



Mobile Internet PC User's Guide

Presario 700 Series

Document Part Number: 253697-XX1

August 2001

© 2001 Compaq Computer Corporation

Compaq and the Compaq logo are trademarks of Compaq Information Technologies Group, L.P. Microsoft, MS-DOS, and Windows are trademarks of Microsoft Corporation. All other product names mentioned herein may be trademarks of their respective companies.

Compaq shall not be liable for technical or editorial errors or omissions contained herein. The information in this document is provided “as is” without warranty of any kind and is subject to change without notice. The warranties for Compaq products are set forth in the express limited warranty statements accompanying such products. Nothing herein should be construed as constituting an additional warranty.

Mobile Internet PC User's Guide
Presario 700 Series
First Edition (August 2001)
Document Part Number: 253697-XX1

Contents

1 Introduction

Where Can I Find Information?	1-2
Documentation.	1-2
Viewing or Printing a Guide on the CD	1-3
Symbols and Graphics	1-5
Symbols	1-5
Graphics.	1-5
Safety	1-6
Turning off your Notebook PC	1-6
Protecting Your Notebook During an Electrical Storm	1-7

2 Your Notebook at a Glance

Front of Your Notebook.	2-2
Common Features	2-2
Lower Front Panel	2-3
Easy Access Buttons and Lights	2-4
Function Key Combinations	2-6
Left and Right Panels.	2-7
Components on Left Side	2-7
Components on Right Side	2-8
Back Panel	2-9
Components on Back.	2-9
Underside	2-10
Components on Underside.	2-10

3 Using Your Notebook

Power On!	3-2
Plugging and Unplugging AC Power	3-3
Turning Your Notebook On and Off	3-4
Using Battery Power	3-6
Using Keyboard and Pointing Device	3-9
Using the TouchPad Instead of a Mouse	3-9
Tapping and Double-Tapping	3-10
Edge Motion	3-12
Easy Access Buttons	3-13
Reprogramming the Easy Access Buttons	3-13
Storage Drives	3-14
Identifying Your Storage Drives	3-14
Security	3-15
Using the Security Slot	3-15
Power-On Password	3-15

4 Common Tasks

S-Video Connection	4-2
Switching Between Displays	4-2
Connecting and Enabling S-Video	4-3
Software and Hardware	4-5
Adding and Removing Software	4-5
Installing Hardware Devices	4-6
Upgrading your Notebook's Memory	4-6
Modem	4-10
Connecting a Modem Cable	4-10
Connecting a Network Cable	4-12

5 Using the CD or DVD Drive

CD or DVD Drive	5-2
Inserting a Disc	5-2
Removing a Disc	5-3
Manually Ejecting a Disc	5-4
Audio CDs and DVD Video Discs	5-5
Playing Audio CDs	5-5
Playing Non-DVD Video Discs	5-6
DVDs	5-7
Using the DVD Player	5-7
On-Screen Controls	5-7
Identifying Your DVD Region Setting	5-8
CD-RW Basics	5-10
Installing CD-RW Software	5-10
Accessing CD-RW Software	
User Information	5-11
Using CD-RW Software	5-12
Preventing Buffer Underrun Errors	5-13

6 Caring for Your Battery

Battery Care	6-2
Storing the Battery	6-4
Recycling the Battery	6-5
Battery Calibration	6-6
Calibrating the Battery	6-6
Maximizing Battery Operating Time	6-8
Power Management	6-10
What Is Power Management?	6-10
Fixing a Low-Battery Condition	6-13

7 Preventive Maintenance

- External Care of Your Notebook 7-2
 - Cleaning the Exterior of your Notebook 7-2
 - Cleaning the Keyboard 7-3
 - Cleaning the Display Screen 7-4
 - Cleaning the TouchPad 7-4
 - Cleaning the External Mouse 7-5
 - Caring for Your Notebook. 7-6

8 Solutions

- Basic Solutions. 8-2
 - Backup Utilities 8-2
 - Compaq Help and Support 8-3
 - Helpful Hints 8-5
 - Finding Solutions Quickly. 8-6
- Solution Tables. 8-7
 - Audio and Video 8-7
 - Battery and Power 8-11
 - Mass-Storage 8-12
 - Games and Internet 8-14
 - Keyboard and TouchPad 8-16
 - Memory and PC Cards 8-18

Glossary

Index

Introduction

Congratulations! As the owner of a new Compaq Notebook computer, you have joined the worldwide community of mobile computer users. After your Notebook is set up and connected to the Internet, you can explore vast regions of information, entertainment, and services online.

To help you access the information you need on your Notebook, this chapter covers the following main topics:

- Where Can I Find Information?, 1-2
- Symbols and Graphics, 1-5
- Safety, 1-6

The *Mobile Internet PC User's Guide* is designed for both experienced computer users and beginners. This easy-to-scan guide helps you find the information you want as quickly as possible. It's also designed to familiarize you with the following:

- Features you'll want to try during the first few days or weeks
- Keeping your Notebook running smoothly
- Solving common problems as they occur



Where Can I Find Information?

All the information you'll need to use the basic features of your new Notebook is available in the documents included with your Notebook. Some of these documents are printed and some are provided on the *Documentation Suite* CD.

Documentation

Your new Notebook computer came with documentation containing helpful reference material. If you have access to the Internet, you can also view these and other documents on the Compaq Web site. See the “Online Help and Support” section in Chapter 8 for specific Web site information.

- The Warranty Statement and Poster are included in your kit.
- The Mobile Internet PC User's Guide, and Safety and Comfort Guide can be found on CD.



Note *Additional documents to those described here may vary per region.*

Getting Started Poster

This poster shows you how to set up your Notebook. When you finish, fold the poster and store it with your documents for future use. For more information about the hardware that came with your new Notebook, see “Your Notebook at a Glance” later in this guide.

Mobile Internet PC User's Guide

This easy-to-scan guide explains how to set up your Notebook and get acquainted with its features. It also introduces:

- Common computer tasks
- The Internet
- Notebook maintenance
- Solutions for computer problems
- Compaq service and support tools



Did you know... *The Mobile Internet PC User's Guide and the Safety and Comfort Guide are also available on the Compaq Web Site. See the "Online Help and Support" section in Chapter 8 for specific Web site information.*

Safety and Comfort Guide

This document explains how to protect your equipment from damage, protect yourself from injury, and ensure your comfort while using your Notebook.

Warranty Certificate

The warranty details the Compaq commitment to service during the warranty period. Keep the warranty certificate in a safe place for future reference.

Viewing or Printing a Guide on the CD

For information about using the CD drive, including instructions for inserting or removing a CD, refer to Chapter 5, “Using the CD or DVD Drive.”

To view or print a document on the *Documentation Suite* CD:

1. Insert the *Documentation Suite* CD into the CD drive.
2. Select a guide from the *Documentation Suite* menu.
3. If Adobe Acrobat Reader information is displayed and you are asked to respond, follow the instructions on the screen to accept the Adobe Acrobat Reader license agreement. (Acrobat Reader is a software application that enables you to view and print the documents on the *Documentation Suite* CD. You will also use Acrobat Reader to view and print some documents available on the Internet.)
4. For information about closing Acrobat Reader or using it to view or print a document on the *Documentation Suite* CD, click the Help button near the top of the Adobe Acrobat Reader window.

Symbols and Graphics

Symbols

The following words and symbols have special meaning in this guide and in the electronic documentation:



WARNING: Text set off in this manner indicates that failure to follow directions in the warning could result in bodily harm or loss of life.



CAUTION: Text set off in this manner indicates that failure to follow directions could result in damage to equipment or loss of information.



Did you know... *Text set off in this manner provides important information that may help you solve a problem.*



Tip *Text set off in this manner provides helpful hints that make using your Notebook easier and faster.*



See also *Text set off in this manner refers to another document or another page in this document that has related information.*



Note *Text set off in this manner provides commentary, sidelights, or interesting points of information.*

Graphics

The illustrations shown and features described in this document may differ slightly from those provided with your Notebook computer.

Safety



WARNING: To reduce the risk of electric shock and damage to the equipment, read the Safety and Comfort Guide.



Did you know... *To protect your equipment from power surges, plug all power cords into a high-quality surge protector. If you have a dedicated telephone line for the modem, buy a surge protector with a telephone jack.*

Turning off your Notebook PC

To shut down your Notebook properly, complete the following steps:

1. Close all open programs.
 2. Shut down the Windows operating system by selecting the **Start** menu from the taskbar, select the **Turn Off Computer** icon, then select the **Turn Off** button.
-



Note *If the Notebook does not turn off automatically, press and hold the **Power**  button until the Notebook shuts down. This is not recommended under normal circumstances.*

3. Unplug the power cord from the wall outlet and unplug the modem line from the wall jack.

Protecting Your Notebook During an Electrical Storm

During an electrical storm, you should take the following precautions to protect your Notebook from damage. You should immediately disconnect your Notebook from the power source.



Tip *After your Notebook is safely disconnected from AC power, you can run your Notebook on battery power.*

- If you are not using a surge protector, unplug all power cords from the wall outlets.
- Disconnect your Notebook from the wall outlets.
- Turn off the power button on all surge protectors.
- If a telephone line from your Notebook is plugged directly into the wall jack (without going through a surge protector), unplug the line from the wall jack.

Your Notebook at a Glance

Before you begin using your new Notebook computer, you'll want to look at some of the basic components.

To help you locate your Notebook's components, this chapter covers the following main topics:

- Front of Your Notebook, 2-2
- Left and Right Panels, 2-7
- Back Panel, 2-9
- Underside, 2-10



To open your new Notebook, push the **Display Release Latch 1** and gently lift up the lid.

Front of Your Notebook

Open your Notebook and take a look at these components.



See also “Turning Your Notebook On and Off” in Chapter 3 of this guide to learn more about how to start and shut down your Notebook.

Common Features

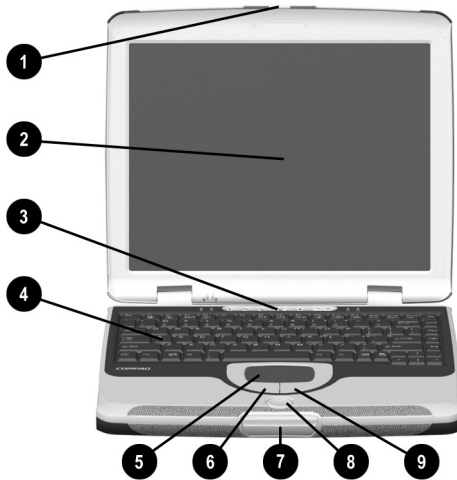

- | | |
|-----------------------|-------------------------|
| ❶ Display Release Tab | ❹ Left TouchPad Button |
| ❷ Display | ❺ Display Release Latch |
| ❸ Power Button | ❻ Easy Scroll Button |
| ❹ Keyboard | ❼ Right TouchPad Button |
| ❺ TouchPad | |

Lower Front Panel

 **See also** “Using Keyboard and Pointing Device” in Chapter 3 of this guide for more information on using the TouchPad.

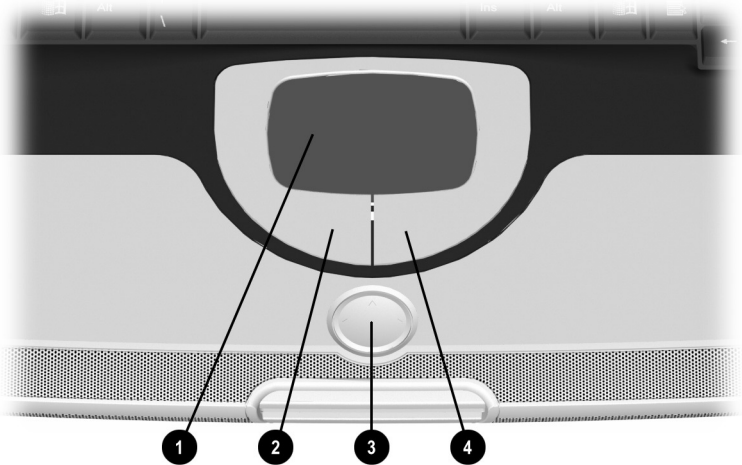

- | | |
|------------------------|-------------------------|
| ❶ TouchPad | ❸ Easy Scroll Button |
| ❷ Left TouchPad Button | ❹ Right TouchPad Button |

Easy Access Buttons and Lights

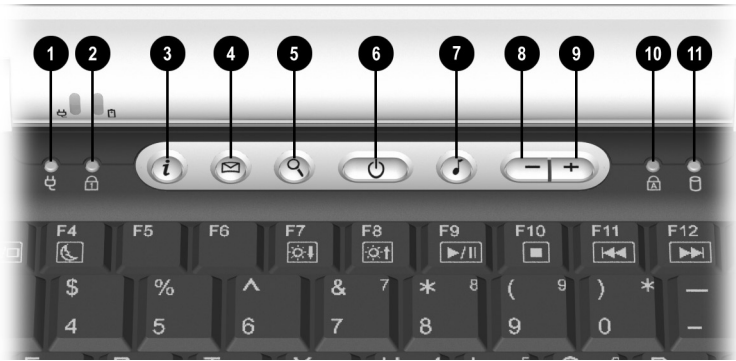







- ❶ AC Adapter Light
- ❷ Digital Audio Button
- ❸ Num Lock Light
- ❹ Instant Internet Access Button
- ❺ Instant E-Mail Button
- ❻ Search Button
- ❼ Power Button
- ❼ Digital Audio Button
- ❽ Volume Down Button
- ❾ Volume Up Button
- ❿ Caps Lock Light
- ⓫ Hard Drive Access Light



See also “Reprogramming the Easy Access Buttons” in Chapter 3 of this guide to learn how to program the Easy Access buttons to suit your needs.



Tip Pressing the **volume down** and **volume up** buttons at the same time mutes the sound. Repeat to un-mute the sound.

Button	Button Description	Default Button Action
	Digital Audio	Launches Windows Media Player to play MP3 music.
	Instant Internet Access	Provides your daily start point to the Internet. It connects you to a personalized Web page filled with local weather, news, sports, and financial information.
	Instant E-mail	Provides you with one-touch access for sending and reading your e-mail.
	Search	Provides you with instant access to news and information on the Internet. Search for topics including shopping, images, music, and videos.
 Fn+F1	Compaq Web Site	Connects instantly to Compaq for product information, helpful hints, performance updates, service, and more.
 Fn+F2	Help and Support	Launches Compaq Help and Support and provides your Notebook with one-touch access to Web-based service and support information.



Tip Key combinations, such as the example **Fn+F1** used in these solutions, mean that you should press and hold down the **Fn** key, press the **F1** key, and then release both keys simultaneously.

Function Key Combinations



The following (FN+function) keys have already been assigned.

Button	Description
F1	Compaq Support Web site launch key
F2	Help launch key
F3	Switch between the display and external monitor in the following order: <ul style="list-style-type: none">■ Display■ External monitor■ Display and external monitor■ TV
F4	Sleep
F5	Unassigned
F6	Unassigned
F7	Brightness control down
F8	Brightness control up
F9	CD or DVD play/pause
F10	CD or DVD stop
F11	CD or DVD previous track
F12	CD or DVD next track

Left and Right Panels

Take a look at the left and right sides of your Notebook. The PC card slot and the removable floppy drive are located on the left side panel. The microphone jack, headphone jack, and optical drive are located on the right side panel.



Did you know... *PC Cards are credit card-sized removable options that expand the capability of your Notebook.*

Components on Left Side

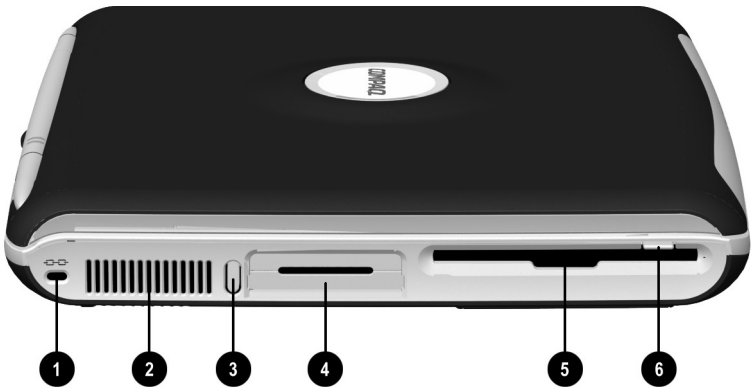

- ❶ Security Lock Slot
- ❷ Air Vent
- ❸ PC Card Eject Button
- ❹ PC Card Slot (Type I, II, or III)
- ❺ Floppy Drive
- ❻ Floppy Eject Button

Components on Right Side

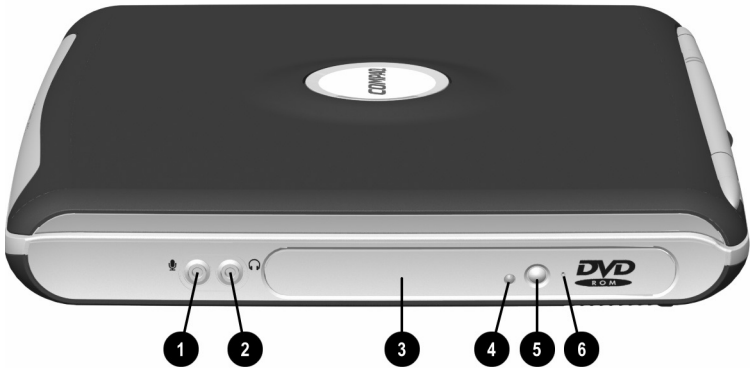

- ❶ Microphone Jack
- ❷ Headphone Jack
- ❸ Optical Drive

- ❹ Optical Drive Activity Light
- ❺ Optical Drive Eject Button
- ❻ Manual Eject Hole

Back Panel

Take a look at the back of your Notebook. This is where you connect external hardware such as a printer or external monitor.



See also “Installing Hardware Devices” in Chapter 4 of this guide for more information on attaching external devices.

Components on Back

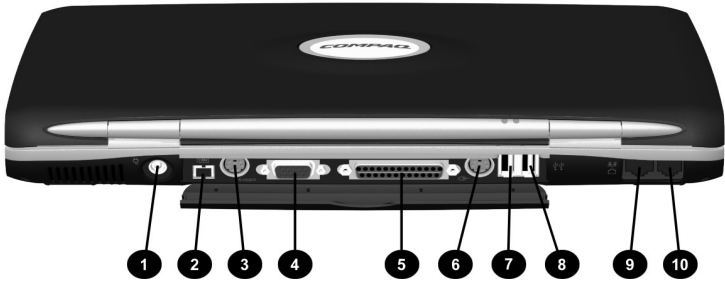

- | | |
|--------------------------------|------------------------|
| ❶ AC Adapter Connector | ❹ Keyboard/Mouse Port |
| ❷ 1394 Port (on select models) | ❺ USB Port (1) |
| ❸ S-Video (TV Output) Port | ❻ USB Port (2) |
| ❹ External Monitor (VGA) Port | ❼ 10/100 Ethernet Port |
| ❺ Printer/Parallel Port | ❽ Modem Port |

Underside

The memory compartment, main battery, battery release switch, and the pop-up feet are located on the underside of your Notebook.



Tip Before contacting Compaq Customer Support, you will need the serial number from the underside of your Notebook.

Components on Underside

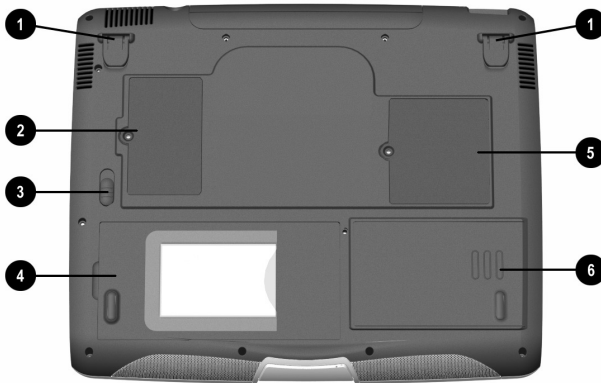

- | | |
|--------------------------------|----------------------------|
| ❶ Pop-up Feet | ❷ Main Battery Compartment |
| ❸ Expansion Memory Compartment | ❹ Modem Compartment |
| ❺ Battery Release Switch | ❻ Hard Drive Access Panel |



See also “Using Battery Power” in Chapter 3 of this guide for more information about the Battery Release Switch.

Using Your Notebook

Your Notebook computer is designed for easy setup, use, and upgrading. In this chapter, you'll become familiar with your Notebook features.



This chapter helps you to use your Notebook right out of the box, by covering the following main topics:

- Power On!, 3-2
- Using Keyboard and Pointing Device, 3-9
- Easy Access Buttons, 3-13
- Storage Drives, 3-14
- Security, 3-15

Power On!

This section helps you get your Notebook set up and running.

- Plugging and Unplugging AC Power
- Turning Your Notebook On and Off
- Using Battery Power



WARNING: To reduce the risk of electrical shock, fire, or damage to the equipment, do not use converter kits sold for appliances to power your Notebook. Use only the Compaq adapter that came with your Notebook or a Compaq replacement part.



CAUTION: High voltages can enter your Notebook through the phone line connected to the modem. To protect your Notebook during electrical storms, use a telephone line surge protector.



See also *The “Government Approvals” section in the Safety and Comfort Guide for worldwide power information.*

Plugging and Unplugging AC Power

Do's

- Ensure that you can reach the electrical outlet easily.
- Unplug the AC adapter from the electrical outlet when you want to disconnect AC power from your Notebook.
- When unplugging from the electrical outlet, grasp the cord by the plug.

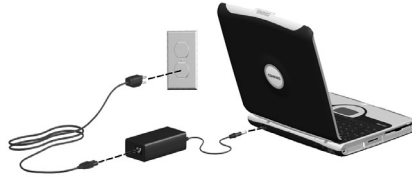

Don'ts

- Do not leave the AC adapter plugged into the electrical outlet when it is not connected to your Notebook.
- Do not place anything on power cords or cables. Arrange them so that no one accidentally steps on or trips over them.

Surge Protectors

Using surge protectors and line conditioners can substantially reduce the risk of electrical shock and aid in protecting your Notebook from power-source problems.

During a power surge, the voltage level of electricity coming into your Notebook can increase and cause data loss or system damage. Protect your Notebook and peripherals by connecting them to a surge suppressor, which absorbs voltage surges and prevents them from reaching your Notebook.

Why Use AC Power When I've Got a Battery?

When you're not on the go, you'll want to use your Notebook's AC adapter as your power source. This ensures that the battery is always charged.

When your Notebook does not have a charged battery, you should save your work and turn off your Notebook before unplugging it from the AC power supply.

i **Did you know...** *When a charged battery is in your Notebook, you can simply unplug it from AC power. Your Notebook automatically switches to battery power.*

Turning Your Notebook On and Off

To turn on your Notebook, press the **Power**  button, which is located at the top of the keyboard.

To turn off your Notebook properly, complete the following steps:

1. Save your work and exit all open programs.
2. Shut down the Windows operating system by selecting the **Start** menu from the taskbar. Select the **Turn Off Computer** icon, then select the **Turn Off** button. Your Notebook will turn itself off.

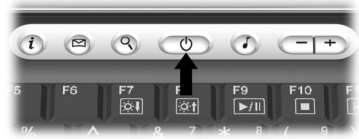



Power Button Functionality

When your Notebook is on, pressing the **Power**  button places your Notebook in Hibernation mode.



Did you know... *Hibernation is a state of no power consumption. When your Notebook enters this mode, the contents of the memory are saved to the hard disk and your Notebook powers off.*

The settings for the **Power**  button are as follows:

- Press and release the **Power**  button once to enter Hibernation mode.
- Press and hold down the **Power**  button to shut down your Notebook.

Using Battery Power



WARNING: Your Notebook contains a lithium-ion battery pack. Improper handling of the battery pack can result in fire and chemical burns. Do not disassemble, crush, puncture, short external contacts, dispose of in water or fire, or expose it to temperatures higher than 140° F (60° C). Replace only with the Compaq battery pack specified for your Notebook.



Did you know... *The battery charges whether your Notebook is on or off. It continues charging until the battery is fully charged or the AC power is disconnected.*



Tip *The battery will lose its charge if not used for a long time.*

Inserting and Removing the Battery

To insert the main battery into the battery compartment, follow these steps:

1. Turn your Notebook bottom side up.
2. Slide the **Battery Release Switch** outward. Lift up the battery door.
3. Position the battery so that the battery label faces downward.
4. Insert the battery, front-edge first, into the keyed battery compartment.

5. Gently push down on the battery door until it snaps into place.

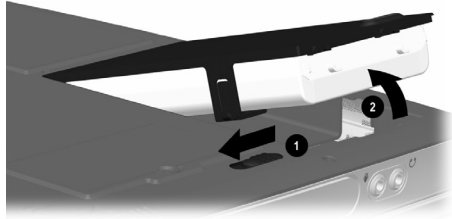

See also “Components on Underside” in Chapter 2 of this guide for help in locating the Battery Release Switch.

To remove the battery, complete the following steps:

1. Save your files.
2. If the AC adapter is not connected, turn off your Notebook.
3. Turn your Notebook bottom side up and slide the **Battery Release Switch** on the underside of your Notebook outward. Lift up the battery door.
4. Slide the battery out of the battery compartment.



Note *The battery door will not close easily if the battery is inserted incorrectly.*

Charging the Battery



See also “Battery Care” in Chapter 6 of this guide.

To charge the battery, insert the battery in the battery compartment and connect your Notebook to AC power. Leave your Notebook plugged into the electrical outlet until the **Battery Charge**  light is no longer illuminated. This ensures that the battery is fully charged.



Note *If you will not be using your Notebook for an extended period of time, Compaq recommends that you unplug the electrical cord from the outlet and remove the battery while your Notebook is not in use.*

Using Keyboard and Pointing Device

In this section you'll learn how to select, click, and double-click with the TouchPad:

- Using the TouchPad Instead of a Mouse
- Tapping and Double-Tapping
- Edge Motion



See also “*External Care of Your Notebook*” in Chapter 7 of this guide for tips on keeping your TouchPad clean.



See also “*Installing Hardware Devices*” in Chapter 4 of this guide to learn how to attach an external mouse.

Using the TouchPad Instead of a Mouse

Just like the mouse, the TouchPad lets you draw lines or point to items on the Windows desktop. Try dragging the pointer across the screen by gently dragging your finger across the TouchPad.



Left-Click

To left-click, press the **Left** TouchPad button. It is located directly below the TouchPad. The **Left** TouchPad button works as the select or drag button. To double-click an item, move the pointer over the item and press the **Left** TouchPad button twice in rapid succession.

Right-Click

The **Right** TouchPad button works as the context menu or special drag button. Move the pointer over the item and press the **Right** TouchPad button to get context-sensitive options.

Easy Scroll Button

The **Easy Scroll** button is the equivalent of the right, left, up, and down buttons of the scroll bars on the side and bottom of your screen. To view other areas of a document or browser window, press the **Easy Scroll** button in the desired direction.



Note *The **Easy Scroll** button is only functional with some software applications.*

Tapping and Double-Tapping

Your TouchPad has a tapping feature that works like the left mouse button. If enabled, you can tap once on the TouchPad to select an object and tap twice to double-click.

To turn on the tapping feature, complete the following steps:

1. Use the Windows **Start** menu to open the **Control Panel**.



Note *All references in this guide to Control Panel menu items will use the Classic View, not the Category View. After opening Control Panel, select **Switch to Classic View**.*

2. Double-click the **Mouse** icon  to open the **Mouse Properties** dialog box.

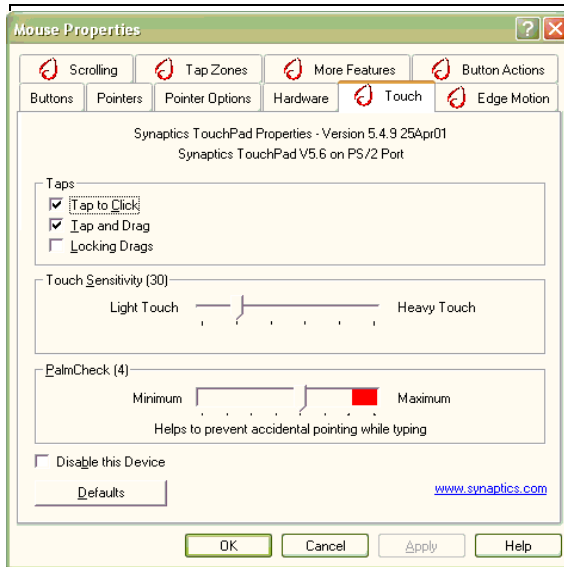

3. Click the **Touch** tab.
4. Select **Tap to Click** to turn on the tapping feature.
5. Click **OK** to accept the changes and close the dialog box.

 **Did you know...** To help prevent accidental pointing while typing, drag the **PalmCheck** slider toward maximum.

Edge Motion

Edge Motion allows you to continue to scroll when your finger reaches the edge of the TouchPad. When this feature is turned on, the window continues to scroll until you lift your finger.

To turn on Edge Motion, complete the following steps:

1. Use the Windows **Start** menu to open the **Control Panel**.
2. Double-click the **Mouse** icon  to open the **Mouse Properties** dialog box.
3. Click the **Edge Motion** tab.

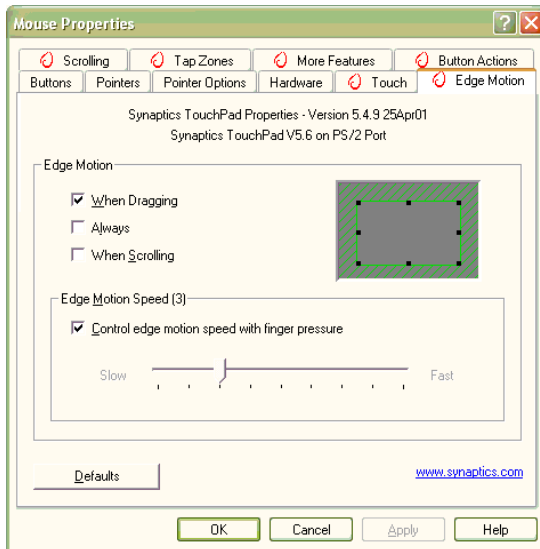

4. Select **When Dragging**, **Always**, and **When Scrolling** to turn on Edge Motion.
5. Click **OK** to accept the changes and close the dialog box.

Easy Access Buttons

The Easy Access buttons, located above your Notebook's keyboard, automatically connect you to the Internet. These buttons give you one-touch access to Internet activities or to software applications.

Until your Internet or network services are configured, all buttons launch the Internet Setup Wizard. After your Internet/network services are set up, each button opens your default Web browser and connects to pre-programmed applications.

Reprogramming the Easy Access Buttons



See also *“Easy Access Buttons and Lights” in Chapter 2 of this guide for descriptions of each button and its default action.*

You can reprogram the Easy Access buttons to reflect your personal preferences.

To reprogram your Easy Access buttons, complete the following steps:

1. Use the Windows **Start** menu to open the **Control Panel**.
2. Double-click the **Easy Access** buttons  and follow the instructions provided.

Storage Drives

Your Notebook stores your files and programs in the storage drives. This section helps you in the following area:

- Identifying Your Storage Drives

Identifying Your Storage Drives

Your floppy drive, hard drive, and CD, DVD, CD-RW, or DVD/CD-RW drive are designated with letters of the alphabet, as well as with icons.

To determine your drive letters, complete the following steps:

1. Use the **Start** menu to access the **My Computer** icon . The icons for each drive and corresponding drive letters are displayed in the **My Computer** window, under the listing for 'Hard Disk Drives' and 'Devices with Removable Storage.'
2. Use the icons to the right to identify your drives.

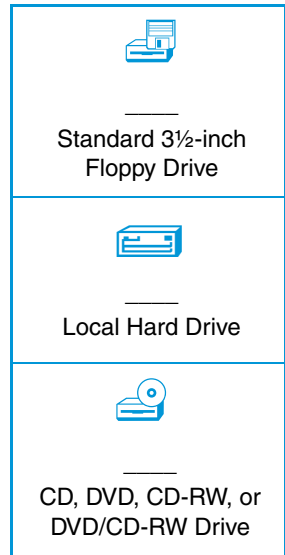

Security

To protect your files and programs, your Notebook provides several security features. This section will cover:

- Using the Security Slot
- Power-On Password

Using the Security Slot

To use the security slot found on the side of your Notebook, complete the following steps:

1. Insert a locking device (such as a Kensington lock) into the security slot.
2. Turn the locking device clockwise 90 degrees.

To remove the locking device, turn the locking device counter-clockwise 90 degrees and remove the device from the slot.

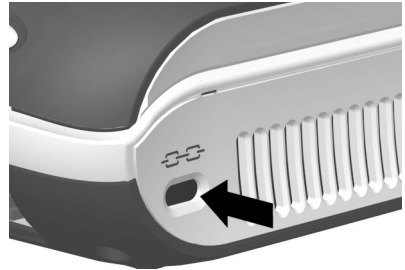

Power-On Password

You can set a power-on password that will secure the information you store on the hard disk. When turning on your Notebook, this password must be entered before you can access your files.



Setting the Password

To set the power-on password, complete the following steps:

1. Press the **Power**  button to turn on your Notebook.
2. After the Compaq logo is displayed, a cursor is shown in the upper right corner of the screen for a few seconds. While the cursor is visible, press the **F10** key.



CAUTION: F10 Setup is for experienced users only. Changing settings may affect the functionality of your Notebook.



CAUTION: Write your password down in a secure location. If you forget or lose your password, a Compaq service technician must reset your Notebook for you to be able to access your files.

3. From the **Main** option on the menu bar, use your arrow keys to move to the **Security** menu bar item. The cursor should be in the **Set Supervisor Password field**. Press the **Enter** key.
4. Set your personal password, and press the **Enter** key. You must confirm the password and press the **Enter** key again.
5. Press the **Enter** key at the **Setup Notice** screen to continue.
6. Move to **Password on boot**. Use the + or - keys to select **Enabled**.
7. Use the arrow keys to select **Exit** from the menu bar.
8. Make sure that **Exit Saving Changes** is selected. Press the **Enter** key.
9. Select **Yes** to save your changes and exit.

Your power-on password is now set. Every time you turn on your Notebook, resume working from hibernation mode, or access **F10 Setup**, you must enter this password.

Removing the Password

To remove a power-on password, complete the following steps:

1. Press the **Power**  button to turn on your Notebook.
2. Access **F10 Setup** as described in ‘Setting the Password’, type your current password, and press the **Enter** key.
3. From the **Main** option on the menu bar, use your arrow keys to move to the **Security** menu bar item. The cursor should be in the **Set Supervisor Password** field. Press the **Enter** key.
4. Type your current password and press the **Enter** key.
5. In the spaces to enter your new password and confirm the new password, press the **Enter** key.
6. Press the **Enter** key at the **Setup Notice** screen to continue.
7. Use the arrow keys to select **Exit** from the menu bar.
8. Make sure that **Exit Saving Changes** is selected. Press the **Enter** key, then select **Yes** to save your changes and exit.



Tip *Pressing the **F9** key at any point within the setup returns your Notebook to the default settings.*

Common Tasks

Now that your Notebook computer is set up and running, you may want to explore and learn about some of the common tasks performed by your Notebook.

To help you take advantage of your Notebook's common features, this chapter covers the following main topics:

- S-Video Connection, 4-2
- Software and Hardware, 4-5
- Modem, 4-10

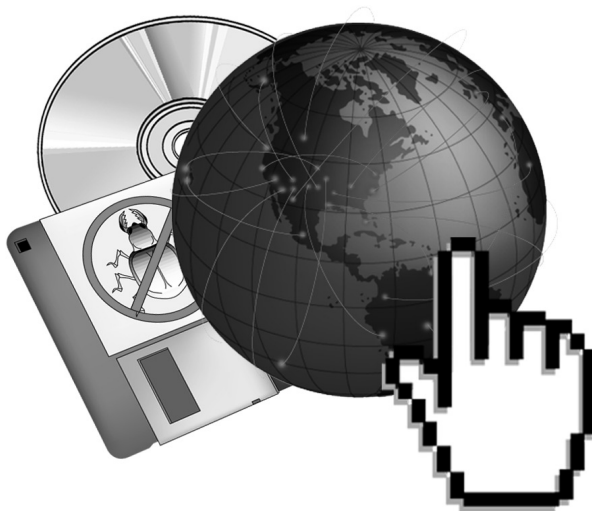

S-Video Connection

With an S-Video connection, you can play games on a bigger screen or watch DVD movies on TV instead of on a Notebook display.

This section helps you complete the following tasks:

- Switching Between Displays (Function Key method)
- Connecting and Enabling S-Video (Manual method)

Switching Between Displays

You can switch between your television and your display or external monitor by pressing **Fn+F3**. The order in which they change is:

Key Combination	External Monitor	TV	Ext. Monitor + TV
FN + F3	lcd + ext. monitor	lcd only	lcd +ext. monitor
FN+F3(2X)	lcd only	tv only	tv only
FN+F3(3X)	ext. monitor only		lcd only
FN+F3(4X)			ext. monitor only



Note *You must connect the S-Video cable before powering on the system.*

Connecting and Enabling S-Video



Did you know... *Your TV may not have an S-Video connector. See your local electronics store dealer for an S-Video adapter.*

To connect your Notebook and your television, you need an S-Video cable to plug into your TV, VCR, or other device. These cables can be purchased from a retail TV store or a computer store.



Note *You must connect the S-Video cable before powering on the system.*

To connect and enable S-Video, complete the following steps:

1. Connect your Notebook and your television with an S-Video cable.
2. Use the Windows **Start** menu to open the **Control Panel**.
3. Click the **Display** icon  to open the **Display Properties** dialog box.
4. Click the **Settings** tab, then click the **Advanced** button to open the **S3 Gamma Plus Properties** dialog box.
5. Click the **S3 Display** tab.

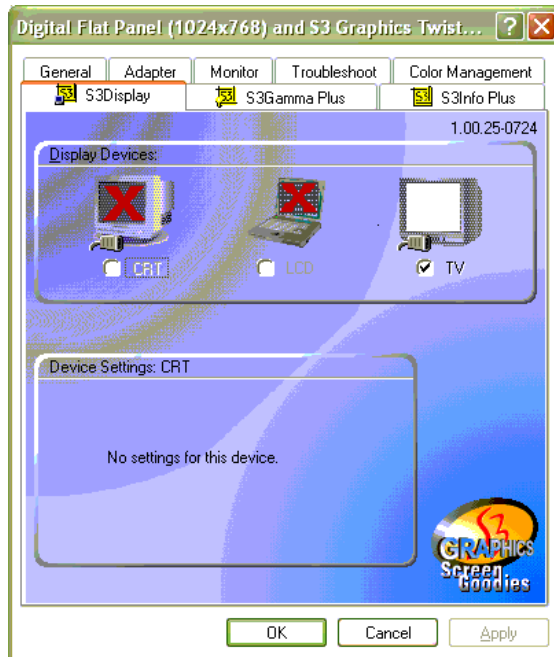

6. Click the **TV** icon to enable S-Video TV output.
7. Click **Apply** to accept the changes, then click **OK** to exit both dialog boxes.
8. If your Notebook asks you to restart Windows, click **OK** for the new settings to take effect.



Did you know... *The resolution of your Notebook display is much greater than the resolution of your TV. Image quality on the TV varies from application to application.*

Software and Hardware

Discover how easy it is to add and remove software, attach new hardware devices, or reinstall deleted hardware drivers. With easy-to-follow instructions, you can completely and safely install or remove software programs and hardware devices with no worries.

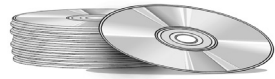

This section covers:

- Adding and Removing Software
- Installing Hardware Devices

Adding and Removing Software

Software can be installed from a CD or a floppy disk or downloaded from a Web site. Many software CDs automatically begin the installation process when placed in the CD drive. If you have software that does not automatically begin the installation process, you can install the software by using the Microsoft Windows **Add/Remove Programs** utility.

Installing Software from a CD or Floppy Disk

To install software from a floppy disk or from a CD that does not automatically install, complete the following steps:

1. Close all programs.
2. Use the Windows **Start** menu to open the **Control Panel**.
3. Double-click the **Add or Remove Programs**  icon to open the **Add or Remove Programs** dialog box.
4. Click **Add New Programs**.

5. Click the **CD or Floppy** button.
6. Insert the CD or floppy disk into the proper drive when prompted by Windows, and click the **Next** button.

Windows finds the CD or floppy disk and begins the installation process.

Installing Hardware Devices

To install a new hardware device such as a printer or gamepad to your Notebook, complete the following steps:

1. Turn off your Notebook.
2. Connect the device to your Notebook according to the instructions that come with it.
3. Turn on your Notebook.

Most hardware devices are plug-and-play compliant. Windows will locate the proper device driver or prompt you to insert the media provided by your hardware manufacturer. Follow the on-screen instructions and use any floppy disk or CD that has been provided by your hardware manufacturer.

You may need to restart your Notebook for the new hardware to be recognized.

Upgrading your Notebook's Memory



Did you know... *Memory is a volatile media also known as RAM (Random Access Memory). Your Notebook uses memory as a scratch pad for all of its internal processes. When your Notebook is turned off, the contents of its memory are lost.*

To avoid losing information that is temporarily stored in your Notebook's memory, always save your work often to non-volatile media, such as a floppy or your Notebook's hard drive.

You can easily upgrade your Notebook's memory to take full advantage of the latest applications and games. Your Notebook can be upgraded to 384 MB of memory using PC 133 memory modules, available from any Compaq retailer.

 **CAUTION:** Electrostatic discharge can damage many electronic components, including memory upgrade modules. Ensure that you are suitably grounded before upgrading your Notebook's memory.

To upgrade your Notebook's memory, follow these steps:

1. Ensure that you have the memory upgrade available.
2. Turn off your Notebook and disconnect the AC adapter.
3. Turn your Notebook bottom side up.
4. Remove the retaining screw **1** from the memory compartment cover and lift the cover **2**.

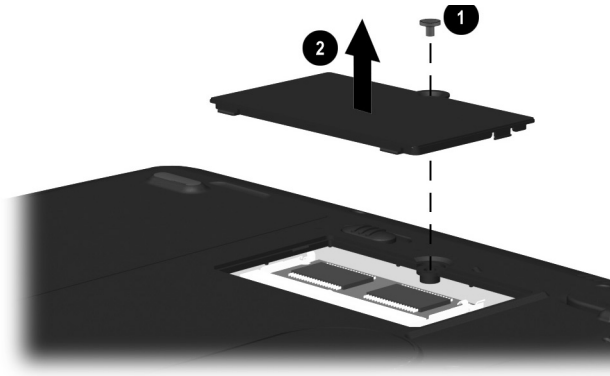

5. Gently pry outward the tabs that hold the memory module in place. The memory module will dislodge and pop up at a 45° angle.

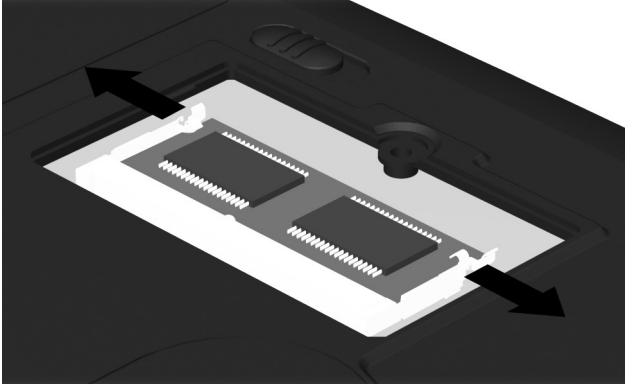

6. Grasp the edges of the memory module and remove it from its socket.
7. Insert the upgrade memory module into the socket at a 45° angle, and gently push down on the sides of the upgrade memory module until it snaps securely into place.

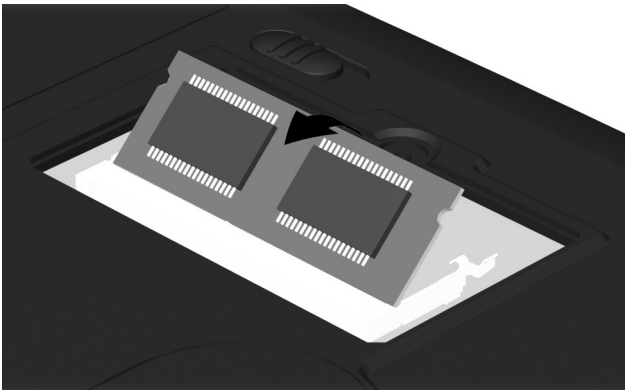



Did you know... *The memory module socket and memory module are keyed. When inserting the memory module into its socket, ensure that the module is correctly aligned with the socket.*

8. Replace the memory compartment cover and secure it with the retaining screw. Press down on the dimples located at both edges of the cover (nearest the retaining screw) to snap it in place.

Modem

The physical connection of a computer to the Internet is typically through a telephone line. Your computer contains hardware called a *modem* that sends and receives information over a standard telephone line. On-screen instructions are provided that you must follow when you set up your modem.

i **Did you know...** *High-speed Internet access may be available in your area. Check with your ISP or local telephone company for more information.*

i **Did you know...** *Your Notebook has a built-in Ethernet connection which is the most common way to connect to high-speed Internet access.*

Connecting a Modem Cable

A modem cable, which has a 6-pin RJ-11 connector at each end, must be connected to an analog telephone line. Jacks for digital PBX systems may resemble analog telephone jacks but are not compatible with the modem. Immediately disconnect an accidental connection to a digital line.

1. Plug the modem cable into the modem port on the computer.
2. Plug the other end of the modem cable into an analog jack.

i **Did you know...** *To use the modem outside the country in which you purchased the computer, you may need to use a country-specific modem adapter and select a country-specific modem configuration.*



WARNING: To reduce the risk of electrical shock, fire, or damage to the equipment, do not plug a telephone cable into the RJ-45 jack.

3. For international use, plug the modem cable into the country-specific modem adapter, as shown in the following figure.

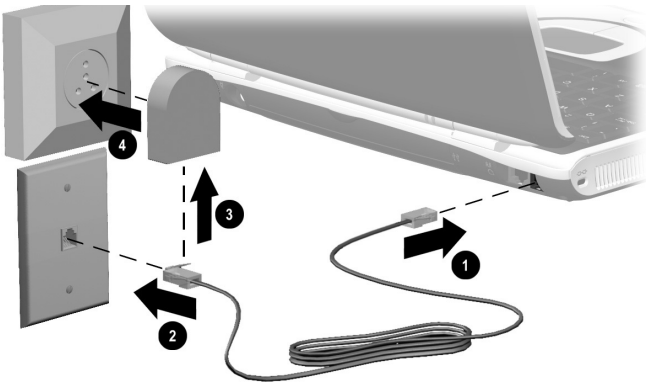

4. Plug the country-specific modem adapter into the wall jack.

Connecting a Network Cable

A network cable has an 8-pin RJ-45 connector at each end:

1. Plug the network cable into the RJ-45 port on the computer.
2. Plug the other end of the cable into a network jack.

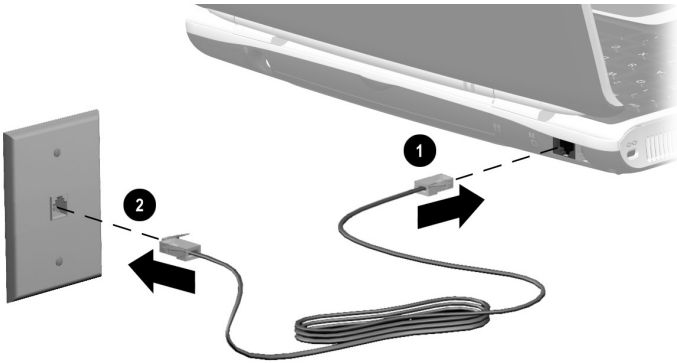

Using the CD or DVD Drive

Who would ever have thought that your home entertainment center could fit in your lap or on a desktop? Your Notebook computer allows you to listen to your favorite music and (on selected models) watch your favorite movies almost anywhere you go.



To help you understand what options lie at your fingertips and how to use these options, this chapter covers the following main topics:

- CD or DVD Drive, 5-2
- Audio CDs and DVD Video Discs, 5-5
- DVDs, 5-7
- CD-RW Basics, 5-11

CD or DVD Drive

In this section, you will learn how to insert and remove CDs and DVDs. This section covers:

- Inserting a Disc
- Removing a Disc
- Manually Ejecting a Disc

Inserting a Disc

To load a disc into the disc drive, complete the following steps:



CAUTION: Improper handling of a CD or DVD can damage the disc and could potentially damage the drive.

1. Press the **Eject** button located on the front of the drive.
2. Remove a disc from its protective case, holding the disc by its center hole and outer edge to avoid touching the surface.
3. Place the disc, label side up (unless it is a double-sided DVD), into the round area of the tray. Gently press the disc down onto the center spindle of the tray until the disc snaps into place.

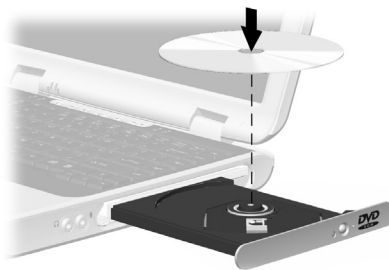



CAUTION: Before closing the disc tray, ensure that the disc snaps onto the spindle in the center of the tray. You can damage the disc and your Notebook if the disc is not seated properly.

4. Push the tray back into the drive until the drive locks into place.

Removing a Disc

To remove a disc from the drive, complete the following steps:

1. Press the **Eject** button on the drive.
2. Remove a disc from the tray, gently pushing down on the center spindle while pulling up on the outer edges. Avoid touching the surface of the disc.
3. Push the tray back into the drive until it locks into place.

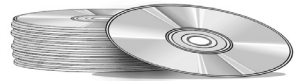

Manually Ejecting a Disc

i **Did you know...** *If your Notebook power is off, you will not be able to eject a disc from the CD or DVD drive. To remove a disc without powering up your Notebook, you must eject the disc from the drive manually.*

If you need to eject a disc when the power is off, complete the following steps to eject the disc manually:

1. Make sure the power is off and any external power sources are disconnected.



2. Insert a small rod or pin, such as a paper clip (approximately 1/16 inch in diameter and at least 3/8 inch in length) into the **Manual Eject Hole** and push firmly as shown in the preceding figure.
3. Remove the disc from the tray.
4. Gently push the tray back into the drive until it locks into place.

Audio CDs and DVD Video Discs

In this section you'll learn how to play audio and video discs with your Notebook. This section covers:

- Playing Audio CDs
- Playing Non-DVD Video Discs

Playing Audio CDs



Did you know... *You can also use the function keys to play an audio CD. These keys are shown in "Function Key Combinations" in Chapter 2 of this guide.*

To play an audio CD, insert the disc into the CD or DVD drive. After a few seconds the **Windows Media Player** opens and the disc automatically starts playing.

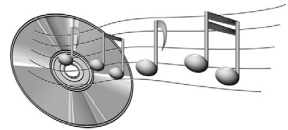

If disc play does not start automatically, complete the following steps:

1. Use the Windows **Start** menu to open the **Windows Media Player**.
2. Click the **Play** button to begin playing the CD.
3. Click the **Stop** button to stop playing the CD.

To remove the disc from the drive, click the **Eject** button on the CD or DVD drive.

Playing Non-DVD Video Discs

To play a video disc, insert the disc into the CD or DVD drive. After a few seconds, the disc automatically starts playing.

If disc play does not start automatically, complete the following steps:

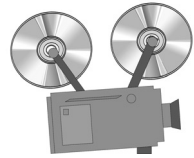

1. Use the Windows **Start** menu to open the **Windows Media Player**.
2. Select **File**, and then **Open** from the **Windows Media Player** menu.
3. Click the **Look in** tab.
4. Locate and double-click the **CD Drive**  icon. You should see a list of files and file folders.
5. Double-click the folder that contains the CD movie files.
6. Select a movie file and click the **Open** button. A viewing window for the movie is displayed and the movie starts playing.

DVDs

In this section you'll learn how to play DVD discs with your Notebook. This section covers:

- Using the DVD Player
- On-Screen Controls
- Identifying Your DVD Region Setting

Your Notebook's DVD drive reserves the best seat in the house for you, so you can watch all your favorite movies anytime, anywhere. The DVD player is simple and fun to use.



Did you know... *DVD stands for Digital Versatile Disc. DVDs look like CDs, but they store movies. DVDs store about 28 times more information than video CDs.*

Using the DVD Player

Did you know... *The DVD drive will take a few seconds to start playback because it must first determine the type of media being played.*



Tip *For the best playback quality, close all open applications while playing a DVD.*



Note *The DVD player is available only on selected models.*

On-Screen Controls

The on-screen controls allow you to quickly and easily access the features of the **WinDVD Player**.



After the **WinDVD Player** is launched and active, use the controls shown on the **WinDVD Player** panel to navigate through the DVD titles. The **WinDVD Player** controls are designed to look like controls on a stand-alone DVD player, so the controls may seem familiar.

Keep in mind that not all options are available with all DVD titles. Only the author of a title can include features. If a feature is not available with a particular title, it will be grayed out and inaccessible.

Identifying Your DVD Region Setting



Did you know... *When attempting to play a DVD that does not match the drive's region setting, you will see the message "Playback of content from this region is not permitted."*

*To close the player without changing the drive's region setting, click **Cancel**.*

*To change the region setting and play the DVD disc, select the current region and click **OK**.*

Most DVD discs have a “region” setting that limits the playback of the disc to specific geographical regions. The region code on the DVD drive must match the region code on the DVD disc.



To change the DVD drive region, complete the following steps:

1. With a DVD disc in the drive, open the **WinDVD Player**.
2. Click the **Properties**  icon on the lower left corner of the player to open the **Properties** dialog box.
3. Click the **General** tab.

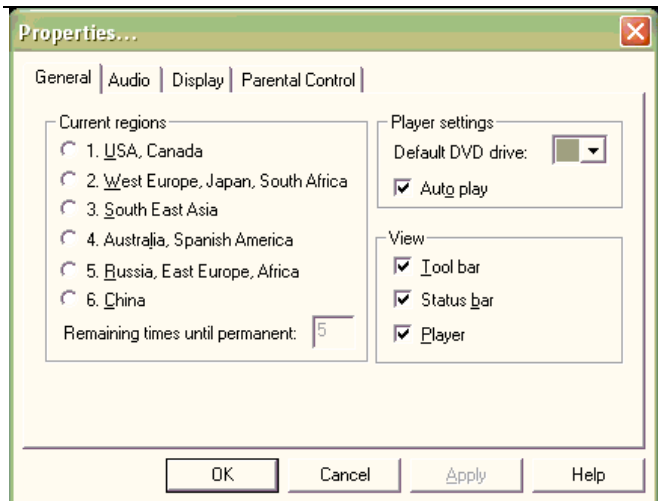

4. Select the desired region in the **Current regions** section.
5. Click **OK** to return to the **WinDVD Player**.



Did you know... *You can only change the region code for the DVD drive five times. The fifth setting change you make becomes the permanent region on the player. Each time you make a change to the drive's region setting, the remaining number of changes allowed on the DVD drive is displayed.*

CD-RW Basics

If your Notebook has a CD-RW drive and the Easy CD Creator Kit, you can create your own audio and data CDs. This section covers:

- Installing CD-RW Software
- Accessing CD-RW Software
- Using CD-RW Software
- Preventing Buffer Underrun Errors

Installing CD-RW Software

Did you know... *The CD-RW drive allows you to create your own CDs. You can buy two types of media: CD-RW and CD-R. CD-RW refers to compact discs (or drives) that are readable and writable. CD-RW discs can hold more than 450 times the information that can be stored on a floppy disk and CD-R media can be played on most of the newer CD players, CD-ROM and DVD-ROM drives. CD-R media can be written to only once. However, you can write to CD-RW media using multiple recording sessions until you close out the disc. CD-RW media can be used to make backups of your personal CDs or hard disk. These discs are reusable and can be erased and rewritten to numerous times.*



Note *CD-RW software is only available on selected models.*

Did you know... *You must close all other Windows programs before installing CD-RW software.*

To install CD-RW Software, complete the following steps:

1. After the CD is inserted, the **CD-RW software** installation dialog box is displayed. Click the **Next** button to begin the installation process.
2. Select the **Complete** option to install CD-RW software. Click the **Next** button to continue the installation process.
3. At the screen advising you that installation is about to start, click the **Install** button to begin copying files to your system.
4. When the installation is complete, click **Finish**.

Accessing CD-RW Software User Information

The CD-RW software included with your Notebook comes with step-by-step instructions and a complete user's manual called Online Help to answer any questions you might have about the functionality of the software with your CD-RW Drive.

To access Online Help, click **Help** from the toolbar, then select **Contents and Index** from the drop-down list.

Using CD-RW Software

CDs are created using the Easy CD Creator Kit (available on select models). Various uses of the CD-RW drive are shown in the following table:

Media	Uses
Audio	Create personal music CDs with your favorite music tracks and MP3/WMA files.
Data	Create a data CD to store data, such as files or folders from the hard disk. This feature is useful for backing up important files or sharing data with other people.
Direct CD	Write files directly to a CD-R/CD-RW just like you copy files to a disk drive. Drag-and-drop files from one drive to another in Microsoft Explorer, without accessing Easy CD Creator.
CD Copier	Create an entire copy of a CD or a backup of data files.
Jewel Case Creator	Make custom jewel case inserts and CD labels to indicate the title and contents of a CD. Labels are sold separately.



Note *Confirm that the Easy CD Creator software has been installed before you begin creating CDs.*



Did you know... *After installation of CD-RW software, you will be prompted to restart your Notebook. You must restart your Notebook before you can begin using the software.*



Did you know... *You must close all other Windows programs before installing CD-RW software.*

Preventing Buffer Underrun Errors



Did you know... *In extreme cases, some errors may render your disc unusable. If this occurs, it may be necessary to start over with a new disc and then properly dispose of the old disc.*

A *buffer underrun* is an error that occurs when the flow of data to the CD-Recorder is interrupted. When a buffer underrun occurs, the CD creation process is halted.

The following suggestions may help prevent buffer underruns:

- Close other programs and disable tasks or applications running in the background such as screen savers and virus software.
- Ensure that the temporary files created during CD recording are created on the local hard disk, not in a directory on a network drive.



Note *To change the location where the temporary files are stored, click **Tools** from the Easy CD Creator menu, select **Options**, and then follow the on-screen instructions.*

- Do not attempt to record CDs from files on a network. If the desired files are on a network, copy them to your local hard disk before recording the CD.



Note *A buffer underrun error can occur on single or dual optical drive systems (CD-ROM, CD-RW, or DVD-ROM drives).*

Caring for Your Battery

When you're on the go, AC wall outlets are not always available and sometimes you'll want to use battery power. This chapter shows you how to maintain and recharge your battery properly so that your Notebook computer has the power necessary to continue running.

This chapter covers the following main topics:

- Battery Care, 6-2
- Battery Calibration, 6-6
- Power Management, 6-10

After you have read this chapter, you will be able to complete the following tasks:

- Increase the length of battery operating time
- Correct a low-battery condition
- Store your battery
- Recycle your battery

Battery Care

Using the Battery

When AC wall outlets are not available or convenient, the battery becomes the “lifeline” of your Notebook. In this section you will become familiar with the following:

- Using the Battery
- Storing the Battery
- Recycling the Battery



WARNING: If your Notebook contains a lithium battery pack, improper handling of the battery pack may result in fire and chemical burns. Do not disassemble, crush, puncture, short external contacts, dispose of in water or fire, or expose it to temperatures higher than 140° F (60° C). Replace only with the Compaq battery pack specified for your Notebook.



See also “Using Battery Power” in Chapter 3 of this guide for inserting, removing, and charging your battery.

Tip For safety reasons, when operating under AC power, Compaq recommends that you keep a battery installed. This ensures that you have a charged battery when you need it.

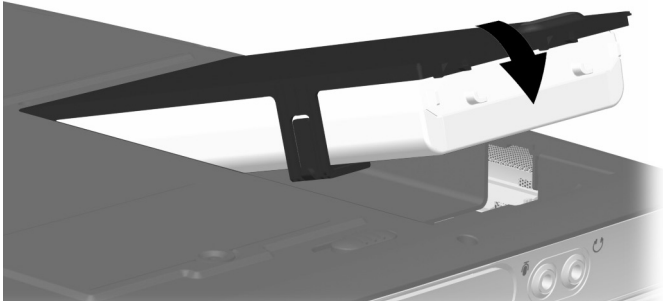

Checking Battery Power

To determine the amount of remaining battery power, double-click the **Battery Status** or **Power Meter** icon located on the right side of the Windows taskbar.

Storing the Battery

Your Notebook uses a **Li-Ion** (lithium-ion) battery. If you will not be using your Notebook for an extended period of time (2 weeks), you must take precautions to ensure that your battery is stored correctly.

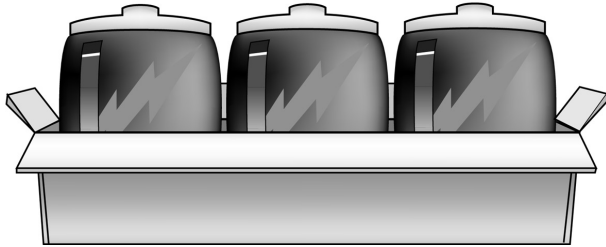

- Use your Notebook until the battery is drained to 50 percent.
- Remove the battery and store it separately.



Tip *You may store your battery within the following temperature range: 32° F to 113° F (0° C to 45° C). To extend its operating life, store the battery in a cool dry place.*



Tip *Temperature plays an important role in recharging your battery. To gain maximum capacity, allow both the battery and your Notebook to cool to 68° F (20° C), which is room temperature, before recharging the battery.*

Recycling the Battery

In North America, dispose of lithium-ion (Li-Ion) batteries by taking advantage of the Compaq battery recycling program. You will be provided with a postage-paid battery pack mailer pre-addressed to a reclamation facility where the metals are recycled.



Do not dispose of batteries with general household waste. Dispose of or recycle them by using a public collection system or returning them to Compaq, your authorized Compaq partners, or their agents.



See also “*Government Approvals*” section of the Safety and Comfort Guide for more information on recycling.

Battery Calibration

All batteries lose their charge if they have not been used for a long period of time. In this section you will become familiar with the following:



- Calibrating the Battery
- Maximizing Battery Operating Time

Calibrating the Battery

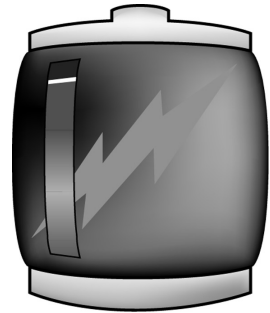
Recalibrating the battery simply means recharging the battery to its maximum capacity and resetting the battery gauge to display the level of charge accurately. You may notice that the battery gauge does not correctly display the battery charge level when you first receive your Notebook or if you have not used your Notebook for a long period of time. If the battery gauge becomes inaccurate, you must recalibrate your battery.



To recalibrate the battery, complete the following steps:

1. Plug in the AC adapter.
2. Allow the battery to charge until the **Battery Charge**  light turns off, showing that the battery is fully charged.
3. After the **Battery Charge**  light turns off, unplug the AC adapter.
4. Turn on or restart your Notebook.



Tip *Do not plug in the AC adapter during the process or you will have to start over with step 1.*



Note Steps 5 through 8 prevent your Notebook from entering Sleep mode. These steps also allow the battery to drain faster.

5. Use the Windows **Start** menu to open the **Control Panel**.
6. Click the **Power Options**  icon to display the **Power Options Properties** dialog box.



Tip You can use your Notebook while the battery is draining or charging.

7. Click the **Power Schemes** tab and select the **Portable/Laptop** scheme.

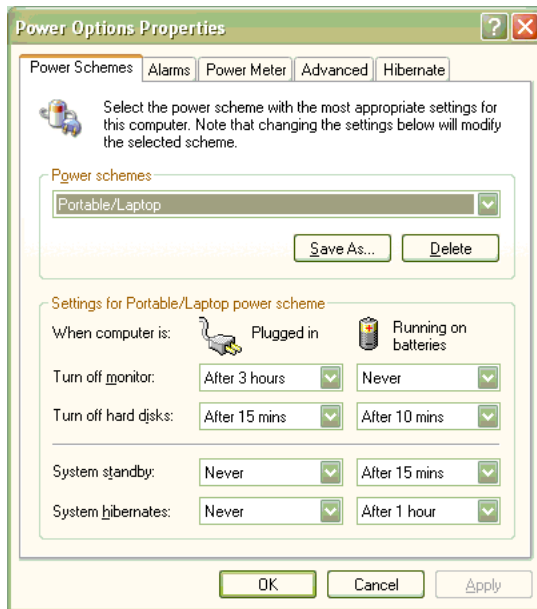

8. From the **Running on batteries** column:
 - a. In the **Turn off monitor** drop-down list, select **Never**.
 - b. In the **Turn off hard disks** drop-down list, select **Never**.
 - c. In the **System standby** drop-down list, select **Never**.
 - d. In the **System hibernates** drop-down list, select **Never**.
9. Let the battery drain until your Notebook reaches Hibernation and turns off.
10. Plug in the AC adapter and restart your Notebook.
11. Return to the **Power Options Properties** dialog box, and re-enter your power savings settings to the desired level.

Battery Charging Time

Battery charging time will vary based on the initial battery charge, the type of battery, and the activity of your Notebook while charging.



Tip *Your Notebook's batteries charge much faster if the Notebook is off while charging.*

Maximizing Battery Operating Time

The battery operating time depends on your power management settings. Your Notebook components, the options, and the applications that you use also affect the operating time. This section shows you how to increase the length of time you are able to operate under battery power.

The display, processor, CD/DVD drive, and hard drive use the most battery power. To maximize the battery operating time, perform one or more of the following actions:

- Press **Fn+F7** to reduce the display brightness and to select a short wait for your screen saver.
- Select a screen saver that does not generate a lot of graphics or motion.
- Reduce audio volume or use headphones.
- Exit modem programs when you are not using them.
- Remove PC Cards when you are not using them.
- Remove CDs or DVDs when you are not using them.
- Use Sleep or Hibernation mode to turn off your Notebook when you are not using it.

Power Management



Did you know... Notebooks have power-saving features that protect your data and conserve battery and monitor life.

What Is Power Management?

This section explains the following main topics:

- Understanding Power Management
- Starting and Ending Power Modes

Understanding Power Management

Power management lets you reduce your Notebook power consumption. Your Notebook has two power management modes:

- Hibernation is an energy-saving feature and safeguard that saves information to the hard drive, then turns off your Notebook. When you resume from Hibernation, your information returns to the screen where you were previously working. Your Notebook hibernates when the Power button is pressed, when the battery has little power left, or when your Notebook (operating on battery power) is in Sleep mode for more than one hour.
- Sleep, also called Standby, is an energy-saving feature that reduces power to system components that are not being used. When Sleep is initiated, your information is saved in Random Access Memory (RAM), and the screen is cleared. Your Notebook is still on, but the display is blank. When you resume from Suspend, your information returns to the screen where you were previously working.







 **Did you know...** *Returning to information saved in Hibernation takes longer than returning to information saved in Sleep but is faster than returning to your information manually after restarting your Notebook.*

 **CAUTION:** Although Sleep mode maintains system information and open files, you will lose any unsaved information if you turn off your Notebook before you end the Sleep mode.

Starting and Ending Power Modes

The following table shows you how to start and end the various power modes of your Notebook.

 **Did you know...** *Your Notebook automatically goes into Hibernation if your battery is low or after one hour of Sleep. When your notebook is on AC power, it does not go into Hibernation.*

If you want to...	Then...	Result/Indicators
Put your Notebook to Sleep manually	Press the Fn+F4 keys. To use Windows to put your Notebook to Sleep, click the Start button and select the Standby option from the shut down menus.	Power  light blinks.
Wake your Notebook from Sleep manually	Press any key.	Power  light stays on.
Put your Notebook into Hibernation manually	Press the Power  button once. To use Windows to put your Notebook into Hibernation, click the Start button and select the Hibernate option from the shut down menus.*	Power  light is off.
Wake your Notebook from Hibernation manually	Press the Power  button once.	Power  light stays on.

* This feature is not available on all operating system platforms.

Fixing a Low-Battery Condition



Tip *If you will not be using your Notebook for an extended period of time, Compaq recommends that you unplug the electrical cord from the outlet and remove the battery while your Notebook is not in use.*

A low-battery condition exists when the battery has less than 10 percent of its power remaining. This section will show you how to correct a low-battery condition and what to do if your Notebook loses all battery power.



When your Notebook loses all battery power, it begins Hibernation, a process that cannot be interrupted. If Hibernation has begun, you must allow your Notebook to finish saving your information and shut off automatically before you try to correct the low-battery condition.

The availability of an AC wall outlet will determine which solution you should use to correct a low-battery condition.

Use one of the following options:

- Connect the AC Adapter
- Replace the Drained Battery with a Charged One
- Suspend Your Work

Connect the AC Adapter

This solution allows you to continue working without being interrupted and simultaneously charges the drained battery. You don't have to turn off your Notebook before connecting the AC adapter. Your Notebook automatically switches to AC power when you connect the AC adapter.



Did you know... *When the AC adapter is connected, the battery will charge whether your Notebook is on or off and will continue to charge until the battery is fully charged or AC power is disconnected.*

Replace the Drained Battery with a Charged One



If you cannot connect the AC adapter but you have a charged battery, you can change to battery power and continue working. To replace the drained battery with a charged one, complete the following steps:

1. Save your work.
2. Turn off your Notebook (or initiate Hibernation).
3. Replace the drained battery with the charged one.
4. Press the **Power**  button to turn on your Notebook.
5. Resume your work.



When AC power becomes available, plug in the AC adapter and replace your Notebook's battery with the drained battery to recharge it.

Suspend Your Work

If you cannot plug in the AC adapter and you do not have a charged replacement battery, start Hibernation by pressing the **Power**  button. When a power source (AC or battery) becomes available, press the **Power**  button to turn your Notebook on and resume your work.



Did you know... *After your Notebook has entered Hibernation mode, it will not turn on until it is plugged into an AC adapter or the drained battery is replaced with a charged one.*

Preventive Maintenance

Maintaining your Notebook by keeping it clean and keeping the vents free from dust promotes longevity and higher performance. If Notebook components are not cleaned periodically, the probability of system failure increases.

The information in this chapter provides helpful instructions for the maintenance and care of your Notebook.

This chapter covers the following main topic:

- External Care of Your Notebook, 7-2



External Care of Your Notebook

This section covers:

- Cleaning the Exterior of your Notebook
- Cleaning the Keyboard
- Cleaning the Display Screen
- Cleaning the TouchPad
- Cleaning the External Mouse
- Caring for Your Notebook

Cleaning the Exterior of your Notebook



CAUTION: When you shut down your Notebook, the power turns off. However, some electrical currents may still be flowing through the Notebook. To completely disconnect power from the Notebook, unplug the power and modem cables from the wall outlets and remove the battery.

Use a damp, lint-free cloth to clean the keyboard, the Notebook's exterior, and other external parts on your Notebook.



CAUTION: Do not use household cleaning solvents because they will damage the finish on your Notebook.

Cleaning the Keyboard

You should clean the keyboard periodically to rid it of dust, lint, and any other foreign particles that may become trapped beneath the keys. Use a can of compressed air with a straw extension attached to blow air in and around the keys.



Cleaning the keyboard prevents keys from sticking and jamming. It also makes typing a more pleasant experience.



CAUTION: Do not use liquids of any kind on the keyboard, because they may permanently damage your keyboard.



CAUTION: Do not use a regular vacuum cleaner for cleaning the keyboard because you may deposit normal household debris on the surfaces rather than remove it.



Tip *Foam swabs or cosmetic applicators are preferred to cotton swabs because cotton can add rather than remove lint.*

Cleaning the Display Screen

The surface of your display screen may look fuzzy or smudged. You can use a soft, damp, lint-free cloth to wipe the screen clean.

If the display screen requires any additional cleaning, use an antistatic screen cleaner or pre-moistened antistatic wipes.



CAUTION: Never spray water or any other cleaning fluids or chemicals directly on the screen. You may permanently damage your Notebook.

Cleaning the TouchPad

Grease and dirt on the TouchPad can cause your cursor to jump around on the display screen.

To avoid this problem, periodically clean the TouchPad with a damp cloth. Remember, before using your Notebook, always wash your hands if they are dirty.

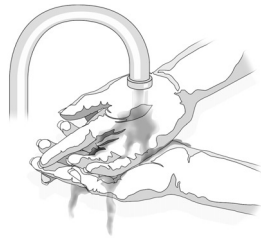

Cleaning the External Mouse



WARNING: Always disconnect the power from your Notebook and disconnect any other peripherals before attempting to clean your Notebook or any of its components.



Tip Give your Notebook a safe home. If your Notebook is consistently exposed to direct sunlight, consider moving it. The heat from the sun shining on the display screen can reduce its performance and cause glare.

If you are using an external mouse and the precision control of the mouse pointer becomes difficult, cleaning the mouse can substantially improve its performance.

To clean the external mouse, complete the following steps:

1. Turn the mouse over and rotate the circular plate about 1/4-inch counter-clockwise until it pops loose. Most mice have an arrow to indicate the direction to turn the plate.
2. Remove the ball from your mouse and clean it with an antistatic wipe or a lint-free cotton cloth.
3. Spray the inside of the mouse with compressed air in an aerosol can to remove loose debris and dust.
4. Replace the ball and the bottom plate.



Caring for Your Notebook

i **Did you know...** *Your Notebook computer is cooled by air that is drawn in through the vents on the chassis and blown out through the exhaust fan. It is important to keep the vents on the chassis free of dust and debris. Brush any dust away from the vents with a damp cloth but do not attempt to dismantle the Notebook to clean dust from the inside of the Notebook. If you dismantle your Notebook, you may permanently damage the components on your Notebook.*

The computer is designed to run demanding applications that require PC Cards, CD-ROM drives, and large amounts of RAM while maintaining full processor performance.

As a result of increased power consumption, it is normal for the computer to feel warm to hot when being used for extended periods.

This computer complies with international safety standards for temperatures of user-accessible surfaces.

Your Notebook computer is designed as a durable product. However, when you transport it, Compaq recommends that you put it in a portable notebook carrying case. To enhance the life of your system, follow these Do's and Don'ts.

Do's

- Carry and store your Notebook in a portable notebook carrying case.
- Keep floppy disks and modular disk drives away from magnetic fields. Magnetic fields can erase data on your floppy disks and on your hard drives.
- Keep your Notebook away from extreme temperatures (for example, in parked cars, near heaters, or near open windows). Extreme temperatures can damage your Notebook or cause it to perform poorly.
- Use your Notebook only on a solid, flat surface and make sure that no walls or objects are close enough to the vents to reduce airflow.

Don'ts

- Bump or drop your Notebook.
- Put objects on top of it. Even if your Notebook is stored in a durable carrying case, it is not made to support extra weight.
- Leave the CD/DVD drive door open when it is not in use. The door can be damaged.
- Handle liquids around your Notebook. Exposure to almost any liquid can result in expensive repairs that are not covered under your warranty.
- Expose your Notebook to dusty or dirty environments. Dust and dirt can clog internal components and mechanisms.
- **Place the Notebook on surfaces that may block the vents on the side or bottom of the unit, such as towels, carpeting, and so on.**

You turn on your Notebook and it won't start. You try to print and nothing happens. You get an error message that prevents you from getting your work done—and there's no one around who knows what to do. Help!



In this chapter you'll learn easy ways to increase computer performance and solve some basic computer problems.

This chapter covers the following main topics:

- Basic Solutions, 8-2
- Backup Utilities, 8-2
- Compaq Help and Support, 8-3
- Solution Tables, 8-7

If you cannot solve a problem yourself, you can contact Compaq support for all the help you'll need.

Basic Solutions

Before you consult our extensive list of common solutions, try these helpful hints. If you still need help, this section tells you how to quickly find the solution.

In this section:

- Backup Utilities
- Compaq Help and Support
- Helpful Hints
- Finding Solutions Quickly

Backup Utilities

Using Backup Devices

To retrieve files that may have been lost or damaged, you should back up your files regularly with a backup utility.

A backup utility will protect your data from accidental loss because of a hardware or media failure by creating a duplicate copy of the data on your hard drive on another storage device such as a floppy disk, a tape drive, or another hard drive. In the event that the original data on your hard drive is accidentally erased or overwritten or becomes inaccessible because of a hard drive malfunction, you can easily restore your data from the backed up copy.

Backup utilities allow you to back up all the files on your Notebook or select specific files and folders. For a partial backup of selected files or folders, save to floppy disks. For a complete hard drive backup, use backup devices such as tape drives, external hard drives, or other high-capacity backup devices.

Compaq Help and Support

Your Notebook is equipped with Compaq Help and Support, an integrated help and assistance tool from Microsoft and Compaq that provides the following services:

- Easy access to your Notebook's built-in product information
- Preventive care and maintenance assistance for your Notebook
- Links to online support and technical assistance

Accessing Compaq Help and Support

To access Compaq Help and Support, press **Fn+F2** or double-click the **Help and Support** icon on your Windows **Start** Menu. The **Help and Support** window is displayed.



Tip *You can also access Compaq Help and Support by clicking the **Start** button and pointing to **Compaq Help and Support**.*

Use Compaq Help and Support when you need:

- Answers to questions about your hardware or software
- Help installing new peripherals or software applications
- A resolution to a hardware or software problem or error
- Help restoring your Notebook's settings and undoing unsuitable changes
- Access to the latest drivers, updates, downloads, and online documentation
- Access to online help and support from a qualified Compaq support specialist

Using Online Help and Support for Additional Assistance

If you are unable to resolve the problem on your Notebook using the troubleshooting and diagnostic features of Compaq Help and Support, additional assistance is available online.

Compaq Help and Support provides integrated access to online assistance, allowing you to post questions or issues to the Compaq Customer Communities or to open a service request online for a Compaq support specialist.

To post your question to the Compaq Customer Communities, open Compaq Help and Support and click **Join the Compaq Customer Communities**.

You may want to visit the following Compaq Web sites:

www.compaq.com/consumersupport	Support for desktops and mobiles, printers, scanners, monitors, and iPAQ Internet products.
http://web14.compaq.com/falco/sp_list.asp	Original drivers, updates, and fixes (also known as Softpaqs). Online documentation including original product manuals and user guides. Original product warranty statements.
www.compaq.com/communities	Keyword search site, where novices to technical experts collaborate to share knowledge, information and assistance.
www.compaq.com/athome/support/consumeremail.htm	E-mail a support specialist.



Did you know... *In the Compaq Customer Communities, you will find collaborative assistance from other users like yourself. You can search the community for existing discussions applicable to your questions or issues, or you can post a new question for a response from the community.*

If you require warranty support or technical assistance, you can open a service request online by clicking **Open an online service event with a Compaq Support Specialist**.

When you are prompted to fill out the e-mail form, ensure that you include the following information before submitting the form:

- Product name and model
- Serial number
- Date of purchase
- Brief description of the problem
- Your e-mail address

Your online service request will be handled using e-mail between you and your assigned Compaq support specialist.



Did you know... *If your Notebook is unable to connect to the Internet for online technical support, you can contact Compaq by telephone. See your Warranty Statement for details.*

Helpful Hints

If you encounter minor problems with your Notebook, display, or software, see the following list of general suggestions before taking further action:

- Ensure that your Notebook is plugged into the AC adapter and that the adapter is plugged into a working electrical outlet.
- Ensure that your Notebook is turned on and the **Power**  light or icon is lit.
- Adjust the brightness and contrast controls of the display.
- Remove any floppy disks from the floppy drive before turning on your Notebook.

Finding Solutions Quickly

To help you find a solution quickly, see the “Solution Tables” section. The information in the tables is divided into three columns:

1. **Symptom** — Describes the symptom or warning that indicates a problem.
2. **Problem** — Identifies one or more reasons why the symptom occurred.
3. **Solution** — Describes how you should try to fix the problem.

If the listed solution does not fix your problem, try another solution for the symptom or try the solution a second time.



If a problem persists and you are unable to resolve it, contact a Compaq authorized service provider. Refer to your *Warranty Statement* for details.



Solution Tables

In this section you will find information on:

- Audio and Video
- Battery and Power
- Mass-Storage
- Games and Internet
- Keyboard and TouchPad
- Memory and PC Cards

Audio and Video

Audio		
Symptom	Problem	Solution
No sound.	Volume has been muted.	On the taskbar, click the Volume  icon then deselect the Mute check box.
	Your Notebook is in Sleep mode. This is identified when the Power  light is flashing.	Press any key.
Sound is too low.	Volume is set too low.	Click the Volume  icon on the taskbar, then click the Volume slider and drag it up, or press the Volume Up button.

Audio (Continued)		
Symptom	Problem	Solution
Sound is distorted.	Volume is set too high.	Click the Volume  icon on the taskbar, then click the Volume slider and drag it down, or press the Volume Down button.
Volume  icon is missing from the Windows taskbar.	The Place volume control icon in the taskbar option has not been selected.	<ol style="list-style-type: none"> 1. Use the Start menu to open the Control Panel. 2. Double-click Sounds and Audio Devices. 3. Select Place volume control icon in the taskbar and click OK.

Video or Display		
Symptom	Problem	Solution
Screen is blank.	Your Notebook is in Sleep mode. This is identified when the Power  light is flashing.	Press any key.
	The external monitor display is selected.	Press the Fn+F3 keys to switch between the LCD display, external monitor, TV-Out (available on selected models), and simultaneous display.
Display only fills part of the screen.	Your resolution settings are not set properly.	<ol style="list-style-type: none"> 1. Use the Start menu to open the Control Panel. 2. Double-click Display. 3. Click the Settings tab. 4. In the Screen area, click the slider and drag it to the desired resolution. 5. Click OK to accept the new settings, then close the Control Panel window.

Video or Display (Continued)		
Symptom	Problem	Solution
Characters are garbled or the display flashes when your Notebook is connected to an external monitor.	The external monitor's resolution is set too high for your Notebook.	Restart your Notebook and reset the Display settings for a lower resolution. See the solution for "Display only fills part of the screen" for more details.

1394 or Digital Video (Supported on selected models only)		
Symptom	Problem	Solution
The digital camcorder or 1394 device is not working.	The device is not on.	Ensure that the device has been turned on.
	The device is not connected.	Ensure that the device is connected to the 1394 port.
	The device drivers are not set up correctly.	Refer to the instructions provided with the device to set up the drivers correctly in Windows.

Battery and Power

Battery		
Symptom	Problem	Solution
Battery gauge is not accurate.	Battery needs calibrating.	See “Calibrating the Battery” in this guide for details.
Battery charging indicator does not display and battery does not charge.	Battery was exposed to temperature extremes.	Keep the battery within the recommended temperature ranges. See “Battery Care” in this guide.
Battery charge does not last as long as expected.	Battery is not fully drained.	Calibrate the battery. See “Calibrating the Battery” in this guide.
Battery charge does not last as long as expected.	Power Management is disabled.	Reset the power management options. See “Calibrating the Battery” in this guide.

Mass-Storage



Did you know... *Mass-Storage media include CDs, CD-RWs, DVDs, DVD/CD-RWs, floppies, and the hard disk.*

CD or DVD Drive		
Symptom	Problem	Solution
CD/DVD drive cannot read a disc or takes too long to start.	The DVD drive takes longer to start because it must determine the type of media being played before it can start.	Wait at least 30 seconds to let the DVD drive determine the type of media being played. If disc still does not start, refer to the "Online Help and Support" section found earlier in this chapter.
DVD player performance is poor when running other programs simultaneously.	DVD playback requires large amounts of processing power; therefore, the system cannot process other tasks simultaneously at maximum performance.	To provide maximum performance, close all other programs while playing DVD media. It may also be necessary to restart Windows to free all resources.
Display is corrupted when playing some DVD movies.	Copyright material at beginning of movie causes momentary corruption.	Wait a few seconds for video corruption to clear up. If it does not clear up, then stop and restart the DVD movie.

Floppy Drive		
Symptom	Problem	Solution
Floppy drive is continually active.	The floppy disk is improperly inserted.	Remove the floppy diskette and reinsert it as follows: <ol style="list-style-type: none"> 1. Insert the edge with the sliding cover into the drive facing up. 2. Push the floppy all the way into the drive until it stops.
Floppy drive cannot read a floppy.	Floppy diskette is not formatted.	Format the floppy diskette by following these steps: <ol style="list-style-type: none"> 1. Open a My Computer  window. 2. Select the 3½ Floppy (A:) drive. 3. Click File and point to Format. 4. Select the desired options and click Start to begin formatting the floppy.

Games and Internet

Games		
Symptom	Problem	Solution
Game frequently stops responding or locks up.	Minimum hardware or software requirements set by manufacturer are not met.	Review the game packaging or call the game's manufacturer to verify the minimum hardware and software requirements.
	Game was not set up properly when installed.	Re-install the program, noting any settings and default selections that pertain to your Notebook, and restart the game.

Internet		
Symptom	Problem	Solution
Cannot connect to the Internet.	Internet service provider (ISP) account is not set up properly.	Verify Internet settings or contact your ISP for assistance.
	Modem is not set up properly.	Reconnect the modem, verifying the telephone line to wall jack connection. Refer to the <i>Compaq Getting Started</i> poster.

Internet (Continued)		
Symptom	Problem	Solution
	If no dial tone is found, another telephone handset on the same line is not on the receiver.	Verify that all telephone handsets on the same line are on the receiver.

Keyboard and TouchPad

Keyboard and TouchPad		
Symptom	Problem	Solution
Keyboard commands or keystrokes are not recognized by your Notebook.	Program in use has stopped responding to commands.	Use the TouchPad to shut down the Windows operating system. Your Notebook will turn itself off. If your Notebook does not shut down, press and hold down the Power  button until your Notebook turns off.
Fn+Num Lk or Shift+Num Lk does not turn the internal NumLock on.	The internal keyboard NumLock is disabled when an external PS/2 keyboard or keypad is present.	Use the keypad on the external keyboard or unplug the external keyboard to use the internal keypad feature.
When typing, some of the letter keys return numbers to the screen.	The NumLock feature is turned on.	Press the Fn or Shift key while pressing the Num Lk key to turn Num Lock off.
Cursor does not respond to Touchpad.	TouchPad needs to be cleaned.	Wipe the TouchPad with a damp cloth and then wipe it dry.

Keyboard and TouchPad (Continued)		
Symptom	Problem	Solution
Cursor does not respond to Touchpad.	Program in use has stopped responding to commands.	Use the keyboard or mouse to shut down the Windows Operating System. If your Notebook does not shut down, press and hold down the Power  button until your Notebook turns off.
Cursor does not respond.	The TouchPad sensitivity settings may need adjustment.	Restore the default TouchPad settings. <ol style="list-style-type: none"> 1. Use the Start menu to open the Control Panel. 2. Double-click Mouse. 3. Click the Touch tab and then the Defaults button. 4. Click OK, and close the Control Panel window.
	The PageUp , PageDown , Home , or End keys were accidentally pressed while typing.	Avoid pressing these keys when pressing the Backspace or Enter keys.

Memory and PC Cards

Memory		
Symptom	Problem	Solution
Insufficient memory message is displayed.	All available memory is used by open programs and memory is needed for the desired task.	Close one or more programs and retry. If this does not solve the problem, restart Windows to recover additional memory.

PC Cards		
Symptom	Problem	Solution
Your Notebook does not recognize the PC Card.	PC Card is not fully inserted in the slot or is upside down.	Remove the card and gently reinsert it. Refer to the manufacturer's documentation for details.
	The PC Card device driver is not installed.	Install the device driver. Refer to the documentation that came with your PC Card or contact the PC Card manufacturer.
	PC Card may not be supported by Windows.	Review the PC Card packaging to verify that the PC Card is compatible or contact the manufacturer directly.

Glossary

This Glossary defines commonly used terms to help new users understand computer concepts. Some of these terms are used in this guide.

1394 port A type of connector for plugging in peripherals, such as digital camcorders, with extremely fast data-transfer rates. The 1394 standard synchronizes audio and video files by delivering data at a guaranteed rate—in real time. See also *peripheral*.

A

Acrobat Reader Software created by Adobe Systems that allows you to view an electronic document with the exact layout intended by the author. The Acrobat Reader can be downloaded free of charge from the Adobe Web site. See also *software*.

anti-virus software A program that detects and, in many cases, repairs the damage caused by a computer virus.

application Software installed on a computer.
See also *program*.

B

backup Copy of a file that is kept in case the original is lost or damaged. Backups can be kept on the hard disk, a floppy diskette, an LS Compaq drive, or even a CD.

bit The smallest possible piece of computer information—a single digit.
See also *digital*.

boot To start or restart the computer. During the startup process, information necessary for the computer to operate is loaded into memory.
See also *main memory*.

browser Software that searches for, displays, and downloads text, graphics, sound, and video from the Internet. Microsoft Internet Explorer and Netscape Navigator are two popular browsers.

bug A mistake in the design of computer software or hardware. Because of their complexity, many have minor bugs. As soon as the manufacturer becomes aware of the problem, modifications are made to correct it.



bulletin board An electronic notice board on the Internet where people can post notices for others with similar interests. Professional organizations and clubs often have bulletin boards for members to share information and opinions.

byte Eight bits of data (eight individual electronic on/off signals, strung together to make a message that the computer can interpret). Most information is organized into bytes. One byte of data is usually required to represent a single character that you can see on the screen (a letter, number, punctuation mark, or other symbol). For example, the byte 01001000 represents the capital letter H.
See also *bit*.

C

cable modem A modem that allows you to access the Internet through your cable television provider. Continuously connected to the Internet, the cable modem allows high-speed, high-capacity data transfer.

CD Compact Disc. Media used in a CD-ROM drive. The disc is a circular piece of plastic that stores digital data on one side, using laser technology.



CD-ROM A compact disc with read-only data. You cannot erase or record over the data.

CD-RW A compact disc with rewritable data. You can write to the disc using a rewritable or recordable CD drive.

chat An Internet feature that allows you to exchange typed messages with another person (or a group of people) in real time. A message you type instantly displays on the other person's computer.

click To push down and quickly release either the left or right mouse button.

Ctrl+Alt+Delete Pressing and holding down the **Ctrl** key, then the **Alt** key, and then the **Delete** key, simultaneously, to close a program that is locked (not responding). Use **Ctrl+Alt+Delete** a second time to shut down a computer that is locked. Unsaved data is erased from memory. When the computer restarts, it displays an error message that Windows was not properly shut down, and it scans the hard disk for errors.

cursor The blinking vertical line on the screen that indicates where the next character displays when you type.

D

data Information that can be processed by a computer. See also *digital*.

database A collection of similar data that is designed for easy retrieval of information.

dedicated line A telephone line that is always connected to the modem (inside the computer) to provide constant access to the Internet. A separate telephone line is used for phone calls.

See also *modem*.

default The option that the software automatically chooses for you when you do not indicate a choice yourself. For example, when you print a document, the **Print** dialog box asks which pages to print (the default is All) and how many copies to print (the default is 1). You can change the settings, and you can designate the new settings as the default.

defragmenting The rearrangement of files and unused space on your hard disk so programs can run faster.

desktop See *Windows desktop*.

dialog box A small window that requests information from the user before a command can be carried out.



digital A system that uses electronic signals to transfer data in the form of bits. A bit is represented by a single digit. Computers use only two digits—either a 0 or a 1—in various combinations. See also *bit* and *byte*.

directory See *folder*.

discussion group A group discussion on a topic of mutual interest held on the Internet. Instead of meeting in a classroom, students may meet for group discussions on the Internet.

disk High-capacity storage media, such as the hard disk inside the computer and the removable media used in a Zip drive or Jaz drive.

floppy Low-capacity, removable storage media made of flexible plastic film encased in a hard plastic shell. Since the plastic film is flexible, the 3.5-inch diskette is sometimes referred to as a floppy diskette.

floppy drive The drive that reads and writes to a diskette.

double-click To push down and quickly release the left mouse button two times in rapid succession to open an item.

download To receive files from another computer on the Internet.

drive A device that reads and sometimes writes to storage media. Examples are the CD drive, DVD drive, LS Compaq drive, floppy drive, and hard drive.

driver Software that enables the operating system to recognize and operate devices installed in or attached to the computer, such as a printer. All drives that use removable media and all peripheral devices have drivers. You can download updated drivers from the manufacturer's Web site.
See also *peripheral*.

drop-down menu A list of options that drops down when you click a menu on the menu bar or the down arrow on a dialog box.

DSL Digital Subscriber Line. A telephone line that carries both voice and data signals; it allows you to talk on the phone and browse the Internet at the same time. The data part of the line, which is continuously connected to the Internet, allows high-speed, high-capacity data transfer. Your local telephone company provides the necessary equipment—a DSL modem, a network interface card, and a splitter.

DSL modem A modem that connects to the Internet using digital subscriber line service through an existing copper telephone line.

DVD Digital Versatile Disc. A CD-sized disc that stores full-length movies, music videos, and multimedia computer games with three-dimensional graphics. Both single-sided and double-sided discs are available.

E

encrypt To translate data into a secret code. You must have access to a secret key or password to read an encrypted file.

See also *secure Web site*.

Ethernet The most widely installed local area network technology. An Ethernet LAN (local area network) typically uses coaxial cable or special upgrades of twisted pair wires. The most commonly installed Ethernet systems provide transmission speeds up to 10Mbps and are called 10BASE-T. Devices are connected to the cable and compete for access using a Carrier Sense Multiple Access with Collision Detection protocol.

Explorer See *Microsoft Internet Explorer* and *Windows Explorer*.

F

fax modem A modem that allows your computer to transmit and receive faxes. The fax modem can transmit documents to fax machines and other computers with fax modems. It can broadcast a fax to several sites at once. A dual-purpose modem functions as both a regular modem that transmits files as attachments, and a fax modem that transmits printed documents.

file extension A dot and two or three letters after a file name that indicate the program in which the file was created. For example, .doc indicates that the file was created in Microsoft Word.

floppy disk See *floppy*.

folder Represented by an icon that looks like a yellow manila folder, a folder contains other folders (subfolders) and files. Both MS-DOS and early versions of Microsoft Windows used the term directory (and subdirectories) for folder (and subfolders).

G

game port A connector on the back of the computer for plugging in a joystick. See also *joystick*.

GIF Pronounced “giff.” A file format for graphics displayed on the Internet. It is easily identified by the file extension .gif. See also *JPEG*.

graphical interface

Communication between a person and a computer by means of images. With a pointing device, such as a mouse, you click an icon to tell the computer what you want. See also *icon*.

graphics Pictures or illustrations, including drawings, pie charts, bar graphs, street maps, architectural and engineering designs, fashion designs, musical scores, cartoons, animated images, and photographs. A graphics card enables the monitor to display these items on the screen. See also *SVGA and XGA*.

H

hard disk Internal storage media for permanent storage of system files, software, and data files. The hard disk consists of flat, round platters. Each side of each platter has a head that floats on a thin cushion of air over the surface of the rapidly spinning disk and picks up (reads) magnetically stored data or records (writes) data onto the disk.

hard drive The drive that reads and writes to the hard disk. If you have a large hard drive, it may be divided into several partitions. Each partition is designated by a different icon and a drive letter, beginning with the letter C. Partition C: contains the files the computer uses to start up. The other partitions contain no pre-installed files.

hardware The physical components of a computer—the parts you can physically touch. See also *software*.

HTML The standard language for documents designed for viewing on the Internet with a browser. Tags embedded in the documents mark the location of other electronic files—including text, graphics, audio, and video files. Click on the links to jump from one document to another. Documents formatted for a browser can be identified by the file extension .htm or .html.

See also *hyperlink*.

http:// This protocol commands the Web server to locate the Web site you requested and transmit the Web site to your computer.

hyperlink An embedded link to another document. When you pass the cursor over a link (usually highlighted text or an image), a small hand with a pointed index finger is displayed. When you click the link, the document to which it points is automatically transferred to your computer—no matter where on the Internet the file is stored. See also *HTML*.

icon A small picture that represents a menu command, file, program, tool, or peripheral.

interactive A computer program that responds to you as if you were having a conversation. You give instructions; the computer performs an action or requests additional information. Computer games, multimedia, and tutorials are interactive programs.

interface A means of communication between two entities. A person and a computer interface through a monitor, keyboard, and mouse. Two computers interface through a network or Internet connection.

Internet A worldwide collection of computer networks that are interconnected so that users can share electronic information.

Internet Explorer

See *Microsoft Internet Explorer*.

Internet keyboard A keyboard that resembles a typewriter keyboard, but is equipped with special buttons programmed to connect to the Internet.

Internet phone A video telephone that allows you to make long-distance calls over the Internet.

ISP Internet Service Provider. A company that provides access to the Internet. To use the service, you need the service provider's software, a user name, a password, and access phone numbers. Through a modem, you can log on to the ISP, browse the World Wide Web, and send and receive e-mail.

J

joystick A lever that moves in all directions to control the movement of a pointer or objects on the screen. It is used for computer games in which you drive, fly, or shoot objects displayed by the monitor.

JPEG Pronounced "J-peg." A file format for graphics, especially photographs, displayed on the Internet. It is easily identified by the file extension .jpg. JPEG files, which store more information per pixel than GIF files, are used for complex, high-resolution images.
See also *GIF* and *pixel*.

L

LAN Local Area Network. Two or more computers that are connected locally to share resources.
See also *network*.

left click To push down and quickly release the left mouse button to select an item.

link See *hyperlink*.

log on To gain access to a computer network or the Internet by entering a user name and password.
See also *network*.

M

main memory Physical memory chips (RAM) inside the computer. Every program you launch and every file you open must be copied from a storage disk, disc, or floppy into main memory. The amount of main memory in your computer determines how many programs you can run and how much data you can process at one time. Memory is measured in megabytes (1 million bytes or characters) of information. Most personal computers come with a minimum of 32 megabytes of main memory—the minimum recommendation for Windows programs. You can insert extra memory (visit the following Web site for more information: www.compaq.com/consumersupport). See also *RAM* and *byte*.

microprocessor A silicon chip inside your computer that processes the instructions and data from input devices (such as the keyboard and mouse) and communicates them to output devices (such as the monitor, speakers, and printer).

Microsoft Internet Explorer

A Web browser developed by the Microsoft Corporation. See also *browser*.

Microsoft Windows

The most popular computer operating system in the world. It is characterized by the use of windows and icons. Each running program and open file has its own window. Instead of memorizing commands, you click icons to communicate with the computer. Clicking the minimize button shrinks a program to an icon on the taskbar. Clicking the icon redisplay the program as a window. You can have several windows open at the same time and toggle from one to another by using **Alt+Tab**. (Press and hold down the **Alt** key, press the **Tab** key, and then release both keys. A palette with an icon for each program is displayed. Click the icon for the program you want.)

See also *Windows desktop*, *Windows Explorer*, and *Windows taskbar*.

MIDI Pronounced “middy.” Musical Instrument Digital Interface. An interface that allows the computer to record sounds created by a synthesizer and then manipulate the data to produce new sounds, such as changing the key of a composition.
See also *interface* and *digital*.

MIDI connector A connector on the back of the computer for plugging in a synthesizer keyboard.

MIDI format A file format used to store electronic music sounds. It can be identified by the file extension .mid. A sound card that supports MIDI files allows the computer to generate the synthesized musical sounds found in games, CD-ROMs, and presentation packages.

minimize To shrink a running program window into an icon on the Windows taskbar. Click the icon to restore the program window.
See also *Microsoft Windows*.

modem A device in the computer that converts data from digital format to analog format so that it can be transferred through a standard telephone line to another computer. The modem in the receiving computer converts the data back to digital format.
See also *digital*.

mouse A device that you move across the top of your desk (or a mousepad) to move the pointer or cursor on the screen. Click to select an item, double-click to launch a program, and right-click to see a shortcut menu.

mouse pointer The arrow on the screen that moves with the mouse.

MP3 The file extension for MPEG, audio layer 3, sound files. This format compresses sound data from a stereo music CD to one-half of its original size without sacrificing sound quality. Because of their small size, MP3 files can easily be transferred over the Internet. You can download individual songs or entire CDs in MP3 format to your computer. The format is easily identified by the file extension .mp3.

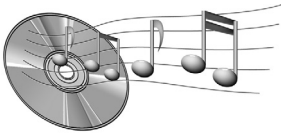

multimedia Two or more media formats used together, such as text, graphics, animation, audio, or video.

music software Programs for composing and editing music. When you play a tune on a synthesizer keyboard connected to a computer, the music program translates what you play into a written score.

N

navigate To move through a Web site or online document by clicking the hyperlinks embedded in the text or images. See also *hyperlink*.

Netscape Navigator A Web browser developed by the Netscape Communications Corporation. See also *browser*.

network Two or more computers linked together to share resources, such as programs, files, and printers. See also *NIC*.

newsgroup A discussion group on the Internet where people can post or read messages on thousands of topics, such as professional basketball, environmental protection, or Himalayan cats.

newsreader A program that lets you read and post messages to newsgroups.

news server A server that receives the Usenet news feed (all the individual messages collected from 100,000 news servers around the world). You access the news server through your Internet Service Provider. See also *Usenet* and *newsgroup*.

NIC Network Interface Card. An expansion card or other device used to connect a computer to a local area network. See also *network*.

O

online To be communicating with another computer through a modem or network. You are online when you log on and establish a connection. You are offline when you lose or terminate a connection. See also *modem* and *network*.

online Help A manual that displays on the screen while you are actually working in a program and need help. It can be accessed through the Help menu at the top of the screen. Help for Windows can be accessed from the **Start** button on the taskbar.

online shopping Ordering products on the Internet. You can purchase books, flowers, music CDs, toys, groceries, stocks, airline tickets, and used cars, among other things.

OS Operating System. The interface that permits a person and a computer to “talk” to one another. Microsoft Windows, the most popular operating system, displays icons, menus, and dialog boxes to find out what you want. You use a mouse and keyboard to reply. See also *Microsoft Windows* and *interface*.

P

parallel port A connector on the back of the computer for plugging in a parallel cable attached to a parallel device, such as a printer. Data is transferred, one byte at a time, through eight data wires (one for each bit in the byte). All eight bits travel side by side and arrive at the same time. A parallel port is faster than a serial port, which lets data through one bit at a time.

See also *digital* and *serial port*.

path A sequence of information that directs the operating system to a file. For example, C:\Windows\Clouds.bmp is the path to a bitmap file named Clouds. It is located in a folder named Windows, which is located on the C: drive.

PC card A removable device that is designed to plug into a PCMCIA slot to accommodate devices such as a modem, fax, and rotating storage media.

peripheral An external device connected to a computer. Examples are a monitor, keyboard, mouse, printer, scanner, joystick, and digital camera.

pixel One of the individual dots, or picture elements, that compose a graphical image. See also *graphics*.

playlist Tracks chosen to play from a CD or DVD.

plug-and-play A feature, introduced with Windows 95, to simplify the use of some peripheral devices. After the device has been installed (in accordance with the manufacturer's instructions), you can plug it into the computer while the computer is running. The operating system automatically recognizes the new device. (In order to connect a non-plug-and-play device, you must first shut down the computer.)

See also *peripheral*.

pop-up menu A list of options that pops up when you right-click an icon on the desktop or taskbar, the vacant part of the desktop, a selection in a document, or a file in Windows Explorer.

See also *right-click*.

processor Short for microprocessor. The brains of the computer.

See also *microprocessor*.

product key A unique series of letters and numbers that is assigned to each software package you buy. You are asked to enter the product key when you install the software. When you register the software, you transmit the product key to the manufacturer to enter in a customer database. Later, when you call for technical support, you are asked for the product key. The technician matches it against the database to determine whether you qualify for support. You should keep a record of all product keys to protect your investment. They are comparable to the serial numbers on hardware.

See also *software*.

program Software that you install on a computer for word processing, drawing, manipulating photos, reconciling your bank statement, calculating your taxes, composing music, or playing games. It is occasionally referred to as an application. See also *software*.

Q

QuikDock A device that provides ports for external devices, allowing you to “dock” and remove your Notebook while your hardware remains connected to the QuikDock. (Available on selected models only).

R

RAM Random Access Memory. The main memory of the computer. It holds a copy of the operating system, any programs that are running on the computer, and any data that is being processed. RAM is temporary memory; turning off the computer clears RAM. The more RAM your computer has, the faster the programs respond. See also *main memory* and *ROM*.

right-click To push down and quickly release the right mouse button to display a shortcut menu of the most commonly used commands for the item you clicked. See also *pop-up menu*.

ROM Read-Only Memory. Memory that contains the basic instructions for the microprocessor. ROM is permanent memory; turning off the computer does not erase it. Since you cannot change or write to ROM, it is referred to as read only. See also *microprocessor*.

S

scanner A device that creates digital images of printed documents and photographs. Software allows you to save and edit the images on the computer. See also *digital* and *software*.

screen saver A moving picture or pattern that displays on the screen when you stop using your computer for a specified period of time. Originally designed to protect the monitor, screen savers are now used for amusement.

scroll To gradually move information across the screen when a document or Web page is too long or too wide to view all at once. Scroll bars are located along the right side and across the bottom of a window. When scroll arrows are present at the ends of the bars, you know that some information is off the screen. Click on one of the arrows to scroll the information into view.

scroll mouse A mouse with a scroll wheel (between the two mouse buttons) for automatic scrolling through long documents or Web pages.

search engine A program, accessed on the Internet, that allows you to search large databases for information, using keywords or phrases. See also *database*.

secure Web site A Web site that encrypts data to protect it from unauthorized use. When you purchase items over the Internet, you are asked to type your name, mailing address, e-mail address, and credit card information on an electronic form. Sending information to a secure Web site is comparable to giving it over the telephone when you order from a catalog. (But never send your social security number over the Internet. Criminals can steal your identity with your social security number.) See also *encrypt*.

serial port A small connector on the back of the computer (or keyboard) for plugging in a thin cable attached to a serial device, such as a mouse. Serial devices transfer data, one bit at a time, through a data wire. The serial cable has two wires for bidirectional communication (sending and receiving information simultaneously). See also *digital* and *parallel port*.

shareware Software you can try before you buy. After a trial period, usually 30 days, the program uninstalls unless you pay for it. You can download shareware from the Internet. See also *software*.

shortcut An icon on the Windows desktop that you double-click to launch a program.

shortcut menu A menu that pops up when you right-click an icon on the Windows desktop or taskbar, the vacant part of the desktop, a selection in a document, or a file in Windows Explorer. The options on the pop-up menu are the most commonly used commands that relate to the item you right-clicked.

See also *right-click*.

sleep mode A low-power state that saves electricity when the computer is not in use.



software The invisible code stored in digital bits and bytes. It consists of a set of instructions that tell the hardware what tasks to perform.

See also *digital* and *program*.

surf To jump from place to place on the Internet, searching for topics of interest, by clicking hyperlinks. Instead of searching for specific information, surfing is an undirected type of Web browsing. You amuse yourself by clicking whatever catches your fancy.

surge protector A device that protects a computer from fluctuations in power. A surge protector regulates the flow of electricity to the computer and prevents high-voltage surges from damaging the equipment.

SVGA Super Video Graphics Array. A video display standard that offers greater resolution and color depth than VGA. The resolution (clarity and sharpness) of an image is determined by the number of pixels that can be displayed per square inch. Color depth is determined by the number of colors (from 256 to 16 million) that can be displayed simultaneously. The number of both pixels and colors is limited by the amount of video memory on the SVGA system.

See also *pixel*.

T

taskbar See *Windows taskbar*.

U

upload To send information to another computer on the Internet.

UPS Uninterruptible Power Supply. A device that provides a short-term backup power supply, as well as surge protection.

URL Uniform Resource Locator. The address of a Web site, such as:
www.compaq.com

USB port Universal Serial Bus port. A connector for plugging in multiple, ultra-high-speed peripherals. USB ports are gradually replacing serial ports and parallel ports and eliminating the need for so many connectors and cables. (Multiple USB peripherals can be linked together in a chain to share the same port.) Windows 98 included a built-in driver for USB peripherals. Windows Millennium and Windows XP support a new USB standard that is 40 times faster than the previous standard.

See also *serial port*, *parallel port*, and *peripheral*.

Usenet Users' Network. A worldwide network of computers set up to transmit messages to newsgroups. See also *newsgroup*.

V

V.90 standard A standard adopted in 1998 to resolve two competing technologies for 56Kbps modems. (If your modem does not conform to the V.90 standard, you can visit the manufacturer's Web site and download a software upgrade.)

V.92 standard A standard adopted in 2000 to improve the V.90 standard in three ways: reduced startup time (time needed to establish connection), new internet call-waiting feature (letting you know that someone is trying to call you without losing the modem connection), and increased maximum upload speed (improve video conferencing and general uploading).

video phone

See *Internet phone*.

virus A set of software instructions written to harm computers. A virus can cause unusual messages to display on the screen, destroy information on the hard disk, or cause your hard disk to crash. Some viruses affect your computer immediately; others are set to activate on a certain date. See also *anti-virus software*.

W

WAV A file format used to store sounds. WAV sound files can be identified by the file extension .wav. Microsoft and IBM developed the format for Windows programs that support sound.

Web See *World Wide Web*.

Web browser See *browser*.

window A framed area that displays on the Windows desktop after you select an item or open a program.

Windows desktop The main screen you see when your computer completes startup. The desktop displays icons (small pictures) that represent items in the operating system (such as My Computer and Recycle Bin), shortcuts to programs installed on your computer, and shortcuts to folders or files. See also *shortcut*.

Windows Explorer A file management program that lets you see the hierarchy of folders on your computer and all the files and subfolders in each folder. Visualizing the hierarchy is useful for copying and moving files. You can open the folder that contains the file you want to move or copy, click and drag the file to a new folder, and then drop it in. To find Windows Explorer, click the **Start** button, and point to **Programs**. You can create a shortcut to Windows Explorer.

Windows taskbar The gray bar running along the bottom of the screen when your computer completes startup. The **Start** button is on the left side of the taskbar, and the systray (a tray with icons and the computer clock) is on the right. Programs that are running, but minimized into icons, are displayed in the middle of the taskbar.

wizard Part of a program that guides you through a complex process, such as signing up with an Internet service provider or posting a Web site to a server. Most programs on CD-ROMs have wizards to guide you through the installation process.

World Wide Web A system of Internet servers that support documents formatted in HTML. See also *HTML*.

X

XGA Extended Graphics Array. A video display standard that offers greater resolution and color depth than VGA, as well as better graphics performance than SVGA. See also *SVGA*.

Z

zipped file A file that has been squeezed to a smaller size by compression software, such as WinZip. An archive (group of related files that are zipped together) can be transmitted as an e-mail attachment much faster than individual files. An archive takes up less storage space on your disk. It can be identified by the file extension .zip. An archive contains a self-extracting program with the file extension .exe (for executable). Double-click the executable file, and a wizard guides you through the process of unzipping the files. See also *wizard*.

1394, troubleshooting 8–10

A

AC adapter

- connecting 6–6
- connector 2–9
- plugging/unplugging 3–3

Air vent location 2–10

Audio features

- digital audio 2–4
- troubleshooting 8–7

B

Back panel components 2–9

Backup procedure 8–2

Battery

- calibrating 6–6
- care of 6–2
- charging 3–8, 4–3, 6–8
- checking 6–3
- connecting AC adapter 6–14
- draining 6–7
- inserting 3–6
- Li-Ion 6–5
- location 2–10
- low condition 6–13
- operating time 6–8
- power management 6–10
- power usage 3–4
- recycling 6–5

release switch 2–10, 3–7

removing 3–7

replacing 6–14

storing 6–4

suspending work 6–15

troubleshooting 8–11

Brightness 2–6

Buffer underrun 5–13

Burning CDs 5–10

C

CD 2–6

basics 5–1

inserting 5–2

CD or DVD drive

See also DVD drive

audio CDs 5–5

CD-RW 5–10

function key 2–6

identifying DVD region 5–8

inserting disc 5–2

manually ejecting disc 5–4

playing audio CDs 5–5

removing disc 5–3

video discs 5–5, 5–6

CD-RW drive

buffer underrun errors 5–13

Roxio Easy CD Creator 5–10

Cleaning procedures

display screen 7–4

- exterior 7-2
- external mouse 7-5
- keyboard 7-3
- TouchPad 7-4
- Compaq Help and Support 8-3
- Components
 - backpanel 2-9
 - display release latch 2-1
 - function keys 2-6
 - Internet Zone buttons and lights 2-4
 - left panel 2-7
 - lower front panel 2-3
 - right panel 2-8

D

- Display
 - cleaning 7-4
 - components 2-2
 - external monitor 2-6
 - hibernation 3-5
 - release latch 2-1
 - switching between 4-2
 - troubleshooting 8-9
- Drives
 - location 2-7
 - storage 3-14
- DVD drive
 - on-screen controls 5-7
 - playing 5-7
 - region settings 5-8
 - troubleshooting 8-12
 - working with discs 5-1

E

- Easy CD Creator 5-10
- Edge motion 3-12
- Ejecting
 - CD or DVD 5-3
 - manually 5-4
- Electrical safety 1-6
- Ethernet connection 4-10
- External device connectors 2-9
- External mouse cleaning 7-5

F

- F10 Setup 3-16, 3-17
- Feet, pop-up 2-10
- Front panel components 2-2
- Function keys 2-6

G

- Getting Started Poster 1-2

H

- Headphone jack 2-7
- Help
 - contacting Compaq 8-5
- Help launch key 2-6
- Hibernation mode 6-12

I

- Installing
 - hardware devices 4-6
 - software 4-5
- Installing memory 4-6
- Internet Zone buttons 3-13

K

Kensington lock. *See* Security

Keyboard

cleaning 7-2, 7-3

function keys 2-6

Keys, function 2-6

L

Left panel components 2-7

Li-Ion battery storage 6-4

lock, Kensington. *See* Security

Low battery condition 6-13

Lower front panel 2-3

M

Maintenance guidelines 7-1

Manual ejection 5-4

Mass-storage sources 3-14

Memory

location 2-10

troubleshooting 8-18

upgrading 4-7

Microphone jack 2-7

Model and serial number 2-10

Mouse cleaning 7-5

Movies playing 5-7

N

Non-DVD video discs 5-6

P

Parallel port 2-9

Password

defined 3-15

removal 3-17

setting 3-16

PC card

troubleshooting 8-18

PC card slot 2-7

Pop-up feet 2-10

Ports 2-9

Power

See also AC adapter; Battery

button 3-5

disconnecting from 1-6

electrical safety 1-6, 1-7

indicator 2-2

management 6-10

modes 6-11

surge protectors 3-3

troubleshooting 8-11

turning on and off 1-6, 3-4

Power surge 1-7, 3-3

Power-on password 3-15

R

Recycling batteries 6-5

Restore utilities 8-2

S

Safety and Comfort Guide 1-3

Safety issues 1-6

Scroll button 3-10

Security 3-15

Serial number location 2-10

Service and support launch key
2-6

Setup poster 1-2

Sleep mode

entering 6-11

function key 2-6

Software, adding and removing
4-5

Solution tables

See also Compaq Help and Support

audio and video 8–7

battery and power 8–11

keyboard and TouchPad 8–16

mass-storage 8–12

memory and PC cards 8–18

Standby 6–11

Storage drives, identifying 3–14

Storing batteries 6–4

Surge protectors 3–3

Suspending work 6–15

S-Video 4–2, 4–3

Switches

battery release 2–10

Symbols and graphics 1–5

T

TouchPad

button location 2–2

cleaning 7–4

components 2–2

edge motion 3–12

tapping 3–10

using 3–9

Troubleshooting

See also Compaq Help and Support

audio 8–7

battery 8–11

CD drive 8–12

diskette 8–13

DVD 8–12

memory 8–18

power 8–11

video 8–7

U

Underside components 2–10

Upgrades, memory 4–6

V

Video discs, playing 5–5

Volume, troubleshooting 8–7

W

Warranty certificate 1–3

Writing files to CD-R/CD-RW
5–12