

# Online Manual

## Table of Contents

Navigating the online manual .....	2
<b>Printing Basics</b> .....	<b>3</b>
How to choose paper .....	3
How to put the paper in the printer .....	4
Finding the HP print settings box .....	6
How to print on standard paper sizes .....	8
How to print on nonstandard paper sizes .....	10
How to print on both sides of the paper .....	11
How to flip a document .....	13
About color .....	14
About pictures .....	15

## Beyond the Basics .....

17

Cards .....	18
Envelopes .....	20
Labels .....	22
Photographs .....	23
Transparencies .....	25
Iron-On Transfers .....	26

## Getting Help .....

28

The HP Toolbox .....	28
Troubleshooting with the Toolbox .....	29
HP Customer Support .....	30

## Appendices .....

35

Print Cartridges .....	35
Aligning the print cartridges .....	41
Minimum printing margins .....	42
Ordering supplies and accessories .....	43
Uninstalling the printer software .....	47
Environmental Attributes of the DeskJet Printer .....	48

# Navigating the online manual

Use the navigation controls at the bottom of each page to move through the guide:



Go to the Table of Contents



Go to previous page



Go to next page

Acrobat Reader provides a number of ways to page through a document. You may use the navigation buttons in the toolbar.

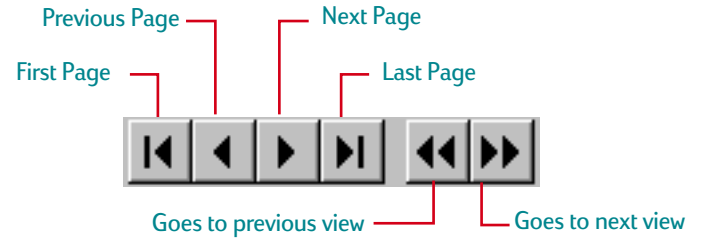

You may also press the arrow keys or choose an action from the View menu. Refer to the *Acrobat Reader Online Guide* for more information.

# Printing Basics

## How to choose paper

Most plain photocopy paper works fine in your printer, particularly paper that is marked for use in inkjet printers. To get the best results, use one of the Hewlett-Packard papers, which were developed especially for HP inks and your printer.

*What to consider:*

- **Size.** You can use any size paper that fits easily within the paper adjusters of the printer.

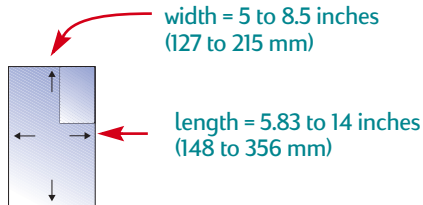

- **Weight.** You can choose from a wide range of paper weights. Use 20-24 lb or 75-90 g/m<sup>2</sup> plain paper for multipurpose, everyday use.

- **Brightness.** Some papers are whiter than others and produce sharper, more vibrant colors. Use HP Photo Paper or HP Premium Photo Paper for printing photographs and documents with photographs; use white paper, such as HP Bright White Inkjet Paper for everyday color printing.
- **Surface smoothness.** The smoothness of the paper affects how crisp the printing looks on the paper. Paper with a high cotton content (25% to 100%) tends to offer greater surface smoothness. Glossy, coated paper works well for pictures and charts (where you want crisp lines with intense, high-quality colors) and for photocopying.
- **Opacity.** Opacity refers to the degree to which printing on one side of the paper shows through to the other side. Use paper high in opacity (or thicker paper) for two-sided printing.

## Determining the print side of paper

Be sure to insert all paper, transparencies, cards, envelopes, and paper labels *print side down* into the IN tray of the printer. For plain paper, the print side is identified by a symbol or word on the packaging.

- For letterhead paper, *load the letterhead side down and forward.*
- For HP Premium Transparency Film, *load the rough side down with the adhesive strip forward.*
- For HP Premium Inkjet Paper, *load the print side down with the corner arrow pointed forward.*
- For HP Premium Inkjet Glossy Paper, *load the glossy side down.*
- For paper labels, *load the label side down.*

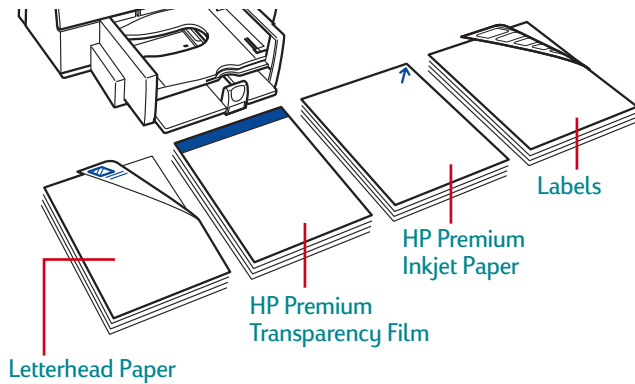

## How to put the paper in the printer

The lower (IN) tray is the printer's launch pad. Careful preparation ensures a successful journey. Make sure all the paper in the tray is the same size and is stacked neatly and snugly for a smooth take-off.

*Let's walk through the process step-by-step:*

- 1 Slide out the paper-width and paper-length adjusters to make room for the paper.

Do this no matter what size paper you're using.

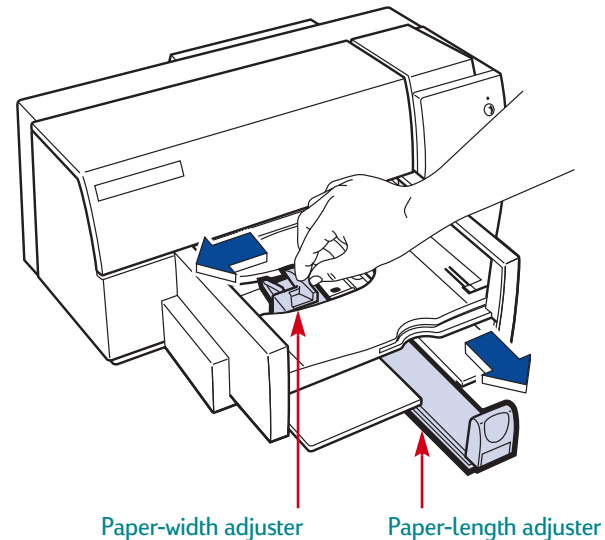

- 2 Fan the edges of the paper stack to separate the pages. Then tap the stack on a flat surface to even it.

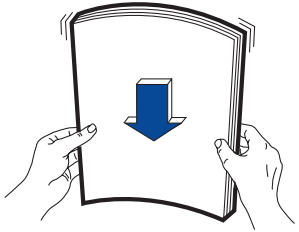

- 3 Put the paper in the lower (IN) tray, print side down.

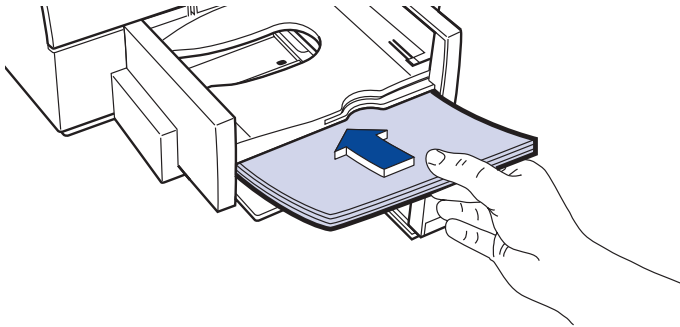

- 4 Slide the paper-width adjuster to the right until it aligns with the left edge of the paper stack.

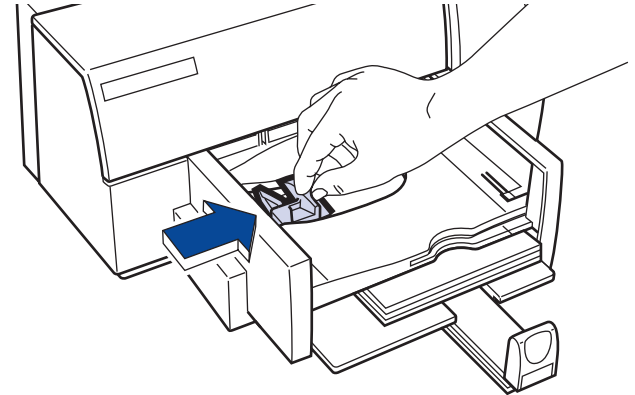

Make sure the paper still lies flat in the tray.

- 5 Slide the paper-length adjuster in toward the paper until it stops.

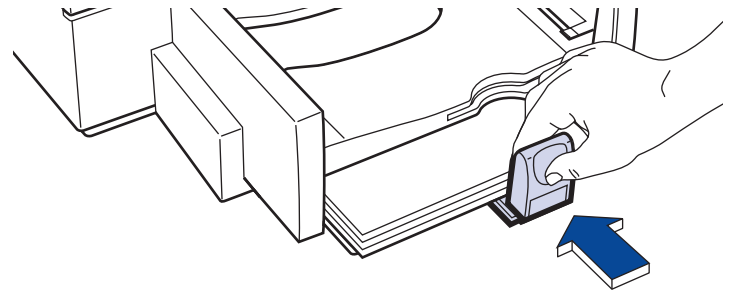

Make sure the paper does not bend in the IN Tray.

# Finding the HP print settings box

After you lay out the page and choose the text, pictures, fonts, and colors from your software program, you need to select settings such as paper type, paper size, orientation, and print quality in the HP print settings dialog box. Where is it?

The way you get there varies depending on the software program and the operating system you're using. Try these strategies from the File menu of your document, and you're sure to get there.

## Try This...

- 1 Click *File* and then click *Print*.

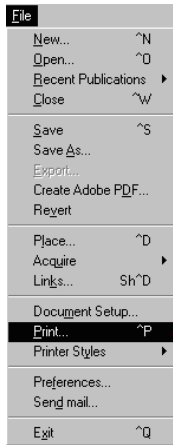

- 2 Then click whichever button you see—*Properties*, *Setup*, or *Printer*.

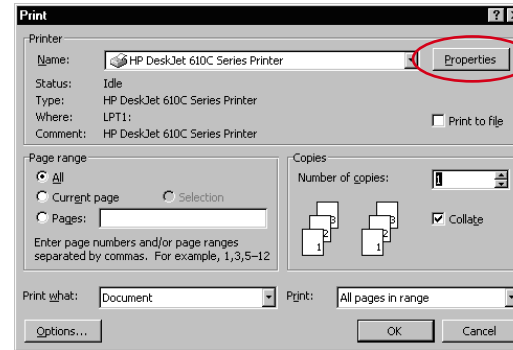

- 3 If you still don't see the box, click *Setup*, *Options*, or *Properties*.

## ...Or Try This

- 1 If Print isn't there, click *Printer Setup* or *Print Setup*.

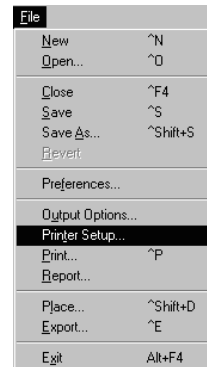

2 Then click whichever button you see—*Setup* or *Options*.

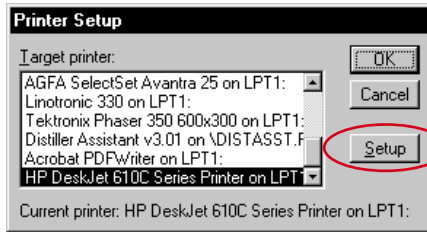

...then click a tab, and then click a setting.

Show your finished work at its best.

Click *Best* print quality.

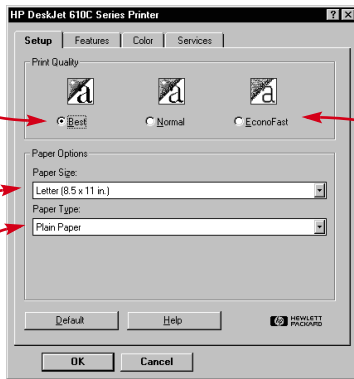

Save time and ink. Click *EconoFast* print quality.

Select the appropriate settings.

Choose the correct paper size and type for the job.

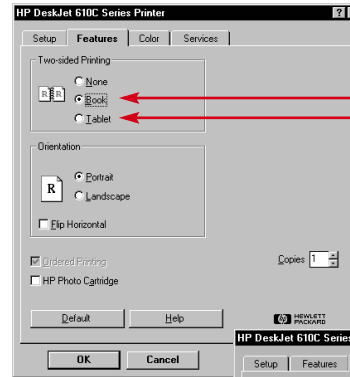

Save money and trees.

Print on both sides of the paper.

Fine-tune your printing.

Pick options to create the effect you want.

Save time and color ink.

Click here to print drafts of color documents in shades of gray

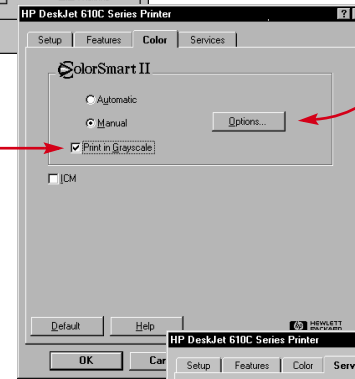

Print clearly.

Align your black and color print cartridges, and clean them when necessary.

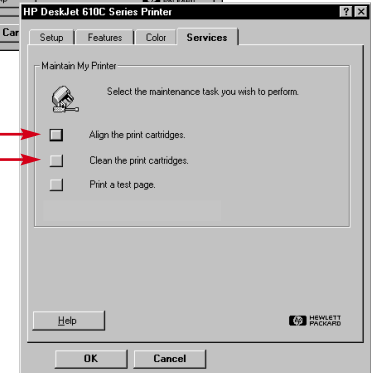

# How to print on standard paper sizes

## 1 Check your print settings.

Choose your print settings in the HP print settings dialog box. (See “Finding the HP print settings box” on page 6.)

Choose color options on the *Color* tab.

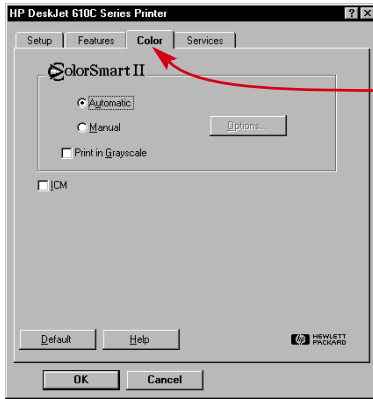

Click the *Color* tab.

**Note:** Depending on the operating system on your computer, your boxes might differ from the Windows 95 boxes shown throughout this document.

Choose print quality, paper size, and paper type on the *Setup* tab.

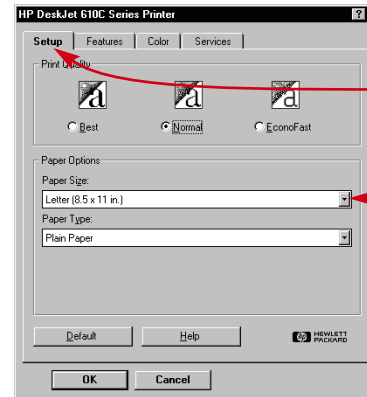

Click the *Setup* tab.

First click the down arrow, and then click your selection.

Choose two-sided printing, orientation, and flip horizontal options on the *Features* tab.

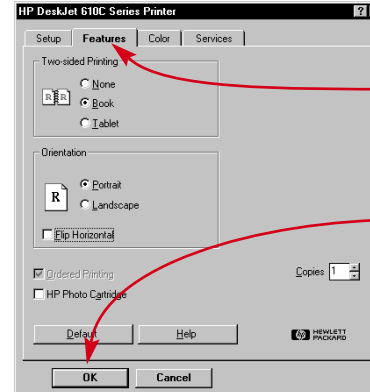

Click the *Features* tab.

Click *OK* to save.



- 2 Click *OK* in the Print box of your software program to save your settings and start printing.

You might need to click *File* and then click *Print* to reach the Print box.

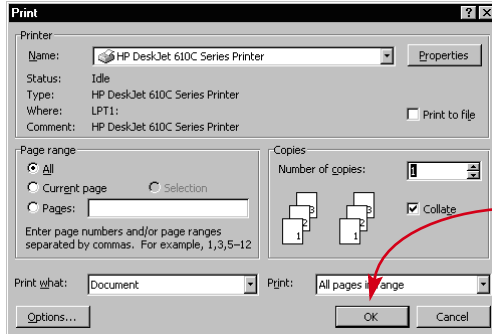

Click *OK*.

## If you run out of paper before you're finished

The printer prompts you to add more paper. Put the paper in the lower (IN) tray and press Resume .

That's all there is to it. The printer prints one page at a time until it finishes, delivering each printed page neatly into the printer's upper (OUT) tray.

## While you're printing

It takes a few moments for the printing to start, because the printer is receiving information from the computer. During printing, the printer might pause occasionally to receive more information. (Don't worry, it's normal.)

## If something goes wrong

Sometimes, in spite of your best efforts, something goes wrong during printing. Maybe a sheet of paper jams in the printer or nothing happens at all.

- If the printer detects a problem, it displays a message on your screen.

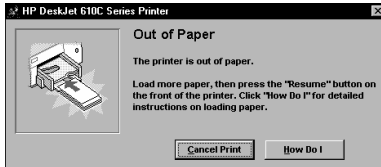

If you notice that something is wrong, click the *Troubleshooting* tab in the HP Toolbox and follow the instructions on the screen. (See “Finding the HP print settings box” on page 6.)

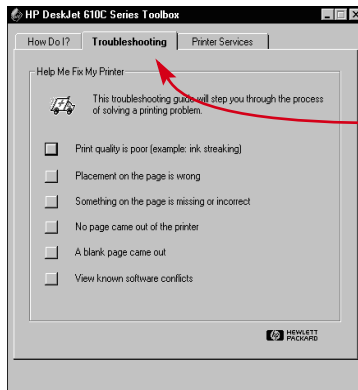

Click the *Troubleshooting* tab.

## How to print on nonstandard paper sizes

Most of the time, when you print on plain paper, cards, labels, and envelopes, you select one of the standard sizes in the *Paper Size* box on the *Setup* tab of the HP print settings dialog box. However, you're not limited to the sizes listed. Just make sure that the size of the paper falls within the following dimensions (so both of the printer rollers can pick up the paper):

**Width:** 5 to 8.5 inches (127 to 215 mm)

**Length:** 5.83 to 14 inches (148 to 356 mm)

*Then follow these steps:*

In the HP print settings dialog box, click the *Setup* tab, and then select *Custom* in the *Paper Size* list. (See “Finding the HP print settings box” on page 6.)

# How to print on both sides of the paper

The easiest way to save paper is to print on both sides. Just put the paper through the printer twice: the first time through it prints the odd-numbered pages and the second time through it prints the even.

- 1 Put the paper in the lower (IN) tray.  
Make sure that there's no paper in the upper (OUT) tray.
- 2 In the HP print settings dialog box, click the *Setup* tab, and click *Plain Paper* or *HP Photo Paper* as the paper type. (See "Finding the HP print settings box" on page 6.)
- 3 Click the *Features* tab and then click *Book* or *Tablet*.

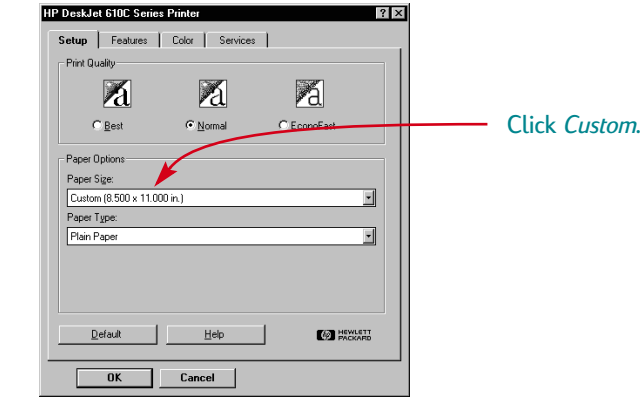

- 3 Type the dimensions of the paper in the *Custom Paper Size* dialog box, and click *OK*.



- 4 Put the paper in the printer, and print as you would for normal paper sizes.

Remember to change the paper size back to *Letter*, or *A4*, or whatever paper size you plan to print on next.

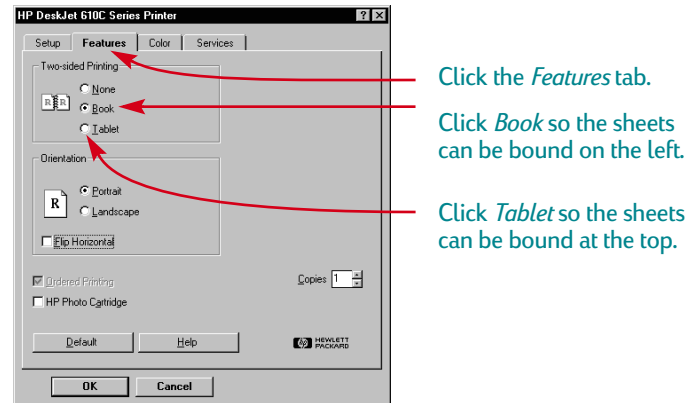

**4** Print your document.

The printer automatically prints only the odd-numbered pages.

**5** Put the printed pages back in the lower (IN) tray of the printer.

A message on your screen tells you which direction to put the printed pages back in the printer. The following illustrations show how to put the paper back in the printer for the *Book* option and the *Tablet* option.

**Book option**

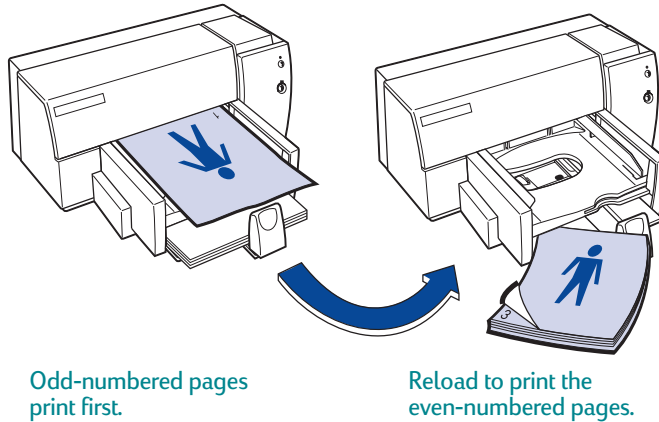

**Tablet option**

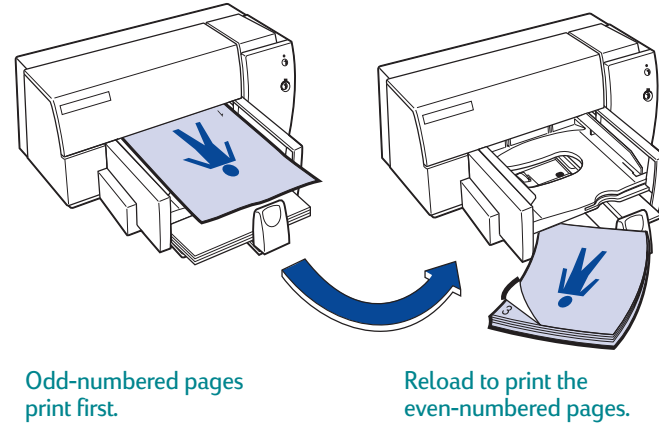

**6** When the paper is ready, click *Continue*.

The printer prints the even-numbered pages on the reverse side of the odd-numbered pages.

After printing, remember to change the *Two-Sided Printing* option back to *None*.

# How to flip a document

When you print a flipped document, the text and pictures are reversed, so they'll be correct when transferred.

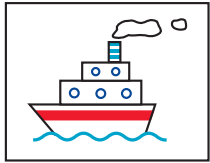

The original

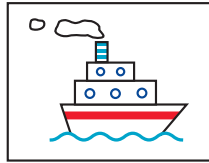

The flipped document

1 Put the paper in the lower (IN) tray, print side down.

If you're using transparencies or special paper, you might need to follow additional directions. (See page 25 for information about printing transparencies.)

2 In the HP print settings dialog box, click the *Features* tab, and then click *Flip Horizontal*. (See "Finding the HP print settings box" on page 6.)

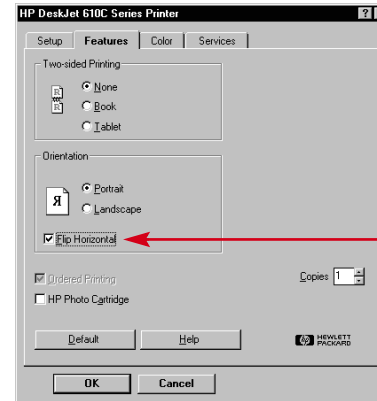

Click *Flip Horizontal*.

3 Print your document.

The text and pictures are backwards. Hold it up to a mirror to see how the final product will look.

*After printing, remember to:*

- Click *Flip Horizontal* box again to clear it.
- If you used transparencies or special paper, replace it with your everyday paper.

## About color

Your HP DeskJet 610C Series printer prints in color when a color-capable software program is used with the printing software. Believe it or not, your color printer prints with only four colors—cyan, magenta, yellow, and black. By printing overlapping dots of different intensity and color, it creates practically any color you can imagine.



Cyan



Magenta



Yellow



Black

Your printer is especially smart about printing color. (That's why HP called the technology ColorSmart™!) When you print a document in color, the printer marks each element in your document—text, full-color photographs, and graphics (such as pie charts with solid blocks of color)—and renders each at its vivid best. (If you use the photo cartridge when you print color photographs, you'll get photo-quality images!) Not only is the color quality high, for whatever you're printing, but it's also less expensive than making color copies at a copy shop.

## How to turn off color

The color text and pictures that you create in your documents automatically print in color. You can print drafts of your documents in grayscale if you're going to photocopy them in black and white, or if you want to save time and ink.

- In the HP print settings dialog box, click the *Color* tab, and then click *Print in Grayscale*.



Now your color documents print in shades of gray until you change the setting. For faster draft printing in grayscale, use the black print cartridge, not the photo cartridge.

# About pictures

Pictures (also called *graphics*) include photographs, illustrations, charts, and decorative elements.

Photographs



Charts and Graphs

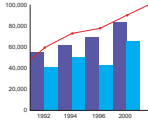

Decorative elements



Illustrations

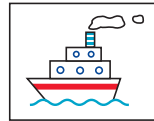

- Use ready-made clip art. You can purchase libraries of clip art from a variety of sources or browse the Internet for what's available there. Look through computer magazines for the names of companies that sell clip art. They'll be happy to send you full-color pictures of their extensive offerings. Or browse in the art sections of bookstores for books of copyright-free pictures.



## How to get a picture on your computer

To put a picture in a computer document, you first need to convert it into an electronic form (a computer file). Then it's simple to copy it into a document—the guide for the application you're using tells you how. Here are some possibilities for getting your pictures into an electronic form:

- Draw the pictures, using the drawing tools in a software application.

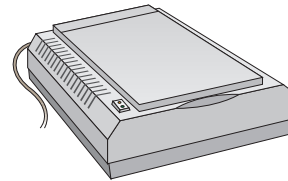

- Remember that it is against the law to copy any photograph unless you have been given specific permission to do so by the person or company who owns the original.
- Scan the pictures yourself. Use your own scanner or gather your pictures together and rent a scanner at a local copy shop.

- Get your photos scanned at your local camera shop. For a small fee, you can have an entire roll of photos put on a CD. Be sure to ask your camera shop to also put a CD-viewing program on the CD with your photos.

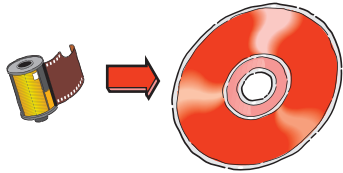

- Take a digital photo. A digital camera bypasses film entirely and turns the photo into a computer file. Call a full-service copy shop or a camera supply store about renting one.

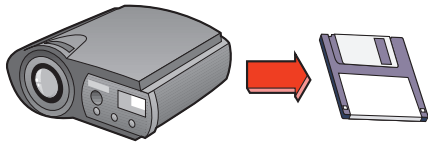



# Beyond the Basics

With the printing basics down, you're ready for some results. Here are some ideas for printing on different paper types.



Business cards, recipe cards, or invitations to opening night.



Envelopes—either one at a time or as a stack.



Labels—scan your logo in full color, and add it to your company address to print distinctive labels for packages and manila envelopes.



Photographs—make personalized buttons, name tags, or photographic calendars.



Transparencies for that important overhead presentation.



Iron-on transfers on t-shirts printed with your company logo.



# Cards

Use your printer to print on index cards or postcards—or any card size included in the Paper Size list on the *Setup* tab shown below. (You can print on other sized cards, too. If the dimensions of your card aren't the same as those shown in the Paper Size list, print it as for a nonstandard paper size.)

- 1 In the HP print settings dialog box, click the *Setup* tab, and then select a card in the *Paper Size* drop-down box. (See “Finding the HP print settings box” on page 6.)

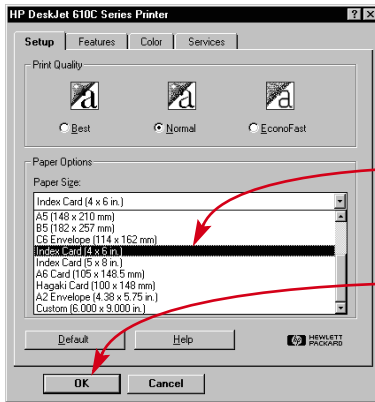

Select a card type.

Click *Ok*.

- 2 Remove the upper (OUT) tray.

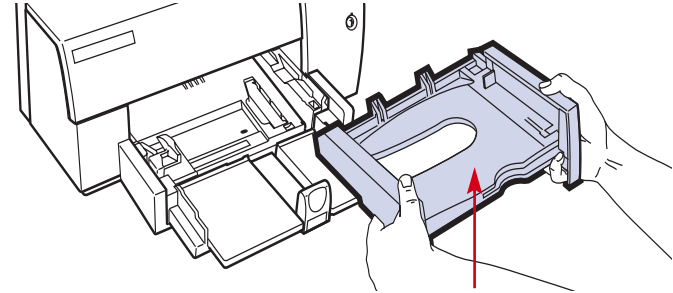

Remove the upper (OUT) tray.

- 3 Raise the card guide.

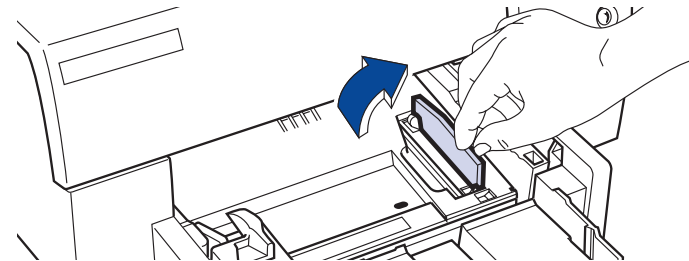

- 4** Put a stack of up to 30 cards in the lower (IN) tray.  
Make sure the short edge is forward and the right edge of the card stack rests against the raised card guide.

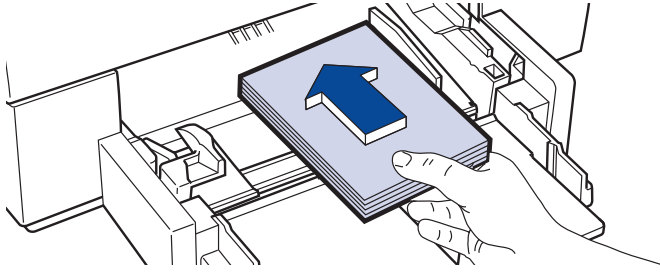

- 5** Lower the handle on the paper-length adjuster so that it doesn't interfere when replacing the upper (OUT) tray.  
**6** Slide the paper-width adjuster to the right until it fits snugly against the cards.

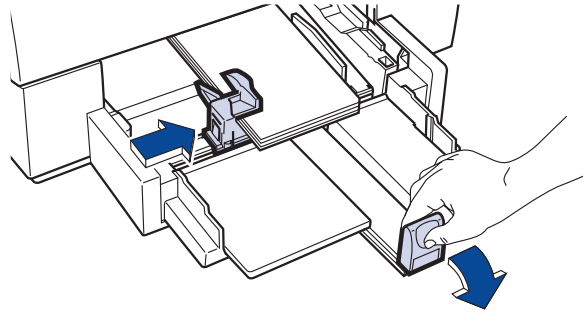

Press the lower-inside portion of the handle to release it.

- 7** Slide the paper-length adjuster in toward the card stack until it stops.

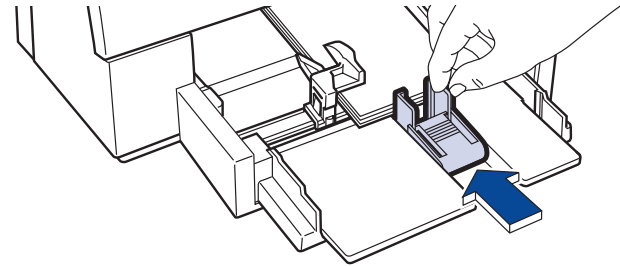

- 8** Replace the upper (OUT) tray.  
You might need to lift up the top cover a little to do this.  
**9** Print the cards.

*After printing, remember to:*

- Return the card guide to the down position.
- Flip up the handle on the paper-length adjuster.
- Change the *Paper Type* and *Paper Size* in the HP print settings dialog box to match whatever you'll be printing next.



# Envelopes

Many programs include a feature for printing envelopes. In that case, follow the program's instructions for setup and for placing the envelopes in the printer.

Your printer provides two methods for printing envelopes:

- If you're printing a single envelope, you can use the single-envelope slot and leave your paper in the lower (IN) tray. This allows you to print the envelope and then a letter.
- If you're printing a stack of envelopes, use the lower (IN) tray.

## How to print a single envelope

1 In the HP print settings dialog box, click the *Setup* tab, and then select an envelope size in the *Paper Size* drop-down box. (See "Finding the HP print settings box" on page 6.)

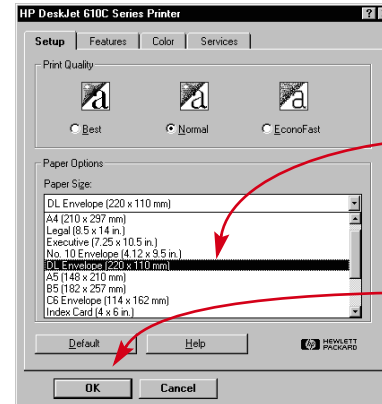

Select an envelope.

Click OK.

- 2 Slide the envelope into the single-envelope slot, as shown here, until it stops. Make sure there's paper in the lower (IN) tray. Make sure the flap edge of the envelope aligns with the right side of the single envelope slot.

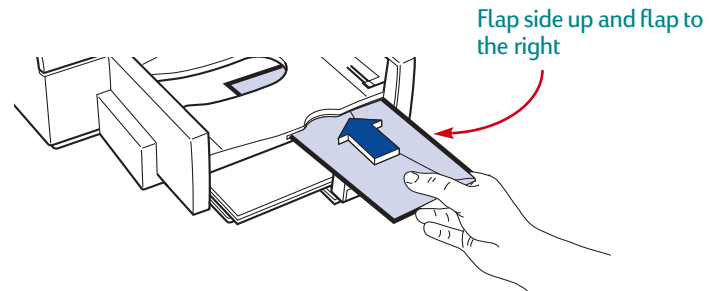

- 3 Print the envelope.

## How to print a stack of envelopes

- 1 In the HP print settings dialog box, click the *Setup* tab, and then select the envelope you're printing on as the Paper Size. (See "Finding the HP print settings box" on page 6.)

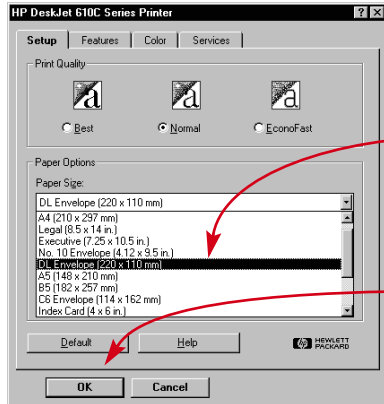

Select an envelope.

Click OK.

- 2 Slide both paper adjusters out.

Make sure the lower (IN) tray is empty.

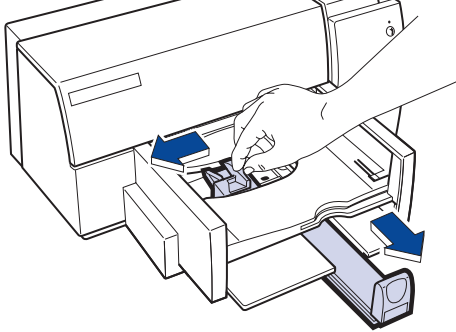

- 3 Put a stack of up to 20 envelopes in the printer, as shown below. (If you're using thick envelopes, you might need to reduce the quantity.)

Make sure the flap edge of the envelopes align with the right side of the lower (IN) tray.

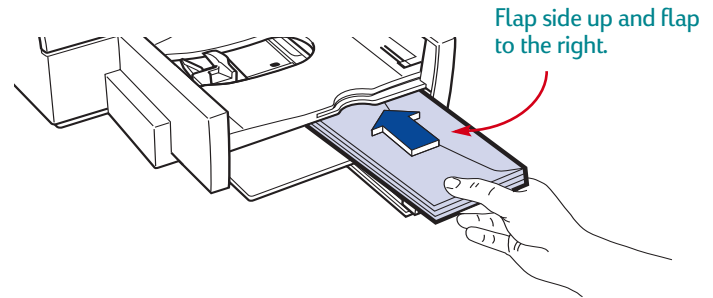

- 4 Slide the paper-width adjuster to the right until it aligns with the left edge of the envelope stack.

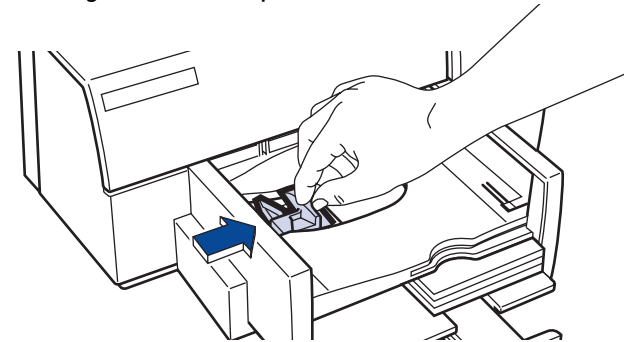

- Slide the paper-length adjuster in toward the envelopes until it stops.

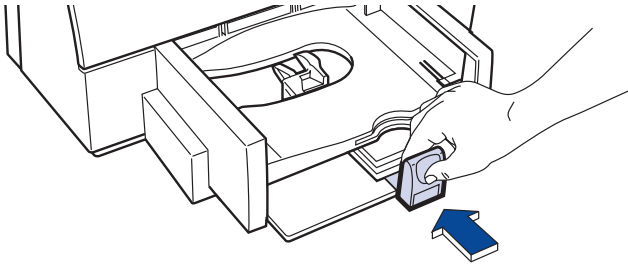

If you're printing on small envelopes such as Invitation A2 or C6, you need to lower the handle on the paper-length adjuster so that it slides under the upper (OUT) tray. Lowering the paper-length adjuster handle reduces the capacity to no more than 10 envelopes.

Make sure the envelopes do not bend in the lower (IN) tray.

- Print the envelopes.

*After printing, remember to:*

- Reset the *Paper Size* and *Paper Type* on the *Setup* tab of the HP print settings dialog box for whatever you'll be printing on next.

## Labels

You can use your HP DeskJet printer to print sheets of labels. We recommend labels which are designed for your inkjet printer.

- Click the *Setup* tab in the HP print settings dialog box. Then select *Plain Paper* as the Paper Type and *Letter* or *A4* as the Paper Size. (See “Finding the HP print settings box” on page 6.)

**Note:** Some programs provide a mailing-label feature that you can use to automatically format labels.

- Then select *Normal* as the Print Quality.

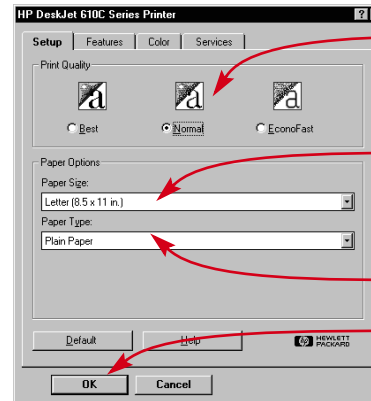

Click *Normal*.

Select *Letter* or *A4*.

Select *Plain Paper*.

Click *OK*.

- Fan the edges of the label sheets to separate them.

- 4 In the lower (IN) tray, place up to 25 label sheets on top of about 5 sheets of plain paper of the same size.

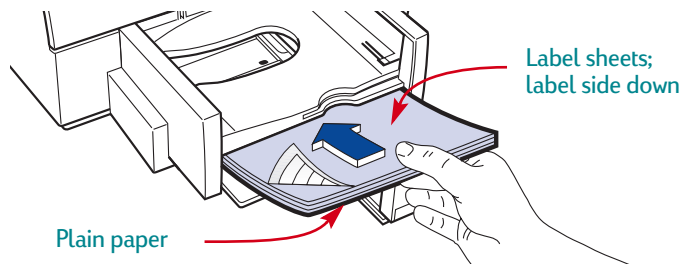

- 5 Slide the paper adjusters to fit snugly against the stack. Make sure the sheets do not bend in the lower (IN) tray.

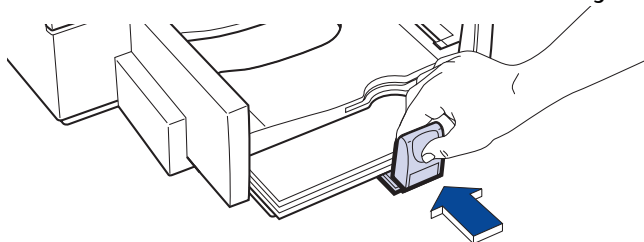

- 6 Print the labels.

*After printing:*

- You can leave the settings as they are if you're going to be printing on plain paper. You might want to change the Print Quality to *EconoFast* for printing drafts.
- Remove the label sheets from the lower (IN) tray and replace them with whatever you'll be using next.



## Photographs

For best results when printing photographs, use an HP Photo Cartridge. For information on purchasing photo cartridges and storage containers, see page 45. Each time you print photographs, you replace the black print cartridge with the photo cartridge.

### First, put the photo cartridge in the printer:

- 1 With the printer turned on, open the top cover.

The cartridge cradles move to the center of the printer and the Resume  light flashes.

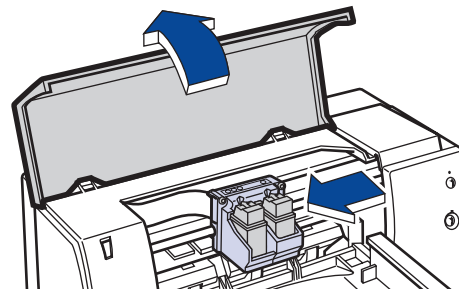

- 2 Pull the top of the black print cartridge toward you until it pops loose. Then lift it from its cradle.

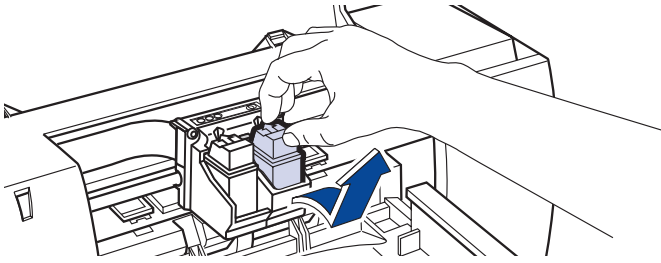

- 3 Store the black print cartridge in the print cartridge storage container or other airtight container.
- 4 Place the photo cartridge into the now-empty cartridge cradle, and push it back into position.

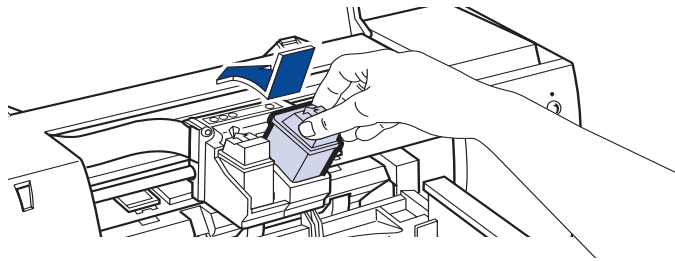

You hear a click when the cartridge sits snugly in its cradle.

- 5 Close the printer's top cover.  
The cradles return to their home position on the right side of the printer and the Resume  light stops flashing.

## Next, align the cartridges:

- If you're using a new cartridge, align the cartridges.
- Use plain paper when aligning the cartridges to save your photo paper.

## Now, print your photograph:

- 1 In the *Setup* tab of the HP print settings dialog box, click *HP Photo Paper* or *HP Premium Photo Paper* for the Paper Type. (See "Finding the HP print settings box" on page 6.)
- 2 Load the paper as you would for normal printing.  
Make sure you insert the paper glossy-side down.
- 3 Print the document.  
For the best results, remove each sheet promptly after printing, and allow it to dry glossy-side up. (The drying time will vary depending on the humidity.)

### After printing, remember to:

- 1 Remove the photo cartridge from the printer and replace it with the black print cartridge. Store the photo cartridge in the storage container.
- 2 If you used any special paper, remove it from the lower (IN) tray and replace it with plain paper.
- 3 Align the print cartridges.





# Transparencies

For best results, use HP Premium Inkjet Rapid-Dry Transparencies, or transparencies specifically designed for inkjet printers, for your overhead presentations.

- 1 In the HP print settings dialog box, click the *Setup* tab, then select *HP Transparency* as the Paper Type. (See “Finding the HP print settings box” on page 6.)

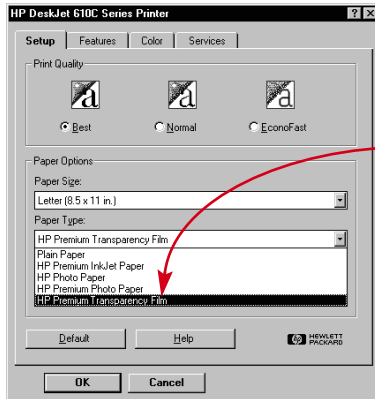

Select *HP Premium Transparency Film*.

- 2 Make sure *Best* is selected as the Print Quality.

It isn't absolutely necessary to use the *Best* Print Quality, but it'll give you the best results. If you're in a hurry, use *Normal* Print Quality.

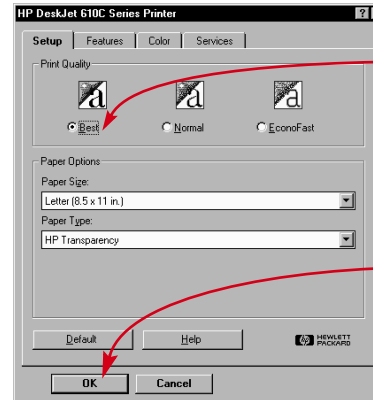

Best print quality.

Click *OK*.

- 3 Put the transparencies in your printer with the rough side down and the adhesive strip forward. (You can peel off the adhesive strip after printing.)

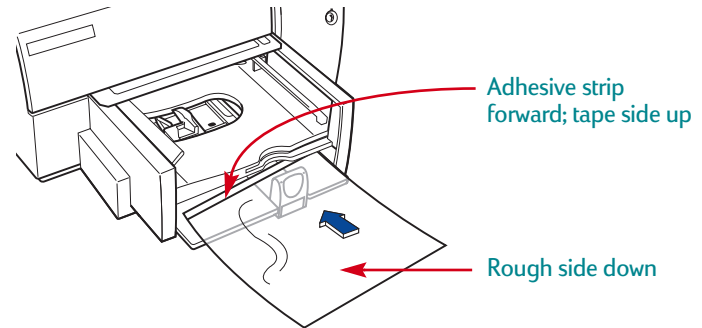

## Iron-On Transfers

When it comes to printing images, you don't need to stop with paper. Use transfer paper to get the images from the computer document onto cloth. HP Iron-On T-Shirt Transfers are designed to work with your printer and HP ink to give you a professional silk screen look.

Although 100% cotton t-shirts are a popular choice for iron-on transfers, you need not stop there. Transfer a photo onto an apron, or add the company logo to baseball caps, sun visors, and tote bags for the company picnic.

### *You'll need:*

- the t-shirt or other cloth you want to transfer an image onto
- the document containing the picture or text you want to print
- iron-on transfer paper

### *Here's how you do it:*

- 1 On your computer, open the document containing the text or picture you want to transfer to the t-shirt.
- 2 Use the color and photo cartridges. (See page 23 for instructions on putting the photo cartridge in the printer.)
- 3 In the HP print settings box, click the *Setup* tab. Select *HP Premium Inkjet Paper* as the paper type.

4 Slide in the paper adjusters, just as you would for plain paper.

5 Print the transparency.

6 Be patient.

Because the printer uses more ink, lays the colors down more slowly, and allows for a longer drying time between sheets, transparencies take awhile to print.

### *After printing, remember to:*

- Change the Paper Type back to *Plain Paper* or whatever you'll be printing on next.
- Change the Print Quality back to *Normal* or whatever is appropriate for what you'll be printing next.
- Remove any remaining transparencies from the lower (IN) tray and replace them with whatever you'll be using next.

- 4 If you want the text or picture on your t-shirt as you see it on the screen, flip the document by clicking *Flip Horizontal* on the *Features* tab.

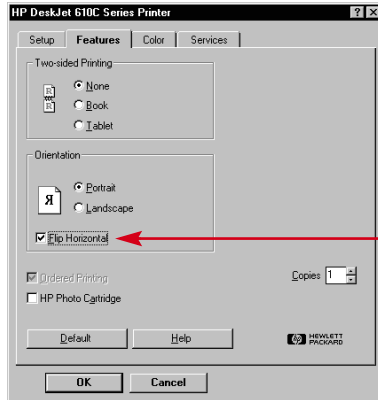

Click *Flip Horizontal*.

- 5 Load the transfer paper transparent side down in the printer.  
6 Print the transfer.

- 7 Follow the instructions included with the iron-on transfer paper to transfer the image onto your shirt.

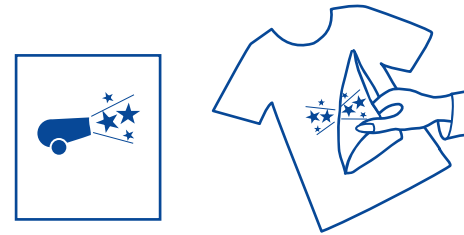

After printing, remember to:

- Click the Flip Horizontal box in the print settings box to clear it.
- Replace the transfer paper with your everyday paper.

# Getting Help

When problems occur, the quickest way to find a solution is to use the online troubleshooting feature. In this section, you will find information on how to get to the HP Toolbox on different Windows systems. If you need additional assistance, this section tells you everything you need to know about contacting HP Customer Support.

## The HP Toolbox

The HP Toolbox tells you how to print and how to troubleshoot your printing problems. It even aligns and cleans your print cartridges for you. For each Windows system, here are a couple of places to find it.

### Windows 95, Windows 98, and Windows NT 4.0

Do one of these to find the HP Toolbox:

- Double-click the HP Toolbox shortcut icon. This shortcut is always on your desktop.
- Click the HP Toolbox taskbar button. This button appears on the taskbar at the bottom of the screen when the HP Toolbox is open and whenever you're printing.

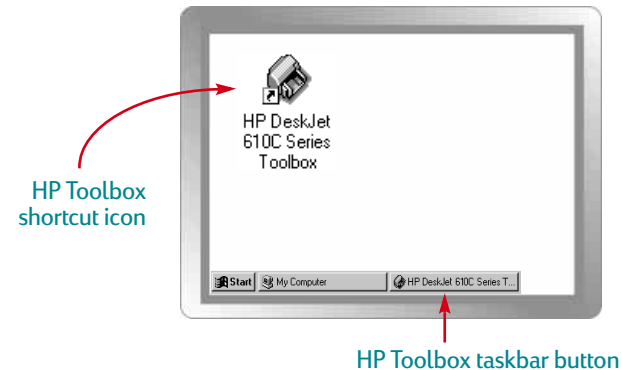

## Windows 3.1x

Do one of these to find the HP Toolbox:

- If you close the HP Toolbox, it reappears when you're printing. You can also double-click the HP Toolbox icon in the HP DeskJet Utilities group in the Program Manager.
- Double-click the HP Toolbox icon. It's on your desktop when you start your computer.

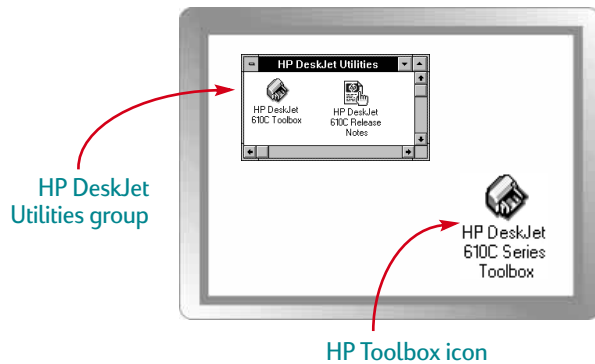

## Troubleshooting with the Toolbox

When problems occur, the quickest way to find a solution is to use the online troubleshooting feature. With a few clicks of the mouse button, you'll find your specific problem and details on how to fix it.

### Click your way to a solution

- 1 Double-click the HP Toolbox shortcut (or icon) on your desktop!
- 2 Then click the *Troubleshooting* tab.
- 3 Click the appropriate category.

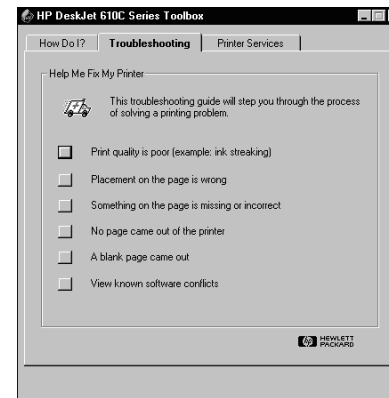

## 4 What seems to be the problem?

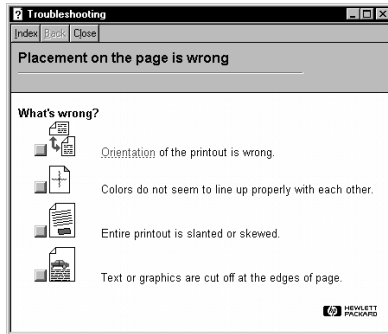

## 5 Explore the possibilities.

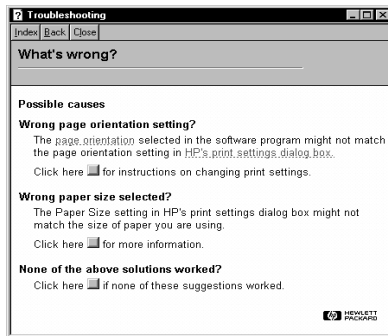

**Note:** See your *User's Guide* for an overview of common problems.

# HP Customer Support



## HP Customer Support Online

Click your way to a quick solution! A great place to go for answers to questions about HP products is HP Customer Support Online at [http://www.hp.com/support/home\\_products](http://www.hp.com/support/home_products). You'll get instant access to everything from helpful printing tips to the latest product and software updates—24 hours a day, seven days a week.

## Printer software

Printer software (also referred to as a printer driver) allows your printer to talk with your computer. HP provides printer software and software upgrades for Windows 3.1x, Windows 95, Windows 98, and Windows NT 4.0. For MS-DOS printer software, contact the manufacturer of your software program.

You have several options for getting printer software:

- Download the printer software by accessing HP Customer Support Online, CompuServe, or America Online.

- If you do not have a CD drive, you can copy the printer software to floppy disks by taking your printer software CD to your HP dealer or a friend that has a CD drive. Be sure to take along at least 6 blank diskettes. To create the floppy disks, insert the printer software CD and select *Make diskettes of your printer software* when the opening screen appears and follow the instructions on the screen.
- If you are in the U.S., and do not have a CD drive, you can order the software on 3.5 inch disks by calling (661) 257-5565.
- If you are in the U. S. and need software, you can order it by calling (661) 257-5565. Software upgrades are available for a nominal fee.
- If you are outside the U.S. and cannot download the driver from HP Customer Online, call your nearest HP Customer Support Center.



### HP Customer Support User Forums

They're friendly. They're informative. Check out our online community user forums. Simply review existing messages left by other HP users to find the answers you're looking for. You can also post your questions, then check back later for ideas and suggestions from knowledgeable users and system operators. Access the user forums directly from [http://www.hp.com/support/home\\_products](http://www.hp.com/support/home_products).



### HP Customer Support by Fax

When you want the facts—and you want them fast—call HP FIRST, our automated faxback service. Dial (800) 333-1917 (U.S. only) from any touch-tone phone, listen to your choices, then select the support document that matches your specific need. You may request up to three documents per call, and we'll fax them to you right away. HP FIRST is a free service, so call anytime—24 hours a day, seven days a week.



### HP Customer Support Repair

If your printer is ever in need of repair, simply call the HP Customer Support Center. A trained service technician will diagnose the problem and coordinate the repair process for you. This service is free of charge during the printer's standard warranty period. Beyond the warranty period, repairs are charged on a time and materials basis.



## HP Customer Support by Phone

### HP Customer Support Technical Assistance

To speak with someone for online technical assistance, call one of the following numbers.

• Africa/Middle East	41 22/780 41 11	• Hungary	36 (1) 252 4505
• Argentina	541781-4061/69	• India	91 11 682 60 35
• Australia	61 3 92728000	• Indonesia	6221 350 3408
• Austria	43 (0)660 6386	• Ireland	353 (0) 1662 5525
• Belgium (Dutch)	32 (0)2 62688 06	• Israel	972-9-9524848
• Belgium (French)	32 (0)2 6268807	• Italy	39 (0)2 264 10350
• Brazil	55 11 709-1444	• Japan, Tokyo	81 3 3335-8333
• Canada	(877) 621-4722 (Toll free)	• Japan, Osaka	81 6 838 1155
• China	86 10 6505 3888-5959	• Korea	82 2 3270 0700
• Czech Republic	42 (2) 471 7321	• Malaysia	03 2952566
• Denmark	45 (0)39 294099	• Mexico D.F.	326 46 00
• Finland	358 (9) 2034 7288	• Mexico, Guadalajara	669 95 00
• France	33 (0) 143623434	• Mexico, Monterey	378 42 40
• Germany	49 (0) 180 5258 143	• Middle East/Africa	41 22/780 41 11
• Greece	30 1 689 64 11	• Netherlands	31 (0)20 606 8751
• Hong Kong	(800) 96 7729	• New Zealand	(09) 356-6640
		• Norway	47 (0)22 116299
		• Philippines	65 272 5300
		• Poland	48 22 37 50 65
		• Portugal	351 (0) 144 17 199
		• Russia	7095 923 50 01
		• Singapore	65 272 5300
		• Spain	34 (9) 02321 123
		• Sweden	46 (0)8 6192170
		• Switzerland	41 (0)84 8801111
		• Taiwan	886 2-2717-0055



- Thailand (66-2) 661 4011
- Turkey 90 1 224 59 25
- United Kingdom 44 (0) 171 512 5202
- U.S. (900) 555-1500
- Venezuela 58 2 239 5664

Before placing a call for help, please make sure that:

- You have checked your setup poster and online troubleshooting for installation troubleshooting tips.
- You are seated in front of your computer with your printer nearby.
- You have the following information available:
  - The printer's serial number (the label is on the back of the printer).
  - The printer's model number (the label is on the front of the printer).
  - The model of the computer.
  - The version of the printer driver and software program (if applicable).

## After the warranty

- You can still get help from HP for a fee. Prices are subject to change without notice. (Online help is always available for free!)
- For quick questions in the United States only, call (900) 555-1500. The charges are \$2.50 per minute and begin when you connect with a support technician.
- For calls from Canada, or for calls in the U.S. that you anticipate might be longer than ten minutes in length, call (800) 999-1148. The fee is US \$25 per call, charged to your Visa or MasterCard.
- If during your phone call, it is determined that your printer requires repair, and you are within your printer's hardware warranty period, HP will pay for your phone charges.

## Extended Warranty Options

If you would like to extend your printer coverage beyond the factory warranty period, you have the following options.

- Consult your HP dealer to get extended coverage.
- If your HP dealer does not offer service contracts, please call Hewlett-Packard directly and ask about our service agreement offering. In the U.S. call (800) 446-0522; in Canada call (800) 268-1221. For service agreements outside the U.S. and Canada, contact your local HP Sales Office.

## A note about letters

If you need technical help from a technical support person, we recommend that you call us while you're in front of your computer and printer, rather than writing a letter to us. That way we can help you with your questions immediately!

# Appendices

Until now, we've been talking about the what, where, and how of your printer. If you're ready for some simple facts about the printer and printer supplies, here they are.

## Print Cartridges

To get the best performance from your printer, Hewlett-Packard recommends using only genuine HP supplies in HP inkjet printers, including only HP print and photo cartridges.

To maintain excellent print quality from your print cartridges:

- Keep print cartridges in their sealed packages, at room temperature (60° – 78° F or 15.6° – 26.6° C), until you are ready to use them.
- Turn off the printer and allow the print cartridges to return to the right side of the printer for proper capping of the nozzles before unplugging the power module or turning off any attached power strip.
- To keep the ink from drying out, store extra cartridges in HP storage containers as shown below. HP storage containers are available for purchase. (See page 45 for ordering information.)

Black Print Cartridge

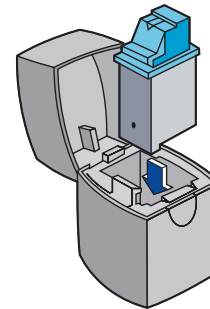
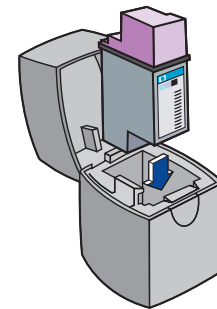

Photo Cartridge



If you store your extra print cartridge in a container other than an HP storage container, remember these things:

- use an airtight container
- do not re-tape the nozzle
- do not let anything touch the nozzle
- store the print cartridge nozzle up

Refilling an HP cartridge pushes the electronic and mechanical components of the cartridge past their normal life cycle, creating many potential problems, such as the following:

### Poor print quality

- Non-HP ink can contain components that cause nozzles to become clogged, resulting in streaked copy and graying or fuzzy characters.
- Non-HP inks can contain components that corrode the cartridge's electrical components, resulting in poor printouts.

### Potential damage

- If ink from a refilled cartridge leaks, the excess ink might damage the service station that caps the cartridge while it is in the printer but not in use. Because this service station maintains the health of the cartridge, quality problems might occur with this cartridge.
- If ink from a refilled cartridge leaks onto the electrical components in your printer, severe printer damage can occur, causing downtime and repair costs.

#### Caution

*Damage resulting from the modification or refilling of HP cartridges is specifically excluded from the coverage of HP printer warranties.*

*Note: When buying replacement print cartridges, check the part numbers carefully so that you buy the right cartridges for your printer:*



Black  
HP C6614A  
Series



Tri-Color  
HP 51649  
Series



Photo Cartridge  
HP C1816  
Series



## Cleaning the print cartridges

Cleaning your print cartridges can improve the quality of printing.

If your printed page is missing lines or dots, perform Procedure 1 below. If your printed page contains streaked ink, perform Procedure 2.

### Procedure 1: Correcting missing lines or dots

Clean the print cartridges when you notice that the lines or dots are missing from your printed text and graphics, as shown in the left margin. The print cartridges can be cleaned from the HP Toolbox.

**Note:** Do not clean the print cartridges unnecessarily, as this wastes ink and shortens the life of the print cartridge.

### To clean the print cartridges from the HP Toolbox:

- 1 Double-click the HP Toolbox icon on the computer screen.
- 2 Click the *Printer Services* tab.

**Note:** MS-DOS users can clean print cartridges from the HP DeskJet Control Panel for MS-DOS.

- 3 Click *Clean the print cartridges* and follow the directions on the screen.

If the preceding procedure does not improve the print quality, your print cartridges might be low on ink. Replace the print cartridges.

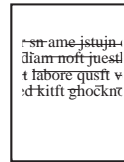

### Procedure 2: Eliminating ink streaks

Customers using HP DeskJet printers in dusty environments might occasionally experience ink streaks or smearing because of a small accumulation of debris inside the printer. This debris can include dust, hair, carpet, or clothing fibers. Ink streaking is easily prevented or corrected by doing scheduled cleaning to three areas of the printer: the print cartridges, the print cartridge cradle, and the service station. HP recommends that you perform this cleaning every 3 months.

## Materials you will need

Before you begin, make sure you have the following materials available:

- Cotton swabs or any soft material that will not come apart or leave fibers (for example, a piece of clean cotton cloth).
- Distilled, filtered, or bottled water (tap water might contain contaminants that can damage the print cartridges).
- Scrap paper or paper towels to set the print cartridges on while you are working.

### Caution

*Be careful not to get ink on your hands or clothing.*

## Steps to clean your printer

- 1 Remove the print cartridges
  - a. Turn the printer **on** and lift the printer's top cover.  
The print cartridges move to the center of the printer.
  - b. After the print cartridges have moved to the center of the printer, **unplug** the black power cord from the back of the printer.
  - c. Remove the print cartridges and place them on their sides on a scrap piece of paper.

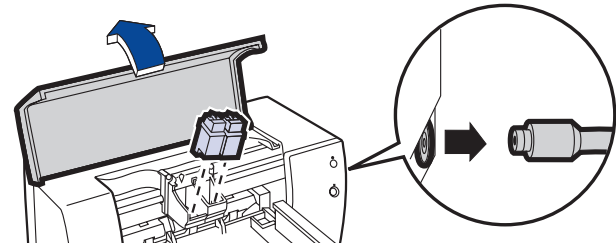

### Caution

*Once you've removed the print cartridges, make sure that they are not outside of the printer for more than 15 minutes.*

### Warning

*Keep new and used print cartridges out of the reach of children.*

## 2 Clean the print cartridges

- Dip a clean cotton swab into distilled water and **squeeze** any excess water from the swab.
- Grasp the black print cartridge by the colored cap.
- Clean the **face** and **edges** of the print cartridge as shown. **DO NOT** wipe the nozzle plate.

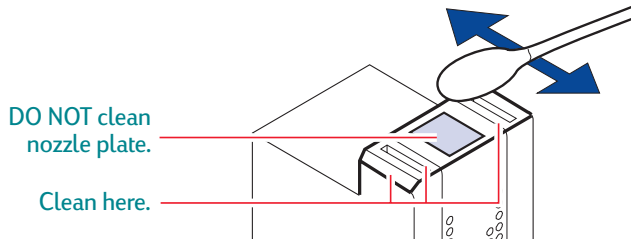

- Hold the print cartridge up to the light to inspect for fibers on the face and edges. If fibers are still present, repeat steps 2a through 2c.
- Repeat steps 2a through 2d with the tri-color print cartridge using a clean, moistened cotton swab to avoid any contamination.

## 3 Clean the print cartridge cradle

- Position yourself at eye level with the printer.
- Locate the cradle that holds the print cartridges, then locate the three black, hook-shaped arms on the bottom of the cradle.
- Using clean, moistened swabs, wipe the **flat surfaces** (shaded area) on the undersides of each arm from back to front. Repeat until no ink residue is seen on a clean swab.

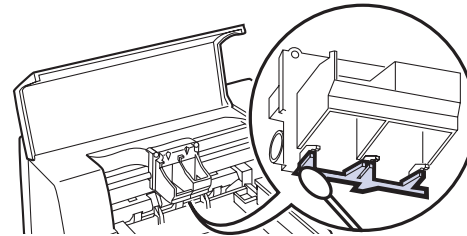

#### 4 Clean the service station

- a. Using a clean, moistened swab, clean the **rim** of the sponge holder.
- b. Remove any built-up ink and fibers from the top of the sponge. If the sponge is higher than the rim, use the cotton swab to push it below the rim.
- c. Using a clean, moistened swab, clean **wiper 1** and the top surface of **cap 1**.

#### Caution

*Use light force when cleaning the print cartridge caps. Heavy force might unseat the caps, eventually causing damage to the print cartridges.*

- d. Using a clean, moistened swab, clean **wiper 2** and the top surface of **cap 2**.

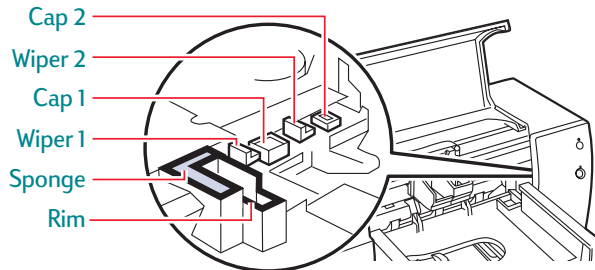

#### 5 Reinstall the print cartridges

- a. Reinstall the print cartridges and close the printer's top cover.
- b. Reinsert the power cord into the back of the printer.
- c. Print a test page. On the *Printer Services* tab of the HP Toolbox, click *Print a test page*.
- d. Examine the printout for ink streaking.

**Note:** *This procedure should remove all fibers that would cause ink to streak on a printout. However, fibers can be missed. If the printout still shows streaking, repeat the procedure until the test printout is clear and sharp. HP recommends that you perform this procedure every 3 months. This procedure and additional maintenance tips are located on the HP Customer Support Web site at: <http://www.deskjet-support.com/maintenance>.*



# Aligning the print cartridges

To ensure that you get the best print quality, align the print cartridges for the final step in setting up your printer. Also, be sure to align the cartridges whenever you install a new cartridge.

1 Be sure the printer's IN tray contains plain paper.

Don't waste your photo or glossy paper by using them to align the cartridges.

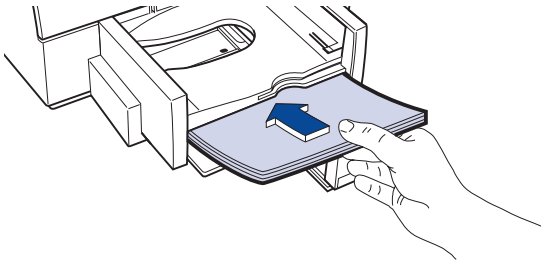

2 Double-click the HP Toolbox icon on the computer screen.



3 Select the Printer Services tab, and then click Align the print cartridges. Follow the directions on the screen.

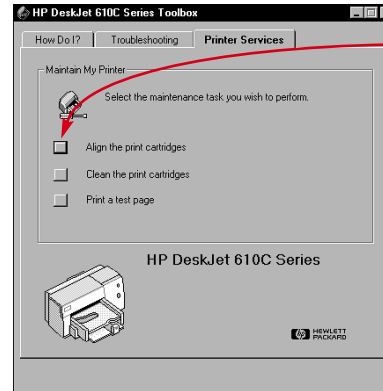

Click here to align the print cartridges.

# Minimum printing margins

The printer cannot print outside a certain area of the page, so you must make sure the contents of your document fall within the printable area—that is, within the top, bottom, left, and right margins available for the specific size paper on which you are printing.

Paper Size	Left and Right Margins	Bottom Margin
U.S. Letter 8.5 x 11 in	0.25 in	0.59 in
U.S. legal 8.5 x 14 in	0.25 in	0.59 in
A4 size 210 x 297 mm	3.4 mm	14.9 mm
A5 size 148 x 210 mm	3.2 mm	21.2 mm
B5 size 182 x 257 mm	4.2 mm	21.2 mm
Executive 7.25 x 10.5 in	0.25 in	0.59 in
U.S. cards 4 x 6 in	0.125 in	0.84 in
U.S. cards 5 x 8 in	0.125 in	0.84 in
A6 cards 105 x 148 mm	3.2 mm	21.2 mm
Hagaki postcards 100 x 148 mm	4.2 mm	21.2 mm

*Note: The top margin is 0.04 inches (1 mm) for all paper sizes.*

Envelope Size	Left Margins	Right Margin
U.S. No. 10 4.12 x 9.5 in	0.84 in	0.04 in
DL 110 x 220 mm	21 mm	1 mm
C6 114 x 162 mm	3.4 mm	1 mm
Invitation A2 4.38 x 5.75 in	0.84 in	0.04 in

*Note: The top and bottom margins are 0.125 inches (3.2 mm) for all envelope sizes.*

*Note: MS-DOS margins can vary. See the manual for the specific MS-DOS program for more information.*

# Ordering supplies and accessories

For ordering information, see page 45.

Parts/Supplies/Accessories	HP Reorder Number
<b>Print Cartridges and Accessories *</b>	
Black print cartridge	C6614A Series
Tri-Color print cartridge	51649 Series
Photo cartridge	C1816 Series
U.S. HP Photo Color Kit	C4585
Asian HP Photo Color Kit	C4583
European HP Photo Color Kit	C4584
Latin American HP Photo Color Kit	C4590
Storage container	C4562-60018
* <i>When you buy replacement cartridges, check the part numbers carefully so that you buy the right one.</i>	
<b>HP IEEE-1284-compliant Parallel Interface Cable</b> (with one 1284-A connector for the computer port and one 1284-B connector for the printer port)	
2-meter length	C2950A
3-meter length	C2951A
<b>Power Adapter (worldwide)</b>	0950-3490
<b>Power Cords (to be used with worldwide Power Adapter)</b>	
U.S., Canada, Brazil, Latin America, Saudi Arabia	8120-8330
Japan	8120-8336
U.K., Singapore, Malaysia, Middle East, Hong Kong	8120-8341
South Africa	8120-8347
India	8120-8345
Australia, Argentina	8120-8337
China, Taiwan, Philippines	8120-8346
Korea	8120-8339
Europe, Jordan, Lebanon, North Africa, Israel, Russia Baltic countries, Thailand, Indonesia, Caribbean, Latin America	8120-8340

## Power Modules

U.S., Canada, Mexico 120 V/60 Hz	9100-5124 (C2175A)
Korea, 220 V/60 Hz	9100-5126 (C2182A)
Australia, 240 V/50 Hz	9100-5127 (C2181A)
South Africa, 220 V/50 Hz	9100-5128 (C2180A)
China, Argentina, 220 V/50 Hz	9100-5129 (C2179A)
Japan, 100 V/50/60 Hz	9100-5130 (C2178A)
U.K., 240 V/50 Hz	9100-5131 (C2177A)
Europe (except U.K.), 230 V/50 Hz	9100-5132 (C2176A)

## User's Guides

Most HP printer documentation is available for viewing and printing at

[http://www.hp.com/support/home\\_products](http://www.hp.com/support/home_products)

Czech	C6450-90004
Danish	C6450-90003
Dutch	C6450-90003
English	Request number when ordering
Finnish	C6450-90003
French	Request number when ordering
German	C6450-90003
Greek	C6450-90004
Hebrew	C6450-90004
Hungarian	C6450-90004
Italian	C6450-90003
Korean	C6450-90006
Norwegian	C6450-90003
Polish	C6450-90004
Portuguese	Request number when ordering
Russian	C6450-90004
Simplified Chinese	C6450-90008
Spanish	Request number when ordering
Swedish	C6450-90003
Traditional Chinese	C6450-90007
Turkish	C6450-90004

<b>Parts/Supplies/Accessories</b>	<b>HP Reorder Number</b>
<b>Access Door (Top Cover) Assembly</b>	<b>C5884-60018</b>
<b>Base Foot Assembly (4 ea.)</b>	<b>C2162-60098</b>
<b>Paper Tray Assembly</b>	<b>C5884-60016</b>
<b>Paper Media **</b>	
<i>HP Premium Inkjet Heavyweight Paper</i>	
European A4, 100 sheets	C1853A
<i>HP Professional Brochure and Flyer Paper</i>	
U.S. letter, 50 sheets	C6955A
<i>HP Premium Inkjet Transparency Film</i>	
U.S. letter, 50 transparencies	C3834A
U.S. letter, 20 transparencies	C3828A
European A4, 50 transparencies	C3835A
European A4, 20 transparencies	C3832A
<i>HP Premium Inkjet Paper</i>	
U.S. letter, 200 sheets	51634Y
European A4, 200 sheets	51634Z
<i>HP Premium Inkjet Rapid-Dry Transparencies</i>	
U.S. letter, 50 transparencies	C6051A
European A4, 50 transparencies	C6053A
<i>HP Greeting Card Paper (Prescored for quarter-fold)</i>	
U.S. letter: 20 sheets, 20 envelopes	C1812A
European A4: 20 sheets, 20 envelopes	C6042A
<i>HP Glossy Greeting Card Paper (Prescored for half-fold)</i>	
U.S. letter: 10 sheets, 10 envelopes	C6044A
European A4: 10 sheets, 10 envelopes	C6045A
Asian A4: 10 sheets, 10 envelopes	C6768A

<i>HP Premium Photo Paper</i>	
U.S. letter, 15 sheets	C6039A
European A4, 15 sheets	C6040A
Asian A4, 15 sheets	C6043A
<i>HP Photo Paper</i>	
U.S. letter, 20 sheets	C1846A
European A4, 20 sheets	C1847A
Asian A4, 20 sheets	C6765A
<i>HP Bright White Inkjet Paper</i>	
U.S. letter, 500 sheets	C1824A
U.S. letter, 200 sheets	C5976A
European A4, 500 sheets	C1825A
European A4, 200 sheets	C5977A
<i>Transfer Media</i>	
<i>HP Iron-On T-Shirt Transfers</i>	
U.S. letter, 10 sheets	C6049A
European A4, 10 sheets	C6050A
Asian A4, 10 sheets	C6065A

\*\* Availability of special media varies by country.

## Ordering information

To order printer supplies or accessories, call your nearest HP dealer or call HP DIRECT at the following numbers for fast shipping service:

- **Argentina:** (54 1) 787-7100  
Fax: (54 1) 787-7213  
Hewlett-Packard Argentina, Montañeses 2150  
1428 Buenos Aires, Argentina
- **Australia/New Zealand:** (03) 895-2895  
China Resources Bldg.  
26 Harbour Road  
Wanchai, Hong Kong
- **Austria-South-East Area:**  
(43-0222) 25 000, ext. 755  
Fax: (43-0222) 25 000, ext. 610  
Hewlett-Packard Ges.m.b.H.  
Ersatzteilverkauf  
Lieblg. 1  
A-1222 Wien
- **Belgium:** 02/778 3092 (or 3090, 3091)  
Fax: 02/778 3076  
Hewlett-Packard Belgium SA/NV  
100 bd. de la Woluwe/Woluwedal  
1200 BRUXELLES
- **Brazil:** 55-11-7296-4991  
Fax: 55-11-7296-4967  
Edisa Hewlett-Packard SA, R. Aruana 125,  
Tambore, Barueri, São Paulo, Brazil, 06460-010
- **Canada:** (800) 387-3154, (905) 206-4725  
Fax: (905) 206-3485/-3739  
Hewlett-Packard (Canada) Ltd.,  
5150 Spectrum Way  
Mississauga, Ontario L4W 5G1
- **Toronto:** (416) 671-8383
- **Chile:** (56 2) 203-3233  
Fax: (56 2) 203-3234  
Hewlett-Packard de Chile SA  
Av. Andres Bello 2777, Oficina 1302  
Los Condes, Santiago, Chile
- **Denmark:** 45 99 14 29  
Fax: 42 81 58 10  
Hewlett-Packard A/S  
Kongevejen 25, 3460 BIRKEROD
- **Finland:** (90) 8872 2397  
Fax: (90) 8872 2620  
Hewlett-Packard Oy  
Varaosamynti, Piispankalliontie 17  
02200 ESPOO
- **France:** (1) 40 85 71 12  
Fax: (1) 47 98 26 08  
EuroParts, 77 101 avenue du Vieux Chemin de  
Saint-Denis  
92625 GENNEVILLIERS
- **Germany:** 07031-145444  
Fax: 07031-141395  
Hewlett-Packard GmbH, HP Express Support  
Ersatzteil-Verkauf, Herrenberger Str. 130  
71034 BÖBLINGEN
- **International Sales Branch:** (41) 22 780 4111  
Fax: (41) 22 780-4770  
Hewlett-Packard S. A., ISB  
319, rue de Veyrot  
1217 MEYRIN 1, GENEVE - SUISSE
- **Italy:** 02/9212.2336/2475  
Fax: 02/92101757  
Hewlett-Packard Italiana S. P. A.  
Ufficio Parti di ricambio  
Via G. Di Vittorio, 9  
20063 Cernusco s/N (MI)
- **Japan:** (03) 3335-8333  
Hewlett-Packard Japan Ltd.  
29-21 Takaido-Higashi 3-chome, sugniami-ku  
Tokyo 168-8585
- **Latin America Headquarters:** (305) 267-4220  
Fax: (305) 267-4247  
5200 Blue Lagoon Drive, Suite 950  
Miami, FL 33126
- **Mexico:** (52 5) 258-4600  
Fax: (54 1) 258-4362  
Hewlett-Packard de México, S.A. de C.V  
Prolongación Reforma #700  
Colonia Lomas de Santa Fe, C.P. 01210 México,  
D.F.
- **Netherlands:** 0 33 450 1808  
Fax: 0 33 456 0891  
Hewlett-Packard Nederland B. V., Parts Direct  
Service  
Basicweg 10  
3821 BR AMERSFOORT

- **Norway:** 22735926  
Fax: 22735611  
Hewlett-Packard Norge A/S, Express Support  
Drammensveien 169-171  
0212 Oslo
- **Spain:** 1 6 31 14 81  
Fax: 1 6 31 12 74  
Hewlett-Packard Espanola S.A.  
Departamento de Venta de Piezas  
Ctra N-VI, Km. 16,500  
28230 LAS ROZAS, Madrid
- **Sweden:** 8-4442239  
Fax: 8-4442116  
Hewlett-Packard Sverige AB  
Skalholtskatan 9, Box 19  
164 93 KISTA
- **Switzerland:** 056/279 286  
Fax: 056/279 280  
Elbatex Datentechnik AG  
Schwimmbadstrasse 45, 5430 WETTINGEN
- **United Kingdom:**  
+44 1765 690061, Fax: +44 1765 690731  
Express Terminals, 47 Allhallowgate  
Ripon, North Yorkshire
- +44 181 568 7100, Fax: +44 181 568 7044  
Parts First, Riverside Works  
Isleworth, Middlesex, TW7 7BY
- +44 1734 521587, Fax: +44 1734 521712  
Westcoast, 28-30 Richfield Avenue  
Reading, Berkshire, RG1 8BJ

- **United States:** (800) 227-8164
- **Venezuela:** (58 2) 239-4244/4133  
Fax: (58 2) 207-8014  
Hewlett-Packard de Venezuela C.A.  
Tercera Transversal de Los Ruices Norte, Edificio  
Segre, Caracas 1071, Venezuela  
Apartado Postal 50933, Caracas 1050

#### **Elsewhere in the world**

- **Hewlett-Packard Company**  
Intercontinental Headquarters  
3495 Deer Creek Road  
Palo Alto, CA 94304, U.S.A.

## Uninstalling the printer software

If you need to uninstall the printer driver for your HP DeskJet printer for any reason, perform **one** of the steps listed for your operating system. If something unexpected happened during installation, it is safest to run the uninstall utility directly from the CD or disks rather than from the uninstall program that was placed on your hard drive.

### For Windows 3.1x, do *one* of the following:

- In *Program Manager*, locate your HP DeskJet Series group. Double-click the Uninstall icon to uninstall your printer software.

#### OR

- Insert the CD into your computer and run Setup.exe. Select *Remove HP DeskJet 610C Series software*.

### For Windows 95, Windows 98, and Windows NT 4.0 do *one* of the following:

- From the *Start* menu, click *Programs*, click *HP DeskJet 610C Series*, and then click *HP DeskJet 610C Series Uninstall*.

#### OR

- From the *Start* menu, click *Settings*, click *Control Panel*, and then click *Add/Remove Programs*. Select *HP DeskJet 610C Series (Remove only)*.

#### OR

- Insert the CD into your computer and run Setup.exe. Select *Remove HP DeskJet 610C Series software*.

# Environmental Attributes of the DeskJet Printer

## Environmental Statement

Hewlett-Packard continuously improves the design and production processes of HP DeskJet printers to minimize the negative impact on the office environment and on the communities where printers are manufactured, shipped, and used. Hewlett-Packard has also developed processes to minimize the negative impact of the disposal of the printers at the end of printing life.

## Reduction and Elimination

**Ozone:** All ozone-depleting chemicals (CFC, for example) have been eliminated from Hewlett-Packard manufacturing processes.

**Number of Parts:** Early in design, the total number of parts used by the printer is reduced when possible to minimize costs during manufacturing and to reduce handling at end-of-life.

**Printer Packaging:** Packaging materials, cushions, accessories and boxes have been reduced, saving roughly 50% in fuel and, therefore, fuel emissions.

## Recycling

Design for recycling has been incorporated into this printer. The number of materials has been kept to a minimum, and dissimilar materials have been designed to separate easily. Fasteners and connectors are easy to locate, access, and remove using common tools. High priority parts have been designed to be accessed quickly for efficient disassembly and repair. Plastics parts have been primarily designed in no more than two colors to enhance recycling options.

**Plastic Materials:** All major manufactured plastics parts are marked as to the plastic content to facilitate product recycling.

**Printer and Print Cartridges:** In certain countries, Hewlett-Packard is conducting pilot programs to take back printers and print cartridges for material reclamation and environmentally sound disposal. Call your Hewlett-Packard representative for current status.

**Printers:** Hewlett-Packard accepts used and obsolete printers for component recycling. Call your Hewlett-Packard sales office for instructions.

**Paper:** This printer is designed to facilitate the use of recycled paper as consumer media. Depending on the availability of recycled paper in each country, all manuals are printed on recycled paper.

## Energy Conservation

This printer was designed with energy conservation in mind. This printer uses less than 5 watts in stand-by mode. As an ENERGY STAR partner, Hewlett-Packard has determined that this product meets the ENERGY STAR guidelines for energy efficiency.

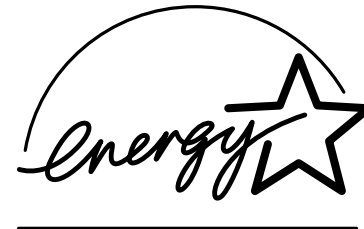

**Off-mode Energy Consumption:** When the printer is in off-mode, a minimal amount of energy is still being consumed. Turning off the printer and then disconnecting the printer power cord from the electrical source can prevent energy consumption.