

# HP DeskJet 1125C

*Professional Series*

## Getting Started Guide

*Read ME  
First!*

## Acknowledgements

Microsoft is a U.S. registered trademark of Microsoft Corporation.

Windows is a trademark of Microsoft Corporation.

Novell and Netware are registered trademarks of Novell Corporation.

## Notice

The information contained in this document is subject to change without notice.

Hewlett-Packard makes no warranty of any kind with respect to this material, including, but not limited to, the implied warranties of merchantability and fitness for a particular purpose.

Hewlett-Packard shall not be liable for errors contained herein or for incidental or consequential damages in connection with the furnishing, performance, or use of this material.

No part of this document may be photocopied, reproduced, or translated to another language without the prior written consent of Hewlett-Packard Company.

# Contents

<b>Section ①</b>	<b>Introduction</b>	
	• Using this Guide	2
	• Accessing Information	2
<b>Section ②</b>	<b>USB</b>	
	• USB Installation	3
	• USB Uninstallation	4
<b>Section ③</b>	<b>Macintosh</b>	
	• Setting Up Your Printer on a Macintosh Computer	5
<b>Section ④</b>	<b>Windows 2000</b>	
	• Setting Up Your Printer in Windows 2000	5
	• Sharing Your Printer in Windows 2000	6
	• Connecting to an External Print Server	7
<b>Section ⑤</b>	<b>More Information</b>	
	• Bi-Directional Communication	8
	• Customer Support	8
	• Language Abbreviations	9

## Using this Guide

Welcome to the *HP DeskJet 1125C Getting Started Guide*. The HP DeskJet 1125C is the latest printer in the HP DeskJet 1120C series of color printers. Read this guide for new information on your HP DeskJet 1125C printer. For printer setup, printing basics and troubleshooting, refer to the *HP DeskJet 1120C User's Guide*.

This guide contains the following sections:

- **USB**—Describes how to connect the USB cable to your printer, and how to install and uninstall the USB port connection (Windows 98 and Windows 2000 only).
- **Macintosh**—Describes how to install the printer software on a Macintosh computer.
- **Windows 2000**—Describes how to install and uninstall the printer software, and how to use your printer on a network in Windows 2000.
- **More Information**—Shows how to enable bi-directional communication in your printer, and how to access HP Customer Support by telephone and through the World Wide Web, and language abbreviations.

*Note: All information in the HP DeskJet 1120C User's Guide applies to the HP DeskJet 1125C printer unless otherwise noted in this guide.*

## Accessing Information

If the following resources are not sufficient to help maintain your printer and solve printing problems, you can obtain assistance from the HP Customer Care Center (see "More Information" on page 8).

- |   |   |
|---|---|
| <b><i>Getting Started Guide</i></b>     | The first place to look for new information on your HP DeskJet 1125C printer.   |
| <b><i>User's Guide</i></b>              | Includes information on printer setup, selecting and using paper, printing using special features, replacing print cartridges, troubleshooting, and ordering HP supplies.<br><br><i>Note: The Print Kit, installation floppy disks, HP Premium InkJet Rapid-Dry Transparencies, and C1823G color print cartridge are no longer available.</i> |
| <b><i>Toolbox</i></b>                   | Provides "how-to" and troubleshooting instructions, as well as access to printer maintenance functions and HP information.  |
| <b><i>Starter CD (Windows; Mac)</i></b> | Includes the Windows and Macintosh printer software on separate CDs, and an electronic copy of the user documentation.  |
| <b><i>Web Site</i></b>                  | <a href="http://www.hp.com/go/dj1125">http://www.hp.com/go/dj1125</a> or <a href="http://www.hp.com">http://www.hp.com</a> provides a link to the HP web site for the latest printer software, operating system, product, and support information.  |

## USB Installation

Use the USB cable only if your computer is running Windows 98 or Windows 2000 and has a USB port. If your computer is not properly configured to use USB, use a parallel cable to connect your computer to the printer.

To connect the parallel cable to your printer, locate the slider on the back of the printer, move it to the right so that it covers the USB port, and connect the parallel cable to the printer's parallel port.

*Note: The slider on the back of the printer allows you to choose either a parallel cable or USB cable connection.*

### Windows 98

- 1 Turn on the printer and insert the Windows Starter CD into your CD-ROM drive. Do *not* click the **Printer Driver** icon. Proceed to step 2.
- 2 a On the back of the printer, locate the slider covering the USB port.

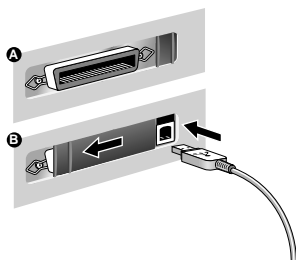

- b Move the slider to the left so that it covers the parallel port. Connect the USB cable (purchased separately; part number C6518A) from your computer to the printer's USB port. If the computer is properly configured to use USB, Windows will detect the printer.
- 3 The **Add New Hardware Wizard** dialog box appears.
  - a Click **Next** until you are asked to specify a location for the software.
  - b Click **Browse**, and double-click the CD icon (typically the D: drive).
  - c Select the `\driver\win\<language>\win98usb` directory in the Windows Starter CD and click **OK**. See page 9 for a list of the 3-character language codes for `<language>`.
  - d Click **Next** to see the subsequent dialog boxes and then click **Finish**.
  - e Click **Back** if the driver could not be located and repeat steps 3a to 3d.
- 4 When the new driver is successfully installed, the **HP DeskJet Setup Wizard** screen appears.
- 5 Follow the instructions on the screen to complete installation of the printer software.

## Windows 2000

- 1 Turn on the printer and insert the Windows Starter CD into your CD-ROM drive. Do *not* click the **Printer Driver** icon. Proceed to step 2.
- 2
  - a On the back of the printer, locate the slider covering the USB port.
  - b Move the slider to the left so that it covers the parallel port. Connect the USB cable (purchased separately; part number C6518A) from your computer to the printer's USB port. If the computer is properly configured to use USB, Windows will detect the printer.
- 3 The **Found New Hardware Wizard** dialog box appears.
  - a Click **Next** until you are asked to specify a location for the software.
  - b Click **Browse** and select the .INF file from the `\driver\winnt\<language>\disk1` directory in the Windows Starter CD. See page 9 for a list of the 3-character language codes for `<language>`.
  - c Click **OK** followed by **Finish** to install the driver.

## USB Uninstallation

### Windows 98

Use the **Uninstaller** program from the HP DeskJet 1125C Program Group to uninstall the USB port connection and the printer software.

To uninstall the USB port connection only:

- 1 Run the UNINST.EXE program from the `\driver\win\<language>\win98usb` directory in the Windows Starter CD.
- 2 Follow the instructions on the screen to complete uninstallation.

### Windows 2000

- 1 Make sure the USB cable is firmly attached to the printer and the PC.
- 2 Turn the printer off and then on again.
- 3 From the Control Panel, double-click **Add/Remove Hardware** and then click **Next**.
- 4 Choose **Uninstall/Unplug a device** and click **Next**.
- 5 Select **Uninstall a device** and click **Next**.
- 6 Scroll down the list of devices and double-click **USB Printing Support**.
- 7 Follow the instructions on the screen to uninstall the device.
- 8 From the Control Panel, double-click **Add/Remove Programs**.
- 9 Select **HP DeskJet 1125C Printer** and click **Change/Remove**.
- 10 Click **OK** to confirm uninstallation.

## Setting Up Your Printer on a Macintosh Computer

You can connect the printer to the latest models of Macintosh computers (Mac OS 8.1 or later) through the USB port. To connect older models without a USB port, you can either connect the Macintosh to a HP JetDirect print server (JetDirect 300x), or visit Apple's web site (<http://www.apple.com>) for USB solutions.

### Configuration Requirements

Before connecting your printer to the computer, ensure that your configuration meets these requirements:

- Your computer must support USB
- You need a USB-compliant interface cable
- Your computer must be running Mac OS 8.1 or later

### Installing the Printer Software

- 1 Connect the USB cable (purchased separately; part number C6518A). For instructions on how to connect the USB cable to your printer, see step 2 of "USB Installation" on page 3.
- 2 Insert the Macintosh Starter CD into your CD-ROM drive. Double-click the **Installer** icon.
- 3 Follow the instructions on the screen to complete the installation.
- 4 Select **Chooser** from the **Apple** menu.
- 5 Click the printer's icon from the left side of the **Chooser** window. Then, click **HP DeskJet 1125C** from the right side of the **Chooser** window. Close the **Chooser**.

## Setting Up Your Printer in Windows 2000

*Note: This section shows you how to set up your printer in Windows 2000 using a parallel cable connection. For USB connection in Windows 2000, see "USB Installation" on page 4.*

*Information pertaining to Windows NT 4.0 in the HP DeskJet 1120C User's Guide and on-line help applies to Windows 2000 unless stated otherwise below.*

### Configuration Requirements

Before installing the printer software in Windows 2000, ensure your computer has at least 64 MB of RAM available.

### Installing the Printer Software

- 1 Start Microsoft Windows and ensure that no other application is running.
- 2 Insert the Windows Starter CD into the CD-ROM drive. The installation program runs automatically.
- 3 Select the **Printer Driver** option on the CD menu to install your printer software.

If the installation program does not run automatically:

- 1 Select **Start** and then **Run**.
- 2 At the Command line box, type the letter of your computer's CD-ROM drive, followed by **:\INSTALL** (for example, D:\INSTALL).
- 3 Follow the instructions on the screen to complete the installation.

## Uninstalling the Printer Software

### Uninstalling from the HP DeskJet 1125C Program Group

- 1 Select **Start** and then **Programs**.
- 2 Click the **HP DeskJet 1125C Printer** program group, and then run the **Uninstaller** program.
- 3 Click **OK** to confirm uninstallation.

### Uninstalling from the Control Panel

- 1 Select **Start**, and then **Settings**, followed by **Control Panel**.
- 2 Double-click **Add/Remove Programs**.
- 3 Select **HP DeskJet 1125C Printer** and click **Change/Remove**.
- 4 Click **OK** to confirm uninstallation.

## *Sharing Your Printer in Windows 2000*

You can share your printer in a network environment using the Windows printer sharing method, or by connecting it directly to the network via an optional HP JetDirect external print server.

### At the Server:

- I. If the server is running Novell Netware 3.12, 4.11 or 5.0:  
Refer to the Novell installation manual to set up the printer and establish the cable connections to your network.
- II. If the server is running Windows NT 4.0/2000:
  - 1 Set up the printer and establish the cable connections to your network.
  - 2 Install the printer software from the Windows Starter CD. See "Installing the Printer Software" on page 5.
  - 3 Select **HP DeskJet 1125C Printer** in the **Printers** folder and right-click **Properties**.
  - 4 On the **Sharing** tab, click **Shared as** and then type a name for the shared printer.
  - 5 On the **Ports** tab, click **Add Port**.



## At the Client:

- I. If both the client and server are running Windows NT 4.0/2000:

Use the “Point-and-Print” method to install the printer software. Drag the printer icon from the Printers folder on the print server and drop it into the client’s Printers folder. The printer software will be automatically installed.
- II. If the client is running Windows NT 4.0/2000 and the server is running another operating system:
  - 1 Install the printer software from the Windows Starter CD.
  - 2 When installing, select the **HP DeskJet 1125C Printer** and any LPT port.
  - 3 Go to the **Printers** folder, right-click your printer icon and select **Properties**.
  - 4 On the **Ports** tab, click **Add Port**, highlight **Local Port**, and then select **New Port**. Type in the name of the printer server followed by the shared name of the printer, such as \\printserver\_name\share\_name.

## Connecting to an External Print Server

If you have already installed the printer software and you want to connect to a JetDirect port in Windows 2000:

- 1 Insert the HP JetDirect CD-ROM (available with purchase of the HP JetDirect print server) into your CD-ROM drive. If the installation program does not run automatically, launch Explorer and locate the file.
- 2 Select the option to install the JetAdmin software (version 3.0 or later) and follow the instructions on the screen.

*Note: If you encounter a setup error (Error 401) during installation, click **OK** to proceed with the installation. The error does not affect the performance of the JetAdmin software.*
- 3 After completing the JetAdmin installation, restart your computer.
- 4 Go to the **Printers** folder, right-click **HP DeskJet 1125C Printer** and select **Properties**.
- 5 Select the **Ports** tab, and click **Add Port**. Select a new JetDirect port and assign it to the printer.
- 6 Click **OK**.

## Bi-Directional Communication

Bi-directional communication allows the printer driver to obtain more information regarding the printer's state. For the HP DeskJet 1125C printer, bi-directional communication is disabled by default. To assess the feasibility of enabling bi-directional communication in your printer, see the **Readme** file in the Toolbox.

### Accessing Readme from the HP DeskJet 1125C Program Group

- 1 Select **Start** and then **Programs**.
- 2 Click the **HP DeskJet 1125C Printer** program group and select **DJ1125C Toolbox**.
- 3 Click the **Readme** button.

## Customer Support

### Internet

Visit our World Wide Web for the latest printer software, product, operating system, and support information:  
<http://www.hp.com/go/dj1125> or <http://www.hp.com/cposupport>

### HP Telephone Support

During the warranty period, you may obtain assistance from the HP Customer Care Center.

North America:

During Warranty: US: 208 323 2551 Monday through Friday 6 am to 6 pm (MST)  
Canada: 905 206 4663 Monday through Friday 8 am to 8 pm (EST)

Post Warranty: US: 900 555 1500 (\$2.50 per minute, maximum of \$25.00) or 800 999 1148 (\$25.00 per call will be charged to your Visa or MasterCard) Monday through Friday 7 am to 6 pm (MST)  
Canada: Toll free 877 621 4722 (Visa, MasterCard, or American Express) Monday through Friday 8 am to 8 pm (EST)

Outside of North America:

Africa/Middle East	+41 22/780 71 11	Czech Republic	42 (2) 471 7327
Argentina	541 781 4061/69	Denmark	3929 4099
Australia	613 8877 8000	Finland	0203 47 288
Austria	0660 6386	France	01 43 62 34 34
Belgium (Dutch)	02 6268806	Germany	0180 52 58 143
Belgium (French)	02 6268807	Greece	01 68 96 4 11
Brazil	55 11 709 1444	Hong Kong	800 96 7729
Chile	800 360 999	Hungary	36 (1) 252 4505
China	010 6564 5959	India	9111 682 6035

Indonesia	21 350 3408	Singapore	272 5300
Ireland	01 662 5525	Spain	902 321 123
Italy	02 264 10350	Sweden	08 619 2170
Korea	822 3270 0700	Switzerland	0848 80 11 11
Malaysia	03 295 2566	Taiwan	886 2 27170055
Mexico D.F.	01 800 2214700, 01 800 9052900	Thailand	02 661 4011
New Zealand	09 356 6640	The Netherlands	020 606 8751
Philippines	2 867 3551	Turkey	90 1 224 59 25
Poland	022 37 5065, 48 22 37 5065	United Kingdom	0171 512 5202
Portugal	01 441 7 199	Vietnam	8 823 4530
Russia	7095 923 50 01	Venezuela	582 239 5664

## *Language Abbreviations*

Chinese (Simplified)	CHS
Chinese (Traditional)	CHT
Czech	CZE
Danish	DAN
Dutch	DUT
English (US, UK)	ENU
Finnish	FIN
French (Euro)	FRE
German	GER
Italian	ITA
Japanese	JAP
Korean	KOR
Norwegian	NOR
Polish	POL
Portuguese (Euro)	POR
Russian	RUS
Spanish (Euro)	SPA
Swedish	SWE

**DECLARATION OF CONFORMITY**  
**according to ISO / IEC Guide 22 and EN 45014**

---

**Manufacturer's name:** Hewlett-Packard Singapore (Pte) Ltd

**Manufacturer's address:** Consumer Business, Asia Operations  
20 Gul Way, Singapore 629196

*declares, that the product*

**Product Name:** HP DeskJet 1125C

**Product Number:** C8099A

**Product Options:** All

*conforms to the following Product Specifications:*

**Safety:** IEC 60950: 1991+A1+A2+A3+A4 / EN 60950: 1992+A1+A2+A3+A4+A11  
IEC 60825-1: 1993 + A1 / EN 60825-1: 1994 + A11 Class I for LEDs

**EMC:** CISPR 22: 1997 Class B / EN 55022: 1998 Class B  
CISPR 24: 1997 / EN 55024: 1998  
IEC 61000-3-2: 1995 / EN 61000-3-2: 1995  
IEC 61000-3-3: 1994 / EN 61000-3-3: 1995

FCC Title 47 CFR, Part 15 Class B / VCCI-2  
AZ / NZS 3548: 1995 / ICES-003, Issue 2

**Supplementary Information:**

- (1) The product herewith complies with the requirements of the Low Voltage Directive 73/23/EEC and the EMC Directive 89/336/EEC, and carries the CE marking accordingly.
- (2) The product was tested in a typical configuration with Hewlett Packard personal computer systems.
- (3) This device complies with FCC Regulation (FCC Title 47 CFR, Part 15). Operation is subject to the following two conditions: (i) this device may not cause harmful interference, and (ii) this device must accept any interference received, including interference that may cause undesired operation.

Singapore, February 2000

Chan Kum Yew, Quality Manager

Australia Contact: Product Regulations Manager, Hewlett Packard Australia Ltd, 31-41 Joseph Street, Blackburn, Victoria 3130, Australia.

European Contact: Your Local Hewlett-Packard Sales and Service Office or Hewlett-Packard GmbH, Department HQ-TRE / Standards Europe, Herrenberger Strasse 130, D-71034 Boblingen (FAX: +49-7031-14-3143).

USA Contact: Corporate Product Regulations Manager, Hewlett Packard Company, 3000 Hanover Street, Palo Alto, CA 94304, USA (Phone: 415-857-1501).



© Copyright 2000  
Hewlett-Packard Company

Printed in Thailand  
Manual Part No. C8099-90009

<http://www.hp.com/go/dj1125>



C8099-90009

# HP DeskJet 1120C

*Professional Series*

## User's Guide

*HP DeskJet 1125C Users: Read the HP DeskJet 1125C Getting Started Guide first.*



**Acknowledgements**

*HP ColorSmart II, HP PhotoREt II and HP ZoomSmart Scaling Technology are trademarks of Hewlett-Packard Company.*

*Microsoft is a U.S. registered trademark of Microsoft Corporation.*

*Windows is a trademark of Microsoft Corporation.*

**Notice**

*The information contained in this document is subject to change without notice.*

*Hewlett-Packard makes no warranty of any kind with regard to this material, including, but not limited to, the implied warranties of merchantability and fitness for a particular purpose.*

*Hewlett-Packard shall not be liable for errors contained herein or for incidental or consequential damages in connection with the furnishing, performance, or use of this material.*

*No part of this document may be photocopied, reproduced, or translated to another language without the prior written consent of Hewlett-Packard Company.*



<b>Section ①</b>	<b>Getting Started</b>	
	• Understanding the Printer's Parts and Functions	2
	• Setting Up	4
	• Accessing Information	7
<b>Section ②</b>	<b>Printing Basics</b>	
	• Loading Paper	8
	• Replacing and Maintaining Print Cartridges	10
	• Getting to Know Your Printer Software	11
	• Changing Print Settings	12
	• Printing with Special Features	13
	• Using Your Printer on a Network	15
	• Printing from DOS Software Programs	17
<b>Section ③</b>	<b>Support</b>	
	• Troubleshooting	18
	• Customer Support	21
	• HP Supplies	23
<b>Section ④</b>	<b>Specifications</b>	
	• Printer Specifications	25
	• Regulatory Notice	26
	• Hewlett-Packard Warranty Statement	27

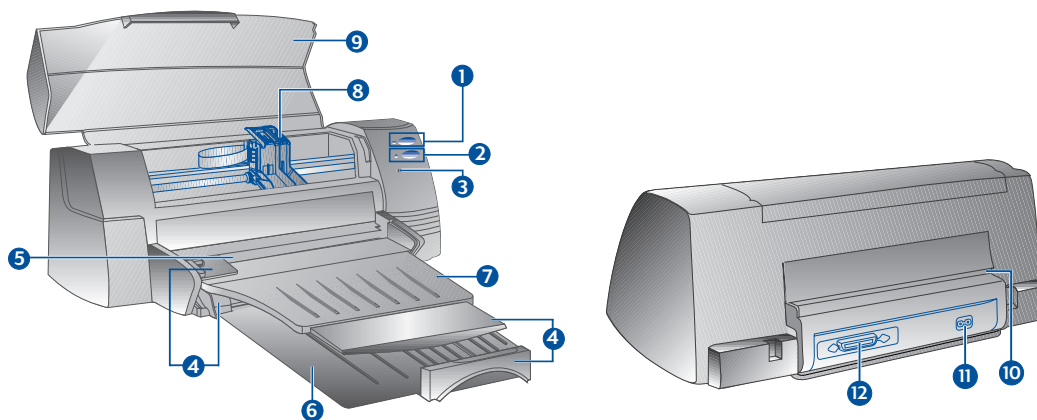

## Understanding the Printer's Parts and Functions



### Printer Parts

- |    |  |                             |
|----|--|-----------------------------|
| 1  |   | Power Button and Indicator  |
| 2  |   | Resume Button and Indicator |
| 3  |  | Cartridge Indicator         |
| 4  |  | Paper Length/Width Adjuster |
| 5  |  | Alternative Top Media Feed  |
| 6  |  | Main Bottom Media Tray      |
| 7  |  | Output Tray                 |
| 8  |  | Print Cartridge Latches     |
| 9  |  | Printer Cover               |
| 10 |  | Rear Media Feed             |
| 11 |  | Power Socket                |
| 12 |  | Parallel Port               |

### Functions

- |    |  |
|----|--|
| 1  | Turns the printer on and off. See the following section on "Printer Lights".                 |
| 2  | Indicates that user intervention is required. See the following section on "Printer Lights". |
| 3  | Indicates print cartridges need user attention.  |
| 4  | Holds paper in place.  |
| 5  | Holds up to 10 sheets of paper.  |
| 6  | Holds the stack of commonly used paper. Holds up to 150 sheets of paper.                     |
| 7  | Receives paper as it comes out of the printer. Holds up to 50 sheets of printed paper.       |
| 8  | Secure the print cartridges.   |
| 9  | Keeps dust particles from the printer parts.   |
| 10 | For feeding thick paper requiring straight paper path.                                       |
| 11 | For connecting to a power source.  |
| 12 | For sending and receiving data to and from the computer.                                     |

## Printer Lights

The lights on the front panel of the printer indicate if the printer is on, in the process of receiving data, or in an error state.

<i>If the lights are...</i>	<i>Then...</i>
Power            Off Resume         Off Cartridge      Off	The printer is off. Press the Power button to turn on the printer.
Power            On Resume         Off Cartridge      Off	The printer is ready to print. You can send a document to the printer.
Power            Blinking Resume         Off Cartridge      Off	The printer is receiving data from the computer or is printing. Wait for the document to print.
Power            Blinking Resume         Blinking Cartridge      Off	There is either a paper jam or the movement of the print cartridge cradle is obstructed.
Power            Blinking Resume         Blinking Cartridge      Blinking	The printer is in error state. Turn the printer off and then on. If the three lights remain blinking, call your nearest Customer Support center, see page 21.
Power            On Resume         Off Cartridge      Blinking	This indicates one or more of the following: <ul style="list-style-type: none"> <li>• the top cover is open;</li> <li>• a print cartridge is missing or not functioning properly.</li> </ul>
Power            On Resume         Blinking Cartridge      Off	This indicates one or more of the following: <ul style="list-style-type: none"> <li>• the printer is out of paper;</li> <li>• the printer is waiting for the ink on special media (transparencies) to dry, before printing the next page;</li> <li>• user intervention required to load or feed paper by following the instructions on the computer screen before pressing the Resume button to continue printing;</li> <li>• user intervention required to feed paper to the rear media feed.</li> </ul>

## Setting Up

### Step 1 - Unpack

- 1 Check that the following items are included with the printer:
  - *Power Cord*
  - *Black Print Cartridge*
  - *Color Print Cartridge*
  - *Printer Software*
  - *User's Guide*
  - *Output Tray*
  - *Starter CD*
  - *Print Kit*
- 2 Remove the packaging material and the four pieces of tape securing the printer (one at the back).
- 3 Open the top cover and remove the fifth piece of tape and white packing material from the inside of the printer.

### Step 2 - Install the Output Tray

- 1 Remove the output tray from its plastic cover.
- 2 Align the guides on the output tray with the grooves on the printer.
- 3 Push the tray in to lock the left side then the right side.
- 4 Lower the tray to its horizontal position.

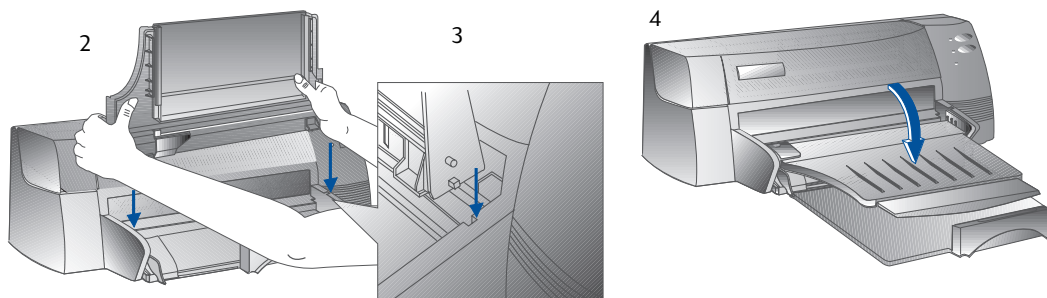

### Step 3 - Connect the Cables

Note: The cable that connects the printer to the computer is not supplied with the printer. You will need to purchase a parallel cable. HP recommends a high-quality IEEE-1284 compliant parallel printer cable (HP part number C2950A or C2951A).

- 1 Turn the computer off.
- 2 Connect one end of the printer cable to the parallel port on the back of the printer and snap both clips onto the notches of the connector.
- 3 Connect the other end of the printer cable to the parallel port on the back of the computer and tighten the screws on the connector.

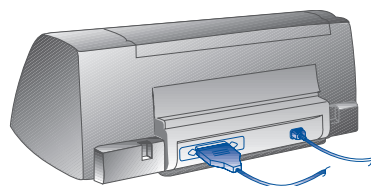

Note: Do not share the parallel port with a Zip drive or scanner.

- 4 Plug the power cord into the printer and then into a grounded outlet.

### Step 4 - Install the Print Cartridges

- 1 Press the Power button to turn on the printer.
- 2 Open the printer cover.  
The print cartridge cradles will move to the center of the printer.
- 3 Lift up the print cartridge latches.
- 4 Remove the color print cartridge from its package.
- 5 Gently remove the tape covering the ink nozzles.  
Be careful not to touch the ink nozzles or the gold-colored contacts.
- 6 Insert and push the print cartridge firmly down into the left cradle and snap the cartridge latch onto the print cartridge.
- 7 Repeat steps 4 to 6 to install the black cartridge into the right cradle.

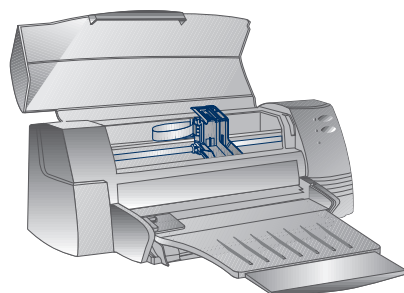

C1823D/C1823G/C1823T

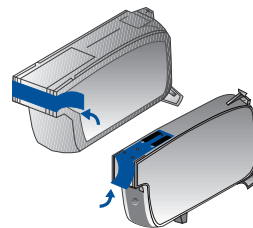

51645A/51645G

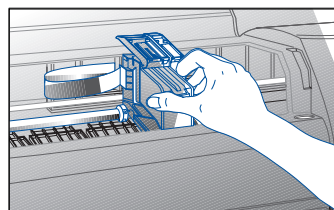

Note: Both print cartridges must be correctly installed for the printer to work.

- 8 Close the printer cover.

## Step 5 - Insert Paper

### Main Bottom Media Tray

- 1 Raise the output tray and extend the paper width and length adjusters to the maximum.
- 2 Insert up to 150 sheets of paper aligning the right edge of the paper stack against the right side of the In-Tray, print side down. Slide the paper in until it stops.
- 3 Slide the paper width and length adjusters in until they press lightly against the paper stack.
- 4 Lower the output tray to its horizontal position.

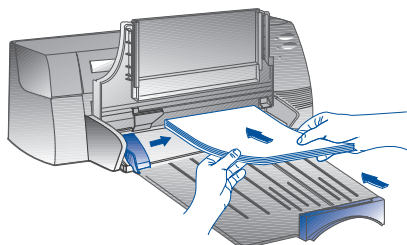
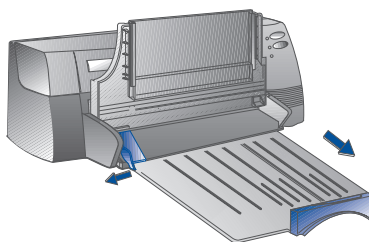

### Alternative Top Media Feed

- 1 Extend the alternative media feed and slide the paper width adjuster to the outermost position.
- 2 Insert up to a maximum of 10 sheets of paper along the right side of the alternative media feed, print side down, until it stops.
- 3 Slide the paper width adjuster in until it stops at the edges of the paper.

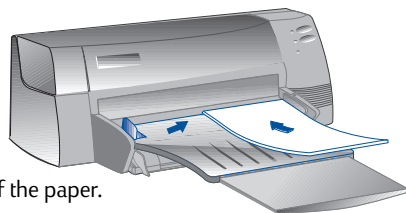

## Step 6 - Install the Printer Software

Before you can use the printer, you must install the printer software. To install the printer software, you need at least 8 MB of RAM and Microsoft Windows 3.1x/95/98 installed in your computer. To install the Windows NT 4.0 printer software, you need at least 24 MB of RAM and Microsoft Windows NT 4.0 installed in your computer. Please refer to page 25, "Hardware Compatibility" for hardware requirements.

*Note:* For Windows 95/98 users.

\* If you see this message, **New Hardware Found**, before or during installation, select **Do not install a driver (Windows will not prompt you again)** and click **OK**. Follow the instructions below to install the printer software.

\* If you see the **Update Device Driver Wizard** dialog, click **Next**. Subsequently, click **Finish**. Follow the instructions below to install the printer software.

### Installing from the Starter CD (Recommended)

*Note:* The Starter CD includes a utility to easily copy the HP DeskJet 1120C printer software to 3.5-inch, high-density diskettes. This allows you to use the diskettes to install the software on systems that do not have a CD-ROM drive. See the Printer Driver option in the Starter CD.

- 1 Start Microsoft Windows and make sure no other Windows applications are running.
- 2 Insert the Starter CD into your CD-ROM drive. The installation program will run automatically.
- 3 Click the **Printer Driver** option on the CD menu to install your printer software.  
If the installation program does not automatically run, follow the instructions below.

### Installing from Floppy Disks (or the Starter CD, if the install does not run automatically)

- 1 Start Microsoft Windows and make sure no other Windows applications are running.
- 2 Insert Disk 1 into your computer's floppy drive (or the CD into the CD-ROM drive).
- 3 Select **File, Run** in Windows 3.1 or select **Start, Run** in Windows 95/98/NT 4.0.
- 4 At the Command Line box,
  - for floppy disk installation, type the letter of your computer's floppy disk drive followed by `: \SETUP` (for example, `A:\SETUP`).
  - for CD installation, type the letter of your computer's CD-ROM drive followed by `: \INSTALL` (for example, `D:\INSTALL`).
- 5 Follow the instructions that appear on the screen to complete installation.

## Step 7 - Align Cartridges and Printer Test

You should align the print cartridges whenever a new cartridge is installed. This ensures that black and color inks align when printed together on the same text, line, or graphic.

- 1 Run the HP DeskJet 1120C Toolbox software utility by double-clicking on the **DJ1120C Toolbox** icon on the desktop or in the program group.
- 2 Click the **Maintenance** tab, and select **Align Print Cartridges**. Follow the instructions on the computer screen.
- 3 Once you have aligned the cartridges, you may want to test the printer setup. To do so, select **Print a Self-Test** from the **Maintenance** tab of the HP DeskJet 1120C Toolbox.

## Accessing Information

<b>User's Guide</b>	includes information about using the printer software, selecting and using paper, printing using special features, replacing print cartridges, solving printer problems, ordering HP Supplies and accessing Customer Support.
<b>Toolbox</b>	provides "how-to" and troubleshooting instructions, as well as access to printer maintenance functions and HP information.
<b>Starter CD</b>	includes a quick tour of your printer, a diskette download utility for the printer software, videos on how to use your printer, print samples, an electronic copy of this user's guide, and ordering information.
<b>Print Kit</b>	includes software that you can use for creating projects to print using the HP DeskJet 1120C printer.
<b>Web Site</b>	<a href="http://www.hp.com/go/dj1120">http://www.hp.com/go/dj1120</a> or <a href="http://www.hp.com">http://www.hp.com</a> provides a link to the HP Web site for latest printer software, product and support information.

*Note: If the help suggestions provided in the user's guide, toolbox, and Starter CD are not sufficient to help you solve your printing problems, you may obtain assistance from the HP Customer Support Center. See page 21 for a list of resources available to you for the support and maintenance of your printer.*

## Loading Paper

Your printer supports paper sizes from 4"x6" (101.6x152.4 mm) to 13"x19" (331x485mm). Paper may be loaded using one of the ways described below.

### Main Bottom Media Tray

This is the default tray for loading commonly used paper. Holds up to 150 sheets of paper or 15 envelopes.

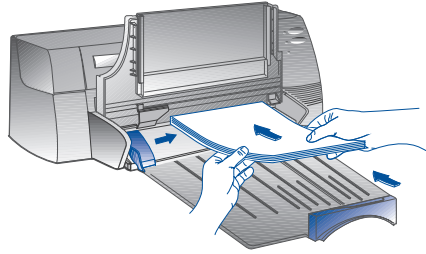

### Alternative Top Media Feed

Designed for occasional printing such as printing on transparencies, labels or envelopes. Holds up to 10 sheets of paper or 3 envelopes.

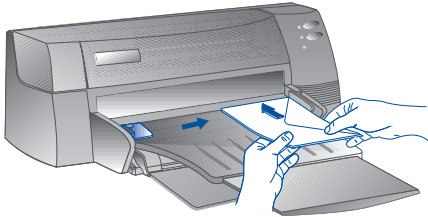

### Rear Media Feed

Provides a straight paper path for printing on thick paper (up to 0.3mm) such as cardboard. Holds 1 sheet of paper at any time.

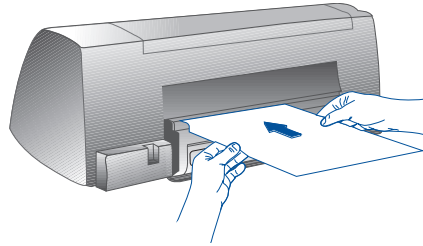

## Tips for Selecting Paper

- Always use paper that conforms with those listed under "Recommended Media Weight and Sizes", in the Printer Specifications section on page 25.
- Do not use media that is damaged, curled, or wrinkled. Do not use paper with cutouts or perforations or paper that is heavily textured or embossed.
- Do not use multiple-part forms.
- Load only one type of paper at a time into any of the trays.
- Always insert paper print side down, with the right edge of the paper aligned against the right edge of the tray.
- Do not load more than 150 sheets of paper or 15 envelopes into the main tray at one time. For the alternative tray, do not load more than 10 sheets of paper or 3 envelopes. The rear media feed only takes 1 sheet of paper at a time.

## To print using the main tray:

- 1 Raise the output tray and extend the paper width and length adjusters to the maximum.

- 2a Insert paper and align the right edge of the paper stack against the right side of the tray.

*Note: For printing on special media such as transparencies and envelopes, insert paper with the print side facing down.*

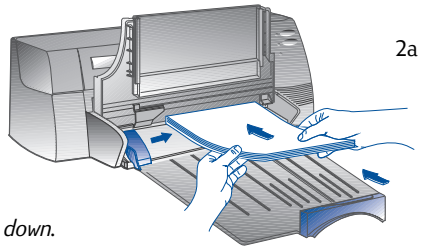

- 2b For printing on cards, extend the card adjuster and slide in until it presses lightly against the edge of the cards.

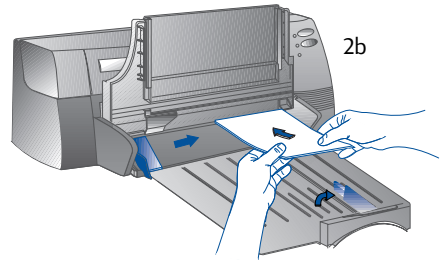

- 3 Slide the paper width and length adjusters in until they press lightly against the paper stack.

- 4 Lower the output tray to its horizontal position.

- 5 For printing on envelopes or cards, push the tabs near the paper output slot down until they lock in place. Remember to push the tabs back up into place once printing is complete.

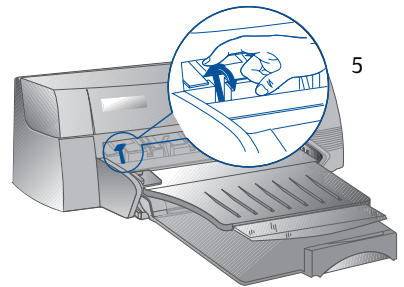

- 6 Adjust print settings in the HP DeskJet 1120C printer driver to match the paper type, size, and orientation. See "Changing Print Settings" on page 12.

*Note: For information on using the alternative tray, rear media feed, or printing on other types of media, see "Print on various paper types and sizes" on the "How Do I?" tab in the HP DeskJet 1120C Toolbox.*



# Replacing and Maintaining Print Cartridges

## Replacing the Print Cartridges

*Note:* Do not remove a print cartridge until you are ready to replace it. If one print cartridge is empty, the other will still print. However, the printer will not print unless both cartridges are in place.

Use only recommended print cartridges (HP part no. 51645A/51645G for black and HP part no. C1823D, C1823G or C1823T for color). Damage to the printer or the print cartridge resulting from modifying or refilling the print cartridge is not the responsibility of Hewlett-Packard.

- 1 Turn on the printer, and then open the top cover.  
The print cartridge cradles move to the center of the printer, and the Cartridge light flashes.
- 2 Lift up the print cartridge latch, grasp the top of the print cartridge, and pull it up and out of its cradle.
- 3 Remove the new print cartridge from its package and gently remove any tape covering the ink nozzles, being careful not to touch the ink nozzles or the gold-colored contacts.
- 4 Push the new cartridge down firmly into its cradle slot and close the print cartridge latch.
- 5 Close the printer's top cover.  
The cartridges return to their "home" position on the right side of the printer, and the Resume light stops flashing.

## Maintaining the Print Cartridges

### ■ *Aligning the print cartridges*

You should align the print cartridges whenever a new cartridge is installed. This insures that black and color inks will align when printed together on the same text, line, or graphic.

- 1 Turn on the computer and printer.
- 2 Run the HP DeskJet 1120C Toolbox by double-clicking the **DJ1120C Toolbox** icon on the desktop or in the program group.
- 3 Click the **Maintenance** tab.
- 4 Select **Align Print Cartridges**.
- 5 Follow the instructions on your computer screen to align the cartridges.

### ■ *Cleaning the print cartridges*

Clean the print cartridges when you notice lines or dots missing from printed text or graphics.

*Note:* Do not clean print cartridges unnecessarily, as this consumes ink and shortens the life of the print cartridges.

- 1 Run the HP DeskJet 1120C Toolbox by double-clicking the **DJ1120C Toolbox** icon on the desktop or in the program group.
- 2 Click the **Maintenance** tab.
- 3 Select **Clean Print Cartridges**.
- 4 Follow the instructions on your computer screen to clean the cartridges.

## Getting to Know Your Printer Software

This section provides an overview of the components and functions of your printer software.

### Printer Software Components

The HP DeskJet 1120C printer driver is equipped with special printing capabilities (see Printing with Special Features), and enhanced print time functions (see details below). In addition, the following software utilities are provided:

- **Toolbox** program provides access to all the information you need when using the printer.
- **Status Monitor** provides printer status information such as current print job and current print settings. It also allows you to cancel your print job.
- **Uninstaller** provides an easy and efficient means to remove the printer software, and the entries no longer required from the Window's registry.
- **Access HP Web Site** provides a link to HP web site for latest printer software, product and support information.
- **Registration Utility** allows you to register your printer through the Internet. Registration entitles you to receive prompt information about software upgrades, and future HP products.

You can access these functions in the printer's program group.

### Enhanced Print Time Functions

The HP DeskJet 1120C printer driver provides several functions that you can access in the user interface.



- **Print Preview.** The HP DeskJet 1120C printer driver has the ability to display a preview of your actual printout before printing. Application preview only shows you the printout based on the application's options. The HP DeskJet 1120C printer driver however will show you the actual output, that is, it shows you the combined effect of the application and printer settings that the printer will finally print. If what you see in the Print Preview is not what you want, then you cancel the print job. Remember to reselect your print settings before printing again.



- **Print Settings Confirmation.** The HP DeskJet 1120C printer driver provides you a quick means to change some common printing options such as print quality, number of copies, and paper type without having to change the settings in the printer driver. When you print, a popup dialog with the common printing options appears. You may change these options or click Print to continue.

*Note: By default, the enhanced print time functions are enabled. You can customise these functions in the Preference tab of the printer driver. See "Changing Print Settings" on page 12.*

# Changing Print Settings

## Select Your Printer

To use your HP DeskJet 1120C printer, make sure that it is selected as the default printer.

*To select your printer as the default printer - Windows 95 and Windows NT 4.0*

- 1 Click **Start**, select **Settings** followed by **Printers**.
- 2 Click the **HP DeskJet 1120C printer** icon to select it.
- 3 From the **File** menu, select **Set As Default**, then close the window.

*To select your printer as the default printer - Windows 3.1*

- 1 In the Program Manager, open the **Main** program group.
- 2 Double-click **Control Panel** to open it, then double-click **Printers**.
- 3 Select the **HP DeskJet 1120C printer** from the **Installed Printers** list, and then click **Set As Default Printer**.
- 4 Click **Close** and exit the Control Panel.

## Change Print Options

HP's Print Settings dialog box allows you to select settings such as paper type and print quality that are not provided by the software program.

You can change the print settings for the current document from your software program. This procedure will vary depending on the software program you are using.

- 1 Select either **Print**, **Print Setup** or **Printer Setup** from the **File** menu.
- 2 Click **Printer**, **Setup**, **Options** or **Properties** according to your software program.
  - 3a If you click **Printer** in step 2, you will need to click **Options**, then **Setup**.
  - 3b If you click **Setup**, you will either see the HP Print Settings right away, or you will need to click **Options**.
  - 3c If you click **Options**, you will need to click **Setup**.
  - 3d If you click **Properties**, you will see the HP Print Settings right away.
- 4 Change the settings under the Setup, Colour, Features, or Preference tabs in the HP print settings dialog box.

*Note:* Click the **Help** button at the bottom right-hand corner of each tab for explanations on the items found in each tabs.

## Printing with Special Features

The HP DeskJet 1120C printer driver allows you to create exciting and impactful documents easily. These features will help you to produce professional-looking documents like direct mailer, brochures, large spreadsheets, newsletter and extra large posters from your desktop.

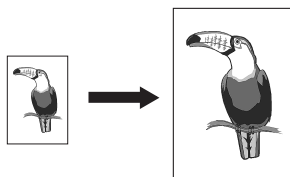

### HP ZoomSmart Scaling Technology

Allows you to enlarge or reduce a selected print job.

#### Usage

Prints your letter/A4-size document such as calendar and spreadsheet easily onto larger paper size without the need to reformat the original document in the software application.

#### Tips

You can also reduce your document by printing on smaller paper size. For example, you can print a C/A2-size document onto a letter/A4-size paper.

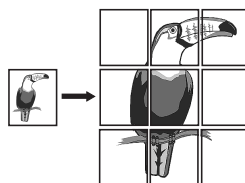

### Billboard

Allows you to enlarge your page and prints sections of that page onto several sheets of paper to form a large poster.

#### Usage

Prints your document up to five times its formatted page size and paste the printed pages together to form a poster.

#### Tips

If your document contains more than 1 page, only the first page or the current page of the document will be printed.

If you have a C/A2-size document, you may use this to print on 2 sheets of 11" x 17"/A3 paper. Or, if you have a 11" x 17"/A3 document, you may use this to print on 2 sheets of letter/A4-size paper.

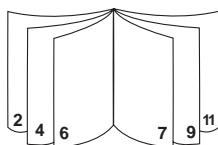

### Booklet

Enables you to print 2 pages onto a single larger sheet, and reorders the page sequencing so that the printouts can be folded in half to form a booklet.

#### Usage

Prints professional looking documents like newsletters and brochures.

#### Tips

It is advisable to set the document size before you begin working on your document. It is not recommended for you to create your document using custom-sized paper.

When creating your document, the left and right margin should be at least 0.5" (12.7mm). Otherwise, use the "Shrink to Fit" option in Booklet to "shrink" your document to fit within the margins.

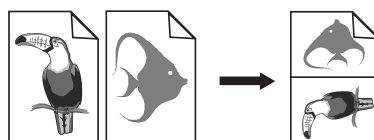

### Handouts

Enables you to print 2, 4 or 8 pages of your document onto one single sheet of paper.

#### Usage

Prints 2, 4, or 8 pages of your presentation materials onto a single sheet for distribution. Also useful for printing electronic mail.

#### Tips

Try printing on larger paper size to enhance readability.

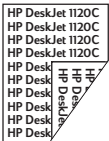

## 2-Sided Printing

Allows you to print on both sides of a page.

### Usage

Prints professional looking double-sided documents like newsletters, brochures and catalogues.

### Tips

If your document contains lots of graphics, use thick media such as HP Premium InkJet Heavyweight Paper for better results.

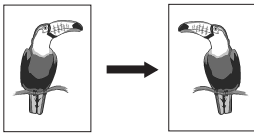

## Mirror Image

Allows you to print a laterally inverted image of your page.

### Usage

Prints your transparencies using this feature allows you to write on the top side of the transparencies which can be easily cleaned off later. Also useful for printing on T-shirt transfers.

### Tips

Most T-shirt printing applications, by default, print a mirror image of your document. Do not choose this feature again in the printer settings.

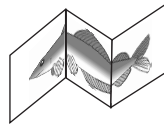

## Banner

Allows you to print on continuous feed.

### Usage

Prints party and exhibition banners easily.

### Tips

Use only HP Banner Paper and make sure you tear one sheet more than is required to print the banner.

When printing, stretch out the Banner paper (see diagram) and insert the first sheet into the alternative top media feed.

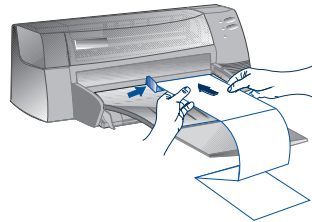

### Note:

- \* For more information on printing using these special features, see the topic "Print with Special Features" on the "How Do I?" tab in the HP DeskJet 1120C Toolbox.
- \* If your application supports such features, it is advisable for you to select the feature from your application.
- \* When the Resume light blinks while you are printing Booklet, 2-sided, or Banner, make sure you read the instructions on your computer screen before pressing the Resume button to continue printing.
- \* Use print Preview to verify the print-out before printing. For more information, refer to "Enhanced Print Time Functions" on page 11.

## Select a Special Feature

- 1 Click the **Features** tab in the print settings. See "Changing Print Settings" on page 12.
- 2 Select the required feature.  
The screen will display the various options available for the selected special feature.

*Note:* Click the **Help** button at the bottom right-hand corner of this tab for explanations descriptions of the various options.

- 3 Change the necessary print settings and proceed to print your document.

*Note:*

- For more information on printing using these special features, see the topic "Print with Special Features" on the "How Do I?" tab in the HP DeskJet 1120C Toolbox.

- To turn off special features selection and print in the normal (default) mode, i.e. printing on one-side of the paper without any of the special features, click **No features** in the **Features** tab.

## Using Your Printer on a Network

The HP DeskJet 1120C printer can be shared in a network environment by connecting it directly to a network via an optional HP JetDirect external print server. You may also share your printer using Windows printer sharing methods. Refer to the topic "Use the printer on a network" on the "How Do I?" tab in the HP DeskJet 1120C Toolbox.

If you are using JetDirect EX Plus, it is recommended that you upgrade your firmware to E.05.13. Check the website: <http://www.hp.com> for upgrade information.

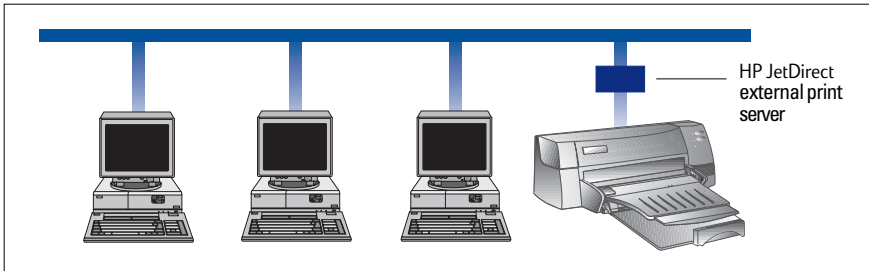

Before you install the printer software:

- Make sure that your computer and print server are configured properly in a network environment. For information about installation and setup of HP JetDirect print servers, refer to your HP JetDirect Hardware and Software Installation Guides.
- For Windows for Workgroup 3.11, Print Manager must be enabled. To enable this, double-click the Printers icon in the Control Panel and choose Use print manager.

### Installing Printer Software in Windows for Workgroup 3.11

#### ■ At the server:

- I. If the server is running Novell Netware 3.12 & 4.11, set up the printer and make the cable connections to your network.
- II. If the server is running Windows NT 4.0, ensure that your printer port is shared.
  - 1 Set up the printer and make the cable connections to your network.
  - 2 Install the printer software from the Starter CD or Installation Disk 1 (see page 6).
  - 3 Select the **HP DeskJet 1120C printer** in the **Printers** folder, right-click the mouse and select **Properties**.
  - 4 Go to the **Ports** tab, select **Add Port**, and configure the type of Port Monitor you wish to use for this shared printer, such as HP JetDirect Port.  
Be sure to set up this printer so that it is "shared".

### ■ *At the client:*

- 1 Install the printer software from the Starter CD or Installation Disk 1 (see page 6).
- 2 When prompted for the printer name and port, choose **"HP DeskJet 1120C Printer"** and either **"None"** or the Port (LPT1:) for the port that you wish to redirect the printer to. Click **OK**.
- 3 Continue installation until complete, then restart Windows.
- 4 Select **Printers** from the Windows Control Panel, click on the **HP DeskJet 1120C printer** icon, then click **Connect**.
- 5 Choose the port to which the printer is connected (for example LPT3).
- 6 Click **Network...** then select the network path for the printer. To set up the printer as a permanent network printer on your system, click the **Permanent** box, and then click **Connect**.

## Installing Printer Software in Windows 95/98/NT 4.0

### ■ *At the server:*

- I. If the server is running Novell Netware 3.12 & 4.11, set up the printer and make the cable connections to your network.
- II. If the server is running Windows NT 4.0, ensure that your printer port is shared.
  - 1 Set up the printer and make the cable connections to your network.
  - 2 Install the printer software from the Starter CD or Installation Disk 1 (see page 6).
  - 3 Select the **HP DeskJet 1120C printer** in the **Printers** folder, right click the mouse and select **Properties**.
  - 4 Go to the **Ports** tab, select **Add Port**, and configure the type of Port Monitor you wish to use for this shared printer, such as HP JetDirect Port.  
Be sure to set up this printer so that it is **"shared"**.

### ■ *At the client:*

*Note: If both the client and the server are running Windows NT 4.0, skip the following steps and use Network Printer Server in NT 4.0 (Point-and-Print) to install the printer software.*

- 1 Install the printer software from the Starter CD or Installation Disk 1 (see page 6).
- 2 Follow the instruction to complete the installation. Select the **HP DeskJet 1120C printer** and any LPT port when installing.
- 3 To access the Properties sheet of your printer, right-click on your printer icon in the **Printers** folder and select **Properties**.
- 4a Windows 95/98:  
Go to the **Details** tab, select **Add Port**, select **Local Port** and type the name of the server followed by the name of the printer, such as \\ComputerName\PrinterName.
- 4b Windows NT 4.0:  
Go to the **Ports** tab, select **Add Port**, highlight **Local Port**, select **New Port** and type the name of the server followed by the name of the printer, such as \\ComputerName\PrinterName.

*Note: If the server is running Windows NT 4.0, install the JetAdmin software which comes with the JetDirect products.*

## Printing from DOS Software Programs

When printing in DOS, there are two different ways you can adjust print settings: the HP DeskJet Control Panel for DOS and DOS printer drivers.

### HP DeskJet Control Panel for DOS

DOS users have access to many printer features through specific DOS printer drivers; however, many software manufacturers do not develop printer drivers for their software programs. Use the DeskJet Control Panel to specify the default printer setting for printing from your DOS program.

*Note:* HP DeskJet Control Panel does not support printing of special features.

### Installing the HP DeskJet Control Panel for DOS

Before you install the Control Panel, make sure you have setup your printer and that the printer is turned on.

- 1 Insert the Starter CD into the CD-ROM drive.
- 2 At the DOS prompt C:\>, type the CD-ROM drive letter and change the directory to \driver\win\disk4, e.g. D:\driver\win\disk4.
- 3 Type **INSTALL** and press **ENTER**.
- 4 Follow the instructions on your computer screen to complete installation.

*Note:* You can also install the HP DeskJet Control Panel from floppy disk 4.

### Using the HP DeskJet Control Panel for DOS

To open the DeskJet Control Panel, at the DOS prompt, change your directory to C:\HP1120C, type DJCP and press ENTER.

Use the Control Panel to select print settings that may not be available from some DOS programs. Duplicate print settings that are selected from a DOS software program may override print settings selected in the Control Panel. The Control Panel also allows you to clean and align the print cartridges for best print quality.

### DOS Printer Drivers

Printer drivers are supplied by the manufacturers of DOS software programs. The recommended printer driver to use is the HP DeskJet 1120. If that is not available use the HP DeskJet 870, 850 or 660.



## Troubleshooting

### ■ Nothing is printed

- **Be patient**  
Complex documents containing many fonts, graphics, and/or color photos take longer to begin printing. If the Power light is blinking, the printer is processing information.
- **Check the power**  
Make sure the power cord is connected firmly to the printer and to a working outlet, and that the printer is turned on. The Power light on the front panel of the printer should be lit.
- **Check the paper**  
Make sure paper is loaded correctly in the tray and that the paper is not jammed in the printer. See page 20 to clear a paper jam.
- **Check the print cartridges**  
Make sure that both the black and color print cartridges are properly installed and that the top cover of the printer is closed.
- **Try printing a "sample page"**  
Turn the printer off, then back on. Press the Resume button and release it when the Resume light starts to blink. If the sample page prints, then the problem is not with the printer.
- **Check the interface cable (Windows 3.1x/95/98 only)**  
Make sure that a high quality bi-directional interface cable (IEEE-1284 compliant) is connected properly to both the printer and the computer. To test the cable, click the Maintenance tab in the HP DeskJet 1120C Toolbox, and select "Run bi-directional cable test".
- **Check the printer setup**  
Make sure your HP DeskJet printer is selected as the current or default printer. See "Select Your Printer", page 12.
- **Check the network setup**  
Make sure that your printer is properly setup in network environment. See "Use the printer on a network" on the "How Do I?" tab in the HP DeskJet 1120C Toolbox and the documentation provided by your network vendors.

### ■ A blank page is printed

- **Check the print cartridges for tape**  
Make sure you remove the protective plastic tape that covers the ink nozzles.
- **Check for an empty print cartridge**  
If you are printing black text and a blank page is printed, your black print cartridge may be empty. Replace the black print cartridge.
- **Check the printer setup**  
Make sure your HP DeskJet 1120C printer is selected as the current or default printer.
- **Check the parallel port on your computer**  
Make sure your printer is connected directly to the parallel port. Do not share the port with other devices such as a Zip drive.

### ■ Placement of the text or graphics is wrong

- **The paper size or orientation settings may be incorrect**  
Make sure the paper size and page orientation selected in the software program match the settings in the HP print settings dialog box. See "Changing Print Settings" on the "How Do I?" tab in the HP DeskJet 1120C Toolbox.
- **The black and color print cartridges may need to be aligned**  
Print cartridges need to be aligned whenever one has been removed or replaced, or if the black ink and color ink do not seem to line up properly with each other on the page. See "Align print cartridges" on the "Maintenance" tab in the HP DeskJet 1120C Toolbox.
- **The paper may not be loaded correctly**  
If everything on the page is slanted or skewed, make sure the paper width and length adjusters fit snugly against the left and bottom edges of the paper stack, and that there are no more than 150 sheets of paper loaded in the main tray or 10 sheets of paper in the alternative tray.
- **The margin settings may be wrong**  
If the text or graphics are cut off at the edges of the page, make sure the margin settings for the document do not exceed the printable area of your printer. See "Printer Specifications", page 25.

## ■ Print quality is poor

- **The print quality setting may need to be changed**

While the EconoFast setting prints faster and uses less ink, it may cause text to appear faded or colors to appear dull. Select Normal or Best Print Quality in the HP print settings dialog box. See "Change print settings" on the "How Do I?" tab in the HP DeskJet 1120C Toolbox.

- **A print cartridge may be low on ink or clogged**

If print quality deteriorates, click the Maintenance tab in the HP DeskJet 1120C Toolbox, and select "Clean print cartridges". Follow the instructions on the screen. If print quality does not improve, a cartridge may be low on ink, and will need to be replaced.

- **The paper type setting may be incorrect**

When printing on transparencies or other special paper types, select the corresponding paper type in the HP print settings dialog box. See "Print on various paper types and sizes" on the "How Do I?" tab in the HP DeskJet 1120C Toolbox.

- **The paper may not be suitable for use with your HP DeskJet printer**

Paper that is too thin or has a slick surface may not feed properly. Paper that is heavily textured does not accept ink well. Use HP Premium Papers or test other paper types before purchasing in large quantities. See "Recommended Printable Weight" in the "Printer Specifications" section on page 25.

## ■ Something on the page is missing or incorrect

- **The margin settings may be wrong**

If the text or graphics are cut off at the edges of the page, make sure the margin settings for the document do not exceed the printable area of your printer.

- **Cable connection may be poor or cable may be bad (Windows 3.1x/95/98 only)**

If meaningless characters are printed, make sure you are using a bi-directional cable and that the cable is firmly connected to both your printer and computer. To test the cable, click the Maintenance tab in the HP DeskJet 1120C Toolbox, and select "Run bi-directional cable test".

- **ColorSmart II print settings may be wrong**

If colors are printed in shades of gray, **Print in Grayscale** is probably selected in the HP print settings dialog box. The **Automatic** ColorSmart selection will give the best color representation.

- **The wrong printer may be selected**

Make sure your HP DeskJet printer is selected as the current or default printer. See "Select Your Printer", page 12.

## ■ Printer takes a long time to print a job

- **Check your system configuration**

The minimum system configuration for your printer is 486-66MHz with 8MB RAM. However, the printer performance is optimized for Pentium machines.

- **There may be insufficient harddisk space in your system**

For printing on 11"x17"/A3 paper, it is recommended that you should have at least 50MB free harddisk space in your system. If you are printing graphics intensive files, make sure you have enough (>50MB) harddisk space.

- **There may be insufficient virtual memory in your system**

Increase the size of your system's virtual memory. See "Other Known Problems" in the Readme file.

- **The option to print line art and photo images is enabled**

If you are printing Best mode on HP Premium Photo Paper and have enabled the option to print line art and photo images, you need at least 200 MB free harddisk space in your system. Also, the printer will take a longer time to spool.

- **The port setting configuration in your system is not set to ECP (Windows 3.1x/95/98 only)**

Refer to the manual that comes with your computer for information on how to change your port setting or contact your computer manufacturer.

- **The printer cable is not a bi-directional cable (Windows 3.1x/95/98 only)**

Replace the printer cable with a IEEE-1284 printer cable.

- **A print cartridge may be low on ink**

Replace the low ink print cartridge.

## ■ Insufficient harddisk space or virtual memory to print

- **There is insufficient harddisk space in your system**

Cancel the print job and free up your harddisk space before printing again. Alternatively, try printing one page a time instead of printing the entire document.

- **There is insufficient virtual memory in your system**

Increase the size of your system's virtual memory. See "Other Known Problems" in the Readme file.

- **The option to print line art and photo images is enabled**

If you are printing Best mode on HP Premium Photo Paper and have enabled the option to print line art and photo images, you need at least 200 MB free harddisk space in your system. Also, the printer will take a longer time to spool.

## ■ Paper is Jammed in the Printer

### To clear a paper jam

- 1 Leave the printer on, open the printer cover and push the print cartridge cradle to the side.

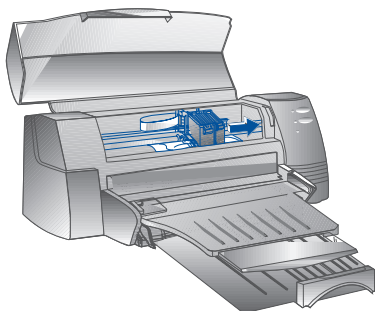

- 2 Free any wrinkled paper and press the Resume button until the printer ejects the entire sheet of paper. If this does not work, turn the printer off, then on again until the printer ejects the entire sheet of paper. If necessary, free any wrinkled paper and pull the sheet of paper towards you.

- 3 Close the printer cover.
- 4 Turn off the printer, and then turn it on.

### Tips for Avoiding Paper Jams

- Make sure nothing is blocking the paper path.
- Do not overload the alternative paper tray. The alternative paper tray holds up to 10 sheets of plain paper or other print material measuring the same thickness. The bottom main tray holds up to 150 sheets of plain paper.
- Load paper in the proper manner.
- Do not use paper that is curled or crumpled.
- Always use paper that conforms with those listed, in the Printer Specifications section on page 25.

## ■ Printing a Sample Page

Your printer will print without being connected to a computer. This allows you to see that your printer is set up, and is working properly by printing a sample page.

To print a sample page

- 1 Turn off the printer, and then turn it on again by pressing the Power button.
- 2 Press the Resume button and release it when the Resume light starts to blink. Your printer will print a sample page.

## ■ Printing a Diagnostic Page

To print a diagnostic page

- 1 Power on your printer.
- 2 Press and hold down the Power button and press the Resume button four times.
- 3 Release the Power button.

Your printer will print a diagnostic page. The information on the diagnostic page is useful to our customer support center in helping you troubleshoot your printer problem.

## Customer Support

The information in the previous chapter suggests solutions to common problems. If your printer is not operating properly and these suggestions do not solve your problem, try using one of the following support services to obtain assistance.

*Note: There are no user serviceable parts inside the printer.*

### HP DeskJet 1120C Toolbox

The "Troubleshooting" tab in this program provides an easy step-by-step solutions to common printing problems. You should be able to resolve most printing problems by stepping through the provided solutions. You can run this program by double-clicking the DJ1120C Toolbox icon on the desktop or in the program group.

### Internet

Visit our World Wide Web for the latest printer software, product and support information.

<http://www.hp.com/go/dj1120> or <http://www.hp.com>

### HP FIRST

HP FIRST is an automated information fax retrieval service which provides toll-free, 24-hour technical information to you by fax. Call HP FIRST at the following telephone numbers:

<i>United States and Canada</i>	<i>800 333 1917</i>
<i>United Kingdom</i>	<i>0800 96 02 71</i>
<i>For service in English outside UK</i>	<i>+31 20 681 5792</i>
<i>Australia</i>	<i>613 9272 2627</i>
<i>Austria</i>	<i>0660 8218</i>
<i>Belgium (Dutch)</i>	<i>0800 11906</i>
<i>Belgium (French)</i>	<i>0800 17043</i>
<i>China</i>	<i>86 10 6505 5280</i>
<i>Denmark</i>	<i>800 10453</i>
<i>Finland</i>	<i>800 13134</i>
<i>France</i>	<i>0800 905900</i>
<i>Germany</i>	<i>0130 810061</i>
<i>Hong Kong</i>	<i>2506 2422</i>
<i>India</i>	<i>9111 682 6031</i>
<i>Indonesia</i>	<i>21-352 2044</i>
<i>Italy</i>	<i>1678 59020</i>
<i>Korea</i>	<i>822 769 0543</i>
<i>Malaysia</i>	<i>03 298 2478</i>
<i>New Zealand</i>	<i>64 09 356 6642</i>
<i>Norway</i>	<i>800 11319</i>
<i>Philippines</i>	<i>(65) 275 7251</i>
<i>Portugal</i>	<i>05 05 313342</i>
<i>Singapore</i>	<i>275 7251</i>
<i>Spain</i>	<i>900 993123</i>
<i>Sweden</i>	<i>020 795743</i>
<i>Switzerland (French)</i>	<i>0800 551526</i>
<i>Switzerland (German)</i>	<i>0800 551 527</i>
<i>Thailand</i>	<i>662 661 3511</i>
<i>The Netherlands</i>	<i>0800 022 2420</i>

## HP Telephone Support

During the warranty period, you may obtain assistance from the HP Customer Support Center.

Before calling, please fill in the following information to be ready to help your Customer Support Center representative:

What is the serial number of your printer (check the back of your printer)? \_\_\_\_\_

What model printer do you have? **HP DeskJet 1120C**

What is the brand and model of your computer? \_\_\_\_\_

What is the version of printer software you are using (check the titlebar of the HP DeskJet 1120C Toolbox) and what driver have you selected? \_\_\_\_\_

Run the DJ1120C Toolbox software utility by double clicking on the icon in the program group in Windows 3.1x or on the desktop in Windows 95/98. Click the Maintenance tab, and select "Display system information". Have this information ready when you call the support lines.

The HP Customer Support Center can be reached at any of the following numbers:

<i>US and Canada</i>	208 323 2551
<i>Africa/Middle East</i>	+41 22/780 71 11
<i>Argentina</i>	541 781 4061/69
<i>Australia</i>	613 9272 8000
<i>Austria</i>	0660 6386
<i>Belgium (Dutch)</i>	02 6268806
<i>Belgium (French)</i>	02 6268807
<i>Brazil</i>	55 11 709 1444
<i>China</i>	86 10 6505 3888
<i>Czech Republic</i>	42 (2) 471 7321
<i>Denmark</i>	3929 4099
<i>Finland</i>	0203 47 288
<i>France</i>	01 43 62 34 34
<i>Germany</i>	0180 52 58 143
<i>Greece</i>	01 68 96 4 11
<i>Hong Kong</i>	800 96 7729
<i>Hungary</i>	36 (1) 252 4505
<i>India</i>	9111 682 6035
<i>Indonesia</i>	21 350 3408
<i>Ireland</i>	01 662 5525
<i>Italy</i>	02 264 10350
<i>Korea</i>	822 3270 0700
<i>Malaysia</i>	03 295 2566
<i>Mexico D.F.</i>	01 800 2214700, 01 800 9052900

<i>Mexico Guadalajara</i>	<i>(525) 264 2075</i>
<i>Mexico Monterey</i>	<i>91800 22147</i>
<i>New Zealand</i>	<i>09 356 6640</i>
<i>Norway</i>	<i>22 11 6299</i>
<i>Philippines</i>	<i>2 867 3551</i>
<i>Poland</i>	<i>48 22 37 5065</i>
<i>Portugal</i>	<i>01 441 7 199</i>
<i>Russia</i>	<i>7095 923 50 01</i>
<i>Singapore</i>	<i>272 5300</i>
<i>Spain</i>	<i>902 321 123</i>
<i>Sweden</i>	<i>08 619 2170</i>
<i>Switzerland</i>	<i>0848 80 11 11</i>
<i>Taiwan</i>	<i>886-2-27170055</i>
<i>Thailand</i>	<i>02 661 4011</i>
<i>The Netherlands</i>	<i>020 606 8751</i>
<i>Turkey</i>	<i>90 1 224 59 25</i>
<i>United Kingdom</i>	<i>0171 512 5202</i>
<i>Vietnam</i>	<i>8 823 4530</i>
<i>Venezuela</i>	<i>582 239 5664</i>

## HP Supplies

### HP Premium Transparency Film

<i>US Letter, 50 sheets: 8.5 x 11 in.</i>	<b>C3834A</b>
<i>US Letter, 20 sheets: 8.5 x 11 in.</i>	<b>C3828A</b>
<i>A4, 50 sheets: 210 x 297 mm</i>	<b>C3835A</b>
<i>A4, 20 sheets: 210 x 297 mm</i>	<b>C3832A</b>

### HP Premium Inkjet Rapid-Dry Transparencies

<i>US Letter, 50 sheets: 8.5 x 11 in.</i>	<b>C6051A</b>
<i>A4, 50 sheets: 210 x 297 mm</i>	<b>C6053A</b>

### HP Premium Inkjet Paper

<i>US Letter, 200 sheets: 8.5 x 11 in.</i>	<b>51634Y</b>
<i>US B-size, 100 sheets: 11 x 17 in.</i>	<b>C1855A</b>
<i>A4, 200 sheets: 210 x 297 mm</i>	<b>51634Z</b>
<i>A3, 100 sheets: 297 x 420 mm</i>	<b>C1856A</b>

### HP Premium Inkjet Heavyweight Paper

<i>US Letter, 100 sheets: 8.5 x 11 in.</i>	<b>C1852A</b>
<i>A4, 100 sheets: 210 x 297 mm</i>	<b>C1853A</b>

**HP Premium Photo Paper***US Letter, 15 sheets: 8.5 x 11 in.**US B-size, 20 sheets: 11 x 17 in.**A4 (European), 15 sheets: 210 x 297 mm**A4 (Asian), 15 sheets: 210 x 297 mm**A3, 20 sheets: 297 x 420 mm***C6039A****C6058A****C6040A****C6043A****C6059A****HP Bright White Paper***US Letter, 500 sheets: 8.5 x 11 in.**US Letter, 200 sheets: 8.5 x 11 in.**US B-size, 200 sheets: 11 x 17 in.**A4, 500 sheets: 210 x 297 mm**A4, 200 sheets: 210 x 297 mm**A3, 200 sheets: 297 x 420 mm***C1824A****C5976A****C1857A****C1825A****C5977A****C1858A****HP Banner Paper***US Letter, 100 sheets: 8.5 x 11 in.**A4, 100 sheets: 210 x 297 mm***C1820A****C1821A****HP Greeting Card Paper***US Letter, 20 sheets, 20 envelopes**A4, 20 sheets, 20 envelopes***C1812A****C6042A****HP Iron-on T-shirt Transfers***US Letter, 10 sheets: 8.5 x 11 in.**A4, 10 sheets: 210 x 297 mm***C6049A****C6050A****HP Labels***A4, 14/sheet, 100 sheets: 99 x 38 mm**A4, 16/sheet, 100 sheets: 99 x 34 mm**A4, 21/sheet, 100 sheets: 64 x 38 mm**A4, 10/sheet, 100 sheets: 100 x 51 mm**A4, 1/sheet, 100 sheets: 200 x 289 mm***92296L****92296M****92296N****92296P****92296R****Print Cartridge***Black**Large Black**Color***51645G (21cc)****51645A (42cc)****C1823D (30cc), C1823G (15cc) or C1823T (2 X 30cc)****Parallel Cable***HP IEEE-1284 Compliant Parallel Cable (2-metre)**HP IEEE-1284 Compliant Parallel Cable (3-metre)***C2950A****C2951A****HP JetDirect Print Server***HP JetDirect EX Plus**HP JetDirect 150X**HP JetDirect 300X***J2591A****J2592A****J3263A**

# Printer Specifications

## Print Method

Plain paper drop-on-demand thermal inkjet printing

## Print Speed

Up to 7.0 pages per minute for black printing

Up to 6.0 pages per minute for color printing

These are approximate figures. Exact speed will vary depending on the system configuration and software used.

## Resolution

Letter quality mode

600 x 600 dpi black

PhotoREt II color

*PhotoREt II technology is a HP proprietary technology that delivers high quality multi-level color image print quality by increasing the number of colors that can be printed on an individual dot (pixel). HP PhotoREt II makes use of a new ink cartridge (C1823D/C1823G/C1823T) which fires ink drops (10 picolitres) that are 70% smaller than previous HP DeskJet cartridges. HP PhotoREt II places up to sixteen drops of ink on a dot, and is able to produce 4 levels of shades per primary color by precisely controlling the amount of ink applied to each dot.*

*Contact your HP Customer Support Center for more information on PhotoREt II.*

## Draft quality mode

300 x 600 black

PhotoREt II color

## Printer Command Language

HP PCL Level 3 Enhanced

## Character Sets

*PC-8, PC8 Danish/Norwegian, PC-8 Turkish, PC-850, PC-852, HP Roman8, ECMA-94 Latin 1 (ISO 8859/1), ECMA-94 Latin 2 (ISO 8859/2), ECMA-128 Latin 5 (ISO 8859), United Kingdom (ISO 4), ASCII (ISO 6), Swedish (ISO 11), Italian (ISO 15), Spanish (ISO 17), German (ISO 11), Italian (ISO 15), Spanish (ISO 17), German (ISO 21), Danish/Norwegian (ISO 60), French (ISO 69), Legal, Windows Latin 1, Windows Latin 2, Windows Latin 5*

## Dimensions

### With the paper tray closed

W x H x D: 22.8 x 8.8 x 15.0 in. (579.1 x 223.5 x 380.0 mm)

### With the paper tray fully extended

W x H x D: 22.8 x 8.8 x 26.3 in. (579.1 x 223.5 x 668.0 mm)

## Weight

20.7 lb. (9.4 kg)

## Hardware Compatibility

### Windows Environment

- 80486-66 MHz processor and above (optimized for Pentium-133 MHz)
- Windows 3.1x, Windows 95, Windows 98, Windows NT 4.0
- 8 MB RAM (optimized for 16 MB RAM) for Windows 3.1x, Windows 95, Windows 98
- 24 MB RAM (optimized for 32 MB RAM) for Windows NT 4.0
- 50 MB of free hard disk space for 11" x 17" or A3 size printing (Graphics intensive files may require more disk space)

## DOS Environment

DOS 3.3 and above

## Software Compatibility

Microsoft Windows (version 3.1x, Windows 95 and Windows NT 4.0)

## Recommended Printable Weight

Paper: 60 to 135 g/m<sup>2</sup> (16 to 36 lb bond)

Envelopes: 75 to 90 g/m<sup>2</sup> (20 to 24 lb bond)

Cards: 110 to 200 g/m<sup>2</sup> (up to 110 lb index)  
(up to 0.012 in or 0.3 mm thickness for manual feed)

## Printable Paper Sizes

from 100 x 148 mm (3.94 x 5.83 in.) to 330 x 483 mm (13 x 19 in.)

## Paper Handling

Main paper tray (up to 150 sheets of 60 g/m<sup>2</sup> or 16 lb paper)

Alternative paper feed (up to 10 sheets of 60 g/m<sup>2</sup> or 16 lb paper)

Manual feed (for cards up to 0.3 mm thick which require a straight paper path)

## I/O Interface

Parallel, IEEE 1284 compliant with 1284-B receptacle (ECP)

## Printer Memory

2MB of built-in ROM

2MB of built-in RAM

64KB receive buffer

## Power Requirements

100 – 240 V ac (50 – 60 Hz)

## Power Consumption

4.4 W when idle

35 W during printing

## Operating Environment

### Temperature

Max. operating temperature: 5°C to 40°C (41°F to 104°F)

Humidity: 10–80% RH non-condensing

Recommended operating conditions for best print quality: 15°C to 35°C (59°F to 95°F), 20 to 80% RH non-condensing

Storage temperature: -40°C to 60°C (-40°F to 140°F)

## Noise Levels per ISO 9296

Sound Pressure, LpAm: 49 dB(A) (By-Stander position)

## Reliability

3,000 pages per month black text, 500 pages per month color

20,000 hours MTBF

## Product and Safety Certifications

### Printer with Power Cord

NOMI, TUV-GS, UL, CSA, SABS (South Africa), CCIB (China) and PSB (Singapore), JUN (Korea)

## EMI Certifications

Printer with Power Cord:

CE (European Union), B mark (Poland), GOST (Russia), BCIQ (Taiwan),

FCC (USA), RRL (Korea), VCCI (Japan), C-Tick (Australia, New Zealand)



## Regulatory Notices

### Power Cord Statement

The power cord cannot be repaired. If it is defective it should be discarded or returned to the supplier.

### LEDs Classification

CLASS 1 LED PRODUCT  
LED KLASSE 1  
APPARECCHIO LED DI CLASSE 1  
PRODUCT KLASY 1 Z DIODAMI ĆEWHECYCYMI LED  
Appareil à Diode Electrluminescente de Classe 1  
ZAŘÍZENÍ LED TŘÍY 1  
KLASS 1 LED APPARAT  
LUOKAN 1 LED

### Energy Consumption

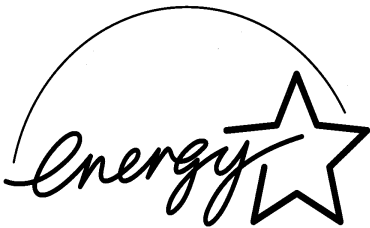

当社は国際エネルギースタープログラムの参加事業者として、本製品が国際エネルギースタープログラムの基準に適合していると判断します。』

As an ENERGY STAR Partner, Hewlett-Packard has determined that this product meets the ENERGY STAR guidelines for energy efficiency."

Energy Star is a US registered service mark of the United States Environmental Protection Agency

### Safety Information



Always follow basic safety precaution when using this product to reduce risk of injury from fire or electric shock.

1. Read and understand all instruction in the user's guide.

#### Warning

2. Observe all warnings and instructions marked on the product.
3. Unplug this product from wall outlets before cleaning.
4. Do not install or use this product near water, or when you are wet.
5. Install the product securely on a stable surface.
6. Install the product in a protected location where no one can step on or trip over the line cord, and the line cord will not be damaged.
7. If the product does not operate normally, see the "Troubleshooting" section in the User's Guide.
8. There are no user-serviceable parts inside. Refer servicing to qualified service personnel.
9. All information followed by this word is meant to alert you to a potential safety hazard.

# Hewlett-Packard Warranty Statement

HP Product	Duration of Limited Warranty
Printer	12 Months
Print cartridges	90 Days
Software	90 Days

## A. Extent of Limited Warranty

1. Hewlett-Packard (HP) warrants to the end-user customer that the HP products specified above will be free from defects in material and workmanship for the duration specified above, which duration begins on the date of purchase by the customer.
2. For software products, HP's limited warranty applies only to a failure to execute programming instructions. HP does not warrant that the operation of any product will be uninterrupted or error free.
3. HP's limited warranty covers only those defects which arises as a result of normal use of the product, and does not cover any other problems, including those which arises as a result of:
  - a. Improper maintenance or modification;
  - b. Software, media, parts or supplies not provided or supported by HP; or
  - c. Operation outside the product's specifications.
4. For HP printer products, the use of a non-HP ink cartridge or a refilled ink cartridge does not affect either the warranty to the customer or any HP support contract with the customer. However, if printer failure or damage is attributable to the use of a non-HP or refilled ink cartridge, HP will charge its standard time and materials charges to service the printer for the particular failure or damage.
5. If HP receives, during the applicable warranty period, notice of a defect in any product which is covered by HP's warranty, HP shall either repair or replace the product, at HP's option.
6. If HP is unable to repair or replace, as applicable, a defective product which is covered by HP's warranty, HP shall, within a reasonable time after being notified of the defect, refund the purchase price for the product.
7. HP shall have no obligation to repair, replace, or refund until the customer returns the defective product to HP.
8. Any replacement product may be either new or like-new, provided that it has functionality at least equal to that of the product being replaced.
9. HP products may contain remanufactured parts, components, or materials equivalent to new in performance.
10. HP's limited warranty is valid in any country where the covered HP product is distributed by HP. Contracts for additional warranty services, such as on-site service, are available from any authorized HP service facility in countries where the product is distributed by HP or by an authorized importer.

## B. Limitations of Warranty

1. TO THE EXTENT ALLOWED BY LOCAL LAW, NEITHER HP NOR ITS THIRD PARTY SUPPLIERS MAKES ANY OTHER WARRANTY OR CONDITION OF ANY KIND, WHETHER EXPRESS OR IMPLIED WARRANTIES OR CONDITIONS OF MERCHANTABILITY, SATISFACTORY QUALITY, AND FITNESS FOR A PARTICULAR PURPOSE.

## C. Limitations of Liability

1. To the extent allowed by local law, the remedies provided in this Warranty Statement are the customer's sole and exclusive remedies.
2. TO THE EXTENT ALLOWED BY LOCAL LAW, EXCEPT FOR THE OBLIGATIONS SPECIFICALLY SET FORTH IN THIS WARRANTY STATEMENT, IN NO EVENT SHALL HP OR ITS THIRD PARTY SUPPLIERS BE LIABLE FOR DIRECT, INDIRECT, SPECIAL, INCIDENTAL, OR CONSEQUENTIAL DAMAGES, WHETHER BASED ON CONTRACT, TORT, OR ANY OTHER LEGAL THEORY AND WHETHER ADVISED OF THE POSSIBILITY OF SUCH DAMAGES.

## D. Local Law

1. This Warranty Statement gives the customer specific legal rights. The customer may also have other rights which vary from state to state in United States, from province to province in Canada, and from country elsewhere in the world.
2. To the extent that this Warranty Statement is inconsistent with local law, this Warranty Statement shall be deemed modified to be consistent with such local law. Under such local law, certain disclaimers and limitations of this Warranty statement may not apply to the customer. For example, some states in the United States, as well as some governments outside the United States (including provinces in Canada), may:
  - a. Preclude the disclaimers and limitations in this Warranty Statement from limiting the statutory rights of a consumer (e.g. the United Kingdom);
  - b. Otherwise restrict the ability of a manufacturer to enforce such disclaimers or limitations; or
  - c. Grant the customer additional warranty rights, specify the duration of implied warranties which the manufacturer cannot disclaim, or allow limitations on the duration of implied warranties.
3. FOR CONSUMER TRANSACTIONS IN AUSTRALIA AND NEW ZEALAND, THE TERMS IN THIS WARRANTY STATEMENT, EXCEPT TO THE EXTENT LAWFULLY PERMITTED, DO NOT EXCLUDE, RESTRICT, OR MODIFY, AND ARE IN ADDITION TO, THE MANDATORY STATUTORY RIGHTS APPLICABLE TO THE SALE OF THE HP PRODUCTS TO SUCH CUSTOMERS.

**DECLARATION OF CONFORMITY**  
**according to ISO / IEC Guide 22 and EN 45104**

---

**Manufacturer's name:** Hewlett-Packard Singapore (Pte) Ltd.

**Manufacturer's address:** Asia Hardcopy Manufacturing Operation  
20 Gul Way Singapore 629196

*declares, that the product*

**Product Name:** HP DeskJet 1120C Printer

**Product Number:** HP C2678A

**Product Options:** All

*conforms to the following Product Specifications:*

**Safety:** IEC 950 : 1991 + A1 + A2 / EN 60950 : 1992 + A1 + A2  
IEC825-1 : 1993 / EN 60825-1 : 1994 class I for LEDS

**EMC:** CISPR 22 : 1993 / EN 55022 : 1994 Class B  
EN 50082-1 : 1992  
IEC 801-2 : 1991 / prEN 55024-2 : 1992 - 4 kV CD, 8 kV AD  
IEC 801-3 : 1984 / prEN 55024-3 : 1991 - 3 V/m  
IEC 801-4 : 1988 / prEN 55024-4 : 1992 - 0.5 kV Signal Lines  
1 kV Power Lines  
IEC-1000-3-2 : 1995 / EN 61000-3-2 : 1995  
IEC-1000-3-3 : 1994 / EN 61000-3-3 : 1995

**Supplementary Information:**

- (1) The products herewith comply with the requirements of the Low Voltage Directive 73 / 23 / EEC and the EMC Directive 89 / 336 / EEC.
- (2) The HP DeskJet 1120C printer was tested in a typical configuration with Hewlett-Packard Personal Computer.

Singapore, December 1997

Chan Kum Yew, Quality Manager

---

European Contact: Your local Hewlett-Packard Sales and Service Office or Hewlett-Packard GmbH,  
Department TRE, Herrenberger Straße 130, D-71034 Boblingen (Fax: +49-7031-143143)



© Copyright 2000  
Hewlett-Packard Company

Printed in Thailand  
Manual Part No. C8099-90003

<http://www.hp.com/go/dj1125>



C8099-90003