

## hp deskjet 5550 printer series

# table of contents

### notices

[notices and acknowledgements](#)

[terms and conventions](#)

[accessibility](#)

### special features

### getting started

[printer features](#)

[buttons and lights](#)

[paper trays](#)

[print cartridges](#)

[automatic paper-type sensor](#)

[reserve mode](#)

[connectivity](#)

### printing

[print settings](#)

[advanced features](#)

[printing digital photographs](#)

[changing default print settings](#)

[auto-on and auto-off feature](#)

[printing a document](#)

[print status box](#)

[printing a screen image](#)

[two-sided printing](#)

[using the automatic paper-type sensor](#)

[borderless printing](#)

[plain paper](#)

[envelopes](#)

[transparencies](#)

[labels](#)

[index cards and other small media](#)

[photographs](#)

[greeting cards](#)

[posters](#)

[banners](#)

[iron-on transfers](#)

## **maintenance**

[replacing print cartridges](#)

[refilling print cartridges](#)

[calibrating print cartridges](#)

[automatically cleaning print cartridges](#)

[manually cleaning the print cartridge cradle](#)

[maintaining print cartridges](#)

[maintaining the printer body](#)

[removing ink from skin and clothing](#)

[tools](#)

## **troubleshooting**

[printer is not printing](#)

[problems with printouts](#)

[printer lights are flashing or on](#)

[printer is too slow](#)

[borderless printing problems](#)

## specifications

[printer specifications](#)

[minimum printing margins](#)

[minimum system requirements](#)

[environmental statement](#)

[print cartridge recovery](#)

[limited warranty](#)

[regulatory notices](#)

## index

## notices

- [notices and acknowledgements](#)
- [terms and conventions](#)
- [accessibility](#)

## notices and acknowledgements

### hewlett-packard company notices

The information contained in this document is subject to change without notice.

Hewlett-Packard (HP) makes no warranty of any kind with regard to this material including, but not limited to, the implied warranties of merchantability and fitness for a particular purpose.

Hewlett-Packard shall not be liable for any errors or for incidental or consequential damages in connection with the furnishing, performance, or use of this material.

All rights reserved. Reproduction, adaptation, or translation of this material is prohibited without prior written permission of Hewlett-Packard, except as allowed under copyright laws.

### acknowledgments

Microsoft, MS, MS-DOS, Windows, and XP are registered trademarks of Microsoft Corporation.

TrueType is a U.S. trademark of Apple Computer, Inc.

Adobe and Acrobat are trademarks of Adobe Systems Incorporated.

**Copyright 2002 Hewlett-Packard Company**

## terms and conventions

The following terms and conventions are used in the *user's guide*.

### terms

HP Deskjet printers may be referred to as the **HP printer** or **printer**.

### symbols

The > symbol guides you through a series of software steps. For example:

Click **Start > Programs > Hewlett-Packard > [hp deskjet series] > release notes** to open the Release Notes.

### cautions and warnings

A **Caution** indicates possible damage to the HP Deskjet printer or to other equipment. For example:

**Caution!** Do not touch the print cartridge ink nozzles or copper contacts. Touching these parts will result in clogs, ink failure, and bad electrical connections.

A **Warning** indicates possible harm to yourself or to others. For example:



**Warning!** Keep both new and used print cartridges out of the reach of children.

### icons

A **Note** icon indicates that additional information is provided. For example:



For great results use HP products.

A **Mouse** icon indicates that additional information is available through the **What's This?** help feature. For example:



To find more information about options on each tab screen, point to an option and click the right mouse button to display the **What's This?** dialog box. Click **What's This?** to view more information about the selected option.

A **Printing Instructions** icon indicates that a description of print options is available in the *user's guide* . For example:



For a description of available print options, see [print settings](#) .

## accessibility

Your HP printer provides a number of features that make it accessible for people with disabilities.

### visual

The printer software is accessible for users with visual impairments or low vision through the use of Windows accessibility options and features. It also supports most assistive technology such as screen readers, Braille readers, and voice-to-text applications. For users who are color blind, colored buttons and tabs used in the software and on the HP printer have simple text or icon labels that convey the appropriate action.

### mobility

For users with mobility impairments, the printer software functions can be executed through keyboard commands. The software also supports Windows accessibility options such as StickyKeys, ToggleKeys, FilterKeys, and MouseKeys. The printer doors, buttons, paper trays, and paper guides can be operated by users with limited strength and reach.

### support

For more details about the accessibility of this product and HP's commitment to product accessibility:

- visit HP's Website at <http://www.hp.com/accessibility>
- email [accessibility@hp.com](mailto:accessibility@hp.com)



## special features

Congratulations! You have purchased an HP Deskjet printer that is equipped with several exciting features:

**photo print cartridge:** Great performance, with a [photo print cartridge](#) that prints stunning true-to-life photos.

**digital photo printing:** Enhanced [digital photo printing](#) capabilities.

**borderless printing:** Photos and cards print to the edges of the paper with [borderless printing](#).

**print screen:** [Print screen](#) images print at the touch of a button.

**reserve mode:** [Reserve mode](#) lets you continue printing with one print cartridge when the other print cartridge has run out of ink.

**auto-on and auto-off:** Enable [auto-off](#) to place the printer into a low-power, energy-efficient mode after it has been idle for 30 minutes. The printer turns on automatically when you print a file.

**Poster Printing:** [Poster printing](#) lets you print a poster on multiple pages which can be taped together.



## getting started

- [printer features](#)
- [buttons and lights](#)
- [paper trays](#)
- [print cartridges](#)
- [reserve mode](#)
- [automatic paper-type sensor](#)
- [connectivity](#)

## printer features

The HP printer has several features to make printing easier and more efficient.

To view a printer feature, click below on the name of the feature.



**1.** [buttons and lights](#)

**2.** [paper trays](#)

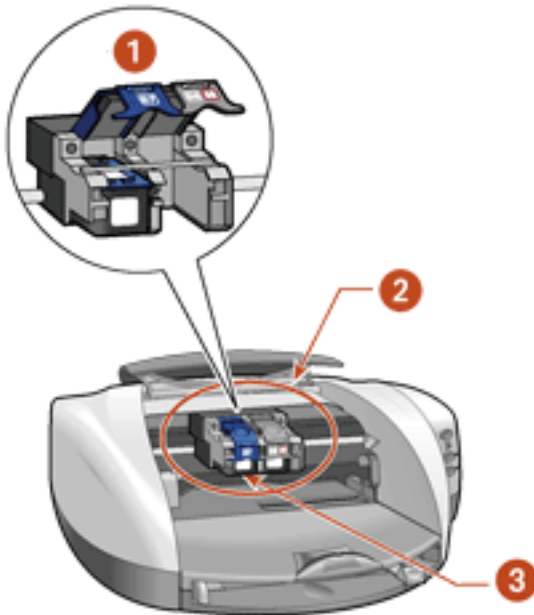

**1.** [reserve mode](#)

**2.** [print cartridges](#)

**3.** [automatic paper-type sensor](#)

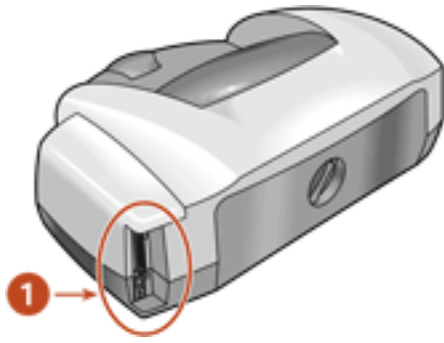

**1.** [connectivity](#)

## buttons and lights

The printer buttons let you turn the printer on and off, cancel a print job, or resume printing. The lights give you visual cues about the status of the printer.

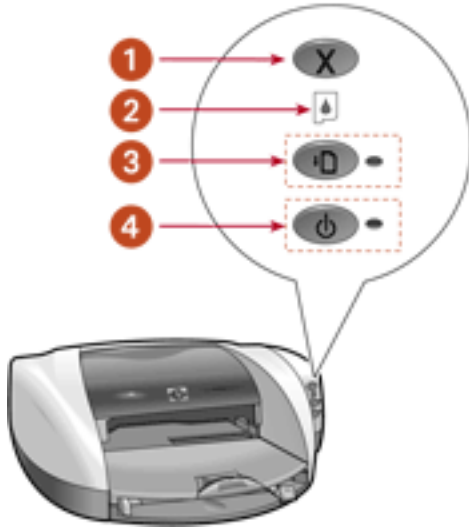

**1. Cancel button 2. Print Cartridge Status light 3. Resume button and light 4. Power button and light**

### cancel button

Pressing the Cancel button cancels the current print job.

### print cartridge status symbol and light

The Print Cartridge Status light turns on or flashes when a print cartridge needs service.

### resume button and lights

The Resume light flashes when an action is required such as loading paper or clearing a paper jam. When the problem is solved, press the Resume button to continue printing.

### power button and light

The Power button turns the printer on and off. It may take a few seconds for the printer to turn on after pressing the Power button. The green light next to the Power button flashes when the printer is processing.

**Caution!** Always use the Power button on the front of the printer to turn the printer on and off. Using a power strip, surge protector, or a wall-mounted switch to turn the printer on and off may cause printer failure.

## paper trays

The printer has two paper trays: an In tray and an Out tray. The Out tray contains a slot for single envelope printing.



**1. Out tray 2. In tray 3. single envelope slot**

### In tray

The In tray holds paper or other media to be printed.

You can print different sizes of media by sliding the paper guides in and out.

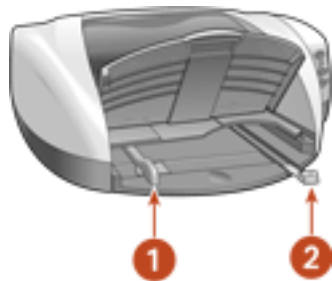

**1. paper width guide 2. paper length guide**

### Out tray

Printed pages are deposited in the Out tray.

Raise the Out tray to load paper.



**1. Out tray up**

Remove the Out tray to load small media, such as index cards.



Replace the Out tray before printing.



**Out tray extension** - Pull out the Out tray extension when printing a large number of pages. Also pull out the extension when printing in draft mode to prevent the paper from falling out of the tray. When the print job finishes, push the tray extension into its storage slot.



**1. Out tray extension**



## print cartridges

Three print cartridges can be used with your printer:

- black print cartridge
- tri-color print cartridge
- photo print cartridge



**1. black print cartridge 2. tri-color print cartridge 3. photo print cartridge**

### print cartridge selection

print cartridge	selection number	product number
<b>black</b>	<b>56</b>	c6656a
<b>tri-color</b>	<b>57</b>	c6657a
<b>photo print</b>	<b>58</b>	c6658a

For installation instructions, see [replacing print cartridges](#) .

For storage instructions, see [maintaining print cartridges](#) .

For recycling instructions, see [print cartridge recovery](#) .



For print cartridge ink capacity, see the information included in the print cartridge packaging.

## automatic paper-type sensor

The Automatic Paper-Type Sensor determines the correct paper type and adjusts the print settings for most paper or media placed in the paper tray. **Automatic** is the default option in the Printer Properties dialog box.

This feature, particularly when used with HP paper and media, provides better printing results.

When the Automatic default option is selected, the Automatic Paper-Type Sensor is engaged. The printer scans the first page of a document with a blue optical sensor light to determine the best paper type setting. Once determined, the page is printed.

For more information, see [using the automatic paper type sensor](#).

## reserve mode

Reserve mode allows the printer to operate using only one print cartridge. It is initiated when a print cartridge is removed from the cradle.

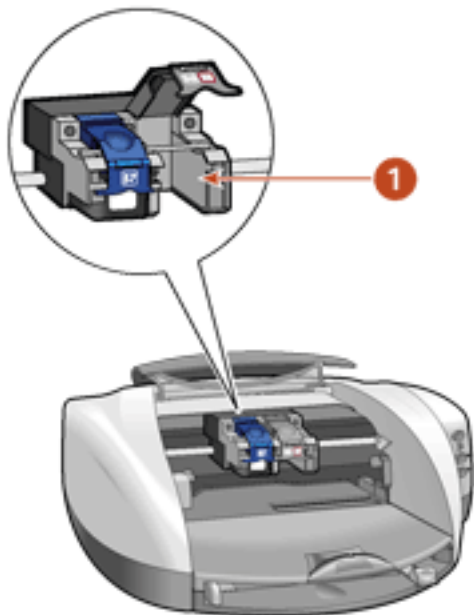

**1. remove print cartridge to initiate reserve mode**

## reserve mode output

Printing in reserve mode slows the printer and affects the quality of printouts.

when only this print cartridge is installed...	the result is...
black print cartridge	Colors are printed as grayscale.
tri-color print cartridge	Colors print but black is grayed and is not a true black. Printing a black text or monochrome document with a tri-color print cartridge increases printing time.
photo print cartridge	Colors are printed as grayscale.

## exiting reserve mode

Install two print cartridges in the printer to exit the reserve mode.

For instructions on installing a print cartridge, see [replacing print cartridges](#).

## connectivity

The printer offers a number of options for connectivity, including:

- [USB](#)
- [parallel](#)
- [network](#)

### USB

The printer connects to the computer with a USB cable. Your computer must be running Windows 98, Me, 2000, or XP operating system to use a USB cable.



For instructions on connecting the printer with a USB cable, see the *Setup* poster that came with the printer.

### parallel

The printer can connect to your computer with a parallel cable.



For instructions on connecting with a parallel cable, see the *Setup* poster that came with the printer.

### network

The printer can be connected to a network in one of two ways:

- The printer can be connected directly to a computer on the network.

For instructions on connecting the printer directly to a computer on the network, **21**

use the printer software CD and follow the *onscreen network setup* instructions.

- The printer can be connected to a network with an HP JetDirect Print Server.

For instructions on connecting the printer to a network with an HP JetDirect Print Server, use the printer software CD and the documentation that came with the HP JetDirect Print Server.

## printing

Click the following topic below to view an explanation of the printer software:

- [print settings](#)
- [advanced features](#)
- [printing digital photographs](#)
- [changing default print settings](#)
- [auto-on and auto-off feature](#)

Click the appropriate topic below to view instructions on printing functions:

- [printing a document](#)
- [using the print status box](#)
- [printing a screen image](#)
- [two-sided printing](#)
- [using the automatic paper-type sensor](#)
- [borderless printing](#)

Click the appropriate topic below to view instructions for printing on different paper types:

- [plain paper](#)
- [envelopes](#)
- [transparencies](#)
- [labels](#)
- [index cards and other small media](#)
- [photographs](#)
- [greeting cards](#)
- [posters](#)
- [banners](#)
- [iron-on transfers](#)

## print settings

The printer is controlled by software installed on your computer. Use the printer software, known as the *printer driver* , to change the print settings for a document.

To change printer settings, open the Printer Properties dialog box.

### displaying the printer properties dialog box

Follow these steps to display the Printer Properties dialog box:

1. Open the file you want to print.
2. Follow one of these paths to select the Printer Properties dialog box, depending on the software program you are using:
  - Click **File** > **Print** , then select **Properties** .
  - Click **File** > **Print Setup** , then select **Properties** .
  - Click **File** > **Print** > **Setup** , then select **Properties** .

The Printer Properties dialog box appears.

### using the printer properties dialog box

The Printer Properties dialog box has several tools to make it easy to use.

In addition to the tabs shown below, the Printer Properties dialog box may also have a Services tab. See [tools](#) for further information.

### quality tab

The Quality tab allows you to set these options:



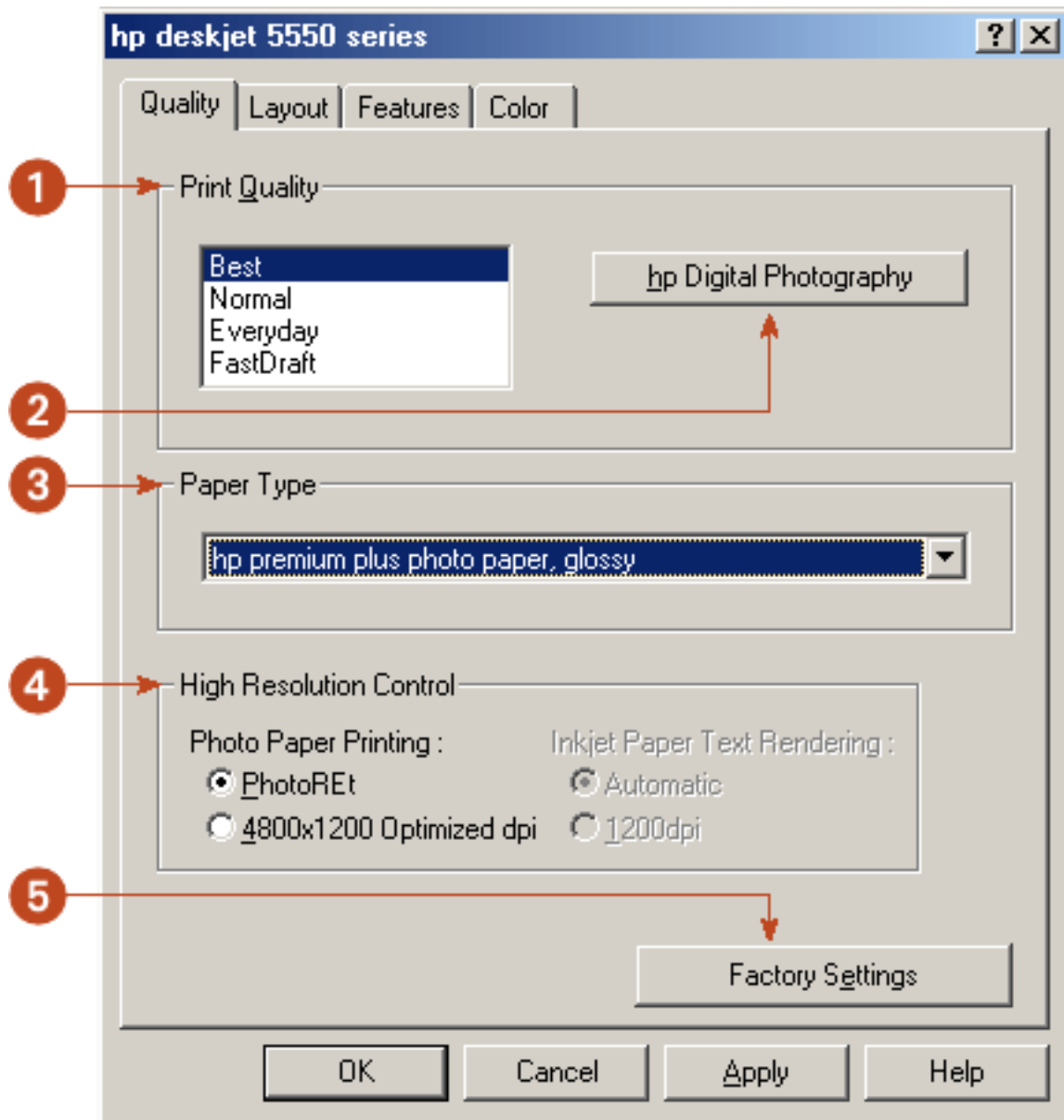

1. **Print Quality:** Quality of printout. There are four options to choose from: **Best** , **Normal** , **Everyday** , and **FastDraft** . *Best* provides the best print quality at the slowest printing speed. The print speed increases and the print quality lessens with *Normal* , *Everyday* , and *FastDraft* . *FastDraft* provides draft quality at the fastest printing speed.
2. **HP Digital Photography:** See [printing digital photographs](#) .
3. **Paper Type:** Type of paper used. **Automatic** is the default setting. It enables the printer to automatically select the paper type.
4. **High Resolution Control:** Quality of graphic printing on certain papers, such as hp photo papers.
5. **Factory Settings:** Returns all settings to the factory default values.

## layout tab

The Layout tab allows you to set these options:

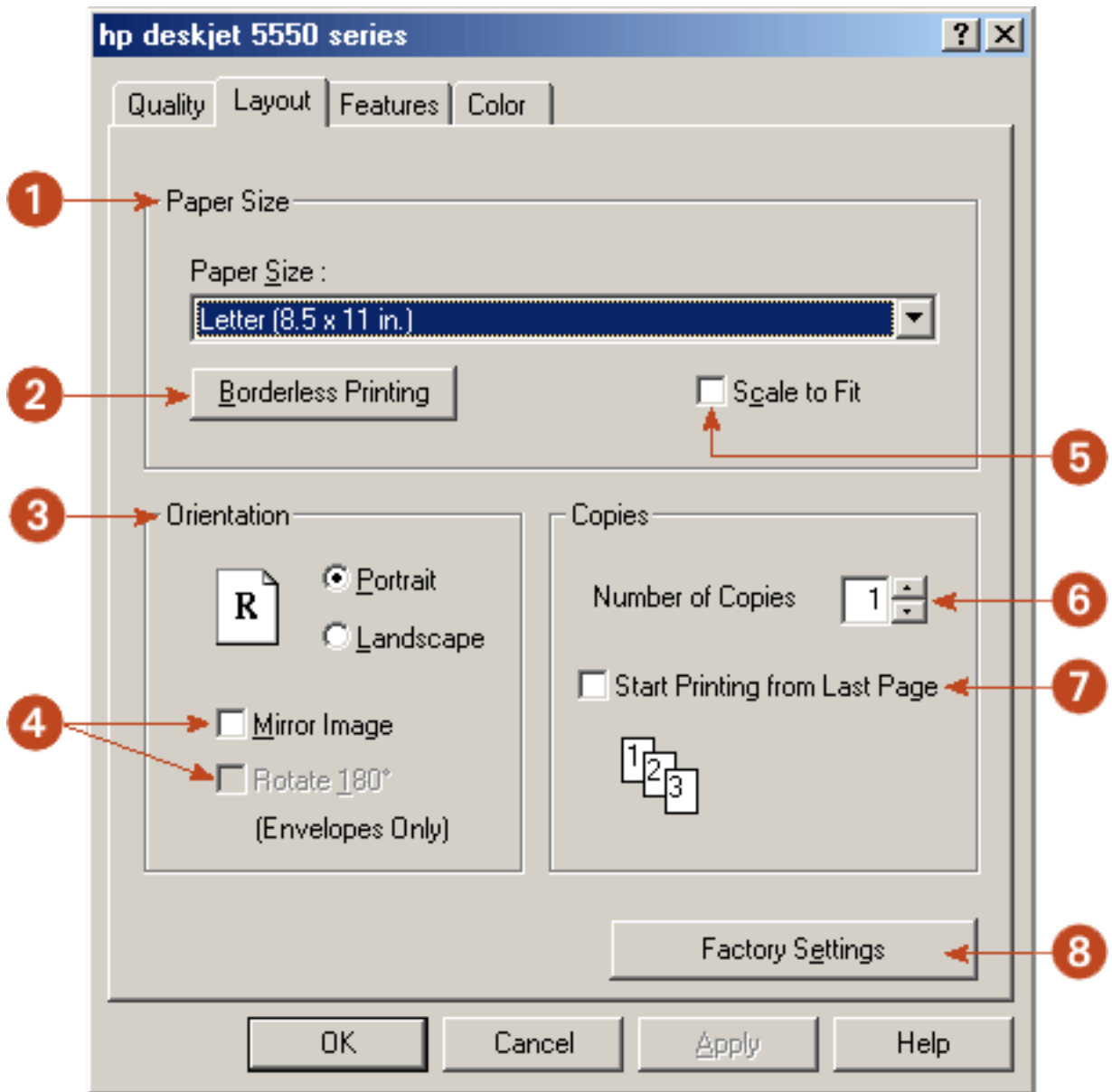

1. **Paper Size:** Size of paper used.
2. **Borderless Printing:** See [borderless printing](#).
3. **Orientation:** Page layout.
4. **Mirror Image/Rotate 180°:** Advanced orientation options.
5. **Scale to Fit:** Size of text and images on a page.
6. **Copies:** Number of copies printed.
7. **Start Printing from Last Page:** Print the last page first.

## 8. **Factory Settings:** Returns all settings to the factory default values.

### features tab

The Features tab allows you to set these options:

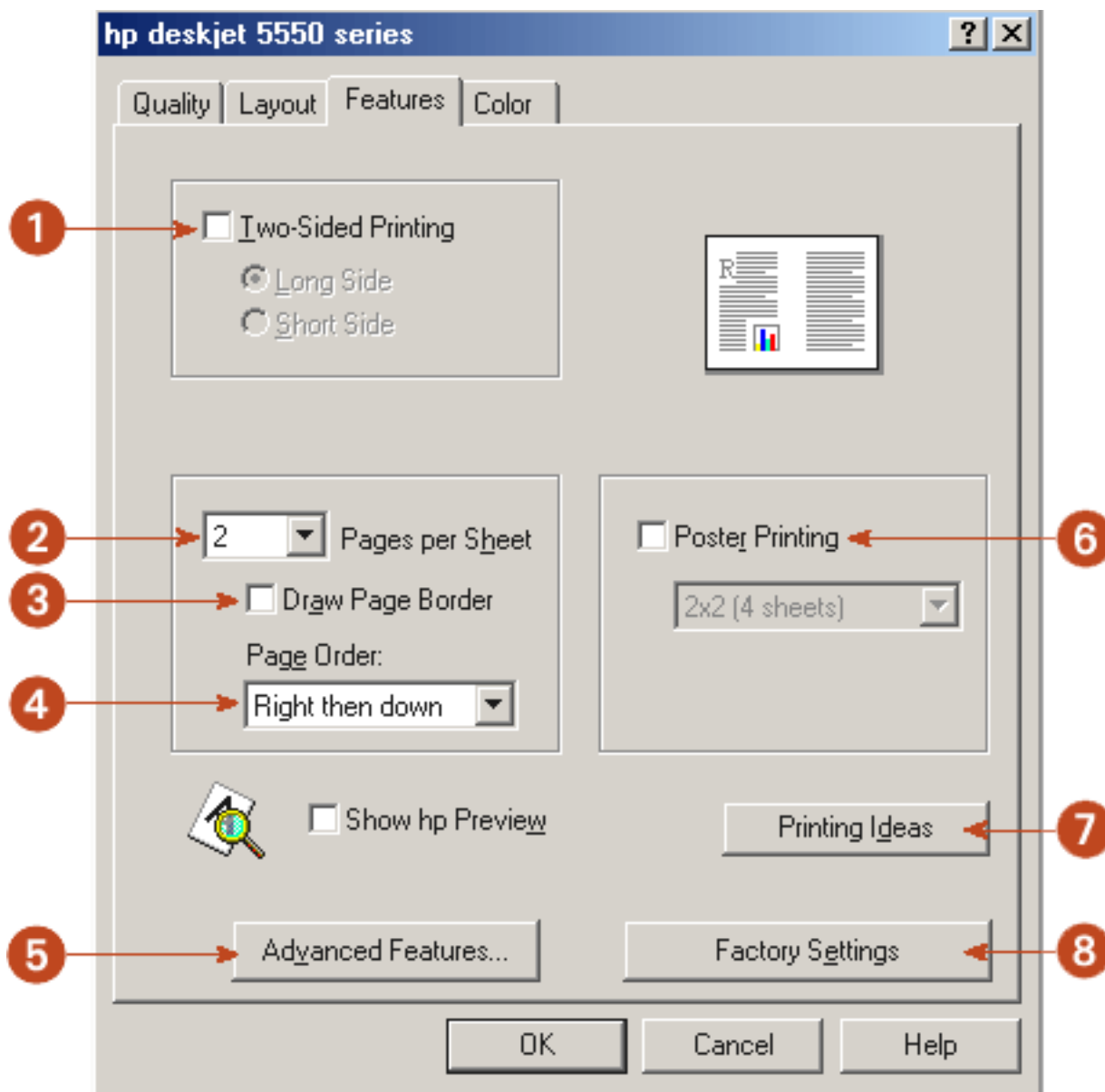

1. **Two-Sided Printing:** See [two-sided printing](#).
2. **Pages per Sheet:** Number of pages printed on each sheet of paper.
3. **Draw Page Border:** Place border around each page on a sheet of paper.
4. **Page Order:** Order in which multiple pages appear on a sheet of paper.
5. **Advanced Features:** See [advanced features](#).

6. **Poster Printing:** Number of paper sheets used to print a poster.
7. **Printing Ideas:** Creative ideas for printing.
8. **Factory Settings:** Returns all settings to the factory default values.

## color tab

The Color tab allows you to set these options:

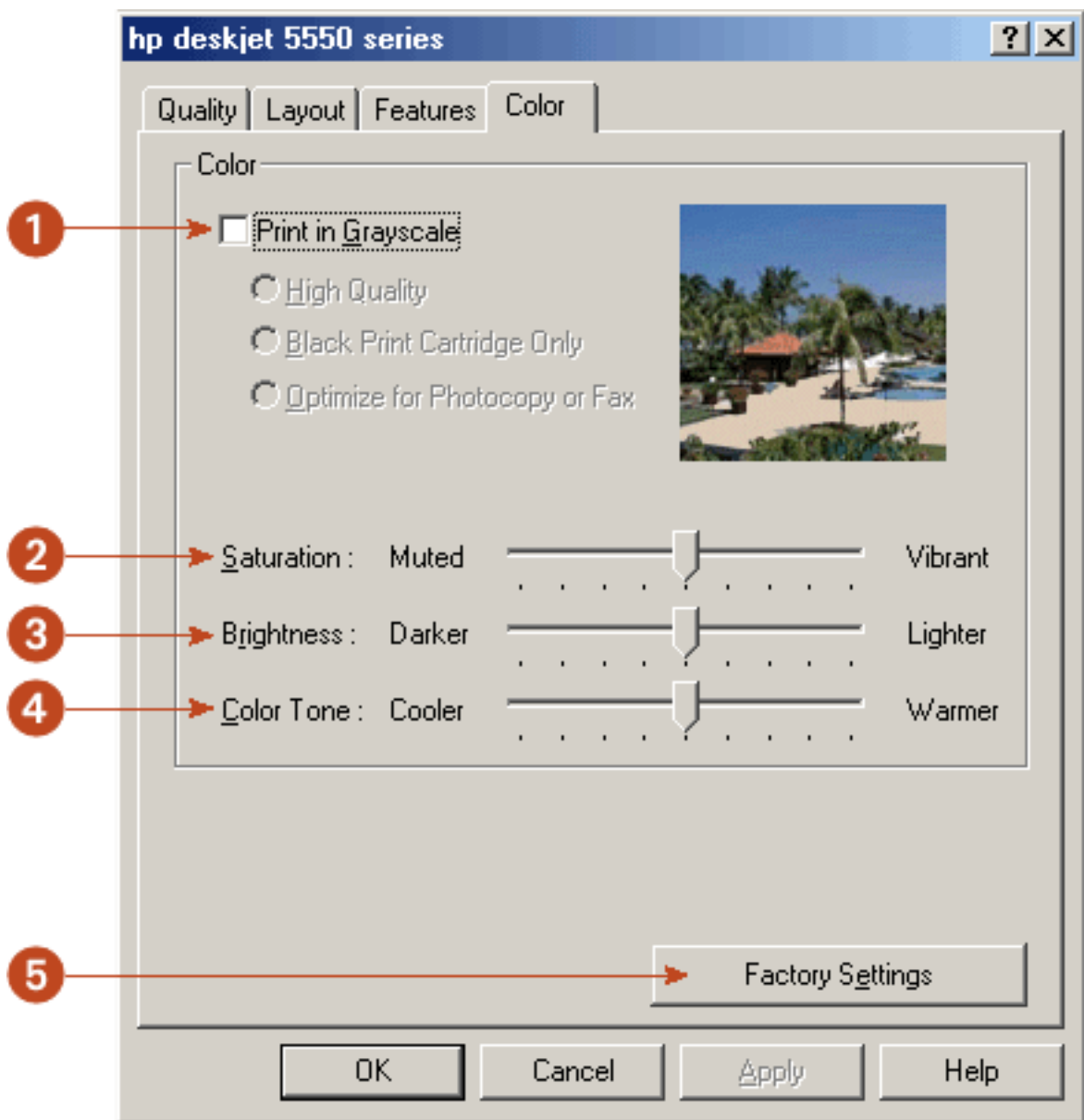

1. **Print in Grayscale:** Print in shades of gray.
2. **Saturation:** Intensity of printed colors.
3. **Brightness:** Lightness or darkness of printed colors.

4. **Color Tone:** Warmth or coolness of printed colors.
5. **Factory Settings:** Returns all settings to the factory default values.



To find more information about options on each tab screen, point to an option and click the right mouse button to display the What's This? dialog box. Click What's This? to view more information about the selected option.

You may also have a Services tab. See [tools](#) for further information.

## advanced features

Printing photographs, transparencies, or documents with graphics may require you to set several options in the Advanced Features dialog box.

### accessing the advanced options dialog box

Follow these steps to access the Advanced Features dialog box:

1. Open the **Printer Properties** dialog box.
2. Click the **Features** tab, then click the **Advanced Features** button.

### using the advanced features dialog box

Use the Advanced Features dialog box to set these options:

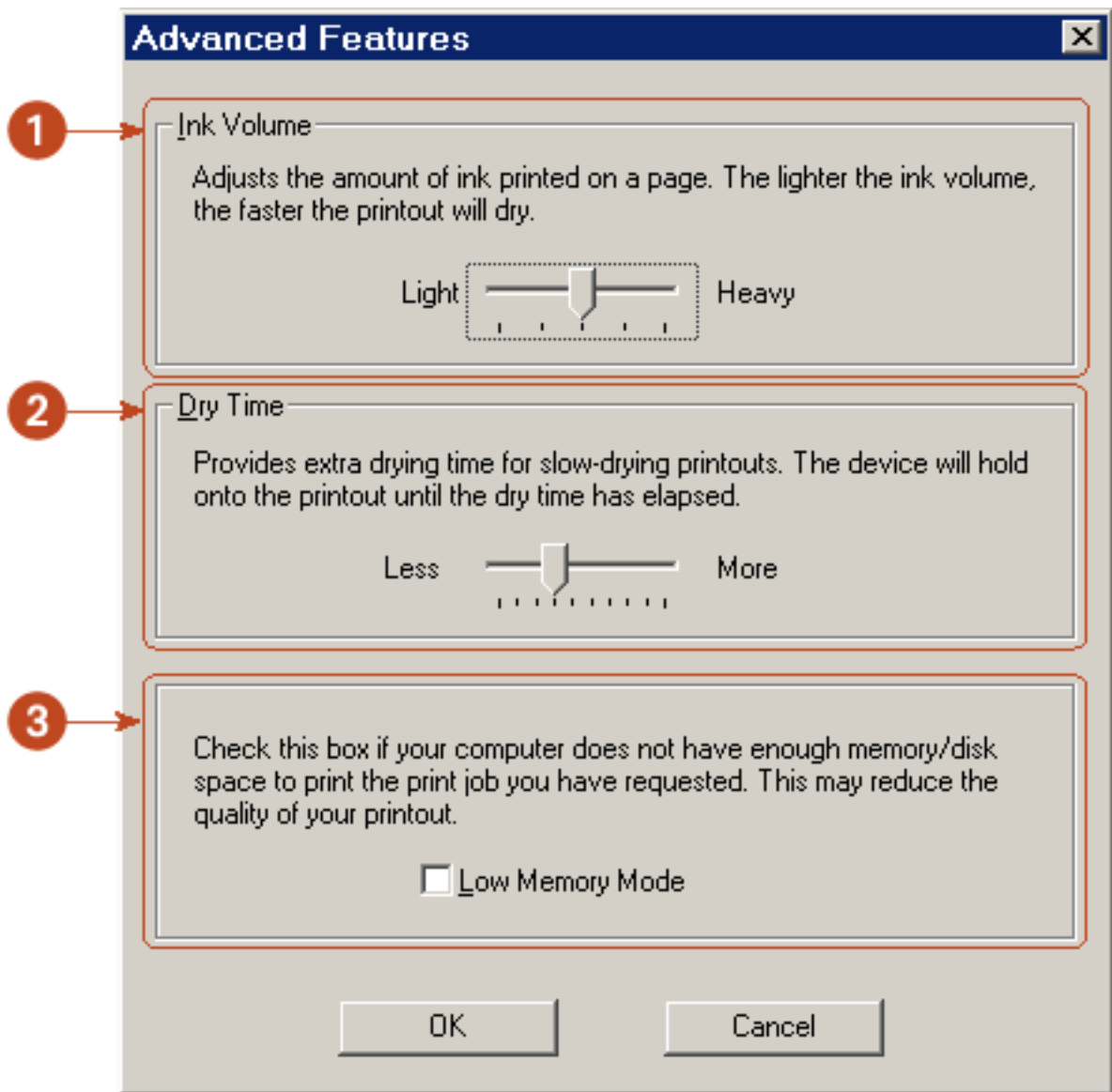

1. **Ink Volume:** Select this feature to lessen or increase the amount of ink used to print a document.
2. **Dry Time:** Select this feature to increase the time the printer holds a document after printing if the ink on your printed document smears.
3. **Low Memory Mode:** Select this option to allow the draft to be printed if your computer does not have enough memory or disk space to print a document.



Using Low Memory Mode may reduce the quality of your printout.

## printing digital photographs

The hp deskjet printer has several features to improve the print quality of your digital photographs. These features are found in the HP Digital Photography Options dialog box.

To access these options:

1. Open the **Printer Properties** dialog box.
2. Click the **Quality** tab, then click the **hp Digital Photography** button.

### using the hp digital photography options dialog box

Use the HP Digital Photography Options dialog box to set these options:

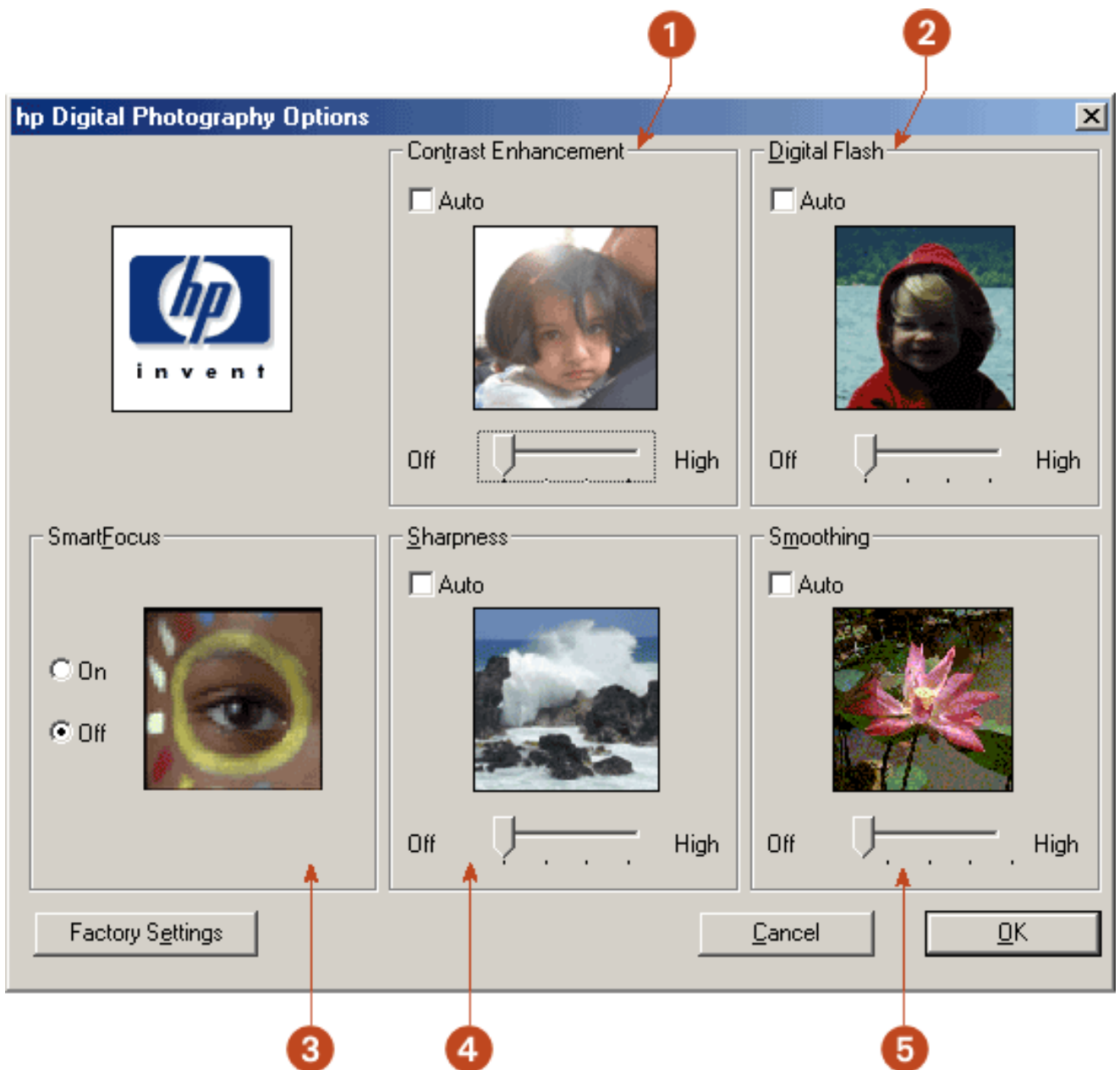



1. **Contrast Enhancement:** Adjust contrast to preference. Click **Auto** to allow the printer driver to automatically balance contrast.
2. **Digital Flash:** Lighten dark images. Click **Auto** to allow the printer driver to automatically balance lightness and darkness.
3. **SmartFocus:** Click **On** to allow the printer driver to automatically focus images.
4. **Sharpness:** Adjust image sharpness to preference. Click **Auto** to allow the printer driver to automatically balance sharpness.
5. **Smoothing:** Adjust distortion to preference. Click **Auto** to allow the printer driver to automatically balance smoothing.

## changing default settings

### changing printer settings

The taskbar icon lets you change the default print settings. Default print settings apply to all documents you print with your HP Deskjet printer.



#### 1. taskbar icon

### using the taskbar icon shortcut menu

1. Right-click the **taskbar icon** .
2. Select **Change Default Print Settings** .  
The Printer Properties dialog box appears.
3. Select the print properties you wish to use for the default print settings.
4. Click **OK** .

A dialog box appears stating that the new settings will be used every time you print. If you do not want to see this dialog box again, select **Don't show me this**<sup>34</sup>

**message again .**

5. Click **OK** to save the new default print settings.

These settings will remain in effect unless you change the default print settings again.

## turning off the taskbar icon

1. Right-click the **taskbar icon** .  
The taskbar shortcut menu screen appears.
2. Select **Exit** to turn off the taskbar icon.

## turning on the taskbar icon

Click **Start > Programs > Hewlett-Packard > [hp deskjet series] > taskbar icon** .  
The taskbar appears automatically whenever you restart you computer.

## auto-on and auto-off feature

### enabling auto-on

Auto-On is a default feature of the printer. The printer automatically turns on when you print a file.

### enabling auto-off

Enable the auto-off feature to place the printer in a low-power, energy-efficient mode after it has been idle for 30 minutes.

Instructions for enabling the auto-off feature vary depending on how the printer was installed on your computer.

To view the correct instructions, answer the following question:

**Does this icon appear on your computer's desktop?**



- [Yes](#) (use printer assistant)
- [No](#) (use printer properties)

### accessing auto-off from the printer assistant

1. Click [configure printer](#) .
2. Click the **Configure** button.  
The HP Deskjet Toolbox screen appears.
3. Select the **Configuration** tab.
4. Select **Activate the Hardware Auto-off feature** to turn on the feature.

—or—

De-select **Activate the Hardware Auto-off feature** to turn off the feature.

5. Click **Apply** .

## accessing auto-off from printer properties

1. Open [printer properties](#) .

2. Click the **Services** tab.

3. Click the **HP Toolbox** button.

The HP Deskjet Toolbox screen appears.

4. Select the **Configuration** tab.

5. Select **Activate the Hardware Auto-off feature** to turn on the feature.

—or—

De-select **Activate the Hardware Auto-off feature** to turn off the feature.

6. Click **Apply** .

## printing a document

Follow these instructions to print a document or change your print settings:

1. Open the file you want to print.
2. Follow one of these paths to open the Printer Properties dialog box:
  - Click **File** > **Print** , then select **Properties** .
  - Click **File** > **Print Setup** , then select **Properties** .
  - Click **File** > **Print** > **Setup** , then select **Properties** .

The Printer Properties dialog box appears.

3. Select the **Quality** tab to choose print quality options, Automatic or a specific paper type, resolution, and HP Digital Photography options.

The Automatic Paper-Type Sensor automatically sets the paper-type option. *Automatic* is the default setting.

4. Select the **Layout** tab to choose paper size, borderless printing, orientation, number of copies printed, and print order.
5. Select the **Features** tab to choose two-sided printing, multiple pages per sheet, and poster printing.
6. Select the **Color** tab to make color and contrast adjustments.
7. Click **OK** to return to the Print or Print Setup screen.



The Printer Properties dialog box may also display the Apply button. The Apply button saves changes to settings without closing the dialog box.

8. Click **OK** to print.

## print status box

The Print Status box appears each time the printer prints a file.

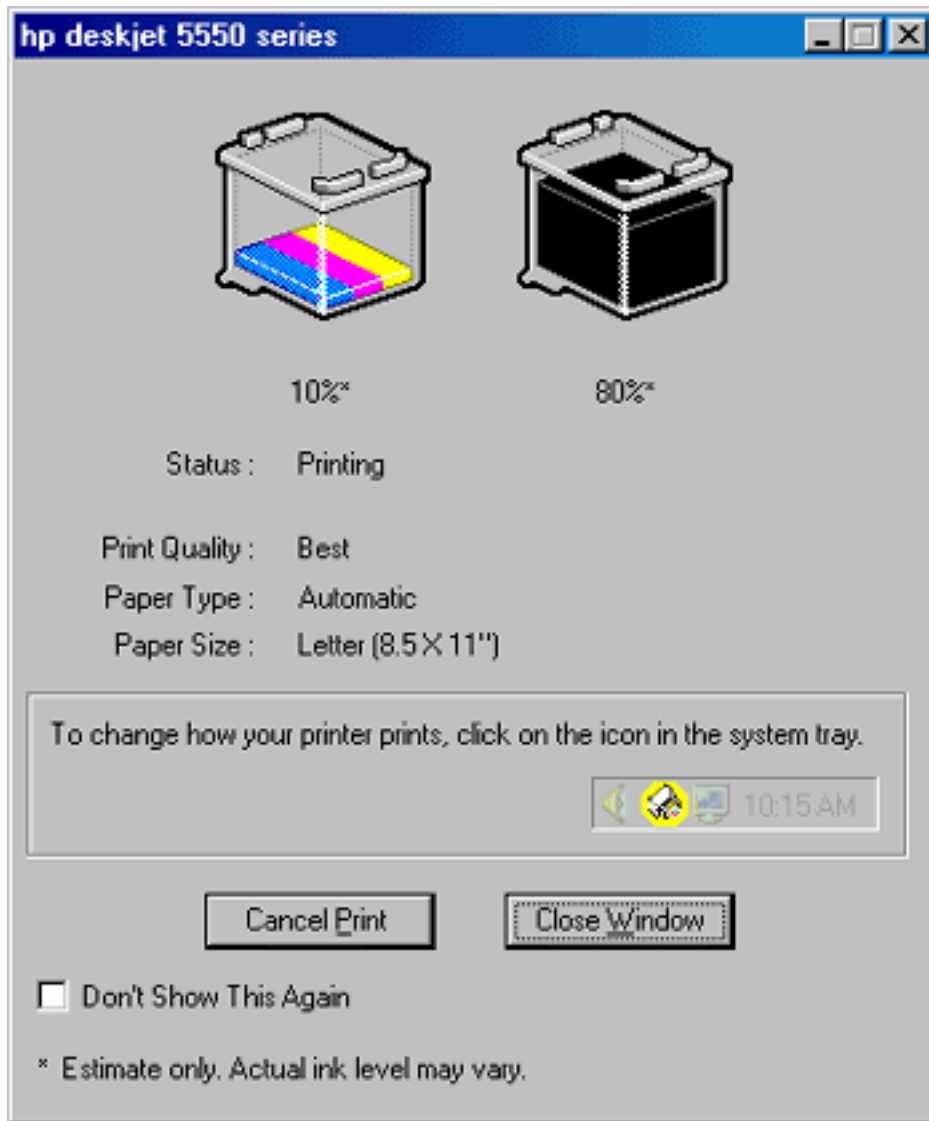

The following items are displayed:

- **Ink Level:** Approximate ink level of each print cartridge
- **Status:** Status of the print job
- **Print Quality:** **FastDraft** , **Everyday** , **Normal** , or **Best**
- **Paper Type:** Type of paper used
- **Paper Size:** Size of paper used

To change the print options, click the [taskbar icon](#) .

To cancel a print job, click **Cancel Print** .

To close the Print Status box, click **Close Window** .



## printing a screen image

The HP Print Screen Utility\* allows you to print a screen image displayed on the computer monitor. It works when your HP deskjet printer is selected as the default printer.

*\*This option may not be available depending on printer installation.*

## printing guidelines

Use either letter-sized or A4-sized paper to print the image.

## print screen button

- Press the **Print Screen** button on the keyboard to print a screen.
- or-
- Press the **Alt** and the **Print Screen** button on the keyboard at the same time to print an active application window.

## configuring the hp print screen utility

Access the HP Print Screen Utility configuration window in Windows from **Start > Programs > Hewlett-Packard > hp print screen** .

Use the configuration window to set up various options for the HP Print Screen Utility:

1. **Unload/Load HP Print Screen** activates or deactivates the utility.
2. **Start with Windows** determines whether the HP Print Screen Utility launches automatically when Windows is started.
3. **Capture screen** performs the same action as if the **Print Screen** button on the keyboard were pressed.
4. **Orientation** toggles between landscape and portrait mode.

## two-sided printing

### printing instructions

Follow these instructions to print a two-sided document manually:

1. Open the **Printer Properties** dialog box, then select the **Features** tab.
2. Check **Two-Sided Printing** .  
The Two-Sided Printing Margin dialog box appears.
3. Select the appropriate page content option, then click **OK** to return to the Features tab.
4. Select **Long Side** (binding on the side) or **Short Side** (binding at the top).
5. Deselect the **Automatic** box.
6. Change any other desired print settings, then click **OK** .

The printer automatically prints odd-numbered pages first. Once the odd-numbered pages are printed, a message appears prompting you to reload the paper so that the even-numbered pages can be printed.

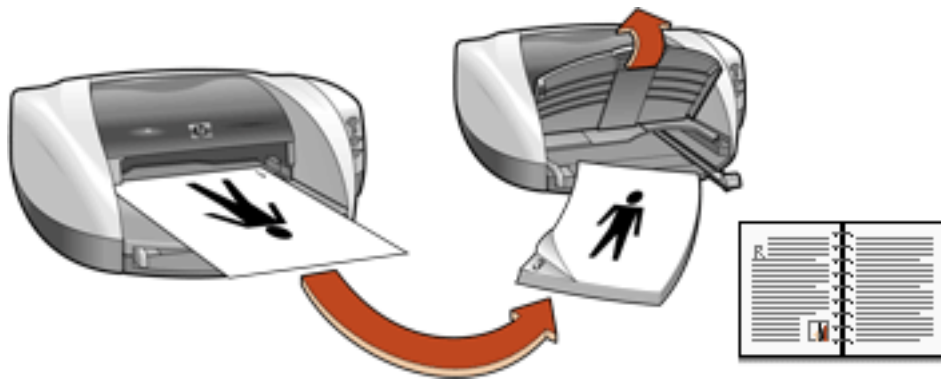

**Long side binding**

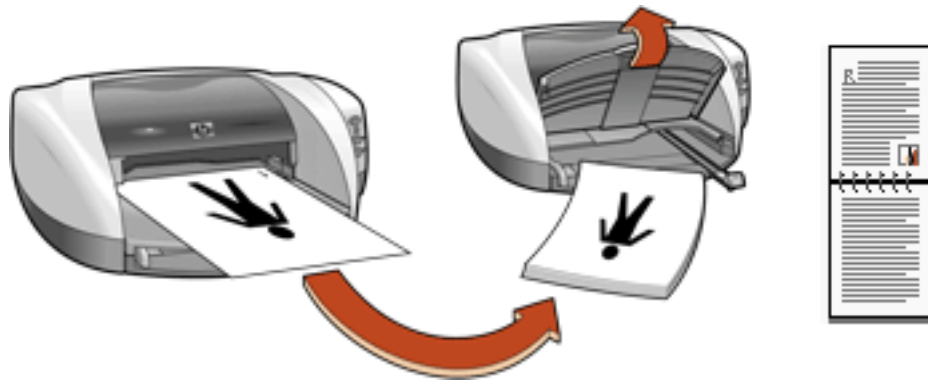

**Short side binding**

7. Reload the paper, then click **Continue** .

## using the automatic paper-type sensor

For a description of the Automatic Paper-Type Sensor feature, see [Automatic Paper-Type Sensor](#).

### turning off the automatic paper-type sensor

Open the file you want to print. Follow the basic printing procedures and select the following option:

tab	setting
<b>Quality</b>	Any paper type <i>other than</i> <b>Automatic</b>



For a description of available print options, see [print settings](#).

### turning on the automatic paper-type sensor

Open the file you want to print. Follow the basic printing procedures and select the following option:

tab	setting
<b>Quality</b>	<b>Paper Type: Automatic</b>

## borderless printing

Borderless printing lets you print to the edges of small media such as cards and photos.

**4 x 6 inch photo paper with tear-off tabs:** When you print on this media, the printout is completely borderless after the tear-off strip is removed.



**A6 cards, greeting cards, Hagaki cards, and 4 x 6 inch photos without tear-off tabs:** When you print on any of these media types, the printout is borderless on three sides with a narrow border on the bottom.



## printing guidelines

**selecting paper:** Use the following paper types for borderless printing.

- Photo 4 x 6 in with tab
- Photo 4 x 6 in

- A6 Card 105 x 148.5 mm

**selecting image size:** Open the image file in a software application and assign the image size. The size corresponds to the paper size on which you want to print the image. When printing, select the appropriate paper size and type from the lists displayed on the Borderless Printing dialog box.

## preparing to print

Load the paper into the printer according to the instructions for the paper type.

- [photographs](#)



**loading and printing photo paper with tear-off tab:** Remove the Out tray and, holding the tabbed edge, slide the HP Borderless Photo paper printable or glossy--side down, into the In tray. Replace the Out tray.

- [index cards and other small media](#)

## printing

1. Select the appropriate paper type and paper size.
2. Click a two-sided printing option when appropriate, such as for cards.

Clicking a two-sided printing option limits the options available in the paper type menu. For example, photos are only printed on one side.

3. Click **OK** to return to the Layout tab.
4. Select any other desired print settings.
5. Click **OK** .

## plain paper

### preparing to print

1. Raise the Out tray.
2. Slide out both paper guides.
3. Do one of the following:
  - For **letter** , **executive** , and **B5** sized paper, place up to 100 sheets of paper in the In tray.

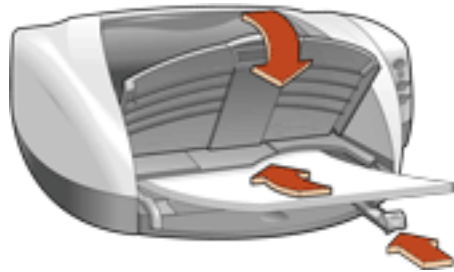

—or—

- For **legal-sized** and **A4** paper, pull out the paper length guide, then place up to 100 sheets of paper in the In tray.

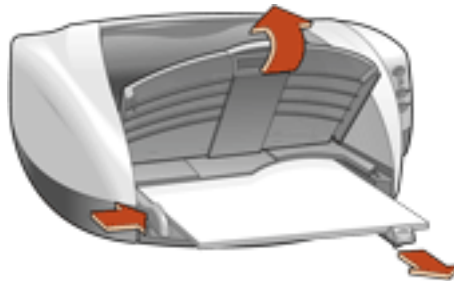

4. Slide the paper guides *firmly* against the paper.
5. Lower the Out tray.

### printing on plain paper

1. Open the [Printer Properties](#) dialog box, then select the following setting:

tab	setting
<b>Quality</b>	<b>Paper Type: Automatic or Plain Paper</b>

2. Select any other desired print settings.
3. After you have selected the print settings, click **OK** .



For a description of available print options, see [print settings](#) .



## envelopes

Print a single envelope using the envelope slot, or print multiple envelopes using the paper tray.

### printing guidelines

- Never place more than 15 envelopes in the In tray at one time.
- Avoid using envelopes that have clasps or windows.
- Avoid using envelopes that are shiny or embossed; envelopes with thick, irregular, or curled edges; or envelopes that are wrinkled, torn, or otherwise damaged.
- Align the envelope edges before inserting them in the paper tray.

### preparing to print a single envelope

1. Place the envelope with the flap side on the left and facing up into the single envelope slot.
2. Push the envelope forward until it stops.



### preparing to print a stack of envelopes

1. Remove the Out tray.



2. Slide out both paper guides and remove all paper from the In tray.
3. Place no more than 15 envelopes—with the flap side on the left and facing up—in the In tray.

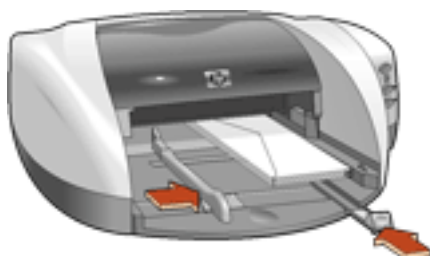

4. Push the envelopes forward until they stop.
5. Slide the paper guides *firmly* against the edges of the envelopes.
6. Replace the Out tray.



## printing the envelopes



If your software program includes an envelope-printing feature, follow the instructions provided with the software program. Otherwise, follow the instructions below.

1. Open the [Printer Properties](#) dialog box, then select the following settings:

tab	setting
Quality	Paper Type: <b>Automatic</b> or <b>Plain Paper</b>

<b>Layout</b>	<b>Orientation:</b> Appropriate envelope orientation <b>Paper Size:</b> Appropriate envelope size
---------------	--

2. Select any other desired print settings.
3. After you have selected the print settings, click **OK** .



For a description of available print options, see [print settings](#) .

## transparencies

### printing guidelines

For great results use **hp premium inkjet transparency film** .

### preparing to print

1. Raise the Out tray.
2. Slide out both paper guides, then remove all paper from the In tray.
3. Fan the edges of the transparency sheets to separate them, then align the edges.
4. Place up to 25 transparency sheets in the In tray with the rough side down and the adhesive strip toward the printer.

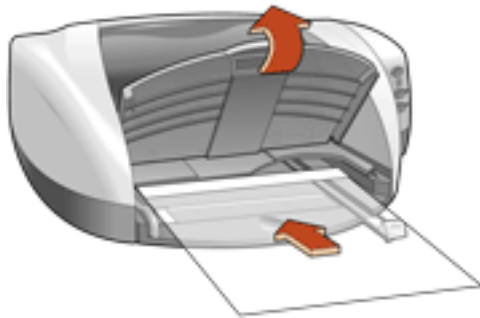

5. Carefully push the transparencies forward until they stop so that none of the adhesive strips catch on one another.
6. Slide the paper guides *firmly* against the transparency sheets.
7. Lower the Out tray.

### printing transparencies

1. Open the [Printer Properties](#) dialog box, then select the following setting:

tab	setting

<b>Quality</b>	<b>Paper Type: Automatic</b> or the appropriate transparency film
----------------	---

2. Select any other desired print settings.
3. After you have selected the print settings, click **OK** .

The printer may wait for transparencies to dry before releasing them.



For a description of available print options, see [print settings](#) .

# labels

## printing guidelines

- Use only paper labels that are designed specifically for inkjet printers.
- Use only full sheets of labels.
- Verify that the labels are not sticky, wrinkled, or pulling away from the protective backing.
- Do not use plastic or clear labels. The ink will not dry on these labels.
- Never place more than 20 sheets of labels in the In tray at one time.

## preparing to print

1. Raise the Out tray.
2. Slide out both paper guides, then remove all paper from the In tray.
3. Fan the edges of the label sheets to separate them, then align the label edges.
4. Load up to 20 label sheets—label side down—in the In tray.
5. Slide the paper guides *firmly* against the sheets.

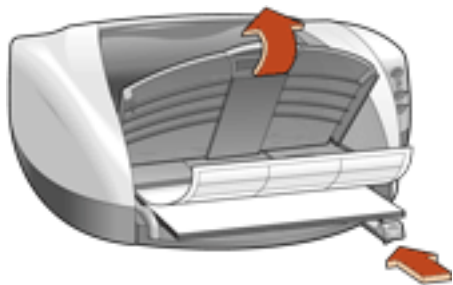

6. Lower the Out tray.

## printing labels



If your software program includes a label printing feature, follow the instructions provided with the software program. Otherwise, follow the instructions below.

1. Open the [Printer Properties](#) dialog box, then select the following settings:

tab	setting
<b>Quality</b>	<b>Paper Type:</b> <b>Automatic</b> , or the appropriate paper type
<b>Layout</b>	<b>Paper Size:</b> Choose <b>A4</b> or <b>Letter (8.5 x 11 in)</b> <b>Orientation:</b> Appropriate orientation
<b>Features</b>	<b>Two-Sided Printing:</b> Unchecked

2. Select any other desired print settings.
3. After you have selected the print settings, click **OK** .



For a description of available print options, see [print settings](#) .

# index cards and other small media

## printing guidelines

- Use only cards and small media that meet the printer's paper size specifications.
- If an **out of paper** message appears, verify that the index cards or other small media are positioned properly in the In tray.
- To print borderless A6 (105 x 148.5 mm) cards, see [borderless printing](#).

## preparing to print index cards or other small media

1. Remove the Out tray.

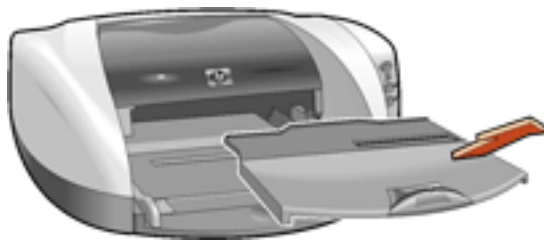

2. Slide out both paper guides, then remove all paper from the In tray.
3. Align the card edges.
4. Place up to 30 cards in the In tray.
5. Push the cards forward until they stop.
6. Slide the paper guides *firmly* against the edges of the cards.



7. Replace the Out tray.





## printing index cards and other small media



If your software program includes a card printing feature, follow the instructions provided by the software program. Otherwise, follow the instructions below.

1. Open the [Printer Properties](#) dialog box, then select the following settings:

tab	setting
<b>Quality</b>	<b>Paper Type:</b> <b>Automatic</b> or <b>Plain Paper</b>
<b>Layout</b>	<b>Paper Size:</b> Appropriate card size <b>Orientation:</b> Appropriate orientation
<b>Features</b>	<b>Borderless Printing:</b> Select if you wish to use borderless printing. Use A6 setting

2. Select any other desired print settings.
3. After you have selected the print settings, click **OK** .



For a description of available print options, see [print settings](#) .

# photographs

## printing guidelines

- The photo must be in an electronic format (digital) before it can be printed. Take a digital picture, scan a photo, or have your local camera shop provide an electronic file of the photo.
- For best print quality, install a [photo print cartridge](#) in the printer, use a High Resolution print setting, and set the [hp Digital Photography options](#) .
- To print borderless photos, see [borderless printing](#) .
- Use **hp photo papers** for great results.

## preparing to print small photographs



For high-quality photos, install a photo print cartridge in the printer. For instructions on installing a print cartridge, see [replacing print cartridges](#) .

1. Remove the Out tray.
2. Slide out both paper guides, then remove all paper from the In tray.
3. Fan the edges of the photo paper to separate them, then align the photo paper edges.
4. Place no more than 20 sheets of photo paper—printable side down—in the In tray.
5. Push the photo paper forward until it stops.
6. Slide the paper guides *firmly* against the edges of the photo paper.

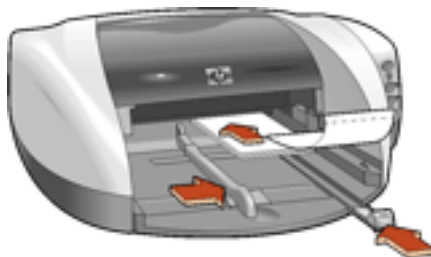

7. Replace the Out tray.

## preparing to print large photographs



For high-quality photos, install a photo print cartridge in the printer. For instructions on installing a print cartridge, see [replacing print cartridges](#) .

1. Raise the Out tray.
2. Slide out both paper guides, then remove all paper from the In tray.
3. Fan the edges of the photo paper to separate them, then align the photo paper edges.
4. Place no more than 20 sheets of photo paper—printable side down—in the In tray.
5. Slide the paper guides *firmly* against the edges of the photo paper.

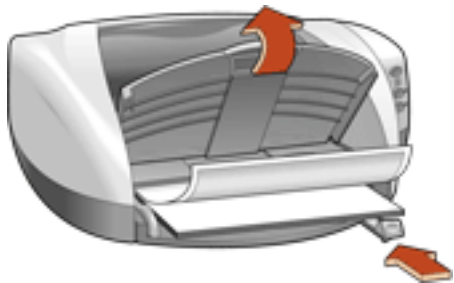

6. Lower the Out tray.

## printing photographs

1. Open the [Printer Properties](#) dialog box, then select the following settings:

tab	setting

<b>Quality</b>	<p><b>Paper Type:</b> Appropriate photo paper type</p> <p><b>Photo Paper Printing:</b></p> <ul style="list-style-type: none"> <li>○ <b>PhotoREt</b> for best print speed and quality, or</li> <li>○ <b>4800 x 1200 Optimized dpi</b> for source images greater than 600 dpi (available on some photo papers; requires 1200 x 1200 input dpi and 400 MB or more hard disk space; takes longer to print)</li> </ul> <p><b>hp Digital Photography:</b> If desired for photo enhancement options</p>
<b>Layout</b>	<p><b>Paper Size:</b> Appropriate paper size</p> <p><b>Borderless Printing:</b> If desired for 4 x 6 inch photos</p>
<b>Features</b>	<p><b>Two-Sided Printing:</b> Unchecked</p>

2. Select any other desired print settings.
3. After you have selected the print settings, click **OK** .



For a description of available print options, see [print settings](#) .



If a photo print cartridge is installed in the printer, replace it with a black print cartridge when you finish printing photographs. For instructions on storing the photo print cartridge when it is not in use, see [maintaining print cartridges](#) .

## greeting cards

### printing guidelines

- Unfold pre-folded cards, then place them in the In tray.
- If an **out of paper** message appears, verify that the cards are positioned properly in the In tray.
- For great results, use hp greeting card paper.

### preparing to print

1. Remove the Out tray.



2. Slide out both paper guides, then remove all paper from the In tray.
3. Fan the edges of the greeting cards to separate them.
4. Align the edges of the cards, then place no more than 5 cards in the In tray.



5. Push the cards forward until they stop.
6. Slide the paper guides *firmly* against the edges of the cards.
7. Replace the Out tray.



## printing greeting cards



If your software program includes a greeting card printing feature, follow the instructions provided with the software program. Otherwise, follow the instructions below.

1. Open the [Printer Properties](#) dialog box, then select the following settings:

tab	setting
<b>Quality</b>	<b>Paper Type:</b> <b>Automatic</b> or appropriate paper type
<b>Layout</b>	<b>Paper Size:</b> Appropriate card size <b>Orientation:</b> Appropriate orientation
<b>Features</b>	<b>Two-Sided Printing:</b> Check if you want to use this feature

2. Select any other desired print settings.
3. After you have selected the print settings, click **OK** .



For a description of available print options, see [print settings](#) .

## posters

### preparing to print

1. Raise the Out tray.
2. Slide out both paper guides, then remove all paper from the In tray.
3. Fan the edges of the sheets to separate them, then align the edges.
4. Place the paper in the In tray.
5. Slide the paper guides *firmly* against the paper.

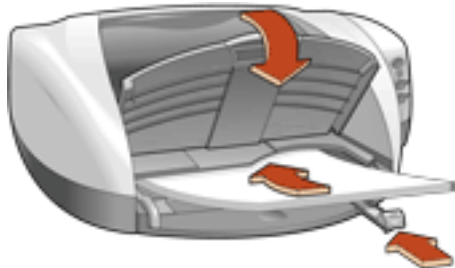

6. Lower the Out tray.

### printing posters

1. Open the [Printer Properties](#) dialog box, then select the following settings:

tab	setting
<b>Quality</b>	<b>Paper Type:</b> <b>Automatic</b> or appropriate paper
<b>Layout</b>	<b>Paper Size:</b> Appropriate size <b>Orientation:</b> Appropriate orientation
<b>Features</b>	<b>Poster Printing:</b> Select this option, then select <b>2 x 2</b> , <b>3 x 3</b> , or <b>4 x 4</b>

2. Select any other desired print settings.



For a description of available print options, see [print settings](#).

3. After you have selected the print settings, click **OK**.
4. After the poster has printed, trim the edges on the sheets, then tape the sheets together.

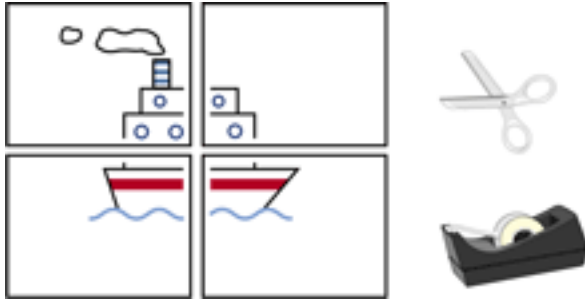



## banners

### printing guidelines

- See the printer *release notes* for specific printing information.
- Use **hp banner paper** for great results.

### preparing to print

1. Raise the Out tray.
2. Slide out both paper guides, then remove all paper from the In tray.
3. Select up to 20 sheets of banner paper. Remove and discard any perforated strips.
4. Place the banner paper in the In tray with the unattached edge of the paper facing the printer.

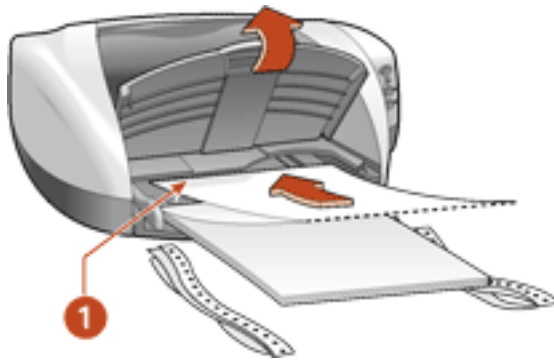

**1. unattached edge**

5. Slide the paper guides *firmly* against the paper.
6. Lower the Out tray.

### printing banners



If your software program includes a banner printing feature, follow the instructions provided with the software program. Otherwise, follow the instructions below.

1. Open the [Printer Properties](#) dialog box, then select the following settings:

tab	setting
<b>Quality</b>	<b>Paper Type: Special Papers: hp banner paper</b> or other banner paper <b>Print Quality: Normal</b>
<b>Layout</b>	<b>Paper Size: Banner [Letter (8.5 x 11 in.)]</b> or <b>Banner [A4 (210 x 297 mm)]</b>

2. Select any other desired print settings.
3. After you have selected the print settings, click **OK** .



For a description of available print options, see [print settings](#) .

## iron-on transfers

### printing guidelines

- When printing a document with a mirror-image, the text and pictures are horizontally reversed from what appears on the computer screen.



- Use **hp iron-on t-shirt transfer paper** for great results.

### preparing to print

1. Raise the Out tray.
2. Slide out both paper guides, then remove all paper from the In tray.
3. Fan the edges of the iron-on transfer paper to separate them, then align the edges.



4. Place the iron-on transfer paper in the In tray with the printable side down.
5. Slide the paper guides firmly against the transfer paper.
6. Lower the Out tray.

### printing iron-on transfers



If your software program includes an iron-on transfer-printing feature, follow the instructions provided with the software program. Otherwise, follow the instructions below.

1. Open the [Printer Properties](#) dialog box, then select the following settings:

tab	setting
<b>Quality</b>	<b>Paper type: Automatic or hp iron-on t-shirt transfers</b> <b>Print Quality: Normal or Best</b>
<b>Layout</b>	<b>Paper Size: A4 (210 x 297 mm) or Letter (8.5 x 11 in.)</b> <b>Orientation: Click Mirror Image</b>

2. Select any other desired print settings.
3. After you have selected the print settings, click **OK** .



For a description of available print options, see [print settings](#) .

## maintenance

- [replacing print cartridges](#)
- [calibrating print cartridges](#)
- [automatically cleaning print cartridges](#)
- [cleaning the print cartridge cradle](#)
- [maintaining print cartridges](#)
- [maintaining the printer body](#)
- [refilling print cartridges](#)
- [removing ink from skin and clothing](#)
- [tools](#)

## replacing print cartridges

Before buying replacement print cartridges, verify the correct part numbers. For the correct part numbers, see [print cartridges](#).



The printer can operate with only one print cartridge installed. For more information, see [reserve mode](#).

To replace a print cartridge:

1. Press the **Power** button to turn on the printer.
2. Open the top cover.  
The cradle moves to the center of the printer.
3. Open the cradle latch.
4. Slide the print cartridge out of the print cartridge cradle and discard it.

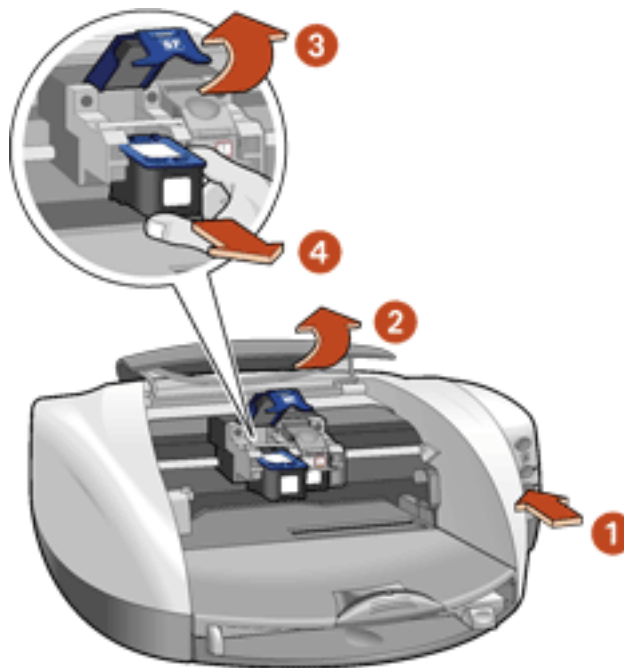

**1. press Power button 2. open top cover 3. open cradle latch 4. slide print cartridge out of cradle**

5. Remove the replacement print cartridge from its packaging and carefully remove the plastic tape. Hold the print cartridge so that the copper strip is on the bottom.

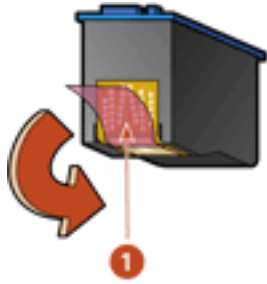

**1. pink pull tab**

**Caution!** Do not touch the print cartridge ink nozzles or copper contacts. Touching these parts will result in clogs, ink failure, and bad electrical connections. Do not remove the copper strips. They are required electrical contacts.

6. Slide the print cartridge firmly into the cradle as shown.

Ensure that the copper contacts of the print cartridge meet the copper contacts of the print cartridge cradle.

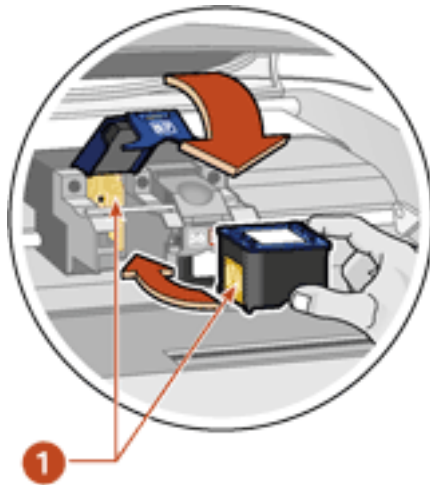

**1. copper contacts**

7. Close the cradle latch. Pull the latch forward, then press it down to tuck the tabs into place.
8. Close the top cover.

If the Print Cartridge Status light continues to blink after installing a new print cartridge, verify the [part number](#) on the cartridge.

After you change the print cartridge, the printer is automatically calibrated for optimum print quality.

For information on how to recycle your empty print cartridge, see [print cartridge recovery](#).



**Warning!** Keep both new and used print cartridges out of the reach of children.



## refilling print cartridges



To get the best performance from your HP printer, use only genuine, factory-filled HP print cartridges.

**Caution!** Damage that is directly attributable to modified or refilled HP print cartridges is specifically excluded from the HP printer's warranty coverage.

## calibrating print cartridges

After you install a print cartridge, the printer automatically calibrates the print cartridges to ensure the best print quality. However, if the black and color print cartridges become misaligned during the course of printing, you may wish to manually calibrate the cartridges.

The instructions for calibrating the print cartridges vary according to how the printer was installed on your computer.

To view the correct instructions, answer the following question:

### Does this icon appear on your computer's desktop?



- [Yes](#) (use printer assistant)
- [No](#) (use printer properties)



If the **Yes** option does not work, double-click the **printer assistant** icon on your computer's desktop, then click **Tools and Updates** .

## calibrating using printer properties

To calibrate print cartridges from printer properties:

1. Open [Printer Properties](#) .
2. Select the **Services** tab.
3. Click the **Open the HP Toolbox** button.
4. Click **Calibrate the Device** , then follow the onscreen instructions.

## automatically cleaning print cartridges

If your printed pages are missing lines or dots or if streaks appear, the print cartridges need to be cleaned.

The instructions for cleaning the print cartridges vary according to how the printer was installed on your computer. To view the correct instructions, answer the following question:

**Does this icon appear on your computer's desktop?**



- [Yes](#) (use printer assistant)
- [No](#) (use printer properties)



If the **Yes** option does not work, double-click the **printer assistant** icon on your computer's desktop, then click **Tools and Updates** .

## cleaning using printer properties

To clean the print cartridges from printer properties:

1. Open [Printer Properties](#) .
2. Select the **Services** tab.
3. Click the **Open the HP Toolbox** button.
4. Click **Clean the Print Cartridges** , then follow the onscreen instructions.

If your printouts are still missing lines or dots after cleaning, a print cartridge may be low on ink. If so, one or both print cartridges may need to be replaced.



If a print cartridge is low on ink and you do not have a replacement cartridge available, use the printer in [reserve mode](#) .

## cleaning the print cartridge cradle

If the printer is used in a dusty environment, a small amount of debris may accumulate inside the case. This debris can include dust, hair, carpet, or clothing fibers. When it gets on the print cartridge cradle, it can cause smudges on printed pages. Smudges are easily corrected by cleaning the print cartridge cradle.

### gathering cleaning supplies

You will need the following items to clean the print cartridge cradle:

- Distilled water. Tap water contains contaminants that damage the cradle.
- Cotton swabs or other soft, lint-free material that will not stick to the cradle.

Be careful not to get ink on your hands or clothing as you clean.

### preparing to clean

1. Press the **Power** button to turn on the printer, then raise the top cover.  
The print cartridges move to the center of the printer.
2. Disconnect the power cord from the back of the printer.
3. Remove the print cartridges and place them on a piece of paper with the copper contacts facing up.

Do not leave the cartridges outside the printer for more than 30 minutes.

**Caution!** Do not touch the print cartridge ink nozzles or copper contacts. Touching these parts will result in clogs, ink failure, and bad electrical connections. Do not remove the copper strips. They are required electrical contacts.

### cleaning the print cartridge cradle

1. Lightly moisten a cotton swab with distilled water.
2. Wipe the underside of the print cartridge cradle walls using the swab.

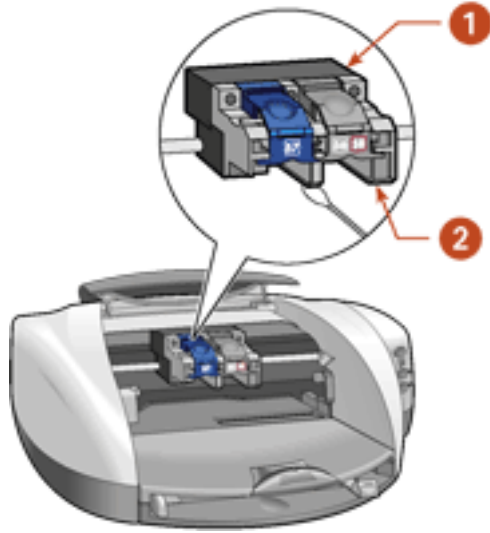

**1. print cartridge cradle 2. print cartridge cradle walls**

3. Repeat this process until no ink residue appears on a clean swab.
4. Reinsert the print cartridges and close the printer's top cover.
5. Reconnect the power cord to the back of the printer.

## maintaining print cartridges

The following tips will help maintain HP print cartridges and ensure consistent print quality:

- Keep all print cartridges in their sealed packages until they are needed. Print cartridges should be stored at room temperature (60–78 degrees F or 15.6–26.6 degrees C).
- Do not remove the plastic tape covering the ink nozzles until you are ready to install the print cartridge in the printer. If the plastic tape has been removed from the print cartridge, do not attempt to reattach it. Reattaching the tape damages the print cartridge.

## storing print cartridges

When print cartridges are removed from either their sealed containers or the printer, store them in a print cartridge protector or an airtight plastic container.

A print cartridge protector comes with the photo print cartridge. If you store the print cartridge in an airtight plastic container make sure that the ink nozzles face down.

### **inserting the print cartridge into the print cartridge protector**

Slide the print cartridge at a slight angle into the protector, and snap it securely in place.



### **removing the print cartridge from the print cartridge protector**

Press down and back on the top of the protector to release the cartridge. Slide the cartridge out of the protector.

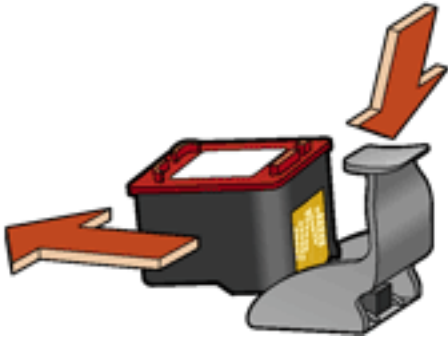

**Caution!** Do not drop the print cartridge. Dropping the print cartridge may result in damage to the print cartridge.

## maintaining the printer body

Because the printer ejects ink onto the paper in a fine mist, ink smudges will eventually appear on the printer case and adjacent surfaces. To remove smudges, stains, and/or dried ink from the exterior of the printer, use a soft cloth moistened with water.

When cleaning your printer, keep these tips in mind:

- **Do not** clean the interior of the printer. Keep all fluids away from the interior.
- **Do not** use household cleaners or detergent. In the event that a household cleaner or detergent is used on the printer, wipe the printer's exterior surfaces with a soft cloth moistened with water.
- **Do not** lubricate the support rod that the print cartridge cradle uses to slide back and forth. Noise is normal when the cradle moves back and forth.



## removing ink from skin and clothing

Follow these steps to remove ink from skin and clothing:

to remove ink from...	do this...
skin	Wash the affected area with an abrasive soap.
white fabric	Wash the fabric in <b>cold</b> water using chlorine bleach.
color fabric	Wash the fabric in <b>cold</b> water using sudsy ammonia.

**Caution!** Always use cold water to remove ink from fabric. Warm or hot water may set the ink color into the fabric.

## tools

The printer software contains a number of useful tools to enhance the printer's performance.

To access the tools, answer the following question:

### Does this icon appear on your computer's desktop?



- [Yes](#) (use printer assistant)
- [No](#) (use printer properties)



If the **Yes** option does not work, double-click the **printer assistant** icon on your computer's desktop, then click **Tools and Updates** .

## using the printer properties

### accessing the printer properties

1. Open the [Printer Properties](#) dialog box.
2. Click the **Services** tab. If you do not see the Services tab, then use [tools and updates](#) .
3. Click the **Open the HP Toolbox** button.

### using the hp toolbox

The hp toolbox has two tabs:

- Device services
- Configuration

### device services

The following tools are available on the Device Services tab:

- **Calibrate the Device:** Calibrate the print cartridges.

- **Clean the Print Cartridges:** Clean the print cartridges.
- **Print a Test Page:** Print a test page to see if the printer can receive data.
- **Print a Diagnostic Page:** Print a diagnostic page when the HP Customer Care Center requests it.

## **configuration**

The following tools are available on the Configuration tab:

- **Accessories:** Activate the Automatic Two-Sided Printing Module if it is installed on the printer.
- **Messages:** Configure software messages.
- **Performance:** Manage the Auto-off feature.

## troubleshooting

Click the topic below that best describes the problem:

- [printer is not printing](#)
- [problems with printouts](#)
- [printer lights are flashing or on](#)
- [printer is too slow](#)
- [borderless printing problems](#)

If you continue to have problems after investigating the above topics, contact [HP Customer Care](#) .

## printer is not printing

### verify the following

- The printer is connected to the power source.
- The cable connections are secure.
- The printer is turned on.
- The media is correctly placed in the paper tray.
- The printer's top cover is closed.
- The duplexer or Rear Access Door is attached.
- The print cartridges are correctly installed.

### check the printer lights

- If the **Power** light is blinking, the printer is in the process of printing.
- If the **Resume** light is blinking, press the **Resume** button.
- If the **Print Cartridge Status** light is blinking, see [print cartridge status light is flashing](#).
- If the **Print Cartridge Status** light is on, see [print cartridge status light is on](#).

### select a topic below

If the printer still does not print, select the topic below that best describes the problem:

- [printer makes a loud noise after a print cartridge is installed](#)
- [paper problems](#)
- [USB problems](#)
- [printer does not turn on](#)

## printer makes a loud noise after a print cartridge is installed

If the print cartridge is installed backward, the printer will make a loud noise.

1. Open the top cover.
2. Remove the print cartridge, then reinsert it as shown. Ensure that the copper contacts of the print cartridge meet the copper contacts of the print cartridge cradle.

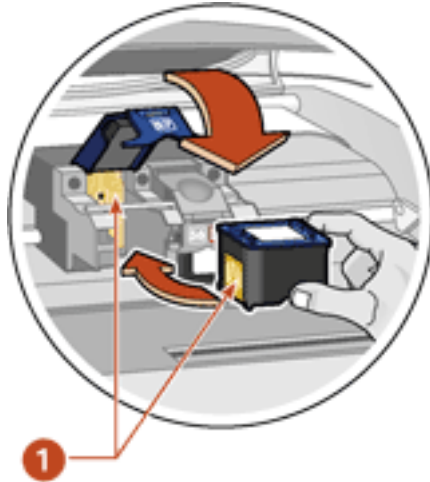

### 1. Copper contacts

**Caution!** Do not touch the print cartridge ink nozzles or copper contacts. Touching these parts will result in clogs, ink failure, and bad electrical connections. Do not remove the copper strips. They are required electrical contacts.

3. Close the top cover.
4. Press the **Resume** button.



Wait until the Power light stops flashing before printing a file.

## paper problems

Click the topic below that best describes the problem:

- [paper jam](#)
- [out of paper](#)
- [printer ejects the paper](#)

## paper jam

Follow each of these steps until the paper jam is cleared.

1. Remove the paper from the In and Out trays.
2. Press the **Resume** button.
3. If you are printing labels, verify that a label did not become detached from the label sheet while passing through the printer.

If the paper jam is not cleared after performing these steps:

1. Open the Rear Access Door by turning the latch counter-clockwise and removing the door.

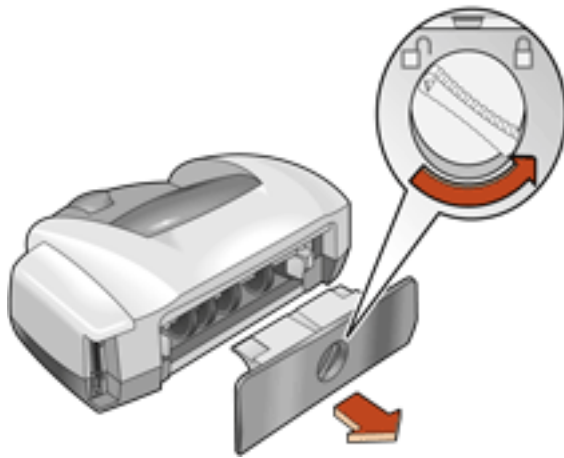

2. Remove the paper jam, then replace the Rear Access Door.

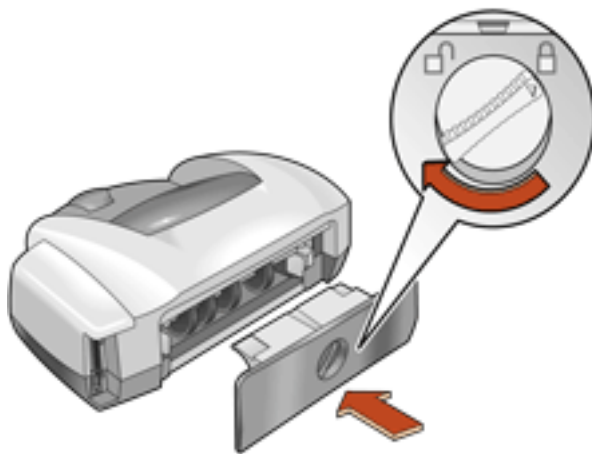

3. Reload paper into the In tray.
4. Press the **Resume** button.
5. Print the document.

## out of paper

### if the paper tray is loaded

1. Adjust the length guide so that the paper stack touches the back of the paper tray.
2. Slide the paper forward until it stops.
3. Press the **Resume** button.

### if the paper tray is empty

1. Load paper in the tray.
2. Press the **Resume** button.

## printer ejects the paper

- Move the printer away from direct sunlight. The printer may have been placed in direct sunlight which can affect the Automatic Paper-Type Sensor.

—or—

- Select a paper type other than **Automatic** .

## USB problems

### the error message “there was an error writing to LPT1” appears

The USB cable may not have been attached before installing the software. [Uninstall](#) , then reinstall, the software.

To uninstall the software:

- Click [here](#) .

-or-

- Click **Start** > **Programs** > **Hewlett-Packard** > **[hp deskjet]** > **uninstall software** , then follow the onscreen instructions.

### the error message “there was an error writing to <name of USB port>” appears

The printer may not be receiving correct data from another USB device or the hub. Connect the printer directly to the USB port on the computer.



## there are conflicting USB cable connections

A printing conflict may arise when the printer and several USB devices are attached to a hub. There are two methods for solving the conflict:

- Attach the printer's USB cable directly to the computer.

—or—

- If the printer is attached to a hub, do not use other USB devices attached to the hub while printing.

## printer does not turn on

The printer may have drawn too much power.

1. Disconnect the power cord from the printer.
2. Wait approximately 10 seconds.
3. Reconnect the power cord to the printer.
4. Press the **Power** button to turn on the printer.

## problems with printouts

Click the topic below that best describes the problem:

- [print quality is poor](#)
- [text and images are misaligned](#)
- [document is printed off-center or at an angle](#)
- [parts of the document are missing or printed in the wrong place](#)
- [printout does not reflect new print settings](#)
- [photos are not printing correctly](#)
- [banner does not print correctly](#)
- [blank pages print](#)

### print quality is poor

- [print cartridges need to be cleaned](#)
- [print is faded](#)
- [too much or too little ink appears on the page](#)

### print cartridges need to be cleaned

If your printed pages are missing lines or dots or if streaks appear, the print cartridges need to be cleaned.

For cleaning instructions, see [automatically cleaning print cartridges](#) .

### print is faded

1. Verify that a black print cartridge is installed. If the black text and images on your printouts are faded, you may be printing using only the tri-color print cartridge. Insert a black print cartridge, in addition to the tri-color print cartridge, for true black print resolution.
2. Verify that neither of the print cartridges is low on ink. If a print cartridge is low on ink, consider replacing the print cartridge.



If you do not have a replacement cartridge, remove the low-ink cartridge and use the printer in the [reserve mode](#) .

3. Verify that the plastic tape has been removed from both print cartridges.

### too much or too little ink appears on the page

In the Printer Properties box, select a paper type other than **Automatic** .

### text and images are misaligned

If the text and images on your printouts are misaligned, then [calibrate](#) the printer.

### document is printed off-center or at an angle

1. Verify that the paper is correctly placed in the In tray.
2. Verify that the paper guides fit snugly against the paper.
3. Reprint the document.

### parts of the document are missing or printed in the wrong place

Follow the [basic printing instructions](#) and verify the following options:

tab	setting
<b>Layout</b>	<p><b>Paper Size:</b> Verify the appropriate paper size and margins</p> <p><b>Scale to Fit:</b> Select to scale text and graphics to fit on the paper</p> <p><b>Orientation:</b> Verify the appropriate orientation</p>
<b>Features</b>	<p><b>Poster Printing:</b> Deselect this option if not printing a poster</p>

### printout does not reflect new print settings

The printer's default settings may differ from the software application's print settings. Select the appropriate print settings within the software application.

## photos are not printing correctly

1. Verify that the photo media is placed in the In tray with the print side down.
2. Slide the paper forward until it stops.
3. Slide the paper guides snugly against the paper, then push in the In tray.

### check the printer properties

Follow the [basic printing instructions](#) and verify the following options:

tab	setting
Quality	<b>Print Quality: Best</b> <b>Paper Type: An hp photo paper</b>
Layout	<b>Paper Size: Appropriate size</b>

## banner does not print correctly

### check the paper tray

- Unfold and refold the paper when several sheets feed into the printer at once.
- Confirm that the unattached edge of the banner paper stack is on top and facing the printer.
- Verify that the correct paper for banner printing is used.

### check the printer properties

Follow the [basic printing instructions](#) and verify the following setting:

tab	setting
Quality	<b>Paper Type: Special Papers</b> , then select <b>hp banner paper</b>

<b>Layout</b>	<b>Paper Size:</b> Appropriate banner paper
---------------	---

### check the software

- Verify that the software application you are using prints banners. Not all software applications print banners.
- If gaps appear at the ends of the sheets, verify that the printer software is operating correctly.
- Click **Start > Programs > Hewlett-Packard > [ hp deskjet series ] > release notes** to view *Release Notes* for known software issues.

### blank pages print

- The protective piece of plastic tape may still be attached to the print cartridges. Verify that the plastic tape has been removed from the print cartridges.
- The print cartridges may be out of ink. Replace one or both empty print cartridges.
- The printer may be in direct sunlight. Direct sunlight can adversely affect the Automatic Paper-Type Sensor. Move the printer out of direct sunlight.

## printer lights are flashing or on

- [what the flashing lights indicate](#)
- [Print Cartridge Status light is on](#)
- [Print Cartridge Status light is flashing](#)
- [Resume light is flashing](#)
- [Power light is flashing](#)
- [all lights are flashing](#)

### what the lights indicate

Flashing or on lights indicate the printer status.

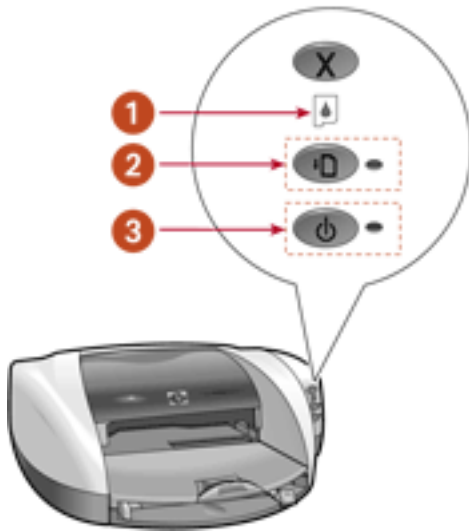

**1. Print Cartridge Status light 2. Resume light 3. Power light**

### Resume light is flashing

**the printer may be out of paper**

1. Place paper in the In tray.
2. Press the **Resume** button on the front of the printer.

**there may be a paper jam**

Follow these instructions [to clear a paper jam](#) .

## **the printer may be ready to print the second side of a two-sided document**

1. Follow the onscreen instructions for printing the second side.  
These instructions appear when you print a [two-sided document](#).
2. Press the **Resume** button.

## **Power light is flashing**

### **the printer is preparing to print**

The light stops flashing when the printer has received all data.

## **all lights are flashing**

### **the printer may need to be restarted**

1. Press the **Power** button to turn off the printer, then press the **Power** button to restart the printer.  
Proceed to step 2 if the lights continue to flash.
2. Press the **Power** button to turn off the printer.
3. Disconnect the printer from the power source.
4. Reconnect the printer to the power source.
5. Press the **Power** button to turn on the printer.

## printer is slow

Several variables can slow the printer's performance. Click the topic below that best describes the printer's performance:

- [multiple software applications are open](#)
- [complex documents, graphics, or photographs are printing](#)
- [automatic paper type option is enabled](#)
- [two-sided documents are printing](#)

If none of the above topics describes the printer's performance, then review the following:

- [printer driver is outdated](#)
- [computer does not meet system requirements](#)
- [printer is in reserve mode](#)

### multiple software applications are open

If too many software applications are open, the printer cannot print at its optimum speed.

Close all unnecessary software applications, then print the document again.

### complex documents, graphics, or photographs are printing

Documents containing graphics or photographs print slower than text documents.

1. Open the **Printer Properties** dialog box.
2. On the Quality tab, select **PhotoREt** .
3. Reprint the document.
4. If the document still prints too slowly, then Open the **Printer Properties** dialog box.
5. Click the **Features tab** , then click **Advanced Features** .
6. Select the **Low Memory Mode** option.
7. Reprint the document.



Print quality may be reduced if you use Low Memory Mode.

### **automatic paper type option is enabled**

When the automatic paper type option is enabled, it takes a few seconds for the printer to scan the first page of the print job to determine the appropriate paper type.

To increase the print speed, turn off the Automatic Paper-Type Sensor.

For instructions on turning off the Automatic Paper-Type Sensor, see [using the automatic paper-type sensor](#).

### **two-sided documents are printing**

Printing two-sided documents takes more time than printing single-sided documents.

### **printer driver is outdated**

An outdated printer driver may be installed.

For information about updating the printer driver, click [here](#).

### **computer does not meet system requirements**

1. Verify that the computer's hard disk space, RAM, and processor speed meet system requirements.

For more information, see [system requirements](#).

2. Increase free space on the hard drive.

If your computer does not have enough RAM, or a large amount of free space on the hard drive, the printer processing time will be longer.

### **printer is in reserve mode**

The printer may print more slowly if it is in reserve mode.

Order a [replacement print cartridge](#).

## borderless printing problems

### image is printed at angle

**if your printout looks like this...**



**do this...**

1. Load the paper correctly in the In tray.
2. Verify that the paper guides fit *firmly* against the cards or photo paper.
3. Follow loading instructions for the paper type. See [borderless printing](#).

### border is on top of image

**if your printout looks like this...**



**do this...**

[Calibrate the printer](#) .

**border is on side of image**

**if your printout looks like this...**



**do this...**

[Calibrate the printer](#) .

**image is above tear-off tab**

**if your printout looks like this...**



**do this...**

## [Calibrate the printer .](#)

### ink smears

#### **if your printout has ink smears...**

If ink smears appear on the back of the printouts or if the paper sticks together...

#### **do this...**

1. Open the **Printer Properties** dialog box.
2. Select the **Features** tab.
3. Click **Advanced Features** .
4. Slide the **Dry Time** pointer to the right.
5. Click **OK > OK** .

If the problem persists:

1. Remove the borderless printing media, then load plain letter or A4 paper in the In tray.
2. Press and hold down the **Resume** button until the printer starts printing a self-test page, then release the **Resume** button.
3. Repeat step 2 until the self-test page has no ink smears on the back of the paper.

## specifications

- [printer specifications](#)
- [minimum printing margins](#)
- [minimum system requirements](#)
- [environmental statement](#)
- [print cartridge recovery](#)
- [limited warranty](#)
- [regulatory notices](#)

# printer specifications

## hp deskjet 5550 series

### black text print speed \*

FastDraft: Up to 17 pages per minute

Everyday: Up to 8 pages per minute

Normal: Up to 6 pages per minute

Inkjet Paper/Best/1200 dpi text rendering: Up to 2 pages per minute

### mixed text with color graphics print speed\*

FastDraft: Up to 12 pages per minute

Everyday: Up to 6 pages per minute

Normal: Up to 4 pages per minute

Inkjet Paper/Best/1200 dpi text rendering: Up to 0.5 page per minute

\*These are approximate figures. Exact speed varies with system configuration, software program, and document complexity.

### black TrueType <sup>TM</sup> text resolution (depending on paper type)

Plain Paper/FastDraft: 300 x 300 dpi

Plain Paper/Everyday: 300 x 300 dpi

Plain Paper/Normal: 600 x 600 dpi

Inkjet Paper/Best/1200 dpi text rendering: 1200 x 1200 dpi

### color input resolution (depending on paper type)

Plain Paper/FastDraft: 300 x 300 dpi

Plain Paper/Everyday: 300 x 300 dpi

Plain Paper/Normal: 600 x 600 dpi

Inkjet Paper/Best/1200 dpi text rendering: 1200 x 1200 dpi

### **color printing resolution (subject to color input resolution above)**

Plain Paper/FastDraft: 600 x 300 dpi

Plain Paper/Everyday: 600 x 600 dpi

Plain Paper/Normal: 600 x 600 dpi

Inkjet Paper/Best/1200 dpi text rendering: 1200 x 1200 dpi

### **4800 x 1200 optimized dpi resolution**

4800 x 1200 optimized dpi color printing on premium photo papers; 1200 x 1200 input dpi; will require a large amount of disk space and take longer to print.

### **color and photo print cartridges**

Up to 6 ink printing

(Requires hp photo print cartridge #58)

For more information, see [print cartridges](#).

### **print technology**

Drop-on-demand thermal inkjet printing

### **software compatibility**

MS Windows compatible (95, 98, Me, 2000, NT 4.0, and XP)

### **duty cycle**

3000 pages per month

### **memory**

8 MB built-in RAM

### **processor**

96 MHz processor

## **buttons and lights**

Cancel button

Print Cartridge Status light

Resume button and light

Power button and light

## **i/o interface**

Centronics Parallel, IEEE 1284-Compliant with 1284-B receptacle

Universal Serial Bus (USB) 2.0 compatible

## **dimensions**

Without Automatic Two-Sided Printing Module:

449 mm wide x 144 mm high x 368 mm deep

## **operating environment**

Maximum operating conditions:

Temperature: 41 to 104 degrees F, 5 to 40 degrees C

Humidity: 15 to 80 percent RH non-condensing

Recommended operating conditions for best print quality:

Temperature: 59 to 95 degrees F or 15 to 35 degrees C

Humidity: 20 to 80 percent RH non-condensing

Storage conditions:

Temperature: -40 to 158 degrees F, -40 to 70 degrees C

## **power consumption**

2 watts maximum when off

4 watts average non-printing

30 watts average when printing



## power requirements

For power adapter part number 0950-4081 the power requirements are:

Input Voltage: 120 ( $\pm$  10%)

Input Frequency: 60 Hz ( $\pm$  3 Hz)

For power adapter part number 0950-4082 the power requirements are:

Input Voltage: 100 to 240 Vac ( $\pm$  10%)

Input Frequency: 50–60 Hz

## declared noise emissions in accordance with ISO 9296

### **Best Mode:**

Sound power level, LWAd without Automatic Two-Sided Printing Module: 5.3 Bels (A)  
[53 dB (A)]

Sound pressure level, LpAm (bystander positions) without Automatic Two-Sided Printing Module: 40 dB (A)

### **Normal Mode:**

Sound power level, LWAd without Automatic Two-Sided Printing Module: 5.9 Bels(A) [59 dB (A)]

Sound pressure level, LpAm (bystander positions) without Automatic Two-Sided Printing Module: 47 dB (A)

## alignment

Skew:

$\pm$  .006 mm/mm (.006 in/in) on plain paper and cards

$\pm$  .010 mm/mm (.010 in/in) on HP transparency films

## media weight

Paper:

U.S. Letter 60 to 90 g/m<sup>2</sup> (16 to 24 lb)

Legal 75 to 90 g/m<sup>2</sup> (20 to 24 lb)

Envelopes: 75 to 90 g/m<sup>2</sup> (20 to 24 lb)

Cards: Up to 200 g/m<sup>2</sup> (110 lb index max)

Banner paper: 60 to 90 g/m<sup>2</sup> (16 to 24 lb)

## media handling

### **In tray capacity:**

Plain paper sheets: Up to 100

Banners: Up to 20 sheets

Envelopes: Up to 15

Greeting cards: Up to 5 cards

Labels: Up to 20 sheets of labels (use only U.S. Letter or A4-sized sheets)

Photo paper: Up to 25 sheets

Index cards: Up to 40 cards

Hagaki cards: Up to 40 cards

Transparencies: Up to 25

### **Out tray capacity:**

FastDraft: Up to 35 sheets

Normal: Up to 50 sheets

Best: Up to 50 sheets

## media size

### **Paper:**

U.S. Letter 216 x 279 mm (8.5 x 11 in)

Legal 216 x 356 mm (8.5 x 14 in)

Executive 184 x 267 mm (7.25 x 10.5 in)

A4 210 x 297 mm

A5 148 x 210 mm

B5 182 x 257 mm

Photo L 89 x 127 mm (Japan)

User Defined:

Width 77 to 215 mm (3.0 to 8.5 in)

Length 127 to 355 mm (5.0 to 14 in)

**Banner:**

U.S. Letter 216 x 279 mm (8.5 x 11 in)

A4 210 x 297 mm

**Envelopes:**

U.S. No. 10 105 x 241 mm (4.12 x 9.5 in)

Invitation A2 111 x 146 mm (4.38 x 5.75 in)

DL 110 x 220 mm (8.66 x 4.33 in)

C6 114 x 162 mm (4.48 x 6.38in)

**Index/Greeting Cards:**

76 x 127 mm (3 x 5 in)

102 x 152 mm (4 x 6 in)

127 x 203 mm (5 x 8 in)

A6 Cards: 105 x 148.5 mm

Hagaki: 100 x 148 mm

L size: 89 x 127 mm

**Labels:**

U.S. Letter 216 x 279 mm (8.5 x 11 in)

A4 210 x 297 mm

**Transparencies:**

U.S. Letter 216 x 279 mm (8.5 x 11 in)

A4 210 x 297 mm

**Photo (with tear-off tab):**

102 x 152 mm (4 x 6 in)

**print cartridges**

Black: selection number 56, part number c6656a

Tri-Color: selection number 57, part number c6657a

Photo: selection number 58, part number c6658a

## minimum printing margins

The printer cannot print outside a designated area of the page. Minimum print margins for common media types are shown below.

### A4 paper

Left and Right Margins: 3.4 mm (0.134 in)

Top Margin: 1.8 mm (0.07 in)

Bottom Margin: 11.7 mm (0.46 in)

### letter, legal, and executive paper

Left and Right Margins: 6.4 mm (0.25 in)

Top Margin: 1.8 mm (0.07 in)

Bottom Margin: 11.7 mm (0.46 in)

### A5, B5, and user defined paper

Left and Right Margins: 3.2 mm (0.125 in)

Top Margin: 1.8 mm (0.07 in)

Bottom Margin: 11.7 mm (0.46 in)

### cards (3 x 5 in, 4 x 6, 5 x 8, and A6)

Left and Right Margins: 3.2 mm (0.125 in)

Top Margin: 1.8 mm (0.07 in)

Bottom Margin: 11.7 mm (0.46 in)

### Hagaki postcards

Left and Right Margins: 3.2 mm (0.125 in)

Top Margin: 1.8 mm (0.07 in)

Bottom Margin: 11.7 mm (0.46 in)

### envelopes

**Left and Right Margins: 3.2 mm (0.125 in)**

**Top Margin: 1.8 mm (0.07 in)**

**Bottom Margin: 11.7 mm (0.46 in)**

**banners - A4 (210 x 297 mm [8.27 x 11.7 in])**

**Left and Right Margins: 3.4 mm (0.134 in)**

**Top Margin: 1.8 mm (0.07 in)**

**Bottom Margin: 11.7 mm (0.46 in)**

**Between Page Margin: 0.0 mm (0.0 in)**

**banners - letter (216 x 279 mm [8.5 x 11 in])**

**Left and Right Margins: 6.4 mm (0.25 in)**

**Top Margin: 1.8 mm (0.07 in)**

**Bottom Margin: 11.7 mm (0.46 in)**

**Between Page Margin: 0.0 mm (0.0 in)**

## minimum system requirements

Your computer must meet the following minimum requirements to use the printer:

### Microsoft Windows XP

Minimum Processor Speed: Pentium 233 MHz

Required RAM: 128 MB

Required Free Hard Disk Space: 40 MB\*

### Microsoft Windows NT 4.0 or 2000

Minimum Processor Speed: Pentium 133 MHz

Required RAM: 64 MB

Required Free Hard Disk Space: 40 MB\*

### Microsoft Windows 95, 98, or Me

Minimum Processor Speed: Pentium 150 MHz

Required RAM: 32 MB

Required Free Hard Disk Space: 40 MB\*

\* If you are printing photographs or are printing at 4800 x 1200 dpi, you must have a large amount of free hard disk space available.

## environmental statement

Hewlett-Packard continuously improves the design processes of its deskjet printers to minimize the negative impact on the office environment and on the communities where printers are manufactured, shipped, and used.

### reduction and elimination

**Paper use:** The printer's automatic/manual two-sided printing capability reduces paper usage and the resulting demands on natural resources. This printer is suited for the use of recycled papers in accordance with DIN 19 309.

**Recycled paper:** All paper documentation for this printer is printed on chlorine-free recycled paper.

**Ozone:** Ozone-depleting chemicals such as CFCs have been eliminated from Hewlett-Packard's manufacturing processes.

### recycling

Design for recycling has been incorporated into this printer. The number of materials has been kept to a minimum while ensuring proper functionality and reliability. Dissimilar materials have been designed to separate easily. Fasteners and other connections are easy to locate, access, and remove using common tools. High priority parts have been designed to access quickly for efficient disassembly and repair.

**Printer packaging:** The packaging materials for this printer have been selected to provide maximum protection for the least cost possible, while attempting to minimize environmental impact and facilitate recycling. The rugged design of the HP Deskjet printer assists in minimizing both packaging materials and damage rates.

**Plastic parts:** All major plastics and plastic parts are marked according to international standards. All plastic parts used in the printer housing and chassis are technically recyclable and all use a single polymer.

**Product longevity:** To ensure the longevity of your HP Deskjet printer, HP provides the following:

- **Extended warranty:** See [limited warranty](#).
- **Replacement parts and consumables** are available for three (3) years after production has stopped (five (5) years in Germany).
- **Product take-back:** To return this product to HP at the end of its useful life, go to [www.hp.com/go/recycle](http://www.hp.com/go/recycle). To return empty print cartridges to HP, see [hp print cartridge recovery program](#).

## energy consumption

This printer was designed with energy conservation in mind. This printer averages 4 watts in stand-by mode. Not only does this save natural resources, but it also saves money without affecting the high performance of the printer.

This product qualifies for the ENERGY STAR® Program (U.S. and Japan). ENERGY STAR is a voluntary program established to encourage the development of energy-efficient office products.



ENERGY STAR is a US registered service mark of the USEPA. As an ENERGY STAR partner, Hewlett-Packard Company has determined that this product meets ENERGY STAR Guidelines for energy efficiency.

**Energy consumption in off-mode:** When the printer is off, a minimal amount of energy is still being consumed. Energy consumption can be prevented by turning the printer power off, then disconnecting the end of the printer power cord from the electrical source.



## print cartridge recovery

Customers interested in recycling their genuine HP print cartridges can participate in HP's empty print cartridge return and recycle program. HP offers this program in the United States, Puerto Rico, France, Germany, and Singapore, more countries than any other print cartridge manufacturer in the world. This program is provided as a free service to HP customers as an environmentally sound solution for these products at end-of life.

To participate, simply request postage-paid return envelopes or bulk boxes via the Web at [www.hp.com/go/recycle](http://www.hp.com/go/recycle). Customers will be asked for their name, phone number, address, and how many bulk boxes or envelopes they would like. Postage-paid envelopes and/or bulk boxes will be shipped within two days.

Because HP's unique recycling processes are very sensitive to material contamination, we cannot take back and recycle cartridges from other manufacturers. The end products of the recycling process are used in the manufacture of new products, and HP must ensure the composition of the material is consistent. To do that, we recycle only HP original cartridges. This program does not extend to refilled cartridges.

Returned cartridges are separated for purification into raw materials for use in other industries to manufacture new products. Examples of products made from recycled HP print cartridge materials include automobile parts, trays used in microchip fabrication processes, copper wire, steel plates, and the precious materials used in electronics. Depending on the model, HP is able to recycle up to 65% of the print cartridge by weight. The remaining parts that cannot be recycled (ink, foam and composite parts) are disposed of in an environmentally responsible manner.

## limited warranty

region	software	printer
North America (including Canada)	90 days	1 year
Asia Pacific	90 days	1 year
Europe	90 days	1 year
Latin America	90 days	1 year

### extent of limited warranty

Hewlett-Packard (HP) warrants to the end-user customer that the HP products specified above will be free from defects in materials and workmanship for the duration specified above, which duration begins on the date of purchase by the customer. Customer is responsible for maintaining proof of date of purchase.

1. For software products, HP's limited warranty applies only to a failure to execute programming instructions. HP does not warrant that the operation of any product will be uninterrupted or error free.
2. HP's limited warranty covers only those defects which arise as a result of normal use of the product, and do not apply to any:
  - Improper or inadequate maintenance or modification;
  - Software, interfacing, media, parts, or supplies not provided or supported by HP; or
  - Operation outside the product's specifications.
  - For HP printer products, the use of a non-HP ink cartridge or a refilled ink cartridge does not affect either the warranty to the customer or any HP support contract with the customer. However, if printer failure or damage is attributable to the use of a non-HP or refilled ink cartridge, HP will charge its standard time and materials charges to service the printer for the particular failure or damage.
3. If HP receives, during the applicable warranty period, notice of a defect in any software, media, or ink cartridge covered by HP's warranty, HP shall replace the defective product. If HP receives notice of a defect in any hardware product

covered by HP's warranty during the applicable warranty period, HP shall either repair or replace the defective product at HP's option.

4. If HP is unable to repair or replace, as applicable, a defective product covered by HP's warranty, HP shall, within a reasonable time after being notified of the defect, refund the purchase price of the product.
5. HP shall have no obligation to repair, replace, or refund until the customer returns the defective product to HP.
6. Any replacement product may be either new or like-new, provided that it has functionality at least equal to that of the product being replaced.
7. HP's limited warranty is valid in any country where the covered HP product is distributed by HP except for the Middle-East, Africa, Argentina, Brazil, Mexico, Venezuela, and France's "Departements D'Outre-Mer"; for those excepted areas, the warranty is valid only in the country of purchase. Contracts for additional warranty services, such as on-site service, may be available from any authorized HP service facility where the product is distributed by HP or by an authorized importer.
8. Any applicable print cartridge warranty shall not apply to HP print cartridges that have been refilled, remanufactured, refurbished, misused, or tampered with in any way.

## limitations of warranty

1. TO THE EXTENT ALLOWED BY LOCAL LAW, NEITHER HP NOR ITS THIRD PARTY SUPPLIERS MAKE ANY OTHER WARRANTY OR CONDITION OF ANY KIND, WHETHER EXPRESS OR IMPLIED, WITH RESPECT TO THE HP PRODUCTS, AND SPECIFICALLY DISCLAIM THE IMPLIED WARRANTIES OR CONDITIONS OF MERCHANTABILITY, SATISFACTORY QUALITY, AND FITNESS FOR A PARTICULAR PURPOSE.

## limitations of liability

1. To the extent allowed by local law, the remedies provided in this Warranty Statement are the customer's sole and exclusive remedies.
2. TO THE EXTENT ALLOWED BY LOCAL LAW, EXCEPT FOR THE OBLIGATIONS SPECIFICALLY SET FORTH IN THIS WARRANTY STATEMENT, IN NO EVENT WILL HP OR ITS THIRD PARTY SUPPLIERS BE LIABLE FOR DIRECT, INDIRECT, SPECIAL, INCIDENTAL, OR CONSEQUENTIAL DAMAGES, WHETHER BASED ON CONTRACT, TORT, OR ANY OTHER LEGAL THEORY AND WHETHER ADVISED OF THE POSSIBILITY OF SUCH DAMAGES.

## local law

1. This Warranty Statement gives the customer specific legal rights. The customer may also have other rights which vary from state to state in the United States, from province to province in Canada, and from country to country elsewhere in the world.
2. To the extent that this Warranty Statement is inconsistent with local law, this Warranty Statement shall be deemed modified to be consistent with such local law. Under such local law, certain disclaimers and limitations of this Warranty Statement may not apply to the customer. For example, some states in the United States, as well as some governments outside the United States (including provinces in Canada), may:
  - Preclude the disclaimers and limitations in this Warranty Statement from limiting the statutory rights of a consumer (e.g., the United Kingdom);
  - Otherwise restrict the ability of a manufacturer to enforce such disclaimers or limitations; or
  - Grant the customer additional warranty rights, specify the duration of implied warranties which the manufacturer cannot disclaim, or not allow limitations on the duration of implied warranties.
3. FOR CONSUMER TRANSACTIONS IN AUSTRALIA AND NEW ZEALAND, THE TERMS IN THIS WARRANTY STATEMENT, EXCEPT TO THE EXTENT LAWFULLY PERMITTED, DO NOT EXCLUDE, RESTRICT, OR MODIFY, AND ARE IN ADDITION TO, THE MANDATORY STATUTORY RIGHTS APPLICABLE TO THE SALE OF HP PRODUCTS TO SUCH CUSTOMERS.

## obtaining a warranty extension

If you would like to extend your warranty coverage beyond the limited warranty period, use one of the following options:

- Consult your reseller to get extended coverage. To find HP resellers in the U.S., visit HP's service locator at **[www.hp.com/service\\_locator](http://www.hp.com/service_locator)** .
- If your reseller does not offer service contracts, call HP directly and ask about our HP service agreements. In the U.S. call (800) 446-0522; in Canada call (800) 268-1221. For HP service agreements outside of the U.S. and Canada, contact your local HP sales office.

## regulatory notices

### hewlett-packard company

This device complies with part 15 of the FCC Rules. Operation is subject to the following two conditions:

- This device may not cause harmful interference, and
- This device must accept any interference received, including interference that may cause undesired operation.

Pursuant to part 15.21 of the FCC Rules, any changes or modifications to this equipment not expressly approved by Hewlett-Packard Company may cause harmful interference, and void your authority to operate this equipment. Use of a shielded data cable is required to comply with the Class B limits of part 15 of the FCC Rules.

For further information, contact:

Hewlett-Packard Company

Manager of Corporate Product Regulations

3000 Hanover Street

Palo Alto, CA 94304

(605) 857-1501

### note

This equipment has been tested and found to comply with the limits for a Class B digital device, pursuant to part 15 of the FCC rules. These limits are designed to provide reasonable protection against harmful interference in a residential installation. This equipment generates, uses, and can radiate radio frequency energy and, if not installed and used in accordance with the instructions, can cause harmful interference to radio communications. However, there is no guarantee that interference will not occur in a particular installation. If this equipment does cause harmful interference to radio or television reception, which can be determined by turning the equipment off and on, the user is encouraged to try to correct the interference by one or more of the following measures:

- Reorient or relocate the receiving antenna.
- Increase the separation between the equipment and the receiver.
- Connect the equipment into an outlet on a circuit different from that to which the receiver is connected.

- Consult the dealer or an experienced radio/TV technician for help.

## LED indicator statement

The display LEDs meet the requirements of EN 60825-1.

この装置は、情報処理装置等電波障害自主規制協議会（VCCI）の基準に基づくクラスB情報技術装置です。この装置は、家庭環境で使用することを目的としていますが、この装置がラジオやテレビジョン受信機に近接して使用されると受信障害を引き起こすことがあります。  
取り扱い説明書に従って正しい取り扱いをして下さい。

# index

## [A](#) [B](#) [C](#) [D](#) [E](#) [F](#) [G](#) [H](#) [I](#) [J](#) [K](#) [L](#) [M](#) [N](#) [O](#) [P](#) [Q](#) [R](#) [S](#) [T](#) [U](#) [V](#) [W](#) [X](#) [Y](#) [Z](#)

---

### A

[accessibility](#)

[acknowledgements](#)

[advanced features](#)

auto-on and auto-off feature

[about](#)

[accessing from printer properties](#)

[accessing from the printer assistant](#)

automatic paper-type sensor

[about](#)

[using](#)

[automatic two-sided printing, about](#)

### B

[banners](#)

borderless printing

[about](#)

[problems](#)

[buttons](#)

## C

[calibrating the print cartridge](#)

cleaning

[print cartridge](#)

[print cartridge cradle](#)

connectivity

[about](#)

[network](#)

[parallel port](#)

[USB port](#)

## D

[default settings, changing](#)

## E - F

[envelopes](#)

[environmental statement](#)

## G - H

[greeting cards](#)



## I - K

[iron-on transfers](#)

## L

[labels](#)

**lights**

[about](#)

[flashing](#)

[flashing \(all\)](#)

[on](#)

[power light is flashing](#)

[Print Cartridge Status light is on](#)

[resume light is flashing](#)

## M

**maintenance**

[print cartridge](#)

[printer body](#)

[margins](#)

[minimum printing margins](#)

[minimum system requirements](#)

## N - O

[notices](#)

## P - Q

[paper jam](#)

[paper trays](#)

[photographs](#)

[print cartridge automatically cleaning](#)

print cartridge cradle

[cleaning](#)

[in the center](#)

[in the center and light is flashing](#)

[on the left](#)

[on the left and light is flashing](#)

[on the left and light is on](#)

[on the right](#)

[on the right and light is flashing](#)

[on the right and light is on](#)

Print Cartridge Status light

[flashing](#)

[on](#)

print cartridge

[calibrating](#)

[cleaning using the hp toolbox](#)

[maintenance](#)

[recovery](#)

[refilling](#)

[replacing](#)

[print cartridges](#)

[print settings](#)

[print status box](#)

[printer is slow](#)

[printer tools](#)

**printer**

[body maintenance](#)

[features](#)

[noise after print cartridge installed](#)

**printing**

[banners](#)

[borderless](#)

[digital photographs](#)

[documents](#)

[envelopes](#)

[greeting cards](#)

[index cards](#)

[iron-on transfers](#)

[labels](#)

[paper problems](#)

[photographs](#)

[plain paper](#)

[posters](#)

[printer ejects the paper](#)

[printout problems](#)

[problems](#)

[screen images](#)

[small media](#)

[transparencies](#)

[two-sided documents](#)

[USB problems](#)

[printout problems](#)

## R

[regulatory notices](#)

[removing ink from skin and clothing](#)

[reserve mode](#)

## S

[special features](#)

[specifications](#)

[system requirements](#)

## T

[terms and conventions](#)

[troubleshooting](#)

[two-sided printing](#)

## U - V

[USB, printing problems](#)

## W - Z

[warranty](#)