

hp Jornada 920 series
wireless digital assistant
user's guide



F1871-90005
Printed in Singapore
Edition One

copyright

The information contained in this document is provided "as is" and is subject to change without notice.

Hewlett-Packard Company makes no warranty of any kind with regard to this manual, including, but not limited to, the implied warranties of merchantability and fitness for a particular purpose. Hewlett-Packard Co. shall not be liable for any errors contained herein or for incidental or consequential damages in connection with the furnishing, performance, or use of this manual or the examples herein.

© Hewlett-Packard Company 2002.

This document contains proprietary information that is protected by copyright. All rights are reserved. No part of this document may be photocopied, reproduced, adapted, or translated to another language without the prior written consent of Hewlett-Packard Co., except as allowed under the copyright laws.

The programs that control this product are copyrighted and all rights are reserved. Reproduction, adaptation, or translation of those programs without prior written permission of Hewlett-Packard Co. is also prohibited.

Microsoft, ActiveSync, MSN, Outlook, Windows, Windows Media, Windows NT, and the Windows logo are either registered trademarks or trademarks of Microsoft Corporation in the United States and/or other countries. Microsoft products are licensed to OEMs by Microsoft Licensing, Inc., a wholly owned subsidiary of Microsoft Corporation. Java™ is a U.S. trademark of Sun Microsystems, Inc.

All other brand names and product names used in this document are trade names, service marks, trademarks, or registered trademarks of their respective owners.

Hewlett-Packard Singapore (Pte) Ltd.
Asia Pacific Personal Computer Division
452 Alexandra Road
Singapore 119961

contents

1 introduction.....	1
welcome	2
getting to know your hp Jornada.....	5
using your hp Jornada for the first time	17
managing power	20
2 phone functions	29
getting started with phone functions.....	30
using the phone	34
3 getting connected	51
connecting to your desktop pc	52
getting started with wireless data functions.....	60
receiving cbsms messages.....	61
connecting to the internet or to a network.....	63
browsing the web (or a corporate intranet)	69
sending and receiving e-mail and sms messages.....	74
hp MicroChaiVM	83
EzWAP	88
4 getting started with pda functions	91
navigating in microsoft windows for pocket pc	92
alerts and notifications.....	100
entering information	101
finding and organizing information	114
managing memory	115
backing up and restoring data.....	118
display and alert profiles	120
adjusting other settings	123
configuring hardware buttons	123
configuring menus.....	124
adding and removing programs	126
pda accessories	128



5 pda programs	131
microsoft pocket outlook	132
microsoft pocket word	147
microsoft pocket excel	149
microsoft windows media player.....	150
microsoft reader.....	153
msn messenger	157
hp image viewer.....	160
codewallet pro	166
6 troubleshooting.....	167
resetting your hp Jornada.....	168
basic problems	170
remote connections	174
display problems	177
phone problems.....	178
7 support and service.....	181
web site.....	181
customer support.....	181
service.....	181
contacting hewlett-packard worldwide.....	182
warranty.....	187
glossary	195
appendix: phone safety.....	199
index	203



1 | introduction

Congratulations on purchasing the Hewlett-Packard Jornada 920 series wireless digital assistant. The hp Jornada 920 series integrates the convenience of a phone and built-in wireless connectivity with the power of a Microsoft® Windows® powered PDA, providing everything you need to stay informed and in touch while you are on the go.

PDA functions let you keep your most important business and personal information current and close at hand. Your hp Jornada includes Microsoft Pocket PC Software 2002 with phone, which includes the latest version of Microsoft Pocket Outlook®, so you can read and write e-mail while on the road and manage your appointments and contacts. You will find that your hp Jornada is also the perfect companion to your desktop or notebook PC, allowing you to take vital business data and documents with you and easily upload updated information upon returning to your desk.

hp Jornada offers you the highest quality in performance and power management as well as rich programs and utilities designed by Hewlett-Packard, making hp Jornada your powerful, reliable, mobile business partner.

This chapter includes four sections:

- **welcome** lists the hp Jornada package contents and provides an overview of this user's guide with pointers to other sources of helpful information.
 - **getting to know your hp Jornada** introduces the preinstalled programs and the hardware features and lists some tips for caring for your hp Jornada.
 - **using your hp Jornada for the first time** provides instructions for setting up your hp Jornada, including installing a SIM card, installing the removable battery, and turning on the power.
 - **managing power** tells how to run your hp Jornada using batteries or ac power, tells how to charge the batteries, and offers tips for getting the longest use out of your batteries between charges.
-

welcome

This section lists the contents of your hp Jornada package and provides an overview of this user's guide with pointers to other sources of information, including online Help.

what's in the box

Your hp Jornada package includes the following items:

- hp Jornada 920 series wireless digital assistant (includes auto cover, stylus, and embedded battery)
- removable battery
- ac adapter
- USB sync cradle for connecting your hp Jornada to your desktop PC
- stereo headset with built-in microphone for hands-free use of the phone
- hp Jornada Quick Start Card—a graphic guide to the features and set up of your hp Jornada
- hp documentation pack—includes this user's guide, a Regulatory Information Leaflet, and the hp Jornada Accessories Guide
- Pocket PC Companion CD—includes Microsoft ActiveSync® and Microsoft Outlook for your desktop PC, as well as programs and utilities that add functionality to your hp Jornada

using this guide

This user's guide is designed to help you get started using your hp Jornada quickly and easily. Although great care has been taken to ensure the accuracy of procedures and artwork, some of the screens displayed on your hp Jornada may be different from the ones that appear in this user's guide.

Detailed, step-by-step instructions for using the programs on your hp Jornada are also included in online Help, so you will always have access to them, and you do not have to carry this guide when you travel. (For more

information about using online Help, see “where to find information” later in this chapter.)

This user’s guide includes certain visual cues that will help you find the information you want easily.



A shortcut, another way to do something, or expanded information about the topic



Caution or warning information about the topic. This is important information that should be observed to prevent loss of data or damage to your hp Jornada.



Helpful information related to the topic



where to find information

The following table is a guide to additional information to help you use your hp Jornada.

For information on	See this source
Programs on your hp Jornada	This user’s guide or online Help. To view Help, tap Help on the Start menu.
Additional programs that can be installed on your hp Jornada	The Pocket PC Companion CD and the hp Web site at www.hp.com .
Connecting to and synchronizing with a desktop PC	ActiveSync Help on your desktop PC.

For information on	See this source
GSM service or service providers	www.gsmworld.com or your GSM/GPRS service provider's website.
Last-minute updates and detailed technical information	The Read Me files in the Microsoft ActiveSync folder on your desktop PC or the Pocket PC Companion CD, and the hp Jornada Web site at www.hp.com .
Troubleshooting connections	The ActiveSync Troubleshooter on your desktop PC. On the ActiveSync File menu, click Connection Settings , and then click Help .
The latest on Windows–Powered Pocket PCs	The Microsoft Mobile Devices Web site: www.microsoft.com/mobile/pocketpc

You can get help for specific programs and for Microsoft Pocket PC software by tapping **Help** on the **Start** menu. Help is displayed for the active program. To display a menu of all Help files available on your hp Jornada, tap the **View** menu, and then tap **All Installed Help**, or simply tap **Help** while the Today screen is active.

Navigate in Help just as you navigate in Microsoft Internet Explorer: by tapping links or tapping the  button. When you have finished viewing Help, tap  to return to the program you were using.



The complete text of this user's guide is also available on the hp Web site at www.hp.com. You can download the user's guide to your desktop PC and view it using the Adobe® Acrobat® Reader, available from the Adobe Web site at www.adobe.com.

getting to know your hp Jornada

This section introduces the preinstalled programs and hardware features that are included with your hp Jornada. Wireless phone and Internet features require separately purchased service contracts; connect-time charges may apply. Check with the service provider for availability in your area. Some Web site content may be unavailable.

programs

Your hp Jornada already includes the full suite of software you need to function as a mobile professional. These programs are introduced below. Detailed information can be found in online Help or in later chapters.

The programs listed below are preinstalled in flash ROM. These preinstalled programs will not be deleted if your hp Jornada loses power.



hp applications

hp backup. Protect your valuable data even when you are away from your office by backing up your personal information manager (PIM) databases (Contacts, Calendar, and Tasks) or your entire hp Jornada to an optional CompactFlash card.



hp display profile. Use a pop-up menu to apply one of four profiles for screen brightness and backlight options.



hp home menu. Quickly launch your favorite programs or open frequently used documents. Assign each of the buttons on the hp home menu to a different document or program.



hp image viewer. View individual images or run a slideshow on the screen of your hp Jornada.



hp month view. View, edit, or add appointments and events in a monthly calendar. You can also use hp month view to view a list of all recurring events, and to calculate the number of days between two dates.





hp pocket camera.¹ Use the optional hp pocket camera to snap pictures with your hp Jornada.



hp pocket keyboard.¹ The hp pocket keyboard application allows you to set options for using an optional hp pocket keyboard accessory.



hp quick menu. Use a pop-up menu to turn the display off, change the phone usage settings mode, or start the Align Screen program.



hp task switcher. Switch between open programs and documents, or close any program from a pop-up menu.



hp alert profile. Use a pop-up menu to apply one of four profiles for speaker volume, system sounds, and phone ringing options.



hp MicroChaiVM. An embedded virtual machine for intelligent devices, hp MicroChaiVM enables your hp Jornada to download and run MIDP Java™ applications (MIDlets), such as games and messaging utilities offered by your GSM/GPRS service provider.



hp profiles. Use this convenient application to set all options for power management, PDA volume and alerts, phone ringing, and display brightness. Apply one of the preset profiles, or configure the profiles to suit your work environment.



phone display. Use hp phone display to set options for displaying information on the phone display when the phone is not in use.



GPRS.² If you subscribe to GPRS (general packet radio service) through your GSM/GPRS service provider, use the hp GPRS program to view usage statistics and to set options for how your device attaches to the GPRS network.

¹ For more information, see the hp Jornada Accessory Guide.

² Wireless phone and internet features require separately purchased service contracts; connect-time charges may apply. Check with the service provider for availability in your area. Some web site content may be unavailable.

Cell Broadcast.¹ If you subscribe to a cell broadcast service through your GSM/GPRS service provider, use the Cell Broadcast application to receive text-based information, such as news, stock updates, and weather reports over your phone network.



microsoft pocket pc software

ActiveSync. Synchronize information between your device and desktop computer.



Calendar. Keep track of your appointments and create meeting requests.



Contacts. Keep track of your friends and colleagues.



Inbox. Send and receive e-mail messages from your hp Jornada.



Notes. Create handwritten or typed notes, drawings, and recordings.



Pocket Excel. Create new workbooks or view and edit Excel workbooks created on your desktop PC.



Pocket Word. Create new documents or view and edit Word documents created on your desktop PC.



Tasks. Keep track of your to-do list.



Microsoft Pocket Internet Explorer.¹ Browse the Web and view channels and subscription content.



MSN Messenger.¹ Send and receive instant messages with your MSN® Messenger contacts.



¹ Wireless phone and internet features require separately purchased service contracts; connect-time charges may apply. Check with the service provider for availability in your area. Some web site content may be unavailable.



Microsoft Windows Media Player for Pocket PC.¹ Play audio and video clips on your hp Jornada. Windows Media™ Player lets you play songs and video files that have been recorded in the MP3, WMV, or WMA formats.



Microsoft Reader. Read electronic books on your hp Jornada.

third-party software



EZOS EzWAP 2.1.² Use the EzWAP browser to view internet sites that have been optimized for viewing on mobile devices using WML (wireless markup language) and WAP (wireless access protocol).



Fonix Voice Dial. Use a voice-activated interface to access your contacts list and call your contacts using the phone features of your hp Jornada.



Developer One CodeWallet Pro. Store, organize, and retrieve personal information, such as passwords, credit card numbers, favorite URLs, and emergency phone numbers.

The Pocket PC Companion CD included with your hp Jornada has additional programs for both your desktop PC and your hp Jornada.



You can also install programs from a variety of sources, including the Internet. For more information, see "adding and removing programs," in chapter 4.

¹ Check the Microsoft Mobile Devices Web site for updates to Windows Media Player, including details on support for video file formats and streaming audio and video capabilities.

² Wireless phone and internet features require separately purchased service contracts; connect-time charges may apply. Check with the service provider for availability in your area. Some web site content may be unavailable.

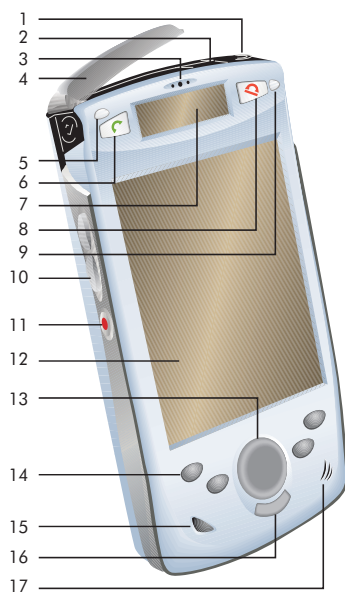

hardware features

The illustrations below introduce you to the various buttons, connectors, ports, and other features of your hp Jornada.

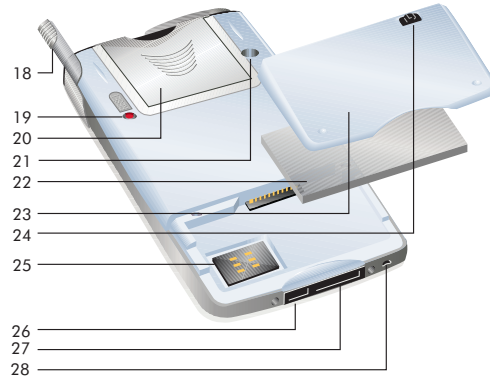

1. Stereo headset jack. Connect a pair of stereo headphones or the hands-free phone headset.
2. Infrared port. Beam files to other mobile devices.
3. Earpiece. Functions as the phone earpiece when you are not using the headset.
4. Antenna. Lift the antenna if necessary to improve phone reception.
5. LED. Notifies you of scheduled appointments, alarms, and reminders, and indicates power status while recharging.
6. Send button. Press to dial a call. Press and hold to start Fonix Voice Dial.
7. Phone display. Displays the status of the phone, phone call, and SMS-related features.
8. End button. Press and hold to turn phone functions on or off. When phone is on, press to end a call or to apply an alert profile.
9. Ambient light sensor. Enables you to create a display profile that automatically turns the backlight on or off.
10. Volume/scroll control. Adjust the talk volume while a call is connected, or scroll the phone display.
11. Record button. Press and hold to record voice notes. Release to stop recording.
12. Touch screen. Tap on-screen controls or buttons to select menu commands or input text.
13. Navigation pad. Press to navigate through documents or select on-screen buttons and controls.
14. hp hot keys. Press to launch an application or programmed function.
15. Power button. Press to turn your hp Jornada on or off. Press and hold to turn the backlight on or off.
16. Action button. Press to open the selected item.
17. Speaker. Listen to music, or use your hp Jornada as a speakerphone.



18. Stylus. Use the stylus to navigate on the touch screen.
19. Reset button. Press the reset button and restart your hp Jornada.
20. CompactFlash Type I extended card slot. Add functionality with optional CompactFlash Type I or Type I extended accessories.
21. Connector for external antenna
22. Removable battery. Remove the battery to access the SIM card slot.
23. Battery compartment door. Remove the door to remove or install the removable battery or a SIM card.
24. Battery lock. Slide to lock , or unlock  to remove the battery.
25. SIM card slot. Install an optional GSM SIM card to activate phone functions.
26. DC jack. Connect to ac power to recharge the batteries.
27. USB connector. Connect to your desktop PC using the supplied cradle, or an optional sync cable.
28. Microphone. Record voice notes.

The hardware buttons on your hp Jornada (that is, the buttons on the device itself, rather than buttons or icons that appear on the display) can each be used to perform several functions, such as turning on your hp Jornada or starting a particular program.

The features associated with each button are described below. In addition, most buttons can be reassigned or configured to start a program that you designate. For more information, see "configuring hardware buttons" in chapter 4.

LED

The color and state (blinking or steady) of the LED have different meanings, depending on whether you are using the phone or PDA, and whether your hp Jornada is connected to ac power.

- steady amber LED indicates that the PDA is recording a voice note, or that batteries are charging (when connected to ac power)
- steady blue LED indicates that batteries are fully charged (when connected to ac power)
- blinking blue LED indicates a PDA alarm or reminder. Blinking blue LED can also indicate a missed phone call, that the phone is in auto-roaming mode, or that an SMS message has been received.

Send button

Press the Send button to

- start to the Microsoft Phone application
- answer an incoming call
- dial the selected number

When the auto cover is closed, you can also use the Send button to dial a number from your speed dial list or to review the lists of incoming and outgoing calls. For more information, see “making a call” in chapter 2.

End button

- press the End button to end a call.
 - press and hold the End button to turn the phone on or off.
 - you can also use the End button to apply a profile while the auto cover is closed and the phone is on. For more information, see “display and alert profiles” in chapter 4.
-

volume/scroll control

- while in a call, press the volume/scroll control to adjust the phone volume.
- while not in a call, if a list is shown in the phone display, press the volume/scroll control to scroll the list.

record button

- press and release the record button to launch Fonix Voice Dial.
- press and hold the record button to turn on your hp Jornada and begin recording a voice note. If the speaker is not muted, a beep indicates that recording has started.
- release the record button to stop recording. If the speaker is not muted, a double beep indicates that recording has stopped.



If your hp Jornada is off, pressing the record button will turn it on. To avoid inadvertently turning on your hp Jornada, you can disable this feature. For more information, see “managing power” later in this chapter.

hp hot keys

The hp hot keys can be reprogrammed to perform different functions or to launch any program or document you want. The descriptions below refer to the default functions. For more information, see “configuring hardware buttons” in chapter 4.

 **hp home menu hot key**

- press the hp home menu hot key to launch the hp home menu application.
- press the hp home menu hot key a second time to display the next page of home menu buttons.
- press and hold the hp home menu hot key to launch the **hp quick menu** pop-up menu. Use the hp quick menu to turn off the display, launch the Align Screen control panel, or to change the phone usage settings mode.

 **contacts hot key**

- press the Contacts hot key to launch the Pocket Outlook Contacts application.
- press and hold the Contacts hot key to display the **hp alert profile** pop-up menu.
- when working in Pocket Outlook Contacts, press the Contacts hot key to filter the contact list on category.

 **calendar hot key**

- press the Calendar hot key to launch the Pocket Outlook Calendar application.
- when working in Pocket Outlook Calendar, press the Calendar hot key to change views (for example, to switch from Day view to Week view).
- press and hold the Calendar hot key to display the **hp display profile** pop-up menu.

 **inbox hot key**

- press the Inbox hot key to launch the Pocket Outlook Inbox application.
- press and hold the Inbox hot key to launch hp task switcher.

power button

- press the power button to turn your hp Jornada on or off.
- press and hold the power button to turn the backlight on or off.
- if the display is off, press the power button to turn on the display.

navigation pad and action button

- press the navigation pad to scroll through a document or to highlight the next item in a list.
- press the action button to select the highlighted item. The actions vary depending on the active program and the item selected.

removing and replacing the auto cover

You can remove the auto cover from your hp Jornada.

To remove the auto cover

1. Open the auto cover to the fully open position (about 120°)
2. Gently pull one side away from the hp Jornada until it pops free.
3. Pull the other side free.

To replace the auto cover

1. Align the auto cover with the hinges on the hp Jornada. Note that the T-shaped extrusions on the cover must align with the T-shaped impression on the hinges, as shown in the diagram below.
2. Fit one side of the cover into the hinge, and then fit the other side.



If you have trouble aligning the cover properly, check to be sure that both hinges are aligned properly. The small arrow on each hinge should align with the small dot on the body of the hp Jornada. If the hinges are not aligned, use a blunt object, such as a small screwdriver to align the hinges.

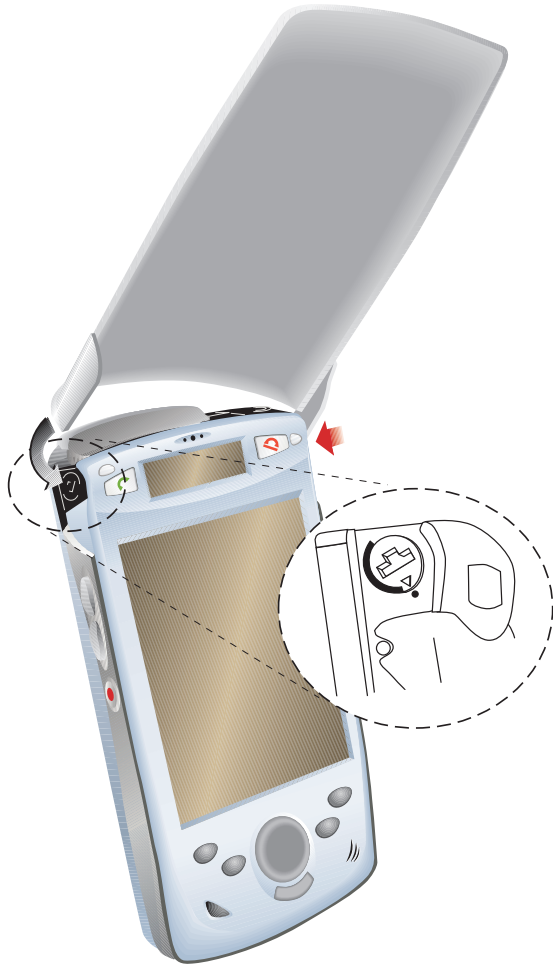

If you frequently remove the auto cover, you may want to disable the auto cover functions that turn your hp Jornada on and off or switch between speakerphone and handheld mode. For more information, see Auto Cover Help on your hp Jornada.



caring for your hp Jornada

When treated properly, your hp Jornada will be a reliable wireless digital assistant. Follow these tips to ensure long and trouble-free use of your hp Jornada:

- **protect the screen.** Pressing too hard on the touch screen may damage the screen. To avoid scratching or damaging to the screen, use only the stylus to tap the hp Jornada screen, and replace the stylus if it becomes dull. To clean the screen, use a small amount of commercial glass cleaner sprayed on a soft, lint-free cloth. Avoid spraying the screen directly.



You can purchase additional styli and screen protectors as optional accessories. For more information, see the hp Jornada Accessories Guide.

- **do not drop your hp Jornada.** Dropping your hp Jornada can cause damage to delicate components such as the display. Accidental damage is not covered under the warranty.
- **do not extend the antenna beyond 90 degrees.**
- **avoid radiated interference.** Radiated interference from other electronic equipment may affect the appearance of the display of your hp Jornada. Removing the source of the interference will return the display to normal.
- **avoid high temperatures.** Your hp Jornada is designed to operate at temperatures between 0 to 40 °C (32 to 104 °F). Subjecting the device to temperatures outside this range may damage the unit or result in loss of data. Be especially careful not to leave your hp Jornada in direct sunlight or in a car where temperatures can rise to harmful levels.
- **Register your hp Jornada.** To receive updates on exclusive promotions, exciting new products, and accessories, register your hp Jornada at www.hp.com.

using your hp Jornada for the first time

Follow these steps to begin using your hp Jornada:

- 1. Install a SIM card.** If you have an account with a GSM/GPRS service provider and you want to use the phone functions of your hp Jornada, install the SIM card (provided by your service provider), as shown in the diagram.

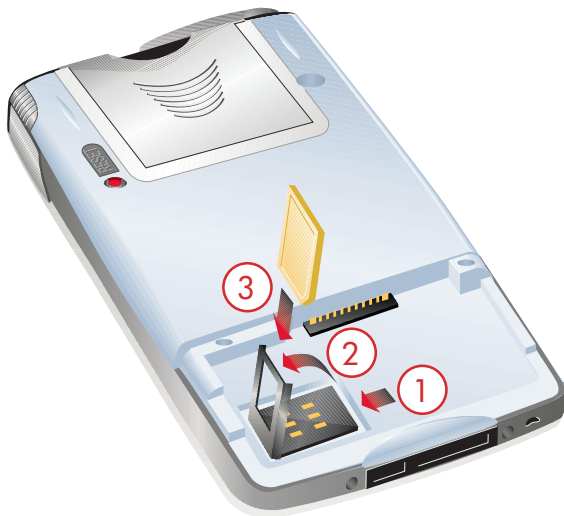

1. Slide the lock on the SIM card slot to the left.
2. Lift the SIM card slot.
3. Insert the SIM card into the SIM card slot.
4. Fold the SIM card slot down, and then slide the lock to the right.

2. Install the removable battery.

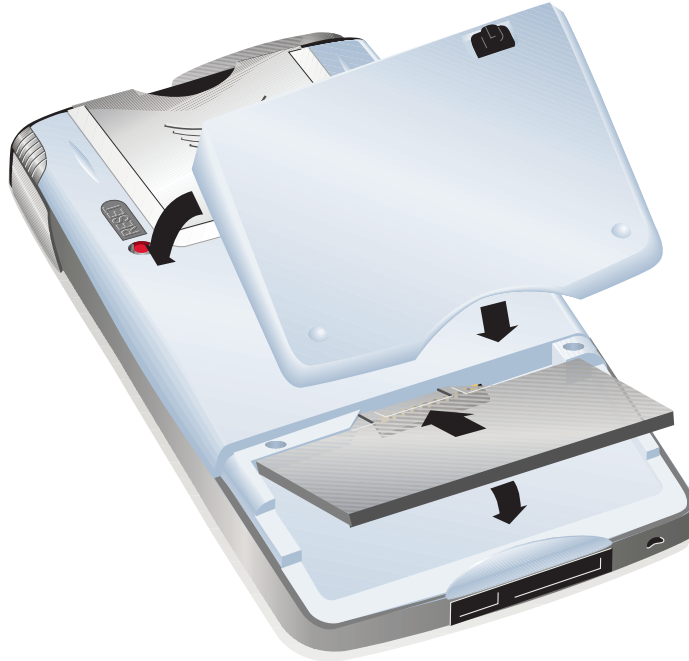

1. Align the removable battery with the hp logo facing upwards. Hold the battery at a 30° degree angle relative to the connectors, and slide the battery into the battery compartment.
2. Hold the battery compartment door at a 45° angle relative to the device, and slide the door into the bottom clasp before placing the door over the removable battery.
3. Slide the battery lock to the locked position. 🔒

- 3. Connect to ac power.** Connect the ac adapter to a wall socket, and then connect the other end to the dc jack on your hp Jornada.



- 4. Complete the Welcome Wizard.** The first time you start your hp Jornada, the **hp invent** screen appears. Then, after a few moments, the Welcome Wizard begins. The Welcome Wizard presents a brief orientation to Microsoft Windows for Pocket PC, helps you align the touch screen, and prompts you to select your city and time zone.

managing power

Because the data and files you save on your hp Jornada are stored in RAM (random access memory), maintaining a continuous power supply to the hp Jornada at all times is extremely important. If your hp Jornada runs out of power, all information stored in RAM is lost. The preinstalled programs will not be deleted even if your hp Jornada suffers a loss of power; however, any custom settings and programs you have added will be erased.

This section describes

- how to run your hp Jornada using the batteries or an ac power supply
- how to turn the phone and PDA functions on and off
- how to manage power to ensure you get the longest use of your hp Jornada between charges

batteries







Your hp Jornada includes two rechargeable lithium-polymer batteries. The *removable battery* can be removed to allow access to the SIM card slot. The *embedded battery* cannot be removed; it provides power when the removable battery is not present.

How long you can operate your hp Jornada without recharging the batteries depends on the features and functions you use. If you use only the PDA functions (no phone functions, and without using the backlight), the batteries included with your hp Jornada will provide approximately 12 hours of use. If you use your hp Jornada only as a phone, the batteries will provide approximately 150–210 minutes of talk time or 120 hours of standby time. Note that some functions, such as listening to music, using the backlight, or using phone functions, use considerable power and may reduce this time significantly. In addition, factors such as your distance from the transmitter and the configuration used by your GSM/GPRS service provider may affect battery life when you are using the phone.

battery status messages and warnings

When your hp Jornada displays a dialog box warning of low power, you should respond as soon as possible by recharging the batteries. If you continue to use your hp Jornada until power reaches a critical low condition, a “Battery very low” message appears, and the hp Jornada shuts down automatically. You will be unable to use your hp Jornada until you connect to external power for charging.

The following table lists all battery-related warning messages, and associated status icons.

Message	Meaning	Icon
Main Battery Low	To prevent possible data loss, replace or recharge the batteries.	
Battery Very Low	Battery very low. Please close all applications and recharge your batteries immediately.	
Main Battery Very Low	To prevent possible data loss, replace or recharge your batteries. (Your hp Jornada will shut down due to low battery power.)	
Embedded Battery Very Low	Embedded battery very low. You may lose data if phone functions are turned on.	
Embedded Battery Empty	Embedded battery empty. Please recharge immediately. To prevent data loss, do not take out the removable battery until the embedded battery is fully charged.	
Removable Battery Removed	Phone functions disabled. Cannot detect removable battery in your hp Jornada.	
Removable Battery Empty	Removable battery empty. Change to a charged battery if available.	

charging the batteries

The batteries are charged whenever your hp Jornada is connected to an ac power source—either the ac adapter or the sync cradle. Connect your hp Jornada to ac power or place it in the cradle when it is not in use, to ensure that the batteries are fully charged when you need to take it with you.

Charging the batteries takes approximately three hours. When the batteries are fully charged, charging stops automatically; the batteries will not overcharge if left connected to ac power.

ac power

To avoid running out of battery power, you can operate your hp Jornada on ac power using the supplied ac adapter. The ac adapter accepts input voltages from 100 V to 240 V, enabling you to connect to ac power anywhere in the world. If you travel, you may need adapters to accommodate different electrical outlets, but the hp Jornada ac adapter will safely convert ac line voltage to the dc voltage required by your hp Jornada.

While your hp Jornada is connected to ac power, the batteries are charged automatically. The color of the LED indicates the status of the batteries: amber indicates that the batteries are charging, and blue indicates that the batteries are fully charged.



If you will not be using your hp Jornada for an extended period of time, be sure to charge the batteries fully (or connect to ac power) before you store your hp Jornada.

turning your hp Jornada on and off

The PDA and phone functions of your hp Jornada are powered separately. That is, you can turn on only the phone or the PDA, or both at the same time.

turning on the pda

One of the most convenient features of hp Jornada is "instant on." With instant on, there is no waiting for your hp Jornada to start up or shut down; you can start working immediately simply by pressing the power button.

You can also turn on your hp Jornada by pressing one of the hp hot keys or opening the auto cover. Use the hp auto cover application or the Power preferences page of the hp profiles application to set these options.



turning off the pda

When you are finished working, turn off your hp Jornada by pressing the power button. You can use the Power preferences page of the hp profiles application to change these settings.

Turning off the PDA does not turn off the phone.

turning on phone functions

You must turn on the phone before you can send or receive phone calls. In addition, you must have a subscription with a GSM/GPRS service provider, and you must install the SIM card provided by your service provider. For more information, see chapter 2.

To turn on the phone

- Press and hold the End (red) button.
–or–
In the Command bar, tap , and then tap **Turn phone on**.

You may be required to enter a personal identification number (PIN) to unlock your SIM before you can turn on the phone. If your SIM is locked, you will see a message on the phone display indicating “SIM Locked,” and the touch screen will display a keypad. Tap the numbers on the touch screen to enter your PIN and unlock the SIM.



turning off the phone

You can turn off the phone and wireless data functions to conserve battery power; however, you will be unable to receive incoming phone calls or browse the Web when the phone is off.

To turn off phone functions

- Press and hold the End (red) button.
–or–
In the Command bar, tap , and then tap **Turn phone off**.

managing power

Use the hp profiles to set power options. Use the Power control panel to check the status of the batteries and the current power source.

To check battery power

1. On the **Start** menu, tap **Settings**.
2. On the **System** tab, tap the Power icon.

The remaining power is displayed on a status bar in the Power control panel. If you are running on battery power, the status bar shows the combined (average) state of the removable and embedded batteries. If the batteries are charging, the status bar indicates that the batteries are charging. The entries below the status bar indicate the status of the individual batteries, as a percentage of full power.

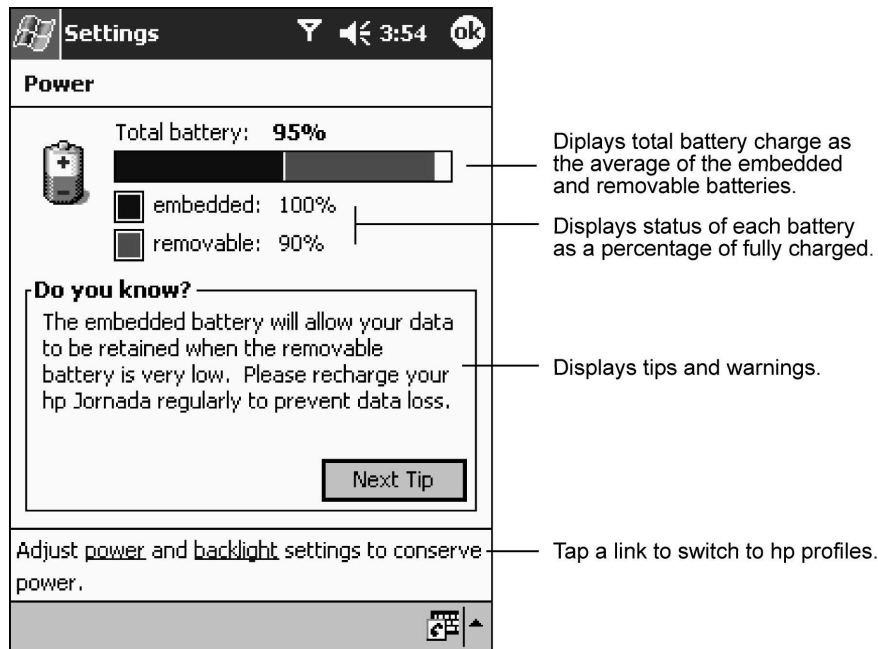

Displays total battery charge as the average of the embedded and removable batteries.

Displays status of each battery as a percentage of fully charged.

Displays tips and warnings.

Tap a link to switch to hp profiles.

Under certain conditions, the Power Status icon is displayed on the Command bar in the Today screen. Simply tap the Power Status icon to launch the Power control panel.



setting power preferences

Use the Power preferences page of the hp profiles application to set options for turning your hp Jornada on and off, both for convenience and to conserve battery power. You can set your hp Jornada to turn on whenever you tap the touch screen or open the auto cover. Disabling the record button and the hp hot keys while the hp Jornada is off prevents you from inadvertently turning on your hp Jornada by pressing one of these buttons.

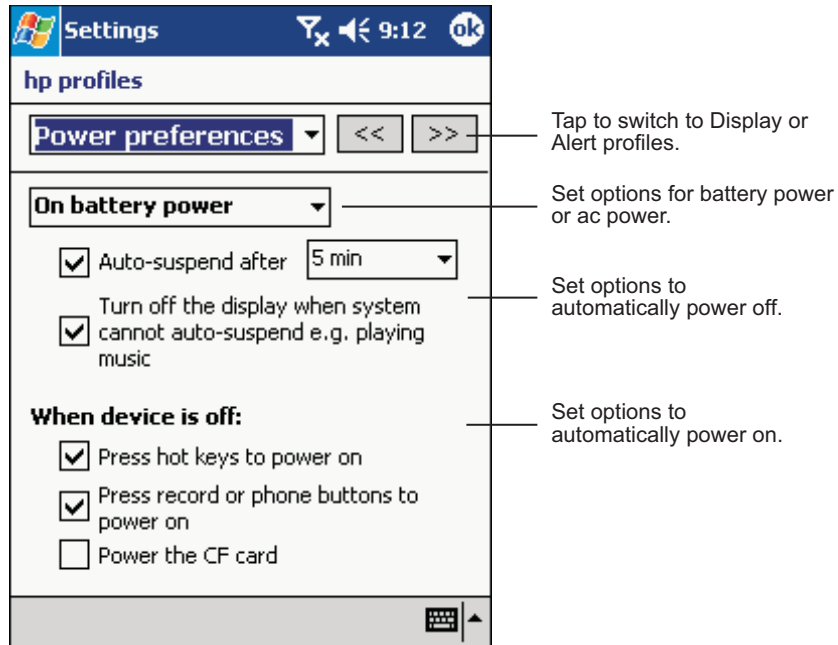

power management tips

Follow these tips to ensure the longest use of your hp Jornada between charges:

- **turn off the backlight.** Press and hold the power button to turn off the backlight, or use the Backlight control panel to set the backlight to turn off automatically after a short period of inactivity.
- **turn off the display manually.** If you are playing music or using other functions that do not require the display, turn off the display. Press and hold the hp home menu hot key to display the hp quick menu, and then tap **Turn display off**. (Turn on the display by pressing the power button.)

- **suspend frequently.** Use the Power control panel to shorten the length of continuous idle time before your hp Jornada auto-suspends. Press the power button to turn off your hp Jornada when it is not in use, even for a short time.
- **always use ac power when connecting your hp Jornada to your desktop PC.** Note that your hp Jornada will not auto-suspend while it is connected.
- **turn off sounds.** Use the hp profiles application to mute the speaker, or use the Sounds & Notifications control panel to turn off all but the most necessary system sounds.
- **avoid using CompactFlash accessories while on battery power.** Some CompactFlash accessories use considerable power and will quickly drain your batteries.
- **do not “listen” for infrared transfers.** Although you can set your hp Jornada to constantly monitor the infrared port for files sent from other devices, doing so will quickly drain your batteries.

Use the ac adapter to plug your hp Jornada into external power whenever possible, especially when connecting to a desktop PC. Do not let the LED blink for a long time.



2 | phone functions

Your hp Jornada 920 series wireless digital assistant includes an integrated GSM/GPRS phone. This chapter includes two sections:

- **getting started with phone and wireless data functions** tells how to set up your hp Jornada to use wireless phone and data functions, and how to interpret the phone display
 - **using the phone** tells how to make and answer phone calls and how to customize phone settings
-

getting started with phone functions

The phone and wireless data functions on your hp Jornada use the Global System for Mobile Communications (GSM) and general packet radio service (GPRS). The following sections will help you establish an account with a GSM/GPRS service provider, install the SIM card that stores your account information, and turn the phone on and off.

setting up an account with a GSM/GPRS service provider

To use the phone and wireless data features of your hp Jornada, you must establish a subscription with a GSM/GPRS service provider. The features available to you depend on the services offered by the service provider and the details of your subscription.

GSM voice services enable you to use your hp Jornada as a phone. You can make and receive calls and SMS messages to a number assigned by your service provider.

installing the sim card



When you register for a new account, your GSM/GPRS service provider will provide you with a SIM (subscriber information module) card. The SIM card contains your phone number, information about services to which you have subscribed, and other information that identifies your hp Jornada to the mobile phone network.

You can copy information stored on a SIM card to your hp Jornada (to Pocket Outlook Contacts), but you cannot copy information from your hp Jornada to a SIM card. For more information, see "managing phone numbers" under "phone tips and advanced features" later in this chapter.

You must install a SIM card in your hp Jornada before you can make or receive phone calls or use wireless data services. For more information, see "using your hp Jornada for the first time" in chapter 1.

If you remove or replace the SIM card, it is recommended that you turn off the phone and PDA functions before removing the SIM card.

To remove or replace the SIM card

1. In the command bar, tap  to turn off the phone.
2. Press the power button to turn off the PDA.
3. Slide the battery lock to the unlocked position  and remove the battery cover.
4. Remove the replaceable battery.
5. Slide the lock on the SIM card slot to the unlocked position.
6. Lift the SIM card slot.
7. Remove the SIM card and/or insert the new SIM card in the SIM card slot.
8. Fold the SIM card slot down, and then slide the lock to the locked position.
9. Replace the battery and battery cover and slide the battery cover lock to the locked position .

turning the phone on and off

You turn the phone on or off independently of your PDA. The phone functions must be on for you to make or receive incoming calls.

To turn on the phone functions

- Press and hold the End (red) button.
—or—
In the Command bar, tap , and then tap **Turn phone on**.

You can turn off the phone to conserve battery power; however, you cannot receive incoming phone calls or text messages when the phone is off.

To turn off the phone







- Press and hold the End (red) button.
—or—
In the Command bar, tap , and then tap **Turn phone off**.





Removing the removable battery from your hp Jornada turns off the phone.





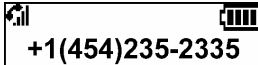





phone display and status icons

When you turn on the phone functions, the phone display shows the SIM card status:

Icon	Meaning
	When you first turn on the phone, the display shows the hp logo while phone functions are initializing.
	The phone is searching for a network.
	The call is being connected.
	Your phone is receiving an incoming call.
	The phone cannot find a network carrier.
	The SIM card is missing or has not been installed properly, the SIM card may be faulty, or your phone has been configured by your service provider to work only with specific SIM cards. If your SIM card is installed properly and you still see this message, contact your GSM service provider.
	The SIM card may be password protected. You may need to enter a personal identification number (PIN) to unlock the SIM card before you can use the phone. For more information, contact your service provider or see "using your hp Jornada for the first time" in chapter 1.

Icon	Meaning
 +1(454)235-2335	While the call is being dialed, the phone display indicates the number dialed. If you have Caller ID service, the phone display also shows the numbers of incoming calls.
 Christina Peterson	If a number you have dialed corresponds to an entry in your Contacts database, the display shows the name of the contact. If you have Caller ID service, the phone display also shows the names of incoming calls.

The phone display indicates the status of the phone and any recent activity using icons or text, as shown below.

Icon	Meaning
	icon changes to show signal strength
	data connection established.
	phone is dialing or in a call.
	call divert on
	new SMS message received
	new voice mail message received
	new voice mail and SMS messages received
	phone ring is muted
	phone vibrate is on
	icon changes to show battery strength

using the phone

There are three ways to make a call using your hp Jornada:

- **hands-free.** The stereo headset includes a built-in microphone for hands-free calling. Connect the headset to the headset jack on your hp Jornada.
- **handheld.** Hold the earpiece to your ear, and speak into the microphone. By default, this method works with the auto cover closed. Use the auto cover control panel to change the default settings.
- **speakerphone.** Use the speaker located at the bottom right corner of the device. By default, this method works with the auto cover open. Use the auto cover control panel to change the default settings.

Use the hp quick menu to switch between handheld and speakerphone modes, or use the hp auto cover control panel to change modes automatically.

While you are in a call, use the volume/scroll control on the side of your hp Jornada to adjust the talk volume of the headset, earpiece, or speaker. Use the hp profiles application to adjust the ring volume.



The appendix includes important information on phone safety. Read the safety information carefully before using the phone.

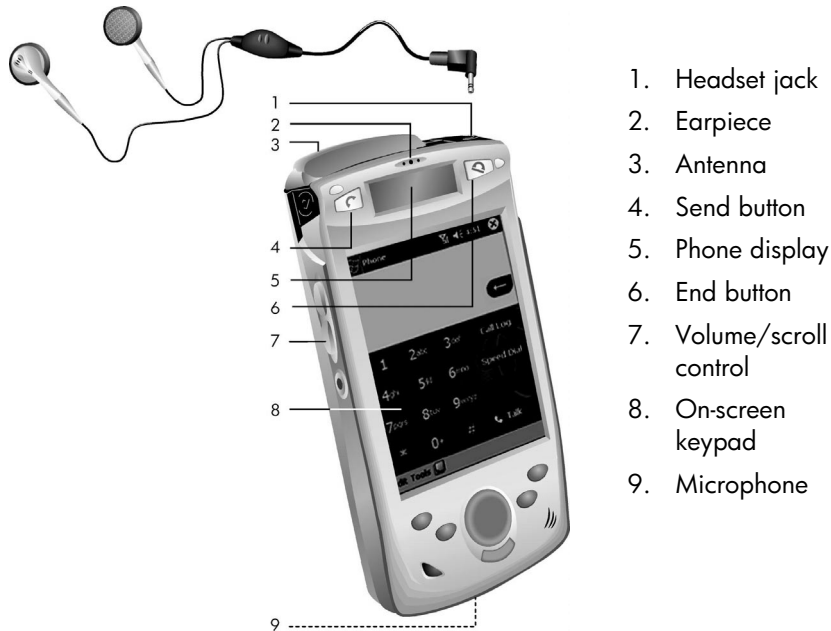

If phone reception is weak, lift the antenna to improve reception.



making a call

There are several methods you can use to dial an outgoing call. You can use the Microsoft Phone application to dial a call manually. You can also make a call by using numbers in your speed dial list, by using the Send button (with the auto cover closed), or by using voice commands.

To dial a call using the phone application

1. Install your SIM card and turn on the phone, as described in previous sections.
-

2. Connect the stereo phone headset to the headphone jack, and put on the headset.
3. On the **Start** menu, tap **Phone** to start the Microsoft Phone application.
4. On the keypad displayed on your hp Jornada screen, tap the number, and then tap **Talk**.
5. Use the volume/scroll control to adjust the headset volume.
6. When you have finished the call, press the red End button.



To place an international call, tap and hold **0** on the on-screen key-pad until a **+** appears.

To make a call using speed dial

- In the Microsoft Phone application, tap **Speed Dial**, and then tap the number of the speed dial entry you want to call.
–or–
On the on-screen keypad, tap and hold the keypad number that corresponds to the Speed Dial entry. (To dial a two-digit speed dial number, tap the first digit, and then tap and hold the second digit.)

To make a call using the phone buttons

1. On the **Start** menu, tap **Settings**, and then tap the Phone Display icon.
 2. On the **Call list** tab, select the list you want to access (speed dial, incoming calls, or outgoing calls).
 3. Tap **OK** to close the Phone Display application.
 4. With the auto cover closed, press the Send button. The phone display shows the first item in the selected list.
 5. Use the volume/scroll button to scroll through the list of numbers.
 6. Press Send to dial the number displayed in the phone display.
-

using fonix voice dial

Fonix Voice Dial is a voice-activated interface that enables you to use your voice to access contacts and dial the phone. Voice Dial does not require you to pre-record the voice commands.

For best results, use the headset provided with your hp Jornada 920 series wireless digital assistant while using Fonix Voice Dial.



To launch Fonix Voice Dial

- Press and release the record button.
—or—
Press and hold the Send button.

You can change the button used to launch Fonix Voice Dial. For more information, see “configuring hardware buttons” in chapter 4.



Fonix Voice Dial launches in listening mode. While in listening mode, Fonix Voice Dial monitors sounds for detectable speech, waiting for you to speak a command. The available voice commands are listed on the Voice Dial screen.

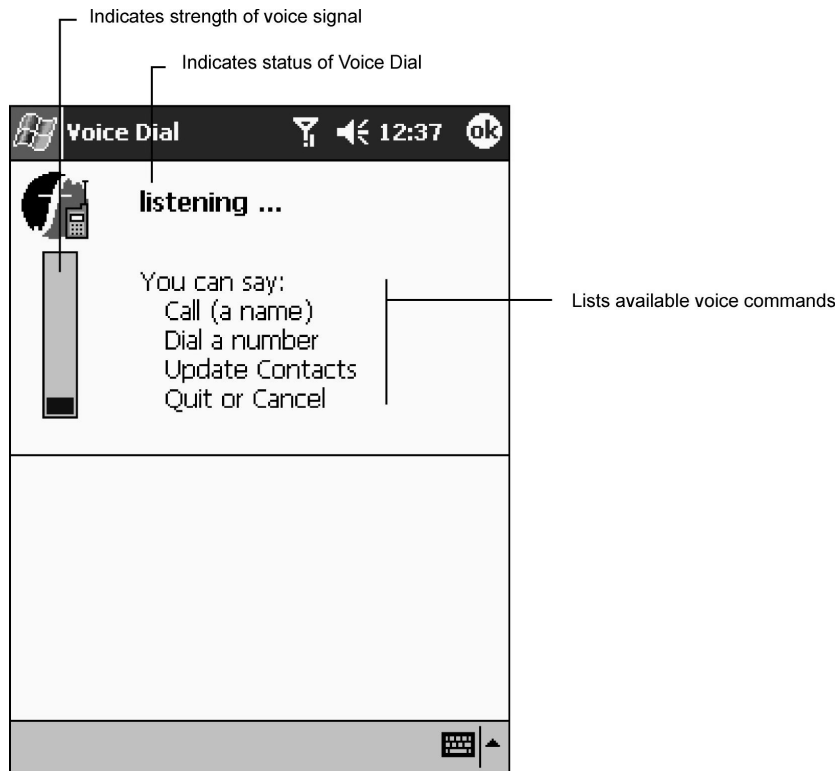

You can use Fonix Voice Dial to place a call by saying the number you want to dial or by saying the name of a contact.

To place a call by a number

1. Say **"dial a number."** Fonix Voice Dial will ask, "What number would you like to dial?" and then a beep will sound.
2. Say the number you want to dial, one digit at a time. Fonix Voice Dial will speak the number and ask you if the information is correct.

3. Say "**yes**," to dial the number.
–or–
Say "**no**," to cancel the call and return to listening mode.

To place a call by name

1. Say "**call**," and then say the first and last name of the contact you want to call. Fonix Voice Dial will display the name and number of the contact and ask you if the information is correct.
2. If you have more than one number saved with the contact, you can say the location at which you want to reach the contact (for example, "**Call Mary Smith at work.**").
3. If the information displayed is correct, say "**yes**," to dial the number.
–or–
Say "**no**," to cancel the call and return to listening mode.

Fonix Voice Dial maintains a list of recognized names. To call a contact by name, the name must be in this list. The list is generated from your Pocket Outlook Contacts database. To be sure the Voice Dial list includes all your contacts, update the list after you make change or add a contact in Pocket Outlook.

To update contact information

- Say "**update contacts.**"

To exit Fonix Voice Dial

- Say "**quit**" or "**cancel.**"

Fonix Voice Dial will also shut down automatically if a period of time passes without any noise.

For more details on using Fonix Voice Dial, see the Pocket PC Companion CD.

answering an incoming call

Your phone must be on to receive an incoming call. When an incoming call is received, your hp Jornada plays the ringing sound or vibrates according to the options you have set for your alert profile. The phone display shows the Incoming call message. If you have a caller ID service, the caller's telephone number is displayed; if the number is in your Pocket Outlook Contacts database, the caller's name is displayed.

To answer an incoming call

- In the Microsoft Phone application, tap **Answer**
–or–
Press the Send button on your hp Jornada.

If the phone rings while you are using Windows Media Player to listen to music on the PDA, Windows Media Player will pause the music. Play will resume after you end the call, or if you cancel the call without answering.



If you answer a call while you are connected to GPRS, GPRS will be disconnected. After you end the call, you will need to manually reconnect to GPRS. If you do not want to end your GPRS session, ignore the incoming call.



If you answer a call while you are in a WAP session, the session will suspend. After you end the call, the WAP session will resume automatically.

deferred answering and local voice mail

When you do not want to answer an incoming call immediately, your hp Jornada provides two options for deferred answering. You can play a recorded message asking the caller to remain on hold until you answer, or you can play a greeting that asks the caller to record a local voice mail message on your hp Jornada.

To use deferred answering

1. Press and hold the Send button on your hp Jornada.
 2. Release the Send button to answer the call.
-

When you place the call on hold, the caller hears a pre-recorded message. Your hp Jornada includes a pre-recorded default message, but you can also create a custom message by recording a voice note.

To use a custom message

1. Record your message. For more information, see “recording a message” in chapter 4.
2. On the **Start** menu, tap **Settings**, and then tap the Phone icon to open the Phone Settings control panel.
3. On the **Answer** tab, under **Deferred Answering**, tap the ... button, and then browse to select the .wav file you recorded.

To activate local voice mail

1. On the **Start** menu, tap **Settings**, and then tap the Phone icon to open the Phone Settings control panel.
2. On the **Answer** tab, under **Local voice mail**, select the **if not answered in** check box.
3. From the drop-down list, select how long you want the phone to ring before it is routed to voice mail.

Your hp Jornada includes a pre-recorded greeting asking callers to leave a message. You can also create a custom greeting by recording a voice note.

To use a custom voice mail greeting

1. Record your message. For more information, see “recording a message” in chapter 4.
2. On the **Start** menu, tap **Settings**, and then tap the Phone icon to open the Phone Settings control panel.
3. On the **Answer** tab, under **play this greeting**, tap the ... button, and then browse to select the .wav file you recorded.

After a voice mail message has been received, you will see the  in the Command bar. Voice mail messages are stored as wav files, named

VoiceMsgX.wav. You can listen to voice mail messages using the Pocket Outlook Notes application.

To listen to local voice mail

1. Tap the voice mail icon in the Command bar. A message appears stating that you have new voice mail.
2. On the message that appears, tap **Launch Notes**. The Pocket Outlook Notes application starts.
3. In Pocket Outlook Notes, tap the file that corresponds to the message.

For information on SMS messages, see "sending and receiving e-mail and sms messages" in chapter 3.

phone tips and advanced features

Depending on the services offered by your GSM/GPRS service provider and the services you subscribe to, there are many advanced features of the phone you can use. Your phone supports features such as speed dial, call logs, ringing tones, caller ID, call forwarding, and others.

using hp dialer

hp Dialer enables you to dial the phone using the input panel, so you can make a call while another program or other information is displayed.

To display hp Dialer

1. Tap the arrow next to the input panel button on the Command bar.
2. On the pop-up menu, tap **hp Dialer**.
3. On the Command bar, tap the input panel button.

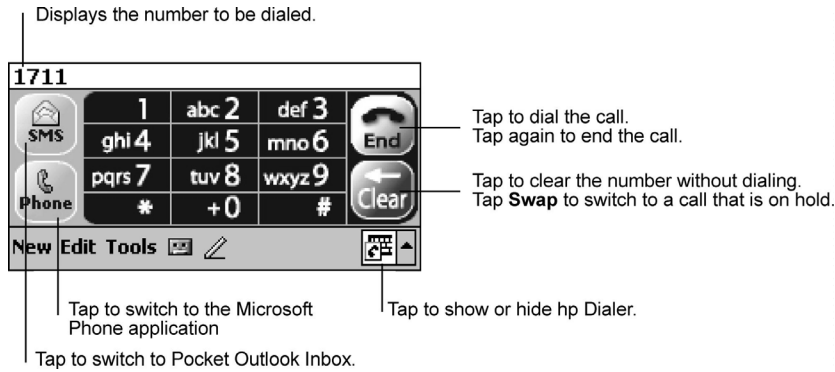

To dial a "+" symbol, tap and hold **0** on the on-screen keypad until a + appears.



managing phone numbers

Your hp Jornada offers several ways to keep track of phone numbers. You can keep track of names and phone numbers using Pocket Outlook Contacts, and synchronize the list with your desktop PC. You can also create "speed dial" entries for the numbers you call most.

You can also copy phone numbers that are stored on a SIM card to your Pocket Outlook Contacts.

To copy phone numbers from a SIM card

- On the **Start** menu, tap **Programs**, and then tap the SIM Contacts icon.

dialing from Pocket Outlook

You can dial a call directly from the Pocket Outlook Contacts list. For more information on creating entries in Contacts, see "Contacts: tracking friends and colleagues" in chapter 5.

To dial from Contacts

1. In the Contact list, tap and hold the contact you want to call.
2. On the pop-up menu, tap **Call**, and then tap the phone number displayed (for example, the contact's work or home telephone number).

using speed dial

Speed dial allows you to store frequently dialed numbers for easy access.

To create a speed dial entry

1. In the Microsoft Phone application, tap **Speed Dial**.
2. Tap **New**. Your Contacts list is displayed.
3. Tap the contact you wish to add.
4. Use the arrow buttons to select an available location.

To delete a speed dial entry

- Tap and hold the contact in the box to the right of the speed dial number, and then tap **Delete** on the pop-up menu.

managing calls using the call log

The Microsoft Phone application keeps track of calls you make, receive, or miss in the Call Log. The Call Log can also tell you when a call was initiated, how long it lasted, and provides easy access to any notes taken during the call.

To access the call log

- In the Microsoft Phone application, tap **Call Log**.

The call log offers five views:

- **All Calls** shows all calls made to and from the phone in chronological order.
 - **Missed** lists only calls that were not answered.
 - **Outgoing** only shows calls made from your phone.
-

- **Incoming** only shows calls made to your phone.
- **By Caller** is categorized alphabetically according to caller.

You can view information about your calls, for example, to track the number of minutes used in the current month. Options include—

- show total time statistics
- show total number of calls and total time since last time the call log was reset.
- delete items older than a specified period of time.

Tap within the white area of a call log entry to display a tool tip showing the date, time, and duration of a call.



If you use the phone while driving, it is recommended that you use the headset to allow hands-free operation. Some countries have laws that forbid using a mobile phone without a hands-free headset while driving.



changing services settings

The services settings allow you to access and configure any of the following services. The services you have depend on the services offered by your GSM/GPRS service provider and your subscription.

To configure a service

- Select the service, and then tap the **Get Settings** button to configure.

The following services may be available:

- **caller ID.** Allows you to choose whether you want your identity revealed to those you call.
 - **call forwarding.** Allows you to forward incoming calls to designated numbers either as a whole (all incoming calls) or you can choose to forward calls only if you are unavailable, busy, and/or you do not answer.
 - **call waiting.** Allows you to enable or disable call waiting.
-

- **voice mail and SMS.** Allows you to enter your voice mail access number and SMS service center number.
- **call barring.** To bar outgoing calls from your hp Jornada, dial ***33*[Password] #**, and then press the Send button. Your GSM service provider will provide your password. To deactivate call barring, dial **#33*[password]#**, and then press the Send button. To check the status of call barring, dial ***#33#**, and then press the Send button.

change phone settings

To adjust your phone settings, tap **Options** on the **Tools** menu.

- **Ring Type & Ring Tone.** These controls determine how your hp Jornada notifies you of an incoming phone call. You can choose from various ring tones, vibration, or a combination of ring and vibrate.

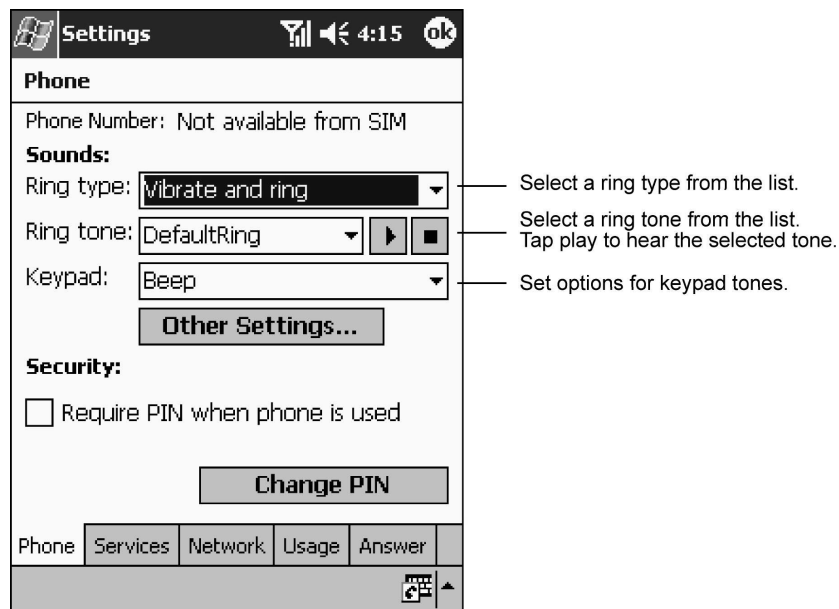

To change ring volume for phone, use the Alert page of the hp profiles application. On the **Start** menu, tap **Settings**, and then tap hp profiles.

- **Keypad.** This option controls whether tones are played while using the dialer. If set to Tones, the tone is heard continuously for as long as the dialer button is depressed. If set to Beep, the tone is played only for a moment.
- **Other Settings.** This will navigate to the Sounds and Reminders control panel, which allows you to set phone and system sounds.
- **Require PIN when phone is used.** This checkbox enables you to prevent unauthorized use of your phone by locking your SIM card using a four-to-eight-digit PIN.
- **Change PIN.** Tap to change your PIN, which must be between four and eight digits.

adjust network settings

You can specify how your phone chooses a wireless network, as there may be more than one network available. The selection you make remains active until you change it or change your SIM card. The availability of Network Settings may depend on the GSM features and services enabled by your GSM/GPRS service provider.

- **Current Network.** Displays the current registered network. Tap **Find Network** to refresh your current connection.
 - **Network Selection.** You can choose to have your network selected *automatically* (your hp Jornada decides on the most appropriate network) or *manually* (your hp Jornada lists all available systems, and you select the network you want to use from the list).
 - **Set Preferred Networks.** Tap **Set Preferred Networks** to select your preferred network operator for voice and data use.
-

locking your hp Jornada remotely

If you have set a password on your hp Jornada, a security feature enables you to remotely lock your hp Jornada by sending a special SMS message. This can be useful if you have lost your hp Jornada or if it contains sensitive information. When you find your hp Jornada, you can unlock the device by entering the preset password.



You must have pre-set either a simple 4-digit password or a strong alphanumeric password with timeout feature. For more information on setting a password, see Settings Help on your hp Jornada.

To remotely lock your hp Jornada using SMS

- Send the following SMS message to the hp Jornada:
HPREMOTELOCK: [password]
For example, if the password is 1234, send the message:
HPREMOTELOCK: 1234

personalize the phone display

Use the Phone Display application to personalize the information shown in the phone display. You can use the phone display to display a clock, a custom text message or a graphic that you choose.

To open the Phone Display application

- On the **Start** menu, tap **Settings**, and then tap the Phone Display icon.

You can choose to display the name of your GSM network, a clock, your next appointment, or a custom text message or bitmap image.

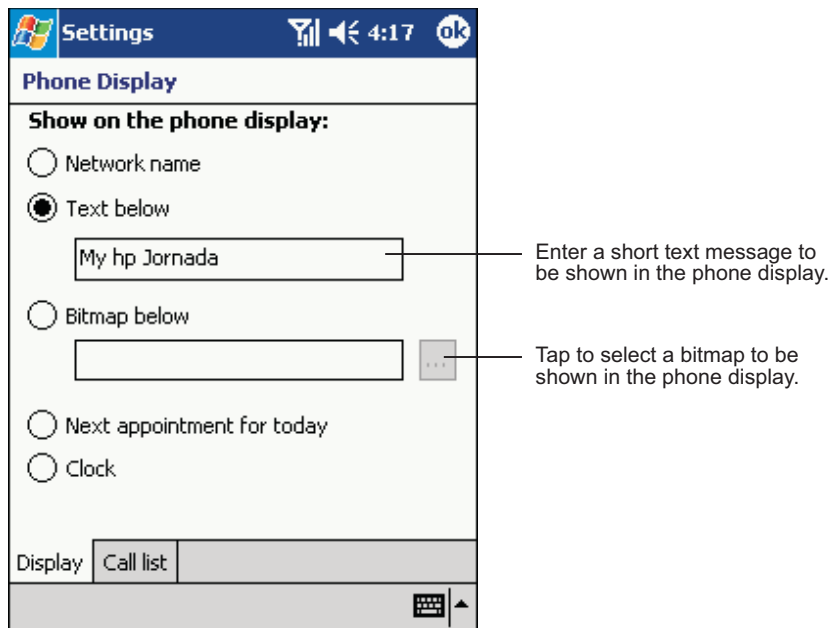

3 | getting connected

To get the most from your hp Jornada, you will want to get connect—to your desktop or notebook PC, as well as to the Internet or a corporate network. Your hp Jornada comes with everything you need to get connected, including a USB cradle and software for your desktop PC and built-in wireless connectivity for the Web or network. Using the wireless data functions of your hp Jornada, you can connect to the Internet and access a variety of wireless data services, such as email, wireless internet (Web/WAP), Short Message Service (SMS) and wireless access to a corporate network.

This chapter includes seven sections:

- **connecting to your desktop pc** describes how to connect to the desktop pc, so you can synchronize information on your hp Jornada with another computer.
 - **wireless data services** describes the text messaging and other wireless services, such as such as SMS, cell broadcast, and GPRS, that are available on your hp Jornada.
 - **connecting to the internet or a network** describes how to establish a network or Internet connection using the built-in wireless data functions.
 - **browsing the web** tells how to use Pocket Internet Explorer to browse the Web or a corporate network, and create mobile favorites for offline browsing.
 - **sending and receiving e-mail** tells how to send and receive e-mail messages using Pocket Outlook Inbox.
 - **hp MicroChaiVM** includes instructions for using the hp MicroChaiVM virtual machine to download and run MIDP Java™ applications (MIDlets), such as games and messaging utilities offered by your GSM/GPRS service provider.
 - **EzWAP** tells how to browse WML sites using the EzWAP browser.
-

connecting to your desktop pc

This section describes how to establish the connection between your hp Jornada and your desktop PC, and how to synchronize and transfer files between your hp Jornada and your desktop (or any PC that has Microsoft ActiveSync installed). In this section, you will learn to

- install Microsoft ActiveSync on your desktop PC.
- use ActiveSync to synchronize data between your hp Jornada and desktop PC.
- connect your hp Jornada to your desktop PC using either the USB cradle or the infrared port.

Microsoft ActiveSync

Microsoft ActiveSync enables you to synchronize the information on your desktop PC with the information on your hp Jornada. In addition, you can back up data from your hp Jornada to your desktop PC and restore this data to your hp Jornada, and copy files between your hp Jornada and desktop PC.

Before you begin synchronization, install ActiveSync on your desktop PC from the Pocket PC Companion CD. ActiveSync is already installed on your hp Jornada.

After installation is complete, the ActiveSync Setup Wizard helps you connect your hp Jornada to your desktop PC, set up a partnership so you can synchronize information between your hp Jornada and your desktop computer, and customize your synchronization settings. Your first synchronization process will begin automatically when you finish using the wizard.

synchronizing data

Synchronization compares the data on your hp Jornada with your desktop PC and updates both computers with the most recent information. For example, you can

- synchronize Microsoft Word and Microsoft Excel files between your hp Jornada and desktop PC. Your files are automatically converted to the correct format.

- synchronize e-mail messages in your hp Jornada Inbox with e-mail messages in Microsoft Outlook on your desktop PC.
- copy favorite Web site addresses and any Web pages you have marked for offline viewing in Microsoft Internet Explorer to your hp Jornada.
- keep your Pocket Outlook Contacts, Calendar, and Tasks databases up-to-date by synchronizing your hp Jornada with Microsoft Outlook data on your desktop PC.

Synchronization with Microsoft Outlook 2002 requires ActiveSync 3.5 on the desktop PC.



After you synchronize, the information you have stored on your desktop PC is copied to your hp Jornada so you can take it with you when you go. Use ActiveSync options to select which information types are synchronized and to control how much data is synchronized. For example, if you choose to synchronize Calendar data, you can specify how many weeks of past appointments you want synchronized. By default, ActiveSync does not automatically synchronize all types of information. Use ActiveSync options to turn synchronization on and off for specific information types.

After you have set up ActiveSync and completed the first synchronization, you can control when synchronization occurs by selecting a synchronization mode. For example, you can synchronize continually while your hp Jornada is in the cradle, or only when you choose the **Synchronize** command.

To start synchronization from your hp Jornada

1. Connect your hp Jornada to your desktop PC. For more information, see “connecting your hp Jornada,” below.
2. On the **Start** menu, tap **ActiveSync**.
3. Tap  to begin synchronization.

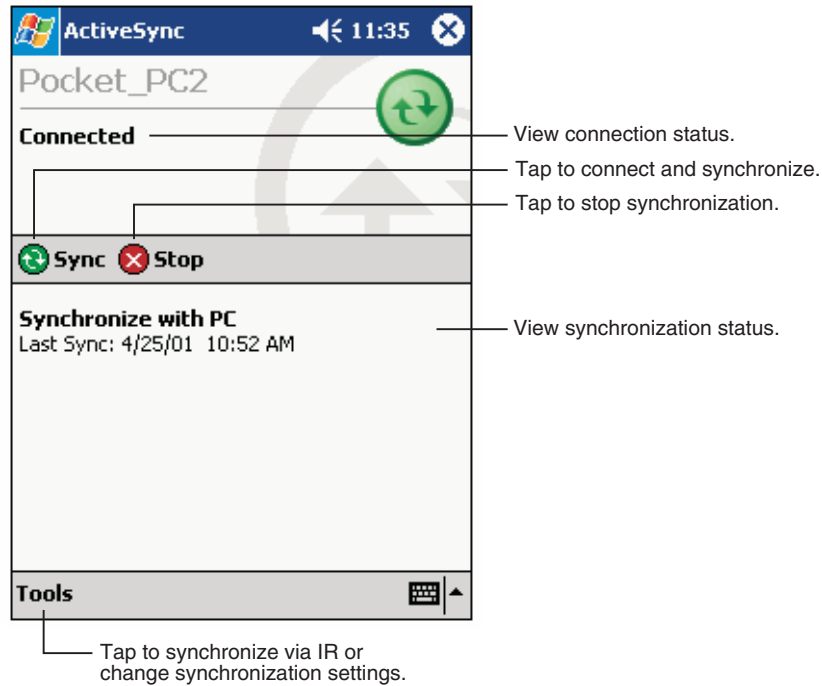

For detailed instructions on setting ActiveSync options and using ActiveSync on your desktop PC, see ActiveSync Help on the desktop PC. For more information on using ActiveSync on your hp Jornada, see ActiveSync Help on your hp Jornada.

synchronizing from a remote location

You can also synchronize by dialing in to your desktop PC or connecting over a network. This can be useful if you need to synchronize files or PIM information while traveling. Before you leave, you must configure both your hp Jornada and your desktop PC.

on your hp Jornada

Create a partnership between your hp Jornada and the desktop PC using one of the direct connection methods (USB cradle or infrared connection) described in this chapter. You must also configure a connection on your hp

Jornada, as described in “connecting to the internet or to a network” later in this chapter.

on your desktop PC

Before you can synchronize remotely, the desktop PC or network server must be configured to allow your hp Jornada to connect. Depending on the version of Windows running on the desktop PC, you may need to install and configure Remote Access Services or Dial-Up Networking on the desktop PC.

You must also ensure that ActiveSync is configured to allow a network connection. For more information, see ActiveSync Help on your desktop PC.

Follow these steps to prepare your desktop PC before you leave:

- if you are using a modem on your desktop PC, turn the modem on before you leave.
- leave your desktop PC on, and be sure you logged on under the same user name that you used when you created the partnership.
- ensure your PIM program and e-mail program (Microsoft Outlook or Microsoft Exchange) are running.

If you receive an error message on your hp Jornada that states that an information type needs attention, or if unresolved items are reported after synchronization, you must synchronize directly with your desktop PC using the USB cradle, an infrared connection, or an optional serial cable.

copying files between your hp Jornada and your desktop pc

You can copy files between your hp Jornada and desktop PC by dragging icons to or from the Mobile Device window or by using the **Cut**, **Copy**, and **Paste** commands on the **Edit** menu.

Files created on your desktop PC may need to be converted before you can use them on your hp Jornada, and files created on your hp Jornada may need to be converted before you can use them on your desktop PC. By default, ActiveSync automatically converts files to the appropriate type; however, you can choose not to convert files, or you can choose to specify the conversion for each type of file by changing options in ActiveSync.

backing up data with activesync

To prevent loss of data, you should back up your hp Jornada frequently using either Microsoft ActiveSync or the hp backup application. When you back up your hp Jornada using ActiveSync, the backup file contains all the files, databases, PIM information, and RAM-based programs on your hp Jornada. The backup file is stored on your desktop PC.



hp backup enables you to back up your PIM databases to an optional CompactFlash memory card. For more information on hp backup, see “backing up and restoring data” in chapter 4.

If you have established a partnership between your hp Jornada and desktop PC, you can set ActiveSync to back up data automatically each time you connect. You can also back up your hp Jornada manually any time you want. ActiveSync lets you decide whether to back up all data each time, or only new and updated information.

When you use the backup file to restore data to your hp Jornada, data on your hp Jornada is replaced with the data stored in the backup file. If you have created files on your hp Jornada since the last backup and do not want to delete these files during the restore process, move the files from your hp Jornada to your desktop PC before restoring data. You can restore data using ActiveSync or the hp backup application.



Restoring data from ActiveSync replaces all data stored on your hp Jornada. Any data added after the backup file was created will be lost.

For more information on backing up and restoring data using Microsoft ActiveSync, see ActiveSync Help on your desktop PC.

connecting your hp Jornada

You can connect your hp Jornada to a desktop computer in several ways:

- using the USB cradle that is included with your hp Jornada. The USB cradle connects to a USB port on your desktop PC.

- using the infrared port on your hp Jornada. You can connect your hp Jornada to an infrared-equipped desktop or notebook PC using the infrared port. Many notebook PCs have built-in infrared ports; however, you may need to purchase and install an infrared transmitter for your desktop PC.
- over a network or dial-up connection. You can synchronize while connected to your desktop PC by a dial-up connection or over a local area network (LAN).
- using a serial cable or cradle. If your desktop PC does not have a USB port or an infrared transmitter, or if your operating system does not support these connection methods, you can purchase an optional serial cable or serial cradle that enables you to connect your hp Jornada to a serial port. Instructions on establishing a serial connection are included with these accessories. Note that Windows 95 and Windows NT® do not support USB or infrared connectivity.

Install ActiveSync on your desktop PC before connecting your hp Jornada by USB.



connecting by usb cradle

The USB cradle included with your hp Jornada provides a convenient way to connect to your desktop PC. In addition to enabling synchronization, the USB cradle charges the batteries on your hp Jornada. Keep your hp Jornada in the cradle when you are not carrying it with you, so it is always charged, synchronized, and ready to go.

Do not shut down or restart your desktop PC while your hp Jornada is connected. Turn off your hp Jornada or remove it from the cradle before you shut down your desktop PC.



Before you connect, be sure of the following: your desktop PC is on, you have installed ActiveSync on your desktop PC, and ActiveSync is configured to allow a USB connection.



To connect by USB cradle

1. Connect the dc plug from the ac adapter to the dc jack on the cradle cable, and plug the ac adapter into a wall outlet.
2. Connect the cable from the cradle to a USB port on your desktop PC.
3. Slide your hp Jornada into the cradle. Your hp Jornada should start automatically and establish a connection to the desktop PC.



Connecting to your PC



When you remove your hp Jornada from the cradle, hold the cradle down with one hand, and gently lift the hp Jornada with the other to avoid putting stress on the connectors.

connecting by infrared

The infrared port on your hp Jornada provides a convenient way to connect to an IrDA-equipped PC without using a cable or cradle. Many notebook computers have built-in infrared ports; however, you may need to install and configure an infrared port on a desktop PC. To install the port, follow the manufacturer's instructions. More information about infrared drivers for Microsoft Windows is available on the Microsoft Mobile Devices Web site at www.microsoft.com/mobile/pocketpc.

For complete instructions on connecting to your desktop PC by infrared, refer to ActiveSync Help on your desktop PC.

getting started with wireless data functions

The wireless data functions on your hp Jornada use the Global System for Mobile Communications (GSM) and general packet radio service (GPRS). To use the wireless data features of your hp Jornada, you must establish a subscription with a GSM/GPRS service provider. The features available to you depend on the services offered by the service provider and the details of your subscription.

Check with your GSM/GPRS service providers for a list of available wireless data services. Your service provider may charge additional fees for use of data services. Check with your service provider for more information on rates and availability of wireless data services with your subscription.

Your hp Jornada supports the following wireless data services:

- **CBSMS (cell broadcast).** Many GSM/GPRS service providers offer cell broadcast services, which transmit text-based information, such as news, stock updates, and weather reports to phones on their network.
- **GSM data transmission (circuit-switched data).** GSM data services enable you to use the GSM component of your hp Jornada as a built-in modem. Connect to the Internet through an ISP or dial in to a corporate network to synchronize your hp Jornada, browse the Web, or send and receive e-mail.
- **GPRS data transmission.** GPRS is a high-speed data-only service that enables you to transmit data over a mobile telephone network. Subscribing to a GPRS service allows you to transfer files, browse the Web, and receive streaming audio and video on your hp Jornada.

receiving cbsms messages

Your hp Jornada is capable of receiving cell broadcast short message service (CBSMS) messages. CBSMS is a service provided by many mobile telephone service providers to transmit brief text messages to mobile phones on their system. Messages typically include general information such as news, financial data, and local weather reports. To receive CBSMS messages, you must have an account with a mobile telephone service provider that offers the CBSMS service.

CBSMS messages are transmitted on channels. Each channel carries messages for a specific topic. Your hp Jornada will receive all channels broadcast by your service provider; you select which messages you want to receive on your hp Jornada by activating only the channels that interest you.

If your service provider gave you a list of available channels and their ID numbers, you can activate channels by entering the ID numbers from this list. If you do not have a list of available channels, you will want to activate channel 000, which is the topic index. When the topic index is activated, your hp Jornada will receive a current list of channels.

Many GSM/GPRS service providers broadcast SMS messages in more than one language. You can filter incoming messages by language, so you receive only messages in the language(s) you choose. Use the Cell Broadcast control panel to activate channels and to filter incoming messages based on language.

To turn on CBSMS services

1. On the **Start** menu, tap **Settings**.
2. On the **Connections** tab, tap the Cell Broadcast icon.
3. Next to **Message reception**, select **On**.

To activate a channel (if you know the channel ID)

1. On the Channels tab, tap **Add Channel**.
2. In the **Channel ID** box, enter the ID number of the channel you want to subscribe to. In the **Description** box, enter a description of the channel content.

3. Select the **Activate Channel** check box.
4. Tap **OK** to close the Cell Broadcast application.

You may not receive messages right away; the frequency with which messages are transmitted depends on your mobile telephone service provider.



Activate channel 000, topic index, to ensure you always have the current list of channels with you on your hp Jornada.

To activate a channel from the topic list

1. Tap the **Index** tab to see a list of available topics.
 2. Tap [+] next to a topic heading to see a list of available channels for that topic.
 3. Tap a channel in the list to select it, and then tap **Add Channel**.
-



If the topic index tab displays the "No topic index received" message, you must activate channel 000, or wait for the list to be transmitted by your GSM/GPRS service provider.

To filter incoming messages

- On the **Language** tab, select the check box next to the language(s) you want to receive.
-

connecting to the internet or to a network

With built-in wireless connectivity, your hp Jornada enables you to connect to an Internet service provider (ISP) or to your corporate network, so you can access e-mail, browse the Internet, or retrieve files from a corporate network, whether you are at home or on the road. This section describes

- the methods you can use to connect your hp Jornada to the Internet or to a network
- the process of configuring your hp Jornada to connect to an ISP or network.

Your hp Jornada gives you two options for connecting to an ISP or network. You can use the integrated GSM phone or subscribe to high-speed GPRS services. Each of these methods requires that you have a subscription with a GSM/GPRS service provider or an ISP.

connecting using the integrated GSM modem

Your hp Jornada is capable of sending and receiving data via a mobile telephone network using the GSM protocol. If your GSM/GPRS service provider supports remote data connection, you can use the built-in phone functionality of your hp Jornada to connect to the Internet or to a remote computer. To send or receive data over a GSM network, you must have an account with a mobile telephone service provider that supports GSM data services, and the service provider must enable the data features on your account. The maximum data transfer rate of the GSM modem is 9.6 kbps.¹

Use a GSM modem connection to

- send and receive e-mail messages by using Inbox. Before you can use Inbox, you need to provide the information it needs to communicate with the e-mail server. For specific instructions, see “connecting directly to an e-mail server,” later in this chapter.

¹ Actual data transfer rates depend on the capabilities and services of the GSM/GPRS service provider and/or Internet service provider. Data transfer rates presented in this User's Guide are theoretical maximums.

- synchronize data with a computer on the network. For more information, see ActiveSync Help on your desktop PC.

configuring a GSM data connection (circuit-switched data)

Before you can configure your hp Jornada to connect to a remote computer using the GSM modem, you must configure a connection. Ensure that you have a subscription to the circuit-switched data (CSD) network. Check with your service provider for details. You will need the following information:

- the phone number or dial string of the ISP or remote computer
- any port settings, TCP/IP settings, or the name of the Domain Name Server(s) (DNS), if required by the network you are connecting to
- a user name and password provided by the ISP or account administrator

In addition, you need an account with the ISP or corporate network you are connecting to, or access permission to dial in to a specific computer.

If you plan to use the account to send or receive e-mail messages directly from your hp Jornada, you must also obtain the following information from your ISP or account administrator:

- a user name and password for your e-mail account. (These may be different from the user name and password you use to connect.)
- the name of the POP3 or IMAP4 server (for incoming messages).
- the name of the SMTP server (for outgoing messages).

Before you can connect to an ISP or dial in to a specific desktop PC, you must create a connection for that service on your hp Jornada.

To configure your GSM connection (CSD)

1. On the **Start** menu, tap **Settings**.
2. On the **Connections** tab, tap the Connections icon.
3. In the drop-down list, select **New**.
4. Tap the **Modem** tab, and then tap **New**.

5. Enter a name for the connection. The name can be anything you want, but should be descriptive, for example "Office Dial-Up."
6. In the **Select a modem** list, tap **Cellular Line**.
7. If your service provider or network administrator specified TCP/IP settings, port settings, or the IP addresses for your DNS servers, tap **Advanced**, and then enter this information on the appropriate tabs. Tap **OK**.
8. Tap **Next**.
9. Enter the phone number of the service or remote computer you are connecting to.
10. Tap **Finish**.

dialing a GSM connection

Use Connection Manager to select the connection you want to use and to dial the connection.

To dial a connection

1. On the **Start** menu, tap **Settings**.
2. On the **Connections** tab, tap the Connections icon.
3. In the drop-down list, select the service that you want.
4. Tap **Connect**.

closing a GSM connection

If you opened the connection from a program, such as Inbox or Pocket Internet Explorer, close that program first. Then, tap the Data Connection icon  in the Command bar of the Today screen, and then tap **End**.

connecting using GPRS

Your hp Jornada is capable of receiving general packet radio services (GPRS), a high-speed data-only service that transmits data over a mobile telephone network. In addition, GPRS provides an “always on” connection.

To use GPRS, you must have a subscription with a GSM service provider that supports GPRS, and the service provider must enable the GPRS features on your account.

configuring a GPRS connection

Before you can connect to a GPRS network, you must configure a connection. You will need the following information from your GPRS service provider:

- the name of the Access Point Node (APN) used by your service.
- the name of the Domain Name Server(s) (DNS), if required.

To configure your GPRS connection

1. On the **Start** menu, tap **Settings**.
2. On the **Connections** tab, tap the Connections icon.
3. In the drop-down list, tap **New**.
4. Tap the **Modem** tab, and then tap **New**.
5. Enter a name for the connection. The name can be anything you want, but should be descriptive, for example “My GPRS Connection.”
6. In the **Select a modem** list, tap **Cellular Line (GPRS)**.

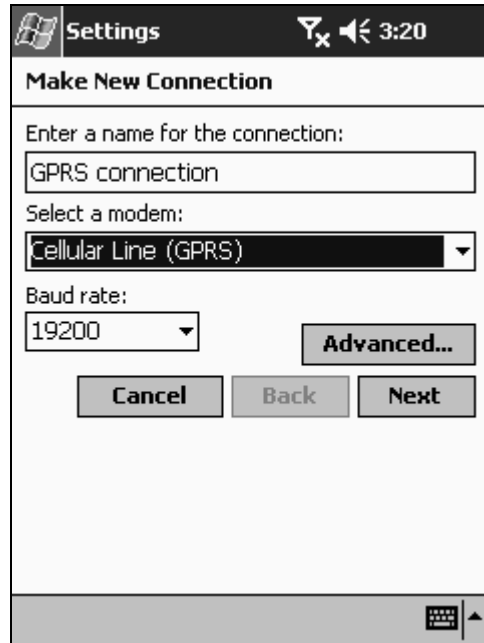

You do not need to make a selection under **Baud rate**. The baud rate is ignored when making a GPRS connection.



7. If your GPRS service provider specified the IP addresses for your DNS servers, tap **Advanced**, and then tap the **Name Servers** tab. Select **Use specific server addresses**, and then enter the DNS addresses provided by your GPRS service provider. Tap **OK**.
8. Tap **Next**.
9. Under **Access Point Name**, enter the APN provided by your GPRS service provider.
10. Tap **Finish**.

connecting to the GPRS network

Use the hp GPRS application to set options for how your device attaches to the GPRS network. Your service provider can provide additional information on connecting to the Internet using GPRS.

To start hp GPRS

1. On the **Start** menu, tap **Settings**.
2. On the **System** tab, tap **hp GPRS**.
3. If you want your device to automatically attach and/or detach from the network, select the appropriate options under **GPRS Settings**.

The GPRS application also displays the total number of bytes transferred and number of bytes transferred in the last context. Click **Reset** to reset the Total

GPRS authentication

You must choose the authentication method required to connect to your GPRS network. Check with your GPRS service provider to determine the authentication method used by your network. There are three methods available:

- None - No authentication required
- PAP- Password Authentication Protocol (PAP)
- CHAP - Challenge Handshake Authentication Protocol (CHAP)

get help on connecting

More information on the procedures described here, as well as information on additional procedures, can be found in the following locations:

- "sending and receiving e-mail," later in this chapter
- online Help on the your hp Jornada
- ActiveSync Help on your desktop PC.

For troubleshooting information, see the Pocket PC Web site at www.microsoft.com/mobile/pocketpc.

browsing the web (or a corporate intranet)

After you are connected to an ISP or to a corporate network, you can browse the Internet or a corporate intranet. You can also use Pocket Internet Explorer to browse Web content while you are not connected—by downloading mobile favorites and channels to your hp Jornada.

using microsoft pocket internet explorer

Use Microsoft Pocket Internet Explorer to view Web pages in either of these ways:

- connect to an ISP or network and browse the Web. To do this, you'll need to create the connection first, as described earlier in this chapter.
- during synchronization with your desktop PC, download your favorite links and mobile favorites that are stored in the Mobile Favorites subfolder in Internet Explorer on the desktop PC.

While you are connected to an ISP or network, you can also download files and programs from the Internet or intranet.

To start Pocket Internet Explorer

- On the **Start** menu, tap **Internet Explorer**.
-

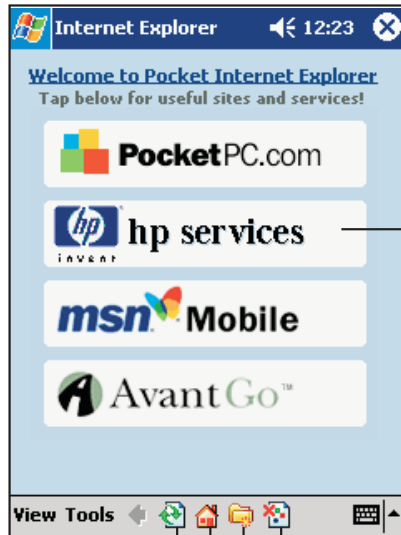

Tap to visit the hp Jornada Web site.

Hide pictures button.

Favorites button.

Home button.

Refresh button.

The Pocket Internet Explorer home page

To view mobile favorites and channels:

1. Tap the Favorites button to display your list of favorites.
2. In the list, tap the page you want to view.

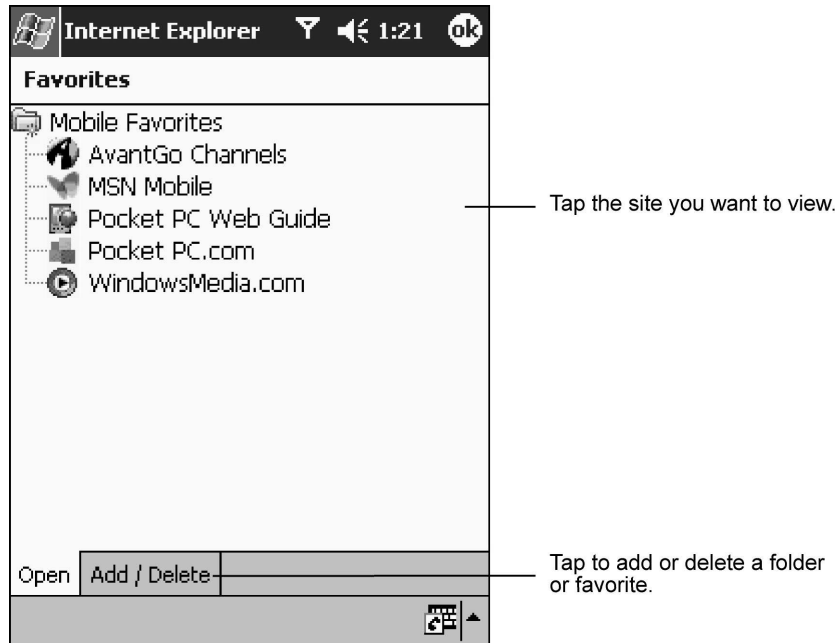

You will see the page that was downloaded the last time you synchronized with your desktop PC. If the page is not on your hp Jornada, it will be dimmed in the Favorites list. You will need to synchronize with your desktop PC again to download the page to your hp Jornada or connect to the Internet to view the page.

To browse the Internet

1. Set up a connection to your ISP or corporate network as described earlier in this chapter.
2. To connect and start browsing, do one of the following:
 - tap the Favorites button and then tap the favorite you want to view.

- tap **View**, and then tap **Address Bar**. In the address bar that appears at the top of the screen, enter the URL you want to visit and then tap **Go**. Tap the arrow to choose from previously entered addresses.

the mobile favorites folder

Only items stored in the Mobile Favorites subfolder in the Favorites folder in Internet Explorer on your desktop PC will be synchronized with your hp Jornada. This folder is created automatically when you install ActiveSync.

favorite links

During synchronization, the list of favorite links in the Mobile Favorites folder on your desktop PC is synchronized with Pocket Internet Explorer on your hp Jornada. Both computers are updated with changes made to either list each time you synchronize. Unless you mark the favorite link as a mobile favorite, only the link will be downloaded to your hp Jornada, and you must connect to your ISP or network to view the content. For more information on synchronization, see ActiveSync Help on your desktop PC.

mobile favorites

If you are using Microsoft Internet Explorer 5.0 or later on your desktop PC, you can download mobile favorites. Synchronizing mobile favorites downloads Web content to your hp Jornada so that you can view pages while you are not connected to your ISP or your desktop PC.

Use the Internet Explorer 5.0 plug-in installed with ActiveSync to create mobile favorites quickly.

To create a mobile favorite

1. In Internet Explorer 5.0 on your desktop PC, click **Tools**, and then click **Create Mobile Favorite**.
2. To change the link name, enter a new name in the **Name** box.
3. Optionally, in **Update**, select a desired update schedule.
4. Click **OK**. Internet Explorer downloads the latest version of the page to your desktop PC.

5. If you want to download the pages that are linked to the mobile favorite you just created, in Internet Explorer on the desktop PC, right-click the mobile favorite and then click **Properties**. On the **Download** tab, specify how many levels of links you want to download. To conserve memory on your hp Jornada, download only one level of links.
6. Synchronize your hp Jornada and desktop PC. Mobile favorites that are stored in the Mobile Favorites folder in Internet Explorer 5.0 are downloaded to your hp Jornada.

If you do not specify an update schedule, you must manually download content to keep the information updated on your desktop PC and hp Jornada. Before synchronizing, in Internet Explorer on your desktop PC, click **Synchronize** on the **Tools** menu. You will see the last time content was downloaded to the desktop PC, and you can manually download content if needed.



You can add a button to the Internet Explorer toolbar for creating mobile favorites. In Internet Explorer 5.0 on your desktop PC, click **Toolbars** on the **View** menu, and then click **Customize**.



conserving memory

Mobile favorites take up storage memory on your hp Jornada. Follow these tips to minimize the amount of memory used:

- in the settings for the Favorites information type in ActiveSync options, turn off pictures and sounds or stop some mobile favorites from being downloaded to your hp Jornada. For more information, see ActiveSync Help.
- limit the number of downloaded linked pages. In Internet Explorer on the desktop PC, right-click the mobile favorite you want to change, and then click **Properties**. On the **Download** tab, specify zero or one for the number of linked pages you want to download.

using avantgo channels

AvantGo is a free interactive service that gives you access to personalized content and thousands of popular Web sites. You subscribe to AvantGo

channels directly from your hp Jornada. Then, you synchronize your hp Jornada with your desktop PC or connect to the Internet to download the content. For more information, visit the AvantGo Web site.

To sign up for AvantGo

1. In ActiveSync options on the desktop PC, turn on synchronization for the AvantGo information type.
2. In Pocket Internet Explorer on your hp Jornada, tap the Favorites button to display your list of favorites.
3. Tap the AvantGo Channels link.
4. Tap the Activate button.
5. Follow the directions on the screen. You will need to synchronize your hp Jornada with your desktop PC and then tap the My Channels button to complete the AvantGo setup.

When synchronization is complete, tap the AvantGo Channels link in your list of favorites to see a few of the most popular channels. To add or remove channels, tap the **Add** or **Remove** link.

sending and receiving e-mail and sms messages

If you have an e-mail account with an ISP or on a corporate network, you can use Inbox to send and receive e-mail messages in two ways:

- synchronize e-mail messages with Microsoft Exchange or Microsoft Outlook on your desktop PC.
- send and receive e-mail messages by connecting directly to an e-mail server through an ISP or a network.

synchronizing e-mail messages

You can synchronize e-mail messages as part of the general synchronization process whenever you connect your hp Jornada to your desktop PC. First, you must enable Inbox synchronization in ActiveSync.

For information on enabling Inbox synchronization, see ActiveSync Help on the desktop PC.

During synchronization, the following occurs:

- messages are copied from the mail folders of Exchange or Outlook on your desktop PC to the ActiveSync folder in Inbox on your hp Jornada. By default, you will receive messages from the past 3 days only, the first 100 lines of each message, and file attachments of less than 100 KB in size.
- e-mail messages in the Outbox folder on your hp Jornada are transferred to Exchange or Outlook, and then sent from those programs.
- e-mail messages in subfolders must be selected in ActiveSync on your desktop PC in order to be transferred.

connecting directly to an e-mail server

In addition to synchronizing e-mail messages with your desktop PC, you can send and receive e-mail messages by connecting to an e-mail server using GSM circuit-switched data (CSD).

In addition to the creating a connection to a network or an ISP, you must set up an e-mail “service” in Inbox.

The ISP or network must use a POP3 or IMAP4 e-mail server and an SMTP gateway.



To set up an e-mail service

- In Inbox, tap **Services**, and then tap **New Service**. Follow the directions in the New Service Wizard.

You can use multiple e-mail services to receive your messages. For each e-mail service you intend to use, first set up and name the e-mail service. If you use the same service to connect to different mailboxes, set up a separate service for each mailbox.

To connect to an e-mail service

- In Inbox, tap **Services**, and then tap **Connect**.

When you connect to the e-mail server, new messages are downloaded to the Inbox folder on your hp Jornada, messages in the Outbox folder are sent, and messages that have been deleted on the e-mail server are removed from the Inbox folder on your hp Jornada.

Messages that you receive directly from an e-mail server are linked to your e-mail server rather than your desktop PC. When you delete a message on your hp Jornada, it is also deleted from the e-mail server the next time you connect based on the settings you selected in ActiveSync.

You can work online or offline. When working online, you read and respond to messages while connected to the e-mail server. Messages are sent as soon as you tap **Send**, which saves space on your hp Jornada.

When working offline, you should download new message headers or partial messages, and then you can disconnect from the e-mail server while you decide which messages to download completely. The next time you connect, Inbox downloads any messages you marked for retrieval and sends the messages in your Outbox folder.

using the message list

Messages you receive are displayed in the message list. By default, the most recently received messages are displayed first in the list.

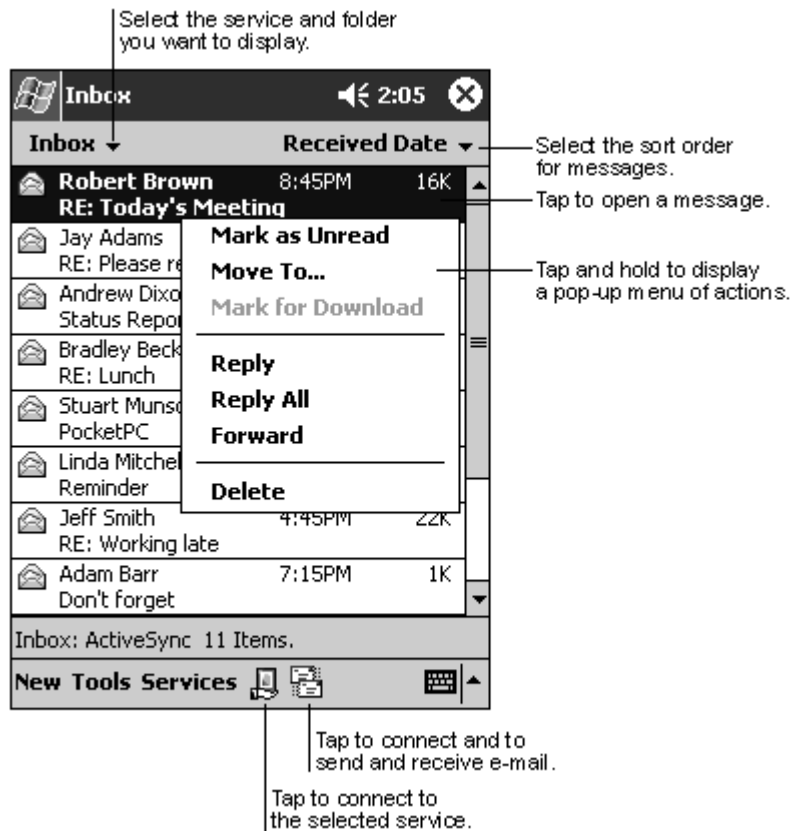

When you receive a message, tap it to open it. Unread messages are displayed in bold.

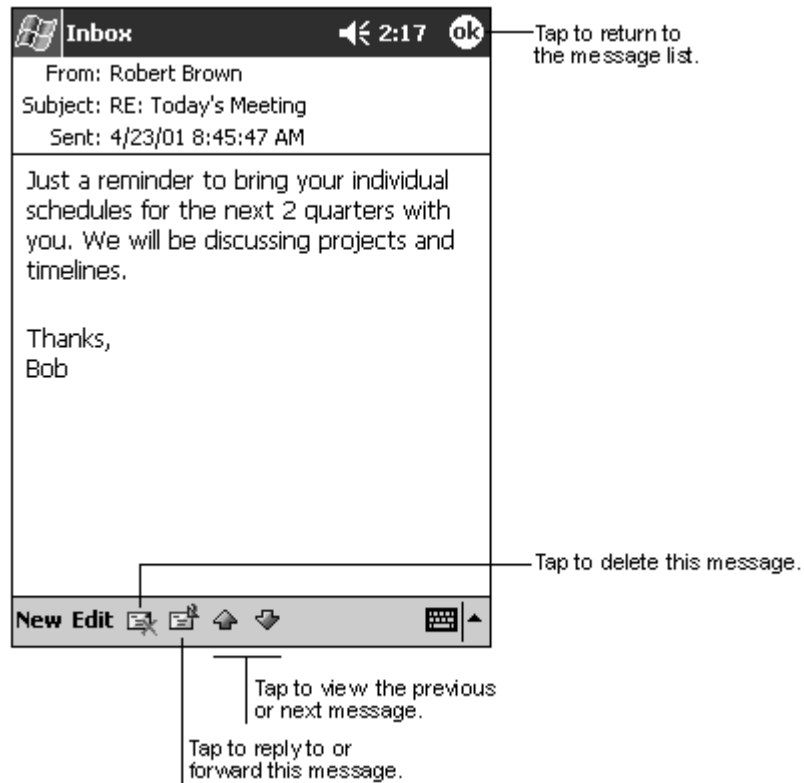

When you connect to your e-mail server or synchronize with your desktop computer, by default, you will receive messages from the last five days only, the first 100 lines of each new message, and file attachments of less than 100 KB in size. The original messages remain on the e-mail server or your desktop PC.

You can mark the messages that you want to retrieve in full during your next synchronization or e-mail server connection. In the message list, tap and hold the message you want to retrieve. On the pop-up menu, tap **Mark for Download**. The icons in the Inbox message list give you visual indications of message status.

You specify your downloading preferences when you set up the service or select your synchronization options. You can change them at any time:

- change options for Inbox synchronization using ActiveSync options. For more information, see ActiveSync Help.
- change options for direct e-mail server connections in Inbox on your hp Jornada. Tap **Tools**, and then tap **Options**. On the **Service** tab, tap the service you want to change. Tap and hold the service and select **Delete** to remove a service.

composing messages

You can use Inbox to compose both e-mail messages and SMS messages.

To compose a message

1. Tap **New**.
2. In the **To** field, enter an e-mail or SMS address of one or more recipients—separating them with a semicolon, or select a name from the contact list by tapping the **Address Book** button. When you send SMS messages to contacts save in your Pocket Outlook Contacts database, be sure to use the number in the **Mobile** field. The contact must be selected (highlighted in blue) before it can be sent.

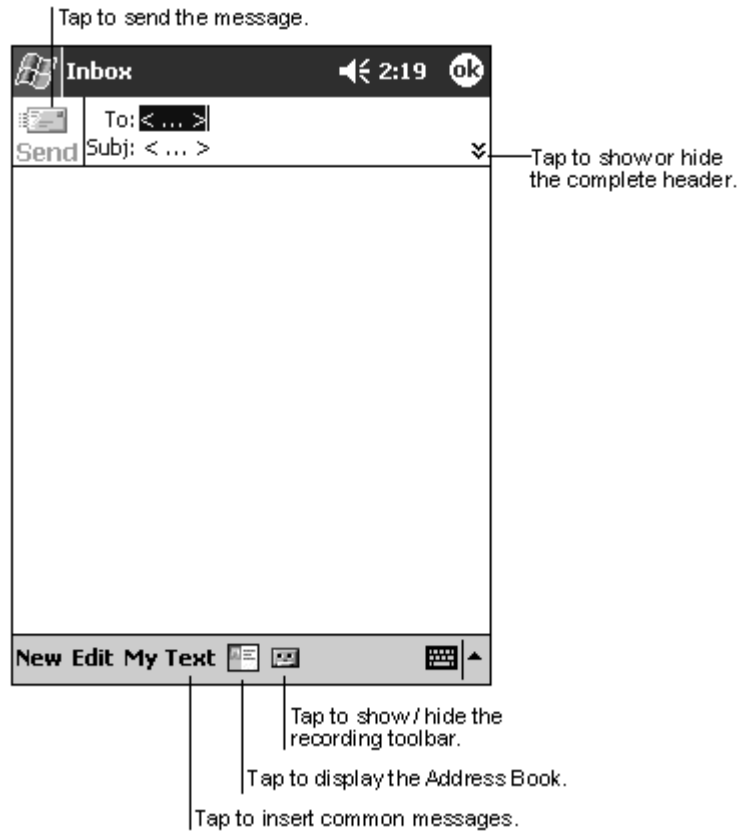

3. Compose your message. To enter preset or frequently used messages, tap **My Text** and select a message.
4. If you are sending an SMS message and want to know if it was received, tap **Edit**, tap **Options**, and then select **Request SMS text message delivery notification**.
5. Tap **Send** when you've finished the message.

The message is placed in the Outbox folder on your hp Jornada and will be delivered in one of two ways:

- the message is transferred to the Outbox folder in Exchange or Outlook on your desktop PC and sent the next time you synchronize.
- the message is transferred to your e-mail server the next time you connect. In Inbox, make sure the appropriate service is selected on the **Services** menu, and then tap the **Connect** button (or **Connect** on the **Services** menu).

managing e-mail messages and folders

By default, messages are displayed in one of five folders for each service you have created: Inbox, Deleted Items, Drafts, Outbox, and Sent Items. The Deleted Items folder contains messages that have been deleted on your hp Jornada. The behavior of the Deleted and Sent Items folders depends on the options you have chosen. In the message list, tap **Tools**, and then tap **Options**. On the **Message** tab, select your options.

If you want to organize messages into additional folders, tap **Tools**, and then tap **Manage Folders** to create new folders. To move a message to another folder, in the message list, tap and hold the message and then tap **Move to** on the pop-up menu.

The behavior of the folders you create depends on whether you are using ActiveSync, POP3, or IMAP4:

- if you use ActiveSync, e-mail messages in the Inbox folder in Outlook will automatically be synchronized with your hp Jornada. You can select to synchronize additional folders by designating them for ActiveSync. The folders you create and the messages you move will then be mirrored on the server. For example, if you move two messages from the Inbox folder to a folder named Family, and you have designated Family for synchronization, the server creates a copy of the Family folder and copies the messages into that folder. You can then read the messages while away from your desktop computer.
-

- if you use POP3 and you move e-mail messages to a folder you created, the link is broken between the messages on the device and their copies on the mail server. The next time you connect, the mail server will see that the messages are missing from the device Inbox and delete them from the server. This prevents you from having duplicate copies of a message, but it also means that you will no longer have access to messages that you move to folders created from anywhere except the device.
- if you use IMAP4, the folders you create and the e-mail messages you move are mirrored on the server. Therefore, messages are available to you any time you connect to your mail server, whether it is from your device or desktop computer. This synchronization of folders occurs whenever you connect to your mail server, create new folders, or rename/delete folders when connected.

hp MicroChaiVM

hp MicroChaiVM, a small-footprint embedded virtual machine for running Java™ applications, allows you to extend the capabilities of your hp Jornada. In addition to running Microsoft Pocket PC applications, you can download on demand and run Java applications that are based on the Mobile Information Device Profile (MIDP) specification. You can download these applications via a GSM network or through a modem connection. With hp MicroChaiVM, your hp Jornada can now run many readily available MIDP applications, which are commonly referred to as MIDlets.

A growing number of GSM service providers offer MIDP-based services. With hp MicroChaiVM, which complies with the public MIDP specification, you can take advantage of the mobile services, games, and messaging options offered by your service provider.



To start hp MicroChaiVM

1. On the **Start** menu, tap **Programs**.
2. In the hp Applications folder, tap the hp MicroChaiVM icon.

using hp MicroChaiVM

The Application Manager screen, your interface with hp MicroChaiVM, has the following items in its menu bar:

- **Options** enables you to view the version of hp MicroChaiVM that you are running and to customize hp MicroChaiVM by adjusting the settings of the virtual machine, HTTP proxy, and other display options.
- **Launch** enables you to launch a MIDlet after it is installed.
- **Install** enables you to install a MIDlet suite from a file system or from the Web.
- **Menu** enables you to show, hide, and get information, and update or delete a MIDlet suite.

Your hp Jornada includes a pre-installed a sample MIDlet for you to use as you explore the features of hp MicroChaiVM.

installing a MIDlet suite

MIDP applications are packaged and distributed in MIDlet suites, which come in a standard format of a .jar file and a .jad file. Using hp MicroChaiVM, you can install a MIDlet suite from a file system or directly from the Web using HTTP.



Installing a MIDlet suite is a two-step process. You first install the .jad file, which will automatically direct hp MicroChaiVM to the .jar file. You must install both the .jad and .jar files for the MIDlet to work.

To install a MIDlet suite from a file system

1. Transfer the .jad and .jar files for the desired MIDlet suite onto your hp Jornada. For example, use ActiveSync to place the files **My Documents**. For more information, see “connecting to your desktop pc” earlier in this chapter.



If you install a MIDlet from a Compact Flash card, you must place the .jar and .jad files in the **My Documents** folder on the card. If necessary, create a **My Documents** folder on the Compact Flash card and place the .jar and .jad files in this folder or any of its subfolders.

2. On the menu bar of the Application Manager screen, tap **Install**.
3. On the Install Source screen, tap **Select JAD file**.
4. Browse to select the .jad file for the MIDlet suite.
5. If the Application Descriptor screen shows the MIDlet that you want to install, tap **Yes**. After a successful installation, a Success screen will be displayed.
6. On the menu bar of the Success screen, tap **Finish**. The MIDlet will appear on the Application Manager screen.



If you are using the File Explorer on your hp Jornada and find a JAD file with the hp MicroChaiVM icon, you can tap on the .jad file with the  icon to invoke hp MicroChaiVM and install the MIDlet suite.

To install a MIDlet suite from the Web

1. Make sure your hp Jornada is connected to the Web. For more information, see “connecting to the internet or to a network” earlier in this chapter.
2. If your device or desktop is behind a firewall, check that the HTTP proxy settings are correct. From the Application Manager screen menu bar, tap **Options**, and then select **HTTP Proxy**.
3. In the menu bar of the Application Manager screen, tap **Install**.
4. In the Install Source screen, tap **Type URL**.
5. Use the soft keyboard to enter the URL of the MIDlet suite .jad file, and then tap **Download**.



6. If the Application Descriptor screen shows the MIDlet that you want to download, tap **Yes**. After a successful download and installation, a Success screen will be displayed.

7. On the menu bar of the Success screen, tap **Finish** to complete the installation. The MIDlet will appear on the Application Manager screen.



If you use Pocket Internet Explorer on your hp Jornada to browse a MIDlet Web site, you can simply click on a MIDlet's .jad download link to invoke hp MicroChaiVM and install the MIDlet suite.

troubleshooting wireless download errors

If you are having problems downloading a MIDlet, the error may be due to the following:

- **GPRS connection not established.** Make sure to have a GPRS connection before you begin downloading a MIDlet.
- **GPRS connection dropped.** If you make a call while connected to GPRS, the connection is dropped when the other party answers the call. You must manually reconnect GPRS before downloading another MIDlet.

For more information, see “connecting to the Internet or to a network” earlier in this chapter.

To launch a MIDlet

- In the hp MicroChaiVM Application Manager screen, tap the MIDlet you want to launch.

If you tap and hold on the MIDlet, a pop-up menu will be displayed with the options to launch, delete, update, show suite information, and hide the highlighted MIDlet.



If you are having problems launching a MIDlet, try adjusting the hp MicroChaiVM settings. Tap **Options** and select **VM Settings**.

To exit a MIDlet

- In the MIDlet menu bar, tap **Exit** to return to the hp MicroChaiVM Application Manager screen.
–or–
If the MIDlet does not provide an **Exit** button, tap the vertical red bar to abort the MIDlet.

To delete a MIDlet suite

1. In the hp MicroChaiVM Application Manager screen, tap and hold on the MIDlet to be deleted.
2. On the pop-up menu, tap **Delete**. The Delete MIDlet suite screen appears, displaying the information of the MIDlet that you want delete.
3. If the information is correct, tap **Yes**. The Delete MIDlet suite screen appears, prompting you to confirm deletion of the MIDlet.
–or–
To cancel the deletion, tap **Exit**.
4. In the Delete MIDlet suite screen, tap **Yes** if the information is correct.
–or–
tap **Exit** to cancel the deletion process.

For detailed help and procedures about using hp MicroChaiVM, refer to online Help at <http://devnet.hp.com>. Information on how to download and install new versions of hp MicroChaiVM is available at the same location.

EzWAP

The EzWAP application allows you to easily access mobile Internet information and services, connect to your Internet Service Provider (ISP), and browse Mobile Internet sites the same way you browse HTML sites using Pocket Internet Explorer.

To start EzWAP

- On the **Start** menu, tap **Programs**, and then tap the EzWAP icon.

Before you can use EzWAP, you must configure your hp Jornada connection settings to enable communication with your GSM/GPRS service provider.

To configure EzWAP

1. In EzWAP, on the **Tools** menu, tap **Options**.
2. Tap the **General** tab to edit the general settings:

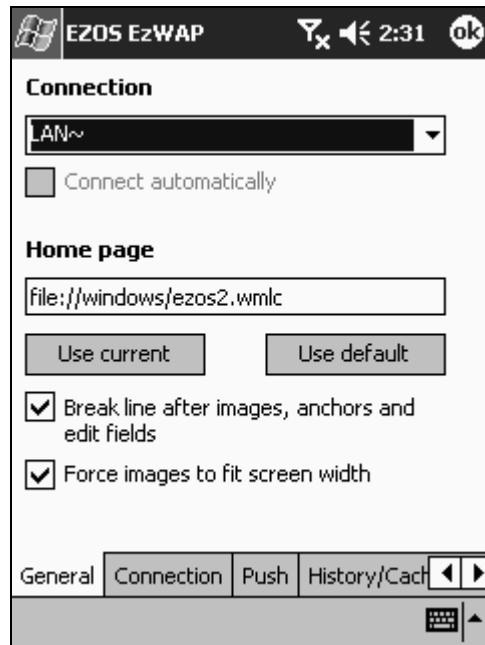

- Under **Connection**, select the dial-up connection to be used.
 - If you want EzWAP to automatically activate the selected connection when needed, select the **Connect** automatically check box.
 - To change the default WML document that will load automatically as home page, enter a URL under **Home page**.
3. Tap the **Connection** tab to select your connection type:

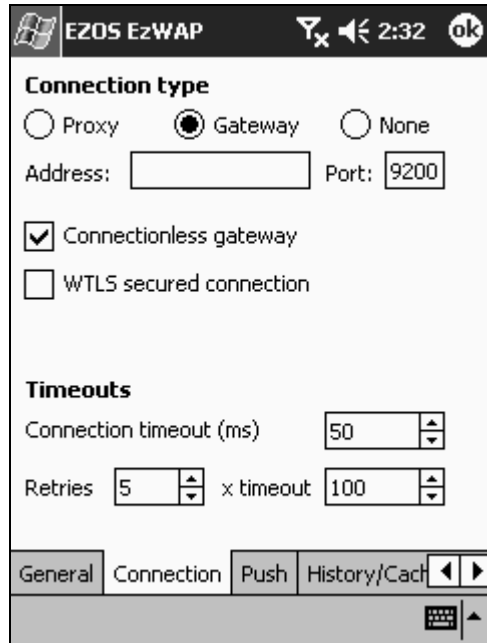

- If your mobile phone network operates a WAP gateway and you want to benefit from the additional services provided by your operator, select **Gateway**. For more information, consult your GSM/GPRS service provider.
 - For WAP gateway settings, enter the IP address of the gateway in the **Address** box. Enter the Port number in the **Port** box.
 - If the gateway works in connectionless mode, select the **Connectionless gateway** check box.
 - If the gateway uses the WTLS technology for enhanced security over the wireless network, select the **WTLS secured connection** check box.
4. Under **Timeouts**, specify the Connection timeout in milliseconds and the number and timeout of connection retries.

For information on advanced features, such as setting up a Proxy or Push, refer to the EzWAP user's guide on the Pocket PC Companion CD.

4 | getting started with pda functions

This chapter will help you start using the PDA functions of your hp Jornada. The various sections cover the basics of working with documents and programs on your hp Jornada. This chapter also details ways you can optimize your hp Jornada using the Settings and the hp profiles application and describes ways you can expand features and functionality by adding programs and accessories.

In this chapter you will learn to

- navigate in Microsoft Windows for Pocket PC using the stylus.
 - use the Today screen to view your day at a glance.
 - switch programs using the **Start** menu, hp home menu, and hp task switcher.
 - enter information in a variety of ways.
 - find and organize information on your hp Jornada.
 - manage the memory on your hp Jornada.
 - configure display and alert profiles.
 - configure hardware buttons.
 - configure menus for easy access to programs and documents.
 - add or remove programs.
 - add functionality to your hp Jornada with optional accessories.
-

navigating in microsoft windows for pocket pc

Your hp Jornada uses the Microsoft Windows for Pocket PC operating system. Navigating in Windows for Pocket PC is similar to navigating in Microsoft windows on your desktop PC, with features such as the **Start** menu, pop-up menus, and toolbars.

using the stylus

Use the stylus to navigate and select objects on the screen.

- **tap.** Touch the screen once with the stylus to launch programs, open items, and select options.
- **drag.** Hold the stylus on the screen and drag across the screen to select text and images. Drag in a list to select multiple items.
- **tap and hold.** Tap and hold the stylus on an item to see a list of actions available for that item. On the pop-up menu that appears, tap the action you want to perform.

aligning the touch screen

From time to time, you might notice that the accuracy of your stylus taps diminishes. When this happens, you can realign your touch screen using the Align Screen control panel.

To launch the Align Screen control panel

1. Press and hold the hp home menu hot key to display the hp quick menu.
2. Using the navigation pad, highlight **Align Screen** on the hp quick menu, and then click the action button.
3. Tap the targets as they appear at each new location to align the touch screen.

today screen

When you turn on your hp Jornada for the first time each day (or after four hours of inactivity), you will see the Today screen. You can also display it by tapping  and then **Today**. On the Today screen, you can see at a glance important information for the day.

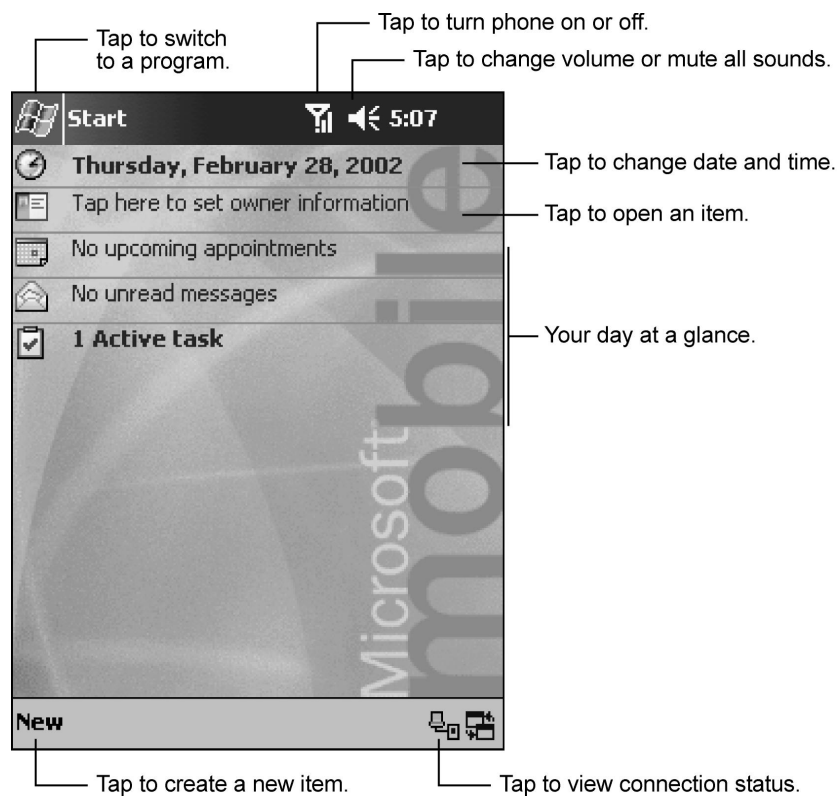

You can customize the Today screen using themes, or display your own graphic as a background. For more information, tap **Settings** on the **Start** menu, and then tap **Today**.



switching programs



Use the hp home menu application or the **Start** menu to quickly launch your favorite programs or open frequently used documents. You can also use hp task switcher to switch between running programs.

To start or switch programs using the hp home menu

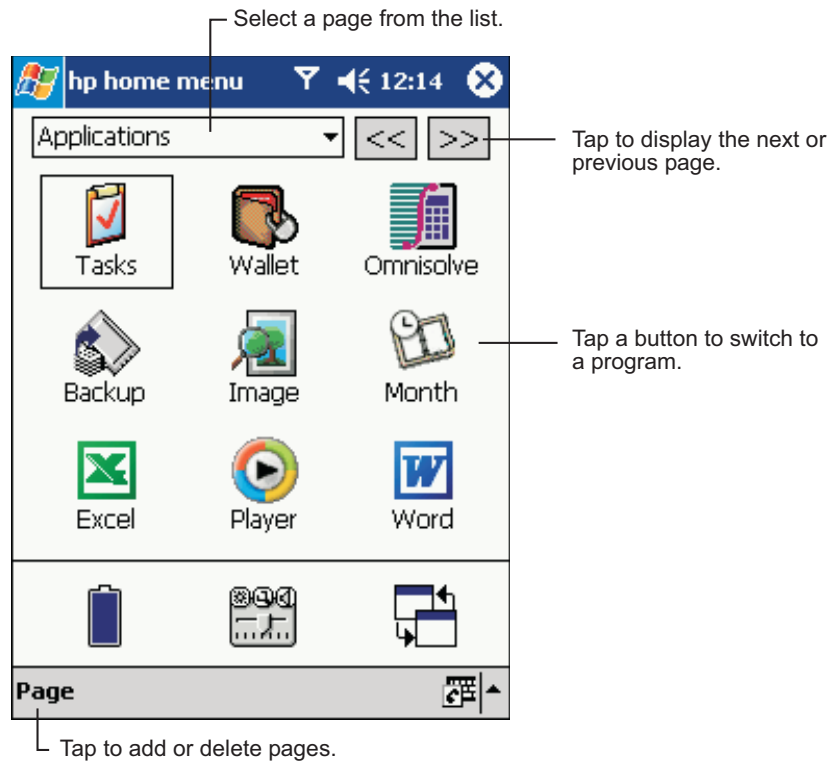
1. Press the hp home menu hot key.
2. Tap the button that corresponds to the program or document.



The hp home menu displays up to 10 pages of buttons and icons that represent the programs and documents on your hp Jornada. To change

pages, tap the name of a page in the drop-down list at the top of the hp home menu screen, or tap the arrows  or  to display the next or previous page.

The battery icon at the bottom of the hp home menu changes to indicate when power is low. Tap the icon to launch the Power control panel.



To start or switch programs using the Start menu

1. Tap  in the Navigation bar to display the **Start** menu.
2. On the **Start** menu, tap the name of the program you want to switch to.
–or–
Tap one of the miniature icons at the top of the **Start** menu to switch to a recently used program.

You can customize both the hp home menu and the **Start** menu to make it easier to access the programs you use most. For more information, see “configuring menus” later in this chapter.



hp task switcher

Use hp task switcher to switch to a program or to quickly close all running programs. hp task switcher offers two ways to display running programs: *Icon pad mode* displays running programs as icons on a pop-up menu (the Icon pad). *Task bar menu mode* lists running programs on a pop-up menu accessible from the Today screen.

By default, hp task switcher is running in icon pad mode when you start your hp Jornada. You can also start hp task switcher by tapping the hp task switcher icon in the hp Applications folder.

To switch between modes

1. Start hp task switcher, and then tap **About** or tap the About hp task switcher icon.
2. On the **Settings** tab, select either **Icon Pad** or **Menu on task bar**. If you select **Icon Pad**, set options for how long the Icon pad will be displayed.

When hp task switcher is running in Icon pad mode, the running programs are displayed as icons on a pop-up menu (the Icon pad).

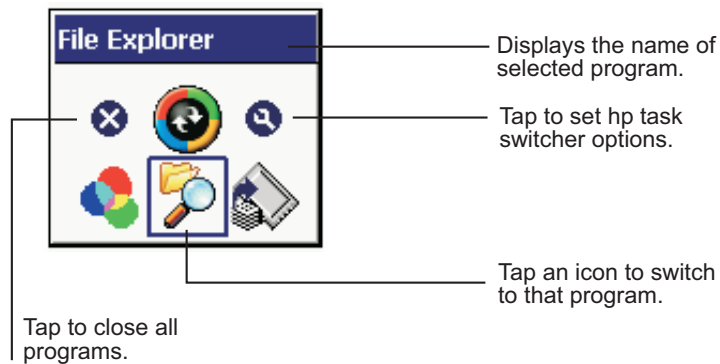

The hp task switcher pop-up menu

To display the hp task switcher icon pad

- Press and hold the Inbox hot key.
 - to switch to a running program, tap the program icon on the icon pad.
 - to close a program, tap and hold the icon for the program you want to close, and then on the pop-up menu, tap **Close**.
 - to close all programs, tap the Close All icon on the icon pad.

When hp task switcher is running in Task bar menu mode, the running programs are displayed in a list on a pop-up menu accessible from the Today screen.

To display the hp task switcher pop-up menu

1. On the **Start** menu, tap **Today**.
2. Tap the hp task switcher icon in the Command bar.
 - switch to a running program by tapping the name of the program in the list.
 - close a single program by tapping **Close Window**, and then tapping the name of the program.

- close all programs by tapping **Close Window**, and then tapping Close All.

You cannot use hp task switcher to close phone applications.



You can also use the navigation pad to select a program, and then the action button to switch to that program, or tap and hold the action button to close the program.



navigation bar and command bar

The Navigation bar is located at the top of the screen. It displays the active program and current time, and allows you to switch programs and close screens.

Use the Command bar at the bottom of the screen to perform tasks in programs. The Command bar includes menu names, buttons, and the Input panel button. To create a new item in the current program, tap **New**. To see the name of a button, tap and hold the stylus on the button. Drag the stylus off the button so that the command is not carried out.

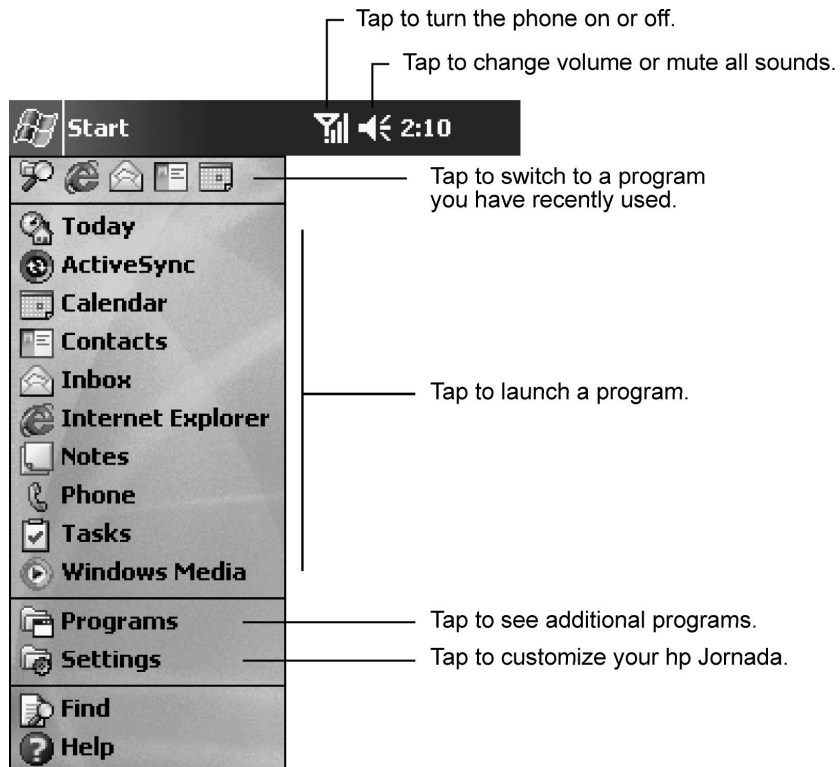

The Navigation bar and Start menu

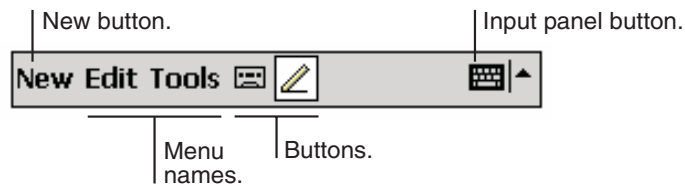

The Pocket PC Command bar

status icons

When the Today screen is displayed, you may see status icons on the Command bar or Navigation bar. In most cases, you can tap a status icon to display the associated control panel or more information related to the item. For example, tap a battery status icon to launch the Power control panel.

If there is not enough room to display all the status icons that need to be displayed, the Notification icon, , will appear. Tap the icon to view all status icons.



pop-up menus

With pop-up menus, you can quickly choose an action for an item. For example, you can use the pop-up menu in the Contact list to quickly delete a contact, make a copy of a contact, or send an e-mail message to a contact. The actions in the pop-up menu vary from program to program. To access a pop-up menu, tap and hold the stylus on the name of the item that you want to perform the action on. When the menu appears, lift the stylus, and tap the action you want to perform. Or tap anywhere outside the menu to close the menu without performing an action.

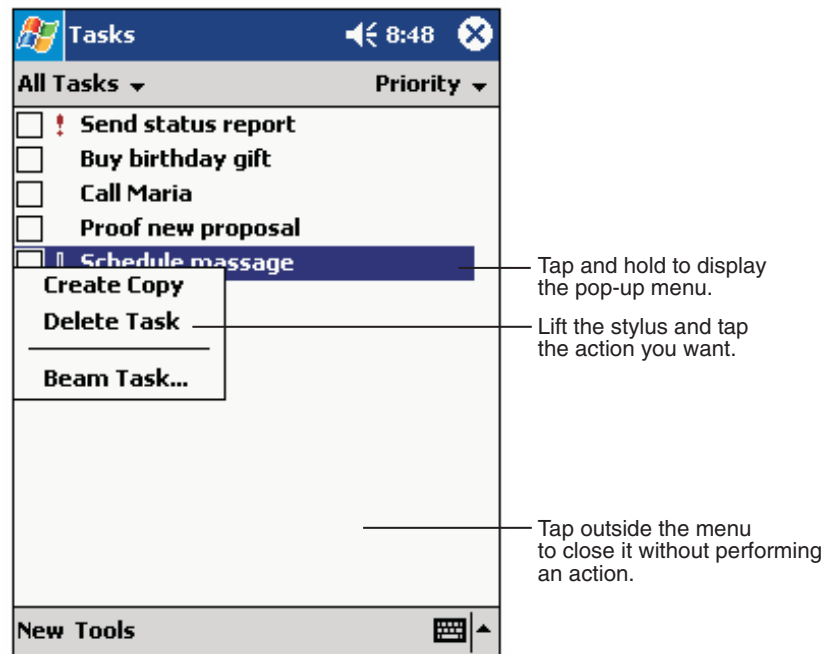

alerts and notifications

Your hp Jornada reminds you in a variety of ways when you have something to do. For example, if you have set up an appointment in Calendar, a task with a due date in Tasks, or an alarm in Clock, you will be notified in one or more of the following ways:

- a message appears on the screen.
- a sound, which you can specify, is played.
- the blue LED blinks.
- the device vibrates.

Use hp profiles to choose reminder types and sounds for your hp Jornada. For more information, see "display and alert profiles" later in this chapter.

entering information

You have several options for entering new information:

- use the Input panel to enter typed text, either by using the soft keyboard or other input method.
- write directly on the screen.
- draw pictures on the screen.
- speak into the microphone to record a message.

entering text using the input panel

Use the Input panel to enter information in any program on your hp Jornada. You can either type using the soft keyboard or write using the soft keyboard, Block Recognizer, Letter Recognizer, or Transcriber. In any case, the characters appear as typed text on the screen.

To show or hide the Input panel, tap the Input panel button. Tap the arrow next to the Input panel button to see your choices.

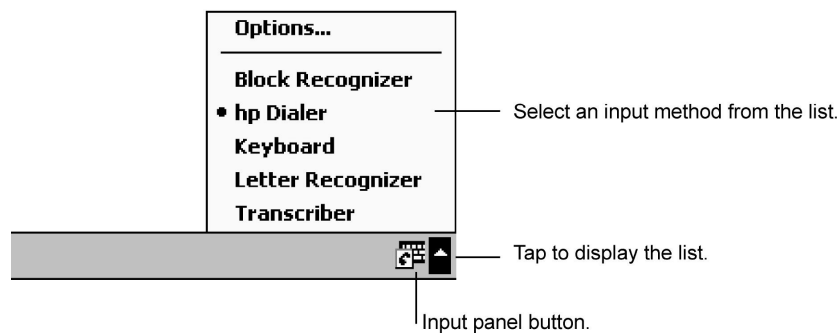

When you use the Input panel, your hp Jornada anticipates the word you are typing or writing and displays it above the Input panel. When you tap the displayed word, it is inserted into your text at the insertion point. The more you use your hp Jornada, the more words it learns to anticipate.

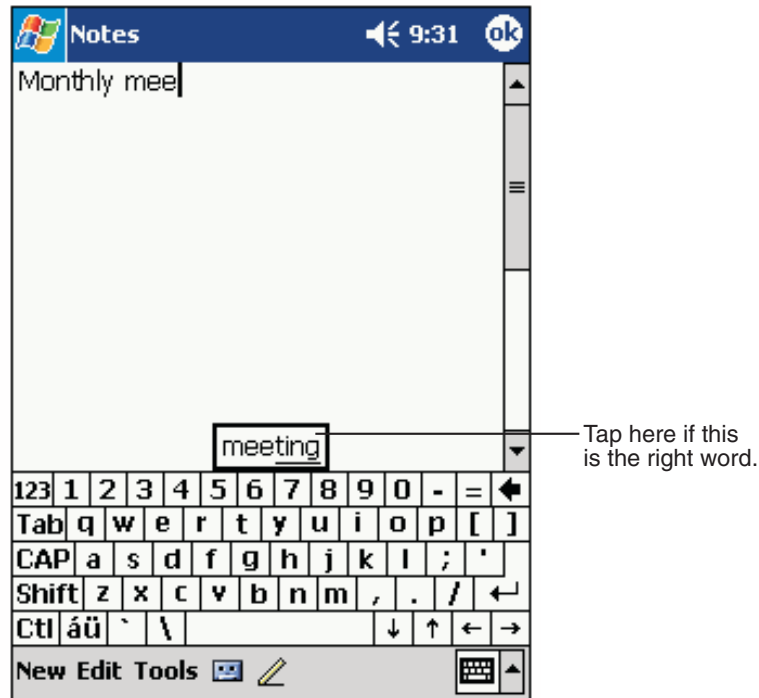

To change word suggestion options, such as the number of words suggested at one time, tap **Settings** on the **Start** menu. On the **Personal** tab, tap **Input**, and then tap the **Word Completion** tab.

block recognizer

With Block Recognizer, you can use the stylus to input characters using strokes that are similar to the Palm™ Graffiti® method.

To type with Block Recognizer

1. Tap the arrow next to the Input panel button, and then tap **Block Recognizer**.
2. Write a letter in the box.

When you write a letter, it is converted to typed text that appears on the screen. For specific instructions on using Block Recognizer, launch Block Recognizer, and then tap the question mark next to the writing area.

soft keyboard

The soft keyboard is an onscreen keyboard displayed at the bottom of the screen.

To type with the soft keyboard

1. Tap the arrow next to the Input panel button, and then tap Keyboard.
2. On the soft keyboard that is displayed, tap the keys with your stylus.

letter recognizer

With Letter Recognizer, you can write letters using the stylus just as you would use a pen on paper.

To type with Letter Recognizer

1. Tap the arrow next to the Input panel button, and then tap **Letter Recognizer**.
2. Write a letter in the box.

When you write a letter, it is converted to typed text that appears on the screen. For specific instructions on using Letter Recognizer, launch Letter Recognizer and then tap the question mark next to the writing area.

transcriber

With Transcriber you can write anywhere on the screen using the stylus just as you would on paper. Unlike Letter Recognizer and Block Recognizer, you can write a sentence or more of information; then, you pause and let Transcriber change the written characters to typed characters.

To type with Transcriber

1. Tap the arrow next to the Input panel button, and then tap **Transcriber**.
-

2. Write anywhere on the screen.

For specific instructions on using Transcriber, launch Transcriber and then tap the question mark in the lower-right corner of the screen.

writing on the screen

In any program that accepts writing—such as the Notes program and the **Notes** tab in Calendar, Contacts, and Tasks—you can use your stylus to write directly on the screen. Write the way you do on paper. You can edit and format what you have written and convert the information to text later.

To write on the screen

- Tap the Pen button to switch to writing mode. This action displays lines on the screen to help you write.

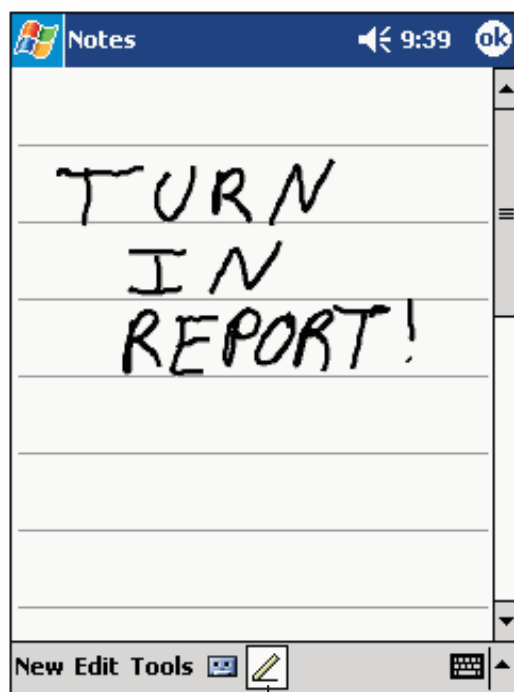

Tap the Pen button and use your stylus like a pen.

Some programs that accept writing may not have the Pen button. See the documentation for that program to find out how to switch to writing mode.



If you want to edit or format writing, you must select it first.

To select writing

1. Tap and hold the stylus next to the text you want to select until the insertion point appears.
2. Without lifting, drag the stylus across the text you want to select.

If you accidentally write on the screen, tap **Tools**, then **Undo**, and try again. You can also select text by tapping the Pen button to deselect it and then dragging the stylus across the screen.

You can cut, copy, and paste written text in the same way you work with typed text: tap and hold the selected words and then tap an editing command on the pop-up menu, or tap the command on the **Edit** menu.

To convert writing to text

- On the **Tools** menu, tap **Recognize**.

If you want to convert only certain words, select them before tapping **Recognize** on the **Tools** menu (or tap and hold the selected words and then tap **Recognize** on the pop-up menu). If a word is not recognized, it is left as writing.

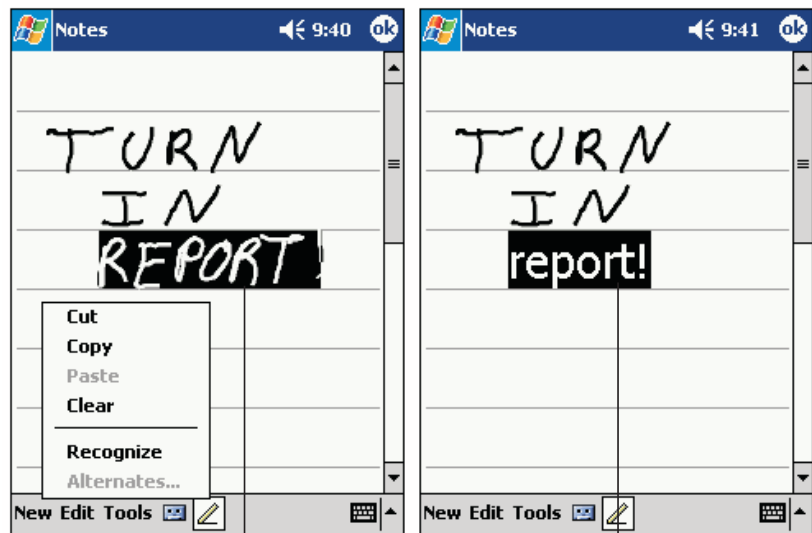

Select the text you want to convert and tap Recognize on the pop-up menu.

The writing is turned into text.

If the conversion is incorrect, you can select different words from a list of alternates or return to the original writing. To do so, tap and hold the

incorrect word (tap one word at a time). On the pop-up menu, tap **Alternates**. A menu with a list of alternate words appears. Tap the word you want to use, or tap the writing at the top of the menu to return to the original writing.

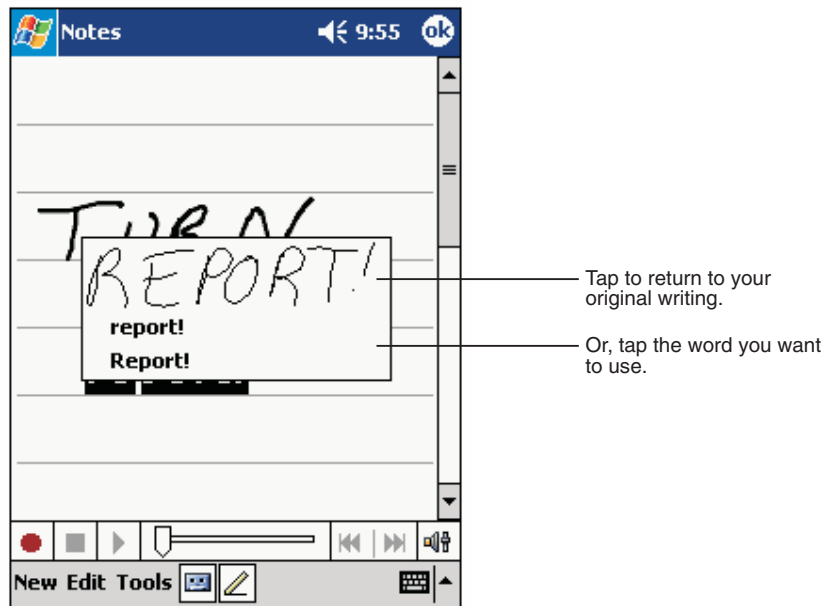

Some tips for getting good recognition are listed below:

- write neatly.
- write on the lines and draw descenders below the line. Write the cross of the "t" and apostrophes below the top line so that they are not confused with the word above. Write periods and commas above the line.
- for better recognition, use the **Tools** menu to increase the zoom level to 300%.
- write the letters of a word close together and leave big gaps between words.

- hyphenated words, foreign words that use special characters such as accents, and some punctuation cannot be converted.
- if you add writing to a word to change it (such as changing a "3" to an "8") after you attempt to recognize the word, the writing you add will not be included if you attempt to recognize the writing again.

drawing on the screen

You can draw on the screen in the same way that you write on the screen. The difference between writing and drawing on the screen is how you select items and how they can be edited. For example, selected drawings can be resized, while writing cannot.

To create a drawing

- Cross three ruled lines on your first stroke. A drawing box appears. Subsequent strokes in or touching the drawing box become part of the drawing. Drawings that do not cross three ruled lines will be treated as writing.

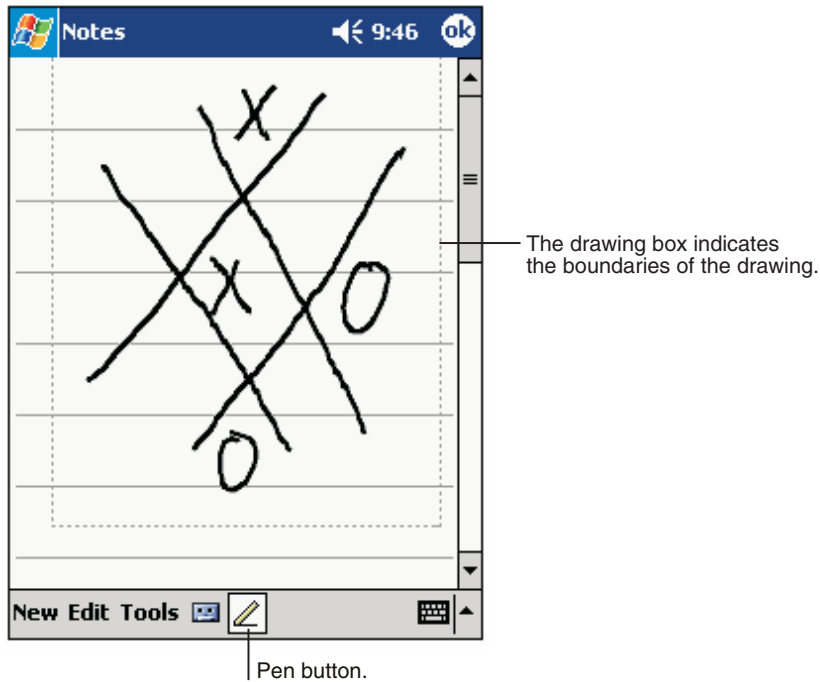

You may want to change the zoom level so that you can more easily work on or view your drawing. Tap **Tools**, and then choose a zoom level.



If you want to edit or format a drawing, you must select it first.

To select a drawing

- Tap and hold the stylus on the drawing until the selection handle appears. To select multiple drawings, deselect the Pen button and then drag to select the drawings you want.

You can cut, copy, and paste selected drawings by tapping and holding the selected drawing and then tapping an editing command on the pop-up menu, or by tapping the command on the **Edit** menu. To resize a drawing, make sure the Pen button is not selected, and then drag a selection handle.

recording a message

In any program where you can write or draw on the screen, you can also quickly capture thoughts, reminders, and phone numbers by recording a message. In Calendar, Tasks, and Contacts, you can include a recording in the **Notes** tab. In the Notes program, you can either create a stand-alone recording or include a recording in a written note. If you want to include the recording in a note, open the note first. In the Inbox program, you can add a recording to an e-mail message.

To create a recording

1. Hold the hp Jornada's microphone near your mouth or other source of sound.
2. Press and hold the record button. If the speaker is not muted, a beep indicates that your hp Jornada is recording. The LED shines steady amber while recording is in progress.
3. While holding down the record button, speak into the microphone.
4. To stop recording, release the record button. Two beeps will sound. The new recording appears in the note list or as an embedded icon.



You can also make a recording by tapping the Record button on the Recording toolbar.

To play a recording

- Tap it in the list or tap its icon in the note.
-



recording formats

Your hp Jornada supports several formats for voice notes. The formats vary in both the quality of the recording and the size of the sound file. When selecting a recording format, you should consider the quality you need as well as how much storage memory the recording will use on your hp Jornada.

Not all recording formats are compatible with other software or computers. If you will share your recordings with others or transfer a recording to your desktop PC, be sure to choose a recording format that is supported by the software used to play recordings on the other computer.

The PCM format offers the highest quality recording, and is compatible with all hp Jornada models, other Windows-powered mobile devices, and

desktop PCs that use Windows operating systems. The GSM 6.10 format is compatible with all hp Jornada models and other Windows-powered mobile devices, but may not work with desktop PCs.

To select a recording format

1. On the **Start** menu, tap **Settings**, and then tap the Input icon.
2. On the **Options** tab in the Input control panel, select a voice recording format from the drop-down list.

The list of recording formats on your hp Jornada indicates the sample rate, whether the format is stereo or mono, and how much storage memory is required per second of recording. You may need to experiment with different sample rates and formats to determine which format best suits your voice.

using my text

When using Inbox or MSN Messenger, use My Text to quickly insert preset or frequently used messages into the text entry area. To insert a message, tap **My Text**, and then tap a message.

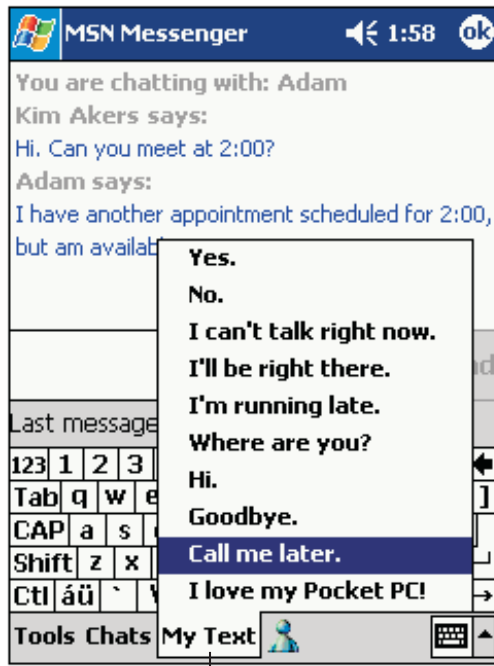

Tap to select a prewritten message.

After inserting a My Text message, you can add text to it before you send the message.



To edit a My Text message, on the **Tools** menu, tap **Edit**, and then tap **My Text Messages**. Select the message you wish to edit and make desired changes.

finding and organizing information

The Find feature on your hp Jornada helps you quickly locate information.

To find a file

- On the **Start** menu, tap **Find**. Enter the text you want to find, select a data type, and then tap **Go** to start the search.



To quickly find information that is taking up storage space on your hp Jornada, select **Larger than 64 KB** under **Type**.

You can also use the File Explorer to find files on your hp Jornada and to organize these files into folders. On the **Start** menu, tap **Programs**, and then tap **File Explorer**.

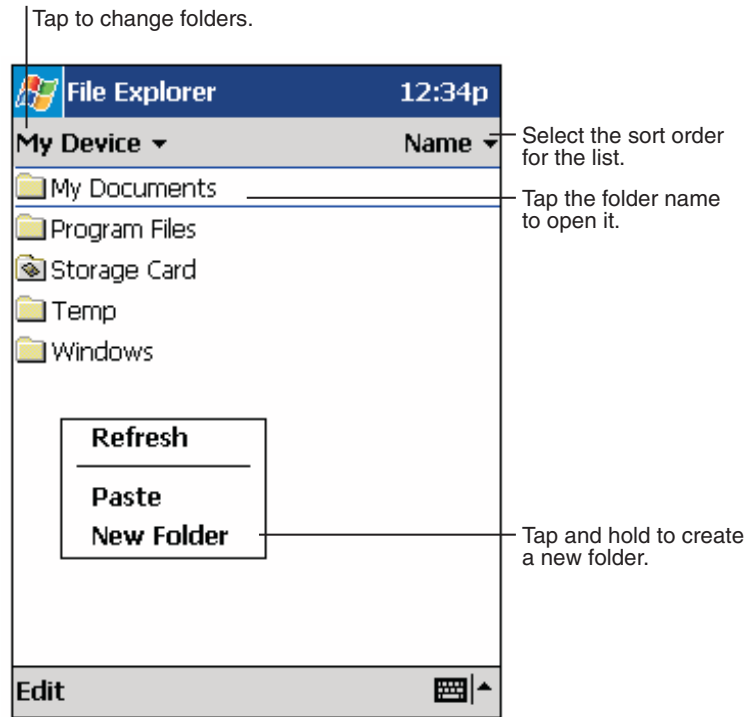

You can move files in File Explorer by tapping and holding the item you want to move, tapping **Cut** or **Copy** on the pop-up menu, browsing to the new location, and then tapping **Paste**.



managing memory

Files, settings, and data that you add to your hp Jornada are stored in RAM. The RAM on your hp Jornada is allocated between *storage memory* (memory used to store files and data) and *program memory* (memory used by running programs). The operating system automatically manages the allocation between storage and program memory; however, in some situations—such as when memory is low—it may not be able to adjust the

memory properly. If you receive a message stating that storage or program memory is unavailable, try the following solutions.

To increase storage memory, you can

- buy an optional CompactFlash Type I or Type I extended memory card, and move files from internal memory to the card. (For more information on using CompactFlash accessories, see "pda accessories," later in this chapter.)
- delete unnecessary files.
- remove Web pages stored for offline viewing in Internet Explorer folders.
- remove programs you no longer use. See "adding and removing Programs," later in this chapter.
- clear program memory. See the section below.

To increase program memory, you can

- use hp task switcher or the Memory control panel to stop programs you are not currently using. In most cases, programs automatically stop to free needed memory. However, in some situations, such as when a dialog box is waiting for a response, the program may not be able to stop automatically.
- clear storage memory as described above. This will free some storage memory so that it can be reallocated as program memory.
- reset your hp Jornada. Remove your hp Jornada from the cradle, remove the CompactFlash card (if installed), and follow the instructions in "resetting your hp Jornada" in chapter 6.

To use the Memory control panel to stop programs

1. On the **Start** menu, tap **Settings**.
2. On the **System** tab, tap Memory, and then tap the **Running Programs** tab to check the state of your active programs.
3. To stop a running program, select the program in the list, and then tap **Stop**.

To use hp task switcher to stop programs

1. Press and hold the Inbox hot key to display hp task switcher.
2. Tap the **Close** button
–or–
On the pop-up menu, tap **Close Window**, and then tap a program in the list or tap **Close All**.

compactflash memory cards

You can increase storage and program memory on your hp Jornada by purchasing an optional CompactFlash memory card. You can use CompactFlash memory cards for backup, storage, archives, or to transfer large files to other devices. Files stored on a CompactFlash card appear in a folder called Storage Card, listed under My Device in the File Explorer application.

Data stored on a CompactFlash card will be saved, even if your hp Jornada loses power. To protect your data, use hp backup to back up regularly to a CompactFlash card.



CompactFlash accessories can be purchased from a variety of third-party vendors. Your hp Jornada supports CompactFlash Type I or Type I extended accessories. In addition to CompactFlash memory cards, you can buy CompactFlash accessories that offer additional functionality, such as network interface cards, cameras, and other peripheral devices. For more information on installing and using CompactFlash accessories with your hp Jornada, see “pda accessories” later in this chapter.

backing up and restoring data

To prevent loss of data, you should back up your hp Jornada frequently. Your hp Jornada comes with two programs for backing up data:

- **Microsoft ActiveSync.** ActiveSync enables you to back all data on your hp Jornada to your desktop PC. You can set ActiveSync to back up automatically each time you connect, or you can back up manually, whenever you choose. For more information, see ActiveSync Help on your desktop PC.
- **hp backup.** The hp backup application enables you to back up all data on your hp Jornada, or only your PIM databases and/or e-mail messages. You can save the backup file in RAM or on an optional, removable CompactFlash memory card.

using hp backup

The hp backup application gives you added flexibility in backing up your valuable data. With hp backup, you can back up all data or back up only your Calendar, Contacts, Tasks, and Inbox databases. You can save the backup file to internal memory or to an optional CompactFlash memory card, so you can safeguard your data even while you are traveling or away from your desktop PC.



Although you can back up data to internal memory (RAM) on your hp Jornada, if you restore your hp Jornada to the factory default settings or accidentally lose power, the backup file will be erased. To ensure the safety of your data, it is recommended that you back up to a CompactFlash memory card (using hp backup) or to your desktop PC (using ActiveSync).

To back up data using hp backup

1. Use hp task switcher to close all running applications.
 2. Disconnect your hp Jornada from your desktop PC.
 3. On the **Start** menu on your hp Jornada, tap **Programs**.
 4. In the hp Applications folder, tap the hp backup icon.
-

5. On the **Backup** tab, choose what you want to back up by checking or clearing the check boxes.
6. If you want to protect your backup file with a password, tap **Backup Options**, and enter a password using the Input panel, and then tap **OK**.
7. Tap **Back Up Now**.
8. In the **Name** box, enter a name for the backup file, and select a storage location from the **Location** and **Folder** drop-down lists.
9. Tap **OK**.

restoring data

When you use the backup file to restore information, information on your hp Jornada is replaced with the information stored in the backup file. If you have created files on your hp Jornada since the last backup and do not want to delete these files during the restore process, move the files from your hp Jornada to your desktop PC or to an optional CompactFlash memory card before restoring information.

Depending on the type of backup file, the restore operation replaces all information stored in your PIM databases or all data stored on your hp Jornada. Any data added after the backup file was created will be lost.



To restore data with hp backup

1. Use hp task switcher to close all running applications.
 2. Disconnect your hp Jornada from your desktop PC.
 3. On the **Start** menu on your hp Jornada, tap **Programs**.
 4. In the hp Applications folder, tap the hp backup icon.
 5. On the **Restore** tab, choose what you want to restore by checking or clearing the check boxes.
 6. Tap **Restore Now**.
 7. In the file list, tap the name of a backup file you want to restore.
 8. Remove the CompactFlash card (if installed), and reset your hp Jornada. See “resetting your hp Jornada” in chapter 6.
-



When you restore data, your hp Jornada must have the same regional settings that it had when you completed the backup; otherwise, you will not be able to restore the files. To change regional settings, on the **Start** menu, tap **Settings**, and then tap the **Regional Settings** icon on the **System** tab. Select your region from the drop-down list.

display and alert profiles

Use the hp profiles application to quickly configure the display and alert profiles with your preferences for brightness, backlight options, and alerts and notifications.

To start hp profiles

1. On the **Start** menu, tap **Settings**.
 2. On the **Personal** tab, tap the **hp profiles** icon.
-



You can use pop-up menus to quickly apply display profiles and alert profiles. Press and hold the Contacts hot key to display the **alert profile** pop-up menu. Press and hold the Calendar hot key to display the **display profile** pop-up menu.



When the PDA functions are off and the auto cover is closed, you can use the phone End button to apply an alert profile, to change the phone ringing options. In the auto cover application, select **Enable speed dial and profile selection**. Then, with the auto cover closed, press the End button to display the alert profiles. Use the volume/scroll control to scroll the profiles. Press the Send button to select a profile.

display profiles

The screen of your hp Jornada uses ambient light to enhance the display. That is, the brighter the surrounding light, the better you will be able to see

the screen. If you are in a dark room, you can use the backlight to compensate for the low ambient light.

Your hp Jornada includes a light sensor. You can set an option to turn on the backlight automatically whenever the light sensor detects that conditions are too dim to see the screen clearly. Use hp profiles to adjust the brightness of your hp Jornada screen, and set options for turning the backlight on and off.

You can configure four display profiles for different environments or lighting conditions (for example, indoors or low power). Display profiles remember all of the display options for brightness and backlight.

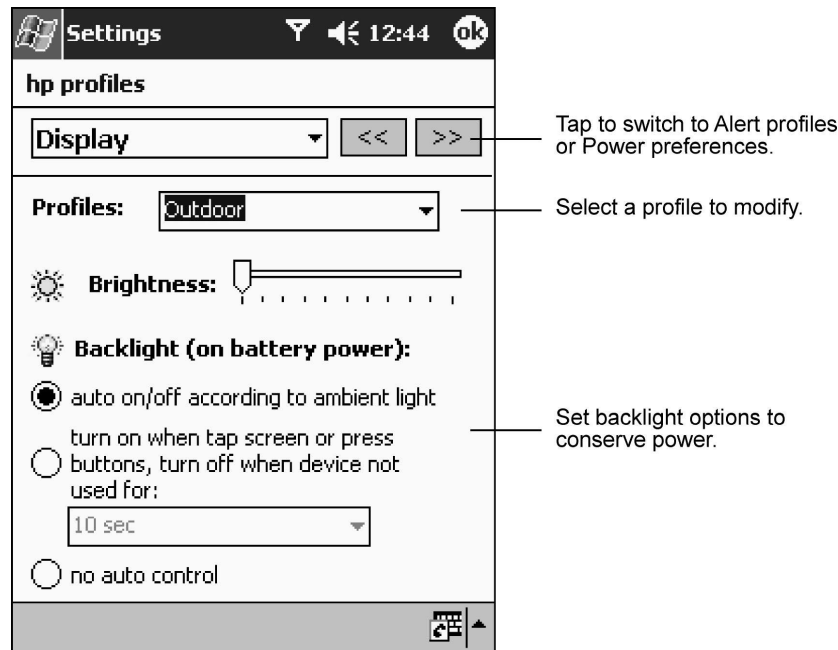

To quickly apply a display profile, press and hold the Calendar hot key, and then select a profile from the pop-up menu.



alert profiles

Alert settings control the type of alarms and notifications used by your hp Jornada. You can configure alert profiles for different environments, for example a Loud profile for noisy environments, or a Meeting profile that silences screen taps and uses vibration for most alerts.

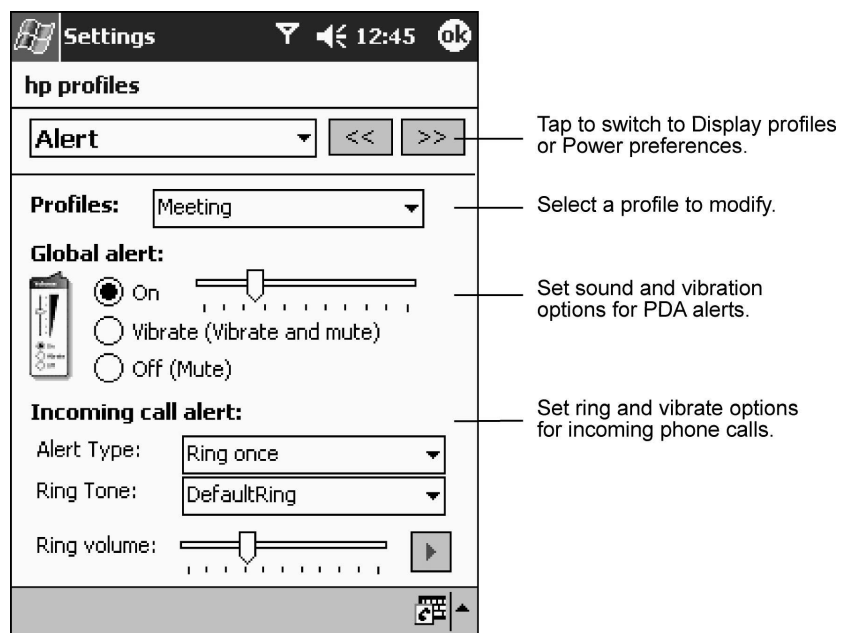

To quickly apply an alert profile, press and hold the Contacts hot key, and then select a profile from the pop-up menu.

adjusting other settings

You can change many settings on your hp Jornada to suit the way you work. To see the available options, tap **Settings** on the **Start** menu, and then tap any of the icons on the **Personal** or **System** tabs. In particular, you might want to adjust the following:

- **Clock.** Change the time and set alarms and reminders.
- **Owner Information.** Enter the contact information you want to be displayed each time you turn on your hp Jornada.
- **Password.** Limit access to your hp Jornada by requiring a four-digit password to be entered each time you turn on your hp Jornada.
- **Today.** Customize the look of, and the information that is displayed on, the Today screen.

configuring hardware buttons

You can configure the hardware buttons on your hp Jornada to suit the way you work. Use the Buttons control panel to assign the hp hot keys and the record button to start any program.

To assign a program to a hardware button

1. On the **Start** menu, tap **Settings**, and then tap the Buttons icon.
2. On the **Program Buttons** tab, select a button from the list.
3. In the **Button assignment** list, select the program you want to assign to the button.

To control the scroll speed

1. On the **Start** menu, tap **Settings**, and then tap the Buttons icon.
2. On the **Volume/scroll Control** tab, move the sliders to set the repeat rate and the delay before repeat.

configuring menus

You can customize the menus on your hp Jornada to ensure you have easy access to programs or documents.

hp home menu

Use the hp home menu application to quickly launch your favorite programs or open frequently used documents. You can modify the buttons on the hp home menu by adding descriptions or by assigning them to other programs. You can also add pages that contain buttons for the programs or documents you use most.

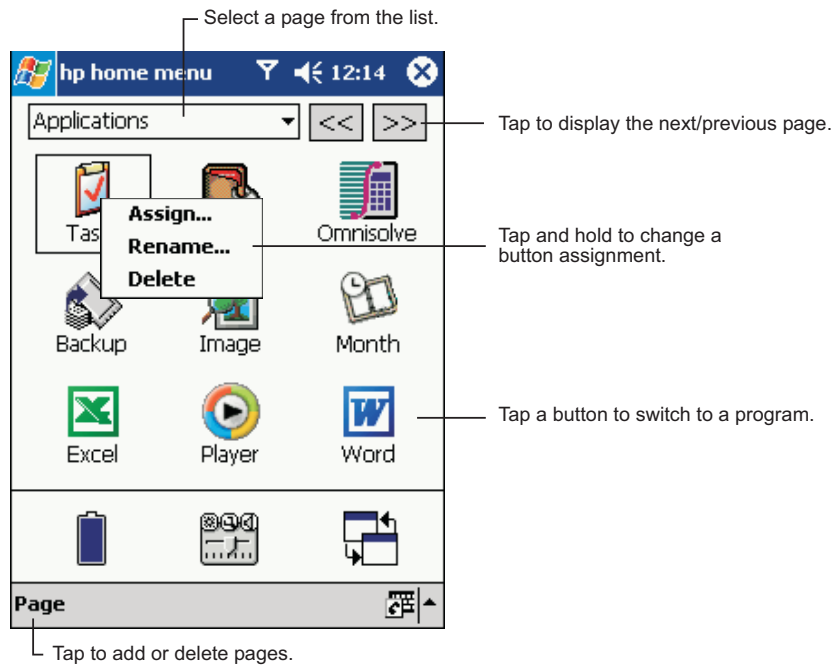

To modify a button assignment

1. Press the hp home menu hot key to launch hp home menu.
2. Select the page you want to modify from the drop-down list of home menu pages.
3. Tap and hold the stylus on the button you want to modify.
4. On the pop-up menu, tap **Assign**, **Rename**, or **Delete**.
 - Tap **Assign**, and then browse to select the program or document you want to assign to the button.
 - Tap **Rename**, and then type a description to be displayed under the button. The description can be up to 10 characters long. The default description is the file name.
 - Tap **Delete** to clear the current button assignment.

To add a page to the hp home menu

1. Press the hp home menu hot key to display the hp home menu.
2. On the **Page** menu, tap **Add Page**.
3. Enter a name for the page, and then tap **OK**.
4. On the new page, tap and hold a button to assign to a program or document.
5. On the pop-up menu, tap **Assign**, and then browse to select the program or document you want to assign to the button.

start menu

You can add programs to the **Start** menu to make it easier to access the programs you use most.

To add a program to the Start menu

1. On the **Start** menu, tap **Settings**, and then tap **Menus**.
 2. On the **Start Menu** tab, select the check box for the program you want to add.
-

The **Start Menu** tab displays only the programs stored in the Start Menu folder on your hp Jornada. If you do not see a particular program listed, use File Explorer to move the program to the Start Menu folder.

adding and removing programs

adding programs

You can add even more functionality to your hp Jornada by installing additional software and programs. A wide variety of software is available for Windows Powered Pocket PCs, ranging from custom business applications and system utilities to games and entertainment. Some programs are available on the Pocket PC Companion CD included with your hp Jornada. Other programs are available from software vendors or on the Web.

In addition to running Microsoft Pocket PC applications, you can download on demand Java applications (MIDlets) that are based on the Mobile Information Device Profile (MIDP) specifications. Suites of MIDlets may be available from your GSM/GPRS service provider. For more info, see "hp MicroChaiVM" in chapter 3, or consult your GSM/GPRS service provider.



Install only programs designed specifically to run on an hp Jornada wireless digital assistant and/or a Windows Powered Pocket PC. You cannot run programs designed for Windows on your hp Jornada. In addition, you may need a version of the program designed specifically for the StrongARM processor used by your hp Jornada.

Install software to your hp Jornada by first loading the installation files onto your desktop PC, and then using ActiveSync or running the Application Manager.

To install a program using ActiveSync

1. Download the program to your desktop computer (or insert the CD or disk that contains the program into your desktop computer). You may see a single *.exe file, a *.zip file, a Setup.exe file, or several versions of files for different device types and processors. Be sure to select the program designed for the Pocket PC and the StrongARM processor.
2. Connect your hp Jornada to your desktop PC.
3. If the program includes an installer program (typically named Setup.exe or Install.exe), double-click the installer program on the desktop PC. The installer program copies the necessary files to your hp Jornada.

–or–

If the program does not include an installer, use ActiveSync Explore to copy the program file to the Program Files folder on your hp Jornada. Refer to the Read Me file or documentation that came with the program to be sure you have copied the necessary file(s). For more information on copying files using ActiveSync, see ActiveSync Help.

You can also use Pocket Internet Explorer to download some programs from the Internet directly to your hp Jornada. If the program includes a *.xip or *.exe file, a Setup.exe file, or a cabinet (*.cab) file for Pocket PC, you can download this file to your hp Jornada, and then tap the icon to install the program.



removing programs

To free storage memory on your hp Jornada, you can remove programs you no longer use. Only programs that are stored in RAM can be removed. Programs preinstalled programs in Flash ROM cannot be removed; however, these programs do not use storage memory.

To remove a program

1. On the **Start** menu, tap **Settings**.
 2. On the **System** tab, tap **Remove Programs**.
 3. Select the program in the list, and then tap **Remove**.
-



If the program does not appear in the list of installed programs, use File Explorer on your hp Jornada to locate the program, tap and hold the program, and then tap **Delete** on the pop-up menu.

pda accessories

By purchasing accessories for your hp Jornada, you can add functionality, replace lost parts, and protect your hp Jornada from accidental damage. Hewlett-Packard makes a variety of accessories designed specifically to enhance your hp Jornada. In addition, you can purchase CompactFlash card accessories from many vendors.

hp accessories

Many optional accessories are available from Hewlett-Packard. In addition to accessories described here, the Accessories Guide included with your hp Jornada includes a catalog of accessories designed to work with the hp Jornada 920 series wireless digital assistant. Check the Hewlett-Packard Web site at www.hp.com for updates to this list.

- **hp Jornada 920 series pocket keyboard.** Auto cover with built-in keyboard for easy typing.
- **hp Jornada 920 series car dc adapter.** Charges your hp Jornada while from an automobile cigarette lighter.

compactflash accessories

There are many CompactFlash Type 1 accessories that provide a range of wide range of expansion possibilities for of the hp Jornada. You can use CompactFlash memory cards for backup storage, archives, or to transfer large files to other devices. CompactFlash cards can be purchased from a variety of third-party vendors.

If you cannot find a software driver for your card on the CD provided with the hp Jornada, consult the card's manufacturer first. Install software drivers as you would install any other software or program. For more information, see "adding or removing programs," earlier in this chapter.

The hp Jornada supports CompactFlash Type I or Type I extended cards. In addition to CompactFlash memory cards, you can buy cards that offer additional functionality, such as modems, network interface cards, cameras, and other peripheral devices. For more information, see “accessories” later in this chapter or visit the hp Web site at www.hp.com.

To install a CompactFlash card

1. Remove the dummy card from the CompactFlash card slot.
2. If the card is a Type I extended card, remove the CompactFlash door.
3. Align the card as shown in the diagram, and push it into the slot until it clicks into place.

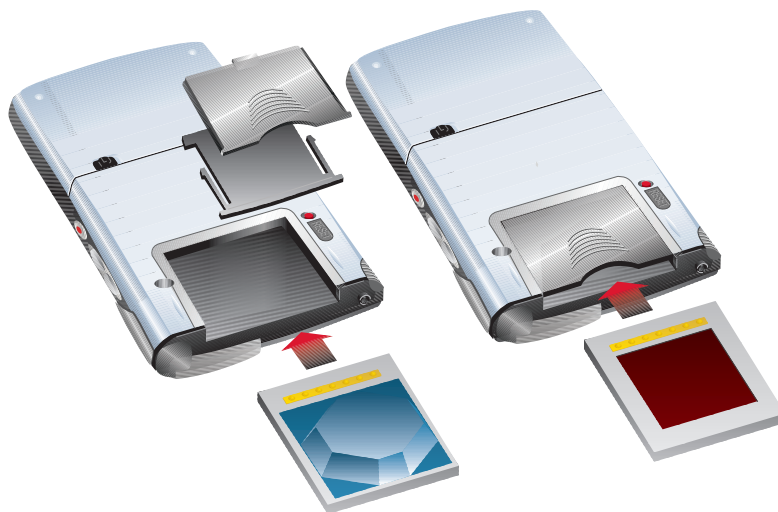

If the card is Type I extended, remove the door from the CompactFlash Type I extended card slot, as shown on the left.

5 | pda programs

Your hp Jornada includes Microsoft Pocket PC Software 2002 with phone, hp applications, and programs from other vendors. The software includes hp image viewer, Microsoft Pocket Word, Microsoft Pocket Excel, Windows Media Player for Pocket PC, and Microsoft Reader. Third-party programs include CodeWallet Pro from Developer One. This section provides an overview of these programs and enough information to get you started. For complete instructions on using a program, refer to online Help for that program.

In this chapter, you will learn about

- Microsoft Pocket Outlook and hp month view
 - Microsoft Pocket Word
 - Microsoft Pocket Excel
 - Microsoft Windows Media Player for Pocket PC
 - Microsoft Reader
 - MSN Messenger
 - hp image viewer
 - CodeWallet Pro from Developer One
-

microsoft pocket outlook

Microsoft Pocket Outlook includes Calendar, Contacts, Tasks, Inbox, and Notes. You can use these programs individually or together. For example, e-mail addresses stored in Contacts can be used to address e-mail messages in Inbox.

Using ActiveSync, you can synchronize information in Microsoft Outlook or Microsoft Exchange on your desktop PC with information in Pocket Outlook on your hp Jornada. Each time you synchronize, ActiveSync compares the changes you made on your hp Jornada and desktop PC and updates both computers with the latest information. For information on using ActiveSync, see ActiveSync Help on your desktop PC.

In this section, you will learn to

- schedule appointments and meetings using Calendar.
- track calendar details using hp month view
- keep track of friends and colleagues using Contacts.
- keep a to-do list in Tasks.
- capture thoughts and ideas with Notes.

For details on using Inbox to send and receive e-mail messages, see "sending and receiving e-mail" in chapter 3.

calendar: scheduling appointments and meetings

Use Calendar to schedule appointments, including meetings and other events. You can check your appointments in one of several views (Agenda, Day, Week, Month, and Year) and easily switch views by using the **View** menu.

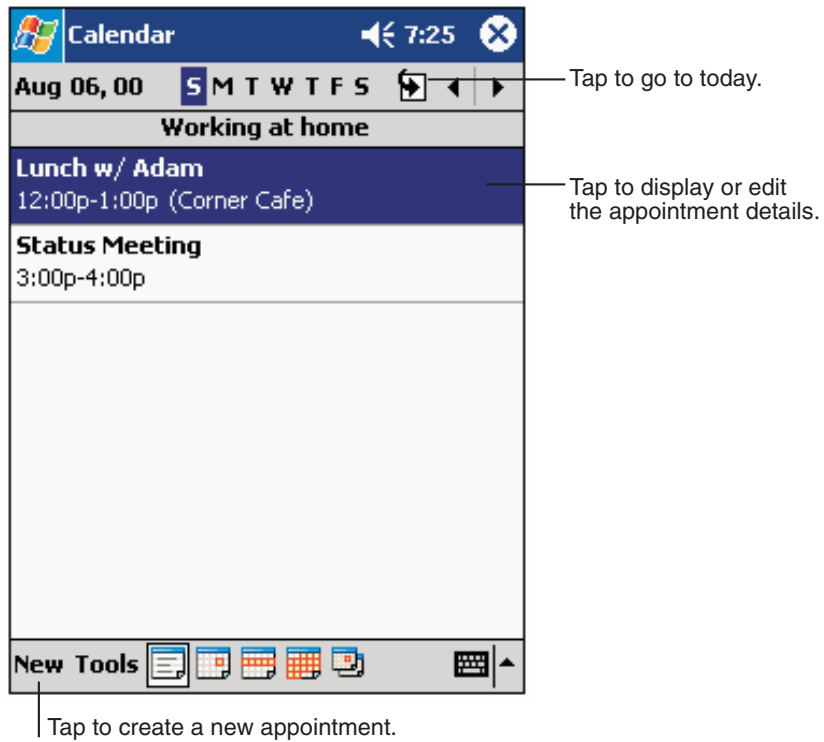

You can customize the Calendar display (for example, change the first day of the week), by tapping **Options** on the **Tools** menu.



To create an appointment

1. In Day or Week view, tap the desired date and time for the appointment.
2. Tap **New**.

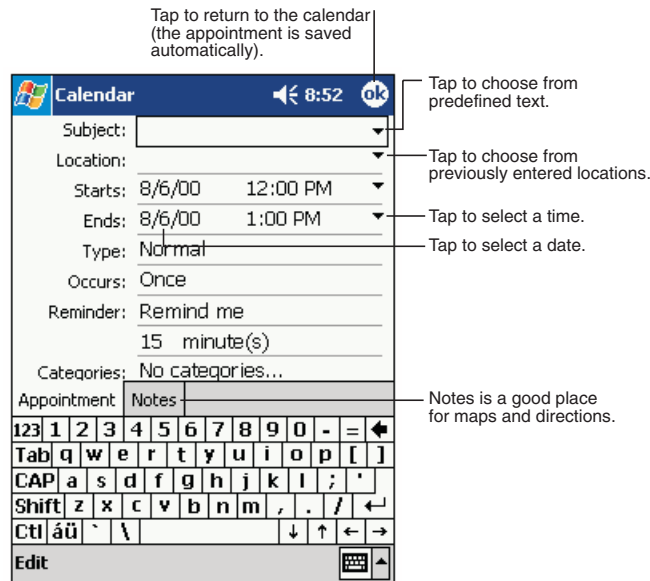

3. Using the Input panel, tap first to select the field, and then enter a description and a location.
4. If needed, tap the date and time to change them.
5. Enter other desired information. You will need to hide the Input panel to see all available fields.
6. To add notes, tap the **Notes** tab. You can enter text, draw, or create a recording. For more information on creating notes, see "Notes: capturing thoughts and ideas," later in this chapter.
7. Tap **OK** to return to Calendar.



If you select **Remind me** in an appointment, your hp Jornada will remind you according to the options set in the Sounds & Notifications control panel.

using the summary screen

When you tap an appointment in Calendar, a summary screen is displayed. To change the appointment, tap **Edit**.

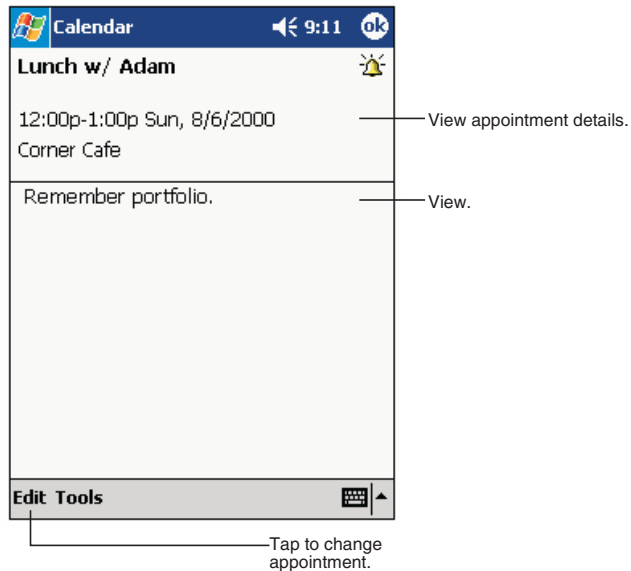

creating meeting requests

You can use Calendar to set up meetings with users of Outlook or Pocket Outlook. The meeting notice will be created automatically and sent either when you synchronize Inbox or when you connect to your e-mail server. Indicate how you want meeting requests sent by tapping **Tools** and then **Options**. If you send and receive e-mail messages through ActiveSync, select **ActiveSync**.

To schedule a meeting

1. Create an appointment.
2. In the appointment details, hide the Input panel, and then tap **Attendees**.
3. From the list of e-mail addresses in Contacts, select the meeting attendees.

The meeting notice is created automatically and placed in the Outbox folder.

For more information on sending and receiving meeting requests, see Calendar Help and Inbox Help on your hp Jornada.

hp month view: managing details by the month

hp month view provides a monthly view of your calendar appointments with details and features for convenient management of calendar data.

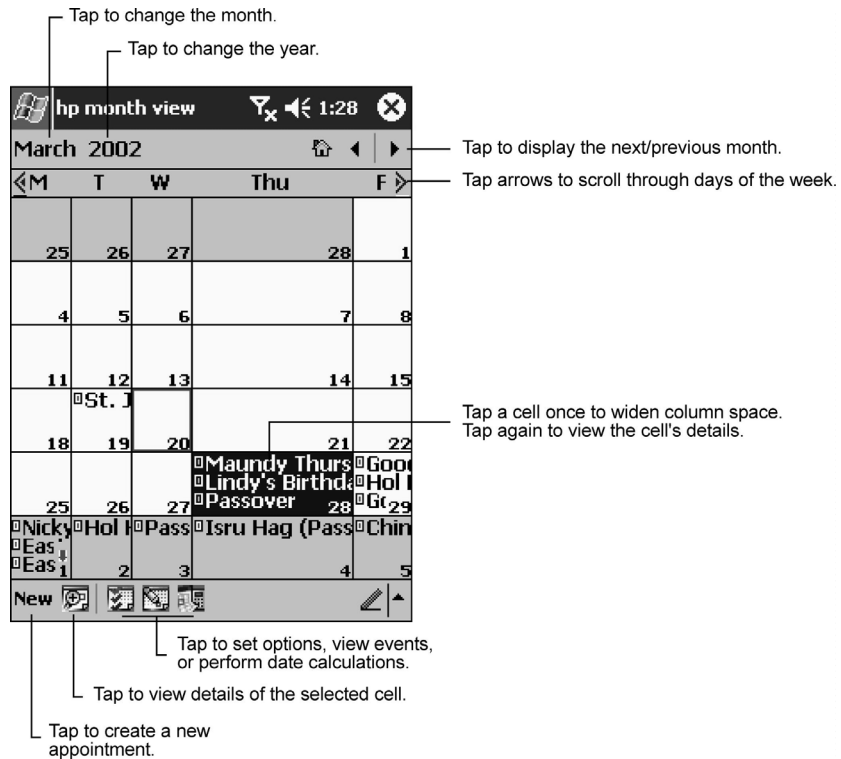

With hp month view you can:

- view appointments and meetings on a monthly calendar.
- easily move from one date to another by tapping the day. Jump to any month or year by tapping the month or year in the navigation bar to bring up a list.
- move forward or backward one month at a time using the arrows in the navigation bar.

- customize the monthly calendar display to your preferences (initially, the calendar displays five-day weeks and automatically widens the column containing the selected day so the full text for appointments is shown).
- zoom in on a day view to modify your calendar data.

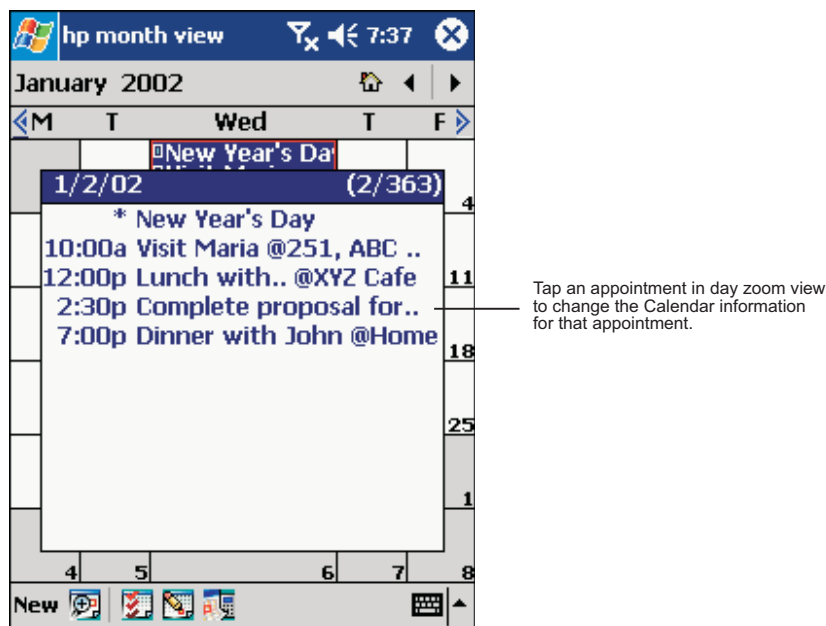

hp month view works with the calendar data you enter in Microsoft Pocket Outlook.

Consider assigning hp month view to the calendar button on your hp Jornada. See "configuring hardware buttons" in chapter 4.



date calculation

You can also use hp month view to calculate the number of days between two dates, or to quickly identify a date that occurs a specified number of days in the future or past.

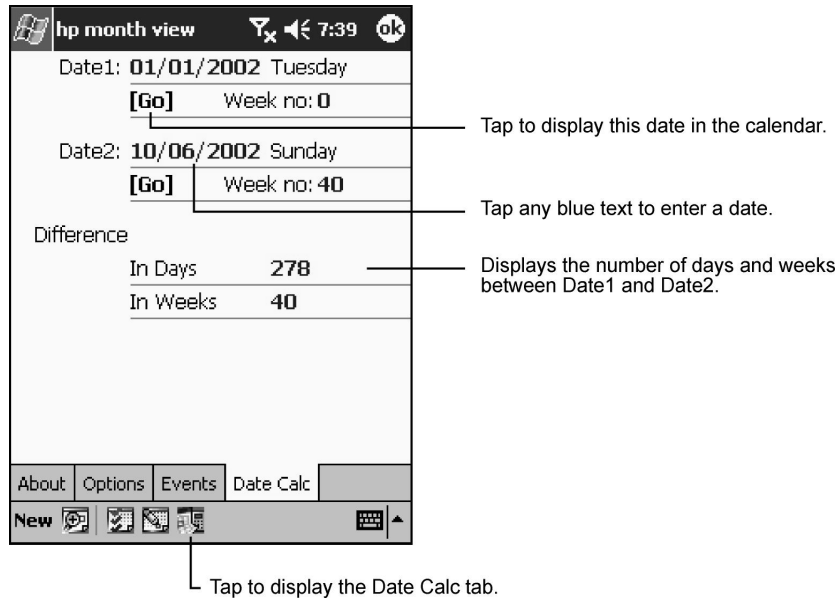

To calculate the number of days between two dates

1. Tap the blue text displayed by **Date1**, and then select a date from the calendar.
2. Tap the blue text displayed by **Date2**, and then select a date from the calendar.
The difference between the two dates (in days and weeks) is shown under **Difference**.

To find a date that is a specified number of days away

1. Tap the blue text displayed by **Date1**, and then select the start date from the calendar.
2. Under **Difference**, tap the blue text, and enter a number of days or weeks.
The resulting date is displayed as **Date2**.

contacts: tracking friends and colleagues

Contacts maintains a list of your friends and colleagues so that you can easily find the information you are looking for, whether you are at home or on the road. Using the hp Jornada infrared port, you can quickly share Contacts information with users of Pocket PCs and other mobile devices.

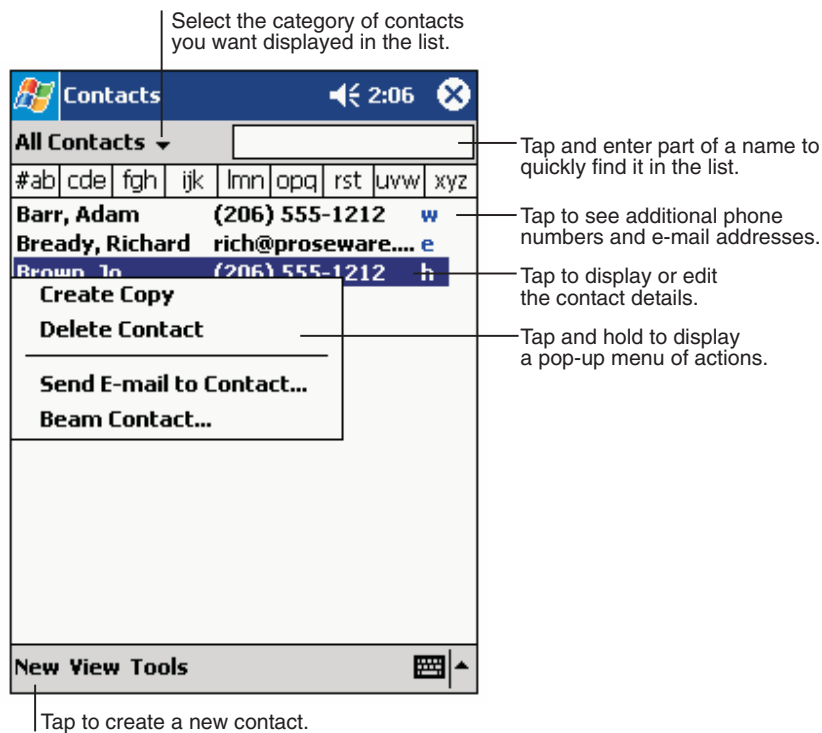

To change the way information is displayed in the list, tap **Tools**, and then tap **Options**.



To create a contact

1. Tap **New**.

Tap to return to the contact list (the contact is saved automatically).

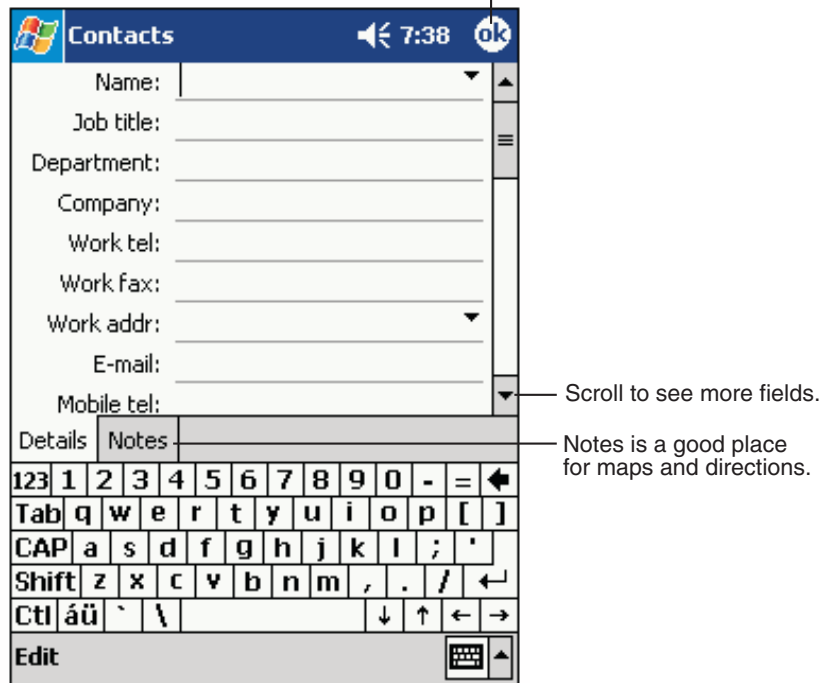

2. Using the Input panel, enter a name and other contact information. You will need to scroll down to see all available fields.
3. To assign the contact to a category, scroll to and tap **Categories** and select a category from the list. In the contact list, you can display contacts by category.

4. To add notes, tap the **Notes** tab. You can enter text, draw, or create a recording. For more information on creating notes, see “notes: capturing thoughts and ideas,” later in this chapter.
5. Tap **OK** to return to the contact list.

finding a contact

There are four ways to find a contact:

- on the **Start** menu, tap **Find**, enter the contact name, select **Contacts** for the type, and then tap **Go**.
- in the contact list, enter a contact name in the box under the Navigation bar. To show all contacts again, clear text from the box or tap the button to the right of the box.
- in the contact list, tap the category list (labeled **All Contacts** by default) and select the type of contact that you want displayed. To show all contacts again, select **All Contacts**. To view a contact not assigned to a category, select **None**.
- to view the names of companies your contacts work for, in the contact list, tap **View**, and then tap **By Company**. The number of contacts that work for that company will be displayed to the right of the company name.

using the summary screen

When you tap a contact in the contact list, a summary screen is displayed. To change the contact information, tap **Edit**.

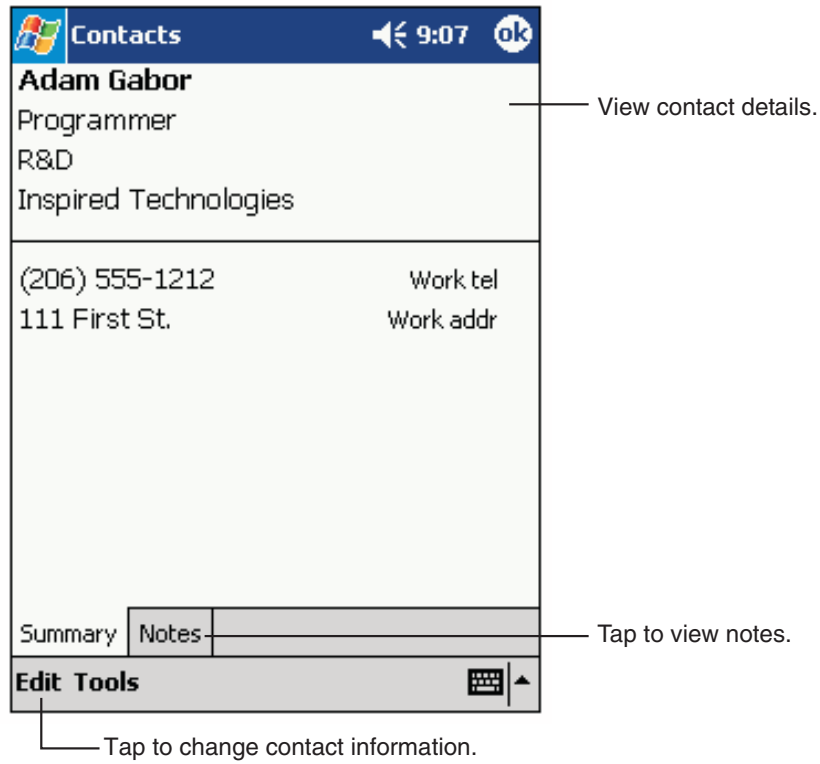

tasks: keeping a to-do list

Use Tasks to keep track of what you have to do.

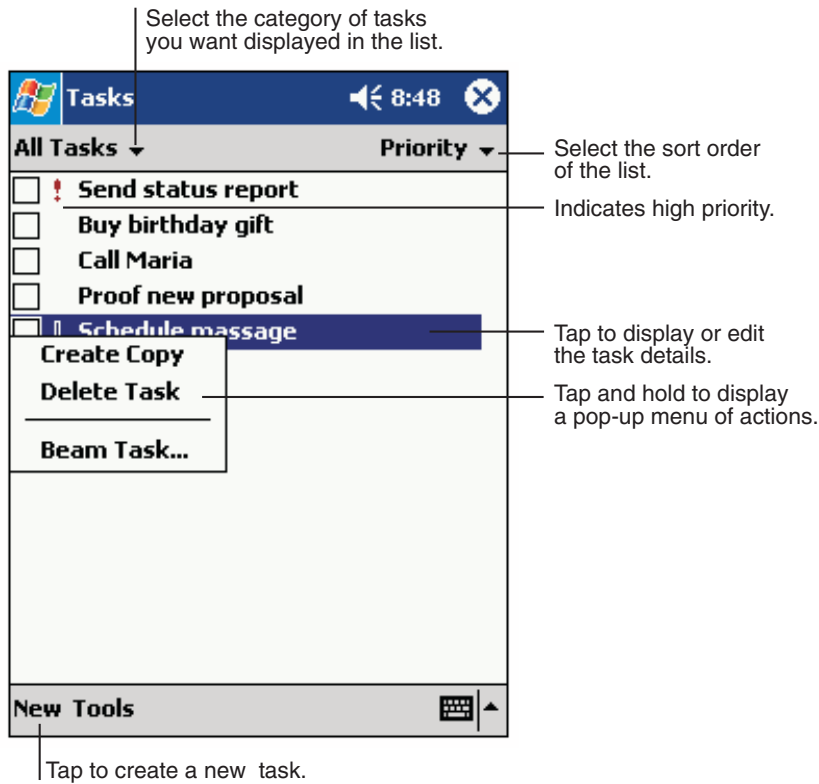

To change the way information is displayed in the list, tap **Tools**, and then tap **Options**.



To create a task

1. Tap **New**.

Tap to return to the task list (the task is saved automatically).

Tap to choose from predefined subjects.

Notes is a good place for maps and drawings.

2. Using the Input panel, enter a description.
3. You can enter a start date and due date or enter other information by first tapping the field. If the Input panel is open, you will need to hide it to see all available fields.
4. To assign the task to a category, tap **Categories** and select a category from the list. In the task list, you can display tasks by category.
5. To add notes, tap the **Notes** tab. You can enter text, draw, or create a recording. For more information on creating notes, see "Notes: capturing thoughts and ideas," later in this chapter.

6. Tap **OK** to return to the task list.

To quickly create a task with only a subject, tap **Entry Bar** on the **Tools** menu, and then tap **Tap here to add a new task**. Enter your task information.



using the summary screen

When you tap a task in the task list, a summary screen is displayed. To change the task, tap **Edit**.

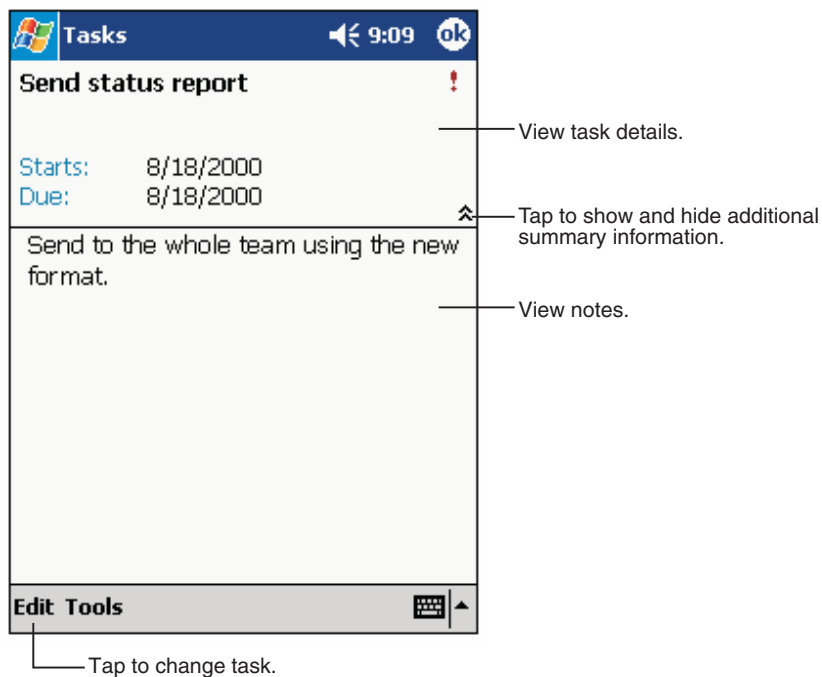

notes: capturing thoughts and ideas

Quickly capture thoughts, reminders, ideas, drawings, and phone numbers with Notes. You can create a written note or a recording. You can also include a recording in a note. If a note is open when you create the recording, it will be included in the note as an icon. If the note list is displayed, it will be created as a stand-alone recording.

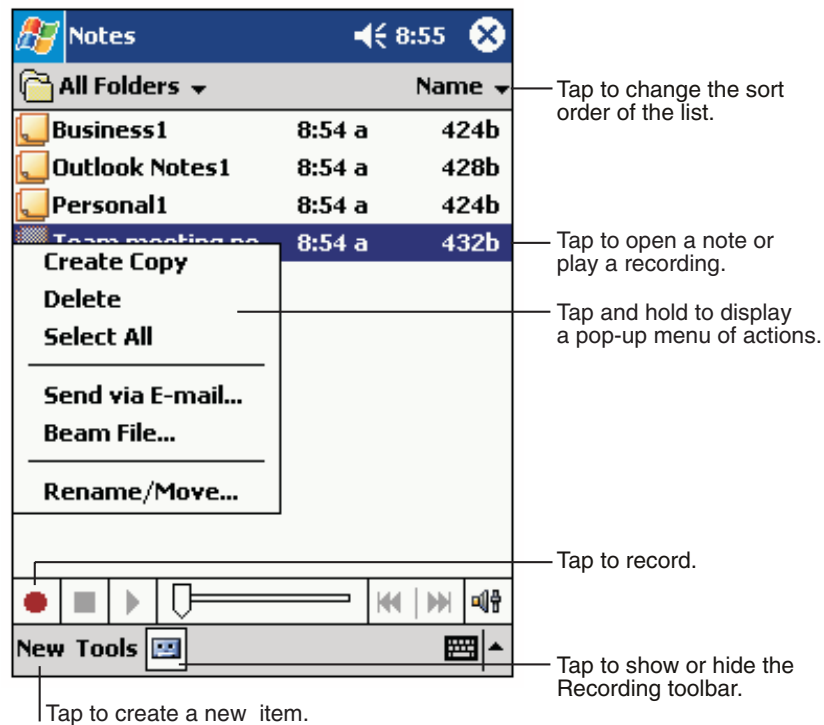

To create a note

1. Tap **New**.
2. Create your note by writing, drawing, typing, or recording. For more information about using the Input panel, writing and drawing on the screen, and creating recordings, see "entering information" in chapter 4.

microsoft pocket word

Microsoft Pocket Word works with Microsoft Word on your desktop PC to give you easy access to copies of your documents. You can create new documents on your hp Jornada, or you can copy documents from your desktop PC. Synchronize documents between your desktop PC and your hp Jornada regularly so that you have the most up-to-date content in both locations.

To use Pocket Word

1. On the **Start** menu, tap **Programs**, and then tap the Pocket Word icon.
2. Tap the name of a document in the file list.
–or–
Tap **New** to open a blank document.

To open a template rather than a blank document, select a template for new documents. On the **Tools** menu, tap **Options**, and then browse to select the default template. When you tap **New**, the template appears with appropriate text and formatting already provided.



You can open only one document at a time; when you open a second document, you will be asked to save the first. You can save a document you create or edit in a variety of formats, including Pocket Word (.psw), Rich Text Format (.rtf), and Plain Text (.txt).

You can enter information in Pocket Word in four modes: writing, drawing, typing, and recording. Use the **View** menu to switch between modes. Each mode has its own toolbar, which you can show and hide by tapping the Show/Hide Toolbar button on the Command bar.

- **typing mode.** Use the Input panel to enter typed text into the document with either the soft keyboard or the Character Recognizer. For more information on entering typed text, see “entering information” in chapter 4.

- **writing mode.** In writing mode, use your stylus to write directly on the screen. Ruled lines are displayed as a guide, and the zoom magnification is greater than in typing mode to allow you to write more easily. For more information on writing and selecting writing, see "entering information" in chapter 4.



Written words are converted to graphics (metafiles) when a Pocket Word document is converted to a Word document on your desktop PC.

- **drawing mode.** In drawing mode, use your stylus to draw on the screen. Gridlines appear as a guide. When you lift your stylus off the screen after the first stroke, you will see a drawing box indicating the boundaries of the drawing. Every subsequent stroke within or touching the drawing box becomes part of the drawing. For more information on drawing and selecting drawings, see "entering information" in chapter 4.
- **recording mode.** Use recording mode to embed a recording into your document. Recordings are saved as .wav files. For more information on recording, see "entering information" in chapter 4.

tips for working in pocket word

- you can change the zoom magnification by tapping **View** and then **Zoom**. Then select the percentage you want. Select a higher percentage to enter text and a lower one to see more of your document.
 - if you are opening a Word document created on a desktop PC, select **Wrap to Window** on the **View** menu so that you can see the entire document.
-

microsoft pocket excel

Microsoft Pocket Excel works with Microsoft Excel on your desktop PC to give you easy access to copies of your workbooks. You can create new workbooks on your hp Jornada, or you can copy workbooks from your desktop PC to your hp Jornada. Synchronize workbooks between your desktop PC and your hp Jornada so that you have the most up-to-date content in both locations. Pocket Excel provides fundamental spreadsheet tools, such as formulas, functions, sorting, and filtering, which enable you to create simple workbooks, such as expense reports and mileage logs.

To use Pocket Excel

1. On the **Start** menu, tap **Programs**, and then tap the Pocket Excel icon.
2. Tap the name of a workbook in the file list.
–or–
Tap **New** to open a blank workbook.

To open a template rather than a blank workbook, select a template for new workbooks. On the **Tools** menu, tap **Options**, and then browse to select the default template. When you tap **New**, the template appears with appropriate text and formatting already provided.



You can open only one workbook at a time; when you open a second workbook, you will be asked to save the first. You can save a workbook you create or edit in a variety of formats, including Pocket Excel (.pxl) and Excel (.xls).

tips for working in pocket excel

- view in full-screen mode to see as much of your worksheet as possible. Tap **View** and then tap **Full Screen**. To exit full-screen mode, tap **Restore**.
 - if your workbook contains sensitive information, you can protect it with a password. To do so, open the workbook, tap **Edit**, and then tap **Password**.
-

- show and hide window elements. Tap **View** and then tap the elements you want to show or hide.
- freeze panes on a worksheet. First, select the cell where you want to freeze panes. Tap **View** and then tap **Freeze Panes**. You might want to freeze the top and leftmost panes in a worksheet to keep row and column labels visible as you scroll through a sheet.
- split panes to view different areas of a large worksheet. Tap **View** and then tap **Split**. Then drag the split bar to where you want it. To remove the split, tap **View** and then tap **Remove Split**.
- show and hide rows and columns. To hide a row or column, select a cell in the row or column you want to hide. Tap **Format**, then tap **Row** or **Column**, and then tap **Hide**. To show a hidden row or column, tap **Tools**, then tap **Go To**, and then type a reference that is in the hidden row or column. Tap **Format**, then tap **Row** or **Column**, and then tap **Unhide**.

microsoft windows media player

Use Microsoft Windows Media Player for Pocket PC to listen to digital audio and video files, such as songs or movie clips. Media Player supports sound files recorded in Windows Media and MP3 formats.

To start Windows Media Player

- On the **Start** menu, tap **Programs**, and then tap the **Windows Media Player** icon.



To save power, turn off the display while listening to music on your hp Jornada. To turn off the display, press and hold the hp home menu hot key to display the hp quick menu, and then tap **Turn display off**. (Press the power button to turn on the display.)



You can copy music files to enjoy on your hp Jornada by converting or "ripping" files from your favorite audio CDs or by downloading songs from a Web site such as EMusic.com. The CD included with your hp Jornada has sample songs from Emusic.com and the MusicMatch JukeBox application, which can be used to record songs from your favorite audio CDs in a format that can be played on your hp Jornada.





Your hp Jornada is uniquely identified by a UUID (Universally Unique ID). Many publishers of digitally secured content, such as MP3 music files and electronic books (eBooks) use digital rights management that relies on the device's UUID to prevent unauthorized usage. After your hp Jornada has been serviced or repaired, you may be unable to access digitally secured content that you had downloaded prior to the service. In such cases, contact the content publisher for assistance.

streaming audio and video

You can use Windows Media Player to enjoy streaming audio and video, such as entertainment, news, music, and more.¹ To see a list of available content, connect to the MSN Mobile site using Pocket Internet Explorer on your hp Jornada.

To view streaming media

1. On the **Start** menu, tap **Internet Explorer**.
2. Tap **MSN Mobile**.
3. On the MSN Mobile page, tap the link to **MSN Mobile**.
4. Tap the link to Windows Media.com.

working with audio files on a compactflash card

Because songs and audio files can use a lot of storage memory, you might want to store them on a CompactFlash memory card. For more information on installing a CompactFlash card and working with files on the card, see "pda accessories" in chapter 4.

¹ Access to streaming content requires a separate wireless data subscription from your service provider.

microsoft reader

Use Microsoft Reader to read eBooks on your hp Jornada. Download books to your desktop PC from eBook Web sites. Then, use ActiveSync to copy the book files to your hp Jornada. The books appear in the Reader Library.

Each book consists of a cover page, an optional table of contents, and the pages of the book. You can

- page through the book by using the volume/scroll control on your hp Jornada or by tapping the page number on each page.
- annotate the book with highlighting, bookmarks, notes, and drawings.
- search for text and look up definitions for words.

The Reader Guidebook is preinstalled on your hp Jornada, and contains all the information you will need to use Microsoft Reader. To open the Guidebook, tap **Help** on the Reader command bar. Or, on a book page, tap and hold on the book title, and then tap **Help** on the pop-up menu.

To start Microsoft Reader

- On the **Start** menu, tap **Programs**, and then tap **Microsoft Reader**.

getting ebooks for your hp Jornada

You can download book files from the Web. Just visit your favorite eBook retailer and follow the instructions to download the book files. Sample books and a dictionary are also included in the MSReader folder in the Extras folder on the Pocket PC Companion CD.

Your hp Jornada is uniquely identified by a UUID (Universally Unique ID). Many publishers of digitally secured content, such as MP3 music files and eBooks, use digital rights management that relies on the device's UUID to prevent unauthorized usage. After your hp Jornada has been serviced or repaired, you may be unable to access digitally secured content that you had downloaded prior to the service. In such cases, contact the content publisher for assistance.



using the library

The Library is your Reader home page; it displays a list of all books stored on your hp Jornada or storage card.

To open the Library

- On the Reader command bar, tap **Library**.
–or–
On a book page, tap the book title and then tap **Library** on the pop-up menu.

To open a book

- Tap a title in the Library list.

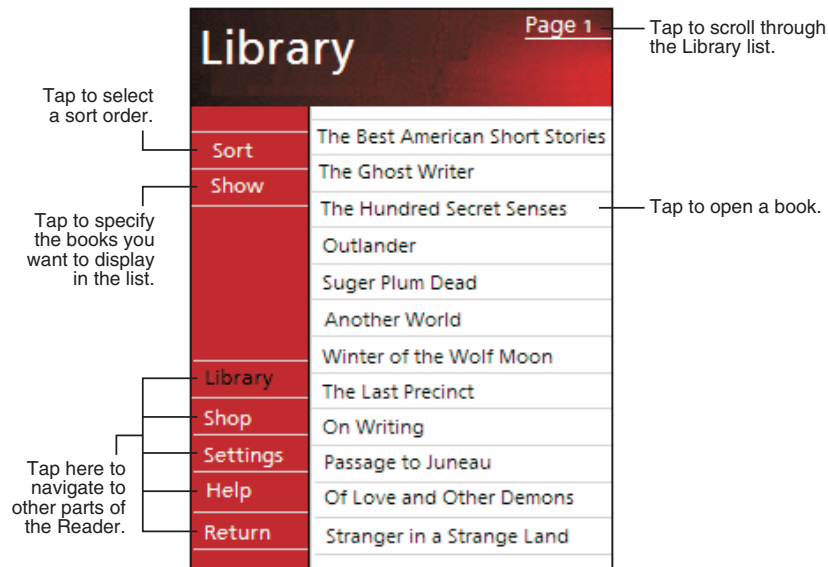

reading a book

Each book consists of a cover page, an optional table of contents, and the pages of the book. Navigation options are listed in the bottom portion of the cover page.

The first time you open a book, you will probably want to go to the first page or to the table of contents, if there is one. Subsequently, whenever you open the book, you will be automatically taken to the last page you read.

In addition to the text, each book page includes a page number and book title.

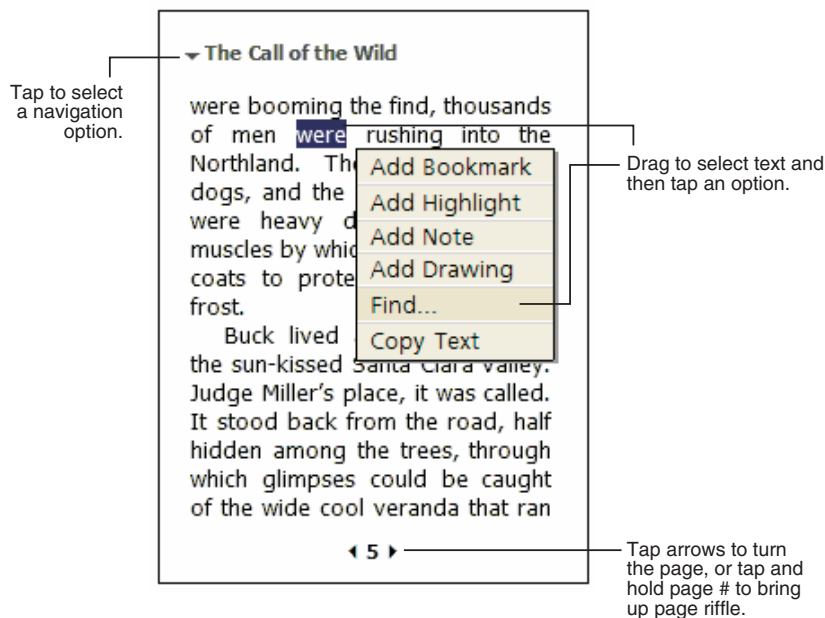

You can also page through a book by using the volume/scroll control on your hp Jornada.

using reader features

Reading a book electronically gives you several options not available with paper books. These options are available from any book page.

Select text by dragging across the text on the page. Then, tap an option on the pop-up menu, as described here:

- **Search for text.** Find text in a book by tapping **Find** on the pop-up menu. Enter the word you want to search for, and tap the desired **Find** option. Reader highlights the found text on the page. To close **Find**, tap outside the box. To return to your original page, tap the title and then tap **Return** on the pop-up menu.
- **Copy text.** You can copy text from books that support this feature into any program that accepts text. On a book page, select the text you want to copy, and then tap **Copy Text** on the pop-up menu. The text can be pasted into the program of your choice.
- **Bookmarks.** When you add a bookmark to a book, a color-coded bookmark icon appears in the right margin. You can add multiple bookmarks to a book. Then, from anywhere in the book, tap the bookmark icon to go to the bookmarked page.
- **Highlights.** When you highlight text, it appears with a colored background.
- **Notes.** When you attach a note to text, you enter the text in a notepad that appears on top of the book page. A Note icon will be displayed in the left margin. To show or hide the note, tap the icon.
- **Drawings.** When you add a drawing, a Drawing icon appears in the lower-left corner of the page, and drawing tools appear across the bottom of the page. Draw by dragging your stylus.
- **Annotations.** To see a list of a book's annotations, including bookmarks, highlights, text notes, and drawings, tap **Annotations Index** on the book's cover page. You can tap an entry in the list to go to the annotated page.

removing a book

When you finish reading a book, you can delete it to conserve space on your hp Jornada. If a copy of the book is stored on your desktop PC, you can download it again at any time.

To remove a book from your hp Jornada, tap and hold the title in the Library list, and then tap **Delete** on the pop-up menu.

msn messenger

MSN Messenger is an instant messaging program that lets you

- see who is online.
- send and receive instant messages.
- have instant message conversations with groups of contacts.

To use MSN Messenger, you must purchase and install an optional modem and have an account with an ISP. For more information, see “connecting to the internet or to a network” in chapter 3.

In addition, you must have a Microsoft Passport account or a Microsoft Exchange e-mail account. You must have a Passport to use MSN Messenger Service. If you have a Hotmail® or MSN account, you already have a Passport. Once you have obtained either a Microsoft Passport or a Microsoft Exchange account, you are ready to set up your account.

Sign up for a Microsoft Passport account at <http://www.passport.com>. Get a free Microsoft Hotmail e-mail address at <http://www.hotmail.com>.



To switch to MSN Messenger

- On the **Start** menu, tap **Programs**, and then tap the MSN Messenger icon.

setting up to use msn messenger

Before you can connect, you must enter Passport or Exchange account information.

To set up an account and sign in

1. On the **Tools** menu, tap **Options**.
 2. On the **Accounts** tab, enter your Passport or Exchange account information.
 3. To sign in, tap the sign-in screen and enter your e-mail address and password.
-



If you already use MSN Messenger on your desktop PC, your contacts will show up on your device without being added again.

working with contacts

The MSN Messenger window shows all of your messenger contacts at a glance, divided into Online and Not Online categories. From this view, while connected, you can chat, send e-mail messages, block the contact from chatting with you, or delete contacts from your list using the pop-up menu.

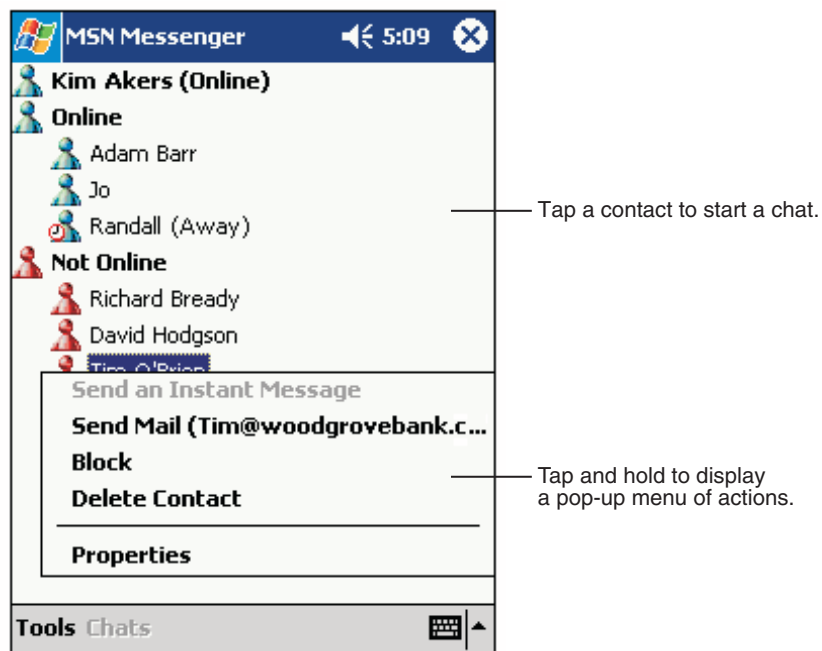

To see others online without being seen, on the **Tools** menu, tap **My Status**, and then tap **Appear Offline**.



If you block a contact, you will appear offline but will remain on the blocked contact's list. To unblock a contact, tap and hold the contact, then tap **Unblock** on the pop-up menu.



chatting with contacts

Tap a contact name to open a chat window. Enter your message in the text entry area at the bottom of the screen (or tap **My Text** to enter a preset message), and then tap **Send**. To invite another contact to a multi-user chat, on the **Tools** menu, tap **Invite**, and then tap the contact you want to invite.

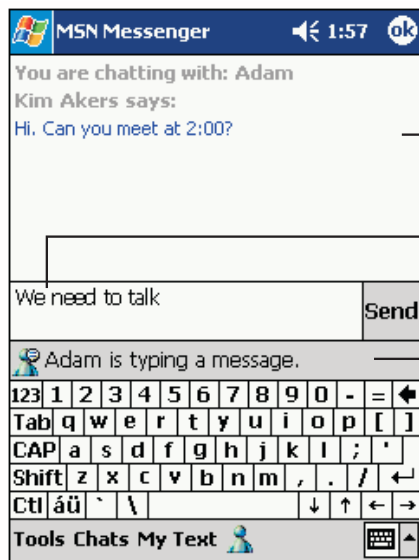

View full chat.

Enter your message.

Tap to send message.

View status of chat.



To switch back to the main window without closing a chat, tap the Contacts button. To revert to your chat window, tap **Chats**, and then select the person with whom you were chatting.

hp image viewer

The hp image viewer application enables you to view and edit image files stored on your hp Jornada. You can view images in the JPG, BMP, 2BP, GIF, and PNG formats.



The hp image viewer application works great with the optional hp Pocket Camera and pocket camera software, enabling you to take pictures and view them immediately on your hp Jornada. The pocket camera software is preinstalled on your hp Jornada. The hp Pocket Camera is available as an optional accessory. For more information, see the Accessories Guide, or visit the hp Jornada Web site at www.hp.com.

You can view pictures on your hp Jornada in three ways:

- browse mode shows small "thumbnails" of all the images on your hp Jornada, with a preview of the current image.
- view mode displays a single image at full size.
- slideshow displays images sequentially, resized to fit your screen.

To start hp image viewer

1. On the **Start** menu, tap **Programs**, and then tap the hp applications folder.
2. Tap the hp image viewer icon.

By default, hp image viewer starts in Browse mode and displays images that are saved in the My Documents folder on your hp Jornada.

To view pictures in a different folder

- On the **View** menu, tap **Change Folder**, and then select a folder from the drop-down list.
-

If you have an hp Jornada Pocket Camera, tap the camera icon in the Command bar (or tap **Capture** on the **View** menu) to switch to Capture mode. If the camera is not installed, switching to Capture mode will display the “no camera” icon, . For more information on the hp Jornada Pocket Camera, see the Accessories Guide, or visit the hp Jornada Web site at www.hp.com.



browse mode

Browse mode displays thumbnail views of the pictures in the current folder and information about the selected picture.



The Preview window displays the selected picture. (If no picture is selected, the Preview window is blank.)

Displays the file name, capture date and time, quality, and size of the selected picture.

Tap a thumbnail to display the picture in the Preview window.

Tap to scroll forward or back through thumbnails.

Tap menus or icons to change modes, edit the selected picture, or send the picture by e-mail or infrared.

Tap the picture in the Preview window to switch to View mode and view the picture at actual size.



From Browse mode, you can perform file actions (rename, copy, or delete) on selected images. You can also record sound files to go with a specific images.

renaming, copying, deleting, and rotating images

Use the **Edit** menu to rename, delete, move, copy, and rotate images. When renaming an image, do not enter the file name extension (for example, .jpg)



You can delete, move, and copy several images at once. Select multiple images by tapping the triangle in the upper left corner of the thumbnail images, or tap **Mark** on the **Edit** menu.

recording sound files

You can record sound files to go with your images. When you display an image with an associated sound file, the sound file is played (unless the **Play review-related sounds** option has been disabled). An image that has an associated sound file has a musical note icon on its thumbnail.

To record a sound file to go with an image

1. In Browse mode, select the image.
 2. Tap the Sound button on the menu bar to display the Recording toolbar.
 3. On the Recording toolbar, tap the Record button.
 4. Speak into the microphone or record the sound.
 5. When you have finished, tap the Stop button on the Recording toolbar.
-

view mode

Use View mode to view a picture on your hp Jornada screen at actual size.

To switch to View mode

- Tap the picture in the Preview window.
–or–
On the **View** menu, tap **Actual Size**.

To close hp image viewer

- Tap **OK**.

If the image is too large to fit on the screen, the Overview window in the lower-right corner of the image displays a thumbnail of the entire image. A black rectangle in the Overview window marks the area of the image that is displayed in the main window. Display other parts of the image by tapping an area in the thumbnail, by scrolling with the navigation pad, or by dragging the stylus on the screen.

slideshow mode

In Slideshow mode, pictures are resized (and/or rotated) to fit the screen of your hp Jornada. You can choose whether the slideshow automatically displays the next picture in sequence after a short delay, or whether you change the picture by pressing the navigation pad or the volume/scroll control.

To start the slideshow

- On the **View** menu, tap **Slideshow**.

To stop the slideshow

- Press the action button.

To set slideshow options

1. On the **View** menu, tap **Options**, and then tap the **Slideshow** tab.
-

2. Select from the following slideshow options:
 - **Sequence.** To automatically play the slideshow, select the order in which you want pictures displayed: **Forward**, **Reverse**, or **Random**. To control the slideshow manually (by rocking the action button to display the next picture), select **Off**.
 - **Delay.** Set the delay time (in seconds) you want the slideshow to wait before it automatically displays the next picture.
 - **Wrap around.** To repeat the slideshow after the final picture has been displayed, select the **Wrap around** check box. Clear the check box if you want the slideshow to stop after the last picture.
 - **Auto-rotate.** Select the **Auto-rotate** check box to rotate pictures if necessary to better fit the screen. Select either **Clockwise** or **Anti-clockwise** to determine the direction of rotation.
 - **Show filename and Show date.** Select **Show filename** and/or **Show date** to display information about the picture on the screen during the slideshow.
 - **Play audio.** Select **Play audio** to play any associated sound files when the picture is displayed.

sending images

You can also use hp image viewer to send images by e-mail, send images by infrared, or copy and paste images into Word documents and notes.

To send an image as an attachment to an e-mail message

1. In Browse mode, select the image that you want to send.
2. On the **Send** menu, tap **E-Mail**.
This will launch Pocket Inbox and open a new e-mail with the image as an attachment.

To send an image to another PDA by infrared

1. In Browse mode, select the image that you want to send.

2. On the **Send** menu, tap **Infrared**.
3. Align the infrared ports on your hp Jornada with the infrared ports on the receiving device, and set the receiving device to receive the file.

To send an image to an infrared-equipped printer or desktop PC

1. In Browse mode, select the image that you want to send.
2. On the **Edit** menu, tap **Send IrOBEX**.
3. Align the infrared ports on your hp Jornada with the infrared ports on the receiving device.

To copy an image to a document

1. In Browse mode, select the image that you want to copy.
2. On the **Edit** menu, tap **Copy to Clipboard**, and then choose the appropriate size.
3. Switch to the document or note into which you will paste the image.
4. On the **Edit** menu, tap **Paste**.

adding comments to images

You can add comments use image viewer to add comments to .jpg files.

To add a comment to a .jpg file

1. In hp image viewer, tap a .jpg image.
2. On the **Edit** menu, tap **Comments**. An edit window appears, showing any currently embedded text in the image.
3. Add or modify text in the edit window.
4. Tap **OK** to save your changes.

Only modifiable JPEG image files allow the inclusion of comments. If another image format is selected, the **Comments** menu item is unavailable.



codewallet pro

CodeWallet Pro allows you to easily store, organize, and retrieve personal information, such as credit card numbers, favorite URLs, and emergency phone numbers. CodeWallet includes information forms for your convenience, and stores your data in encrypted, password-protected files.



CodeWallet Pro may not be included on some models of the hp Jornada.

To start CodeWallet Pro

- On the **Start** menu, tap **Programs**, and then tap the CodeWallet Pro icon.

For detailed help and procedures about using CodeWallet Pro, refer to online Help or the CodeWallet Pro User's Guide on the Pocket PC Companion CD.

6 | troubleshooting

If you encounter difficulty while using your hp Jornada, this chapter will help you find answers. If you need information about troubleshooting ActiveSync or connecting to your desktop PC, click **Microsoft ActiveSync Help** on the **Help** menu in ActiveSync.

The information in this chapter will help you

- reset your hp Jornada.
 - restore your hp Jornada to the factory default settings.
 - troubleshoot basic problems.
 - troubleshoot problems with remote connections.
 - troubleshoot problems with the display and touch screen.
 - troubleshoot phone problems
-

resetting your hp Jornada

Occasionally, you may need to reset your hp Jornada; for example, you should reset after you restore data from your desktop PC or when the operating system stops responding. Resetting your hp Jornada is similar to restarting your desktop PC. It restarts the operating system and preserves any saved data, but you will lose any unsaved data.

Reset after restoring data from a backup file or when your hp Jornada appears to be "frozen" or "locked up."



When you reset, you lose unsaved data in all open documents or programs. Use hp task switcher to close all open documents and programs before you reset.

To reset

1. Remove your hp Jornada from the cradle.
2. Remove the CompactFlash card (if installed).
3. Use the stylus to press the red reset button on the back of the hp Jornada, as shown in the following illustration.



restoring factory defaults

In some cases, such as when your hp Jornada does not respond after being reset or when you forget your password, you may need to restore your hp Jornada to the factory default settings. This erases all data stored in RAM. All information you have entered, including all files, system settings, and programs you have installed, may be erased.

To ensure the safety of your information should it be necessary to restore the factory defaults, you should regularly back up your data to your desktop PC (using ActiveSync), to a CompactFlash card (using the hp backup application). For more information on backing up data, see “backing up and restoring data” in chapter 4.

Restoring the factory default settings erases all files, programs, and data stored in RAM. You can restore data from a backup file saved on your desktop computer or on a CompactFlash card. (For more information, see “backing up and restoring data” in chapter 4, or ActiveSync Help on your desktop computer.)



To restore the factory defaults

1. Remove your hp Jornada from the USB cradle and disconnect all cables, including the ac adapter, from your hp Jornada.
2. Using the stylus, press and hold the reset button.
3. While holding the reset button, press and release the power button.
4. Release the reset button
5. Press the power button.

After you restore the factory defaults, you will need to complete the Welcome Wizard and re-establish a partnership with your desktop PC. You may also want to restore data to your hp Jornada from your most recent backup file. For more information, see “using your hp Jornada for the first time” in chapter 1, and “backing up and restoring data” in chapter 4.

basic problems

If you have a specific problem, review the information below to see if you can quickly find the answer. Or, visit the hp Web site at www.hp.com for more information about common difficulties.

Problem	Diagnosis/Remedy
hp Jornada does not turn on when not connected to ac power.	<i>Power is too low to run your hp Jornada. Connect to ac power, and then turn on your hp Jornada. (Charge the batteries regularly to avoid running out of battery power.)</i>
Batteries run out of power quickly.	<p><i>You are using your hp Jornada in ways that drain power quickly. Use external power to charge and power your device whenever possible, especially when listening to music or using CompactFlash accessories. Using wireless LAN, GPRS, and GSM functions can also drain the batteries very quickly. Turn off these functions when they are not in use.</i></p> <p>—or—</p> <p><i>Alerts and notifications are causing your hp Jornada to turn on, even when you are not using it. Check the “wake up sources” under When device is off in the Power Preferences page in hp profiles.</i></p> <p>For more information, see “managing power” in chapter 1.</p>

Problem	Diagnosis/Remedy
hp Jornada automatically shuts down/suspends.	<p><i>Power is too low.</i> When a critically low power condition is encountered, the hp Jornada initiates a safety shutdown. Connect to ac power and charge the batteries.</p> <p>–or–</p> <p><i>Auto-suspend activated.</i> To conserve power, the hp Jornada auto-suspends if it is idle for one minute immediately after power is turned on. It also auto-suspends if it is continuously idle for five minutes.</p> <p>–or–</p> <p><i>hp Jornada is locked up.</i> Connect to external power, and reset your hp Jornada. (See “resetting your hp Jornada” in this chapter.) (Caution: You may lose any unsaved data when you reset.)</p>
hp Jornada locks up when running applications, or it runs slowly.	<p><i>hp Jornada is locked up.</i> Connect to ac power, and reset. (see “resetting your hp Jornada” in this chapter.) Note: Check to ensure that the device is not running low on power, and avoid running several applications at the same time. Use hp task switcher to close applications that are not in use.</p>
Phone ringing volume is too soft/loud.	<p><i>Ring volume not set properly.</i> The phone ringing volume and the volume of PDA alerts and notifications are controlled separately. Use the Alert page of the hp profiles application to set the ringing volume for the phone.</p>

Problem	Diagnosis/Remedy
Unable to send SMS.	<i>Messages not addressed to mobile phone.</i> When you send SMS messages to contacts save in your Pocket Outlook Contacts database, be sure to use the number in the Mobile field. The contact must be selected (highlighted in blue) before it can be sent.
hp Jornada does not turn on or display appears to be off, even though power is on.	<i>The display is off.</i> Press the power button to turn on the display. —or— <i>There is not enough light to see the display.</i> Turn on lights or move to a room with more light. Use hp profiles to increase the brightness of the display. Change hp profiles to use the light sensor to automatically turn on the backlight in dark conditions. —or— <i>The device has been reset.</i> After a reset, the screen remains blank for approximately three seconds after pressing the power button. —or— <i>hp Jornada has run out of power.</i> Charge the device by connecting to ac power

Problem	Diagnosis/Remedy
Backup file created with the hp backup application on another hp handheld device cannot be restored to the hp Jornada.	<i>Only PIM data can be migrated to hp Jornada 920 series wireless digital assistants.</i> Because the hp Jornada 920 series wireless digital assistant uses a new version of the Pocket PC operating system, it is recommended that you restore PIM data from an older device by using Microsoft ActiveSync or Microsoft Outlook rather than hp backup. Synchronize your older hp handheld device with Microsoft Outlook on your desktop PC, and then establish a new partnership to transfer data to your new hp Jornada.
Difficult to install or run software from previous hp handheld.	<i>Software that runs on previous hp handheld devices may not run on your hp Jornada 920 series wireless digital assistant.</i> Because the hp Jornada 920 series wireless digital assistant uses a different processor and a new version of the Pocket PC operating system, software built for previous-generation Pocket PCs (such as hp Jornada 430, 420, 520, 540, 560, or 570 series) may not run on the hp Jornada 920 series. Check with the software vendor for an upgrade or newer version that will run on the hp Jornada 920 series.
Inaccurate response to stylus tap.	<i>The calibration of the touch screen may be off.</i> Realign the touch screen. Press and hold the hp home menu hot key to display the hp quick menu, and then use the navigation pad and action button to launch the Align Screen control panel.

Problem	Diagnosis/Remedy
Unable to locate files in CompactFlash memory in applications.	<i>Files must be stored in the My Documents folder on the CompactFlash card. Create the My Documents folder using File Explorer, and move files into this folder.</i>
Data is lost.	<i>hp Jornada has run out of power. Restore data from a backup file on your desktop PC or a CompactFlash card.</i> <i>–or–</i> <i>Factory default settings have been restored. Restore data from a backup file on your desktop PC or a CompactFlash card.</i>

remote connections

This section offers troubleshooting help for connecting your hp Jornada to other computers. For problems communicating with your desktop PC, see ActiveSync Help.

able to dial out, but unable to make proper connection

Make sure the network to which you are trying to connect supports Point-to-Point Protocol (PPP). Your Internet service provider or network administrator can verify this.

Verify that the dialing location is correct. On the **Start** menu, tap **Settings**, and then on the **Connections** tab, tap **Connections**. On the **Dialing Locations** tab, select the location you are dialing from and confirm that the settings are appropriate for that location.

GPRS connection is unreliable

- **GPRS connection not established.** Make sure to have a GPRS connection before you begin downloading.
- **GPRS connection dropped.** If you make a call while connected to GPRS, the connection is dropped when the other party answers the call. You must manually re-connect GPRS.

unable to use infrared transfer between windows-powered devices

If you are unable to use infrared to transfer information between Windows-powered devices, try the following:

- transfer only one file, or no more than 25 contact cards, at a time.
- position the infrared ports so that they line up and are less than one meter (three feet) but more than five centimeters (two inches) apart.
- make sure nothing is between the two infrared ports.
- adjust the room lighting. Some types of light interfere with infrared communication. Try moving to a different location or turning off some lights.

The hp Jornada 920 series do not support raw IR.



network connection problems

The following solutions may help if you encounter problems when using a network card for network connections. Additional troubleshooting information is available in Connections Help on the device and ActiveSync Help on the desktop PC.

- verify that your NIC is compatible with the hp Jornada 920 series wireless digital assistant and that you have installed the proper drivers for the hp Jornada.
-

- in the properties for your network adapter, ensure that you have properly configured the IP settings, and the addresses of your DNS servers and/or WINS servers. Check with your network administrator to determine the proper settings.
- verify that you have added necessary server information. On the **Start** menu, tap **Settings**. On the **Connections** tab, tap **Network**. Tap your installed adapter (usually your Ethernet card's name) and enter any necessary information. Most networks use DHCP to assign IP addresses dynamically; you should not have to change or enter an IP address settings unless your network administrator instructs you to do so.
- if **Network Connection** is not listed as a connection method in the **ActiveSync** dialog box when starting synchronization, wait a few minutes and try again. Also, if synchronization does not start right away, the network is probably busy, and it may take a minute for your device to connect to the network.
- verify with your network administrator that your user name and password are correct.
- verify with your network administrator that the network you are trying to connect to is available, or try to connect to it from another computer.
- you may need to change the device name if you are trying to connect to a network and cannot because another device with the same name is already connected. To change the device name, on the **Start** menu, tap **Settings**. On the **System** tab, tap **About**, and then tap the **Device ID** tab.

cradle connection problems

If you are having trouble connecting to your desktop PC using the USB cradle, try these possible solutions. For additional, up-to-date troubleshooting information, refer to ActiveSync Help on your desktop PC or to the Microsoft Mobile Devices Web site at www.microsoft.com/mobile/pocketpc.

- ensure you have installed the correct version of ActiveSync on your desktop PC. Install the version ActiveSync included with your hp Jornada 920 series wireless digital assistant.
- ensure that your hp Jornada is on.
- ensure that you do not have any other active connections. On the **Start** menu, tap **Today**. Tap  at the bottom of the screen, and then tap **Disconnect**.
- ensure the cable is securely plugged into the USB port on the back of your desktop PC. Connect the USB cable directly to your desktop PC—do not run the cable through a USB hub.
- enable the USB connection on your hp Jornada. On the **Start** menu, tap **ActiveSync**. On the **Tools** menu, **Options**. Under **Enable synchronization when cradled using**, select **USB connection** from the drop-down list.
- ensure the USB connection is enabled in ActiveSync on your desktop PC. Refer to ActiveSync Help on your desktop computer. If the USB connection is already enabled, disable the USB connection, close the Connection Settings window, and then reopen and re-enable the USB connection.
- reset your hp Jornada before putting it in the cradle to connect. For more information, see “resetting your hp Jornada,” earlier in this chapter.
- always disconnect your hp Jornada before you restart your desktop PC.
- connect only one Pocket PC or wireless/personal digital assistant to your desktop PC at a time.

display problems

If you are having trouble viewing data on your hp Jornada screen, follow these suggestions.

screen is blank

Follow these steps if the screen remains dark or if the device does not respond when you briefly press the power button:

- press the power button to ensure that the display is on.
- reset the device. After a reset, the screen remains blank for approximately three seconds after pressing the power button.
- charge the device by connecting to ac power.

display is difficult to see in dark rooms

Use hp profiles to adjust the display brightness for optimal viewing. (See "display and alert profiles" in chapter 4.) In very bright light, select the Outdoor profile in hp profiles. In very dark conditions, apply the Low Power profile. In a dark room, you may also need to turn on the backlight or position a lamp so that the light shines directly on the screen. Use hp profiles to set the backlight to come on automatically in dark conditions.



screen is difficult to read

If you are having a hard time viewing a document in Notes, try changing the size of the view. To do this, tap a zoom percentage on the **Tools** menu. In Pocket Word and Pocket Excel, on the **View** menu, tap **Zoom** and then select a zoom percentage. In Pocket Internet Explorer, on the **View** menu, tap **Text Size** and then select a size.

phone problems

bad reception, or calls are dropped

The phone sends and receives radio signals. As with all radio equipment, the quality of your reception depends on the strength of the signal in the area where you are using the phone. Signal strength will vary depending on your surroundings and your location relative to your GSM/GPRS service provider's antenna relay.

The  icon in the phone display indicates the signal strength. The  icon indicates that the phone is not receiving a signal. To improve signal strength and improve reception, try these steps:

- if you are in a building, move near a window, or go outside.

- if you are in a reinforced structure, such as an elevator or parking garage, wait until you are outside to try your call.
- lift the antenna.

sim card not detected



If you receive an error message indicating that your SIM card is invalid, ensure that you have installed the SIM card correctly. Check the orientation of the SIM card, and be sure to lock the SIM card slot before re-installing the removable battery. If you see this message when the SIM card is installed properly, the SIM card may be faulty. Contact your GSM service provider for more information.

cannot turn on phone, but can use pda functions

- ensure that the removable battery is properly installed.
- check battery power. If total battery power (both embedded and removable batteries) is low, or if the embedded battery is empty, you cannot use phone functions.
- Reset your hp Jornada. For more information, see “resetting your hp Jornada” earlier in this chapter.
- if you receive an error message indicating that your SIM card is invalid, ensure that you have installed the SIM card correctly. Check the orientation of the SIM card, and be sure to lock the SIM card slot before re-installing the removable battery.

7 | support and service

web site

You can obtain product information as well as tips and hints on how to get more from the hp Jornada product at our Worldwide Web site. This service is provided free of charge; you pay only for telephone charges and Internet service fees. To connect to this Web site from a computer via the Internet, go to www.hp.com.

customer support

To ensure a fast response to your technical support questions, you should first contact your service provider or point of sale. If you have questions that the user's guide or the Web site does not answer (after checking the contents and index), you can contact Hewlett-Packard Worldwide Support and Services for Handheld Products at the telephone numbers listed in the following table.

If the device requires service, contact Hewlett-Packard for service information, shipping instructions, and out-of-warranty service charges before you send your device to hp for repair. In countries not listed in the table, contact the Hewlett-Packard authorized dealer or sales office.

service

For diagnostic instructions and other service information, contact one of the technical support numbers listed. Please do not ship your device for service without first contacting a Hewlett-Packard office. If your device qualifies for in-warranty service, be ready to supply a dated proof of purchase. In countries not listed in the following table, contact the Hewlett-Packard authorized dealer or sales office.

Before you contact us for help, be sure to:

1. Review the manuals whenever possible.
 2. Have the following information about the product:
 - model number
-

- serial number
 - purchase date
3. Have your product ready to use. The support personnel may ask you to run tests and other operations.
 4. Organize your question or problem. The more detailed information you can provide, the quicker the support personnel can help you.

contacting hewlett-packard worldwide

You will be pleased to know that our commitment to quality does not stop at the sale. Our worldwide customer support network is available to give you personal telephone service should you need it.

Country/Region	Telephone
Algeria	213 (0)61 56 45 43
Argentina	
Buenos Aires	54-11-4778-8380
All other cities	54-0810-555-5520
Australia	61-3-88778000
Austria	43 (0)810 00 6080
Bahrain	800 728
Belgium (Dutch)	32-(0)2-6268806
Belgium (French)	32-(0)2-6268807
Brazil	
Sao Paulo	55-11-3747-7799
All other cities	55-0800-157751
Canada	1-905-2064663

Country/Region	Telephone
Algeria	213 (0)61 56 45 43
Chile	56-800-360999
China	86-(0)10-65645959
Czech Republic	42 (0)2 61 30 7310
Denmark	45 39 294099
Egypt	02 532 5222
Finland	358-(0)20347288
France	0836696022 (€ 0.34/min)
Germany	49-(0)1-805258143
Greece	30 10 6073603
Hong Kong	852-300-28555
Hungary	36 (0)1 382 1111
India	91-11-6826035
Indonesia	62-21-3503408
Ireland	353-(0)1-6625525
Israel	972 (0)9 9524848
Italy	39 02 26410350
Japan	81-0570-000511
Korea	
Seoul	82-(0)2-32700700
All other cities	82-080-9990700
Malaysia	60-(0)3-2952566

Country/Region	Telephone
Algeria	213 (0)61 56 45 43
Mexico	
Mexico City	52-58-9922
All other cities	01-800-4726684
Morocco	212 22404747
Netherlands	31-(0)20-6068751
New Zealand	64-(0)9-3566640
Norway	47-22-116299
Philippines	66-2-8673551
Poland	48 22 8659800
Portugal	351 21 3176333
Romania	
Inside	01 315 44 42
Outside	40 1 315 44 42
Russian Federation	
Moscow	7 095 797 3520
St. Petersburg	7 812 346 7997
Saudi Arabia	800 897 14440
Singapore	65-62725300
Slovakia	421 2 68208080
South Africa	
Inside	086 000 1030
Outside	27 11 258 9301
Spain	34 902 321 123
Sweden	46-(0)8-6192170

Country/Region	Telephone
Algeria	213 (0)61 56 45 43
Switzerland	41-(0)-848-801111
Taiwan	886-2-27170055
Thailand	66-2-3539000
Tunisia	216 1 891 222
Turkey	216 1 891 222
UK	44-870-608-3003
Ukraine	7 (380 44) 490 3520
United Arab Emirates	971 4 883 8454
USA	208-323-2551
Venezuela	
Caracas	2-207-8488
All other cities	58-800-10111
Vietnam	84-88234530

Please visit www.hp.com/cposupport/loc/regional.html for updated telephone numbers and to access the hp customer care website in your local language. All Customer Care Centers are available during office hours. Pre-sales Information in the USA is available 24 hours per day, 7 days per week. Support & Service in the USA can be contacted from 5 am to 5 pm Pacific Time, Monday through Friday.

The information in this document and applicable conditions for hp phone support are subject to change without notice. Please check for the latest information and conditions on the Website indicated in this document.

warranty

Important: This is your hardware product warranty statement. Read it carefully.

Warranty terms may be different in your country. If so, your authorized hp dealer or Hewlett-Packard sales and service office can give you details.

one year limited hardware warranty

Hewlett-Packard (hp) warrants this hardware product against defects in material and workmanship for a period of one year from receipt by the original end-user purchaser.

If hp receives notice of the above-defined defects during the warranty period, hp will either, at its option, repair or replace products that prove to be defective.

Should hp be unable to repair or replace the product within a reasonable amount of time, the customer's alternate exclusive remedy shall be a refund of the purchase price upon return of the product.

limitation of warranty

The above warranty shall not apply to defects resulting from: misuse; unauthorized modification; opening for any reason; operation or storage outside the environmental specifications for the product; in-transit damage; improper maintenance; or defect resulting from use of non-hp software, accessories, media, supplies, consumables, or such items not designed for use with the product.

hp makes no other express warranty, whether written or oral, with respect to this product.

Any implied warranty of merchantability or fitness for a particular purpose is limited to the one-year duration of this written warranty.

Some states, provinces, or countries do not allow limitations on how long an implied warranty lasts, so the above limitation or exclusion may not apply to you.

This warranty gives you specific legal rights, and you may also have other rights that vary from state to state, province to province, or country to country.

no warranty of data or backup files

hp makes no warranty, express or implied, and no claim of responsibility or liability for end user data integrity or the integrity of backup files. It is the full responsibility of the end user to ensure data integrity, backup file integrity, and correct and successful backup procedures. hp makes no warranties or claims, express or implied relating to restoring or recovering end-user data.

limitation of liability and remedies

The remedies provided above are the customer's sole and exclusive remedies.

In no event shall hp be liable for any direct, indirect, special, incidental, or consequential damages (including lost profit), whether based on warranty, contract, tort, or any other legal theory.

Some states, provinces, or countries do not allow the exclusion or limitation of incidental or consequential damages—including lost profit—so the above limitation or exclusion may not apply to you.

consumer transactions in australia, new zealand, and the united kingdom

The preceding disclaimers and limitations shall not apply to consumer transactions in Australia, New Zealand and the United Kingdom, and shall not affect the statutory rights of consumers.

for consumers in australia

The above warranty terms and any other warranty statement enclosed with this product, except to the extent lawfully permitted, do not exclude, restrict, or modify and are in addition to the statutory rights implied by the Trade Practices Act 1974 or any corresponding State or territory legislation applicable to the sale of this product to you. If you have any queries about your rights, contact the Hewlett-Packard Customer Care Center at 61-3-88778000.

for consumers in new zealand

The above warranty terms or any other warranty statement enclosed with this product, except to the extent lawfully permitted, do not exclude, restrict or modify and are in addition to the statutory rights implied by the Consumer Guarantees Act 1993 applicable to the sale of this product to you. If you have any queries about your rights contact the Hewlett-Packard End User Support line at 0800-733547.

hp software product license agreement and hp software product limited warranty

This hp product contains preinstalled software programs. Please read the hp Software Product License Agreement before proceeding.

Important: Carefully read this License Agreement and the Limited Warranty statement before operating the equipment. The rights to the software are licensed, not sold. hp or its licensors continue to own all intellectual property rights to the software, and you will be granted certain rights to use the software upon your acceptance of this license. Rights in the software are offered only on the condition that you agree to all terms and conditions of the License Agreement. Operating the equipment indicates your acceptance of these terms and conditions. If you do not agree to the terms and conditions of the License Agreement, return the complete package for a full refund now.

hp software product license agreement

The hp Software Product License Agreement shall govern the use of all software that is provided to you, the customer, as part of this hp product with the exception of Microsoft Software. Microsoft Products are licensed to you under the Microsoft End User License Agreement (EULA) contained in the Microsoft documentation. Any third-party software supplier's warranty terms that may be found online, or in any documentation or other materials contained in the product packaging, shall govern the use of that third-party software.

The following License Terms govern the use of the software:

use

You may only use the software on a single computer. You may not reverse engineer, disassemble, or decompile the software.

Transaction in European Union member states: The prohibition against decompilation shall be subject to Directive 91/250/EEC.

copies and adaptations

You may make copies or adaptations of the software (a) for archival purposes, or (b) when copying or adaptation is an essential step in the use of the software with a computer so long as the copies and adaptations are used in no other manner.

You have no other rights to copy unless you acquire an appropriate license to reproduce which is available from hp for some software.

You agree that no warranty, free installation, or free training is provided by hp for any copies or adaptations made by you.

All copies and adaptations of the software must bear the copyright notice(s) contained in or on the original.

ownership

You agree that you do not have any title to or ownership of the software, other than ownership of the physical media. You acknowledge and agree that the software is copyrighted and protected under the copyright laws. You acknowledge and agree that the software or part thereof may have been developed by a third-party software supplier named in the copyright

notice(s) included with the software, who shall be authorized to hold you responsible for any copyright infringement or violation of this or their own License Agreement.

transfer of rights in software

You may transfer rights to the software to a third party only as part of the transfer of all your rights and only if you obtain the prior agreement of the third party to be bound by the terms of this License Agreement. Upon such a transfer, you agree that your rights to the software are terminated and that you will either destroy all your copies and adaptations or deliver them to the third party. Transfer to a U.S. government department or agency or to a prime or lower tier contractor in connection with a U.S. government contract shall be made only upon prior written agreement to terms required by hp.

sublicensing and distribution

You may not lease, sublicense the software, or distribute copies or adaptations of the software to the public in physical media, by telecommunication or at all without the prior written consent of hp.

termination

hp may terminate this software license for failure to comply with any of these terms, provided hp has requested you to cure the failure and you have failed to do so within thirty (30) days of such notice.

updates and upgrades

You agree that the software does not include updates and upgrades that may be available from hp under a separate support agreement.

export clause

You agree not to export or re-export the software or any copy or adaptation in violation of the U.S. Export Administration regulations or other applicable regulations.

U.S. government restricted rights

The Software and Documentation have been developed entirely at private expense. They are delivered and licensed as "commercial computer software" as defined in DFARS 252.227-7013 (Oct 1988), DFARS 252.211-7015 (May 1991) or DFARS 252.227-7014 (Jun 1995), as "commercial item" as defined in FAR 2.101 (a), or as "Restricted computer software" as defined in FAR 52.227-19 (Jun 1987) (or any equivalent agency regulation or contract clause), whichever is applicable. You have only those rights provided for such Software and Documentation by the applicable FAR or DFARS clause or the hp standard software agreement for the product involved.

hp software product limited warranty

Important: This hp Software Product Limited Warranty shall cover all software that is provided to you, the customer, as part of the hp product, including any operating system software. Any third-party software supplier's warranty terms that may be found on-line, or in any documentation or other materials contained in the product packaging shall supersede the hp Software Product Limited Warranty with regard to that third-party software.

ninety-day limited software warranty

hp warrants for a period of NINETY (90) DAYS from the date of purchase that the software product will execute its programming instructions when all files are properly installed. hp does not warrant that the software will be uninterrupted or error free. In the event that this software product fails to execute its programming instructions during the warranty period, your remedy shall be replacement or refund only. Return the media to hp for replacement. Should hp be unable to replace the media within a reasonable amount of time, hp shall refund the purchase price upon return of the product and all copies.

removable media (if supplied)

hp warrants the removable media, if supplied, upon which this product is recorded to be free from defects in material and workmanship under normal use for a period of NINETY (90) DAYS from the date of purchase.

In the event the media proves to be defective during the warranty period, your remedy shall be replacement or refund only. Return the media to hp for replacement. Should hp be unable to replace the media within a reasonable amount of time, hp shall refund the purchase price upon return of the product and destruction of all other non-removable media copies of the software product.

notice of warranty claims

You must notify hp in writing of any warranty claim not later than thirty (30) days after the expiration of the warranty period.

limitation of warranty

hp makes no other express warranty, whether written or oral, with respect to this product.

Any implied warranty of merchantability or fitness for a particular purpose is limited to the 90-day duration of this written warranty. Some states, provinces, or countries do not allow limitations on how long an implied warranty lasts, so the above limitation or exclusion may not apply to you. This warranty gives specific legal rights, and you may also have other rights that vary from state to state, province to province, or country to country.

limitation of liability and remedies

THE REMEDIES PROVIDED ABOVE ARE YOUR SOLE AND EXCLUSIVE REMEDIES. IN NO EVENT SHALL hp BE LIABLE FOR ANY DIRECT, INDIRECT, SPECIAL, INCIDENTAL, OR CONSEQUENTIAL DAMAGES (INCLUDING LOST PROFIT), WHETHER BASED ON WARRANTY, CONTRACT, TORT, OR ANY OTHER LEGAL THEORY. Some states, provinces, or countries do not allow the exclusion or limitation of incidental or consequential damages—including lost profit—so the above limitation or exclusion may not apply to you.

In no case shall hp's liability exceed the purchase price for the software and/or product. The limitations set forth above will apply regardless of whether you accept the software.

Consumer transactions in Australia and the United Kingdom: The disclaimers and limitations above shall not apply and shall not affect the statutory rights of a Consumer.

glossary

AC adapter. An external power supply that converts ac power from a standard household electrical outlet to the low-voltage dc power required to operate your hp Jornada.

Backup. A duplicate copy of your hp Jornada files and data that is stored on your desktop PC or on a CompactFlash card.

Cell broadcast. A wireless data services that transmits text-based information, such as news, stock updates, and weather reports to phones on a GSM network.

CompactFlash. A removable media for high-performance memory cards and other accessories such as modems and NICs.

Cradle. A desktop base for your hp Jornada that allows instant connectivity to a desktop PC. The cradle remains connected to your desktop PC, even when you remove your hp Jornada.

DHCP (Dynamic Host Configuration Protocol). A protocol that assigns a dynamic IP address to your hp Jornada each time you connect to a network.

Dial-up connection. A connection between your hp Jornada and another computer by modem. You can have a dial-up connection with an ISP, a network, or with a modem attached to a PC.

Direct connection. A connection between your hp Jornada and another computer by means of the cradle or infrared port.

DNS (Domain Name System). An Internet service that translates domain names into IP addresses. For example, the domain name `www.jornada.com` might translate as `198.125.247.4`.

Driver. A control program that enables a computer to work with a specific peripheral device.

Flash ROM. See ROM.

GPRS (General Packet Radio Service). A packet-based wireless data service that enables mobile phones, computers, and PDAs to connect to the Internet.

GSM (Global System for Mobile communication). A digital mobile telephone system that is widely used in Europe and other parts of the world.

IMAP4 (Internet Messaging Access Protocol v4). A protocol that enables a computer to retrieve messages from a mail server.

Infrared port. A communication port that uses optical (infrared) signals rather than wires or cables to transmit data.

Internet. A worldwide network of computers offering services such as e-mail, the Worldwide Web, FTP, Usenet news, and others.

Intranet. A network that offers services similar to the Internet, but usually accessible only to users within a single company or organization.

IP (Internet Protocol). The standard by which packets of information are transmitted over the Internet.

IrDA (Infrared Data Association protocol). An established standard for infrared communications between computers and other peripherals and devices.

ISP (Internet service provider). A commercial business that provides Internet access to individuals or businesses, usually for a fee.

Java™. A high-level programming language used to create small applications that can be downloaded over the Web.

LAN (local area network). A group of computers, usually in close proximity (either in the same building or in buildings in close proximity), that are linked together to share files and exchange data.

MIDlet. A Java™ application that conforms to the MIDP standard.

MIDP (Mobile Information Device Profile). A set of Java programming interfaces that define how applications work with phones and other mobile devices.

Modem. A communication device that enables a computer to transmit data over telephone lines.

NIC (network interface card). A card installed in a computer so that it can be connected to a network. NICs can provide a dedicated, full-time connection to a network.

Partnership. An established relationship between your hp Jornada and your desktop PC for the purpose of synchronizing and transferring data.

PDA (personal digital assistant). A handheld device that combines computer, telephone, personal information manager, and networking features.

PIM (personal information manager). An application or set of applications that organizes information such as addresses, appointments, and notes.

POP3 (Post Office Protocol v3). A protocol that enables a computer to retrieve messages from a mail server.

PPP (Point-to-Point Protocol). The default method your hp Jornada uses to communicate with an ISP or network server.

Proxy server. A server that sits between a client computer or Web browser and the Internet. A proxy server provides security by filtering requests and can improve performance by storing local copies of requested information.

RAM (random access memory). Volatile memory that can be read and written. Data stored in RAM is retained only while power is maintained.

Remote connection. A connection between your hp Jornada and a remote computer or server.

Reset. The process of restarting your hp Jornada and reinitializing the operating system. Performing a reset erases any unsaved data in open documents, but preserves data that has been saved.

Restore. To return your device to the state it was in when data was last backed up. This involves copying your backup data to your hp Jornada.

ROM (read-only memory). Nonvolatile flash memory that contains the Microsoft Windows for Pocket PC operating system and preinstalled programs.

Serial connection. A cable connection between your hp Jornada and a serial (COM) port on your desktop PC.

SIM (subscriber information module) card. A card supplied by a GSM/GPRS service provider that contains a mobile phone number, information about account services, and other information that identifies a mobile device to the mobile phone network.

SLIP (Serial Line Internet Protocol). A method of connecting to the Internet. Similar to PPP, but older and simpler.

SMS (Short Message Service). A service for sending short text messages to mobile phones.

SMTP (Simplified Mail Transport Protocol). A protocol for sending e-mail messages between computers on the Internet.

Stylus. A pen-like utensil designed for navigating on a touch screen.

Synchronization. The process of comparing the files or data on two computers to ensure that they contain exactly the same information.

Touch screen. A touch-sensitive screen that allows you to open files, launch programs, and select text by touching or tapping the screen with the stylus.

USB (Universal Serial Bus). A newer standard for connecting peripheral devices. USB supports relatively fast data transfer rates and can be used to connect multiple devices to a single computer.

Virtual machine. A self-contained computer environment that allows Java applications to run without interacting with the Pocket PC operating system.

VPN (virtual private network). A network that is constructed by using the Internet to connect nodes. VPNs typically include security to ensure that only authorized users can access the network.

WAP (Wireless Application Protocol). A secure specification that allows handheld wireless devices to access information over the Internet.

WDA (wireless digital assistant). A personal digital assistant (PDA) that includes wireless voice and/or data functions.

WML (Wireless Markup Language). A markup language used to specify content and user interface for WAP devices.

appendix: phone safety

driving

Do not use your hp Jornada wireless digital assistant while driving a vehicle. If you must use your hp Jornada, park the vehicle first.

Always secure your hp Jornada while driving; do not place your hp Jornada on the passenger seat or where it can break loose in a collision or sudden stop.

For vehicles equipped with an airbag, remember that an airbag inflates with great force. Do not place your hp Jornada in the area over the airbag or in the airbag deployment area.

Check the laws and regulations on the use of phones in the areas where you drive. If you are going to use your phone while driving,

- give full attention to driving.
- use a phone headset. Laws in many countries requires the use of a hands-free solution when driving a vehicle.
- pull off the road and park before making or answering a call if driving conditions so require.

Radio frequency (RF) energy emitted by your hp Jornada may affect electronic systems in your vehicle. For more information, see the following section.

radio interference with electronic devices

Your hp Jornada is a radio transmitter and receiver. When the phone is turned on, it receives and transmits RF energy. The system that handles your call when you are using your phone controls the power level at which your phone transmits. Most modern electronic equipment is shielded from

RF signals; however, some electronic equipment may not be shielded against the RF signals from your hp Jornada.

pacemakers

Pacemaker manufacturers recommend that a minimum separation of 20 cm (6 inches) be maintained between a handheld wireless phone and a pacemaker to avoid potential interference with the pacemaker. These recommendations are consistent with the independent research by and recommendations of Wireless Technology Research. Persons with pacemakers

- should always keep the hp Jornada more than 20 cm (6 inches) from their pacemaker when the phone is on
- should not carry the hp Jornada in a breast pocket;
- should use the ear opposite the pacemaker to minimize the potential for interference.

If you have any reason to suspect that interference is taking place, switch off the phone functions of your hp Jornada immediately.

hearing aids

Some digital wireless phones may interfere with some hearing aids. If you experience such interference, you may want to consult your service provider.

other medical devices

Operation of any radio transmitting equipment, including your hp Jornada, may interfere with the functionality of inadequately protected medical devices. If you use any other personal medical device, consult a physician or the manufacturer of a medical device to determine if it is adequately shielded from external RF energy or if you have any questions.

Turn off the phone functions of your hp Jornada in healthcare facilities when any regulations posted in these areas instruct you to do so. Hospitals or healthcare facilities may be using equipment that could be sensitive to external RF energy.

vehicles

RF signals may affect improperly installed or inadequately shielded electronic systems in motor vehicles (for example, electronic fuel injection systems, electronic anti-skid/anti-lock braking systems, electronic speed control systems, airbag systems, and stereos). Check with your vehicle manufacturer's representative to be sure that your hp Jornada will not affect the electronic systems in your vehicle. You should also consult the manufacturer of any equipment that has been added to your vehicle.

operating environment

Remember to follow any special regulations in force in any area. Always turn off the phone functions of your hp Jornada when it is forbidden to use it, or when it may cause interference or danger.

potentially explosive atmospheres

Turn off the phone functions of your hp Jornada when you are in an area with a potentially explosive atmosphere. Obey all signs and instructions. Sparks in such areas could cause an explosion or fire resulting in bodily injury or even death.

Switch off the phone when at a refueling point (service station). Observe restrictions on the use of radio equipment in fuel depots (fuel storage and distribution areas), chemical plants or where blasting operations are in progress.

Areas with a potentially explosive atmosphere are often—but not always—clearly marked. They include below deck on boats; chemical transfer or storage facilities; vehicles using liquefied petroleum gas (such as propane or butane); areas where the air contains chemicals or particles, such as grain, dust, or metal powders; and any other area where you would normally be advised to turn off your vehicle engine.

vehicles

Do not store or carry flammable liquids, gases, or explosive materials in the same compartment as your hp Jornada, its parts or accessories.

aircraft

Use of wireless telephones in an aircraft may be hazardous to safe aircraft operation, disrupt the wireless telephone network, and may be illegal. Please follow the instructions of your flight crew regarding the use of your hp Jornada on board aircraft.

blasting areas

To avoid interfering with blasting operations, turn off the phone functions of your hp Jornada when you are in a blasting area or any area posted "Turn off two-way radio."

emergency calls

Like any wireless phone, your hp Jornada wireless digital assistant operates using radio signals, wireless, and landline networks as well as user-programmed functions, which cannot guarantee connection in all conditions. Therefore, you should never rely solely upon a wireless phone for essential communications (e.g., medical emergencies).

Remember: to make or receive any calls the phone must be switched on and in a service area with adequate signal strength. Emergency calls may not be possible on all wireless phone networks or when certain network services and/or phone functions are in use. Check with local service providers.

If certain features are in use (call barring, fixed dialing, closed user group, system lock, keypad lock, etc.), you may first need to turn those features off before you can make an emergency call. Consult this document and your GSM/GPRS service provider.

When making an emergency call, remember to give all the necessary information as accurately as possible. Remember that your hp Jornada may be the only means of communication at the scene of an accident. Do not end the call until given permission to do so.

index

A

- ac adapter, 2, 19, 21–22, 27, 32, 58, 195
- accessories, 16, 128
 - Accessories Guide, 2
 - CompactFlash, 27, 116, 128, 170
 - hp Pocket Camera, 160, 161
 - pocket keyboard, 6
 - serial cable or cradle, 57
- action button, 14
- ActiveSync, 2–4, 7, 52–57, 73, 75, 76, 81, 118, 127, 132, 135, 153, 167, 174–177
- adding programs. *See* programs
- alarm, 100, 122, 123
- alert profiles, 6, 11, 13, 40, 120, 122
- alerts, 27, 100, 134, 170
 - incoming call, 40
 - LED. *See* LED
- aligning touch screen, 6, 13, 19, 92, 173
- answering a call, 11, 40
- antenna, 35
- appointments
 - adding notes to, 134
 - alarm for, 100
 - changing, 134
 - creating, 133
 - reminders, 134
 - Summary Screen, 134
- audio files
 - formats, 150
 - playing, 150, 170
 - ripping, 151
 - secured content (UUID), 152
- auto cover, 2, 11, 34
 - removing, 14
 - settings, 15, 23, 25, 34
- AvantGo, 73

B

- backing up data
 - about hp backup, 5
 - to CompactFlash card, 118
 - to desktop PC, 56
 - using ActiveSync, 56, 118, 169
 - using hp backup, 56, 117, 118, 169
- backup file, 56, 118, 173, 195
- batteries
 - about, 20
 - charging, 20, 21, 22, 57, 128, 170, 171
 - embedded, 2, 20
 - expected life, 20
 - removable, 1, 2, 10, 18, 20, 179
 - status, 22, 24
 - warnings, 21
- Block Recognizer, 101, 102
- books online. *See* Reader
- browser
 - WAP. *See* EzWAP
 - Web. *See* Pocket Internet Explorer
- browsing
 - the Web, 69
 - WAP sites, 88
- buttons. *See* hardware buttons

C

- calculator. *See* Calendar
 - about, 7, 132, 136
 - adding notes to, 134
 - alarm for, 100
 - backing up, 5, 118
 - creating an appointment, 133
 - customizing display of, 133
 - hot key, 13, 120

- meeting requests, 135
 - Summary Screen, 134
 - synchronizing, 53
 - call barring, 46
 - call forwarding, 45
 - call log, 44
 - call waiting, 45
 - caller ID, 45
 - calls
 - answering, 11, 40
 - deferred answering, 40
 - ending, 11, 36
 - making, 34, 35, 36
 - cell broadcast, 7, 60, 61
 - Character Recognizer, 147
 - chat. *See* MSN Messenger
 - closing programs. *See* programs
 - CodeWallet Pro, 8, 131, 166
 - Command bar, 97
 - CompactFlash card
 - about, 117, 128, 195
 - for backup, 5, 56, 118, 119, 169
 - installing, 129
 - memory, 116–118, 169, 174
 - power usage, 27, 170
 - slot, 129
 - storing audio files, 152
 - connecting
 - by infrared, 59
 - by LAN, 54
 - by USB cradle, 57
 - to a network, 63, 175
 - to desktop PC, 57, 59
 - to Internet, 63
 - contacting hp, 182
 - Contacts
 - about, 7, 132, 139
 - adding notes to, 141
 - backing up, 5, 118
 - categorizing, 140
 - copying from SIM card, 30, 43
 - creating, 140
 - customizing display of, 139
 - dialing a call, 43
 - finding, 141
 - hot key, 13, 122
 - Summary Screen, 141
 - synchronizing, 53
 - viewing, 141
 - converting files, 55
 - cover, 192. *See* auto cover
 - cradle. *See* USB cradle
 - customer service. *See* technical support
- ## D
- dc jack, 58
 - deferred answer, 40
 - DHCP protocol, 195
 - dial-up connection, 195
 - direct connection, 195
 - display
 - backlight, 6, 14, 26, 121, 172, 178
 - brightness, 6, 178
 - cleaning, 16
 - radiated interference, 16
 - touch screen, 6, 13, 92, 173
 - troubleshooting, 172, 177
 - turning off, 13, 26, 150
 - turning on, 14, 26
 - display profiles, 5, 13, 120
 - DNS, 195
 - drawings
 - adding to book text, 156
 - creating, 108
 - resizing, 109
 - selecting, 109
 - zooming, 109
 - drivers. *See* software drivers
- ## E
- eBooks. *See* Reader
 - e-mail
 - adding recordings to, 110
 - configuring services, 75
 - folder behavior, 81, 82

- reading messages, 78
- receiving attachments, 78
- sending, 74
- synchronizing, 53, 74
- embedded battery. *See* batteries, embedded
- EMusic.com, 151
- End button, 11, 23, 31
- Exchange, 55, 132, 157
- EzWAP, 8, 88

F

- factory default settings, 169
- File Explorer, 114, 126, 128, 174
- files
 - converting, 55
 - transferring, 55
- Find feature, 114
- Flash ROM, 5, 197
- Fonix Voice Dial, 8, 12, 37

G

- GPRS, 6, 30, 40, 60, 63, 66
 - configuring, 66
 - connecting to network, 68
- GSM, 4, 30, 47, 60, 63, 83, 126, 197
 - audio file format, 112
 - closing a connection, 65
 - data connection, 63, 64, 75
 - dialing a connection, 65
 - service provider, 17, 23, 30, 42, 45, 60, 83

H

- hardware buttons
 - about, 10
 - configuring, 123
- headset, 34, 199
- hp backup. *See* backing up data
- hp Dialer, 42

- hp home menu, 5, 94, 124, 125
- hp home menu hot key, 13, 94
- hp hot keys, 12, 13, 23, 25, 123
- hp image viewer
 - about, 5, 131
 - adding comments to images, 165
 - adding images to a document, 165
 - adding recordings to an image, 162
 - Browse mode, 161, 162
 - changing folders, 160
 - file formats, 160
 - sending images, 164, 165
 - Slideshow mode, 163
 - starting, 160
 - View mode, 163
- hp Jornada
 - caring for, 16
 - hardware features, 9
 - package contents, 2
 - registering, 16
 - turning off, 22
 - turning on, 22
 - warranty, 187
- hp Jornada user's guide online version, 4
- hp MicroChaiVM, 6, 51, 83
- hp month view, 5, 136
- hp Pocket Camera, 6, 160, 161
- hp pocket keyboard, 6
- hp profiles, 27, 120, 122, 178
 - power preferences, 25
- hp quick menu, 6, 13, 34, 150
- hp settings, 120, 172
- hp task switcher, 6, 13, 94, 95, 116, 117, 118, 119, 168, 171

I,J,K

- images. *See* hp image viewer
- IMAP4 protocol, 64, 75, 82, 196
- Inbox, 118
 - about, 7
 - My Text, 113

- synchronizing, 53
- Inbox hot key, 13
- infrared port, 27, 52, 54, 55, 57, 59, 139, 164, 165, 175, 196
- Input panel, 101, 147
- installing programs. *See* programs
- instant messages. *See* MSN Messenger
- interference, radiated, 16
- Internet, 196
 - Pocket Internet Explorer, 69
 - Web browsing, 69
- intranet, 69, 196
- IP protocol, 196
- IrDA protocol, 59, 196
- ISP, 196

L

- LAN, 57, 196
- LED, 11, 27
 - blinking blue, 11, 100
 - steady amber, 11, 22, 110
 - steady blue, 11, 22
- Letter Recognizer, 101, 103
- light sensor, 121
- locking your hp Jornada, 48

M

- mail. *See* e-mail
- Media Player. *See* Windows Media Player
- meeting requests, 135
- memory
 - managing, 116
 - program, 115, 116
 - storage, 111, 112, 115, 116
- microphone
 - headset, 2
- Microsoft Exchange. *See* Exchange
- Microsoft MSN Messenger. *See* MSN Messenger
- Microsoft Outlook. *See* Outlook
- Microsoft Passport. *See* Passport

- Microsoft Phone application, 35
- Microsoft Pocket Excel. *See* Pocket Excel
- Microsoft Pocket Internet Explorer. *See* Pocket Internet Explorer
- Microsoft Pocket Outlook. *See* Pocket Outlook, Calendar, Contacts, Notes, Tasks, Inbox
- Microsoft Pocket Word. *See* Pocket Word
- Microsoft Reader. *See* Reader
- MIDlet, 83
 - deleting, 87
 - exiting, 87
 - installing, 84
 - launching, 86
- mobile favorites, 72
 - viewing, 53
- modem, 196
- MP3 files, 8, 150, 152
- MSN Messenger
 - about, 7, 157
 - blocking contacts, 159
 - chatting, 159
 - contacts, 158
 - My Text, 113
 - setup, 157
 - starting, 157
- MusicMatch JukeBox, 151
- My Text, 113

N,O

- Navigation bar, 97
- navigation pad, 14
- network. *See* LAN
- network interface card, 175, 196
- Notes
 - about, 7, 132, 146
 - adding to books, 156
 - creating, 146
 - drawing, 108
 - inputting text, 101
 - recording, 110

- writing on-screen, 104
- zooming, 178

notification icon, 99

notifications. *See* alerts

online chat. *See* MSN Messenger

online Help, 2, 3, 4, 131, 166

Outlook, 2, 53, 55, 81, 132, 135

owner information, 123

P

partnership, 52, 54, 56, 169, 173, 196

Passport, 157

password, 48, 64, 123, 149, 169, 176

- phone, 23, 32

PCM file format, 111

personal identification number

- for phone SIM, 23, 32

phone

- answering a call, 11, 40
- antenna, 35
- call barring, 46
- call forwarding, 45
- call log, 44
- call waiting, 45
- caller ID, 45
- deferred answering, 40
- display, 49
- ending a call, 11, 36
- handheld mode, 34
- hands-free mode, 34, 199
- hp Dialer, 42
- making a call, 34, 35, 36
- ring options, 46
- settings, 46
- speakerphone mode, 34
- speed dial, 36, 44
- turning off, 11, 23, 31
- turning on, 11, 23, 31
- voice dial, 37
- voice mail, 40

Phone Display, 49

phone safety, 34, 199

pictures. *See* hp image viewer

PIM (personal information manager), 5, 54, 55, 56, 118, 119, 173, 197

Pocket Excel

- about, 7, 131, 149
- customizing display of, 150
- file formats, 149
- opening spreadsheets, 149
- passwords, 149
- starting, 149
- synchronizing, 149
- templates, 149
- zooming, 149, 178

Pocket Internet Explorer, 7, 69, 127, 178

Pocket Outlook, 1, 53, 132, 135

Pocket Outlook Inbox, 13

Pocket PC Companion CD, 2, 3, 52, 126, 153, 166

Pocket Word

- about, 7, 131, 147
- drawing mode, 148
- file formats, 147
- opening documents, 147
- recording mode, 148
- starting, 147
- synchronizing, 147
- templates, 147
- typing mode, 147
- writing mode, 148
- zooming, 148, 178

POP3 protocol, 64, 75, 82, 197

pop-up menus, 99

power

- about, 20
- ac adapter, 22, 27, 32
- checking remaining, 24
- conserving, 25, 26, 150
- loss of, 5, 20, 118
- low power indicator, 95
- Power control panel, 23, 25

- turning PDA on or off, 14, 22, 23, 27
- power button, 14, 22, 23, 26, 27, 172, 177, 178
- Power preferences, 25
- PPP protocol, 174, 197
- profiles
 - alert, 6, 11, 13, 40, 120, 122
 - display, 5, 13, 120
 - Loud, 122
 - Low Power, 178
 - Meeting, 122
 - Outdoor, 178
- program memory, 115, 116
- programs
 - adding to Start menu, 125
 - additional, 8
 - closing, 116, 117
 - from hp, 5
 - from Microsoft, 7
 - from third parties, 8, 131
 - help for, 4
 - installing, 3, 8, 84, 126, 127, 173
 - Java, 83
 - MIDlets, 83
 - preinstalled, 5
 - removing, 5, 116, 127
 - switching, 94, 95, 97
- proxy server, 197

R

- radiated interference, 16
- RAM, 197
- Reader
 - about, 153
 - adding drawings to text, 156
 - adding notes to text, 156
 - annotations, 156
 - bookmarks, 156
 - copying text, 156
 - getting books for, 153
 - Guidebook, 153
 - highlighting text, 156

- Library, 154
 - removing a book, 156
 - searching for text, 156
 - secured content (UUID), 153
 - starting, 153
- record button, 12, 25, 123
- recording
 - about, 110
 - adding to a note, 110
 - adding to an e-mail message, 110
 - adding to images, 162
 - creating, 110
 - file formats, 111, 112
 - in Pocket Word, 148
 - playing back, 110
 - starting, 12
 - status indicator, 110
 - stopping, 12
- removable battery. *See* batteries, removable. *See* batteries:removable
- removing programs. *See* programs
- reset button, 168
- resetting, 168, 171, 172, 178, 197
- restoring data, 52, 56, 118, 119, 120, 168, 169, 173, 174, 197
- restoring factory defaults, 118, 169, 174

S

- safety information, 34, 199
- screen protector, 16
- security, 48
- Send button, 11
- serial connector, 55
- short message service, 46, 51, 61, 74, 79
 - delivery notification, 80
 - locking device remotely, 48
- SIM card, 1, 23, 30, 31, 47, 179, 197
 - copying contacts from, 30, 43
 - installing, 17
 - locking or unlocking, 23, 32

- PIN, 47
 - status, 32
- SLIP protocol, 197
- SMS. *See* short message service
- SMTP protocol, 198
- soft keyboard, 101, 103, 147
- software drivers
 - about, 195
 - infrared, 59
 - NIC, 175
 - portable keyboard, 6
- Software License Agreement, 190
- sounds
 - alert profile, 120
 - alert profiles, 122
 - choosing, 100
 - turning off, 27
- speakerphone, 34
- speed dial, 11, 35, 36, 42, 43, 44, 120
- Start menu, 95, 125
- status icons, 99
 - batteries, 21
 - phone, 32, 33
- stereo headset, 2
- storage memory, 73, 111, 112, 115, 116, 127, 152
- streaming media, 152
- suspend, 27
- switching programs. *See* programs
- synchronizing
 - about, 7, 52, 53, 132, 198
 - e-mail messages, 53, 74
 - Excel files, 52, 149
 - from a remote location, 54, 55
 - help for, 3
 - mobile favorites, 53
 - Outlook, 53
 - schedule, 53
 - starting, 53
 - troubleshooting, 176
 - Word files, 52, 147

T

- Tasks
 - about, 7, 132
 - adding notes to, 144
 - alarm for, 100
 - backing up, 5, 118
 - categorizing, 144
 - changing, 145
 - creating, 144
 - customizing display of, 143
 - due date, 144
 - start date, 144
 - Summary Screen, 145
 - synchronizing, 53
- technical support, 181
- temperature, operating, 16
- templates
 - Pocket Excel, 149
 - Pocket Word, 147
- Today screen, 4, 25, 93, 99, 123
- to-do list. *See* Tasks
- touch screen
 - aligning, 6, 13, 19, 92, 173
- touch screen. *See also* display, 198
- Transcriber, 101, 103
- transferring files, 55
- troubleshooting, 167
 - basic problems, 170
 - connections, 4
 - display, 177
 - infrared, 175
 - network connections, 175
 - remote connections, 174
 - USB cradle, 176

U,V,W

- USB, 56–58, 177, 198
- USB cradle, 2, 21, 52, 54–58, 195
- videos, 150
- viewing images
 - at actual size, 163
 - in a slideshow, 163

- in hp image viewer, 160
- voice dialing. *See* Fonix Voice Dial
- voice mail, 40, 46
- voice notes. *See* recording
- volume/scroll control, 12
- warranty
 - software, 189
- WAV files, 148

- Welcome Wizard, 19, 169
- Windows Media Player, 8, 40, 131, 150
- wireless data. *See* GSM or GPRS
- WMA files, 8
- WMV files, 8
- writing on the screen, 104
- WWW. *See* Web