

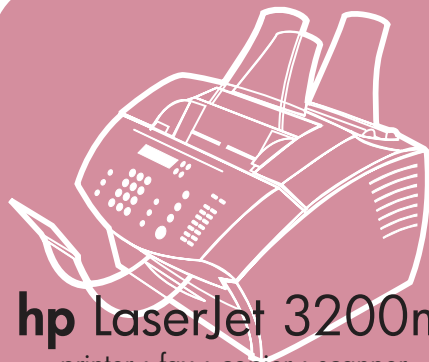

i n v e n t



hp LaserJet 3200m
printer • fax • copier • scanner

**getting
started
guide**

**LaserJet
all-in-one**



Installation checklist

Tear out this checklist now to use as you proceed through this guide. For each major step in the installation process, you can check your work by answering the questions on the checklist. See “Using the installation checklist” on page 7 for more information.

1 What type of phone line did you decide to use (page 8)?

- Dedicated line** for fax calls.
- Shared line** for fax calls and voice calls.

Continue to “Computer and network requirements” on page 9.

2 What type of installation did you choose (page 9)?

- Standalone.** Continue to “Checking the contents of the box” on page 12.
- Direct.** Continue to “If you chose network connection or direct connection:” on page 10.
- Network.** Continue to “If you chose network connection or direct connection:” on page 10.

3 Does your computer or network meet the requirements (page 11)?

- Yes.** Continue to “Checking the contents of the box” on page 12.
- No.** You should decide whether you want to upgrade your computer, network, or HP JetDirect print server, to use a different computer, or to change the type of installation you want. When you are ready, continue to “Checking the contents of the box” on page 12.

4 Does the box contain all of the items it should (page 13)?

- Yes.** Continue to “Recording important information” on page 13.
- No.** Do one of the following:
 - Contact the dealer for details about getting the missing item.

- Gather this information: the product serial number and model number (on the back of the product), the item missing, and the purchase date. Then, call HP Customer Care at (03) 8877 8000.

5 Were you able to install the toner, attach the supports, and load media into the paper input tray (page 20)?

- Yes.** Continue to “Connecting the product” on page 21.
- No.** Review pages 18, 19, and 20.

6 After you connect the power cord and turn the power switch to “on,” does **READY** appear on the control panel display (page 26)?

- Yes.** Continue to “Testing the hardware” on page 27.
- No.** See chapter 3, “Installation troubleshooting,” on page 53.

7 Were you able to print and copy the demonstration page (page 27)?

- Yes.** Continue to “Completing installation” on page 28.
- No.** Try again to print and copy the page, making sure you press **COPY** (not **FAX/SEND**, which would try to send the page as a fax). If you try again and still cannot print and copy the demonstration page, see “HP Customer Care” on page 58.

For direct connect installations or network installations:

8 Did the test page print (page 37 for direct, or page 41 for network)?

- **Yes.** You have finished installing the software and setting the required settings. Continue to "Completing software installation" (on page 37 for direct connect installations, or on page 41 for network installations).
- **No.** Do the following:
 - See chapter 3, "Installation troubleshooting," on page 53 to check for solutions to messages and common installation issues.
 - If the troubleshooting section does not resolve the issue, see "HP Customer Care" on page 58.

9 Did the document print (page 42)?

- **Yes.** The new equipment is working correctly with your computer.
 - If you completed a direct connect installation, and want to allow other computers on your network print to the product, see "Sharing the product (for printing only)" on page 43. (If you do not want to share the product, you have completed installation. Continue to chapter 4, "Now that installation is complete . . .," on page 57.)
 - If you completed a network installation, Continue to chapter 4, "Now that installation is complete . . .," on page 57.
- **No.** Do the following:
 - See chapter 3, "Installation troubleshooting," on page 53 to check for solutions to messages and common installation issues.
 - If the troubleshooting section does not resolve the issue, see "HP Customer Care" on page 58.

For standalone installations:

10 After you set the time and date, does the control panel read **READY**, followed by the date and time you set (page 45)?

- **Yes.** Continue to "To set the fax header" on page 46.
- **No.** Do the following:
 - If the control panel display does not read **READY**, or does not show the correct time and date, complete all of the steps under "To set the time and date" again.
 - If the control panel display contains information about an error, see chapter 3, "Installation troubleshooting," on page 53.

When the control panel reads **READY**, followed by the correct time and date, continue to "To set the fax header" on page 46.

11 Does the control panel display show the answer mode setting that you chose (page 48)?

- **Yes.** If you have ring pattern service, continue to "Enabling answer ring patterns" on page 49; if you do not have ring pattern service, continue to "To print a configuration report" on page 51.
- **No.** Try again to set the answer mode.

12 Do the settings you entered appear correctly?

- **Yes.** You have completed the required settings. Continue to chapter 4, "Now that installation is complete . . ."
- **No.** See "HP Customer Care" on page 58.

HP LaserJet 3200M Product

Getting Started Guide _____

Copyright Information

© 2000 Hewlett-Packard Company

All Rights Reserved.
Reproduction, adaptations, or translation without prior written permission is prohibited except as allowed under copyright laws.

Part number C7055-90910
First edition, October 2000
Printed in USA

Warranty

The information contained in this document is subject to change without notice.

Hewlett-Packard makes no warranty of any kind with respect to this information. HEWLETT-PACKARD SPECIFICALLY DISCLAIMS THE IMPLIED WARRANTY OF MERCHANTABILITY AND FITNESS FOR A PARTICULAR PURPOSE.

Hewlett-Packard shall not be liable for any direct, indirect, incidental, consequential, or other damage alleged in connection with the furnishing or use of this information.

NOTICE TO U.S. GOVERNMENT USERS: RESTRICTED RIGHTS COMMERCIAL COMPUTER SOFTWARE: "Use, duplication, or disclosure by the Government is subject to restrictions as set forth in subparagraph (c) (1)(ii) of the Rights in Technical Data Clause at DFARS 52.227-7013."

Trademark Credits

Microsoft, Windows, and MS-DOS are U.S. registered trademarks of Microsoft Corporation.

ENERGY STAR is a U.S. registered service mark of the U.S. EPA.

All other products mentioned herein may be trademarks of their respective companies.

This product is approved for use only in Australia.

Local country/region laws may prohibit the use of this product outside of the countries/regions specified. It is strictly forbidden by law in most countries/regions to connect nonapproved telecommunications equipment (fax machines) to public telephone networks.



Safety Information

WARNING!

Potential Shock Hazard

Always follow basic safety precautions when using this product to reduce risk of injury from fire or electric shock.

- 1 Read and understand all instructions in the user guide.
- 2 Observe all warnings and instructions marked on the product.

- 3 Use only a grounded electrical outlet when connecting the HP LaserJet 3200M product to a power source. If you don't know whether the outlet is grounded, check with a qualified electrician.
- 4 Do not touch the contacts on the end of the telephone cord or any of the sockets on the HP LaserJet 3200M product. Replace damaged cords immediately.
- 5 Never install telephone wiring during a lightning storm.
- 6 Unplug this product from wall outlets and telephone jacks before cleaning.
- 7 Do not install or use this product near water or when you are wet.
- 8 Install the product securely on a stable surface.
- 9 Install the product in a protected location where no one can step on or trip over the line cord and the line cord will not be damaged.
- 10 If the product does not operate normally, see the online user guide.
- 11 Refer all servicing questions to qualified personnel.

Information regarding FCC Class B, Parts 15 and 68 requirements can be found in the *user guide*.

Contents

1 Introduction

Setup requirements	8
Phone line requirements	8
Computer and network requirements	9
Checking the contents of the box	12
Recording important information	13
Hardware overview	14

2 Installation

Setting up hardware	18
Toner	18
Supports	19
Paper/media	20
Connecting the product	21
Connecting the phone line	21
Connecting additional devices	23
Connecting power and testing	26
Connecting power	26
Testing the hardware	27
Completing installation	28
Direct connect installation (USB cable)	29
Direct connect installation (parallel cable)	33
Network installation	38
Standalone installation (no computer)	44

3 Installation troubleshooting

4 Now that installation is complete . . .

Using the HP LaserJet 3200M product	57
HP Customer Care	58
Warranty statement	60
Declaration of Conformity	62
Limited Warranty for Toner Cartridge Life	63
FCC regulations	64
Additional regulatory statements	64

1

Introduction

Thank you for purchasing the HP LaserJet 3200M product, a powerful business tool with the capabilities of a full range of office equipment: use the product to print, fax, copy, and scan. Increase your productivity by doing more than one task at a time.

Use this guide to help you:

- check phone line and computer requirements
- check the contents of the box
- set up the product hardware
- connect the product to your phone line and to other devices, such as answering machines and computers
- verify that you have successfully installed the product

Using the installation checklist

Several times during the installation process, you will be prompted to

Check your work.

When you encounter a "check your work," see the installation checklist inside the front cover of this guide. The checklist lists all of the task checks to help you install the product, step-by-step, and, for each check, you get directions to your next step.

Setup requirements

Phone line requirements

Connect the HP LaserJet 3200M product to the phone line in one of two ways:

- a **dedicated line** for fax calls
- a **shared line** for both fax calls and voice calls

In most cases, you can choose either one. However, the product only works with **analog**, rather than digital, telephone lines (analog is common) and some phone-system features, such as call waiting and voice mail, might interfere with the correct operation of the product.

HP recommends that you get a second phone line dedicated to fax calls if your phone system has call waiting or voice mail. Contact your local phone company to add a second phone line.

CAUTION

If you live in an area that is subject to frequent electrical storms or if you experience frequent power outages, HP strongly recommends that you purchase a telephone line surge protector, available at local computer or electronics retailers. Electrical surges and power interruptions can damage the product.

Check your work #1.

Which type of phone line did you decide to use?

Computer and network requirements

The product has three installations to choose from; each has different computer and network requirements and varying available features:

- **Direct connection** to a computer
- **Network connection** with an HP JetDirect Print Server
- **Standalone**, to use the product as a fax machine and copier, not connected to a computer or network

The table below details the features available and the installations with which the features work.

Feature	Direct	Network	Standalone
Faxing to and from the product using the control panel	X	X	X
Copying using the control panel	X	X	X
Control panel access to setup options, fax and copy options, one-touch keys, and speed-dial and group-dial codes	X	X	X
Printing from the computer	X	X	
Access to PC Fax Phone Books	X	X	
Color scanning from the product to the computer	X	X	
Faxing electronic documents from the computer (PC faxing)	X	X	
Optical character recognition (OCR) software for converting scanned text to editable text	X	X	
Special copying features, such as collation for large documents	X	X	
Quick access through the software to product setup options, fax options, and setup for one-touch keys and speed-dial codes	X	X	

Note

When the computer in a direct connection installation is on a local area network, the product can be **shared** with other computers on the network. Users of shared computers can only print from their computers to the product.

Check your work #2

Which type of installation did you choose?

If you chose the standalone installation:

There are no computer or network requirements; skip the remainder of this section and continue to “Checking the contents of the box” on page 12.

If you chose network connection or direct connection:

All of the computers that will use the product software must meet the following minimum requirements:

- PC-compatible computer with the following:
 - a 486 33 MHz processor or better (or a Pentium 90 MHz processor or better for Microsoft Windows NT 4.0 or Windows 2000)
 - Windows 95, 98, 2000, Millennium Edition, or NT 4.0 operating system
 - 32 MB or more of RAM for Windows 95 or 98; 64 MB or more of RAM for Windows 2000, Millennium Edition, or NT 4.0
 - 175 MB or more of free hard-disk space
- Macintosh computer (Power PC processor), such as an iMac, Power Macintosh G3, or Power Macintosh G4, with the following:
 - Mac OS 8.6 or 9.0
 - 32 MB or more of RAM
 - 20 MB or more of hard-disk space

Note

For a direct connection to a Macintosh computer, the computer should have a USB port; parallel cable connections are not supported.

For a direct connection to a PC-compatible computer, the computer should have USB port or a dedicated IEEE-1284 bidirectional or ECP-compliant parallel port available. If the parallel port has another device attached to it, such as an external storage device, that device must be disconnected.

If you chose network connection:

In addition to having the network computers meet the requirements shown above, you must have the following:

- An installed network that uses the TCP/IP or the IPX/SPX network protocol.
- An appropriate cable for the type of network connection. The cable is used to connect the print server to a network jack, and is not included with the product. If you do not know what type of cable you need, ask the person who installed the network.
- A supported HP JetDirect Print Server (not included). Your choice of print server depends on the type of network connection you have and the number of devices you want to connect to the print server.
 - **HP JetDirect 70X (J4155A)** for a Home PNA network.
 - **HP JetDirect 170X (J3258B — J3258A is *not* supported)** for a 10Base-T network connection, if you only need to connect the product to this print server.
 - **HP JetDirect 300X (J3263) with a firmware revision of H.08.00 or higher*** for a 10Base-T or 10/100Base-TX network connection, if you only need to connect the product to this print server.
 - **HP JetDirect 500X (J3265) with a firmware revision of J.08.00 or higher*** for a BNC, 10Base-T, or 10/100Base-TX network connection, if you need to connect the product and up to two other devices to this print server.
 - **HP JetDirect 500X (J3264) with a firmware revision of J.08.00 or higher*** for a Token Ring network connection. You can connect the product and up to two other devices to this print server.

*You can check the firmware revision number by printing a configuration page for the print server. Instructions for printing the configuration page appear later in this guide.

Note

HP recommends against using HP JetDirect Print Servers that are older than the print servers listed above.

Check your work #3

Does your computer or network meet the requirements?

Checking the contents of the box

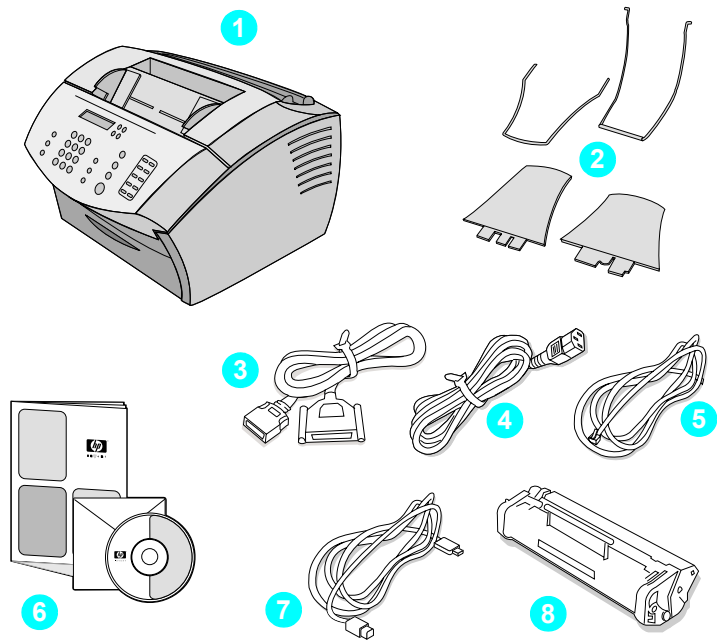

Unpack the box and check to see that it includes the following items:

- 1 HP LaserJet 3200M product
- 2 Four media supports
- 3 IEEE-1284 compliant parallel cable (with a “C” connector)
- 4 Power cord
- 5 Telephone cord
- 6 Software and documentation on CD-ROM
- 7 USB cable
- 8 Toner cartridge

Save the box and packing material in case you move or ship the product later.

Check your work #4

Does the box contain all of the items it should?

Recording important information

Take a moment now to write the model and serial numbers, which are located on the back of the product, and the date of purchase on the inside front cover of this guide. HP Customer Care will ask for this information if you call with a question.

Also, locate your sales receipt or proof of purchase and tape it or staple it to the inside, back cover of this guide.

When you are ready, continue to “Hardware overview” on page 14.

Hardware overview

Place the product on a sturdy, level surface in a well-ventilated area that meets the following environmental requirements:

- temperature: 15° to 32.5° Celsius (59° to 90.5° Fahrenheit)
- humidity: 10% to 80% relative humidity (no condensation)
- install away from direct sunlight, open flames, and ammonia fumes
- install with enough space around the product to allow for proper access and ventilation, as shown in the figure below:

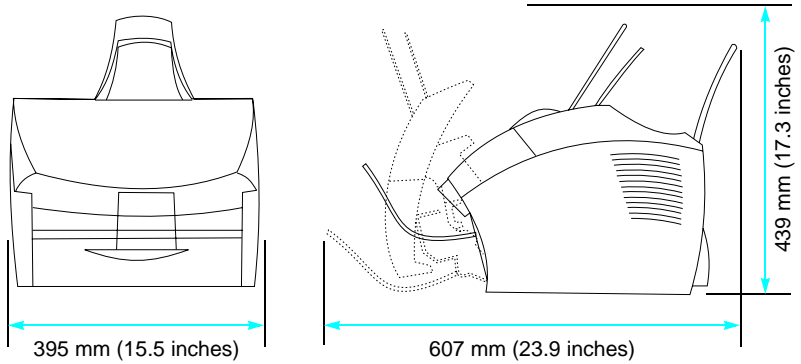

Then, make sure you can identify the parts shown in this overview.

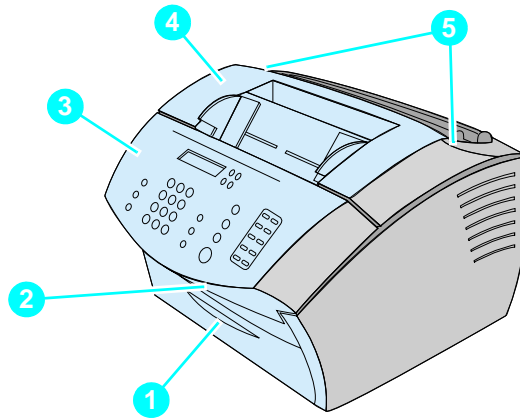

- 1 Front paper path door
- 2 Document output slot
- 3 Control panel/document release door
- 4 Printer door
- 5 Printer door release latches

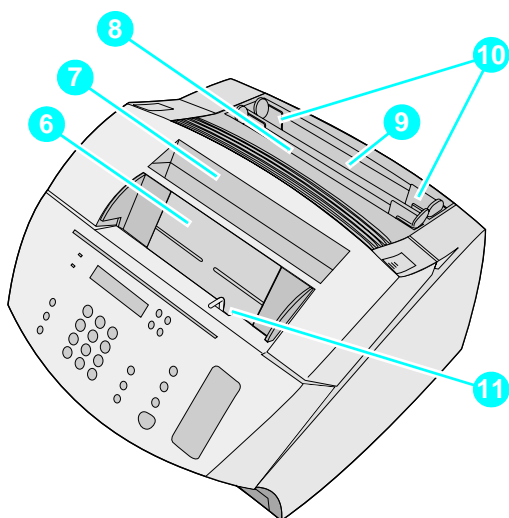

- 6** Document feeder tray
- 7** Paper output bin
- 8** Single-sheet input tray
- 9** Paper input tray
- 10** Paper input guides
- 11** Special media lever

When you are comfortable with parts identification, continue to Chapter 2, Installation.

2 Installation

HP LaserJet 3200M product installation involves one of the following installation paths, depending upon the type of installation you chose:

Direct connection to a computer

1	Set up hardware
2	Set up phone connections, including attaching other telephone line devices
3	Connect power
4	Connect the product to the computer
5	Install the software

Network connection

1	Set up hardware
2	Set up phone connections, including attaching other telephone line devices
3	Connect power
4	Connect the product to a supported HP JetDirect Print Server
5	Install the software

Standalone

1	Set up hardware
2	Set up phone connections, including attaching other telephone line devices
3	Connect power
4	Set the date and time, fax header, and other required items on the product

Setting up hardware

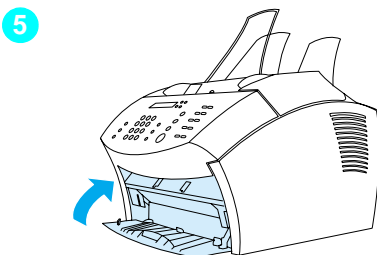
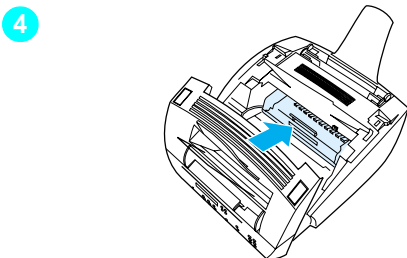
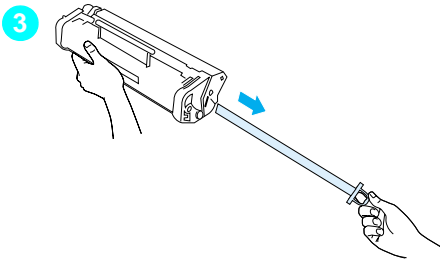
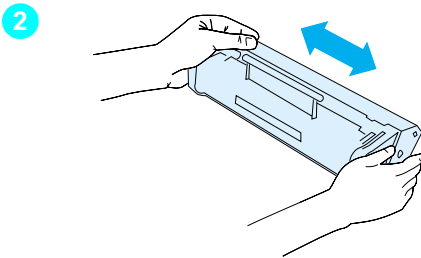
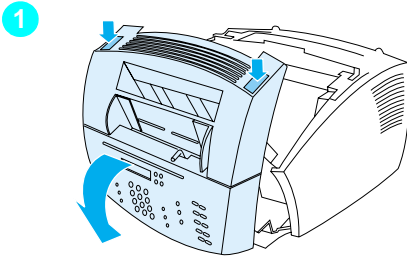

Toner

HP recommends using HP LaserJet toner cartridges, which are designed to work with the product to give you optimal image quality and reliability.

CAUTION

To prevent damage, do not expose the toner cartridge to light for more than a few minutes.

To install the toner cartridge

- 1 Press the two printer door release latches and open the printer door.
- 2 Shake the toner cartridge several times from side to side (about twice per second) to distribute the toner evenly.
- 3 Grasp the end of the clear sealing tape on the side of the cartridge and pull firmly to remove the entire length of the tape (about twice as long as the cartridge).
- 4 Hold the cartridge by the handle, with the arrows facing the product, and slide the cartridge into the black grooves in the product. Rotate the cartridge firmly into place and close the printer door.
- 5 Close the front paper path door.

Note

If toner gets on your clothing, wipe it off with a dry cloth and wash the clothing in cold water. Hot water and heat from a dryer can set toner into fabric.

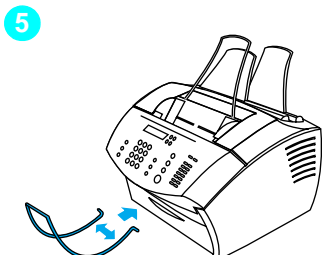
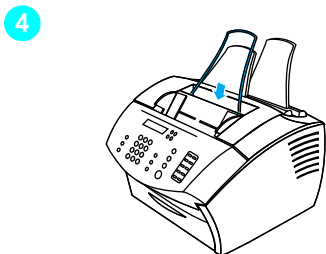
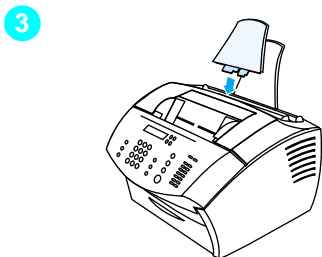
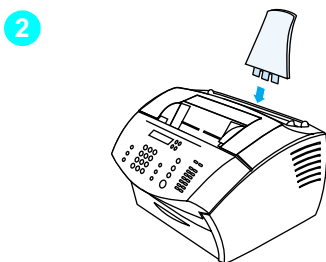
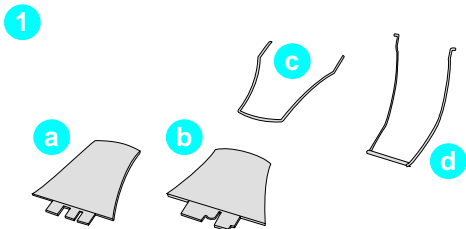

Supports

To support media feeding into and coming out of the product, four supports should be installed.

To attach supports

- 1 Locate the four supports:
 - a paper input support
 - b paper output support
 - c document feeder support
 - d document output support
- 2 Insert the paper input support into the groove on the paper input tray.
- 3 Insert the paper output support into the groove on the paper output bin.
- 4 Insert the document feeder support into the grooves on the back of the document feeder tray.
- 5 Squeeze the ends of the document output support, insert it into the holes on the document output slot, and release the support.

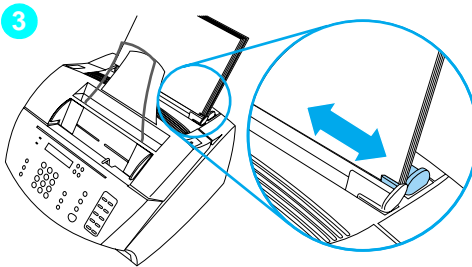
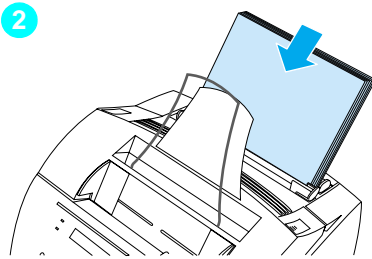
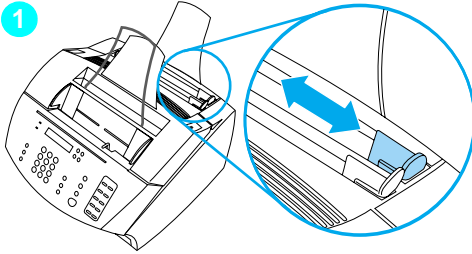

Paper/media

You can load up to 125 sheets of 20 lb (75 g/m²) paper into the paper input tray. The product uses media from the paper input tray or from the single-sheet input tray to print, copy, and print received faxes.

To load the paper input tray

- 1 Adjust the paper input guides to the size of media you want to load.
- 2 Insert up to 125 sheets of paper into the paper input tray. Be careful not to overfill the tray.

Note

When adding paper to the paper input tray, always remove any paper already in the tray and restack it with the new paper before loading to reduce multiple feeds and jams.

- 3 Readjust the paper input guides to fit snugly against the edges of the stack.

Check your work #5

Were you able to install the toner, attach the supports, and load media into the paper input tray?

Connecting the product

As you work your way through connecting the product, you will make several decisions. Some are based on your personal preferences; others are based on phone services and equipment you already have.

The first step in connecting the product is connecting the phone line to the product.

Connecting the phone line

In order for the product to fax correctly, it must be the first device connected to the phone jack.

Note

If you do not have an RJ11 phone jack or if an RJ11 adapter did not come with the product, you must buy and install one to convert the phone jack to an RJ11 phone jack.

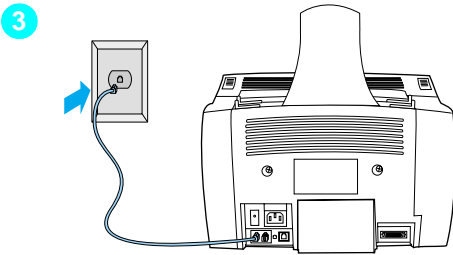
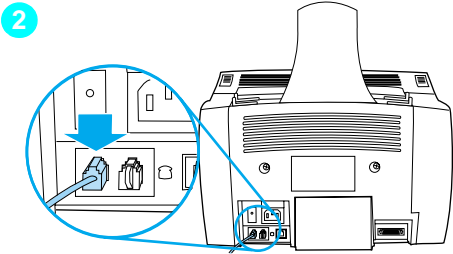
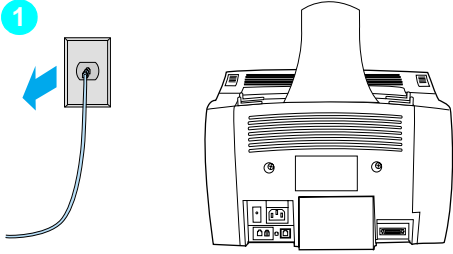

To connect the product to the phone line

- 1 If any telephone cord is plugged into the phone jack, unplug the cord and set it aside.
- 2 Plug one end of the telephone cord that was included in the product box into the socket shown (on the back of the product).
- 3 Plug the other end into the phone jack. If it does not seem to fit correctly, see the note on page 21.

After you have connected the phone cord, continue to page 23 or to page 26, depending upon the following:

- If you want to connect other devices, such as a telephone, to the phone line, continue to “Connecting additional devices” on page 23.
- If you do not want to connect other devices, continue to “Connecting power and testing” on page 26.

Connecting additional devices

You can connect up to three additional devices to the phone line, depending upon how your phone line is set up:

- a telephone
- an answering machine
- an external modem or an internal modem in a computer

Note

If you have an external modem or an internal modem for your computer that you use to send and receive e-mail, to connect to the Internet, or to communicate with other computers, you will still have to connect the modem to the phone line. The product cannot act as a data modem for these purposes.

Dedicated fax line

If you connected the product to a phone jack with a phone line for fax calls only:

- You can connect a modem if you want to use the fax line for e-mail or for access to the Internet, although you cannot send or receive faxes while the line is in use for these purposes.
- You can connect an extra telephone if you want to make outgoing calls on the fax line.
- You should not connect an answering machine or computer voicemail. If you use computer voicemail, you must connect the modem, whether external or internal, to your dedicated voice line. Then, use the dedicated voice line to connect to the Internet or to e-mail.

Shared line

If you connected the product to a phone jack with a phone line for both fax calls and voice calls or if you have one phone line with two phone numbers and ring pattern service:

- You can connect the devices listed above to the phone line.
- If you have another phone jack for the phone line, you can connect some devices to it, but if you want to connect an answering machine or computer voicemail, you should connect that device to the same phone jack as the product.

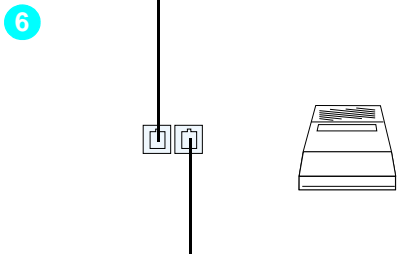
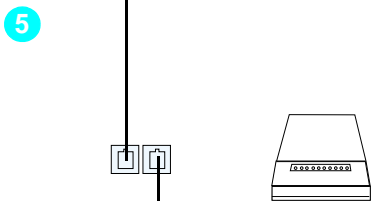
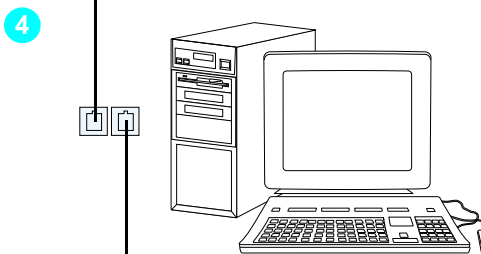
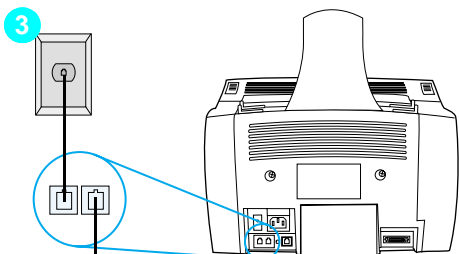
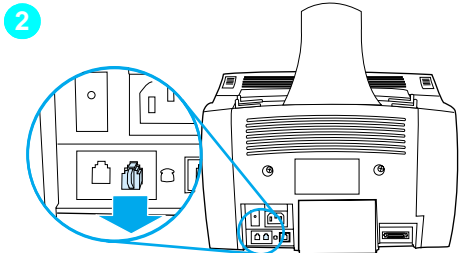

To prepare the product for additional devices

- 1 Unplug all of the additional devices you want to connect from their power sources.
- 2 Remove the plastic insert from the “phone” socket on the back of the product.

To connect additional devices

Connect additional devices in the order shown below. If you do not want to connect a device, skip it and continue to the next device.

- 3 The product is already connected to the phone jack.
- 4 To connect the internal modem on a computer, plug the computer’s phone cord into the “phone” socket on the product.

Note

Some computers have a second “line” socket to connect the computer to a dedicated voice line. If you have two “line” sockets, check your computer documentation to make sure you connect to the correct “line” socket.

- 5 To connect an external modem, plug the modem’s phone cord into the “phone” socket on the product (or on the internal modem).
- 6 To connect an answering machine, plug the answering machine’s phone cord into the “phone” socket on the product or on the last device you connected.

7

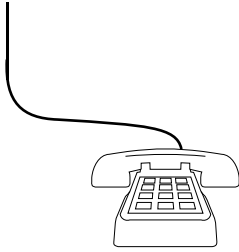

- 7** To connect a telephone, plug the phone cord into the “phone” socket on the product or on the last device you connected.
- 8** After you have finished connecting additional devices, plug back in all of the devices to their power sources.

Connecting power and testing

Connecting power

Make sure the power switch is in the "off" position before you connect the power cord.

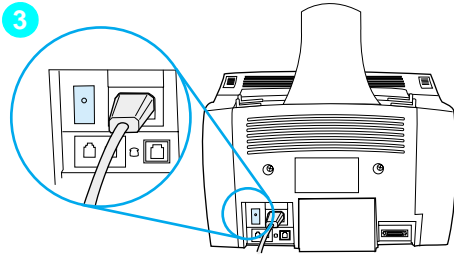
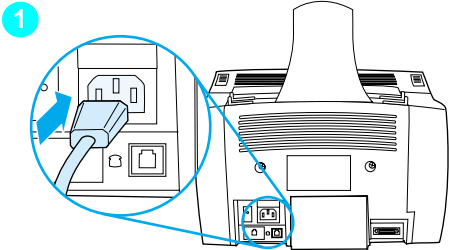

To connect the product power cord

CAUTION

Use the power cord that came in the product box. Using a different power cord can damage the product.

- 1 Connect the power cord to the connector on the back of the product.
- 2 Plug the other end into a grounded power strip or wall outlet.
- 3 Turn the power switch to the "on" position.

After you complete step 3, the product begins an internal self-test.

Note

If you plug the product into a power strip that has an on/off switch, make sure that the power strip is turned on at all times. The product cannot receive faxes if it is without power.

Check your work #6

After you connect the power cord, does **READY** appear on the control panel display?

Testing the hardware

After you plug in the power cord, you should be able to print the demonstration page and make a copy of it. This test ensures that the hardware is working properly.

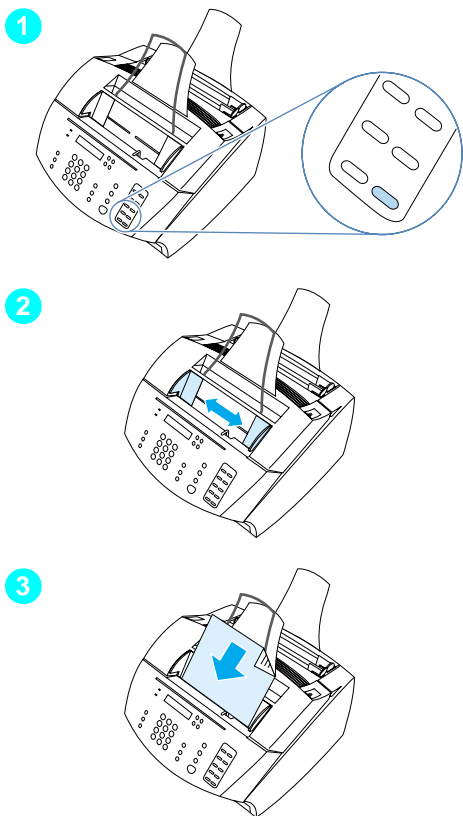

To test the hardware

- 1 At the product control panel, press the **10** on the numeric keypad to print the demonstration page.

Note

You can still configure the #10 one-touch key as an individual or group-dial later. See the online user guide for information about configuring the one-touch keys.

- 2 Adjust the guides on the document feeder tray to the size of the demonstration page.
- 3 Place the demonstration page top first, face down, into the document feeder tray and verify that the control panel display reads **DOCUMENT LOADED**.
- 4 On the product control panel, press **COPY**.

The product should make a copy of the demonstration page and the control panel should return to **READY**.

Check your work #7

Were you able to print and copy the demonstration page?

Completing installation

Review your checklist (question 2) to see the type of installation you chose before you set up the product. There are three installation types:

- **Direct connection** to a computer
- **Network connection** with an HP JetDirect Print Server
- **Standalone**, to use the product as a fax machine and copier, not connected to a computer

Now that the product hardware is installed, it is time to connect it to your network or to your computer, or, for a standalone installation, to prepare the product for sending and receiving faxes.

If you chose . . .	continue to . . .
Direct connect installation , and you want to use a USB cable	"Direct connect installation (USB cable)" on page 29
Direct connect installation , and you want to use a parallel cable	"Direct connect installation (parallel cable)" on page 33
Network installation	"Network installation" on page 38
Standalone installation	"Standalone installation (no computer)" on page 44

Direct connect installation (USB cable)

If you have a Macintosh computer or if you use Windows 98, Millennium Edition, or 2000, you can connect the product to the computer with the USB cable that was included in the product box.

Note

If you want to use a parallel cable to connect the product, continue to “To connect the product to a computer with a parallel cable” on page 33. Parallel connections are not supported for Macintosh computers.

2

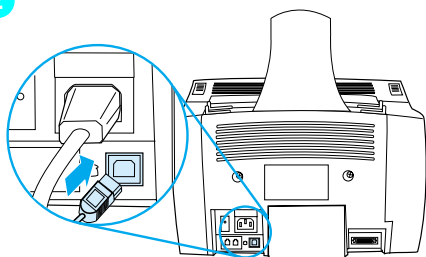

To connect the product to a computer with a USB cable

Note

Windows 95 and Windows NT 4.0 do not support USB cable connections.

- 1 Quit all open programs.
- 2 Plug one end of the USB cable into the USB socket on the product.
- 3 Plug the other end of the USB cable into the computer's USB socket.

3

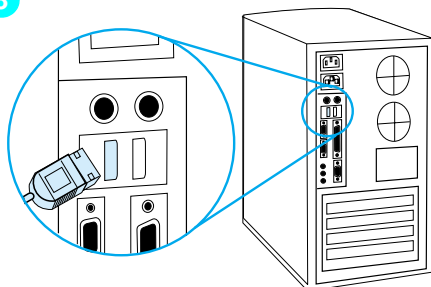

Note

With Windows operating systems, after you have completed step 3, the “New Hardware Wizard” window should immediately appear on the computer display.

- 4 Depending on your operating system, follow the steps listed:
 - for Windows 98, follow steps **a** through **f** on page 30.
 - for Windows Millennium Edition, follow steps **g** through **k** on page 30.
 - for Windows 2000, follow steps **l** through **r** on page 31.
 - for Macintosh operating systems, follow steps **s** through **z** on page 32.

To install the software for Windows 98 (direct connect installation with a USB cable)

- a In the “Add New Hardware Wizard” window, click **Next>**.
 - b Select **Search for the best driver for your device. (Recommended)** and then click **Next>**.
 - c Click the boxes as needed so that there is a check mark next to **Specify a location:** (and **no** check marks next to **Floppy disk drives** and **CD-ROM drive**).
 - d Under **Specify a location:**, type `Z:\98me_usb` (where Z is the letter of your CD-ROM drive).
 - e Insert the product software CD-ROM into the CD-ROM drive and then click **Next>**.
 - f Continue to step 5 on page 31.
-

To install the software for Windows Millennium Edition (direct connect installation with a USB cable)

- g In the “Add New Hardware Wizard” window, select **Specify the location of the driver (Advanced)** and then click **Next>**.
 - h Select **Search for the best driver for your device. (Recommended)** and then click the boxes as needed so that there is a check mark next to **Specify a location:** (and **no** check mark next to **Removable Media**).
 - i Under **Specify a location**, type `Z:\98me_usb` (where Z is the letter of your CD-ROM drive).
 - j Insert the product software CD-ROM into the CD-ROM drive and then click **Next>**.
 - k Continue to step 5 on page 31.
-

To install the software for Windows 2000 (direct connect installation with a USB cable)

Note

To install the software on Windows 2000, you must have administrator privileges (on start and restart).

- l** In the “Found New Hardware Wizard” window, click **Next>**.
- m** Select **Search for a suitable driver for my device (recommended)** and then click **Next>**.
- n** Under **Optional search locations:**, click the locations as needed so that there is a check mark next to **Specify a location:** (and **no** check marks next to **Floppy disk drives** and **CD-ROM drives**) and then click **Next>**.
- o** Insert the product software CD-ROM into the CD-ROM drive.
- p** Under **Copy manufacturer’s files from:**, type **z:\2000** (where **z** is the letter of your CD-ROM drive) and then click **OK**.
- q** The Wizard should display a window indicating that it has found the driver; click **Next>**.
- r** Continue to step **5** on page 31.

5 Follow the instructions on the screen to install the software.

Note

Before installation is complete, make sure that there is a check mark next to **Print a test page** (when the prompt appears).

In Windows 2000, if the “Found New Hardware Wizard” window reappears before installation is complete, click **Cancel**.

6 Click **Finish**.

7 If you are prompted to restart your computer, click **Yes**.

Note

The test page should print after your computer restarts. If you are **not** prompted to restart your computer, a test page should print immediately.

8 Continue to “Check your work #8” on page 37.

To install the software for Macintosh computers (direct connect installation with a USB cable)

- s Insert the product software CD-ROM into the CD-ROM drive to start the software installer.

Note

If the installer does not start automatically, open the CD-ROM window and double click the "HP All-in-One Installer" icon.

- t Select the language to install. (The language of the operating system is displayed, but you may install a different language, if you choose.)
- u Click **Install** and then follow the instructions on the screen to complete the software installation.

Note

Before installation is complete, make sure that there is a check mark next to **Print a test page** (when the prompt appears).

- v When software installation is complete, click **Restart**. After the computer restarts, the HP All-in-One Setup Assistant starts automatically.
 - w In the welcome screen, click **Next>**.
 - x Under "Select Device," choose the USB option, select the HP LaserJet 3200 product from the list of USB devices, and then click **Next>**.
 - y Follow the instructions on the screen to complete the setup and then click **Go Ahead>**.
 - z Continue to "Check your work #8" on page 37.
-

Direct connect installation (parallel cable)

Note

If you have a Macintosh computer, you cannot use a parallel cable to connect the product. To connect the product to a Macintosh computer using a USB cable, see “Direct connect installation (USB cable)” on page 29.

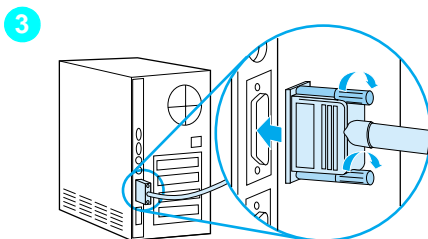
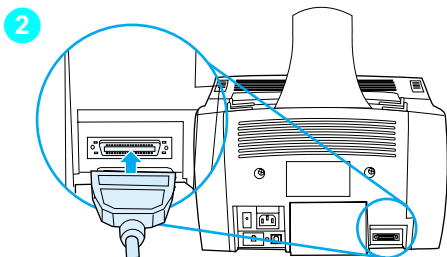

To connect the product to a computer with a parallel cable

- 1 Turn off the computer.
- 2 Squeeze the clips on the sides of the parallel cable and attach it to the connector on the back of the product. Gently tug on the cable to ensure it is securely connected, and then push it back in.
- 3 Connect the other end of the cable to a dedicated parallel port on the computer and secure the cable by tightening the screws. The product should be connected directly to a dedicated, IEEE-1284 bidirectional or ECP-compliant parallel port. If the parallel port has another device attached to it, such as an external storage device, that device must be disconnected.

CAUTION

Do not connect the parallel cable to a serial port on the computer. Doing so can damage the product. If you need help locating the parallel port, see the documentation for the computer.

- 4 Turn the computer back on.
- 5 After the computer restarts, follow the steps listed for the version of Windows that you use:
 - for Windows 95, follow steps **a** through **d** on page 34.
 - for Windows 98, follow steps **e** through **j** on page 34.
 - for Windows 2000, follow steps **k** through **q** on page 35.
 - for Windows Millennium Edition, follow steps **r** through **v** on page 35.
 - for Windows NT 4.0, follow steps **w** through **z** on page 36.

To install the software for Windows 95 (direct connect installation with a parallel cable)

The "Update Device Driver Wizard" window should appear on the computer display.

- a Insert the product software CD-ROM into the CD-ROM drive.
 - b Depending on the version of Windows 95:
Click **Next>** (if available) and then continue to step **6** on page 36.
-or-
Click **OK** and then continue to step **c** below.
 - c On the line provided, type `z:\9xme_1pt` (where `z` is the letter of your CD-ROM drive), and then click **OK**.
 - d Continue to step **6** on page 36.
-

To install the software for Windows 98 (direct connect installation with a parallel cable)

- e In the "Add New Hardware Wizard" window, click **Next>**.
 - f Select **Search for the best driver for your device. (Recommended)** and then click **Next>**.
 - g Click the boxes as needed so that there is a check mark next to **Specify a location:** (and **no** check marks next to **Floppy disk drives** and **CD-ROM drive**).
 - h Under **Specify a location:**, type `z:\9xme_1pt` (where `z` is the letter of your CD-ROM drive).
 - i Insert the product software CD-ROM into the CD-ROM drive and then click **Next>**.
 - j Continue to step **6** on page 36.
-

To install the software for Windows 2000 (direct connect installation with a parallel cable)

Note

To install the software on Windows 2000, you must have administrator privileges (on start and restart).

- k** In the “Found New Hardware Wizard” window, click **Next>**.
- l** Select **Search for a suitable driver for my device (recommended)** and then click **Next>**.
- m** Under **Optional search locations:**, click the locations as needed so that there is a check mark next to **Specify a location:** (and **no** check marks next to **Floppy disk drives** and **CD-ROM drives**) and then click **Next>**.
- n** Insert the product software CD-ROM into the CD-ROM drive.
- o** Under **Copy manufacturer’s files from:**, type `z:\2000` (where `z` is the letter of your CD-ROM drive) and then click **OK**.
- p** The Wizard should display a window indicating that it has found the driver; click **Next>**.
- q** Continue to step **6** on page 36.

To install the software for Windows Millennium Edition (direct connect installation with a parallel cable)

- r** In the “Add New Hardware Wizard” window, select **Specify the location of the driver (Advanced)** and then click **Next>**.
 - s** Select **Search for the best driver for your device. (Recommended)** and then click the boxes as needed so that there is a check mark next to **Specify a location:** (and **no** check mark next to **Removable Media**).
 - t** Under **Specify a location**, type `z:\9xme_lpt` (where `z` is the letter of your CD-ROM drive).
 - u** Insert the product software CD-ROM into the CD-ROM drive and then click **Next>**.
 - v** Continue to step **6** on page 36.
-

To install the software for Windows NT 4.0 (direct connect installation with a parallel cable)

Note

To install the software on Windows NT 4.0, you must have administrator privileges (on start and restart).

- w** Insert the product software CD-ROM into the CD-ROM drive.
 - x** When the welcome screen opens, follow the directions on screen. If the welcome screen does not open, click **Start**, click **Run**, type `Z:\setup` (where *Z* is the letter of your CD-ROM disk drive), and then click **OK**.
 - y** Click the button labeled **Software Installation**.
 - z** Continue to step **6** on page 36.
-

- 6** Follow the instructions on the screen to install the software.

Note

Before installation is complete, make sure that there is a check mark next to **Print a test page** (when the prompt appears).

In Windows 2000, if the “Found New Hardware Wizard” window reappears before installation is complete, click **Cancel**.

-
- 7** Click **Finish**.
 - 8** If you are prompted to restart your computer, click **Yes**.

Note

The test page should print after your computer restarts. If you are **not** prompted to restart your computer, a test page should print immediately. (If you use Windows NT 4.0, you should not have to restart your computer.)

-
- 9** Continue to “Check your work #8” on page 37.

Check your work #8

Did the test page print?

Completing software installation

When installation is complete, remove the CD-ROM and store it in a safe place.

Additional notes about software

If you already have a PC fax program

The PC fax program that came with the product is the only PC fax program that works with the product's built-in modem. If you want to continue to use your PC fax program, you can still use it with the modem you already have, but you cannot use it with the product.

If you already have scanning software

The product comes with scanning software. You can use it or any other TWAIN-compliant scanning software that is compatible with the product. (TWAIN is an industry standard.) See the Readme.txt file on the software CD-ROM for a list of programs that have been tested for compatibility.

Continue to "Printing a document as a test" on page 42.

Network installation

To connect the product to the network using an HP JetDirect Print Server, you need to do the following.

- 1 Purchase and set up a supported HP JetDirect Print Server or check that the one you have is supported. (See page 11 for a list of supported print servers. See the documentation for the print server to set it up. Do not install the software that came with the HP JetDirect Print Server.)
- 2 Connect the product to the print server. (See the documentation for the print server.)

Note

Make sure you **do not** create a JetDirect port while performing step 2.

- 3 Test the hardware installation by printing the configuration pages for the HP JetDirect Print Server (two pages should print; only one page should print with the HP Jet Direct 70X). To do this, press **TEST** on the print server. (*If the pages do not print, use ASCII as the configuration page language.* See the print server documentation for further instructions.)
- 4 Check the model or firmware revision number, which is located in the first section of the configuration pages you just printed.
 - If you have a 170X Print Server and the model number is *not* J3258B, you must get a new print server.
 - If you have a 300X or 500X Print Server and the firmware revision number is *not* H.08.00 or J.08.00 or higher, you must download a firmware upgrade from the HP website at http://www.hp.com/support/net_printing. Or, see the documentation that came with the HP JetDirect Print Server.

Installing software for network computers

To install the software on network computers, the computers must be running Windows 95, 98, Millennium Edition, 2000, or NT 4.0, or Mac OS 8.6 or 9.0. All computers that have the product software installed can use all of the product features available over the network. Computers on which the product software is not installed are limited to printing to the product over the network.

For IPX/SPX users: You must use the IPX/SPX protocol in Direct mode. The configuration pages you printed in step 3 on page 38 contain the LAN hardware address you need for software installation.

For TCP/IP users: Use only the product software to make the network connection to the printer. Other software might not work. The configuration pages you printed in step 3 on page 38 contain the IP address, default gateway, and subnet mask information you need for software installation.

If the computer already has a PC fax program

The PC fax program that came with the product is the only PC fax program that works with the product's built-in modem. If you want to continue to use your PC fax program, you can still use it with the modem you already have, but you cannot use it with the product.

If the computer already has scanning software

The product comes with scanning software. You can use it or any other TWAIN-compliant scanning software that is compatible with the product. (TWAIN is an industry standard.) See the Readme.txt file for a list of programs that have been tested for compatibility.

Follow the instructions below depending on the operating system you use:

To install software for Windows operating systems

Note

To install the software on Windows 2000 or NT 4.0, you must have administrator privileges (on start and restart).

- 1 Quit all open programs.
- 2 Insert the CD-ROM into the CD-ROM drive. When the welcome screen opens, follow the directions on screen.

Note

If the welcome screen does not open, click **Start**, click **Run**, type `Z:\setup` (where Z is the letter of your CD-ROM drive), and then click **OK**.

- 3 Follow the instructions on the screen. Make sure you select "Connected to the network" before you click **Next>** when the installer software prompts you to select how the product will be connected.
 - 4 When the installation is nearly complete, a setup screen appears that asks whether or not you want to print a test page; select "Yes."
-

To install software for Macintosh operating systems

- 1 Insert the product software CD-ROM into the CD-ROM drive to start the software installer.

Note

If the installer does not start automatically, open the CD-ROM window and double click the "HP All-in-One Installer" icon.

- 2 Select the language to install. (The language of the operating system is displayed, but you may install a different language, if you choose.)
- 3 Click **Install** and then follow the instructions on the screen to complete the software installation.
- 4 When software installation is complete, click **Restart**. After the computer restarts, the HP All-in-One Setup Assistant starts automatically.

- 5 In the welcome screen, click **Next>**.
- 6 Under "Select Device," choose the TCP/IP option, select the HP LaserJet 3200M product and then click **Next>**.
- 7 Enter the IP address of the product and then click **OK>**.

Note

The configuration pages you printed in step 3 on page 38 contain the IP address information you need for software installation.

- 8 Follow the instructions on the screen to complete the setup and then click **Go Ahead>**.

Check your work #8 (for network installations)

Did the test page print?

Completing software installation

- Remove the CD-ROM when the setup is finished.
- Repeat steps 1 through 4 for all other computers on which you want to install software.

When finished, store the CD-ROM in a safe place.

Continue to "Printing a document as a test" on page 42.

Printing a document as a test

Follow the steps below to print an electronic document and ensure that the product and software are working properly.

- 1 Open a document created in a program such as Wordpad, Write, or SimpleText.
- 2 On the **File** menu, select the **Print** command. Make sure the HP LaserJet 3200M product is selected and click **OK**.



Check your work #9

Did the document print?

Sharing the product (for printing only)

Using Windows sharing, the person using the computer directly connected to the product can allow other users on the network to print to it. Computers running Windows 3.1x can use Windows-sharing to print, but the computer directly connected to the product must be running Windows 95, 98, Millennium Edition, 2000, or NT 4.0.

Note

Peer-to-peer sharing is not supported on Macintosh systems.

See the computer documentation to enable Windows-sharing. Once the product is shared, install the printer drivers on all computers you want to allow to print to the product. For Windows 95, 98, Millennium Edition, 2000, or NT 4.0, the easiest way to do this is to use the following procedure, which does not require the CD-ROM. For Windows 3.1x, see the documentation for your computer to install printer drivers.

To add the printer driver to network computers for Windows 95, 98, Millennium Edition, 2000, or NT 4.0

- 1 On the **Start** menu, point to **Settings**, and click **Printers**.
- 2 Double-click **Add Printer** and click **Next**.
- 3 Follow the directions on screen. Also:
 - When asked if the product is a local or network printer, select **Network Printer**.
 - To find the printer, click **Browse**, locate the printer name you assigned when you shared the printer, and then click **OK**.
 - When prompted, print a test page to ensure the printer driver is installed properly.

Note

You might need the product software CD-ROM to complete the printer driver installations.

Standalone installation (no computer)

Before you can use the product as a standalone fax machine, you must complete the following, instructions for which appear on the following pages:

- 1 Set the time and date.
Time and date information is included in the header that prints at the top of faxes you send. The time and date also show on the control panel display when the product is idle.
- 2 Enter the fax header information.
Fax header information prints at the top of faxes you send. **Filling it in is a legal requirement.** Most product functions are not available until the fax header information is filled in.
- 3 Check the answer mode and number of rings-to-answer settings.
Depending on your configuration, you may or may not have to alter these settings.
- 4 If you have ring-pattern service (such as distinctive ring) from your local telephone company, “answer ring-pattern” must be set correctly on the product.
- 5 Print a configuration report to make sure that the product is working correctly.

To set the time and date

- 1 Press **ENTER/MENU**.
- 2 Use the **<** and **>** keys to select **TIME/DATE**, **HEADER**, and then press **ENTER/MENU**.
- 3 Press **ENTER/MENU** to select **TIME/DATE**.
- 4 Use the **<** and **>** keys to select a 12-hour or a 24-hour clock, and then press **ENTER/MENU**.
- 5 Enter the current time using the numeric keys.

Note

If you enter a number incorrectly, press **BACK SPACE** until you reach the entry; then, reenter the number.

- 6 If you chose the 12-hour clock, use the **<** and **>** keys to move the cursor past the fourth character. Select **1** for am or select **2** for pm, and then press **ENTER/MENU**.
- Or -
If you chose the 24-hour clock, press **ENTER/MENU**.
- 7 Enter the current date using the numeric keys. Make sure you enter the month and day using both digits (for example, "05" for May).
- 8 Press **ENTER/MENU**.

Check your work #10

Does the control panel read **READY**, followed by the date and time you set?

To set the fax header

- 1 Press **ENTER/MENU**.
- 2 Use the **<** and **>** keys to select **TIME/DATE**, **HEADER**, and then press **ENTER/MENU**.
- 3 Use the **<** and **>** keys to select **FAX HEADER** and press **ENTER/MENU**.
- 4 Enter your fax number and press **ENTER/MENU**. To separate numbers, press **>** to insert spaces. To add a plus sign, press *****.
- 5 Use the numeric keys to add the name of your company. To do so, repeatedly press the numeric key for the letter you need until the letter appears. (For example, if the first letter you need is a "C," press **2** repeatedly until a **C** appears.) Then press **>** or any other key to move the cursor to the next space.

Note

To insert punctuation, press ***** repeatedly until the character you want appears, and then press **>** to move the cursor to the next space. To delete a letter, press **<** or **>** until you reach the space to the right of the letter, and then press **BACK SPACE**.

- 6 When you have finished, press **ENTER/MENU**.

Setting answer mode and rings-to-answer

The answer mode is set to Automatic or Manual depending on your situation. In Automatic mode, the product answers incoming calls after the number of rings-to-answer specified. Or, it “listens” for fax tones when an answering machine connected to the line answers first and then answers if it is a fax call. In Manual mode, the product never answers calls. You must start the fax-receiving process yourself, either by pressing **FAX/SEND** on the control panel or by picking up a phone connected to that line.

If the product is set to Automatic mode, you may need to adjust the rings-to-answer setting. This is especially important if the product is connected to a line receiving both fax and voice calls (a shared line) with an answering machine. The rings-to-answer on the product must be higher than the rings-to-answer on the answering machine. This allows the answering machine to answer the incoming call and record a message if it is a voice call. This also allows the product to listen to the call, and, if it detects fax tones, to answer the call.

The factory default answer mode is “Automatic.” The default number of rings-to-answer is 2. Use the table below to determine the settings you should use:

If you have . . .	Recommended answer mode	Recommended number of rings-to-answer
A dedicated fax line (only receiving fax calls)	Leave at Automatic	Leave at 2 rings or set to 3 rings.
A shared line (receiving both fax and voice calls) and a telephone as the only additional device connected	Leave at Automatic*	Set to 5 rings.
A shared line (receiving both fax and voice calls) and an answering machine or computer voicemail	Leave at Automatic	Set to 2 rings greater than the answering machine or computer voicemail (for example, if the answering machine answers at 3 rings, set the product to 5 rings). <i>You cannot set the product to more than 6 rings.</i>
One line with two separate numbers and ring pattern service	Leave at Automatic	Leave at 2 rings. (If you have an answering machine or computer voicemail for the other phone number, make sure the product is set to a <i>lower</i> number of rings than the answering system. Also see “Enabling answer ring patterns” on page 49.)

*In Automatic, the product automatically answers fax calls. However, people calling to speak to you hear fax tones if you do not answer or if they do not hang up by the number of rings at which the product answers. Use the Manual setting if you do not want voice callers ever to hear fax tones, but remember that fax calls are not received automatically.

To set the answer mode

- 1 Press **ENTER/MENU**.
- 2 Use the **<** and **>** keys to select **FAX SETUP**, and then press **ENTER/MENU**.
- 3 Use the **<** and **>** keys to select **FAX RECEIVE SETUP**, and then press **ENTER/MENU**.
- 4 Press **ENTER/MENU** to select **ANSWER MODE**.
- 5 Use the **<** and **>** keys to select **AUTOMATIC** or **MANUAL**, and then press **ENTER/MENU**.

To set the number of rings to answer

- 1 Press **ENTER/MENU**.
- 2 Use the **<** and **>** keys to select **FAX SETUP**, and then press **ENTER/MENU**.
- 3 Use the **<** and **>** keys to select **FAX RECEIVE SETUP**, and then press **ENTER/MENU**.
- 4 Use the **<** and **>** keys to select **RINGS TO ANSWER**, and then press **ENTER/MENU**.
- 5 Enter the number of rings to answer, and then press **ENTER/MENU**.

Check your work #11

Does the control panel display show the answer mode setting that you chose?

Enabling answer ring patterns

If you subscribe to ring pattern service, such as distinctive ring, with your telephone company, set the product to answer the correct ring pattern.

What is ring pattern service?

Ring pattern service is available from some local telephone companies. It allows you to have two or three phone numbers on one line. This costs less than paying for two or three separate lines. Each of the phone numbers has a different ring pattern. Ring patterns allow you to answer voice calls and allow the product to answer fax calls.

How do I get the service?

Call your local telephone company to check the availability and to subscribe. The service might not be available in all areas. Also, your telephone company might use a different name for this service.

If ring pattern service is available and you choose to subscribe to it, keep in mind the following:

- Select the ring pattern that the product will use to distinguish fax calls.
- Make sure the telephone company assigns the correct ring pattern to the fax number. In Australia, it should be the double-ring pattern.
- **Important! If you have an answering machine or computer voicemail on this line for the other phone number**, make sure the product's rings-to-answer is set to a *lower* number than the rings-to-answer on the answering machine or voicemail.

How will I know if it is working?

After product installation is complete, do one of the following to verify that the ring pattern service is working correctly:

- Ask someone you know to send you a fax. Make sure you provide the correct fax number.
- Or-
- Call HP's fax verification number. After we receive some basic information from you, we will send you back a fax.

To enable answer ring patterns

Note

If you do not have ring pattern service, and you change this setting from **All Rings** to another setting, the product might not be able to receive faxes.

- 1 Press **ENTER/MENU**.
- 2 Use the **<** and **>** keys to select **FAX SETUP**, and then press **ENTER/MENU**.
- 3 Use the **<** and **>** keys to select **FAX RECEIVE SETUP**, and then press **ENTER/MENU**.
- 4 Use the **<** and **>** keys to select **ANSWER RING PATTERN**, and then press **ENTER/MENU**.
- 5 Use the **<** and **>** keys to select the ring pattern you want, and then press **ENTER/MENU**.

To print a configuration report

- 1 Press **ENTER/MENU**.
- 2 Use the **<** and **>** keys to select **REPORTS**, and then press **ENTER/MENU**.
- 3 Use the **<** and **>** keys to select **CONFIGURATION REPORT**, and then press **ENTER/MENU**.

The product exits the Menu settings and prints the report, confirming that the product is operating correctly.

Check your work #12

Check the report that the product just printed. Do the settings you entered appear correctly?

3 Installation troubleshooting

Use the following table to solve problems that might occur when installing the software or changing settings manually:

Problem	Cause	Solution
When installing software, you receive this message: "Setup has determined that you do not have enough disk space on the selected drive. Please reduce the set of install components or change the install drive."	The product software requires at least 175 MB of available disk space in PC-compatible computers, or 20 MB of available disk space in Macintosh computers, for installation.	After you select the product software and data directories, the installation program checks that your computer has enough available disk space. Try deleting unnecessary files or archiving older data to floppy disks or some other medium.
The software did not install (Windows 95, 98, Millennium Edition, 2000, or NT 4.0)	All programs <i>except</i> Systray and Explorer should be closed.	To check in Windows 95, 98, or Millennium Edition, press CTRL+ALT+DELETE . If other programs are open, click one and click End Task . Repeat for all other open programs. Then, reinstall the software. To check in Windows 2000 or NT 4.0, press CTRL+ALT+DELETE . On the Applications tab, if other programs are open, click one and click End Task . Repeat for all other open programs. Then, reinstall the software.

Problem	Cause	Solution
<p>When installing software on a Macintosh computer, you receive this message: "Unable to find a supported device attached to this machine. Select Cancel to cancel the install or Continue to return to the Select Device dialog."</p>	<p>The computer did not detect the product correctly.</p> <p>The Select Device dialog was completed incorrectly.</p>	<p>Make sure that the control panel display reads "READY," select Continue (to return to the Select Device dialog) and try again to install the product software. If the computer still does not detect the product, make sure that the USB cable or the network cable is connected correctly. Replace cables if the cables are faulty.</p> <p>Select Continue (to return to the Select Device dialog) and make sure that either USB or TCP/IP is selected. If TCP/IP is selected, also make sure that the IP address shown is correct.</p>
<p>The computer cannot read the installation CD-ROM.</p>	<p>The correct drive may not have been specified.</p> <p>The CD-ROM may be damaged.</p>	<p>Check for the proper disk drive letter. Often, it is D or E for the CD-ROM drive.</p> <p>Contact HP Customer Care. See "HP Customer Care" on page 58.</p>
<p>When the product is connected to the network using an HP JetDirect Print Server, you receive this message: "All in One configuration cannot continue because the required protocols were not found on your computer."</p>	<p>The IPX/SPX or TCP/IP protocols are not installed on your computer.</p>	<p>Install an IPX/SPX protocol that is compatible with NW Link or a TCP/IP protocol on your computer.</p>

Problem	Cause	Solution
<p>When the product is connected to the network using an HP JetDirect Print Server, you receive one of these messages:</p> <ul style="list-style-type: none"> ● "The configuration wizard did not find your HP LaserJet 3200M All in One on the network." ● "The configuration wizard was unable to find an All in One at the specified address." ● "The JetDirect model found at the specified address does not support All in One devices." 	<p>The print server you are using is not one of the HP JetDirect Print Servers that works with the product.</p> <p>The power cord is loose.</p> <p>The network cord is loose.</p> <p>The parallel cable is loose or not directly connected.</p> <p>The parallel cable might be faulty.</p> <p>The HP JetDirect Print Server might not be configured yet (TCP/IP).</p> <p>HP JetDirect Print Server is incorrectly configured (TCP/IP).</p>	<p>See page 11 for a list of compatible HP JetDirect Print Servers.</p> <p>Make sure that the power cord is securely connected between the product and the power source. Also, make sure that the power cord for the HP JetDirect Print Server is securely connected to the power source.</p> <p>Make sure that the network cable is securely connect between the HP JetDirect Print Server and the wall outlet for the network. Also, make sure that the network cable between the computer and the wall is securely connected.</p> <p>Make sure that the parallel cable between the HP JetDirect Print Server and the product is securely connected.</p> <p>If you have another "size C" parallel cable, try connecting it between the product and the HP JetDirect Print Server.</p> <p>If you installed the product software, uninstall it. Then, reinstall the software and select the Network Install option.</p> <p>See the documentation that came with the HP JetDirect Print Server for troubleshooting information.</p>
<p>Vertical streaks appear in scanning or copying.</p>	<p>The scanner should be cleaned and recalibrated.</p>	<p>See the online user guide for information about cleaning and recalibrating the scanner.</p>

4 Now that installation is complete . . .

Using the HP LaserJet 3200M product

If you completed a network installation or direct connect installation, see the online help and the online user guide for all of the information you need to fax, copy, scan, and print.

If you completed a standalone installation, there is still a lot you might want to know about the product's powerful fax and copy features, such as how to set send and receive fax options and how to print reports and logs. You should also know how to maintain the product and clear jams. The online user guide contains the information you need to keep the product operating smoothly and efficiently.

The online user guide is available on the CD-ROM that arrived in the product box. To find the online user guide, follow the steps below:

- 1 Insert the CD-ROM into the CD-ROM drive. The CD-ROM should start the browser utility automatically.

Note

If the CD-ROM does not start automatically, use your mouse to click **Start** and click **Run**. Type `Z:\setup` (where Z is the letter of your CD-ROM drive), and then click **OK**.

- 2 Click **Documentation**.
- 3 Click **User's Guide**.

HP CUSTOMER CARE

Online



Connect with HP! Whether you are a beginner or advanced user, HP Customer Care online is a great place to learn more about your product. Click your way to the answers, training, and software updates you need, 24 hours a day, 7 days a week, all at no charge to you.

Visit <http://www.hp.com/support/lj3200>. (Site is in English.)

E-mail



Get assistance conveniently and quickly with e-mail. E-mail your question to HP, and you will receive a reply within 24 hours on business days. It's that simple. E-mail questions via HP's Web site at <http://www.hp.com/support/lj3200>. (Site is in English.)

User Forums



Go online, anytime, to find other users with great ideas and usage suggestions at HP's online user forum for the HP LaserJet 3200M product. Visit HP's Web site at <http://www.hp.com/support/lj3200>. (Site is in English.)

Your purchase is backed by HP Customer Care—award-winning service and support. HP Customer Care is our promise to provide support solutions that keep you up and running . . . and learning how to do more with your HP LaserJet 3200M product.

Subscription services

When you sign up for Proactive Notification, we will send you e-mail about topics of your choice, like: updated software, product announcements, and other important news about your HP LaserJet 3200M products. Sign up online at <http://www.hp.com/support/lj3200>. (Site is in English.)



By phone

Speak with trained service technicians who specialize in your product by calling +(03) 8877 8000.

Before you call, please have the purchase date and note the product model and serial numbers, which are on the back of the product, or you might have written them on the inside front cover.



Warranty statement

Hewlett-Packard limited warranty statement

HP LaserJet 3200M product ONE-YEAR LIMITED WARRANTY

- 1** HP warrants to you, the end-user customer, that HP hardware, accessories, and supplies, will be free from defects in materials and workmanship after the date of purchase, for the period specified above. If HP receives notice of such defects during the warranty period, HP will, at its option, either repair or replace products which prove to be defective. Replacement products may be either new or like-new.
- 2** HP warrants to you that HP software will not fail to execute its programming instructions after the date of purchase, for the period specified above, due to defects in material and workmanship when properly installed and used. If HP receives notice of such defects during the warranty period, HP will replace software media which does not execute its programming instructions due to such defects.
- 3** HP does not warrant that the operation of HP products will be uninterrupted or error free. If HP is unable, within a reasonable time, to repair or replace any product to a condition as warranted, you will be entitled to a refund of the purchase price upon prompt return of the product.
- 4** HP products may contain remanufactured parts equivalent to a new in performance or may have been subject to incidental use.
- 5** Warranty does not apply to defects resulting from (a) improper or inadequate maintenance or calibration, (b) software, interfacing, parts or supplies not supplied by HP, (c) unauthorized modification or misuse, (d) operation outside of the published environmental specifications for the product, or (d) improper site preparation or maintenance.

- 6 HP MAKES NO OTHER EXPRESS WARRANTY OR CONDITION WHETHER WRITTEN OR ORAL. TO THE EXTENT ALLOWED BY LOCAL LAW, ANY IMPLIED WARRANTY OR CONDITION OR MERCHANTABILITY, SATISFACTORY QUALITY, OR FITNESS FOR A PARTICULAR PURPOSE IS LIMITED TO THE DURATION OF THE EXPRESS WARRANTY SET FORTH ABOVE.** Some countries, states or provinces do not allow limitations on the duration of an implied warranty, so the above limitation or exclusion might not apply to you. This warranty gives you specific legal rights and you might also have other rights that vary from country to country, state to state, or province to province.
- 7 TO THE EXTENT ALLOWED BY LOCAL LAW, THE REMEDIES IN THIS WARRANTY STATEMENT ARE YOUR SOLE AND EXCLUSIVE REMEDIES. EXCEPT AS INDICATED ABOVE, IN NO EVENT WILL HP OR ITS SUPPLIERS BE LIABLE FOR LOSS OF DATA OR FOR DIRECT, SPECIAL, INCIDENTAL, CONSEQUENTIAL (INCLUDING LOST PROFIT OR DATA), OR OTHER DAMAGE, WHETHER BASED IN CONTRACT, TORT, OR OTHERWISE.** Some countries, states or provinces do not allow the exclusion or limitation of incidental or consequential damages, so the above limitation or exclusion may not apply to you.
- 8 (AUSTRALIA ONLY) THE WARRANTY TERMS CONTAINED IN THIS STATEMENT, EXCEPT TO THE EXTENT LAWFULLY PERMITTED, DO NOT EXCLUDE, RESTRICT OR MODIFY AND ARE IN ADDITION TO THE MANDATORY STATUTORY RIGHTS APPLICABLE TO THE SALE OF THIS PRODUCT TO YOU.**

Declaration of Conformity

Declaration of Conformity according to ISO/IEC Guide 22 and EN 45014	
Manufacturer's Name:	Hewlett-Packard Company
Manufacturer's Address:	11311 Chinden Boulevard Boise, Idaho 83714-1021, USA
declares, that the product	
Product Name:	HP LaserJet 3200 product
Model Number:	C7052A, 7053A, 7055A (Printer/Fax/Scanner/Copier)
Product Options:	ALL
conforms to the following Product Specifications:	
Safety:	IEC 950:1991+A1+A2+A3+A4/EN 60950:1992+A1+A2+A3+A4+A11 IEC60825-1:1993+A1/EN 60825-1:1994+A11 Class 1 Laser/LED Product
EMC:	CISPR 22:1997/EN 55022:1998 Class B ¹ CISPR 24:1997/EN 55024:1998 IEC 61000-3-2:1995/EN61000-3-2:1995 IEC61000-3-3:1994/EN61000-3-3:1995 FCC Title 47 CFR, Part 15 Class B ² / ICES-003, Issue 2 AS / NZS 3548:1995
Supplementary Information:	
The product herewith complies with the requirements of the Low Voltage Directive 73/23/EEC, the EMC Directive 89/336/EEC, and the R&TTE Directive 1999/5/EC (Annex II) and carries the CE-marking accordingly.	
1)	The product was tested in a typical configuration with Hewlett-Packard Personal Computer Systems.
2)	This Device complies with part 15 of the FCC Rules. Operation is subject to the following two conditions: (1) this device may not cause harmful interference, and (2) this device must accept any interference received, including interference that may cause undesired operation.
April 18, 2000	
For Compliance Information ONLY, contact:	
Australia Contact: Product Regulations Manager, Hewlett-Packard Australia Ltd., 31-41 Joseph Street, Blackburn, Victoria 3130, Australia	
European Contact: Your Local Hewlett-Packard Sales and Service Office or Hewlett-Packard GmbH, Department HQ-TRE / Standards Europe, Herrenberger Strasse 130, D-71034 Böblingen (FAX: +49-7031-14-3143)	
USA Contact: Product Regulations Manager, Hewlett-Packard Company, PO Box 15, Mail Stop 160, Boise, ID, 83707-0015 (Phone: 208-396-6000)	

Limited Warranty for Toner Cartridge Life

Note

The warranty below applies to the toner cartridge that came with the product. This warranty supersedes all previous warranties. (7/16/96)

This HP Toner Cartridge is warranted to be free from defects in materials and workmanship for cartridge life until the HP toner is depleted. Your HP toner is depleted when your printer indicates a toner low message. HP will, at HP's option, either replace products which prove to be defective or refund your purchase price.

The warranty does not cover cartridges which have been refilled, are emptied, abused, misused, or tampered with in any way.

This limited warranty gives you specific legal rights. You may have other rights which vary from state to state, province to province, and country to country.

To the extent allowed by applicable law, in no event shall Hewlett-Packard Company be liable for any incidental, consequential, special, indirect, punitive, or exemplary damages or lost profits from any breach of this warranty or otherwise.

FCC regulations

This equipment has been tested and found to comply with the limits for a Class B digital device, pursuant to Part 15 of the FCC rules. These limits are designed to provide reasonable protection against harmful interference in a residential installation. This equipment generates, uses, and can radiate radio frequency energy. If it is not installed and used in accordance with the instructions, it may cause harmful interference to radio communications. However, there is no guarantee that interference will not occur in a particular installation. If this equipment does cause harmful interference to radio or television receptions, which can be determined by turning the equipment off and on, the user is encouraged to try to correct the interference by one or more of the following measures:

- Reorient or relocate the receiving antenna.
- Increase separation between equipment and receiver.
- Connect equipment to an outlet on a circuit different from that to which the receiver is located.
- Consult your dealer or an experienced radio/TV technician.

Note

Any changes or modifications to the printer that are not expressly approved by HP could void the user's authority to operate this equipment.

Use of a shielded interface cable is required to comply with the Class B limits of Part 15 of FCC rules.

Additional regulatory statements

See the online user guide for additional regulatory specifications and statements.



i n v e n t

Copyright© February 2001
Hewlett-Packard Co.

<http://www.hp.com/support/lj3200>

English



C7055-90910