

HP LaserJet 4100, 4100N, 4100TN, and 4100DTN Printers

English

Getting Started Guide

© Copyright Hewlett-Packard Company 2001

All Rights Reserved.
Reproduction, adaptation, or translation without prior written permission is prohibited, except as allowed under the copyright laws.

Publication number
C8049-90903

First Edition, February 2001

Warranty

The information contained in this document is subject to change without notice.

Hewlett-Packard makes no warranty of any kind with respect to this information. HEWLETT-PACKARD SPECIFICALLY DISCLAIMS THE IMPLIED WARRANTY OF MERCHANTABILITY AND FITNESS FOR A PARTICULAR PURPOSE.

Hewlett-Packard shall not be liable for any direct, indirect, incidental, consequential, or other damage alleged in connection with the furnishing or use of this information.

Trademark Credits

Adobe and PostScript are trademarks of Adobe Systems Incorporated which may be registered in certain jurisdictions.

Microsoft is a registered trademark of Microsoft Corporation.

FCC Statement

This equipment has been tested and found to comply with the limits for a Class B digital device, pursuant to Part 15 of the FCC rules. These limits are designed to provide reasonable protection against harmful interference in a residential installation. This equipment generates, uses, and can radiate radio frequency energy. If it is not installed and used in accordance with the instructions, it may cause harmful interference to radio communications. However, there is no guarantee that interference will not occur in a particular installation.

If this equipment does cause harmful interference to radio or television reception, which can be determined by turning the equipment off and on, the user is encouraged to try to correct the interference by one or more of the following measures:

- Reorient or relocate the receiving antenna.
- Increase separation between equipment and receiver.
- Connect equipment to an outlet on a circuit different from that to which the receiver is located.
- Consult your dealer or an experienced radio/TV technician.

Any changes or modifications to the printer that are not expressly approved by HP could void the user's authority to operate this equipment.

Use of a shielded interface cable is required to comply with the Class B limits of Part 15 of FCC rules.

See the online user guide for other regulatory information and product specifications.

1

Getting Started Guide

Getting Started

Introduction	1-5
Where to look for information	1-6
Installation checklist	1-8
Step 1: Check package contents.	1-9
Step 2: Remove internal packaging	1-10
Step 3: Prepare printer location.	1-12
Step 4: Locate printer parts	1-14
Step 5: Install accessories.	1-16
Step 6: Install the toner cartridge	1-17
Step 7: Load trays	1-18
Step 8: Attach the power cord	1-21
Step 9: Change the control panel language (optional)	1-22
Step 10: Test the printer	1-23
Step 11: Connect printer cables	1-24
Step 12: Install the printing software	1-27
Step 13: Verify printer setup	1-30
Step 14: Distribute software to network clients (optional)	1-31
Step 15: Install the software for network clients (optional)	1-32
Step 16: Access the user documentation	1-33

HP Customer Care

Find product support on the World Wide Web	1-35
Get answers through e-mail	1-35
Tools and documentation	1-35
Connect with other users online	1-36
We stay in touch	1-36
Web registration	1-36
HP SupportPack	1-36
Talk to a technical support agent	1-37

Quick Reference

Control panel	1-39
Printing tasks	1-49
Paper jams	1-52
Correcting output quality problems	1-58
About the toner cartridge.	1-67
Paper sizes supported.	1-69

Getting Started

This section of the guide contains information for unpacking and setting up the printer.

Introduction

Congratulations on your purchase of the HP LaserJet 4100 printer. The printer is available in four configurations:

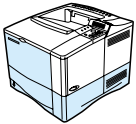

HP LaserJet 4100

- 16 MB RAM
- 100-sheet paper tray
- 500-sheet paper tray

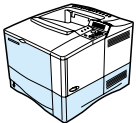

HP LaserJet 4100N

- 32 MB RAM
- HP JetDirect 10/100Base-TX print server card for network connection
- 100-sheet paper tray
- 500-sheet paper tray

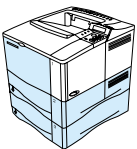

HP LaserJet 4100TN

- 32 MB RAM
- HP JetDirect 10/100Base-TX print server card for network connection
- 100-sheet paper tray
- two 500-sheet paper trays

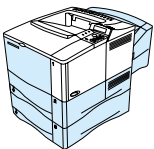

HP LaserJet 4100DTN

- 32 MB RAM
- HP JetDirect 10/100Base-TX print server card for network connection
- 100-sheet paper tray
- two 500-sheet paper trays
- duplex printing accessory (duplexer)

Where to look for information

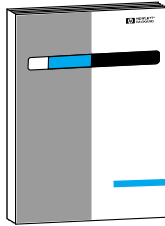

Getting Started Guide

Information for setting up your printer (Getting Started), as well as tips and quick information for using the printer (Quick Reference).



Online User Guide

Detailed information on using and troubleshooting the printer, available on the CD that came with the printer. If you would like a hard copy, print the user guide using your printer.



HP JetDirect Print Server Administrator's Guide

Information for configuring and troubleshooting the HP JetDirect print server, available on the CD that came with the printer.

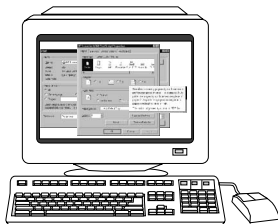

Online Help

Information on printer options that are available from within printer drivers. To view a Help file, access the online help through the printer driver.

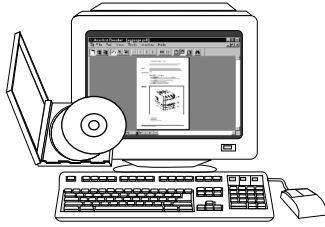

HP Fast InfraRed Receiver User Guide

Information on using and troubleshooting the HP Fast InfraRed Receiver.

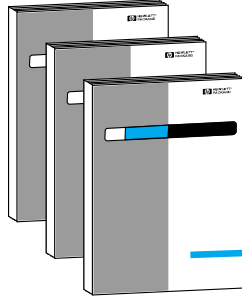

Accessory guides

Instructions for installing and using accessories or toner cartridges, included with the accessory.

Additional information is available on the World Wide Web at <http://www.hp.com/support/lj4100>.

Installation checklist

Follow the steps below to set up and install the printer.

- Step 1: Check package contents 1-9
- Step 2: Remove internal packaging 1-10
- Step 3: Prepare printer location 1-12
- Step 4: Locate printer parts 1-14
- Step 5: Install accessories 1-16
- Step 6: Install the toner cartridge 1-17
- Step 7: Load trays 1-18
- Step 8: Attach the power cord 1-21
- Step 9: Change the control panel language (optional). 1-22
- Step 10: Test the printer 1-23
- Step 11: Connect printer cables 1-24
- Step 12: Install the printing software 1-27
- Step 13: Verify printer setup 1-30
- Step 14: Distribute software to network clients (optional) 1-31
- Step 15: Install the software for network clients (optional). . . . 1-32
- Step 16: Access the user documentation 1-33

WARNING!

The printer is heavy. We recommend having two people move it.

Note

To learn about all the features and capabilities of the printer, see the online user guide (available on the CD that came with the printer) and the Help menus (in the printer driver online help).

Step 1: Check package contents

Printer

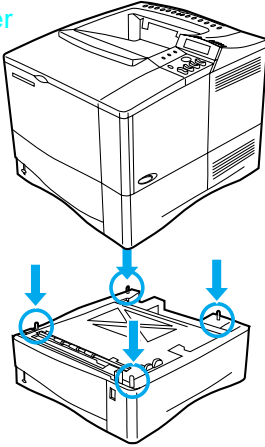

Second 500-sheet paper tray
(included with 4100TN and 4100DTN only)

Printer software and documentation

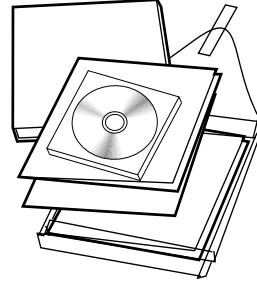

Duplexer (included with 4100DTN only)

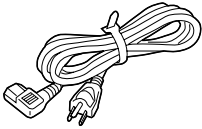

Power cord

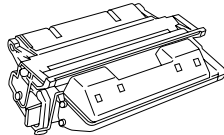

Toner cartridge

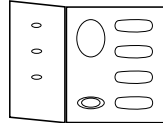

Control panel overlay
(might already be installed on printer)

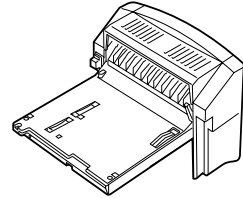

Note

An IEEE parallel cable is not included in the package contents. See the online user guide on the CD for ordering information.

Step 2: Remove internal packaging

1

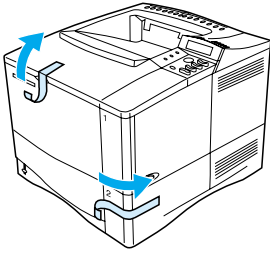

2

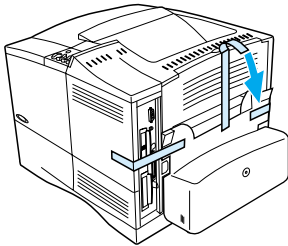

3

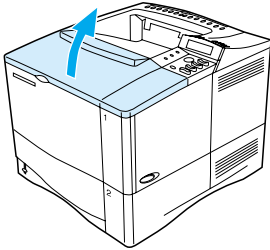

4

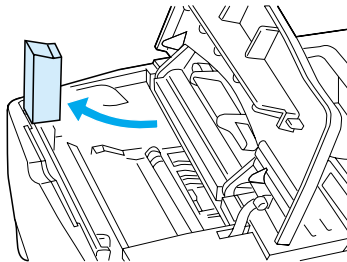

5

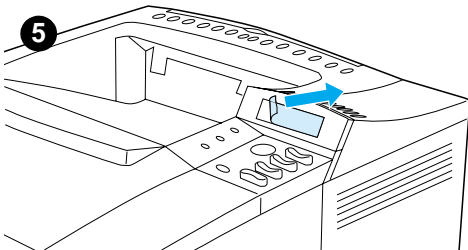

Note

Save all packaging material. You might need to repack the printer at a later date.

- 1 Remove the shipping bag and tape from the front of the printer.
- 2 Remove the tape from the back of the printer.
- 3 Open the top cover.
- 4 Remove the foam packing material from inside the toner cartridge cavity.
- 5 Remove the plastic film on the control panel display.

Continued on the next page.

6

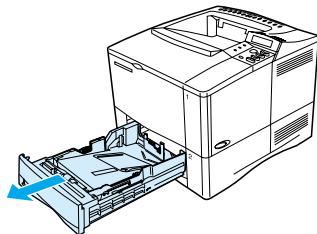

7

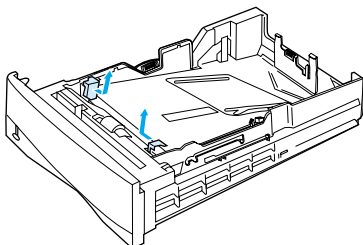

8

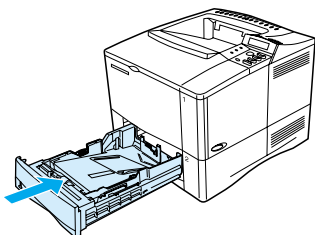

10

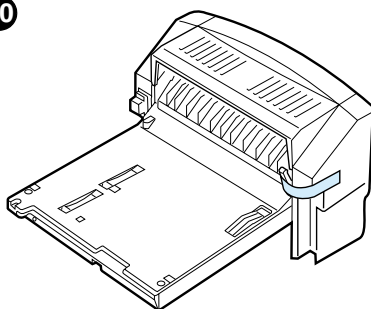

- 6 Slide tray 2 out of the printer.
- 7 Remove all packaging materials and any spacers from the tray.
- 8 Slide tray 2 back into the printer.
- 9 For 4100TN and 4100DTN models, repeat steps 6 through 8 for tray 3.
- 10 For the 4100DTN model, remove the duplexer from its shipping bag and then remove all tape from the duplexer.

Step 3: Prepare printer location

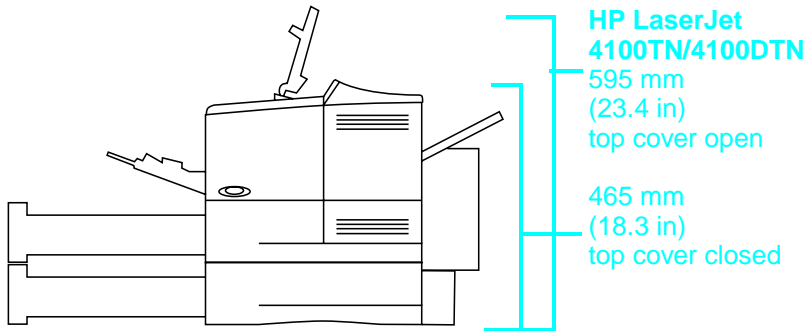
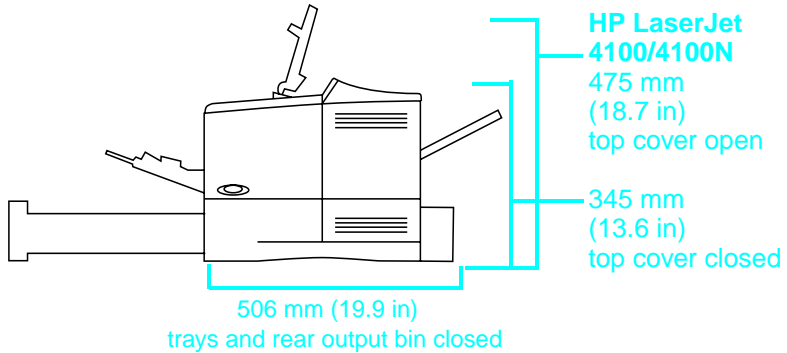
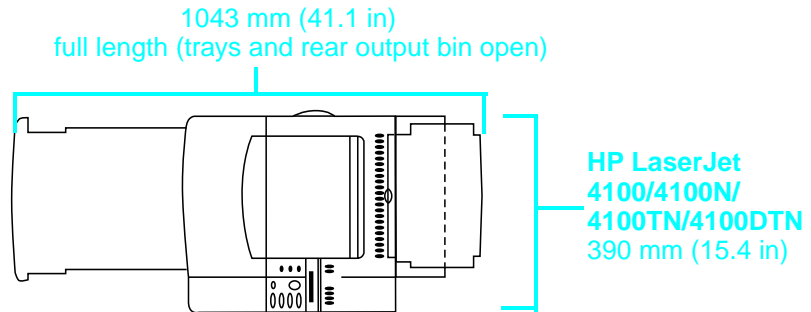

HP LaserJet 4100TN
trays and rear output bin closed 506 mm (19.9 in)

HP LaserJet 4100DTN
trays and rear output bin closed 565 mm (22.2 in)

Printer weights (without toner cartridge or paper installed)

HP LaserJet 4100/4100N printers	18 kg (39 lb)
HP LaserJet 4100TN printer	25 kg (55 lb)
HP LaserJet 4100DTN printer	28 kg (62 lb)

Location requirements for the printer

- Sturdy, level surface for placement
 - Space allowance around the printer
 - Well-ventilated room
 - No exposure to direct sunlight or chemicals, including ammonia-based cleaning solutions
 - Relative humidity 20% to 80%
 - Adequate power supply (100 to 127 V or 220 to 240 V line voltage, 50/60 Hz)
 - Stable environment—no abrupt temperature or humidity changes
 - Room temperature 50° to 91° F (10° to 32° C)
-

Step 4: Locate printer parts

Front view

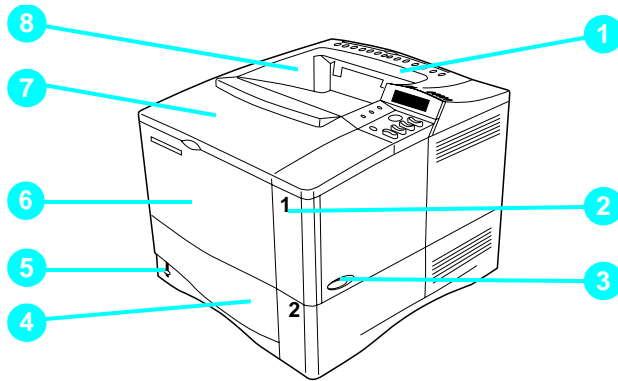

- 1 Control panel
- 2 Tray number
- 3 Power switch
- 4 Tray 2 (500-sheet)
- 5 Paper level indicator
- 6 Tray 1, closed (100-sheet)
- 7 Top cover (toner cartridge underneath)
- 8 Top output bin

Back view

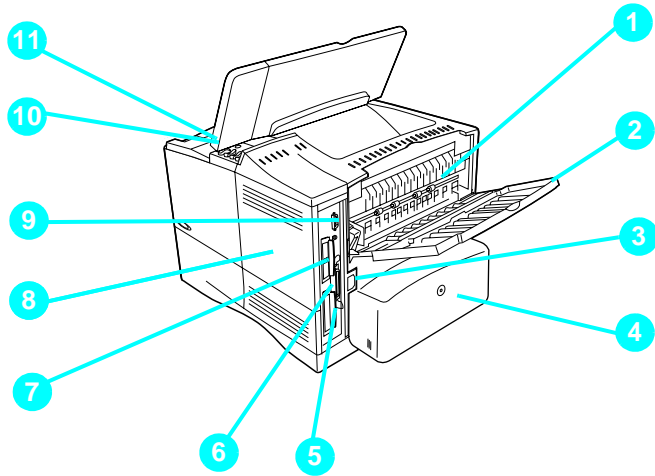

- 1 Fuser (can be removed to clear paper jams)
- 2 Rear output bin (straight-through paper path)
- 3 Power connector
- 4 Dust cover (tray 2 dust cover not installed if duplexer is installed)
- 5 Parallel interface port
- 6 Enhanced I/O (EIO) slots
- 7 Fast InfraRed (FIR) port for an optional FIR receiver
- 8 Memory access door (more than one DIMM can be installed)
- 9 Accessory interface port
- 10 Serial number and model number (under top cover)
- 11 Toner cartridge access (under top cover)

Step 5: Install accessories

Install any accessories that you have purchased with the printer. Use the separate installation instructions for the accessories.

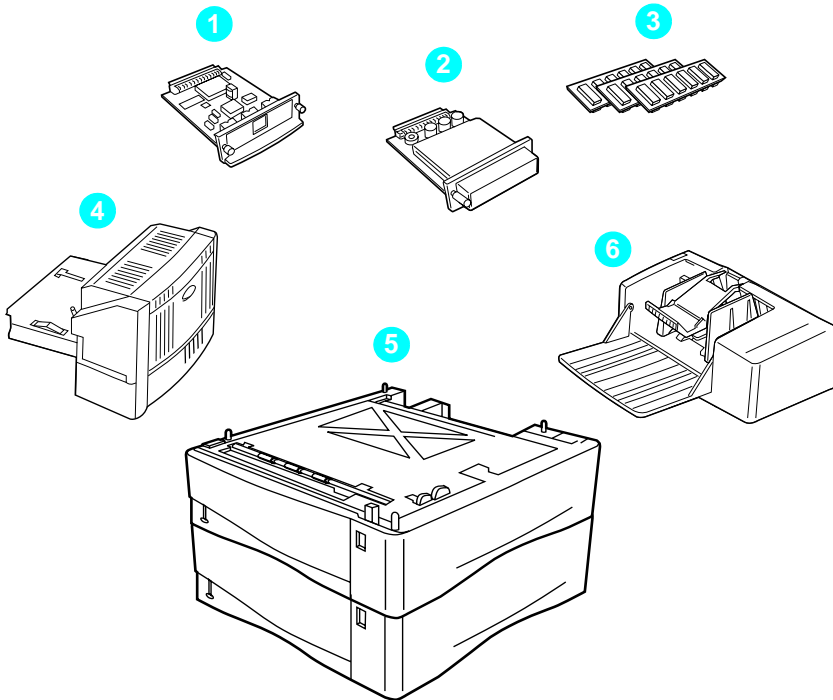

- 1 HP JetDirect print server (EIO card)
- 2 Hard disk accessory (EIO card)
- 3 Memory DIMM, flash DIMM, or font DIMM
- 4 Duplex printing accessory (duplexer), for 2-sided printing
- 5 Stackable 500-sheet paper tray (maximum of two, as shown here, for a total input capacity of 1,600 sheets)
- 6 Envelope feeder

Note

See the online user guide for information on ordering accessories.

Step 6: Install the toner cartridge

1

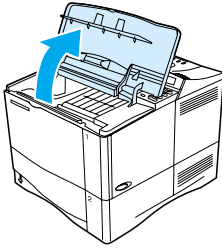

2

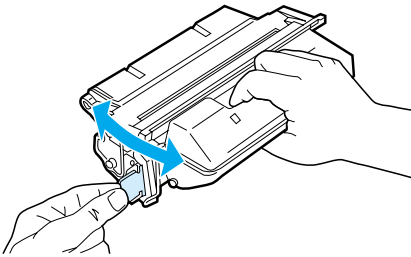

3

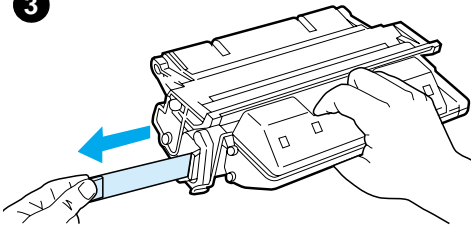

4

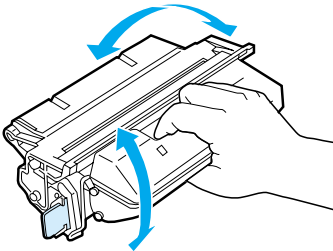

5

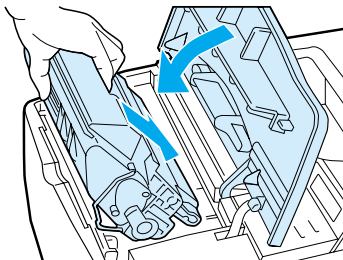

- 1 Remove the toner cartridge from its packaging (save packaging for possible cartridge storage). Open the printer by lifting the top cover.
- 2 Locate the sealing tape tab on the end of the cartridge. Carefully bend the tab back and forth until it separates from the cartridge.
- 3 Firmly pull the tab straight out from the toner cartridge to remove the entire length of tape (56 cm, or 22 in). Avoid touching any black toner on the tape.

Note

If the tab separates from the tape, grasp the tape and pull it out of the toner cartridge.

- 4 Gently shake the toner cartridge when installing it for the first time.
- 5 Position the toner cartridge as shown with the arrow pointing into the printer. Slide the toner cartridge into the printer as far as it will go.

If the toner cartridge is installed correctly, the top cover will close easily.

Note

If toner gets on your clothing, wipe it off with a dry cloth and wash clothing in cold water. (Hot water sets toner into fabric.)

Step 7: Load trays

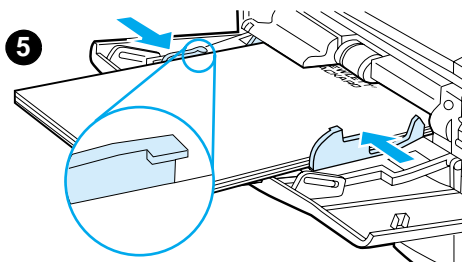
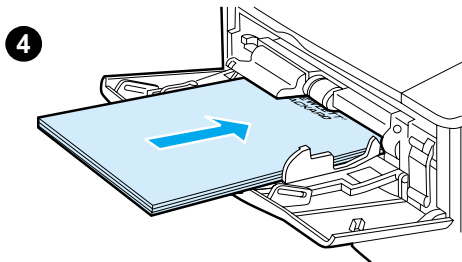
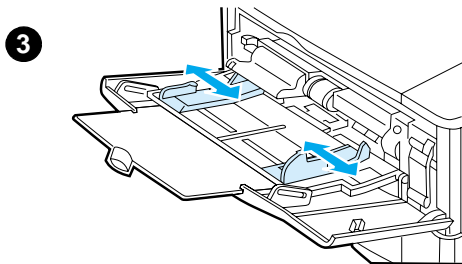
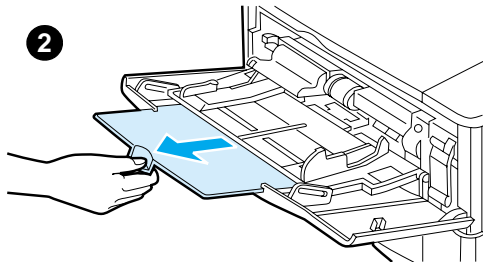
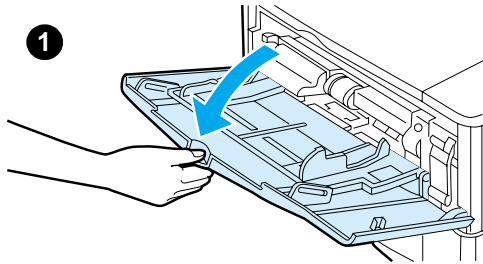

Loading tray 1

Tray 1 is a multi-purpose tray that holds up to 100 sheets of paper, 10 envelopes, or 20 index cards. The printer's default is to pull paper from tray 1 first. See the online user guide for information on how to change this default.

Tray 1 provides a convenient way to print envelopes, transparencies, custom-size paper, or other types of media without having to unload the other trays. It can also be used just as a convenient additional input tray.

Note

To avoid paper jams, do not load trays while the printer is printing.

- 1 Open tray 1.
- 2 Pull out the tray extension.
- 3 Set the side guides to the desired width.
- 4 Load paper in the tray.

Note

Make sure the paper fits under the tabs on the guides and not above the load level indicators.

Generally, load paper with the side to be printed up, and the top, short edge toward the printer.

- 5 Adjust the side guides so that they lightly touch the paper stack but do not bend the paper.

Loading trays 2, 3, and 4

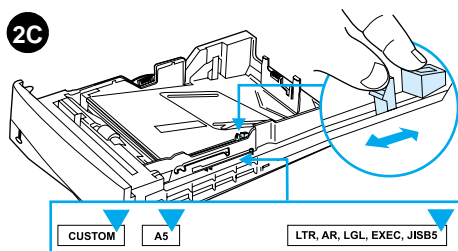
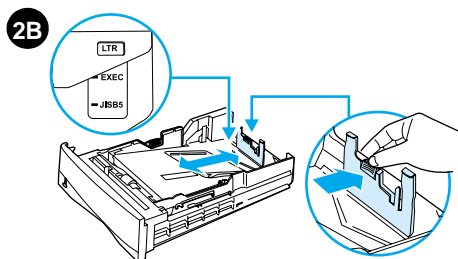
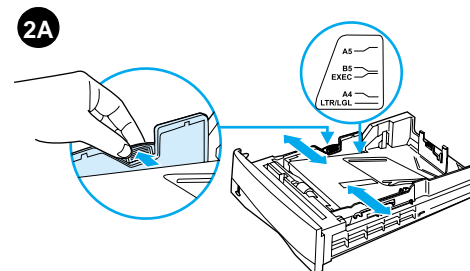
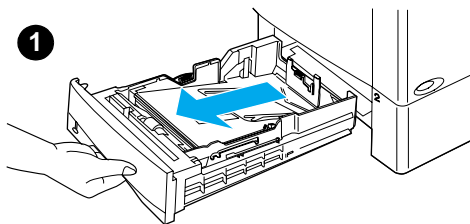

Trays 2, 3, and 4 are 500-sheet paper trays. Tray 3 is optional and comes with the 4100TN and 4100DTN models. Tray 4 is an additional 500-sheet option.

The trays adjust for six standard sizes of media, as well as for many custom sizes (see the online user guide for details). Three adjustments on the trays let the printer sense the paper size that is loaded.

Note

To avoid paper jams, do not load trays while the printer is printing.

- 1 Pull the tray completely out of the printer.
- 2 If the tray is not already set to the desired paper size, you will need to make up to three adjustments:

2A: To adjust the width, squeeze the lever on the left guide and slide the guides into place to match the width of the paper.

2B: To adjust the length, squeeze the lever on the rear paper guide and slide it to the desired paper size until it clicks into place. Standard sizes are labeled. For A5-size paper, lift the metal backstop near the center of the tray.

2C: To make the third adjustment, squeeze the blue tab located on the right side of the tray and move it to the correct position based on the paper size required.

Continued on the next page.

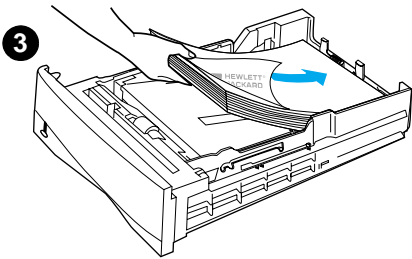

- 3 Load paper into the tray.
- 4 Make sure the paper is flat in the tray at all four corners and below the front and back tabs.
- 5 Slide the tray back into the printer.

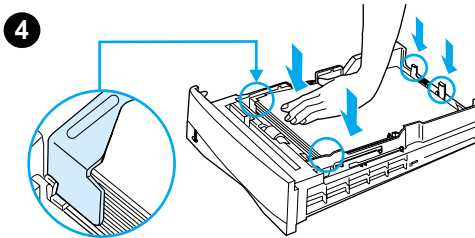

Note

If the tray is not properly adjusted, the printer might display an error message or paper might jam.

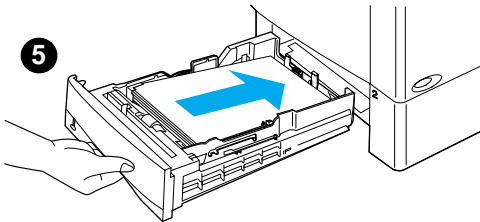

Step 8: Attach the power cord

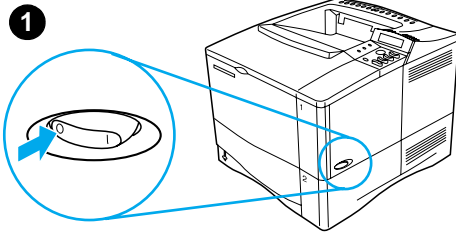

- 1 Locate the power switch on the right side of the printer. Make sure the printer is switched off.
- 2 Connect the power cord to the printer and a grounded power strip or an AC outlet.

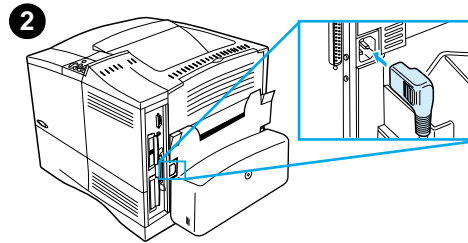

WARNING!

To prevent electric shock, connect the power cord only to a grounded outlet. Only use the power cord that came with the printer.

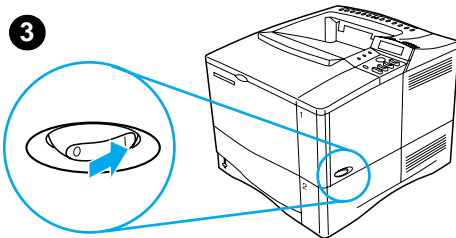

Note

If you have installed the optional duplexer, it will need to be pulled outward in order to connect the power cord. Push the duplexer back in before switching the printer on.

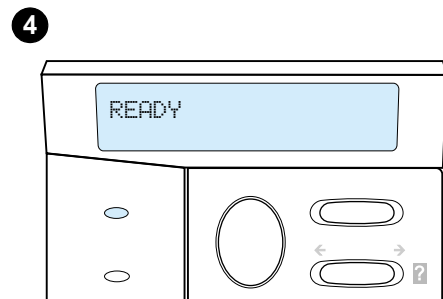

- 3 Switch the printer on.
- 4 After the printer warms up, the **READY** message should be visible on the control panel display and the **READY** light will remain on.

If the **READY** message does not appear, go to the problem-solving chapter in the online user guide.

Step 9: Change the control panel language (optional)

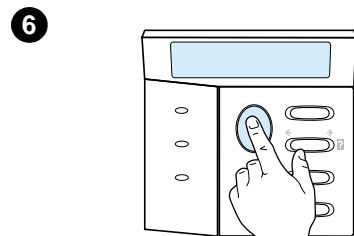
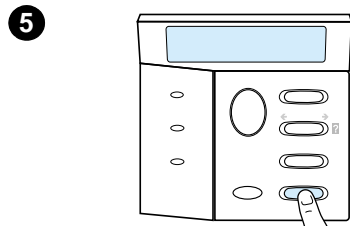
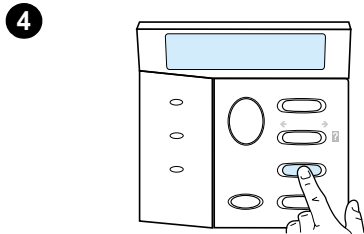
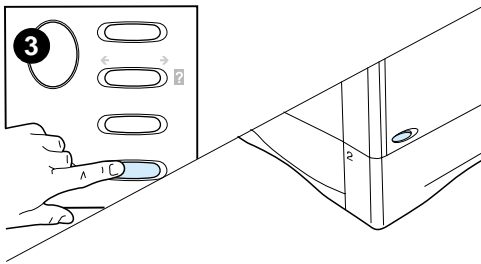
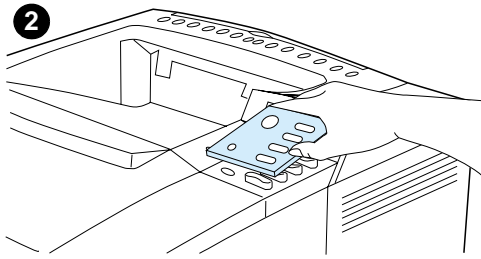

Follow these steps to change the control panel language from English to a language of your choice.

- 1 Turn the printer off.
- 2 If it is not already installed, place the control panel overlay (translated to your language) onto the control panel and snap it into place.
- 3 Hold down **SELECT** while switching the printer on until the message **SELECT LANGUAGE** briefly appears in the display. Then release **SELECT**. After warming up, the printer displays **LANGUAGE=ENGLISH**.
- 4 Press **- VALUE +** to scroll through the available display languages.
- 5 Press **SELECT** to save your display language as the new default. An asterisk appears in the right side of the display.
- 6 Press **GO** to return to a **READY** display message.

Step 10: Test the printer

1

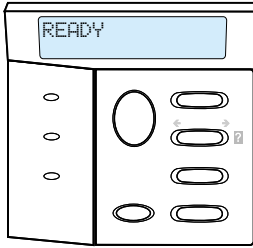

2

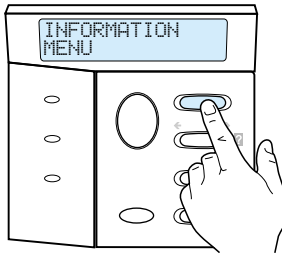

3

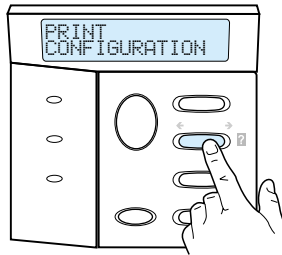

4

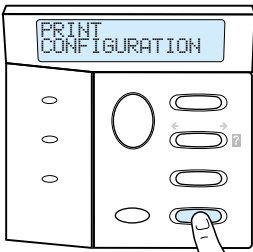

5

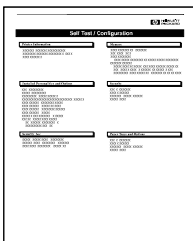

Before connecting the printer to a network or computer, print a configuration page to make sure the printer is operating correctly.

- 1 Make sure the printer is on and the READY message is displayed.
- 2 Press **MENU** until the display reads INFORMATION MENU.
- 3 Press **ITEM** until the display reads PRINT CONFIGURATION PAGE.
- 4 Press **SELECT** to print.
- 5 Look at the configuration page to see how the printer is configured.

Note

If an HP JetDirect print server is installed, an HP JetDirect configuration page will also print.

If the configuration page does not print correctly, see the problem-solving chapter in the online user guide.

Step 11: Connect printer cables

The printer includes several interface ports:

- IEEE-1284 parallel
- accessory port for optional paper handling accessories
- Fast infrared (FIR)
- Ethernet 10/100Base-TX (RJ-45)—standard on the HP LaserJet 4100N, 4100TN, and 4100DTN model printers

Note

An EIO serial port is not included, but you can install an EIO card serial port. See the online user guide for ordering information.

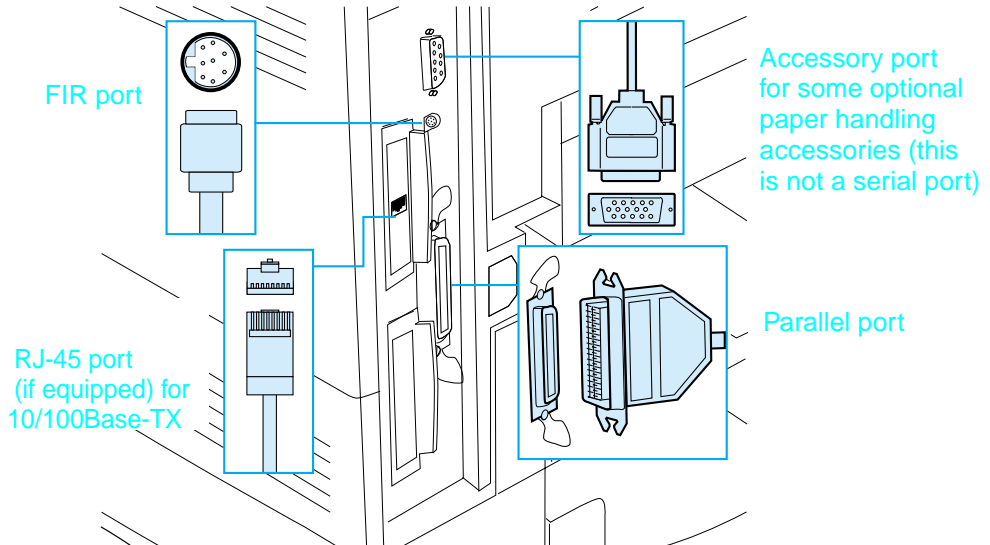

Connecting a parallel cable

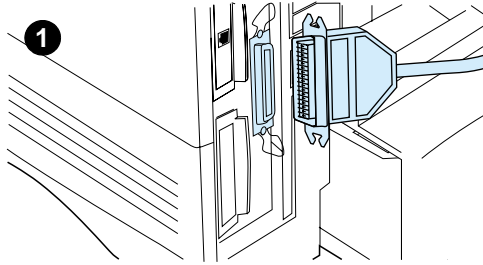

Use the parallel port when directly connecting the printer to a personal computer.

CAUTION

Make sure the printer is turned off before connecting the parallel cable.

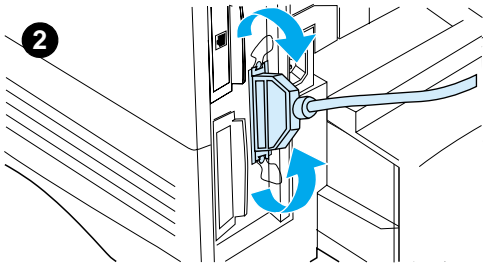

Note

To ensure reliability, use an IEEE-1284 compliant parallel cable (these cables are clearly marked with "IEEE-1284"). Only IEEE-1284 cables support all of the printer's advanced features.

- 1 Connect the parallel cable to the parallel port on the printer.
- 2 Snap the wire clips in place to secure the cable to the printer.

The cable should install easily. If installation is difficult, check the cable orientation.

- 3 Connect the other end of the cable to the parallel port on the computer.

Connecting to an Ethernet 10/100Base-TX network

Use the RJ-45 port to connect the printer to an Ethernet 10/100Base-TX network.

CAUTION

Make sure the printer is turned off before connecting to the RJ-45 port.

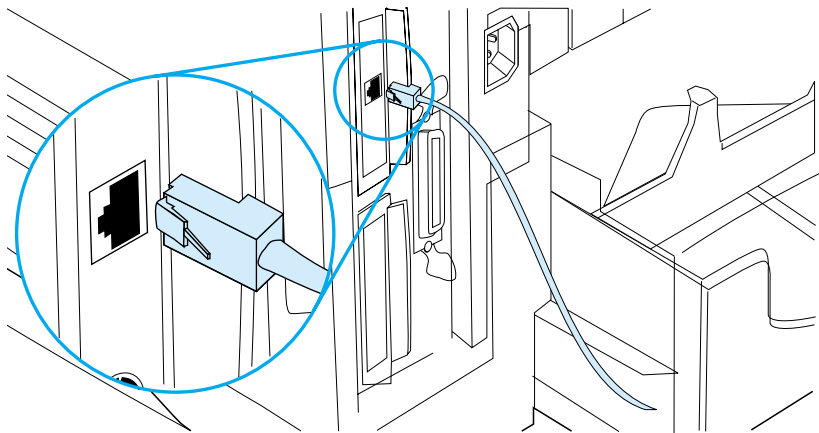

- 1 Connect a twisted-pair network cable to the RJ-45 port on the HP JetDirect 610N print server card.
- 2 Connect the other end of the cable to the network.

Note

For a successful link, either the 10 or 100 LED at the port should turn on when the printer is turned on. If the print server is unable to link to the network, see the problem-solving chapter in the online user guide.

Step 12: Install the printing software

The printer comes with printing software on a CD. The printer drivers on this CD must be installed to take full advantage of the printer features. If your computer does not have a CD drive, but you have access to one, you can copy the drivers onto diskettes for installation into your computer.

Depending on the configuration of Windows-driven computers, the installation program for the printer software automatically checks the computer for Internet access to obtain the latest software. The most recent drivers are also available at <http://www.hp.com/support/lj4100>.

If you have questions, see “HP Customer Care” on page 1-35. For more details, see the HP Customer Care Service and Support information in the online user guide.

Note

If the printing software does not allow installation on your network, see the *HP JetDirect Print Server Administrator's Guide*.

After installation, software must be configured to use accessories such as the duplexer, envelope feeder, and 500-sheet paper trays.

Installing Windows printing software

These installation instructions are for single users and network administrators. Procedures for installing the software vary according to operating system and network environment. Use the instructions below that best match your system and environment.

Windows

The setup software detects both the version of Windows that you are running and the language that is selected in your operating system. The setup software then installs printer drivers and software that are appropriate for your system.

- For single users, install the software on the computer that is connected to the printer.
- For Novell NetWare or Microsoft® networks, run the printer installation software. On NetWare networks, you will be able to set up the appropriate queues on the NetWare server and HP JetDirect print server. On IP networks, you can set up IP configuration parameters.
- For Windows NT 4.0 and Windows 2000 server networks, install the software on the server, then share the printer.

- 1 **Single user:** Log onto the computer that is connected to the printer.
- 2 **Network administrator:** Depending on your environment, log onto the network administrator workstation or onto the server with supervisor or administrative privileges.

Follow the steps below to install your printer software.

Windows 95, Windows 98, Windows NT 4.0, and Windows 2000

- 1 Close all running applications.
- 2 Insert the CD into the CD drive.

Note

If your computer is not configured to automatically start the CD, click **Start**, and then **Run**. Type `D:\Setup.exe` at the prompt and click **OK**.

- 3 Follow the instructions on the computer screen.

Windows 3.1x

Install both drivers and fonts from your CD.

- 1 Close all running applications.
- 2 Insert the CD into the CD drive.
- 3 From the Program Manager, select **Main**, select **Control Panel**, select **Printers**, and then select **Install**.
- 4 Follow the instructions on the screen to add a printer.
- 5 To install fonts, locate the appropriate font installer on the CD for your system and run it.

Note

For latest or additional drivers, go to <http://www.hp.com/support/lj4100> on the World Wide Web.

Installing Macintosh printing software

On a Macintosh-compatible computer, the installation procedures are the same for a network administrator, a network client, and a single user. Install the software on any computer that will be printing to the printer.

Note

If the computer is connected to the printer by a LocalTalk (Printer Port) or EtherNet connection, the AppleTalk (or Network) control panel must be configured for the correct connection to communicate with the printer.

The Macintosh partition on the CD contains an installer program for each available language. Find the language that is appropriate for your operating system, and then use the installer program for that language.

- 1 Quit all open applications.
- 2 Insert the CD into the CD drive.
- 3 Double-click the Installer icon and follow the instructions on the screen.
- 4 Open the **Chooser** from the **Apple** menu.
- 5 Click the **Apple LaserWriter 8** icon. If the icon is not there, contact your Macintosh dealer.
- 6 If you are on a network with multiple zones, select the zone in the **AppleTalk Zones** box where the printer is located. If this is unknown, ask your network administrator.
- 7 Double-click the desired printer. A **Desktop Printer** icon should appear.
- 8 Close the **Chooser** by clicking the go-away (close) box in the upper-left corner.

Step 13: Verify printer setup

The easiest way to verify that the software installation has been completed successfully is to print a document from a software application.

- 1 Load a software application of your choice and open or create a simple document.
- 2 Make sure the correct printer driver is selected.
- 3 Print the document.

If the document prints, installation is complete. If nothing printed, see the problem-solving chapter in the online user guide.

Step 14: Distribute software to network clients (optional)

Before a network client can print to the printer, the printing system software must be installed on the client workstation. Rather than distribute the contents of the CD to each client, you can place disk images of the installation software onto a public directory. The software's Customization Utility allows you to copy disk images only for Windows operating systems to a designated directory.

Creating disk images with the Installer's Customization Utility

- 1 Insert the CD into the CD drive.

Note

If AutoPlay does not automatically begin the installer program, click **Start** and then click **Run**. Type `D:\Setup.exe` at the prompt (this assumes your CD drive is the D: drive).

- 2 When prompted to choose the method of installation, click **Customization Utility**.
- 3 Select the language and operating system versions for which you want to create disk images, and then choose the drivers you want included in the disk images.
- 4 Assign a path to the drive and directory where you want to copy the disk images.
- 5 Follow the instructions on the screen.

Step 15: Install the software for network clients (optional)

Before a client can print to the printer, the printing system software must be installed on the client workstation. Procedures for installing the software vary, depending on the operating system you are using. Use the instructions below that apply to your operating system.

Windows

The procedures for installing end-user software on client workstations are similar to the installation procedures for network administrators.

- 1 Install the end-user software on client workstations by running Setup.exe.
- 2 Follow the instructions on the screen.

Note

To install the end-user software onto a Windows NT 4.0 or Windows 2000 workstation, you must have administrator privileges on that workstation.

Guidelines:

- Do not install the PCL driver or PostScript™ emulation driver(s) onto Windows NT workstations when you install other end-user software. Clear the **PCL and PostScript Driver** check boxes in the **Components** list during the **Custom Install**. The driver(s) will be installed from the server when you connect to the network printer.
- Users of a shared network version of Windows can install only the drivers that the network administrator installed during the network administrator installation.
- For a minimal install (driver only) in Windows 3.1x, install using the operating system.
- For a minimal install in Windows 9x, Windows NT 4.0, or Windows 2000, use the **Add Printer Wizard**.

Step 16: Access the user documentation

The CD also contains the online user guide, the *HP JetDirect Print Server Administrator's Guide*, the Adobe™ Acrobat Reader for the English language, and the *Fast Infrared Receiver User Guide*. This documentation can be viewed directly from the CD or loaded onto your computer.

Note

To view user documentation, your system must have Adobe Acrobat Reader installed.

Installing the Adobe Acrobat Reader from the CD

Windows 95, Windows 98, Windows NT 4.0, or Windows 2000

- 1 Double-click the **CD drive** icon from **My Computer**.
- 2 Double-click the **English** folder and then the **Adobe** folder. Double-click the folder for your operating system and run the executable. The English version of Acrobat Reader will be installed onto your hard drive.

Windows 3.1x

- 1 From the **Main Group Window**, double-click **File Manager**, and then double-click **CD drive**.
- 2 Double-click the **English** folder and then the **Adobe** folder. Double-click the folder for your operating system and run the executable. The English version of Acrobat Reader will be installed onto your hard drive.

Note

If you already have Adobe Acrobat Reader on your operating system and would like the newest version, or if you need a version other than English, go to <http://www.adobe.com> on the World Wide Web.

Viewing the user documentation from the CD

Windows 95, Windows 98, Windows NT 4.0, or Windows 2000

- 1 Insert the CD into the CD drive.

Note

If AutoPlay does not automatically begin the installer program, click **Start** and then click **Run**. Type `D:\Setup.exe` at the prompt (this assumes your CD drive is the D: drive).

- 2 Click **Documentation**.

Windows 3.1x

- 1 From the **Main Group Window**, double-click **File Manager**, and then double-click **CD drive**.
- 2 Double-click the preferred language.
- 3 Select the appropriate documentation folder.
- 4 Double-click the document to view.

HP Customer Care

Your HP LaserJet 4100 printer sets the standard for quality and reliability. Your purchase is backed by HP Customer Care, outstanding service, support, and online training.



Find product support on the World Wide Web

The web is a great place to learn more about the HP LaserJet 4100 printer. With just a few quick clicks, you will find updated software, tools, training material, and technical solutions. This service is available 24 hours a day, 7 days a week, free of charge. Find us on the World Wide Web at <http://www.hp.com/support/lj4100>.



Get answers through e-mail

Get one-to-one assistance. Send your e-mail questions by visiting our website at <http://www.hp.com/support/lj4100>.



Tools and documentation

We have designed a variety of informative tools to assist you with training and troubleshooting. You can locate these tools at <http://www.hp.com/support/lj4100>. From there, you can:

- use our “Troubleshooting Trees” to resolve questions or problems with printer operation
- download interactive training material, the latest versions of the printer manuals, or product data sheets
- use the virtual product to learn about the printer from the inside out



Connect with other users online

Go online to <http://www.hp.com/support/lj4100>, anytime, and you'll find other users with great ideas and suggestions for using your HP LaserJet 4100 printer at our online HP LaserJet 4100 printer user forum.



We stay in touch

When you sign up for Subscription Services, we will send you e-mail about topics of your choice, such as updated software, product announcements, and other important news about your HP LaserJet 4100 printer. Sign up online at <http://www.hp.com/support/lj4100>.



Web registration

Save yourself the time, trouble, and postage of filling out the registration card. Simply log on to <http://www.hp.com/support/lj4100> and complete your registration electronically. Using a simple form and step-by-step instructions, you can register your product within minutes. HP can inform you of product news, software updates, and other enhancements.



HP SupportPack

HP SupportPack is a packaged service agreement that upgrades your basic HP LaserJet product warranty (1 year), and extends coverage to 5 years.

The HP SupportPacks are sold by HP resellers and are available in either a shrink-wrap version for a 3-year service package only (you must register with HP to activate service) or an electronic version for a 1-, 2-, 3-, 4-, or 5-year service package (you can register by fax or on the World Wide Web).

For ordering and pricing details, contact your local HP reseller or visit our web site at <http://www.hp.com/go/printerservices> for more information.



Talk to a technical support agent

Call your local Customer Care Center to speak directly with a support agent who specializes in the HP LaserJet 4100 printer. Refer to the “Service and Support” chapter in the online user guide to find the phone number of the HP Customer Care Center nearest you. Be sure to have your product serial number ready before making the phone call.

Your product serial number is located on the inside top cover of the printer (example: USAB123456). Record your product serial number below for future reference and easy access.

Serial Number: _____

Quick Reference

This section of the guide contains tips and quick information on how to use the printer. See “Where to look for information” on page 1-6 for additional sources of information.

Control panel

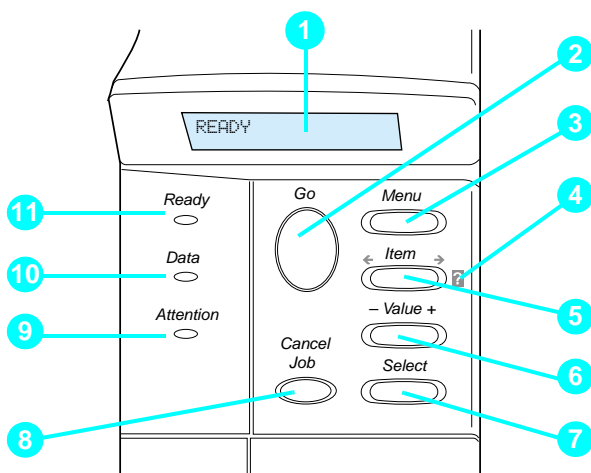

- 1 Displays printer messages
- 2 Places the printer online or offline, resumes printing, and exits menus
- 3 Cycles through menus
- 4 Displays available help messages
- 5 Cycles through items in a selected menu
- 6 Cycles through values in a selected menu item
- 7 Saves the control panel setting you have selected
- 8 Cancels the current print job
- 9 Lights when action is required (when lit, see the display message)
- 10 Lights when the printer is processing information (when lit, see the display message)
- 11 Lights when the printer is online and ready to print

Using the printer Help system

This printer features an online help system on the control panel that provides instructions for resolving most printer errors. Certain control panel messages alternate with instructions on accessing the online help system.

Whenever a **?** appears in an error message or the message alternates with `FOR HELP PRESS THE ? KEY`, press the right side of the **ITEM** key to navigate through a sequence of instructions.

Note

To exit the online help system, press either **GO** or **SELECT**.

Changing a control panel setting

Some menus and items are available only when certain accessories are installed or when certain features are activated. You can print a menu map at the printer using the steps on page 1-41.

- 1 Press **MENU** until the desired menu appears.
- 2 Press **ITEM** until the desired item appears.
- 3 Press **- VALUE +** until the desired setting appears.
- 4 Press **SELECT** to save the selection. An asterisk (*) appears beside the new setting.
- 5 Press **GO** to exit the menu.

Checking the printer configuration

From the printer, you can print the following information pages, which give details about the printer and its configuration:

- Menu map
- Configuration page
- PCL or PS font list
- Supplies status page

To print a menu map

- 1 Press **MENU** until INFORMATION MENU appears.
- 2 Press **ITEM** until PRINT MENU MAP appears.
- 3 Press **SELECT** to print the menu map.

To print a configuration page

- 1 Press **MENU** until INFORMATION MENU appears.
- 2 Press **ITEM** until PRINT CONFIGURATION appears.
- 3 Press **SELECT** to print the configuration page.

To print a PCL or PS font list

- 1 Press **MENU** until INFORMATION MENU appears.
- 2 Press **ITEM** until PRINT PCL FONT LIST or PRINT PS FONT LIST appears.
- 3 Press **SELECT** to print the font list.

To print a supplies status page

- 1 Press **MENU** until INFORMATION MENU appears.
- 2 Press **ITEM** until PRINT SUPPLIES STATUS PAGE appears.
- 3 Press **SELECT** to print the page.

Common printer messages

This table includes some of the most common printer messages. See the online user guide for a more complete list.

Common printer messages

Message	Explanation
ACCESS DENIED MENUS LOCKED	The printer control panel function you are trying to access has been locked to prevent unauthorized access. See your network administrator.
BAD DUPLEXER CONNECTION	The duplexer is not properly connected to the printer. Ensure that the right-angle power cord that shipped with the printer is being used. Try removing and reinstalling the duplexer. Then turn the printer off and back on.
BAD ENV FEEDER CONNECTION	The envelope feeder is not connected properly to the printer. Try removing and reinstalling the envelope feeder. Then turn the printer off and back on.
BAD OPT TRAY CONNECTION	There is a problem with an optional 500-sheet paper tray connection with the printer: <ul style="list-style-type: none">• the tray is not connected properly• more than two optional 500-sheet paper trays have been installed (the printer cannot support more than four trays total)• the electronics in the paper tray are faulty Try removing and reinstalling the paper tray. Then turn the printer off and back on.
CANNOT DUPLEX CLOSE REAR BIN	The printer cannot duplex because the rear output bin is open. Close the rear output bin.
CHECK INPUT DEVICE alternates with PAPER PATH OPEN PLEASE CLOSE IT	The optional input tray cannot feed paper to the printer because a door or paper guide is open. Check the doors and paper guides and close any that are open.
CHECK OUTPUT DEVICE alternates with CLOSE OUTPUT DELIVERY PATH	The optional output device is not properly connected to the printer. A proper connection must be made for printing to continue.
CHECKING PAPER PATH	The engine is checking for possible paper jams or paper that was not cleared from the printer.

Common printer messages (continued)

Message	Explanation
CLOSE TOP COVER	The top cover is open and must be closed for printing to continue.
ENV FEEDER LOAD [TYPE] [SIZE]	<p>A job has been sent to the envelope feeder and it is empty.</p> <p>Load the correct size and type in the feeder. Pressing GO will prompt a question asking if you would rather print on another available size of envelope in the printer. Press -VALUE+ to scroll through the available types and sizes; press SELECT to accept an alternate type or size.</p> <p>Make sure the envelope size and type are set correctly from the Paper Handling Menu in the printer control panel (see the description of the Paper Handling Menu in the online user guide).</p>
ENVELOPE FEEDER SIZE = [xxxxxx]	<p>The printer is asking what size of envelopes has been loaded in the envelope feeder. In response, you can take either of the following actions:</p> <ul style="list-style-type: none"> press SELECT to accept the current envelope size press -VALUE+ to change the size and then press SELECT to accept the new size <p>If you do not press any buttons, the message disappears in about 1 minute.</p> <p>Note</p> <p>Changing the size here changes the default for envelope size in the envelope feeder in the Paper Handling Menu (see the description of the Paper Handling Menu in the online user guide).</p>
ENVELOPE FEEDER TYPE = [xxxxxx]	<p>The printer has received a job under the following conditions:</p> <ul style="list-style-type: none"> the envelope type requested by the job is not available in the printer envelopes have just been placed in the envelope feeder (thus triggering the paper sensor) <p>You can take either of the following actions:</p> <ul style="list-style-type: none"> press SELECT to accept the paper type and then press GO press +VALUE- to change the type, press SELECT to accept the new type, and then press GO to continue
INPUT DEVICE CONDITION [xx.yy]	<p>An input paper handling device has a condition that needs attention before printing can resume.</p> <p>Turn the printer off.</p> <p>Disconnect the cable to the input paper handling devices and then reconnect it.</p> <p>Turn the printer on.</p> <p>See the documentation that came with the paper handling device for assistance.</p>
INSTALL TONER CARTRIDGE	The toner cartridge has been removed and must be reinstalled for printing to continue.

Common printer messages (continued)

Message	Explanation
INSTALL TRAY [x]	The specified tray is not installed and must be inserted and closed for printing to continue.
MANUALLY FEED [TYPE] [SIZE]	Load the requested paper into tray 1. Press Go if the desired paper is already loaded in tray 1.
NON HP TONER DETECTED alternates with PRESS GO TO CONTINUE	The printer has detected that the toner cartridge is not a genuine HP toner cartridge. If you believe you purchased an HP toner cartridge, call the HP fraud hotline (1-877-219-3183, toll-free in North America). Any printer repair required as a result of using non-HP toner is not covered under the printer warranty.
OFFLINE	Press Go to place the printer online.
OUTPUT BIN FULL alternates with CLEAR PAPER FROM [BINNAME]	The output bin is full and needs to be emptied.
PAPER WRAPPED AROUND FUSER	Turn the printer off to keep the paper from wrapping more firmly around the fuser. Open the top cover and remove the toner cartridge. Remove all visible paper. If you cannot locate the paper, leave printer turned off and remove the fuser to remove paper (see the online user guide for steps to clear fuser jams).
PERFORM PRINTER MAINTENANCE	To ensure optimum print quality, the printer prompts you to perform routine maintenance every 200,000 pages (see the online user guide for information on printer maintenance).
PROCESSING AUTO CLEANING PAGE	The printer is conducting the auto cleaning page process. This can take up to 2.5 minutes.
PROCESSING CLEANING PAGE	The printer is conducting the manual cleaning page process. This can take up to 2.5 minutes.
TONER LOW	<p>The message first appears when about 15% of the toner is remaining in the toner cartridge (about 1,500 pages remaining for the 10,000-page cartridge and about 900 pages remaining for the 6,000-page cartridge at 5% coverage). Depending on how the printer has been configured, it will either continue to print or stop.</p> <p>If the printer has stopped, you can resume printing by pressing Go for each job.</p> <p>You might want to ensure that you have a replacement toner cartridge on hand.</p> <p>See the online user guide for information on how to configure the printer's response to toner messages.</p>

Common printer messages (continued)

Message	Explanation
TONER OUT	<p>The toner cartridge has run out of toner. Depending on how the printer has been configured, it will either continue to print or stop.</p> <p>If the printer has stopped, you can resume printing by pressing Go for each job.</p> <p>Replace the toner cartridge.</p> <p>See the online user guide for information on how to configure the printer's response to toner messages.</p>
TRAY [x] EMPTY [TYPE] [SIZE]	<p>Load paper in the empty tray (x) to clear the message.</p> <p>If you do not load the specified tray, the printer will continue printing from the next tray with the same paper size, and the message will continue to appear.</p>
TRAY 1 LOAD [TYPE] [SIZE]	<p>This message occurs for the following reasons:</p> <ul style="list-style-type: none"> • tray 1 was requested from the application, but the tray is empty • the printer cannot find the requested size of paper in the printer <p>If the correct paper size is loaded, the adjustments to the tray have not been set correctly, either in the control panel or on the tray itself. To set adjustments on the tray, see "Loading tray 1" on page 1-49.</p> <p>Load the requested paper into tray 1, or press SELECT to override the message and print on a loaded paper size.</p> <p>If printing does not continue, press Go.</p> <p>If you are trying to print A4- or letter-size paper and this message appears, make sure the default paper size is set correctly from the Printing Menu in the printer control panel and also in the software program (see the description of the Printing Menu in the online user guide).</p> <p>Press Go to print from the next available tray.</p> <p>Press -VALUE+ to scroll through the available types and sizes.</p> <p>Press SELECT to accept the alternate type or size.</p>

Common printer messages (continued)

Message	Explanation
TRAY [x] LOAD [TYPE] [SIZE] where x is tray 2, 3, or 4	<p>This message occurs for the following reasons:</p> <ul style="list-style-type: none">• tray 2, 3, or 4 was requested, but the tray is empty• tray 2, 3, or 4 was requested, but the adjustments are not set for the requested type of size <p>Make sure that all three paper size adjustments have been made (see the explanation of adjustments in “Loading trays 2, 3, and 4” on page 1-50). Also make sure that the type has been set at the control panel (see the description of the Paper Handling Menu in the online user guide).</p> <p>Load the requested paper into an indicated tray, or press SELECT to override the message and print on a loaded paper size.</p> <p>If printing does not continue, press Go.</p> <p>If you are trying to print A4- or letter-size paper and this message appears, make sure the default paper size is set correctly from the Printing Menu in the printer control panel and also in the software program (see the description of the Printing Menu in the online user guide).</p> <p>Press Go to print from the next available tray.</p> <p>Press -VALUE+ to scroll through the available types and sizes.</p> <p>Press SELECT to accept the alternate type or size.</p>
TRAY 1 SIZE = [xxxx]	<p>The printer is asking what size of paper has been loaded in tray 1. In response, you can take either of the following actions:</p> <ul style="list-style-type: none">• press SELECT to accept the paper size• press -VALUE+ to change the size and then press SELECT to accept the new size <p>The printer will first display the TRAY 1 TYPE =xxxx message (see the description of that message). If you do not press any buttons in the timeout period (about 1 minute), it displays this TRAY 1 SIZE=xxxx message.</p> <p>Note</p> <p>Changing the size here changes the default for tray 1 paper size in the Paper Handling Menu (see the description of the Paper Handling Menu in the online user guide).</p>

Common printer messages (continued)

Message	Explanation
TRAY 1 TYPE = [xxxx]	<p>The printer has received a job under the three following conditions:</p> <ul style="list-style-type: none"> the paper type requested by the job is not available in the printer tray 1 has been set for CASSETTE paper has been placed in tray 1 (thus triggering tray 1's paper sensor) <p>If you do not press any buttons, the message disappears in about 1 minute). You can take either of the following actions:</p> <ul style="list-style-type: none"> press SELECT to accept the paper type press -VALUE+ to change the type and then press SELECT to accept the new type <p>Note Changing the type here changes the default for tray 1 paper type in the Paper Handling Menu (see the description of the Paper Handling Menu in the online user guide).</p> <p>If you do not do anything during the timeout period (about 1 minute), the printer will print on the paper in tray 1. It will also change the default for tray 1 paper type in the Paper Handling Menu to the type requested by the application that sent the job.</p>
USE [TYPE] [SIZE] INSTEAD?	<p>If the requested paper size or type is not available, the printer asks if it should use another paper size or type instead.</p> <p>Press -VALUE+ to scroll through the available types and sizes. Press SELECT to accept the alternate type or size.</p>
xx.yy PRINTER ERROR PRESS GO TO CONTINUE	<p>A printer error has occurred that can be cleared by pressing Go in the printer control panel.</p>
13.x PAPER JAM [LOCATION]	<p>Paper has either jammed in the printer or has been caught in a paper tray.</p> <ol style="list-style-type: none"> Open the top cover or tray indicated by the message. Clear all paper from the area. If necessary, remove the toner cartridge, duplexer, or paper trays. If the message persists, check for paper in all other areas. <p>Caution Ensure that all jammed paper is removed before closing the cover or tray. Open and close the top cover to clear the message. See "Paper jams" on page 1-52 for more detailed information.</p>

Common printer messages (continued)

Message	Explanation
41.3 UNEXPECTED PAPER SIZE alternates with EXPECTED [TYPE] [SIZE]	<p>The printer detected a paper size different than what it was expecting. This is typically caused if two or more sheets stick together in the printer or if the paper tray is not properly adjusted.</p> <p>Reload the tray with the correct paper size.</p> <p>Ensure that paper in the tray is loaded under the front and back tabs.</p> <p>If you are printing from tray 1, verify that the correct paper size is selected in the control panel (see the description of the Paper Handling Menu in the online user guide).</p> <p>If you are printing from tray 2, 3, or 4, verify that the three paper size adjustments on the paper tray have been made correctly (see the description of adjustments in “Loading trays 2, 3, and 4” on page 1-19).</p> <p>After performing the actions above, press Go. The page containing the error will automatically be reprinted if jam recovery is enabled. (Or, you might want to press CANCEL JOB to clear the job from the printer’s memory.)</p>
41.x PRINTER ERROR alternates with PRESS GO TO CONTINUE	<p>A temporary printing error occurred.</p> <p>Press Go. The page containing the error will automatically be reprinted if jam recovery is enabled.</p> <p>If the error does not clear, turn the printer off, then turn the printer on.</p>
54.1 REMOVE SEALING TAPE alternates with FROM TONER CARTRIDGE	<p>The toner cartridge has been installed without removing the sealing tape.</p> <p>Open the top cover and remove the toner cartridge. Pull the sealing tape tab to remove the strip. Reinstall the toner cartridge and close the top cover.</p>

See the online user guide for complete information about loading and orienting paper for duplexing.

Loading tray 1

Note To avoid paper jams, do not load trays while the printer is printing.

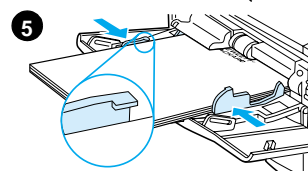
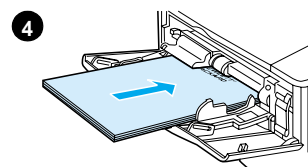
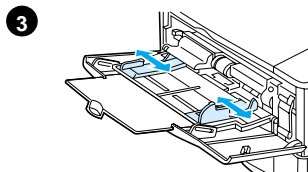
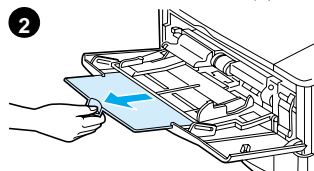
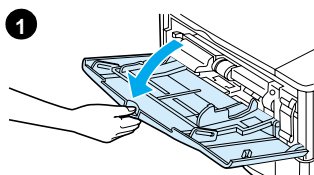

Letterhead/prepunched

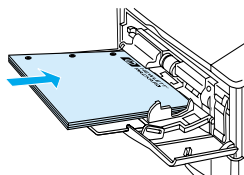

Transparencies

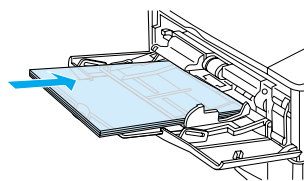

Envelopes

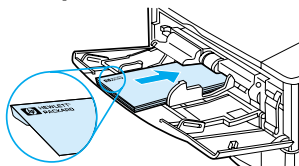

Card stock/custom sizes

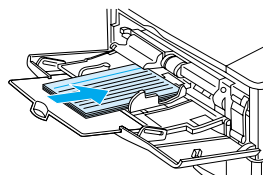

Labels

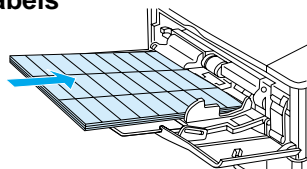

Loading trays 2, 3, and 4

Note

Trays 2, 3, and 4 are 500-sheet paper trays. Tray 3 is optional and comes with the 4100TN and 4100DTN models only. Tray 4 is an additional 500-sheet option.

The trays adjust for six standard sizes of media as well as for many custom sizes. See the online user guide for details.

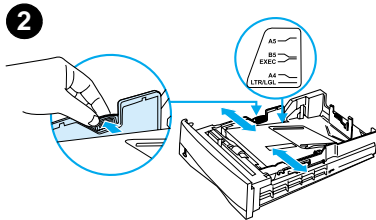
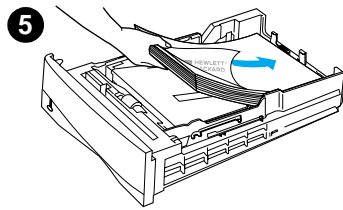
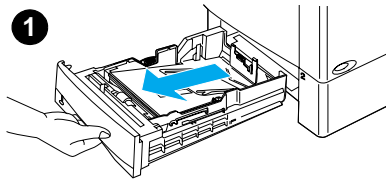

Note Make sure paper is under the front and back tabs to avoid paper jams.

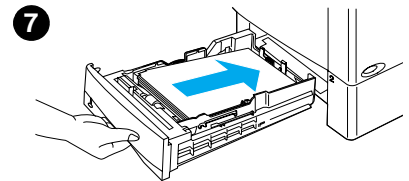
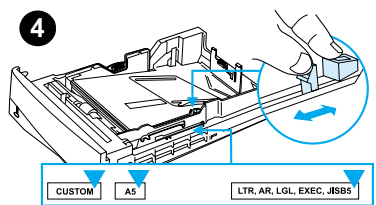
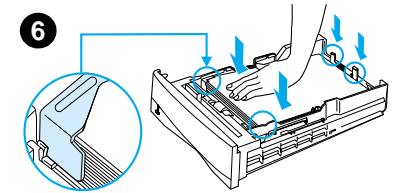
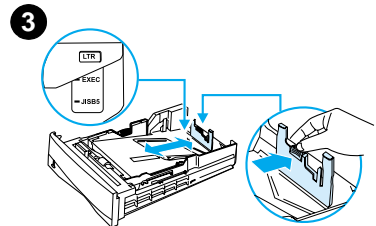

Loading envelopes in the envelope feeder

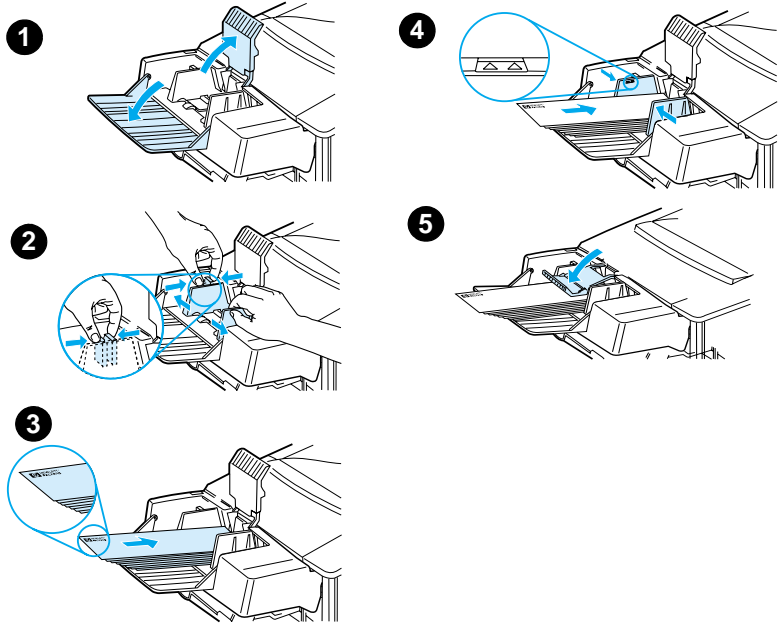

Selecting the output bin

Top
output
bin

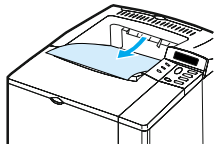

Rear
output
bin

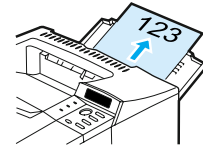

Use the top output bin when printing the following:

- most typical print jobs
- transparencies

Opening the rear output bin might improve results with the following:

- envelopes
- labels
- small custom-size paper
- postcards
- heavy paper

Paper jams

Locations

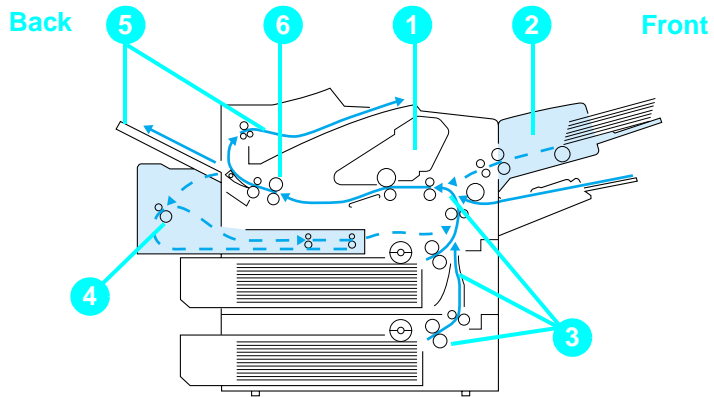

- 1 Top cover and toner cartridge area
- 2 Optional envelope feeder
- 3 Input tray areas
- 4 Optional duplexer
- 5 Output areas (top and rear)
- 6 Fuser area

Clearing top cover and toner cartridge areas

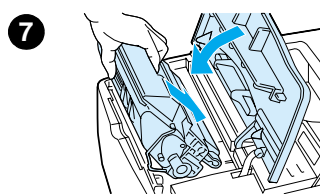
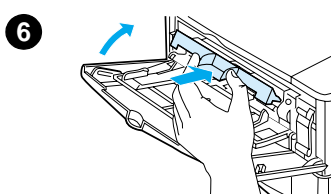
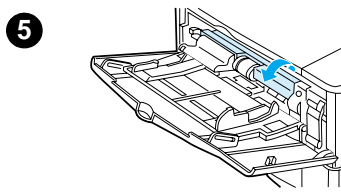
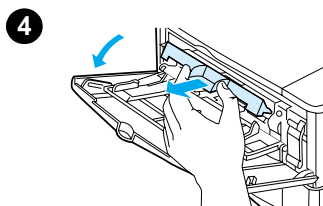
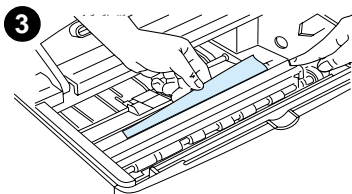
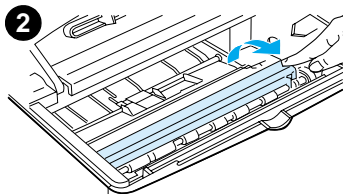
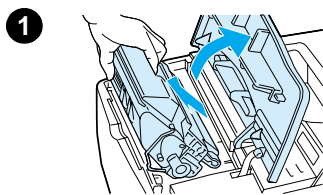

Clearing the optional envelope feeder

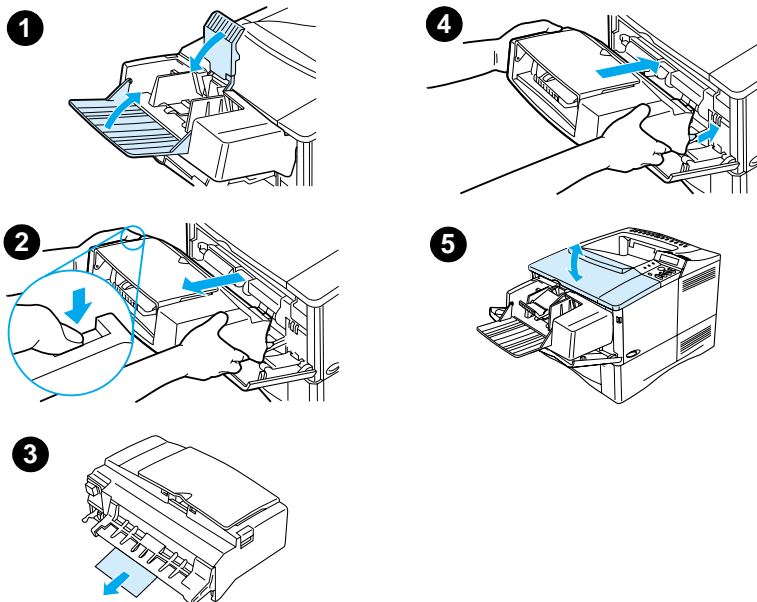

Clearing input tray areas

Trays 2, 3, and 4

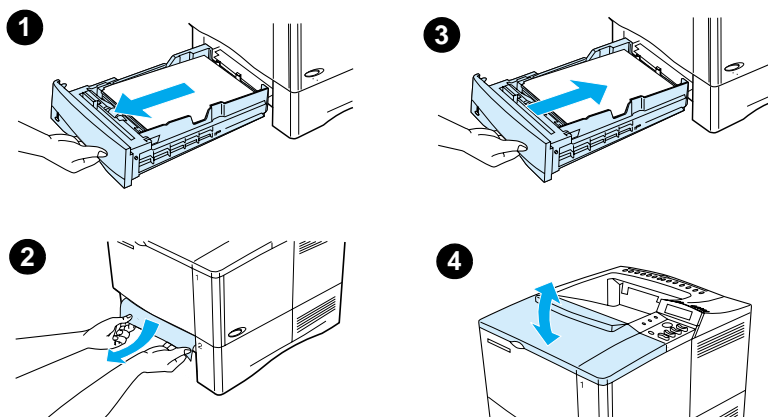

Clearing the optional duplexer

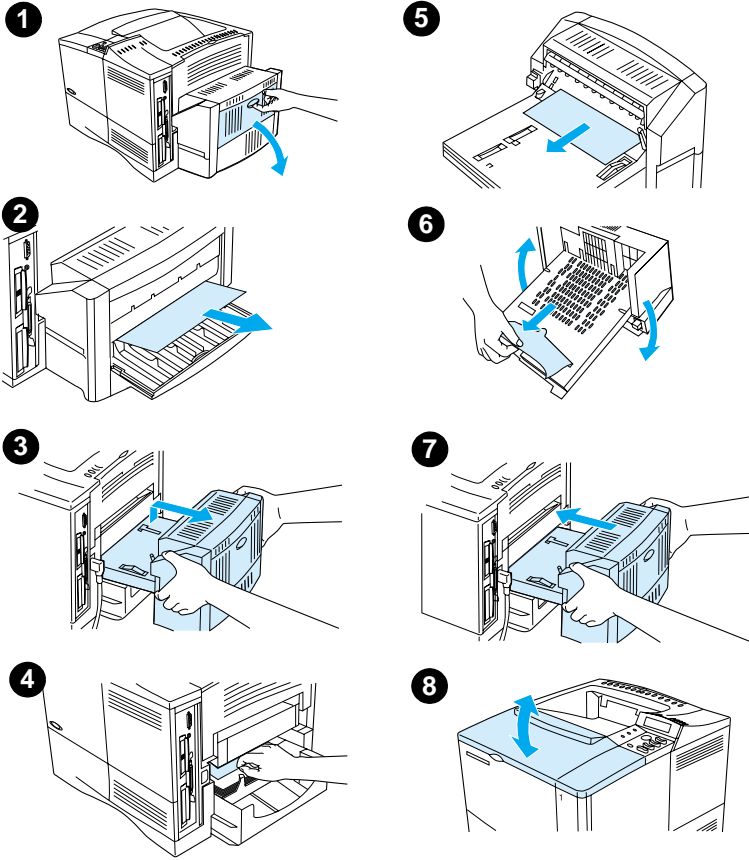

Clearing output areas

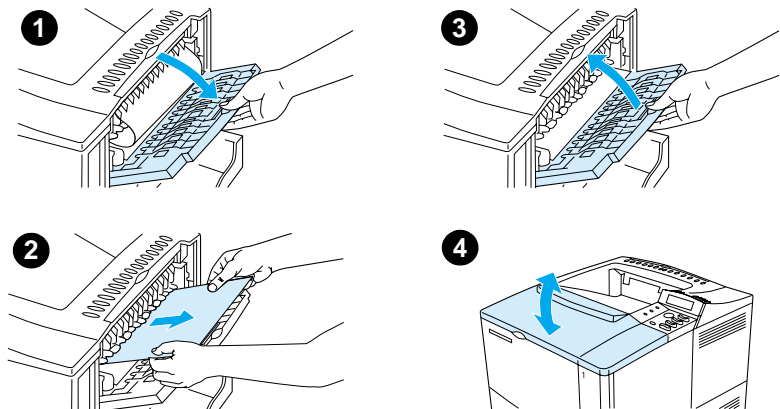

Clearing the fuser area

Use this procedure when paper has jammed inside the printer and cannot otherwise be removed, or when a page has torn while you were trying to clear a jam from the fuser.

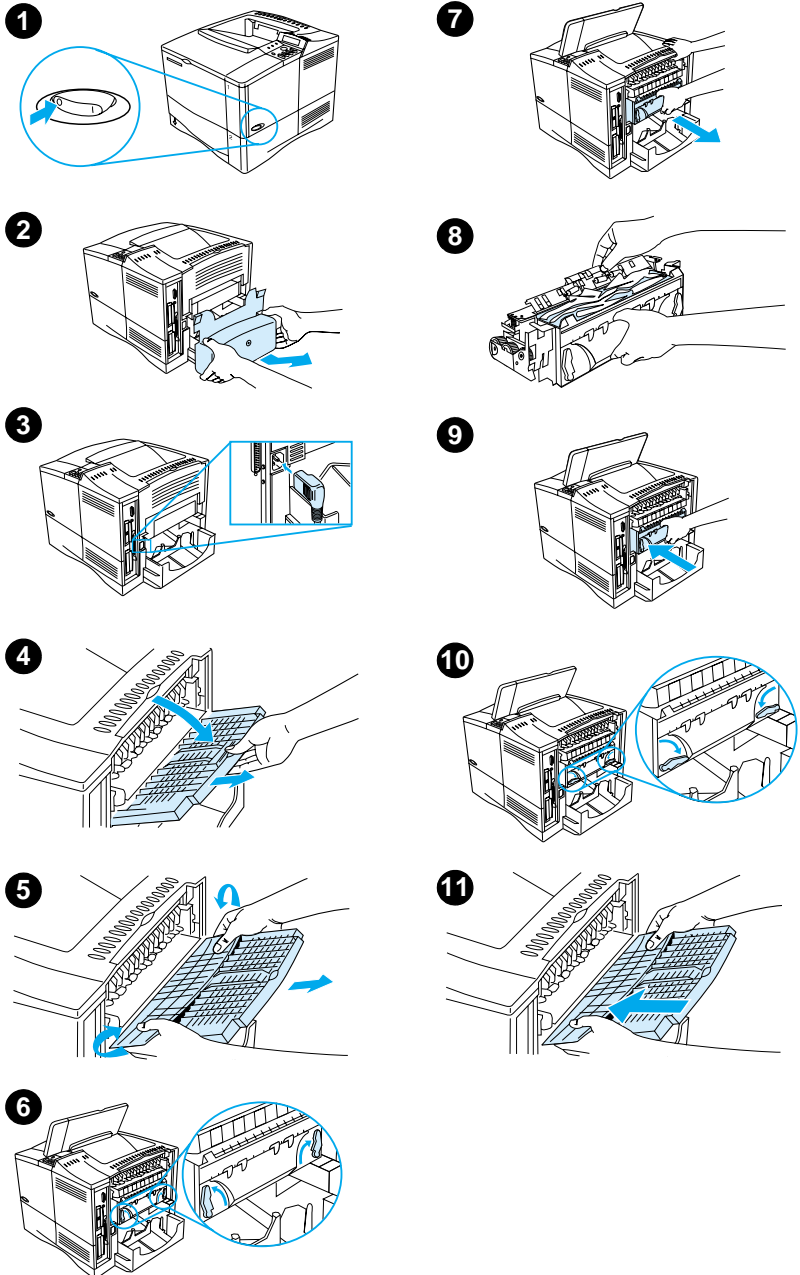

Solving repeated paper jams

- Check all the paper jam locations (see “Paper jams” on page 1-52). A piece of paper might be stuck somewhere in the printer. Even a small torn piece of paper in the printer path can cause repeated jams.
- If using a duplexer, check all areas (including under the duplexer).
- Check that paper is correctly loaded in the trays, that all three adjustments have been made, and that the trays are not overfilled. Make sure paper is under the front and back tabs. See the sections on loading paper (pages 1-18 and 1-19).
- Check that all trays and paper handling accessories are completely inserted into the printer. (If a tray is opened during a print job, this might cause a paper jam.)
- Check that all covers and doors are closed. (If a cover or door is opened during a print job, this might cause a paper jam.)
- Try printing to a different output bin.
- The sheets might be sticking together. Try bending the stack to separate each sheet. Do not fan the stack.
- If you are printing from tray 1, try reducing the size of the stack.
- If printing from the envelope feeder, make sure it is loaded correctly, pushing the bottom envelopes in slightly farther than the top envelopes.
- If you are printing small sizes, feed paper short edge first.
- Turn over the stack of paper in the tray. Also try rotating the paper 180°.
- Check the characteristics of the media you are using. Use only paper that meets HP specifications (see the online user guide for paper specifications). Try using different paper to see if the problem goes away. Do not use curled, deformed, damaged, or irregular paper.
- Avoid using paper that has already been used in a printer or copier.
- Do not print on both sides of envelopes or transparencies.
- Print only on full sheets of labels and do not print on both sides of label sheets.
- Check that the power supplied to the printer is steady and meets printer specifications (see the online user guide for printer specifications).
- Clean the printer (see the online user guide procedures).
- Perform preventative printer maintenance if maintenance is due (see the online user guide for details).

Correcting output quality problems

This section of the manual helps you define print quality problems and what to do to correct them. Often output quality problems can be handled quite easily by making sure that your printer is properly maintained, using media that meets HP specifications, or running a cleaning page.

Use the examples in the image defect table starting on this page to determine which output quality problem you are experiencing, then see the corresponding reference pages to troubleshoot. These examples consist of the most common methods to remedy print quality problems. If you still have problems after trying the suggested remedies, see “HP Customer Care” on page 1-35.

Note

The examples below depict letter-size paper that has passed through the printer short-edge first.

Image defect table







 <p>See “Light print (partial page)” on page 1-60</p>	 <p>See “Light print (entire page)” on page 1-60</p>	 <p>See “Specks” on page 1-60</p>	 <p>See “Specks” on page 1-60</p>
 <p>See “Dropouts” on page 1-61</p>	 <p>See “Dropouts” on page 1-61</p>	 <p>See “Dropouts” on page 1-61</p>	 <p>See “Lines” on page 1-61</p>

Image defect table (continued)

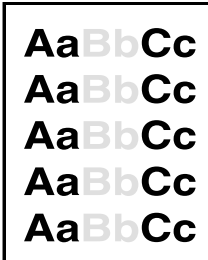
 <p>See "Gray background" on page 1-62</p>	 <p>See "Toner smear" on page 1-62</p>	 <p>See "Loose toner" on page 1-63</p>	 <p>See "Repeating defects" on page 1-63</p>
 <p>See "Repeating image" on page 1-64</p>	 <p>See "Misformed characters" on page 1-64</p>	 <p>See "Page skew" on page 1-64</p>	 <p>See "Curl or wave" on page 1-65</p>
 <p>See "Wrinkles or creases" on page 1-65</p>	 <p>See "Vertical white lines" on page 1-65</p>	 <p>See "Tire tracks" on page 1-66</p>	 <p>See "White spots on black" on page 1-66</p>

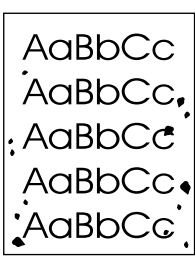
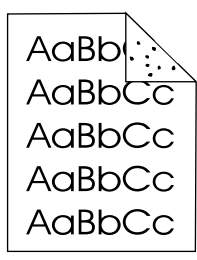
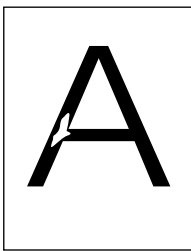
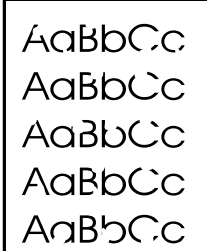
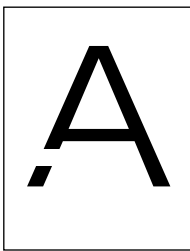
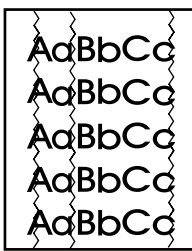

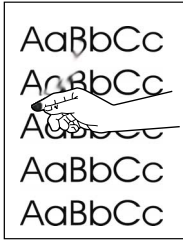
Light print (partial page)

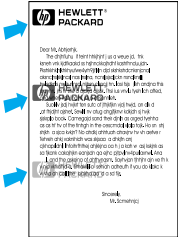
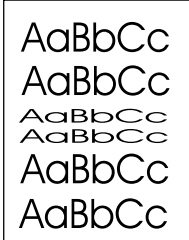
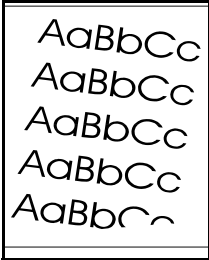
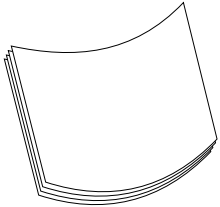
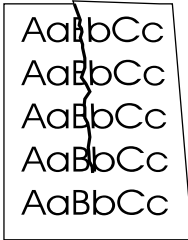
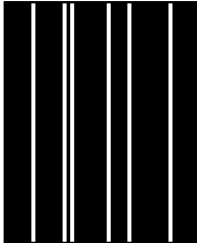
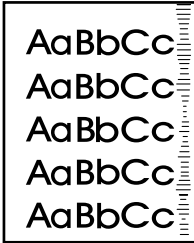
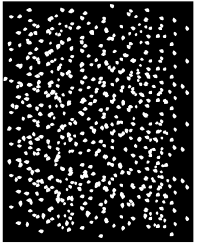
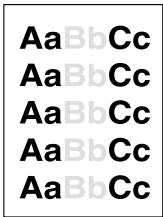
- 1 The toner cartridge might be low. Replace the toner cartridge.
- 2 Maintenance might be due. Check this by printing a copy of the supplies status page (see the online user guide). If maintenance is due, order and install the printer maintenance kit (see the online user guide).
- 3 The toner cartridge might be almost empty. Replace the toner cartridge.



Light print (entire page)

- 1 At the printer control panel, use the Print Quality Menu to turn EconoMode off (see the online user guide for details).
- 2 At the printer control panel, use the Print Quality Menu to increase the toner density setting (see the online user guide for details).
- 3 Try using a different type of paper.
- 4 The toner cartridge might be almost empty. Replace the toner cartridge.

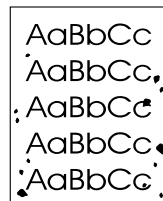

Specks

Specks might appear on a page after a jam has been cleared.

- 1 Print a few more pages to see if the problem corrects itself.
- 2 If specks occur frequently, set your printer up to automatically run a cleaning page (see the online user guide for details).
- 3 Clean the inside of the printer and run a manual cleaning page to clean the fuser (see the online user guide for cleaning details).
- 4 Try using a different type of paper.
- 5 Check for toner cartridge leaks. If the toner cartridge is leaking, replace it.

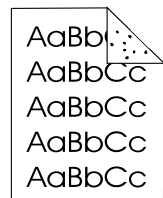



Dropouts

- 1 Make sure that the environmental specifications for the printer are being met (see the online user guide for printer specifications).
- 2 If the paper is rough and the toner easily rubs off, either try changing the fuser mode to High 1 or High 2 (see the description of the Paper Handling Menu in the online user guide), or try using a smoother paper.
- 3 Try changing to a different paper type.

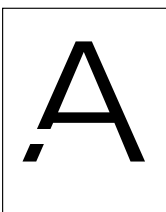

Lines

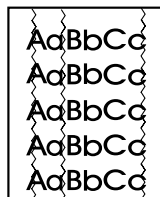

- 1 Print a few more pages to see if the problem corrects itself.
- 2 Clean the inside of the printer and run a manual cleaning page to clean the fuser (see the online user guide for cleaning procedures).
- 3 Replace the toner cartridge.
- 4 Maintenance might be due. Check this by printing a copy of the supplies status page. If maintenance is due, order and install the printer maintenance kit (see the online user guide for details).

AaBbCc
AaBbCc
AaBbCc
AaBbCc
AaBbCc

Gray background

- 1 Do not use paper that has already been run through the printer.
- 2 Print a few more pages to see if the problem corrects itself.
- 3 Turn over the stack of paper in the tray. Also, try rotating the paper 180°.
- 4 At the printer control panel, use the Print Quality Menu to decrease the toner density setting (see the online user guide for details).
- 5 Make sure that the environmental specifications for the printer are being met (see the online user guide for printer specifications).
- 6 Replace the toner cartridge.

AaBbCc
AaBbCc
AaBbCc
AaBbCc
AaBbCc

Toner smear

See also “Loose toner” on page 1-63.

- 1 Print a few more pages to see if the problem corrects itself.
- 2 Try using a different type of paper.
- 3 Make sure that the environmental specifications for the printer are being met (see the online user guide for printer specifications).
- 4 Clean the inside of the printer and run a manual cleaning page to clean the fuser (see the online user guide for cleaning procedures).
- 5 Maintenance might be due. Check this by printing a copy of the supplies status page. If maintenance is due, order and install the printer maintenance kit (see the online user guide for details).
- 6 Replace the toner cartridge.

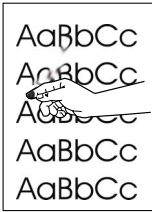

Loose toner

Loose toner, in this context, is defined as toner that can be rubbed off the page.

- 1 If paper is heavy or rough, try using a high fuser mode so that toner fuses more completely onto the paper. At the printer control panel, use the CONFIGURE FUSER MODE MENU item on the Paper Handling Menu to do this (see the online user guide for details).
- 2 If you have observed a rougher texture on one side of your paper, try printing on the non-rough side.
- 3 Make sure that the environmental specifications for the printer are being met (see the online user guide for printer specifications).
- 4 Make sure that paper type and quality meet HP specifications (see the online user guide for paper specifications).
- 5 Maintenance might be due. Check this by printing a copy of the supplies status page. If maintenance is due, order and install the printer maintenance kit (see the online user guide for details).

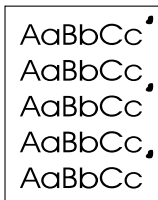

Repeating defects

See also "Repeating image" on page 1-64.

- 1 Print a few more pages to see if the problem corrects itself.
- 2 If the distance between defects is 38 mm (1.5 in) or 94 mm (3.76 in), the toner cartridge might need to be replaced.
- 3 Clean the inside of the printer and run a manual cleaning page to clean the fuser (see the online user guide for cleaning procedures).
- 4 Maintenance might be due. Check this by printing a copy of the supplies status page. If maintenance is due, order and install the printer maintenance kit (see the online user guide for details).



Repeating image

This type of defect might occur when using preprinted forms or a large quantity of narrow media.

- 1 Print a few more pages to see if the problem corrects itself.
- 2 Make sure that paper type and quality meet HP specifications (see the online user guide for paper specifications).
- 3 If you observe that this type of defect occurs on wide paper (such as letter- or A4-size paper) just after printing on narrow media (such as envelopes), you can set SMALL PAPER SPEED on the Paper Handling Menu to SLOW (see the online user guide for details). Note that this will slow down printing.
- 4 Maintenance might be due. Check this by printing a copy of the supplies status page. If maintenance is due, order and install the printer maintenance kit (see the online user guide for details).

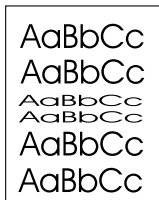

Misformed characters

- 1 Print a few more pages to see if the problem corrects itself.
- 2 Make sure that the environmental specifications for the printer are being met (see the online user guide for printer specifications).
- 3 Maintenance might be due. Check this by printing a copy of the supplies status page. If maintenance is due, order and install the printer maintenance kit (see the online user guide for details).

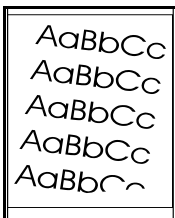

Page skew

- 1 Print a few more pages to see if the problem corrects itself.
- 2 Verify that there are no torn pieces of paper inside the printer.
- 3 Make sure that paper is loaded correctly, all adjustments have been made, and the paper is under the corner tabs (see "Loading tray 1" on page 1-49 and "Loading trays 2, 3, and 4" on page 1-50).
- 4 Turn over the stack of paper in the tray or rotate the paper 180°.
- 5 Make sure that paper type and quality meet HP specifications (see the online user guide for paper specifications).
- 6 Make sure that the environmental specifications for the printer are being met (see the online user guide for printer specifications).

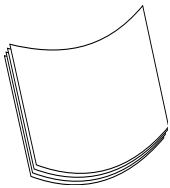

Curl or wave

- 1 Turn over the stack of paper in the tray. Also, try rotating the paper 180°.
- 2 Make sure that paper type and quality meet HP specifications (see the online user guide for paper specifications).
- 3 Make sure that the environmental specifications for the printer are being met (see the online user guide for printer specifications).
- 4 Try printing to a different output bin.
- 5 If media is lightweight and smooth, try using a low fuser mode to reduce the heat in the fusing process. At the printer control panel, use the `CONFIGURE FUSER MODE MENU` item on the Paper Handling Menu to do this (see the online user guide for details).

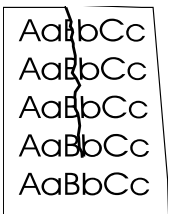

Wrinkles or creases

- 1 Print a few more pages to see if the problem corrects itself.
- 2 Make sure that the environmental specifications for the printer are being met (see the online user guide for printer specifications).
- 3 Turn over the stack of paper in the tray. Also, try rotating the paper 180°.
- 4 Make sure that paper is loaded correctly, all adjustments have been made, and the paper is under the corner tabs (see “Loading tray 1” on page 1-18 and “Loading trays 2, 3, and 4” on page 1-19).
- 5 Make sure that paper type and quality meet HP specifications (see the online user guide for paper specifications).
- 6 If envelopes are creasing, try storing envelopes so that they lie flat.

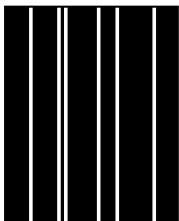

Vertical white lines

- 1 Print a few more pages to see if the problem corrects itself.
- 2 Make sure that paper type and quality meet HP specifications (see the online user guide for paper specifications).
- 3 Replace the toner cartridge.

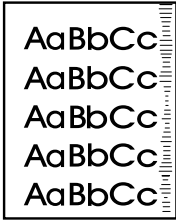

Tire tracks

This defect typically occurs when the toner cartridge has far exceeded its rated usage of 10,000 pages (for example, printing a very large quantity of pages with very little toner coverage).

- 1 Replace the toner cartridge.
- 2 Reduce the number of pages that you print with very low toner coverage.
- 3 Use the 6,000-page cartridge if you cannot reduce the number of pages with very little toner coverage (part number C8061A).

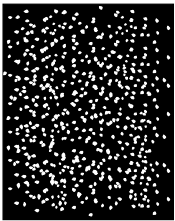

White spots on black

- 1 Print a few more pages to see if the problem corrects itself.
- 2 Make sure that paper type and quality meet HP specifications (see the online user guide for paper specifications).
- 3 Make sure that the environmental specifications for the printer are being met (see the online user guide for printer specifications).
- 4 Replace the toner cartridge.

Cartridge interaction (shaking)

When you install a toner cartridge for the first time, gently shake it from side to side to distribute the toner evenly inside the cartridge. Due to new cartridge design, this is the only time you will need to shake the cartridge.

Checking the toner level

You can check the toner level by printing a supplies status page from the printer control panel.

- 1 Press **MENU** on the printer control panel until `INFORMATION MENU` appears.
- 2 Press **ITEM** until `PRINT SUPPLIES STATUS PAGE` appears.
- 3 Press **SELECT** to print the supplies status page.

Cartridge authentication

The printer will let you know that a cartridge is not a genuine HP toner cartridge when you insert it in the printer. If you insert a used HP cartridge from another HP printer, the printer can take up to 20 printed pages to receive the message authenticating that the cartridge is a genuine HP part.

If the printer control panel message states that this is not a genuine HP toner cartridge and you believe you purchased an HP cartridge, call the HP fraud hotline at 1-887-219-3183 (toll-free in North America).

Toner low and toner out conditions

Toner low condition

When toner is low, the printer control panel displays the `TONER LOW` message and the printer will continue to print. The message first appears when about 15% of the toner remains in the cartridge (about 1,500 pages remaining for the 10,000-page cartridge and about 900 pages remaining for the 6,000-page cartridge at 5% page coverage).

You might prefer to have the printer stop instead of continuing when the `TONER LOW` message first appears—for example, if you want print quality to remain consistently high during print jobs or if you do not want toner to run out during a long print job. See the online user guide for information on how to configure the printer to stop. You can resume printing by pressing `Go`.

Toner out condition

When the toner cartridge runs out of toner, the printer control panel displays the `TONER OUT` message and the printer stops printing. You can continue printing the current job by pressing `Go`. The message continues to appear for every job until you take one of the following actions:

- replace the toner cartridge
- press `Go` (the printer will print the current job)

See the online user guide for information on how to configure the printer to continue. Subsequent jobs will continue to print indefinitely while `TONER OUT` is displayed.

Paper sizes supported

Supported sizes and weights of paper (one-sided printing) - tray 1

Size	Dimensions ^a	Weight	Capacity ^b
Paper (custom minimum size)	76 by 127 mm (3 by 5 in)	60 to 199 g/m ² (16 to 53 lb)	100 sheets of 75 g/m ² (20 lb) paper
Paper (maximum size)	216 by 356 mm (8.5 by 14 in)		
Transparencies	Same as minimum and maximum paper sizes listed above.	Thickness: 0.099 to 0.114 mm 0.0039 to 0.0045 in	50 transparencies
Labels		Thickness: 0.127 mm to 0.178 mm (0.005 to 0.007 in)	50 labels
Envelopes		75 to 105 g/m ² (20 to 28 lb)	10 envelopes

- The printer supports a wide range of paper sizes. Check the printer software for supported sizes. See the online user guide for information on printing custom-size paper.
- Capacity may vary depending on paper weight and thickness, and environmental conditions.

Supported sizes and weights of paper - duplex printing accessory (duplexer)

Size	Dimensions	Weight
Letter	216 by 279 mm (8.5 by 11 in)	60 to 105 g/m ² (16 to 28 lb)
A4	210 by 297 mm (8.3 by 11.7 in)	
Executive	184 by 267 mm (7.3 by 10.5 in)	
Legal	216 by 356 mm (8.5 by 14 in)	
B5 (JIS)	182 by 257 mm (7.2 by 10 in)	

Supported sizes and weights of paper - trays 2, 3, and 4

Size	Dimensions ^a	Weight	Capacity ^b
Letter	216 by 279 mm (8.5 by 11 in)	60 to 105 g/m ² (16 to 28 lb)	500 sheets of 75 g/m ² (20 lb) paper 50 transparencies
A4	210 by 297 mm (8.3 by 11.7 in)		
Executive	184 by 267 mm (7.3 by 10.5 in)		
Executive (JIS) (custom ^c)	216 by 330 mm (8.5 by 13 in)		
16K (custom ^c)	197 by 273 mm (7.75 by 10.75 in)		
Legal	216 by 356 mm (8.5 by 14 in)		
B5 (ISO) (custom ^c)	176 by 250 mm (6.9 by 9.9 in)		
B5 (JIS)	182 by 257 mm (7.2 by 10 in)		
A5	148 by 210 mm (5.8 by 8.2 in)		
Custom ^c	148 by 210 mm to 216 by 356 mm (5.8 by 8.2 in to 8.5 by 14 in)		

- The printer supports a wide range of paper sizes. Check the printer software for supported sizes.
- Capacity may vary depending on paper weight and thickness and environmental conditions.
- See the online user guide for information on printing custom-size paper.

Declaration of Conformity

according to ISO/IEC Guide 22 and EN 45014

Manufacturer's Name: Hewlett-Packard Company
Manufacturer's Address: 11311 Chinden Boulevard
Boise, Idaho 83714-1021, USA

declares that the product

Product Name: HP LaserJet 4100 / 4100N / 4100TN / 4100DTN / 4100SE

Model Numbers: C8049A / C8050A / C8051A / C8052A / C8048A

Product Options: ALL

conforms to the following Product Specifications:

Safety: IEC 950:1991+A1+A2+A3+A4 / EN 60950:1992+A1+A2+A3+A4+A11
IEC 825-1:1993 +A1 / EN 60825-1:1994 +A11 Class 1 Laser/LED Product

EMC: CISPR 22:1997 / EN 55022:1998 Class B¹
EN 61000-3-2:1995
EN 61000-3-3:1995
EN 55024: 1998
FCC Title 47 CFR, Part 15 Class B² / ICES-002, Issue 2
AS / NZS 3548:1995

Supplementary Information:

The product herewith complies with the requirements of the EMC Directive 89/336/EEC and the Low Voltage Directive 73/23/EEC, and carries the CE-Marking accordingly:

1. The product was tested in a typical configuration with Hewlett-Packard Personal Computer Systems.
2. This Device complies with Part 15 of the FCC Rules. Operation is subject to the following two Conditions: (1) this device may not cause harmful interference, and (2) this device must accept any interference received, including interference that may cause undesired operation.
3. Product exhibits Class A operation when connected to Local Area Network (LAN) cables using print server accessories.

**Boise, Idaho, USA
February 2001**

For regulatory topics ONLY, contact:

Australia Contact: Product Regulations Manager, Hewlett-Packard Australia Ltd.,
31-41 Joseph Street, Blackburn, Victoria 3130, Australia

European Contact: Your Local Hewlett-Packard Sales and Service Office or
Hewlett-Packard GmbH, Department HQ-TRE / Standards
Europe, Herrenberger Straße 110-140, D-71034 Böblingen
(FAX: +49-7031-14-3143)

USA Contact: Product Regulations Manager, Hewlett-Packard Company,
PO Box 15, Mail Stop 160, Boise, ID 83707-0015 (Phone:
208-396-6000)

