



C6074A, C6075A
HP DesignJet 1050C Printer
HP DesignJet 1055CM Printer

Quick Reference Guide



Hewlett-Packard Company
Barcelona Division
Avda. Graells, 501
08190 Sant Cugat del Vallès
Barcelona, Spain

Table of Contents Page

Table of ContentsPage

Normal Start up of the Printer	4
Switching On	5
Front Panel Navigation.....	8
Printer Driver Attributes.....	12
Internal Prints	13
Supported Paper Types	14
Supported Paper Sizes and Margin Settings.....	16
Paper Loading and Unloading	
Installing a New Roll into the Printer	17
Loading Roll Paper	20
Which side?.....	32
Sheet Paper.....	32
Unloading Sheet Paper.....	35
Working with HP80 Ink System	
Ink Cartridge Status Messages	39
Obtaining Ink Cartridge Information	40
Ink Cartridge Removal.....	42
Ink Cartridge Installation	45
Printhead Status Messages	47
Obtaining Printhead Information	51
Printhead Removal.....	53
Printhead Installation.	57
Printhead Cleaner Removal	59
Printhead Cleaner Installation.....	62
Front Panel Menu Structure.....	65
Hewlett-Packard Support Services	71
User Tips (Finding other Information)	73

Normal Start up of the Printer

Normal Start up of the Printer

NOTE: When starting up the printer for the **first** time refer to the Setup guide which came with your printer.

When you start-up your printer you will be prompted by the display on the front panel which will help you perform the various operator tasks. For more details about these instructions, refer to the User's Guide.

For safety, keep objects such as hair, jewelry and clothing away from the printer mechanisms and electronics.

Make sure that the power cord supplied with your printer matches your AC power outlet connection. Only use a three-wire (earth-grounded) power cord with this printer.

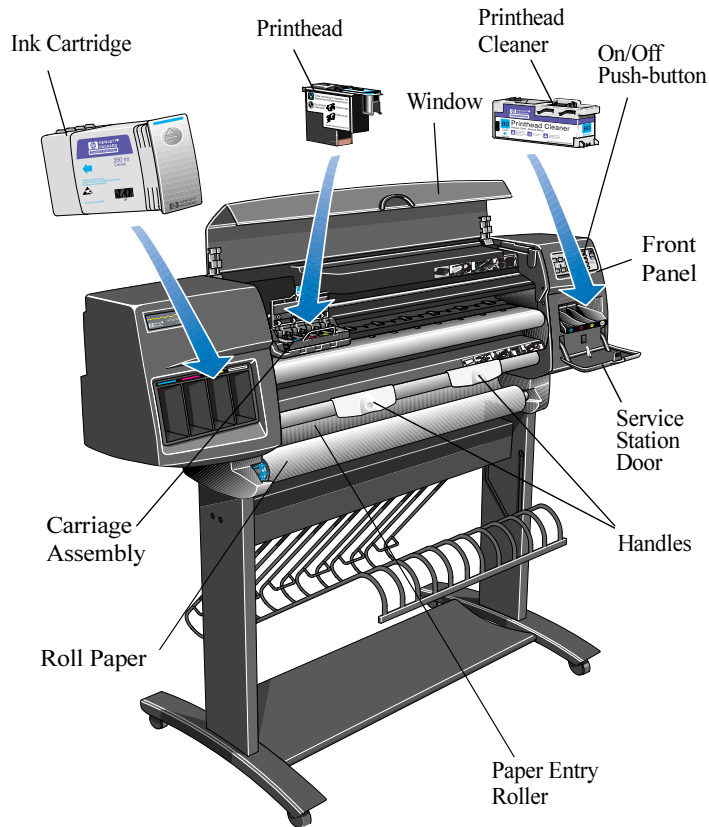

C6074274a

Switching On

Switching On

The printer has two power switches:

- a) A power isolator switch located at the back of the printer.
- b) An On/Off push-button located on the front panel of the printer.

To switch the printer on you must use both of these switches.

- 1 Switch the rear power isolator switch to the On (I) position.

Power Isolator Switch
in the On (I) position

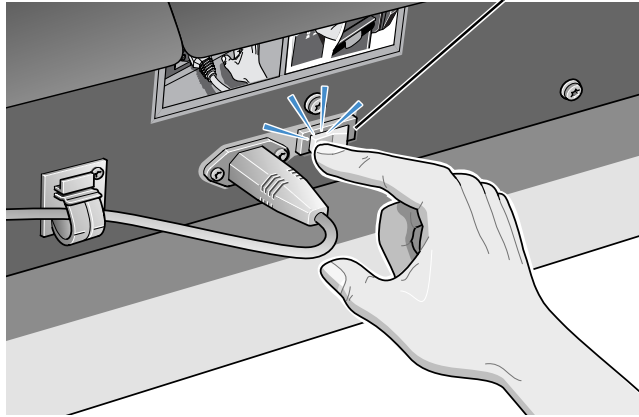

C6074259

NOTE: The LED on the front panel illuminates red, indicating that the printer is in the power saving mode and ready to be turned on.

- 2 Push the On/Off push-button on the front panel; the front panel display will then indicate the status of the printer.

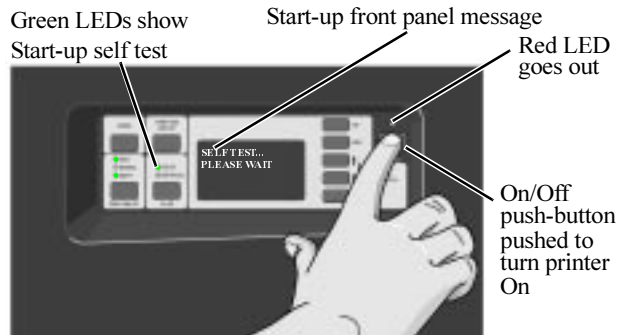

C6074284

Switching On

Switching Off

- 1 To turn the printer off, press the On/Off push-button to the off position. The LED will illuminate red again and the front panel will no longer display any messages.

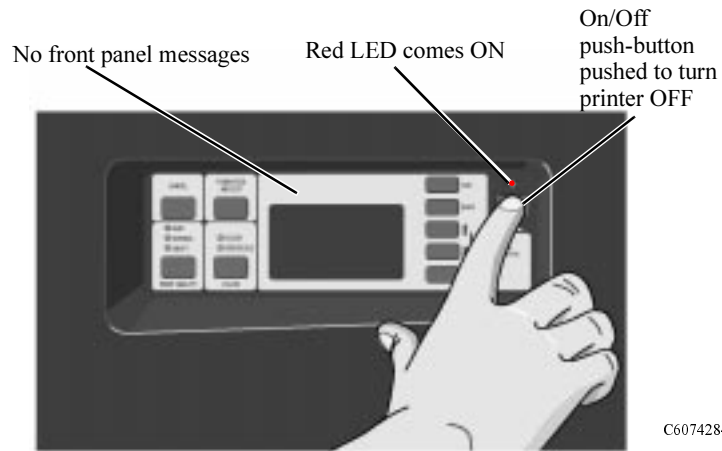

C6074284

Power Isolation Switch

Power Isolation Switch

The power isolator switch should only be switched off for power isolation requirements:

- a) Removing/Installing memory expansion modules.
- b) Removing/Installing JetDirect Print Server and Hard Disk.
- c) Connecting to a computer.
- d) Transportation.

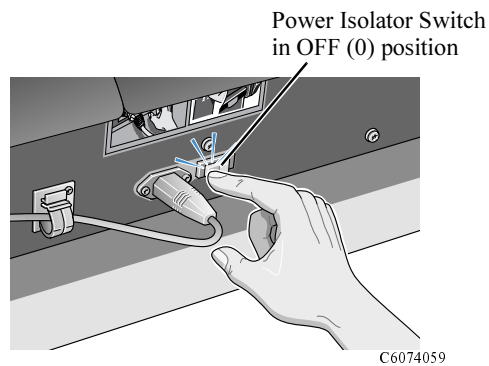

CAUTION

The power isolator switch should only be switched to the Off (0) position when the printer has gone into power saving mode (On/Off push-button in the Off position).

Front Panel Navigation

Front Panel Navigation

The front panel of the printer is made up of the following functional areas:

- Display keys
- A message display screen
- Action keys and associated Status Lights, on the left
- Power section.

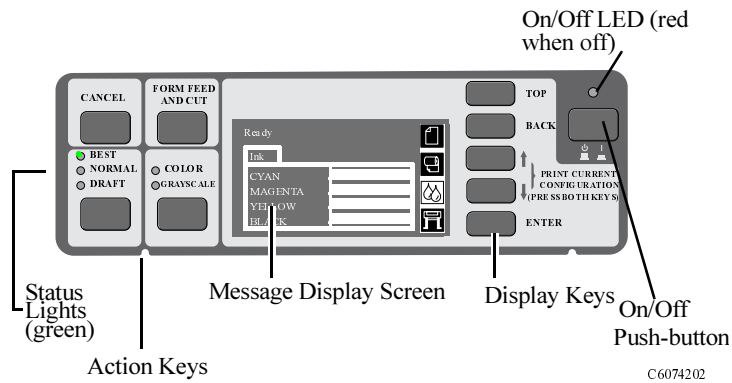

The Display Keys

The display section of the front panel consists of a message display screen and five display keys: **Top**, **Back**, **↑**, **↓** and **Enter**.

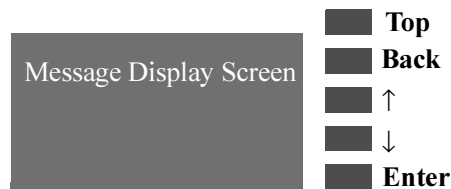

You use the display keys to navigate through the menu system and to select menu icons and menus, see chapter 3 in the User's Guide, *Navigation Examples*. You also use the display keys to respond to messages. See chapter 12, *Message Descriptions and Actions* in the *User's Guide* for detailed descriptions of error and status messages.

Front Panel Navigation

Message Display Screen

The display shows menu icons and several lines of text . They are used for displaying:

- Information on the status of the HP No.80 Supplies.

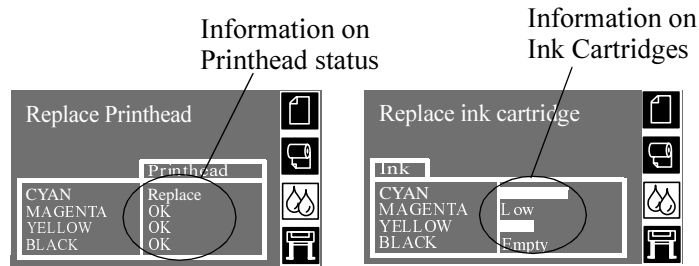

- messages and menus.

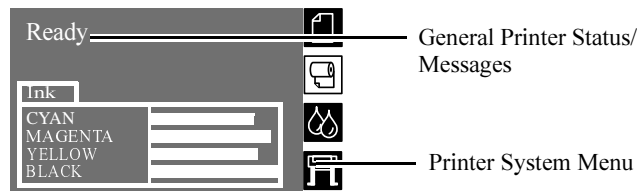

- menus used to configure the printer.

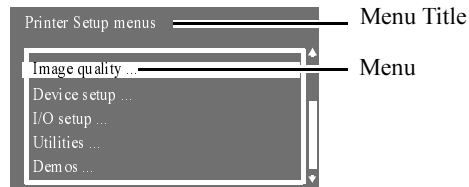

- instruction for loading and aligning roll paper.

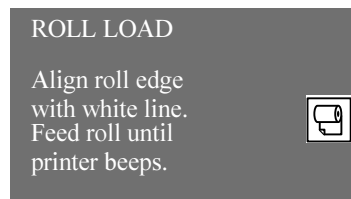

Front Panel Navigation

- the amount of ink remaining:

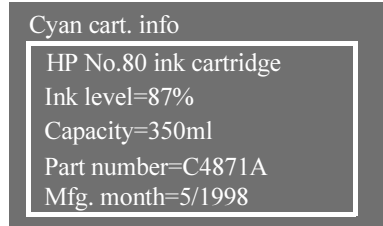

Action Keys and associated Status Lights

The action section of the front panel consists of four action keys: **Cancel, Form Feed and Cut, Color and Print Quality**. The Color and Print Quality sections have green status lights next to the selected setting.

The action keys let you:

- cancel the following printer operations while they are in progress (**Cancel**):
 - Printing
 - Paper loading
- advance and cut paper (**Form Feed and Cut**)
- select color or greyscale printing (**Color**)
- select the printing resolution (**Print Quality - Draft, Normal and Best**). See chapter the User's Guide, for information on the use of these keys.

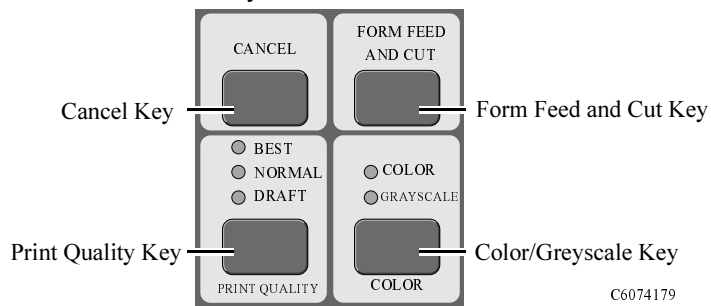

Front Panel Navigation

Status Lights

The status lights provide status information about the current configuration and state of the printer.



NOTE: In most cases, settings in your application software or printer driver will override any settings you make on the front panel of the printer.

Power Section

The power section contains the On/Off push-button. This is how you must always power-off the printer. It turns the printer off making sure that the printheads are returned to the part of the printer which prevents the printheads from drying out. The status light above is red when the printer has been turned off correctly.

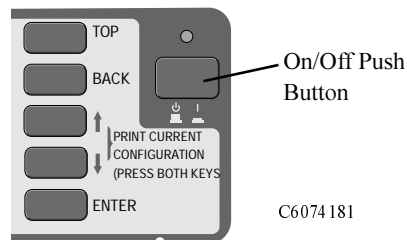

Printer Driver Attributes

Many of the printer attributes that can be changed by the front panel (print quality, paper type, scaling etc.) can also be changed from the computer.

For HP printer drivers

Here are some examples of how to access the printer attributes from the computer:

- a) Select **Print** from the **File** menu of the application.
- b) Select the printer whose printing attributes are to be changed (if it is not already selected).
- c) Click the **Properties** button. A dialog box will appear, in which the print attributes can be viewed. Change the printer attributes as required.

When the printer attributes are changed from the computer, these changes **override the front panel settings**. The only exception is that the Paper Type selected on the front panel determines which Print Mode is used, but Paper Type selected from the computer determines which Color Map is used. For this reason, it is generally best to ensure that the same Paper Type is selected on the computer and front panel.

For Non-HP Printer Drivers

In most cases, settings in the application software or printer driver will override any settings made on the front panel of the printer.

NOTE: If a **Non-HP Driver** is installed in the printer see the **Vendor Documentation** related to that driver for more information.

Differences between PostScript and Non-PostScript Print Files

The printer behaves differently in many ways, depending on whether it receives PostScript or non-PostScript files. For help refer to the User's Guide.

Printer Driver Attributes

Internal Prints

The printer is capable of printing on request different “internal prints”, giving various kinds of information about the printer’s status:

- a) HP-GL/2 Configuration print.
- b) Front Panel Menus print.
- c) Print Quality Print.
- d) Printer Usage Information print.
- e) Service Configuration.
- f) Palette print.
- g) Samples.

NOTE: For more information about these prints see chapter 2, Printing Internal Prints in the User’s Guide.

Supported Paper Types

Supported Paper Types

The paper types that the printer will give its best performance on are:

Front Panel Display	Other names used for this paper type	Available from HP as....	Cost
Plain Paper	Plotter paper; Plain paper	White inkjet paper (from the front panel choose white inkjet paper)	Low
Translucent bond		HP Translucent bond	Low
White inkjet paper	Color bond paper; Color Inkjet paper	HP Bright White Inkjet Paper	Low
Coated paper	Special paper; Inkjet paper; Color Inkjet paper; Matte paper; Presentation	HP Coated Paper Note: <i>HP Special Inkjet Paper is not supported</i>	Low/ Mid
Heavy coated paper	Heavyweight coated paper; Heavyweight special paper; Heavyweight Inkjet paper; Heavyweight matte paper; Heavyweight Color Inkjet paper	HP Heavy Weight Coated Paper. Note: HP Heavyweight Special Inkjet Paper is not supported	Mid
Matte film	Matte polyester; Polyester matte film; Mylar	HP Matte film	High
Clear film	Translucent film; Clear polyester	HP Clear film	High

Supported Paper Types

Front Panel Display	Other names used for this paper type	Available from HP as....	Cost
High-gloss photo	High-gloss photo paper; High-gloss paper	HP High-Gloss Photo paper for the HP DesignJet 1050C and HP DesignJet 1055CM	High
Vellum		HP Vellum	Med
Nat. tracing paper	Natural tracing paper; Tracing paper; Extra translucent bond	HP Natural Tracing Paper	Low
Thin Nat. tracing paper	Rice paper; Japanese tracing paper	Not available	Low

Choosing the correct paper for your printer is important for obtaining good print quality.

From time to time, new paper types may become available. For up-to-date information, please contact your HP dealer or our web page www.hp.com/go/designjet.

Supported Paper Sizes and Margin Settings

Supported Paper Sizes and Margin Settings

Paper size	Width		Length	
	Maximum	Minimum	Maximum	Minimum
A/A4-E/A0 (Sheet)	917 mm	210 mm	1600 mm	210 mm
E/A0 size (Roll)	917 mm	210 mm	15200 mm	210 mm
E/A0 size	917 mm	210 mm	210 mm	15.2 m

Margins		Normal	Extended
Sheet	Leading Edge:	10 mm	10 mm
	Trailing Edge:	15 mm	15 mm
	Sides:	5 mm	15 mm
Roll	Leading Edge:	10 mm	10 mm
	Trailing Edge:	5 mm	5 mm
	Sides:	5 mm	15 mm
For more information on margins see the User's Guide, chapter 5.			

CAUTION If you are printing images with intense color that require large amounts of ink, it is strongly recommended that you avoid lightweight papers such as HP bright white inkjet or coated papers and/or increase the margins. Lightweight papers are *not* designed to absorb large amounts of ink and may wrinkle severely, risking contact with the printheads and so potential damage to them. Refer to the *User's Guide* for information on how to change the margins settings to extended, and which paper you should choose, both of which help to eliminate the risk of the printheads coming into contact with the paper.

Installing a New Roll into the Printer

Installing a New Roll into the Printer

- 1 Make sure the printer wheels are locked (the brake lever is pressed down) to prevent the printer from moving.
- 2 Remove the empty spindle by pulling firmly on each end first A and then B as indicated below.

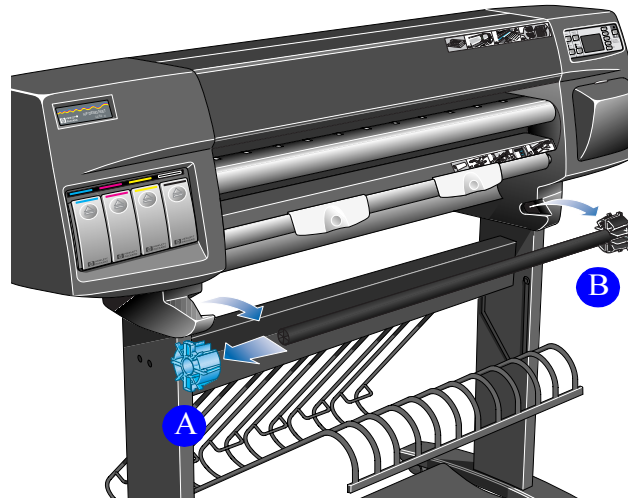

C6074045

The spindle has a stop at each end to keep the roll in position. The stop at the left-hand end (A)(colored blue) can be removed to mount a new roll, it slides along the spindle to hold rolls of different widths.

- 3 Remove the blue colored stop (A) from the left-hand end of the spindle, and stand the spindle vertically, with the fixed stop (B) on the floor.

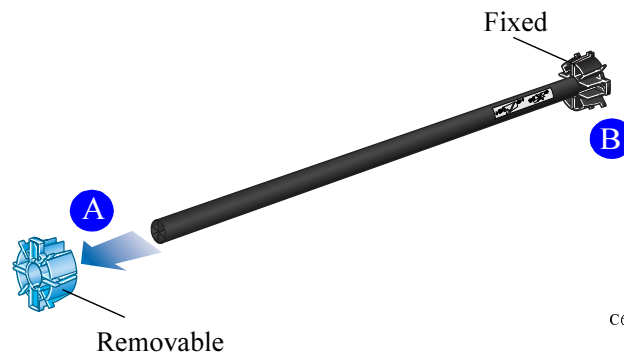

C6074246

Installing a New Roll into the Printer

- Slide the new roll of paper on to the spindle. Make sure the orientation of the paper is exactly as shown. If it is not, remove the roll, turn it through 180 degrees vertically and slide it back onto the spindle.

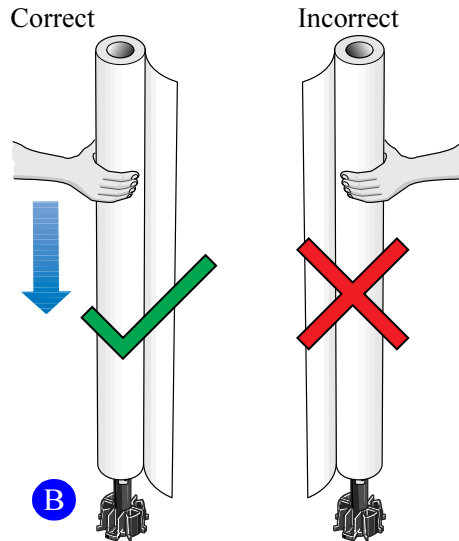

C6074247

- Put the removable stop onto the upper end of the spindle, and push it down as far as it will go. Do not use excessive force.

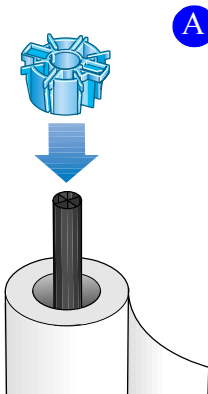

C6074248

Installing a New Roll into the Printer

- 6 With the blue colored roll stop on the left, slide the spindle into the printer left and then right as shown by A and B. The paper must hang down from the roll exactly as shown below.

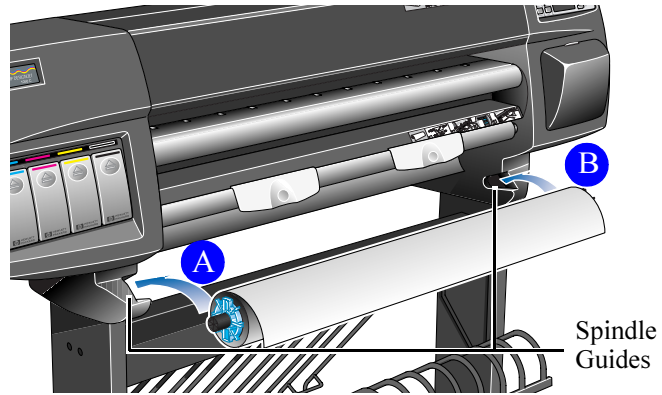

C6074249

Loading Roll Paper

Loading Roll Paper

NOTE: To start this procedure you need to have a roll of paper installed on a printer spindle. See page 17, *Installing a New Roll into the Printer*.

- 1 Check the leading edge as it unwinds from the spool. If it is not evenly cut or if it is skewed (not perpendicular to the guides), continue with the next procedure. If the paper is cut correctly go to step 3.

WARNING



The knife used in the next step is sharp. Be sure the printer's wheels are locked. Keep fingers clear of the cutting path. Keep the knife away from children.

- 2 Trim the leading edge of the paper roll only if it is not straight:
 - a) Pull the paper over the top of the machine and lay it over the cutting track.
 - b) Use the knife in the pocket located on the back of the printer to cut off the first few inches of the paper.
 - c) Retract the blade and return the knife to its pocket.

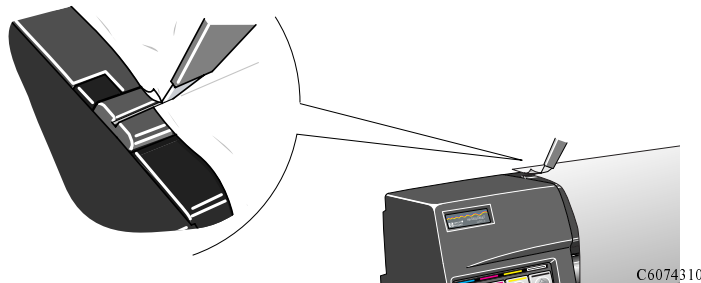

- 3 Press the **Top** button to select the main menu on the front panel.
- 4 Make sure that the front panel displays the “**Ready for paper**” message.



Loading Roll Paper

In addition to these instructions the **front panel** displays step by step instructions on how to load roll paper. There are also **labels** on the printer which give you a pictorial view of the paper loading procedure.

- 5 Lift the handles so that they are in the up position.

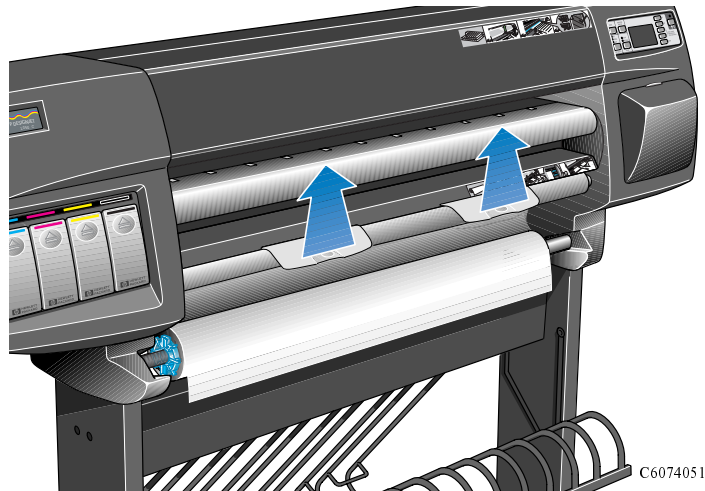

- 6 Pull out approximately 30 cm of paper (1ft).

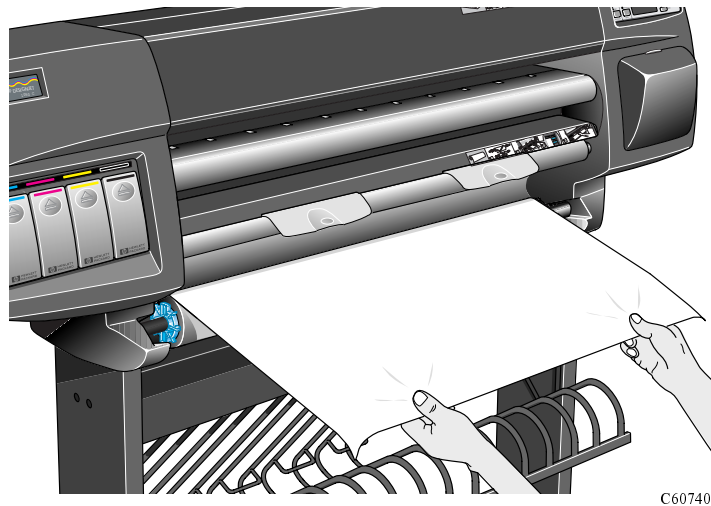

- 7 The front panel message will tell you how to load the roll.

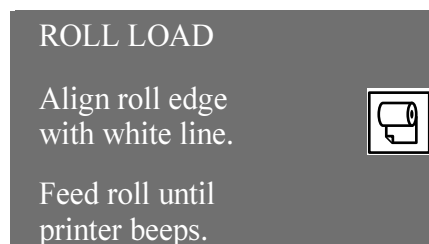

Loading Roll Paper

- 8** Insert the roll paper edge below the handles and above the paper entry roller.

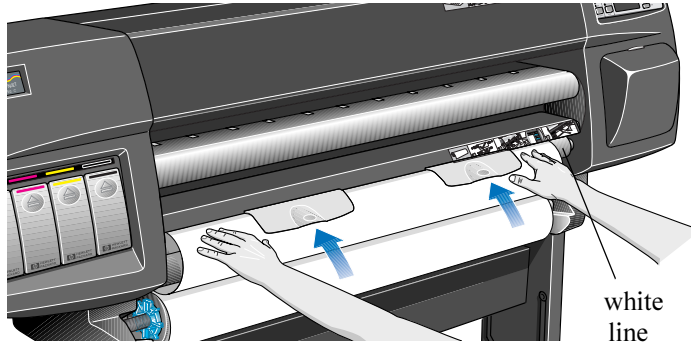

C6074054

- 9** Align the right edge of the paper with the white line on the right side of the entry roller.

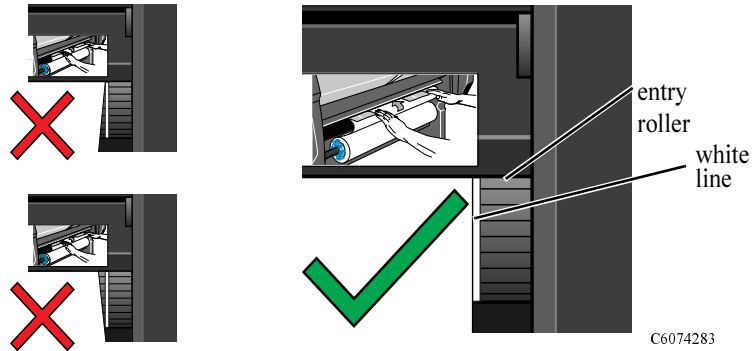

C6074283

- 10** When the paper has been inserted enough the printer will “BEEP”.

- 11** Lower the handles.

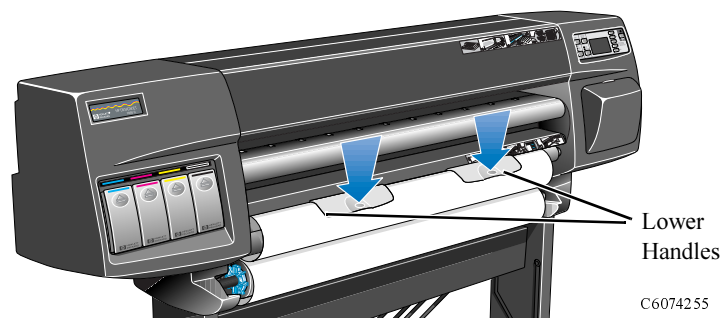

C6074255

Loading Roll Paper

- 12 The front panel will ask you to wrap back onto the roll any excess paper and press **ENTER**.

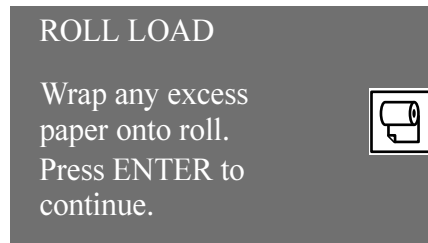

- 13 Carefully wind the excess roll paper back onto the spindle. Use the wings on the blue removable paper stop to turn the roll paper in the direction shown below.

NOTE: It is important to perform this step as the paper will not enter the printer correctly and there will be a misalignment.

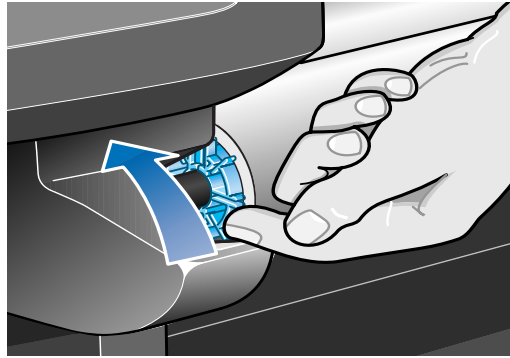

C6074256

- 14 Press the **ENTER** key.

Loading Roll Paper

- 15** The front panel will ask for the type of roll paper loaded. Select it from the options displayed on the front panel using the ↑ and ↓ keys and then press the **ENTER** key.

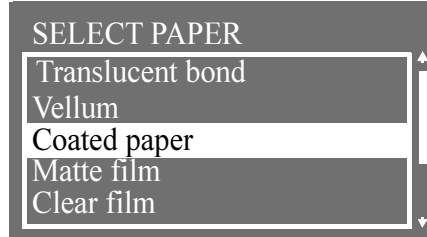

- To ensure you get the best image quality it is important to select the correct paper type, if you are unsure what paper type you have, refer to *chapter 3, Physical Characteristics of Paper Types in the User's Guide*.
- If you do not select a paper type within 2 minutes, the printer will select the default paper type and automatically load the roll paper.
- Once you have finished this procedure you cannot change the paper type. To do this you must unload the paper and then reload it.

- 16** The printer will now automatically:

- a) Load, check and align the paper.
- b) Trim a strip off the lead edge of the paper to give a straight edge.

NOTE: If a problem occurs while loading the roll paper, instructions will be displayed on the front panel.

- 17** If the paper is well aligned, the printer will accept the roll load and give one more single “BEEP”.

- 18** The front panel should now say “Ready” and you can begin to print.



NOTE: If you have problems loading the roll because of incorrect paper alignment, try loading the roll using the manual alignment procedure. Refer to page 25

Loading Roll Paper Using Manual Alignment

NOTE: To start this procedure you need to have a roll of paper installed on to the printer spindle. See page 17, *Installing a New Roll into the Printer*.

This procedure can be used to load roll paper without using the printer's automatic loading feature. If you have problems aligning roll paper try this simple manual alignment procedure.

- 1 The front panel should display "Ready for paper" before you can load the paper.

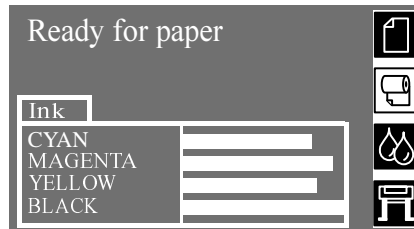

NOTE: This manual alignment procedure will override the printer's automatic loading function. Therefore ignore the messages displayed on the front panel during the manual alignment.

- 2 Lift the handles. You will hear a single "BEEP". **Ignore the message on the front panel instructing you how to perform an automatic load.**

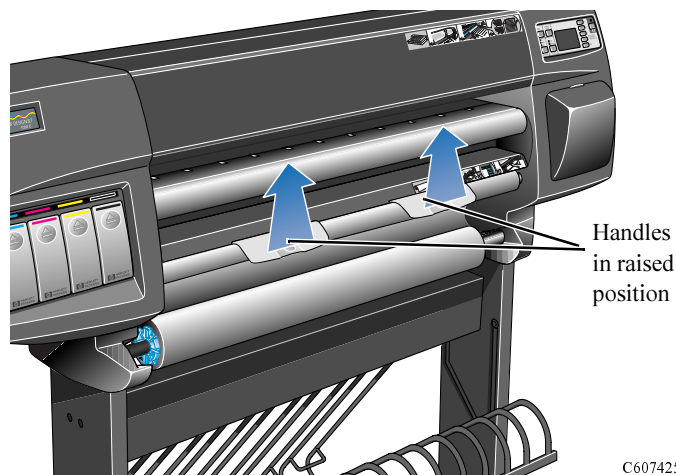

C6074251

Loading Roll Paper Using Manual Alignment

- 3 Lift the window. You will hear 3 successive “BEEPS”. Ignore the message shown on the front panel.

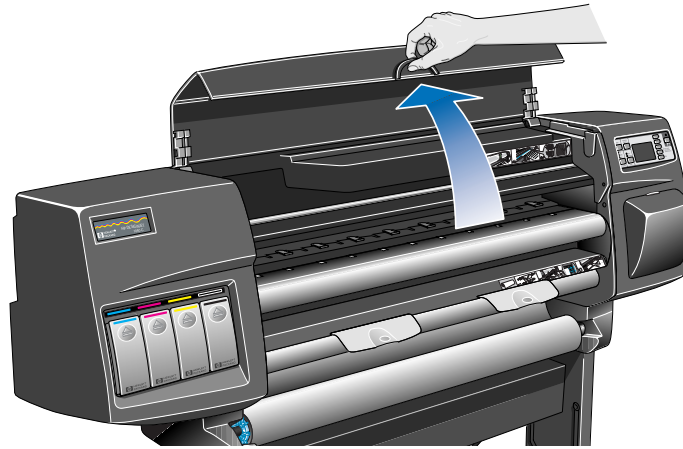

C6074228C

- 4 Pull out approximately 30cm (1ft) of paper.

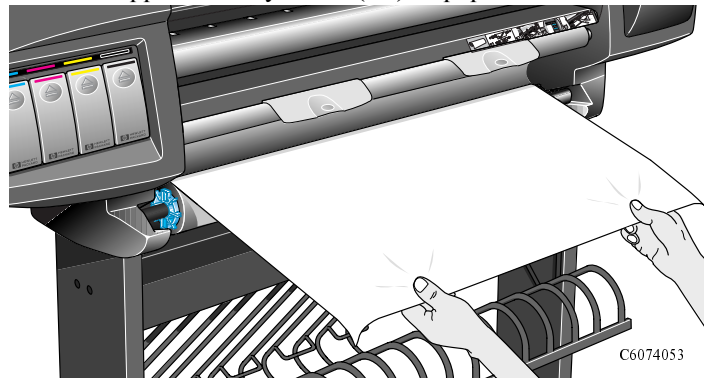

C6074053

Loading Roll Paper Using Manual Alignment

- 5 Carefully insert the roll paper edge, below the handles and between the roll paper entry roller and the roll cover. At some point, you will hear a single “BEEP”.

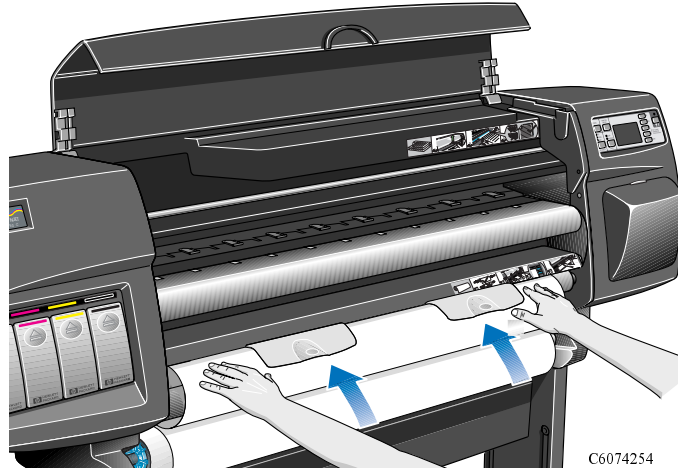

- 6 Continue inserting the roll paper between the roll paper cover and entry roller until it emerges from the sheet paper entry platen.

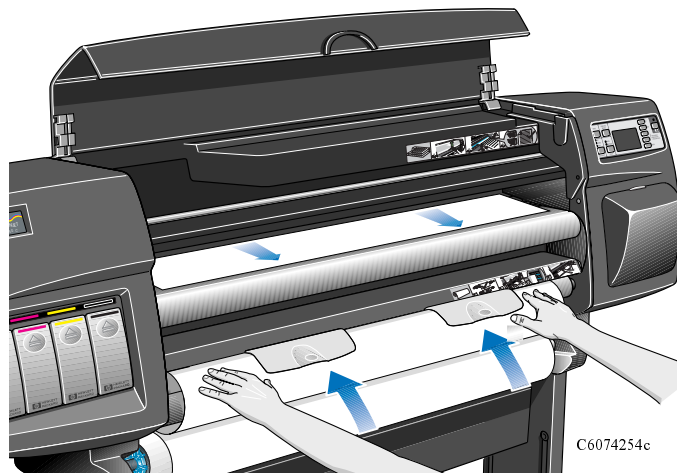

Loading Roll Paper Using Manual Alignment

- 7 Take hold of the leading edge of the paper and carefully aligning the right edge with the blue dashed lines on the right side of the sheet paper entry platen.

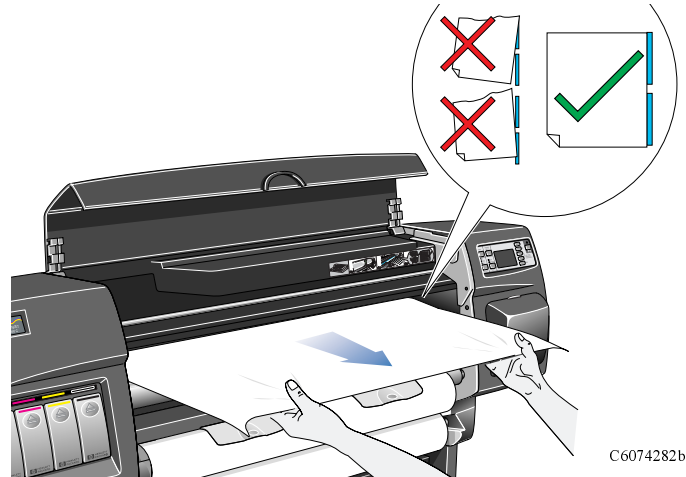

- 8 When the paper is correctly aligned with the blue dashed lines on the **sheet paper entry platen** lower the handles to hold the paper in place.

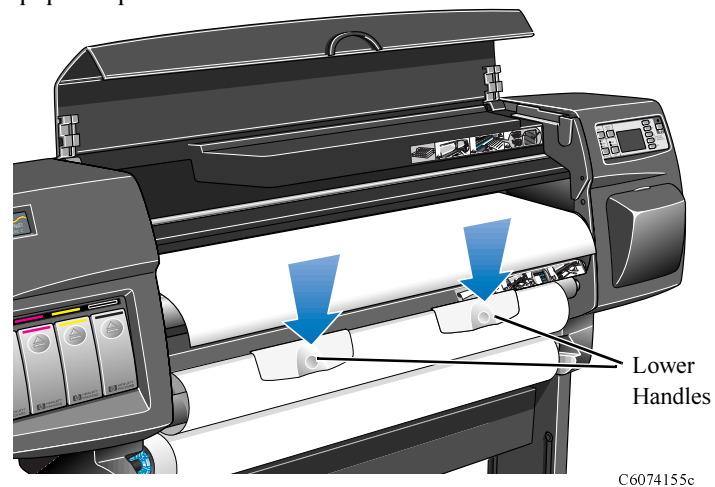

Loading Roll Paper Using Manual Alignment

- 9 Close the window and the printer will begin the roll paper load process in the same way as for an automatic load. To continue refer to step 12 on page 23.

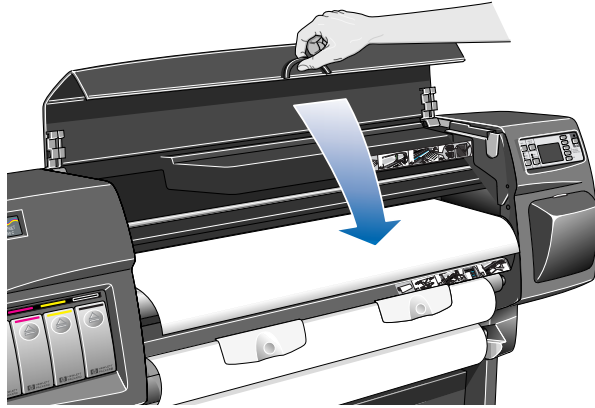

C6074229b

Unloading a Roll from the Printer

Unloading a Roll from the Printer

- 1 Lift the handles and turn the roll of paper in the direction indicated by the arrow shown below.

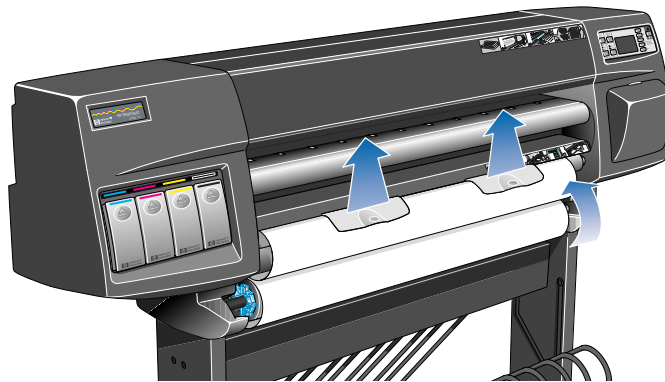

C6074052

- 2 Turn the blue removable paper stop by hand, using the wings as shown below, until the paper is removed from inside the printer.

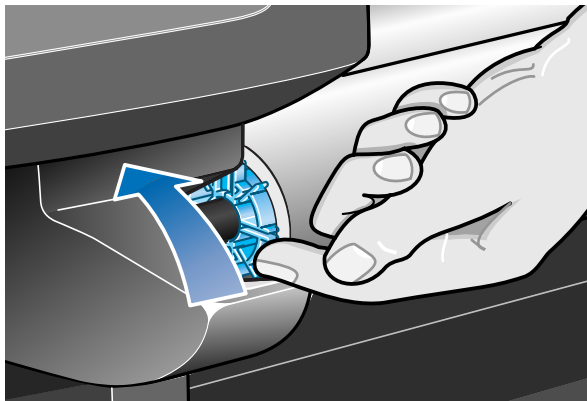

C6074256

NOTE: Keep the paper tightly wound on the roll throughout the unloading procedure. If it begins to unwind, it will become more difficult to handle.

Unloading a Roll from the Printer

- 3 Remove the roll paper from the printer by pulling first the left side of the roll A and then the right side B as indicated by the arrows.

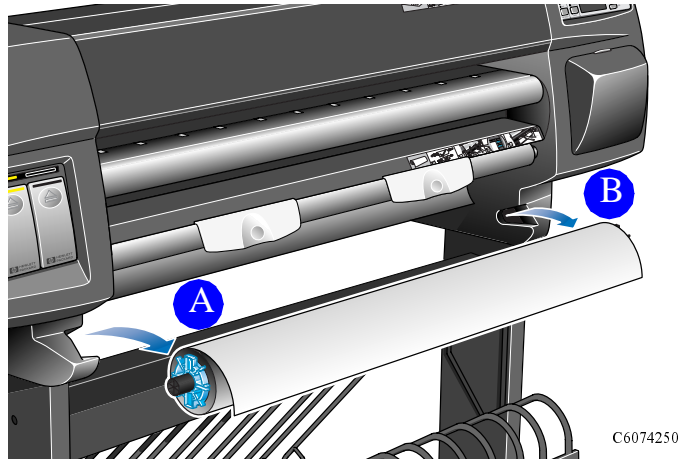

Sheet Paper

Sheet Paper

Do I have to remove the roll of paper?

When loading a single sheet of paper it is **not necessary** to remove the roll of paper that you may have already loaded into the printer. The printer will remove the roll of paper to a standby position.

NOTE: When loading a single sheet of paper always ensure the handles are in the down position.

Which side?

It is the side facing up on which the printer prints. It is important to load the sheet with the correct side facing up. See the table below.

Paper type	Paper loading tips
Plain Paper	Both sides are the same. If the sheet is curled, load with the curl down.
Translucent Bond	Both sides are the same. If the sheet is curled, load with the curl down.
Vellum	Both sides are the same. If the sheet is curled, load with the curl down.
Coated paper	Load with the coated side up.
Matte film	Load with the matte side up.
High-gloss Photo	Load with the glossy side up.
Heavy Coated paper	Load with the coated side up.
Bright white inkjet paper	Both sides are the same. If the sheet is curled, load with the curl down.
Natural tracing paper	Both sides are the same. If the sheet is curled, load with the curl down.
Thin Natural tracing paper	Both sides are the same. If the sheet is curled, load with the curl down.

Sheet Paper

Which edge first?

You can load a sheet in either portrait or landscape orientation. Unless using the Rotate option (see chapter 5 in the User's Guide, *Rotating an Image (PostScript)*), load the sheet in the same orientation as you have specified in your software. If printing a PostScript file, always load the sheet with the short edge first, even if the width of your image is greater than its length.

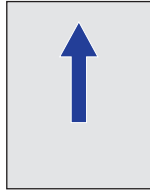

Portrait (short edge first)
- always use for PostScript files

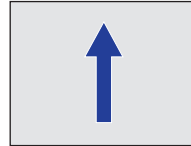

Landscape (long edge first)

C4704020

Loading Sheet Paper

- 1 Open the window.

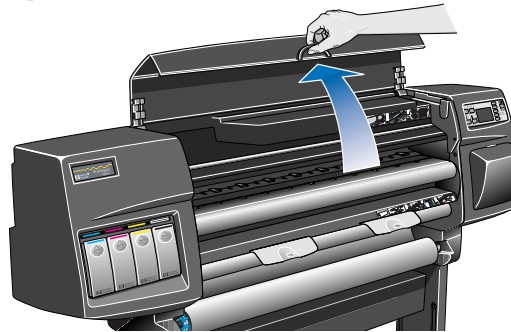

C6074228e

- 2 The front panel will display the following message:

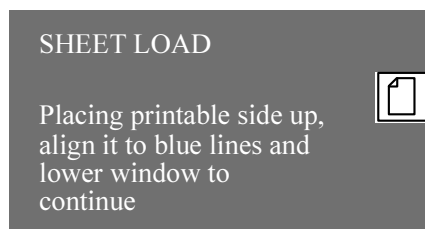

Sheet Paper

- 3 Place the bottom edge of the sheet paper onto the printer as shown below,

NOTE: Make sure the correct side is facing upwards, if you're not sure which side is correct see page 32, *Which side?*

- 4 Align the edge of the paper with the blue dashed lines on the printer. Air suction will hold the paper in place.

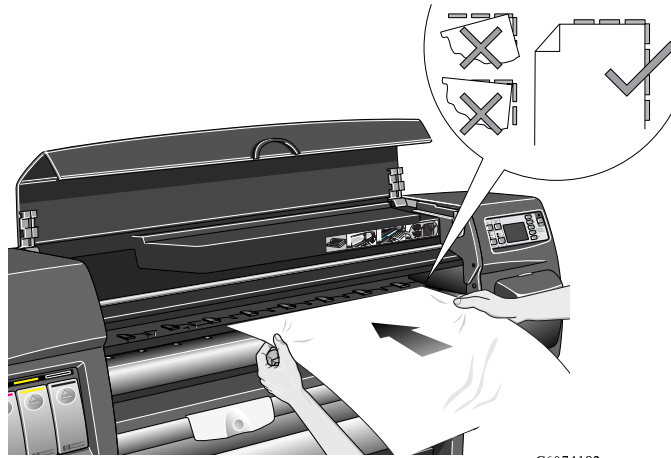

C6074182

- 5 Close the window.
- 6 Using the \uparrow or \downarrow key, select the type of paper you are loading and then press the **ENTER** key.

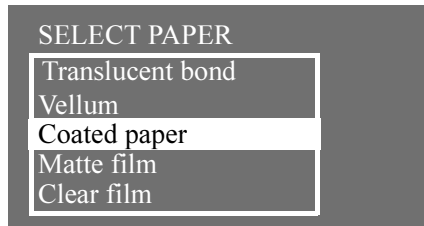

The printer will now load the paper, checking the alignment.

- 7 If the paper is correctly aligned, the printer will accept the single sheet and will give a “BEEP”. If it is not correctly aligned, the front panel will display an instruction.
- 8 The front panel will now display “Ready” and you can begin to print.

Unloading Sheet Paper

Unloading Sheet Paper

To unload a single sheet of paper from the printer, press the **Form Feed and Cut** action key located on the front panel.

To give the ink time to dry the printer holds the paper for some time. (Refer to page 36 for drying times). It is then released into the paper bin.

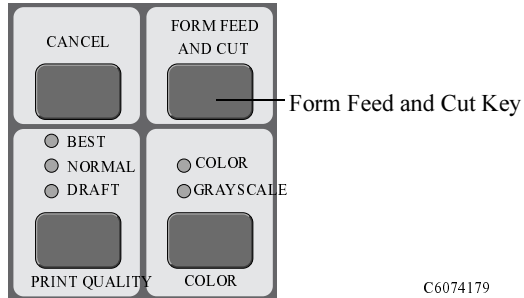

C6074179

Drying Time

Drying Time

With some paper types and environmental conditions the ink needs time to dry before the paper is unloaded. The printer has three settings which you can choose through the front panel; see page 28, *Changing the Drying Time* for more help.

Manual

Paper which has a specific drying time will be held in place by the printer and a “drying time to go” countdown will be displayed on the front panel. You can change this dry time to what you want.

Automatic

The printer automatically determines the appropriate drying time, based on the type of paper you have selected and the current temperature and humidity. If there is any drying time, a “drying time to go” countdown will be displayed on the front panel.

None

With this setting, when the printer has finished printing an image, the paper will fall into the paper bin under the printer.

CAUTION

Changing the drying time to speed up the printer could result in damage to your printed image and/or reduce the quality of your print.

Drying Time

Below is a table showing the typical drying times for HP tested paper at approximately 25°C with 50% relative humidity.

HP Tested Paper type	Drying time (seconds)	
	Draft	Normal/ Best
Plain Paper	25	43
HP Translucent Bond	35	60
HP Vellum	30	50
HP Coated paper	5	5
HP Matte film	180	180
HP Clear film	240	240
HP High-gloss Photo	180	180
HP Heavy Coated paper	5	5
HP Bright White inkjet paper	25	43
HP Natural tracing paper	45	100
Thin Natural tracing paper	45	100

Drying Time

Drying Procedure

- 1 The printed image emerges from beneath the printer window:
 - a) For a **roll** of paper, the printer automatically cuts the paper and is held on the platen of the printer by air suction.
 - b) For a **sheet** of paper, the printer finishes printing and the sheet is held on the platen by air suction.
- 2 The front panel displays:

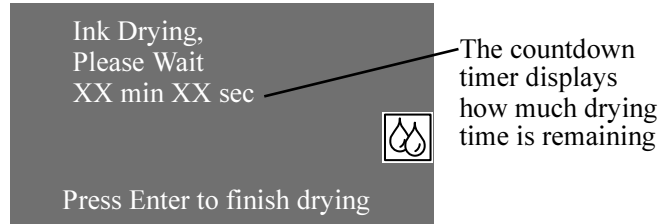

- 3 You can press **Cancel** or the **Enter** key to cancel the drying time.
- 4 After the drying time has elapsed the air suction is turned off and the printed image falls into the bin.

Ink Cartridge Status Messages

Detailed below are the ink cartridge status messages that you may come across while using the printer.

Status Bars

The front panel displays four horizontal bars. These bars represent how much ink is remaining in the ink cartridges: as ink is used up the bars get shorter in length. To see how much ink you have remaining, go to the 'Ink Cartridge Info' menu. See page 40, *Obtaining Ink Cartridge Information*

Low

The **Low** message means that you should obtain new supplies of that particular color. It is an early warning sign. To see how much ink you have remaining go to the 'Ink Cartridge Info' menu. See page 40, *Obtaining Ink Cartridge Information*

Very Low

When the **Very Low** message is displayed you should not attempt any overnight printing. It is strongly recommended that you change the ink cartridge to avoid stopping the printer halfway through a print. To see how much ink you have remaining go to the 'Ink Cartridge Info' menu. See page 40, *Obtaining Ink Cartridge Information*

Empty

The printer will stop and will not be able to continue printing until a new ink cartridge has been installed. If this occurs halfway through printing an image, replacement of the empty ink cartridge will allow printing to continue. You should check the quality of this image, as stopping mid-plot can affect the print.

Faulty

The ink cartridge is faulty and must be replaced, before you can continue printing.

Wrong Model

The ink cartridge is not recognized by the printer and needs to be replaced before the printer can continue.

Obtaining Ink Cartridge Information

- 1 To get information on your ink cartridges press the **Top** key on the front panel to go to the main menu.



- 2 Press the \uparrow or \downarrow key until the front panel displays the ink system menu. Press **Enter**.

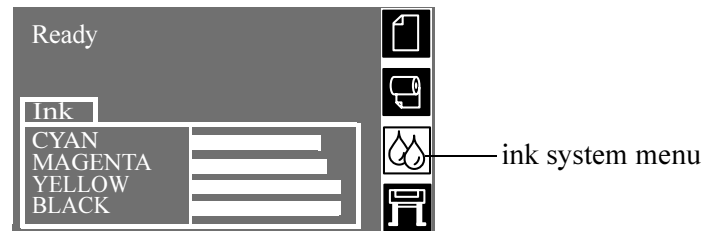

- 3 Press the \uparrow or \downarrow key until the front panel highlights "Ink Cartridge info". Press the **Enter** key.

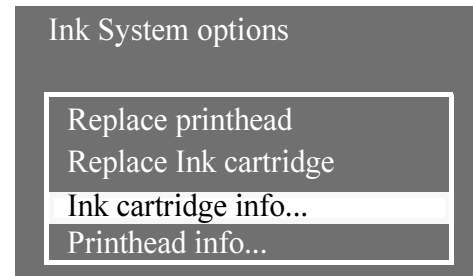

- 4 Press the \uparrow or \downarrow key until the front panel highlights the color that you want to see information on. Press the **Enter** key.

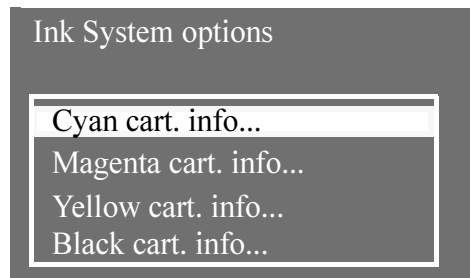

Obtaining Ink Cartridge Information

- 5 The front panel displays information on the selected ink cartridge.

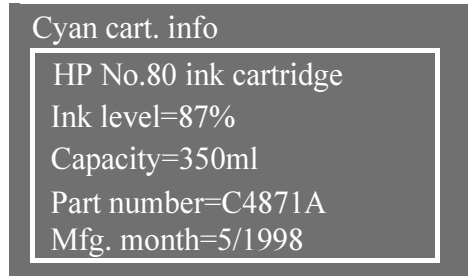

The information supplied is:

- The make of the ink cartridge (HP No.80 are recommended)
- The percentage of how much ink is remaining
- Original capacity of the ink cartridge in milliliters
- Re-order part number of the ink cartridge
- The year and the month that the ink cartridge was manufactured

Ink Cartridge Removal

CAUTION

Only remove an ink cartridge if you are replacing it. See *chapter 4, When Should You Replace the HP No.80 Supplies?* in the *User's Guide*.

There are two types of ink cartridge removal.

- The ink cartridge is **empty** and the front panel tells you to replace the ink cartridge. Go directly to step five.
- The ink cartridge is **very low** and you want to replace the ink cartridge before it becomes empty. Go directly to step one.

1 Press the **Top** key on the front panel to go to the main menu.



2 Select the Ink System Menu on the front panel by using the ↑ and ↓ keys, and then press the **ENTER** key.

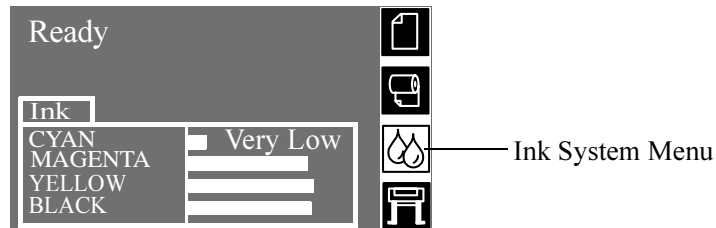

3 Press the ↑ and ↓ keys until "Replace Ink cartridge" is selected. Press **Enter**.

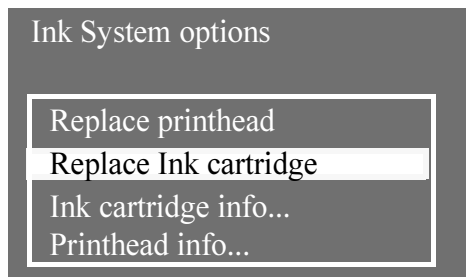

Ink Cartridge Removal

- 4 Select “yes (replace)” as shown below and press **Enter**.

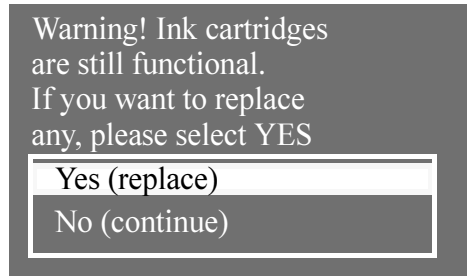

- 5 The front panel displays either of the message displays shown below, depending on how the ink cartridge replacement was initiated: by the printer (because it's empty) or, by you.

This is displayed if you initiated an ink cartridge replacement:

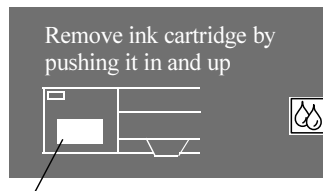

This is displayed if the printer initiated an ink cartridge replacement:

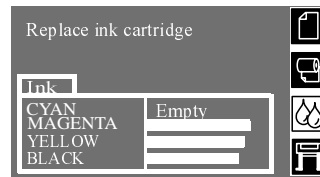

ink cartridge symbol

Ink Cartridge Removal

- 6 Remove the corresponding color ink cartridge by pushing the dimpled recess in the ink cartridge inward and upward, as indicated by the arrow shown below. This releases the ink cartridge, you can then pull it out horizontally.

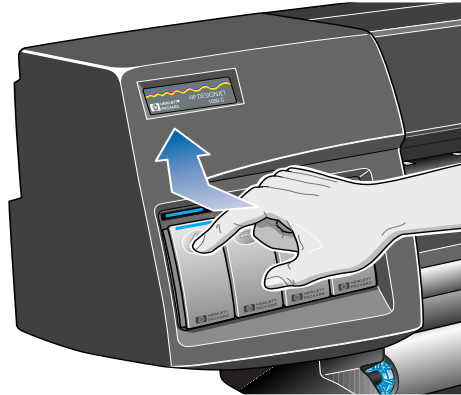

C6074225

NOTE: Avoid touching the end of ink cartridge which is inserted into the printer, as there may be ink on the connection.



C6074225

Ink Cartridge Installation

Ink Cartridge Installation

NOTE: Each ink cartridge slot has a colored label above it. This should match the colored label on the new ink cartridge.

- 1 Pick up the new ink cartridge and find the label identifying the ink color. Hold the ink cartridge so that you can see the identifying colored label at the top of the side facing you.
- 2 Insert the ink cartridge into the ink cartridge slot labelled with the same color.

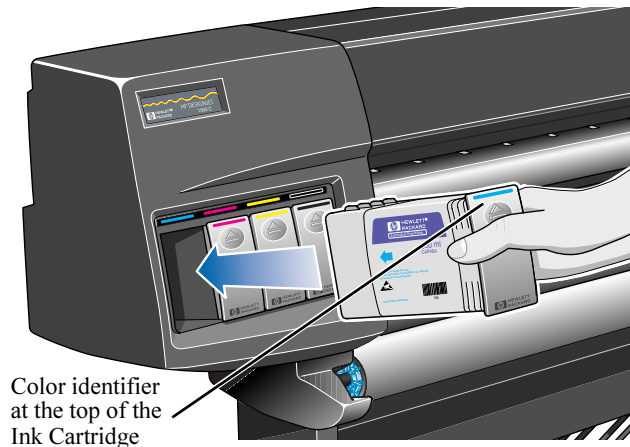

NOTE: The ink cartridge is designed to prevent you from inserting it upside down or into the wrong color slot. If you have difficulty inserting the ink cartridge, do not attempt to force it. Check again that the color of the ink cartridge matches the color of the ink cartridge slot, also that the colored marker is at the top of the ink cartridge.

- 3 Slide the ink cartridge into the slot until you feel some resistance and stop.

Ink Cartridge Installation

- 4 Press firmly with one finger, using the dimpled recess on the front of the ink cartridge, inwards and then downwards, as indicated by the arrow shown below, until the ink cartridge clicks into place.

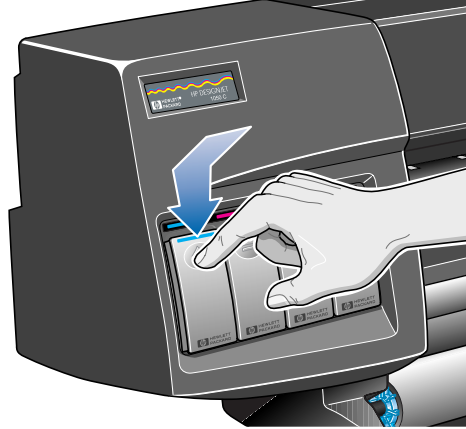

C6074226

- 5 The front panel displays:

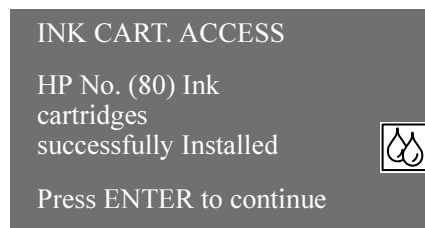

- 6 Press the **Enter** key to continue.

Printhead Status Messages

Printhead Status Messages

Detailed below are the printhead status messages that may come across while using the printer.

OK

The printhead is operating correctly and will provide an acceptable level of print quality. To find more information on your printheads you can go to 'Printhead info.' in the front panel. See page 51, *Obtaining Printhead Information*.

Ready/Replace

The front panel displays "Ready" and the printhead status is "Replace". The printer is giving an early warning that there maybe a degradation of print quality. You should buy a new printhead. Depending on the print mode you are using (best, normal or draft) the printer may be affected. Refer to the table on page 48.

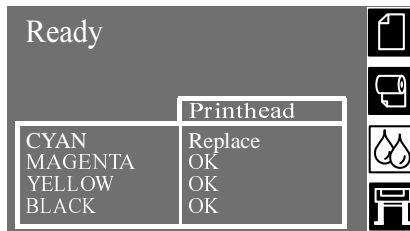

Ready		
Printhead		
CYAN	Replace	
MAGENTA	OK	
YELLOW	OK	
BLACK	OK	

The printer will still operate with a printhead that needs replacing, the front panel will display:

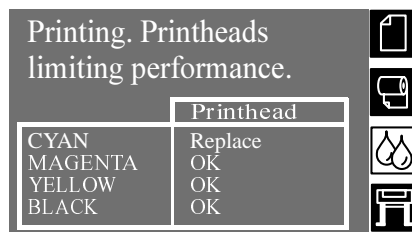

Printing. Printheads limiting performance.		
Printhead		
CYAN	Replace	
MAGENTA	OK	
YELLOW	OK	
BLACK	OK	

Printhead Status Messages

Front panel displays Ready/Replace		
Draft	Normal	Best
Print Quality is Affected	Print Quality is maintained but under the “normal” setting the printer changes the printing process to compensate for an ageing printhead. Subsequently the printer will print slower.	Printer will try to compensate for an ageing printhead
Speed not affected	Speed is affected	Speed not affected

Replace Printhead

The front panel displays a warning, meaning that the printhead has quite a few nozzles operating incorrectly. There is a risk that you could waste media. The printer will stop at the beginning of every print job and the front panel will display:

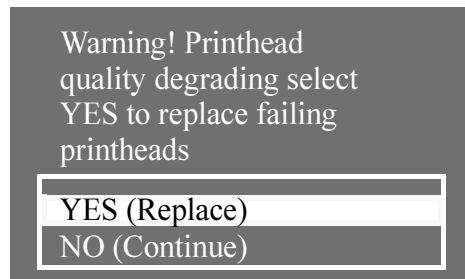

Press the ↓ or ↑ down key to select YES or NO. Press the **Enter** key. If you select **YES** the print job will be cancelled and a replacement will be started. See page 53, *Printhead Removal*. If you say **NO**, the printer will continue printing.

Next time you print, the same message will appear until you select YES (Replace).

Printhead Status Messages

Monitor

When this message is displayed it means that the printhead has reached its life expectancy.

NOTE: Printhead life is anticipated to be 700ml or twelve months in the printer, whichever occurs first, provided that the printhead is used under normal operating conditions (using HP ink cartridges only) and its “install before date” has not lapsed. However results vary depending on the print quality setting you use. The printer will attempt to warn you when this stage is reached with the monitor message.

To find out how to see the amount of ink consumed by the printhead and the usage time, go to page 51, *Obtaining Printhead Information*.

Even with the monitor message being displayed you may still obtain good image quality, but it could start degrading. Look at the images you are receiving and decide if they are of an acceptable print quality.

If you want to ensure optimum print quality with maximum unattendedness, you should consider buying a new printhead and replacing the old printhead with a new one.

Reseat

The printhead has moved slightly and is not making good electrical contact with the carriage assembly. Reseat the printhead into the correct position. This situation must be corrected before the printer will operate. For more help see page 53, *Printhead Removal* or refer to *chapter 11, Problems reseating the printhead in the User's Guide*.

Printhead Status Messages

Failed

This message generally indicates that the printhead must be replaced. However, this problem may be corrected by reseating the printhead. For more help refer to *chapter 11, Problems reseating the printhead in the User's Guide*. If by reseating the printhead, the failed message disappears but then reappears later, change the printhead. This situation must be corrected before the printer will operate.

Wrong Model

The printer does not recognize the printhead or printhead cleaner that you have inserted into the printer. You will have to remove it before the printer can continue.

Obtaining Printhead Information

Obtaining Printhead Information

- 1 To get information on your printheads, press the **Top** key on the front panel to go to the main menu.



- 2 Press the \uparrow or \downarrow key until the front panel displays the ink system menu. Press **Enter**.



- 3 Press the \uparrow or \downarrow key until the front panel highlights "Printhead info". Press the **Enter** key.

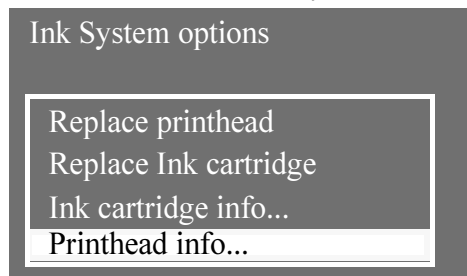

- 4 Press the \uparrow or \downarrow key until the front panel highlights the color that you want to see information on. Press the **Enter** key.

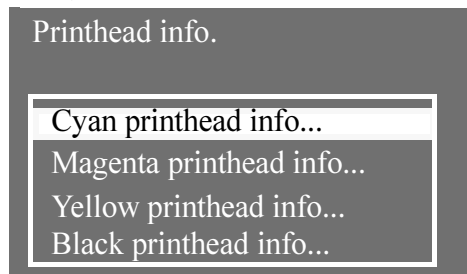

Obtaining Printhead Information

- 5 The front panel displays information on the selected printhead.

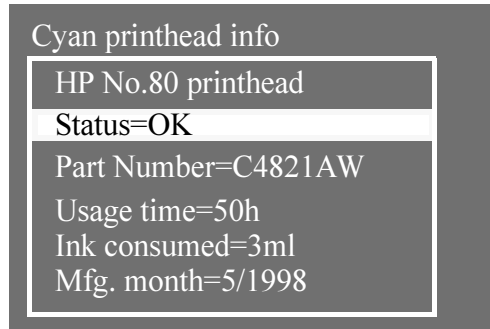

The information supplied is:

- The make of the printheads (HP No.80 are recommended)
- The current status of the printhead
- Re-order part number of the printhead
- The time that the printhead has been operating in the printer
- How much ink has been consumed by the printhead. It is possible for a printhead to consume more than one ink cartridge
- The month and the year that the printhead was manufactured

Printhead Removal

Printhead Removal

If the printer determines that a printhead will no longer provide the adequate print quality, a warning message will be displayed advising you to replace the printhead. See also *chapter 12, Messages and Descriptions* and *chapter 4, Working with HP No.80 Ink Supplies* in the *User's Guide*.

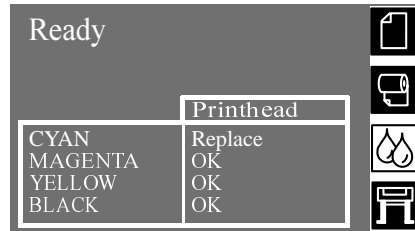

Printhead replacement must be performed with the printer switched on at both the Power Isolation Switch and the front panel **On/Off** push-button.

- 1 Press the **TOP** key on the front panel to go to the main menu.
- 2 Select the Ink System menu on the front panel by using the \uparrow and \downarrow keys, and then press the **ENTER** key.

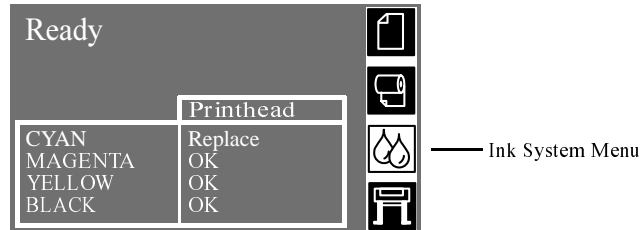

- 3 Select the "Replace printhead" option and press the **ENTER** key.

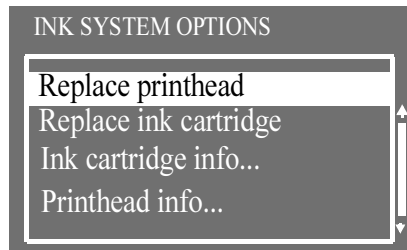

NOTE: The front panel will prompt you to lift the window and access the printheads.

Printhead Removal

- 4 Lift the window and locate the carriage assembly.

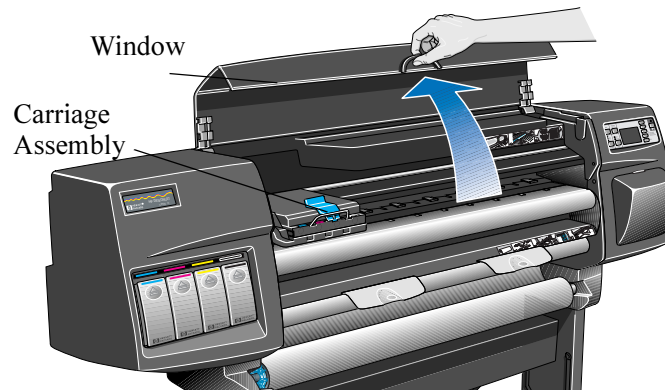

C6074028

- 5 Pull up and release the latch on top of the Carriage Assembly (as indicated by the arrow).

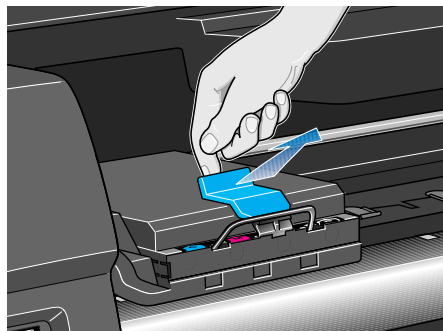

C6074231

- 6 Lift up the cover (as indicated by the arrow). This will now give you access to the printheads.

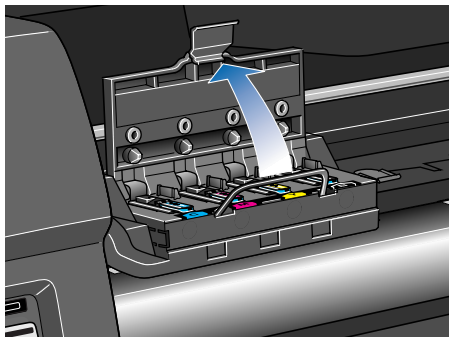

C6074233a

Printhead Removal

7 To remove a printhead, lift up the blue handle.

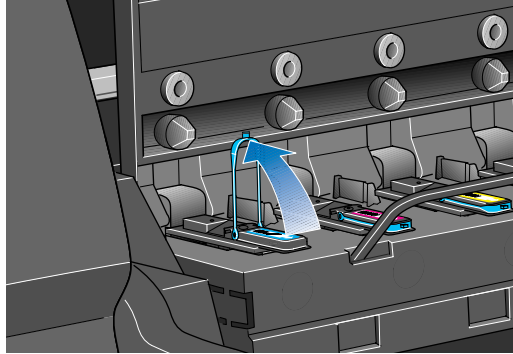

C6074261a

8 Place your index finger through the loop of the blue handle.

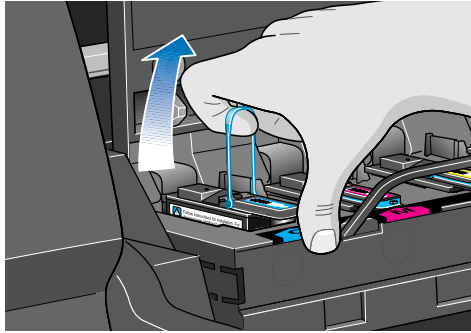

C6074261c

Printhead Removal

- 9 With controlled pressure pull the blue handle upward until the printhead is released from the carriage assembly.

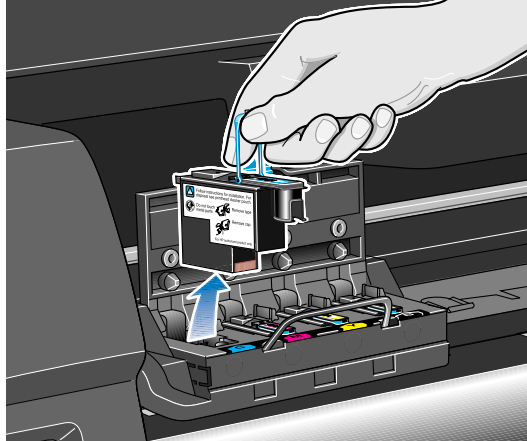

C60742.62a

- 10 When you remove the printhead, check the slot that you removed it from. If you notice the electrical contacts are dirty, clean them using the procedure on *chapter 11, Carriage Interconnect Wiper* in the *User's Guide*.

NOTE: For information on disposing of the old printhead see page 62

Printhead Installation.

Printhead Installation.

- 1 Remove the blue protective cap by pulling down on it.
- 2 Remove the clear protective tape from the printhead's nozzles by pulling on the paper tab.

NOTE: Make sure that all the tape has been removed.

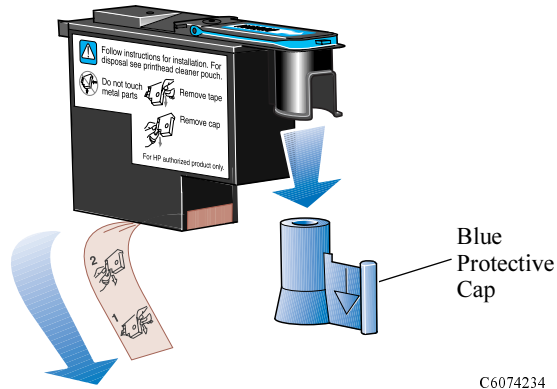

C6074234

NOTE: The printhead is designed to prevent you from accidentally inserting it into the wrong position. Check that the colored label on the printhead matches the colored label of the carriage assembly position that the printhead is to be inserted in.

- 3 Insert the new printhead into the correct carriage assembly position.
- 4 Push down in the direction indicated by the arrow shown below.

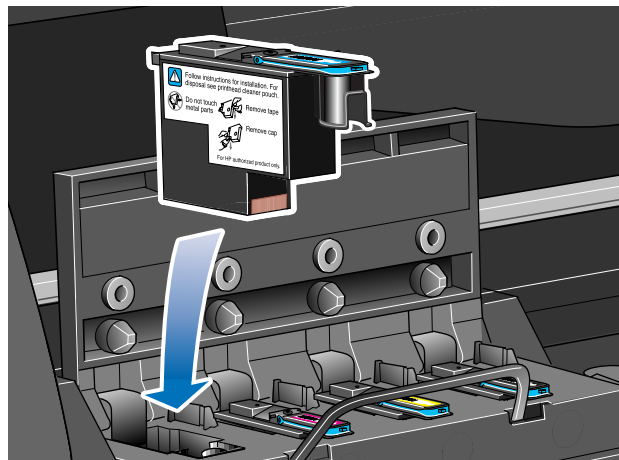

C6074235

Printhead Installation.

- 5 When installing the new printhead there may be some resistance, so you need to press it down firmly but smoothly. Only when **all** the printheads have been inserted correctly and accepted by the printer, will the printer then “BEEP”.

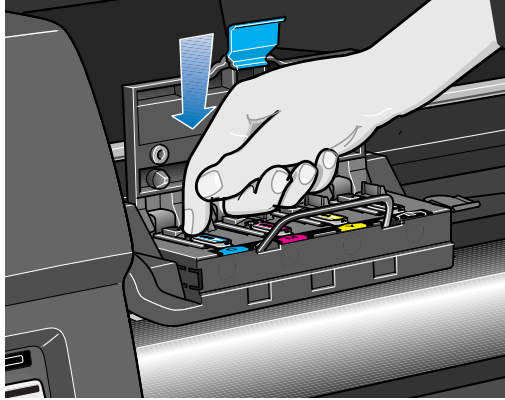

C6074264

NOTE: If the printer does not “beep” when you insert the printhead and the "Reseat" or “Failed” message appears on the front panel, the printhead may need reseating. See *chapter 11, Problems reseating the printhead* in the *User’s Guide*.

- 6 After replacing the printheads successfully the front-panel will prompt you to close the cover on the carriage and lower the window.



- 7 The front panel will now prompt you to replace the printhead cleaner. See page 59.

CAUTION

Leaving the old printhead cleaner in the printer will shorten the new printhead’s life and possibly damage the printer.

Printhead Cleaner Removal

Printhead Cleaner Removal

When removing the printhead cleaners:

- Be careful not to get ink on your hands. There may be ink on, around and inside the replaced printhead cleaner.
 - Do not lay the replaced printhead cleaner on its side or turn it upside down, as ink may leak out.
 - Always handle and store the replaced printhead cleaner upright to avoid spilling any ink.
- 1 After replacing a printhead the front panel will prompt you to replace the printhead cleaner.



- 2 The printhead cleaners are located in the slots, behind the service station door, at the front of the printer.

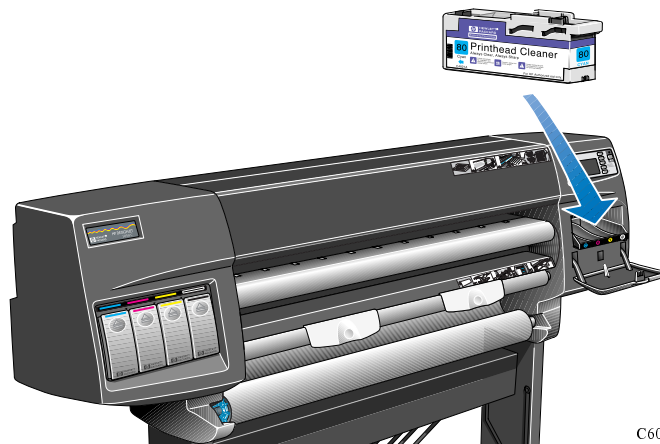

Printhead Cleaner Removal

- 3 Open the service station door to access the printhead cleaners.

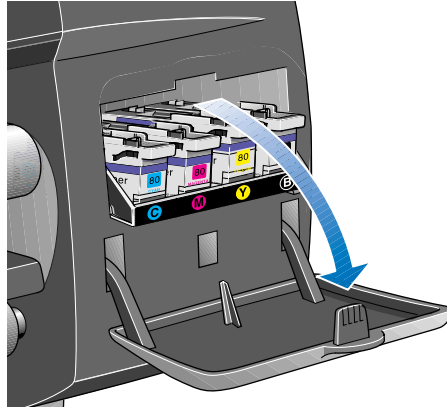

C6074040

- 4 When the door has been opened the front panel displays:

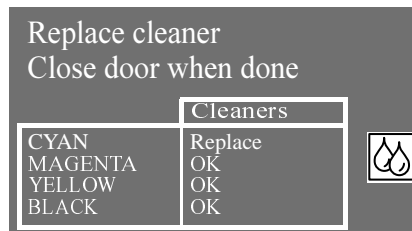

- 5 Each printhead cleaner has a handle on the front. To remove, press inward and upward as indicated by the arrow shown below, until the printhead cleaner is released.

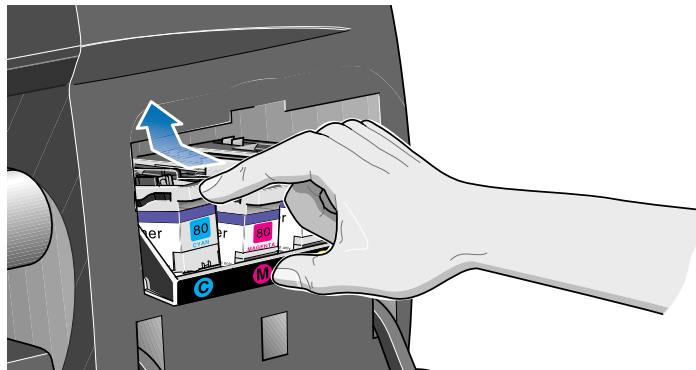

C6074244

Printhead Cleaner Removal

- 6 Lift the printhead cleaner up to remove it from the service station and slide the printhead cleaner out horizontally as shown below.

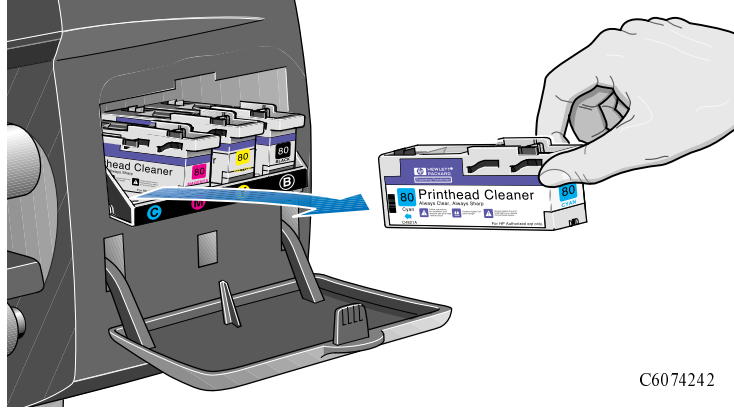

C6074242

CAUTION

When replacing a printhead always replace the corresponding printhead cleaner. Leaving the old printhead cleaner in the printer will seriously shorten the new printhead's life and possibly damage the printer.

Printhead Cleaner Installation

Printhead Cleaner Installation

The plastic bag which the new printhead cleaner comes in is re-usable. Follow the instructions on the back of the bag to dispose of the old printhead cleaner and the old printhead.

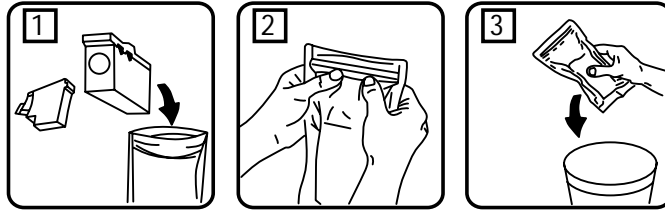

C6074311

- 1 Insert each printhead cleaner into the correct color slot location, in the service station, in the direction indicated by the arrow shown below.

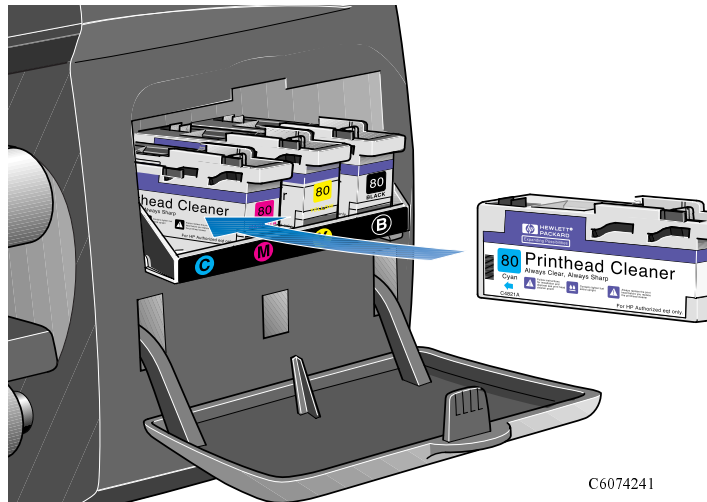

C6074241

Printhead Cleaner Installation

- 2 When the printhead cleaner has been pushed all the way in, press inwards and downwards as indicated by the arrow shown below, until it clicks into place. The front panel will not register the new printhead cleaner until the service station door is closed.

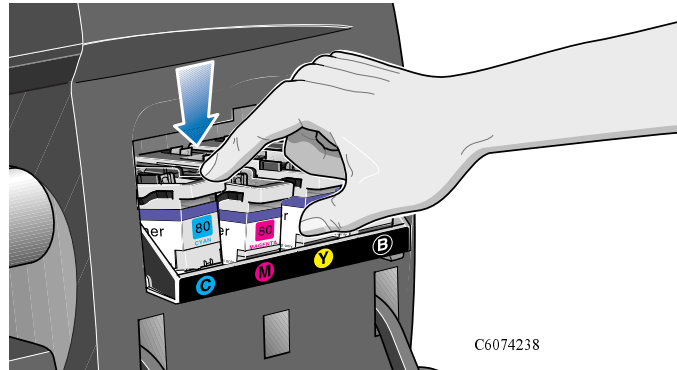

- 3 When you have inserted the printhead cleaner into the service station, close the door.

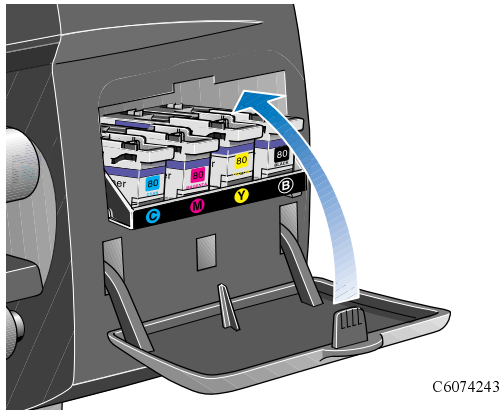

NOTE: The printer needs all the printheads and printhead cleaners installed before it can continue.

- 4 If paper is not loaded, the front panel will instruct you to load the paper. Refer to page 64, *After Replacing a Printhead and Printhead Cleaner*.

After Replacing a Printhead and Printhead Cleaner

After you replace a printhead and printhead cleaner, the printer will:

- perform tests on the printhead nozzles to ensure correct operation
- align the printheads

For more information on printhead alignment see *chapter 9, Aligning the Printheads*, in the *User's Guide*.

If there is no paper loaded, load paper following the directions on page 20. The alignment procedure requires an A1 or D-size paper width. An A2 or C-size cut sheet paper can only be accepted if loaded in the landscape position. You can load most of the HP supported papers to perform the printhead alignment procedure, however natural tracing paper will not work. Vellum can be used but it is not recommended.

When the front panel displays “**Ready**”, you are ready to print.

NOTE: Make sure the printer window and the right door are closed after you replace the HP No.80 supplies. The printer will not print while these are open.

NOTE: If after installing the HP No.80 supplies you experience problems see chapter 11 in the *User's Guide, Solving HP No.80 Supplies Problems*.

Front Panel Menu Structure

Front Panel Menu Structure

- 1 The items marked with an at-sign (@) require PostScript drivers.
- 2 Items in shaded boxes always appear in the front panel.
- 3 Items in white boxes only appear when Utilities/Menu mode is set to **Full**.

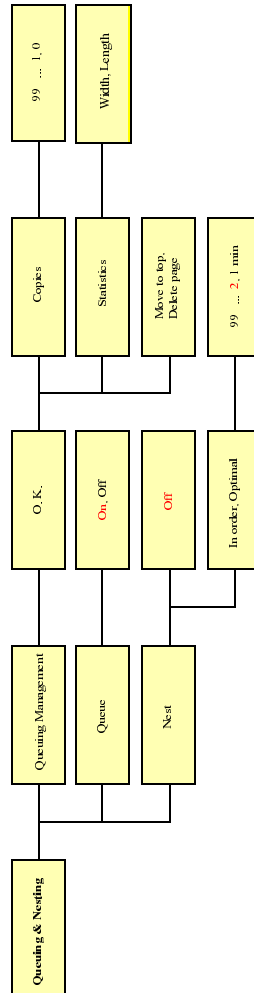

Front Panel Menu Structure

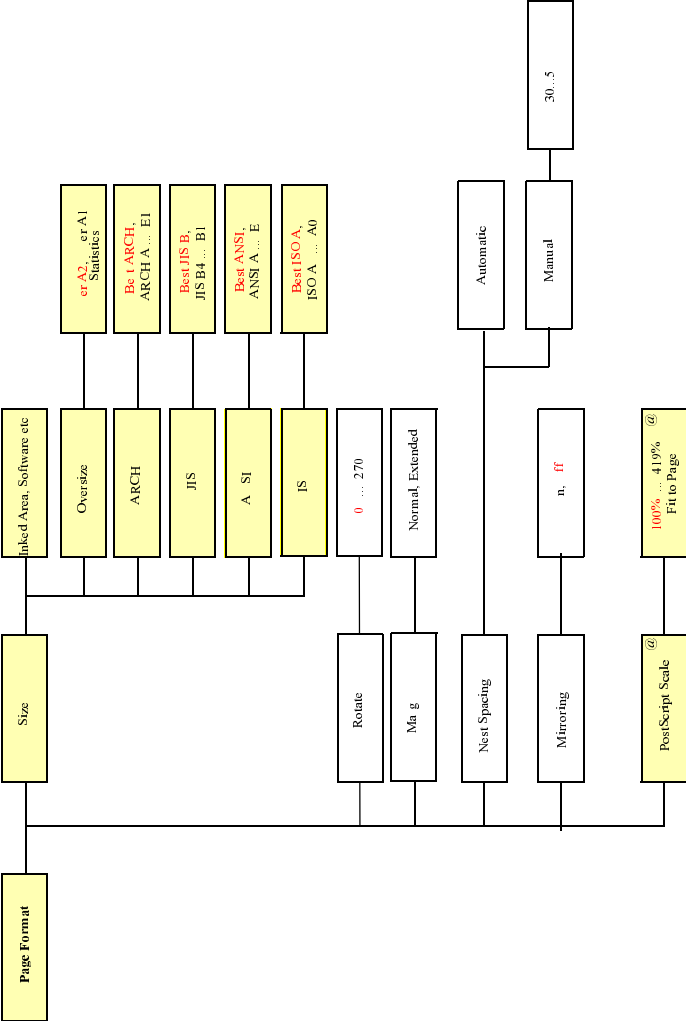

Front Panel Menu Structure

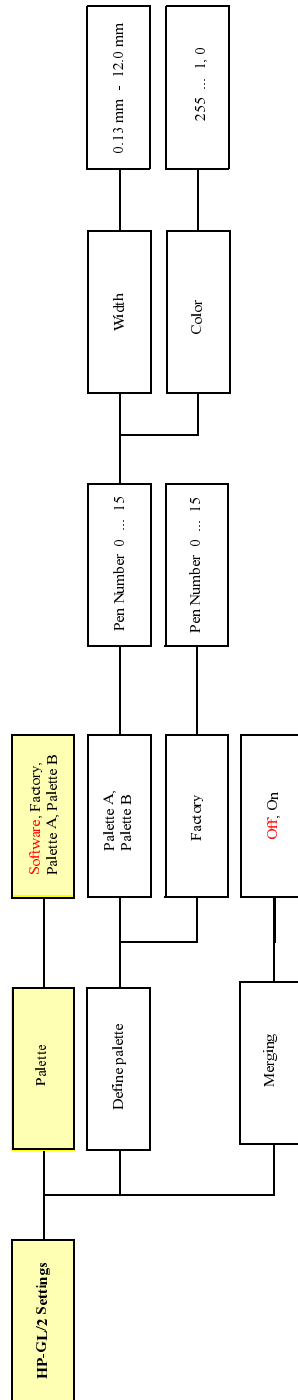

Front Panel Menu Structure

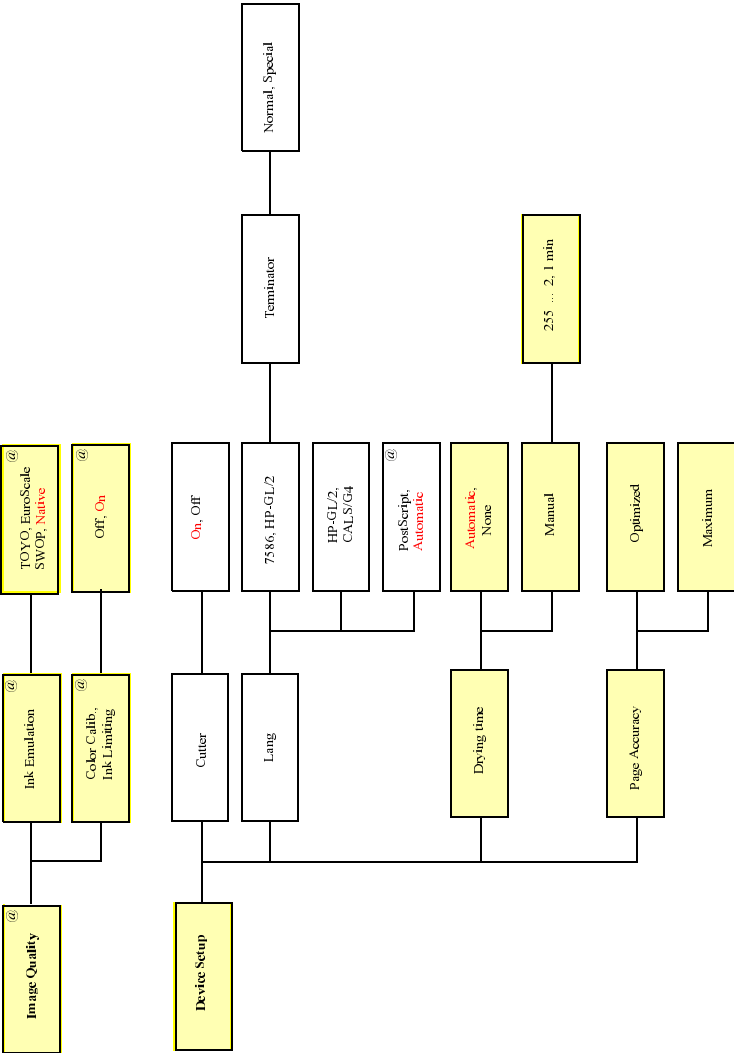

Front Panel Menu Structure

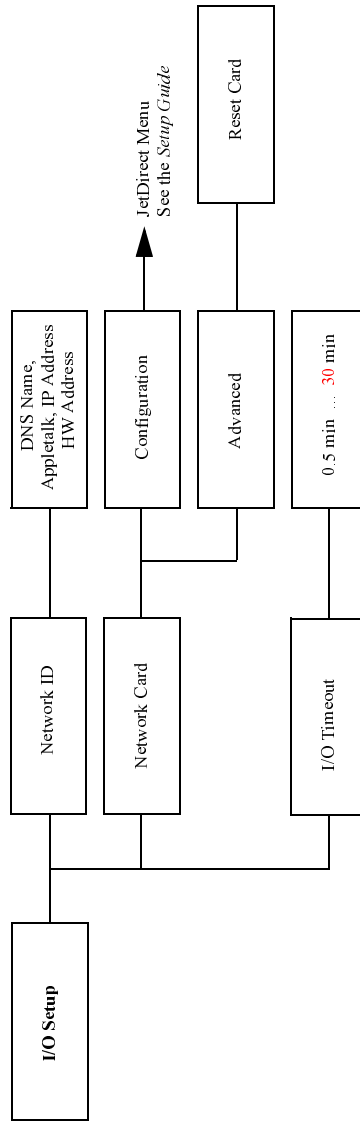

Front Panel Menu Structure

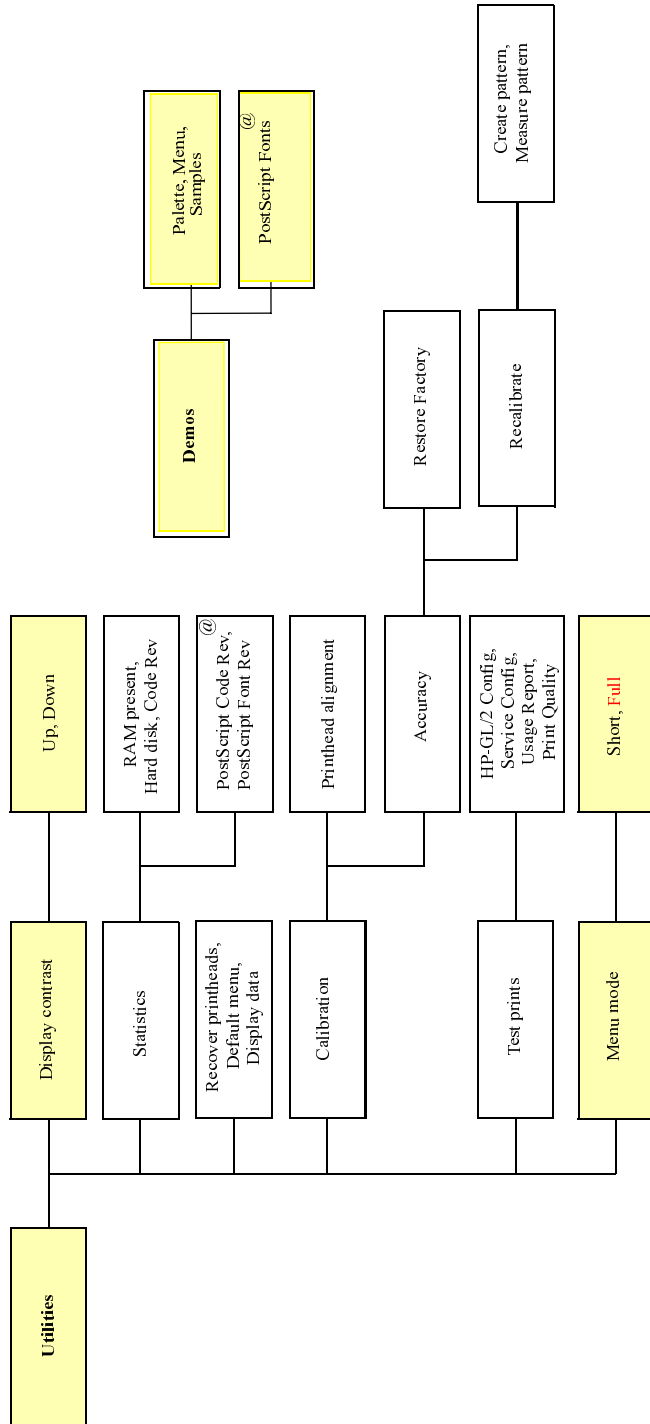

Hewlett-Packard Support Services

About HP Customer Care

As your strategic support partner, we make it our business to help keep your business running smoothly. HP Customer Care offers award-winning support to ensure you get the most from your HP DesignJet.

HP Customer Care provides comprehensive, proven support expertise and leverages new technologies to give customers unique end-to-end support. Services include setup and installation, troubleshooting tools, warranty upgrades, repair and exchange services, phone and Web support, software updates, and self-maintenance services. To find out more about HP Customer Care, please visit us at:

www.hp.com/go/support

In the unlikely event that you do have problems;

- 1 Review the troubleshooting suggestions in *chapter 11, Troubleshooting* in the *User's Guide* and your printer driver documentation, and any relevant software application notes.
- 2 If the problem appears to be related to your software application, first contact your software vendor.
- 3 If you still have difficulty, begin by contacting your HP dealer. The sales representative is familiar with your needs, equipment, and software, and should be able to provide you with the information you want. If necessary, you can subsequently call Hewlett-Packard for support.
- 4 Visit our web page www.designjet-online.hp.com
NOTE: For a list of the support services available, refer to the HP Support Services booklet shipped with your printer.
- 5 If you call one of the HP offices, please have the following information available to help us answer your questions quickly:
 - a) The printer you are using (Part Number and Serial Number found on the label at the back of the printer).
 - b) The computer you are using.
 - c) Any special equipment or software you are using (for example spoolers,

Hewlett-Packard Support Services

- networks, switch-boxes, modems, or special software drivers).
- d) The part number of the cable used and where purchased from.
- e) The type of interface used on the printer (parallel or serial).
- f) The software name and version currently being used.
- g) If the problem is a software error, it will have an error number; record the error number and have it ready.
- h) If possible print out the Usage Report, PostScript Configuration, and the Service print. *Refer to chapter 2, Printing Internal Prints in the User's Guide* and fax them to the support center helping you.

User Tips (Finding other Information)

User Tips (Finding other Information)

To find how to...	
Install and connect the printer	User's Guide Chapter 1
Use the front panel	User's Guide Chapter 2
Load the Roll Paper	User's Guide Chapter 3
Load the Sheet Paper	User's Guide Chapter 3
Use the Modular Ink Supplies	User's Guide Chapter 4
Install the Ink Cartridge	User's Guide Chapter 4
Install the Printhead	User's Guide Chapter 4
Install the Printhead Cleaner	User's Guide Chapter 4
Control the Page Format	User's Guide Chapter 5
Control the appearance of the Print	User's Guide Chapter 6
Manage the Print	User's Guide Chapter 7
Queue and Nest	User's Guide Chapter 7
Reconfigure the Printer	User's Guide Chapter 8
Control the Image Quality	User's Guide Chapter 9
Maintain the Printer	User's Guide Chapter 10
Troubleshoot the Printer	User's Guide Chapter 11
Troubleshoot the Print Quality	User's Guide Chapter 11
Use the Front Panel Messages	User's Guide Chapter 12
General specifications	User's Guide Chapter 13
To find any other information about your printer, go to the index at the back of the User's Guide.	



6071-90141

English
This guide has been printed on chlorine-free paper
Printed in Europe