

hp photosmart
7200 series

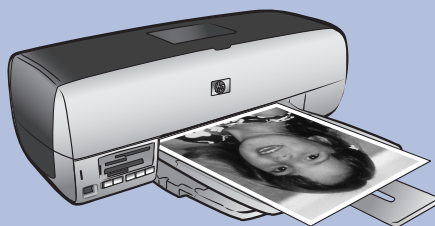

basics guide



© Copyright 2003 Hewlett-Packard Company

All rights are reserved. No part of this document may be photocopied, reproduced, or translated to another language without the prior written consent of Hewlett-Packard Company.

The information contained in this document is subject to change without notice. Hewlett-Packard shall not be liable for errors contained herein or for consequential damages in connection with the furnishing, performance, or use of this material.

HP, the HP logo, and Photosmart are property of Hewlett-Packard Company.

The Secure Digital logo is a trademark of the SD Association.

Microsoft and Windows are registered trademarks of Microsoft Corporation.

CompactFlash, CF, and the CF logo are trademarks of the CompactFlash Association (CFA).

Sony Memory Stick is a registered trademark of Sony Corporation.

MultiMediaCard is a trademark of Infineon Technologies AG of Germany, and is licensed to the MMCA (MultiMediaCard Association).

SmartMedia is a trademark of Toshiba Corporation.

xD-Picture Card is a trademark of Fuji Photo Film Co., Ltd., Toshiba Corporation, and Olympus Optical Co., Ltd.

IBM is a registered trademark of International Business Machines Corporation.

Mac, the Mac logo, and Macintosh are registered trademarks of Apple Computer, Inc.

Pentium is a registered trademark of Intel Corporation.

Other brands and their products are trademarks or registered trademarks of their respective holders.

The embedded software in your printer is based in part on the work of the Independent JPEG Group.

The copyrights to certain photos within this document are retained by the original owners.

Regulatory Model Identification Number

For regulatory identification purposes, your product is assigned a Regulatory Model Number. The Regulatory Model Number for your product is SDGOA-0372. This regulatory number should not be confused with the marketing name (Disk System 2400) or product numbers (A6214A, A6214AZ).

safety information

Always follow basic safety precautions when using this product to reduce risk of injury from fire or electric shock.

Warning! To prevent fire or shock hazard, do not expose this product to rain or any type of moisture.

Warning! Potential shock hazard.

- Read and understand all instructions in the *HP Photosmart Setup Guide*.
- Use only a grounded electrical outlet when connecting the unit to a power source. If you do not know whether the outlet is grounded, check with a qualified electrician.
- Observe all warnings and instructions marked on the product.
- Unplug this product from wall outlets before cleaning.
- Do not install or use this product near water or when you are wet.
- Install the product securely on a stable surface.
- Install the product in a protected location where no one can step on or trip over the power cord, and where the power cord will not be damaged.
- If the product does not operate normally, see the troubleshooting information in the HP Photosmart Printer Help.
- There are no operator serviceable parts inside. Refer servicing to qualified service personnel.
- Use in a well-ventilated area.



contents

1	get started	1
	welcome	1
	find information	1
	what's in the box?	2
	printer parts	3
	front	3
	front with main cover open	3
	back	4
	control panel	4
	indicator lights	6
	memory card slots	6
	paper information	7
	load paper in the in tray	7
	load paper in the photo cassette	8
	remove the photo cassette	10
	maintain the quality of your photo paper	11
	store the paper trays	11
	print cartridge information	12
	install or replace a print cartridge	13
	calibrate the print cartridges	15
	remove the print cartridge	16
	print cartridge storage	17
	use ink-backup printing mode	18
2	print from a memory card	19
	supported memory cards	19
	insert a memory card	20
	remove a memory card	23
	print photos from a memory card	24
	use the hp photosmart 7200 series assistant	24
	print from the control panel	24
	print 4 x 6 inch (10 x 15 cm) photos	24
	print a photo collage	26
	print camera-selected photos using the control panel	27
	save photos from the control panel	28
3	print using the hp photosmart 7200 series assistant	29
	use the hp photosmart assistant	29
	view memory card information provided by the assistant	30
	view error condition information provided by the assistant	31
4	print using the direct-printing port	33
	connect your hp digital camera to the direct-printing port	33

	connect your notebook computer to the direct-printing port . . .	34
5	print from your computer	37
	print using your Windows PC.	37
	use the Windows PC taskbar icons	38
	print using your Macintosh.	40
6	specifications	43
	recommended paper	43
	printer specifications	44
7	troubleshooting	47
	hardware problems	47
	printing problems	48
	index.	57



get started

welcome

Thank you for purchasing an HP Photosmart 7200 Series printer! With your new photo printer, you can print beautiful photos, save photos to your computer, and create fun and easy projects.

For information about:

- Printing photos stored on your memory card, see **print from a memory card** on page 19.
- Printing camera-selected photos stored on your memory card, see **print camera-selected photos using the control panel** on page 27.
- Printing borderless photos from your computer, see **print from your computer** on page 37.
- Printing camera-selected photos by connecting your HP direct-printing digital camera to your printer, see **connect your hp digital camera to the direct-printing port** on page 33.
- Saving photos to your computer, see the HP Photosmart Printer Help. For information about viewing the Printer Help, see **view the hp photosmart printer help** on page 2.

find information

Your new printer comes with the following documentation to help you get started and take full advantage of your printer's capabilities:

- **Setup Guide**—The *HP Photosmart 7200 Series Setup Guide* contains quick and easy instructions to help you set up your printer and install the printer software.
- **Basics Guide**—The *HP Photosmart 7200 Series Basics Guide* is the booklet you are reading. This booklet describes the basic features of your printer and contains hardware troubleshooting information.
- **Setup & Support Reference Guide**—The *HP Photosmart Setup & Support Reference Guide* explains how to install and set up the software that comes with your printer. This guide contains software troubleshooting information, describes how to get support from www.hp.com/support, and explains how to contact HP support.
- **HP Photosmart Printer Help**—The HP Photosmart Printer Help describes how to use the more advanced features of your new printer. The Printer Help includes information about printer care and maintenance, advanced troubleshooting, and error messages.

After you have installed the HP Photosmart printer software on your computer, you can view and print the HP Photosmart Printer Help.

view the hp photosmart printer help

- **Windows® PC:** From the **Start** menu, select **Programs** (in Windows XP, select **All Programs**); **Hewlett-Packard; Photosmart 140, 240, 7200, 7600, 7700, 7900 Series; Photo & Imaging Director**. From the **Photo & Imaging Director**, click **Help**.
- **Macintosh®:** Insert the HP Photosmart CD. In the **User Docs** folder, select your **language**, then double-click the **photosmart 7260.html** file.

print the hp photosmart printer help

- **Windows PC:** Click **Print** in the top navigation bar of the HP Photosmart Printer Help window.
- **Macintosh:** Click in the frame you want to print. From the **File** menu, select **Print**, or click **Print** in the top navigation bar of the browser.

what's in the box?

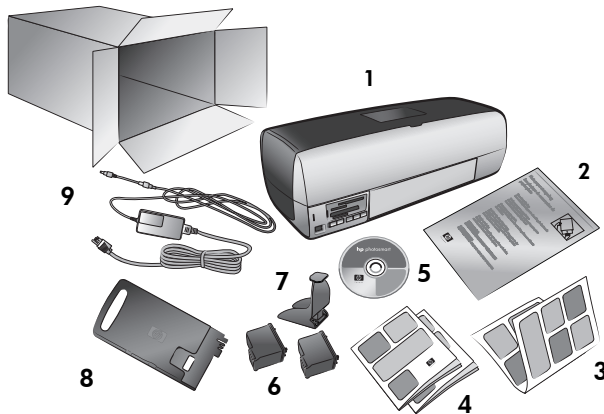

Your printer box contains the following items:

- 1 HP Photosmart 7200 Series printer
- 2 Photo paper storage bag
- 3 *HP Photosmart 7200 Series Setup Guide*
- 4 *HP Photosmart 7200 Series Basics Guide* and *HP Photosmart Setup & Support Reference Guide*
- 5 HP Photosmart 7200 Series printer software CD
- 6 HP Photosmart CD HP #57 tri-color print cartridge and HP #58 photo print cartridge
- 7 Print cartridge protector
- 8 Photo cassette
- 9 Power supply (may vary in appearance or have an additional power cord)

printer parts

front

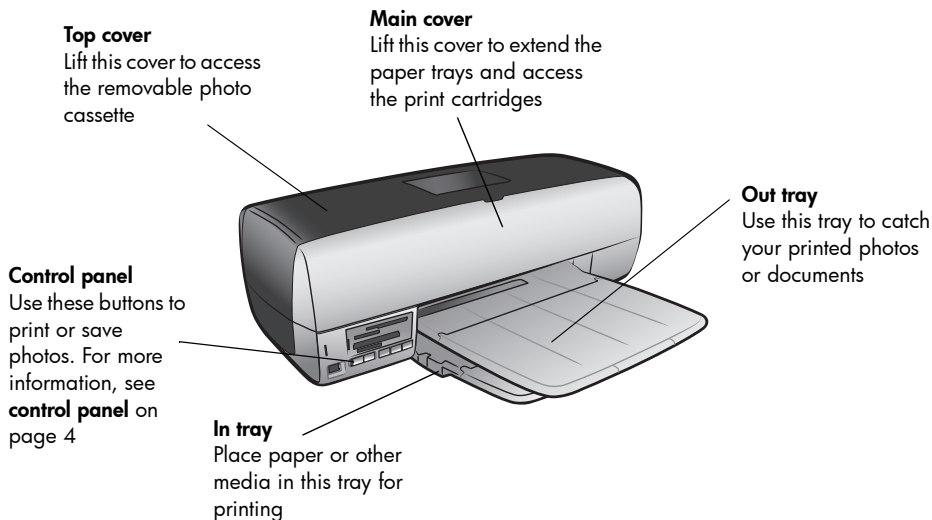

front with main cover open

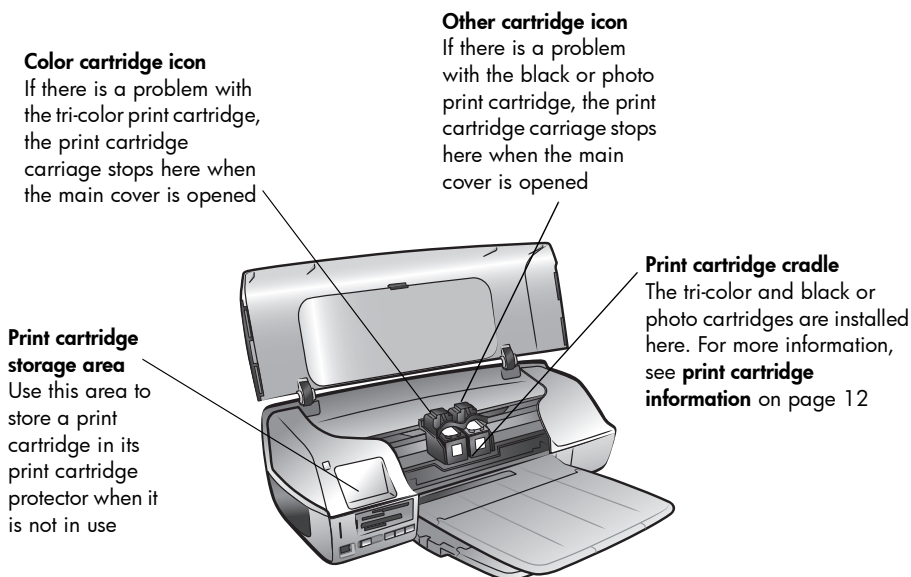

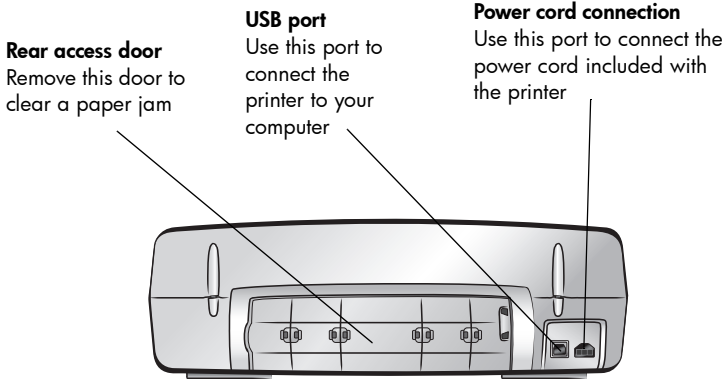

back



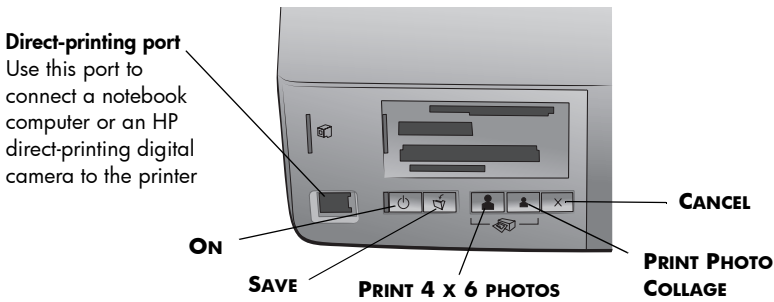

control panel

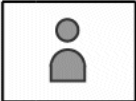
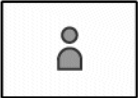

See the following table for a description of button functions.

Button	Description
	ON Press this button to turn the printer on or off.
	SAVE Press this button to save the contents of the memory card to your computer.

Button	Description
	<p>PRINT 4 x 6 PHOTOS</p> <p>Use this button to print 4 x 6 inch photos:</p> <ul style="list-style-type: none"> • Press this button to print all photos or all camera-selected photos on the memory card. • Press and hold this button to print all photos on a memory card that have not been previously printed from the control panel. • Press this button to continue printing after resolving a printing error. • Press this button to continue printing after reloading paper.
	<p>PRINT PHOTO COLLAGE</p> <p>Use this button to print photo collage pages:</p> <p>Note: A photo collage prints four images on 4 x 6 inch paper or nine images on 8.5 x 11 inch paper.</p> <ul style="list-style-type: none"> • Press this button to print all photos or all camera-selected photos on the memory card on photo collage pages. • Press and hold this button to print on photo collage pages all photos on a memory card that have not been previously printed from the control panel. • Press this button to continue printing after resolving a printing error. • Press this button to continue printing after reloading paper.
	<p>CANCEL</p> <p>Use this button to stop a process:</p> <ul style="list-style-type: none"> • Press this button to stop printing. • Press this button to stop saving images from the memory card to your computer. • Press this button to skip printing camera-selected photos on a memory card so you can print unmarked photos.

indicator lights

Print cartridge status light Green

A print cartridge is low on ink

Red

One of the print cartridges is not installed correctly or has failed

Printer status light Off

The printer is off

Green

The printer is on

Blinking (Green)

The printer is busy

Blinking (Red)

The printer requires attention

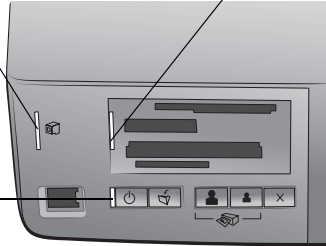

Memory card light Off

There is no memory card inserted

Green

The memory card is inserted correctly

Blinking (Green)

Information is being transmitted between the memory card and the printer or computer

Blinking (Red)

There is a problem with the memory card or more than one memory card is inserted into a memory card slot

Blinking (Red then Green) after pressing the PRINT button

There are no photos on the memory card

memory card slots

Sony® Memory Stick memory card slot

You can insert a supported Sony Memory Stick memory card into this slot

MultiMediaCard™/Secure Digital™ memory card slot

You can insert a MultiMediaCard or a Secure Digital memory card into this slot

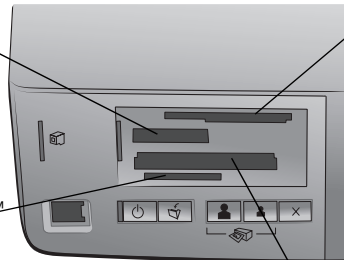

SmartMedia™/xD-Picture Card™ memory card slot

You can insert a SmartMedia memory card into the upper portion of this slot or an xD-Picture Card memory card into the lower right portion of this slot

CompactFlash™/IBM® Microdrive memory card slot

You can insert a CompactFlash or an IBM Microdrive memory card into this slot

paper information

You can print your photos on a wide variety of paper sizes, from 3 x 5 inches (76 x 127 mm) up to 8.5 x 14 inches (216 x 356 mm) paper, and on 4 x 6 inch (10 x 15 cm) photo paper.

If you are using HP premium plus photo paper, select the paper type when you set up the printing project. For more information, see **print using your Windows PC** on page 37 or **print using your Macintosh** on page 40.

For a list of available HP-designed inkjet paper, or to purchase supplies, go to:

- www.hpshopping.com (U.S.)
- www.hp-go-supplies.com (Europe)
- www.jp.hp.com/supply/inkjet (Japan)
- www.hp.com/paper (Asia/Pacific)

load paper in the in tray

You can load paper in many different sizes, from 3 x 5 inches (76 x 127 mm) up to 8.5 x 14 inches (216 x 356 mm), in the In tray. For more information about supported paper types and sizes, see **recommended paper** on page 43.

Note: The photo cassette must not be installed when printing on paper loaded in the In tray.

- 1 Lift the main cover of the printer, and slide the paper width guide as far to the left as it will go.

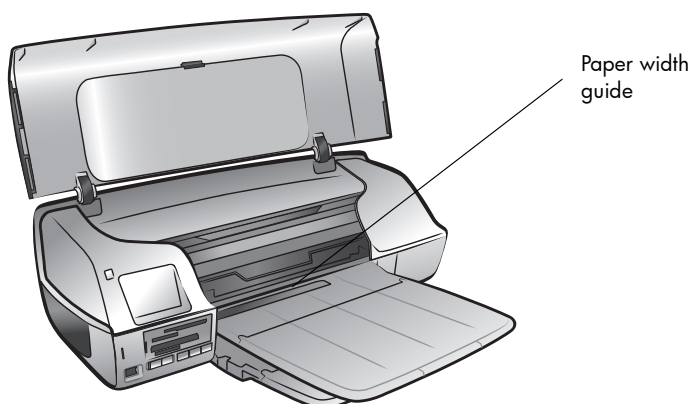

- 2 Lift the Out tray and place a stack of paper in the In tray.

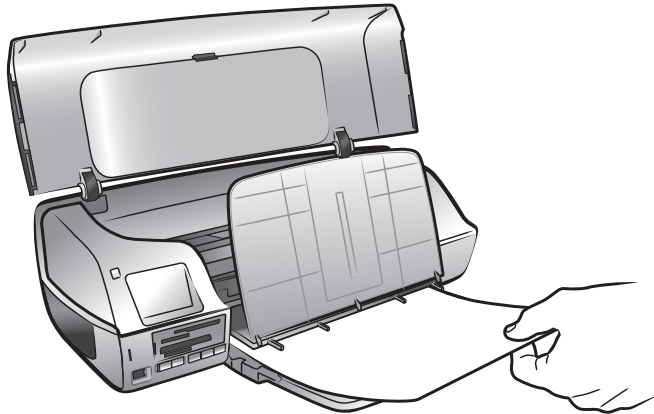

- Load the paper with the **side to be printed facing down**.
 - Always load paper in the portrait orientation, with the shortest edge feeding into the printer.
 - Be careful not to use too much or too little paper. It may be difficult for the printer to pick up a sheet of paper when there are only one or two sheets in the In tray. For more information about the amount of paper to load in the In tray, see **printer specifications** on page 44.
 - Use one type and size of paper at a time. Do not mix paper types or sizes in the In tray.
- 3 Push the paper into the printer as far as it will go without bending.
 - 4 Lower the Out tray.
 - 5 Adjust the paper width guide to fit snugly against the edge of the paper without bending the paper. The paper width guide holds the paper straight as it feeds into the printer.
 - 6 Close the main cover.

load paper in the photo cassette

Use the photo cassette to load 4 x 6 inch (10 x 15 cm) paper. To print borderless photos, use 4 x 6 inch photo paper with a 0.5 inch tab (10 x 15 cm with 1.25 cm tab); the photo prints without borders on three sides and with a small border on the bottom edge that you can tear off. HP does not recommend printing borderless photos on plain paper. For more information about recommended paper types, see **recommended paper** on page 43.

Note: Before inserting the photo cassette into the printer, be sure to remove any paper from the In tray.

- 1 Lift the top cover on the printer and remove the photo cassette.
- 2 Place up to 20 sheets of photo paper in the photo cassette with the **side to be printed facing down**. If you are using tabbed paper, insert the paper so the tabbed end goes into the cassette first.

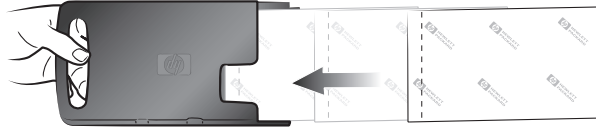

- 3 Slide the paper width guide all the way to the left and remove any paper from the In tray.
- 4 Lift the main cover.
- 5 Lift the Out tray and line the photo cassette up with the far right edge of the In tray.

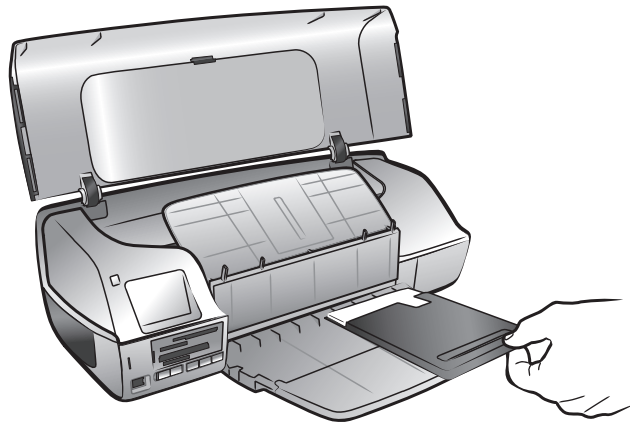

- 6 Gently slide the photo cassette into the printer until it snaps into place.

Note: Check the icon on the photo cassette to ensure that you are inserting the photo cassette in the correct orientation. The HP logo on the photo cassette should be facing up.

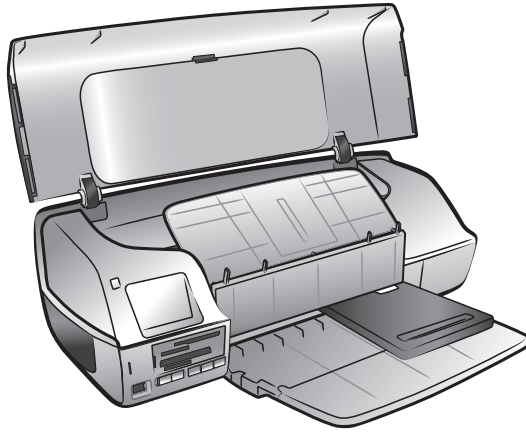

- 7 Lower the Out tray.
- 8 Slide the paper width guide to the right until it cradles the photo cassette, and then close the main cover.

remove the photo cassette

When you are finished printing 4 x 6 inch (10 x 15 cm) photos, follow these steps to remove the photo cassette:

Note: The photo cassette must be removed to print on paper loaded in the In tray.

- 1 Lift the main cover and slide the paper width guide all the way to the left.
- 2 Lift the Out tray.

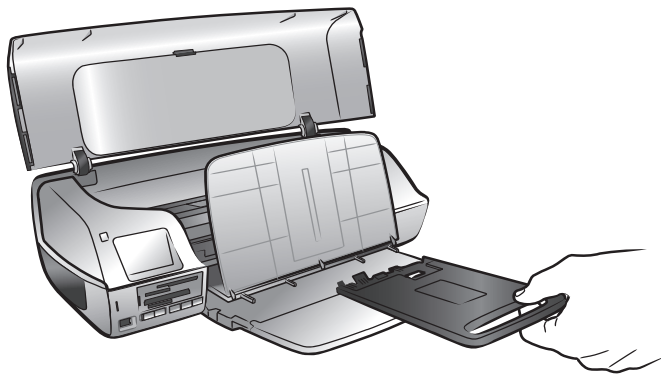

- 3 Grasp the photo cassette by the handle and gently pull the photo cassette toward you until it disengages from the printer.
- 4 Lower the Out tray and close the main cover.

maintain the quality of your photo paper

To ensure high-quality prints, it is important to maintain the quality of your photo paper. This section provides information about storing and handling your photo paper.

store photo paper

Keep unused photo paper in the photo paper storage bag that was shipped with your printer. Store the packaged photo paper on a flat surface in a cool, dry place.

When you are ready to print, remove only the paper you plan to use immediately. When you have finished printing, return any unused photo paper to the photo paper storage bag and seal it.

Note: Do not leave unused paper in the printer's paper tray. The paper may start to curl, which may reduce the quality of your photographs. Photo paper should be flat before printing.

handle photo paper

Always hold photo paper by the edges. Fingerprints on photo paper can reduce print quality.

If the corners of the photo paper curl, place the paper in a resealable plastic bag and gently bend it in the opposite direction of the curl until the paper lies flat.

store the paper trays

For safe and convenient storage of your printer, the Out and In trays fold up into your printer. You can store the paper trays by following these steps:

- 1 Turn off the printer.
- 2 Lift the main cover.
- 3 Lift and fold back the Out tray.

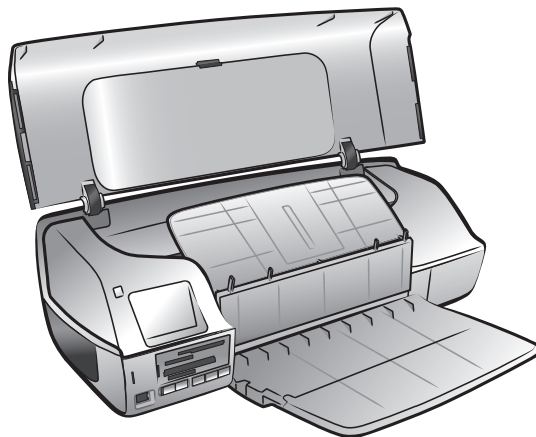

- 4 Lift and fold up the In tray so that it lies over the Out tray.

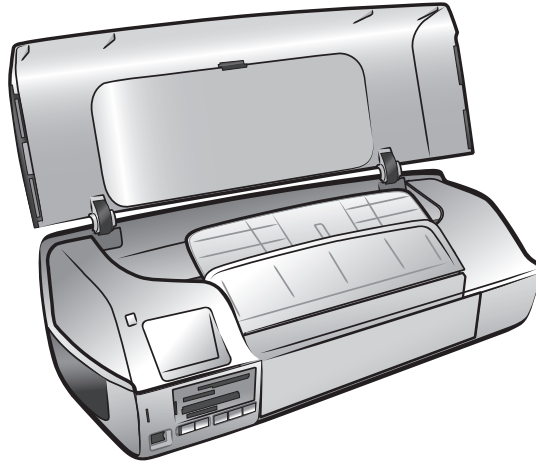

- 5 Close the main cover.

print cartridge information

Your HP Photosmart 7200 Series printer prints in color and in black and white. HP provides a range of print cartridges so that you can choose the best print cartridges for your project.

Installing a print cartridge that is not in this table may invalidate your printer warranty.

To print...	Use these print cartridges...
Color or black and white documents	HP #57 (C6657A) —Tri-color print cartridge and HP #56 (C6656A) —Black print cartridge
Color photos	HP #57 (C6657A) —Tri-color print cartridge and HP #58 (C6658A) —Photo print cartridge

When you install a print cartridge, match the number on the print cartridge to the number on the inside of the main cover. The printer holds two print cartridges at a time.

Caution! Check that you are using the correct print cartridges. Also, note that HP does not recommend modifying or refilling HP print cartridges. Damage that results from modifying or refilling HP print cartridges is not covered by HP's warranty.

Whenever you remove a print cartridge from the printer, store it in a print cartridge protector. Failure to properly store your print cartridge can cause the print cartridge to fail. For more information about storing your print cartridges, see **print cartridge storage** on page 17.

install or replace a print cartridge

To get the best performance from your printer, use only genuine HP factory-filled print cartridges.

To get maximum use from your print cartridges, turn off the printer when it is not in use. Do not unplug the printer or turn off the power source (such as a power strip) until the Printer Status light is off. Waiting to turn off the printer allows it to store the print cartridges properly.

- 1 If the printer is off, press the **ON** button on the printer's control panel to turn on the printer.
- 2 Lift the main cover of the printer. The print cartridge cradle moves to the middle of the printer.

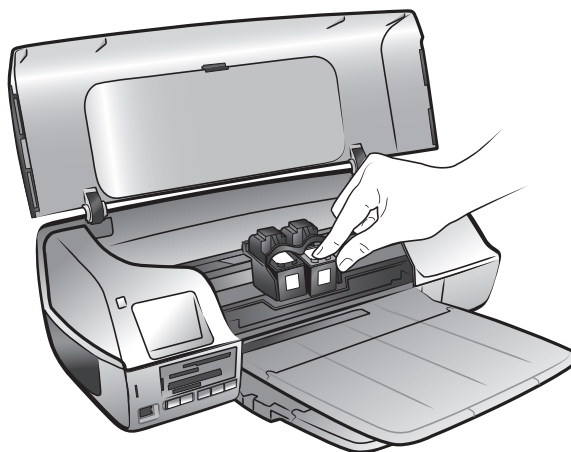

- 3 If you are replacing a print cartridge, push down and pull outward on the print cartridge to unsnap it from the print cartridge cradle. Remove the print cartridge and store, recycle, or discard it. For information about recycling print cartridges, go to www.hp.com/recycle.

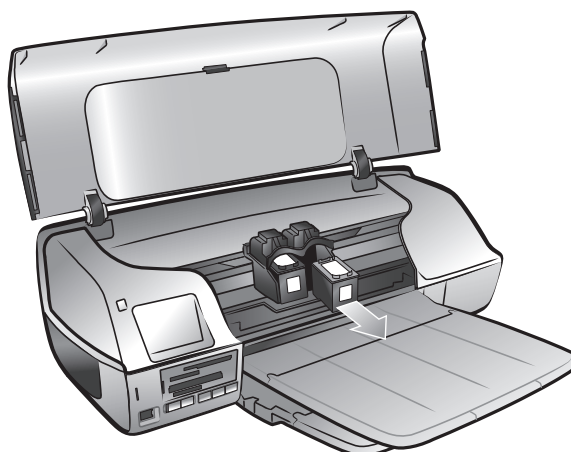

- 4 Take the new print cartridge out of its package.

- 5 Grasp the pink tab and gently peel off the clear plastic tape. Make sure you remove only the clear tape. Be sure to install the print cartridge immediately after removing the tape; ink nozzles exposed longer than one minute may dry out and cause printing problems later. Once the tape is removed, do not attempt to replace it.

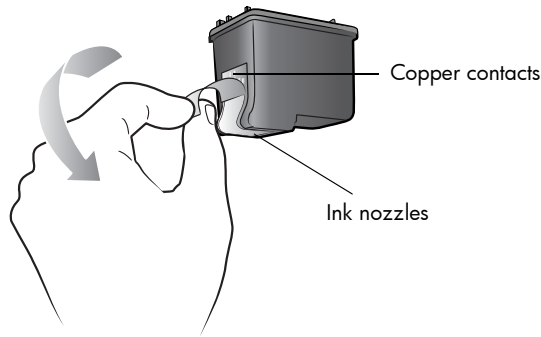

Caution! Do not touch the ink nozzles or the copper contacts on the print cartridge. Touching these parts may cause the print cartridge to fail.

- 6 Insert the print cartridge:

Note: The tri-color print cartridge must be installed in the left stall of the print cartridge cradle. The black or the photo print cartridge must be installed in the right stall of the print cartridge cradle.

- a. Hold the print cartridge so the copper contacts go into the print cartridge cradle first. Line up the ridges on the left and right sides of the top of the print cartridge with the grooves on the inside of the print cartridge cradle. The label on the print cartridge should face upwards.
- a. Carefully slide the print cartridge into the print cartridge cradle at a slight angle, then firmly push the print cartridge in until it snaps into place.

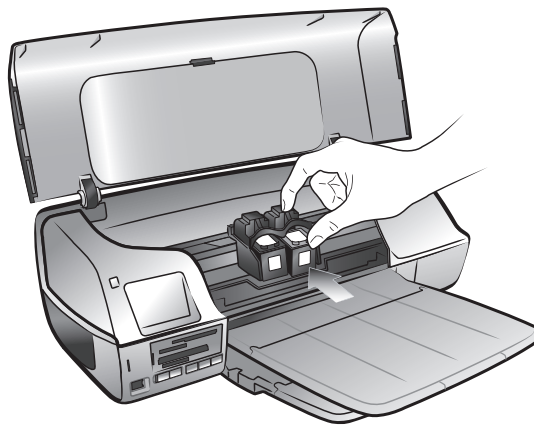

- 7 Repeat steps 3–6 to install the second print cartridge.
- 8 Close the main cover.

calibrate the print cartridges

To ensure high-quality prints, each time you install or replace one or both of the print cartridges, calibrate the cartridges to check that they are properly aligned. You can calibrate the print cartridges using a Windows PC or a Macintosh computer.

To calibrate the print cartridges using your Windows PC:

- 1 If the printer is off, press the **ON** button on the printer's control panel to turn on the printer.
- 2 Load paper in the In tray. For more information, see **load paper in the in tray** on page 7.
- 3 Right-click the printer icon on the Windows taskbar, and select **Open hp photosmart 7200 series toolbox** from the menu that appears. For more information about opening the HP Photosmart Series Toolbox, see the HP Photosmart Printer Help. For information about viewing the Printer Help, see **view the hp photosmart printer help** on page 2.
- 4 From the Devices Services tab on the HP Photosmart Series Toolbox, click **Calibrate the Device**.

The Align the Print Cartridges screen appears.

- 5 Click **Calibrate**. Your printer will print a calibration page with seven sets of alignment patterns. The Align the Print Cartridges screen reappears asking you to review the alignment patterns and select the best page alignment, pen alignment, and color calibration for your printer.
- 6 Follow the onscreen instructions, and use the ◀ or ▶ buttons to make your selections. Determine the appropriate selections from the printed page.
- 7 Click **Continue**. Your printer prints a second page, and the Align the Print Cartridges screen reappears.
- 8 Follow the onscreen instructions to complete the print cartridge calibration.

To calibrate the print cartridges using your Macintosh:

Note: The following steps are specific to OS X. For OS 9, the steps may be slightly different. Be sure you have selected your HP Photosmart printer in the Print Center (OS X) or in the Chooser (OS 9) before you begin printing.

- 1 If the printer is off, press the **ON** button on the printer's control panel to turn on the printer.
- 2 Load paper in the In tray. For more information, see **load paper in the in tray** on page 7.
- 3 Select **Calibrate** from the HP Inkjet Utility pop-up menu. For information about opening the HP Inkjet Utility, see the HP Photosmart Printer Help. For information about viewing the Printer Help, see **view the hp photosmart printer help** on page 2.

The Calibrate panel appears.

- 4 Click **Align**. Your printer prints a calibration page with five sets of alignment patterns.
- 5 Follow the onscreen instructions to review the alignment patterns, and use the sliders to select the best alignment for your print cartridges. Use the printed page to determine your selections.
- 6 Click **Verify** when you have finished making your selections. Your printer prints a second page, and the Calibrate panel appears with new instructions.
- 7 Follow the onscreen instructions to complete the print cartridge calibration.

remove the print cartridge

- 1 With the printer turned on, lift the main cover of the printer. The print cartridge cradle moves to the middle of the printer.

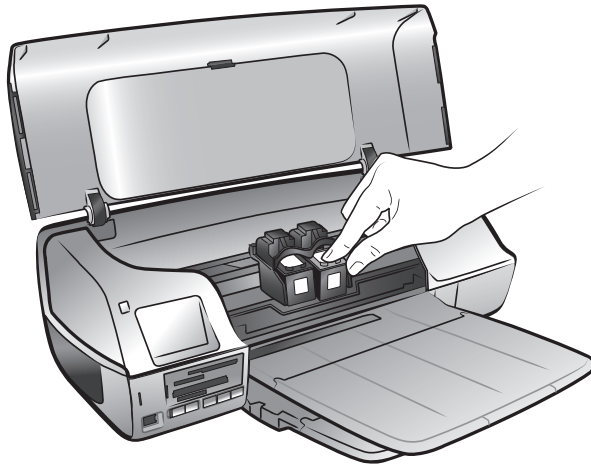

- 2 If you are replacing the print cartridge, push down and pull outward on the print cartridge to unsnap it from the print cartridge cradle. Remove the print cartridge and store, recycle, or discard it. For information about recycling print cartridges, go to www.hp.com/recycle.

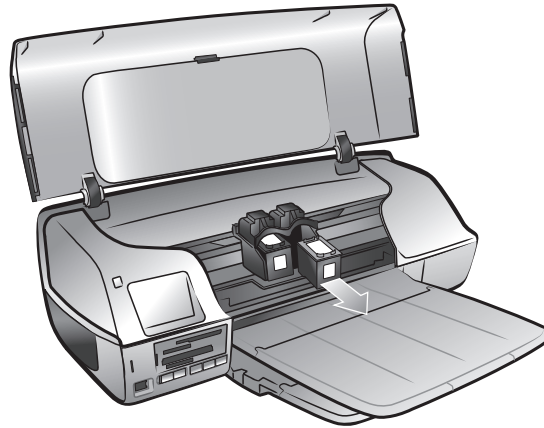

print cartridge storage

The print cartridge protector is designed to keep the ink in the black print cartridge or the photo print cartridge from drying out when it is not being used.

Caution! It is critical that the print cartridge be placed in the print cartridge protector when it is not installed in the printer. Failure to properly store the print cartridge can result in the failure of the print cartridge.

- To insert a print cartridge into the print cartridge protector, slide the print cartridge into the print cartridge protector at a slight angle and snap it securely into place.

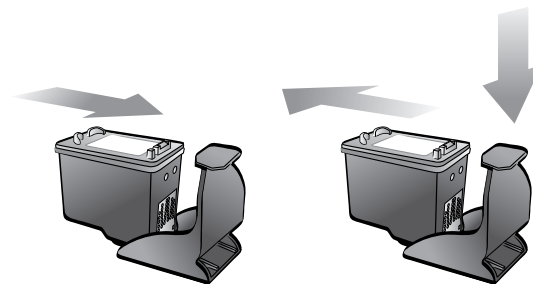

- To remove the print cartridge from the print cartridge protector, press down and back on the top of the print cartridge protector to release the print cartridge, then slide the print cartridge out of the print cartridge protector.

Once you have inserted a print cartridge into the print cartridge protector, you can store it in the print cartridge storage area located in your printer.

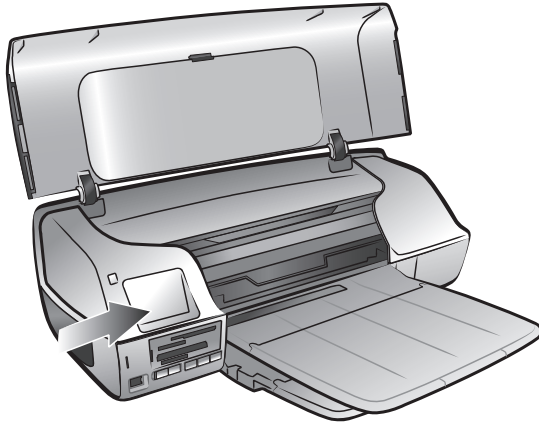

use ink-backup printing mode

Ink-backup Printing Mode allows you to keep printing even if one of your print cartridges fails or runs out of ink. If you see a print cartridge error message on your computer monitor, remove the print cartridge and close the main cover to enter Ink-backup Printing Mode. Your computer displays a message reminding you that the printer is in Ink-backup Printing Mode.

Note: Ink-backup Printing Mode allows you to keep printing, but it slows the printer and affects the print quality. For the highest print quality, be sure to replace the missing print cartridge as soon as possible.

2

print from a memory card

It's easy to print high-quality photos for yourself, family, and friends. If your digital camera uses a memory card to store photos, you can insert the memory card into the printer to print your photos—you don't have to turn on your computer or even have your printer connected to a computer!

Note: You can also print photos using your computer. For more information, see **print from your computer** on page 37.

Note: Be sure to load photo paper into the In tray or the photo cassette before printing.

supported memory cards

Your HP Photosmart printer can read the following memory cards:

CompactFlash Association (CFA) certified Type I and II, IBM Microdrive, MultiMediaCard, Secure Digital, SmartMedia, Sony Memory Sticks, xD-Picture Card

These cards are manufactured by several vendors and are available in a variety of storage capacities. You can purchase memory cards where you purchased your digital camera or at most computer supply stores.

Caution! Using any other type of memory card may damage the memory card and the printer.

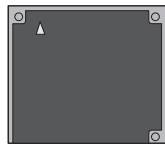

IBM Microdrive



CompactFlash
Type I and II



SmartMedia



Sony Memory Sticks

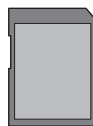

Secure Digital



MultiMediaCard



xD-Picture Card

insert a memory card

After you have taken pictures with your digital camera, remove the memory card from your camera and insert it into your printer. You can print photos immediately or save the photos to your computer.

When the memory card is inserted correctly, the memory card light blinks and then remains solid.

Caution! Do not pull out the memory card while the memory card light is blinking. Removing a memory card while it is being accessed may damage the printer or the memory card, or corrupt the information on the memory card. For more information, see **remove a memory card** on page 23.

To insert a memory card:

- 1 Remove any memory cards that are already inserted into any of the memory card slots.
- 2 Hold the memory card so the correct side faces up. To determine the correct orientation for your memory card, see the table after these steps.

Note: To use a Sony Memory Stick Duo™ memory card, insert the memory card into the adapter that came with the Memory Stick Duo before you insert it into the printer's memory card slot.

- 3 Insert the memory card into the appropriate memory card slot. The end with the metal contacts or pinholes must go into the printer first.

Caution! Inserting the memory card any other way may damage the memory card or the printer.

- 4 Gently push the memory card into the printer until it stops. The memory card may not insert all the way into the printer.

Caution! Forcing the memory card into the printer too far may damage the memory card or the printer.

Note: If you insert a SmartMedia memory card upside down, the red memory card light will begin blinking. Remove the memory card and reinsert it properly.

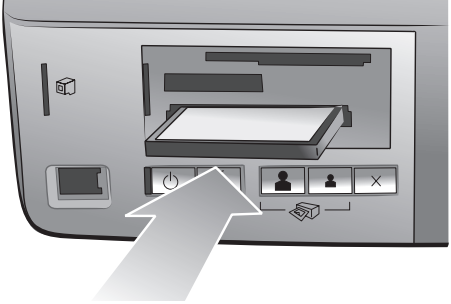
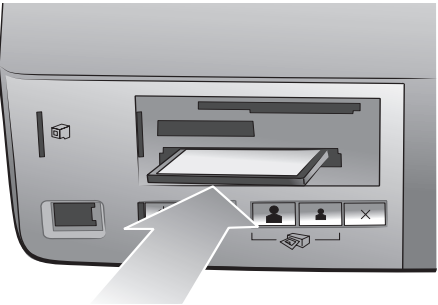
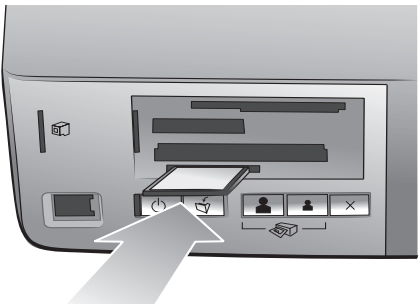
Memory card	Memory card slot	How to hold and insert the memory card
CompactFlash Type I and II	Third slot from the top	<ul style="list-style-type: none"> • Front label faces up, and if the label has an arrow, the arrow points toward the printer • Pinholes insert into the printer first 
IBM Microdrive	Third slot from the top	<ul style="list-style-type: none"> • Front label faces up, and if the label has an arrow, the arrow points toward the printer • Pinholes insert into the printer first 
MultiMediaCard	Bottom slot	<ul style="list-style-type: none"> • Label faces up, angled cutout is on the right, and arrow points toward the printer • Metal contacts face down 

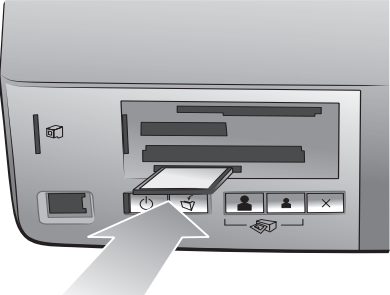
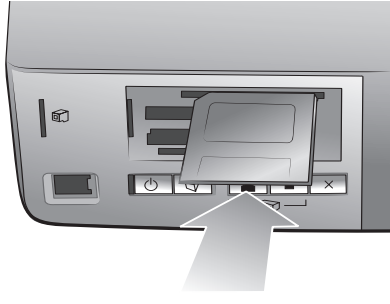
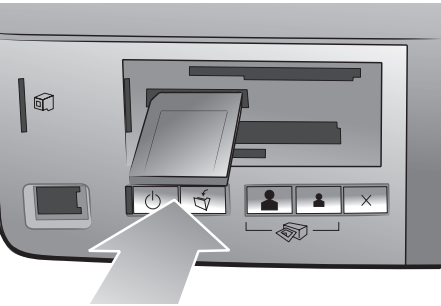
Memory card	Memory card slot	How to hold and insert the memory card
Secure Digital	Bottom slot	<ul style="list-style-type: none"> • Label faces up and angled cutout is on the right • Metal contacts face down 
SmartMedia	Top slot	<ul style="list-style-type: none"> • Angled cutout is on the left, and if the label has an arrow, the arrow points toward the printer • Metal contacts and label face down 
Sony Memory Sticks Note: Some memory sticks require the adapter that came with them be attached before you insert the memory stick into the printer	Second slot from top	<ul style="list-style-type: none"> • Angled cutout is on the left and arrow points toward the printer • Metal contacts face down 

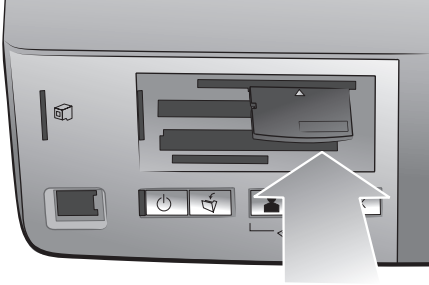
Memory card	Memory card slot	How to hold and insert the memory card
xD-Picture Card	Top slot	<ul style="list-style-type: none"> • Label faces up and arrow points toward the printer • Metal contacts face down 

remove a memory card

Use the procedures in this section to safely remove the memory card from the printer's memory card slot.

Caution! Do not pull out the memory card while the memory card light is blinking. A blinking light means that the printer is accessing the memory card. Wait until the memory card light remains solid. Removing a memory card while it is being accessed may damage the printer and the memory card or corrupt the information on the memory card.

remove a memory card when the printer is not connected to a computer

- ▶ Once the memory card light stops blinking, gently pull the memory card to remove it from the printer's memory card slot.

remove a memory card when the printer is connected to a Windows PC

- 1 If the memory card light is blinking, wait for it to stop.
- 2 With the memory card still inserted in the printer, right-click the memory card icon in the Windows taskbar.
- 3 When the menu appears, select **Prepare to remove card**.
- 4 When prompted on the computer screen, click **OK**.

It is now safe to remove the memory card from the printer. Gently pull the memory card to remove it from the printer's memory card slot.

remove a memory card when the printer is connected to a Macintosh computer

- 1 With the memory card still inserted in the printer, drag the memory card icon from the desktop to the Trash.
- 2 Wait until the memory card light stops blinking, then remove the memory card from the printer's memory card slot.

print photos from a memory card

Your printer can print digital photos that are stored on your memory card. Digital photos may be unmarked or camera-selected. For a list of supported digital photo file types, see **specifications** on page 43.

Note: If the printer detects camera-selected photos, it will print only those photos when you press one of the Print buttons. If you wish to print both unmarked and camera-selected photos, you must press the **CANCEL** button after inserting the memory card and before pressing one of the Print buttons.

use the hp photosmart 7200 series assistant

If your printer is connected to a Windows PC, the HP Photosmart 7200 Series Assistant (Assistant) appears on the computer screen when a memory card is inserted. The Assistant provides information about the memory card slots and the indicator lights. The Assistant also provides information about printing photo collages and 4 x 6 inch (10 x 15 cm) photos from the control panel. For more information, see **print using the hp photosmart 7200 series assistant** on page 29.

print from the control panel

From the control panel you can print all of the photos on the memory card, only the new photos on the memory card, or the camera-selected photos on the memory card.

Note: If the printer detects camera-selected photos, it prints only those photos when you press one of the Print buttons. If you wish to print both unmarked and camera-selected photos, you must press the **CANCEL** button after inserting the memory card then press one of the Print buttons.

Note: Be sure to load photo paper into the In tray or the photo cassette before printing.

You can print photos from the control panel in the following ways:

- Print 4 x 6 inch (10 x 15 cm) photos
- Print a photo collage
- Print camera-selected photos using the control panel

print 4 x 6 inch (10 x 15 cm) photos

Press the **PRINT 4 X 6 PHOTOS** button to print 4 x 6 inch (10 x 15 cm) photos from the memory card. If the photo cassette is loaded with 4 x 6 inch (10 x 15 cm) photo paper, each photo prints on a separate sheet. If the In tray is loaded with letter size or A4 paper, three 4 x 6 inch (10 x 15 cm) images print on a single sheet of paper. For information about loading the photo cassette, see **load paper in the photo cassette** on page 8.

To print 4 x 6 inch (10 x 15 cm) photos:**1** Load the appropriate paper:

- To print individual 4 x 6 inch photos, load 4 x 6 inch (10 x 15 cm) photo paper in the In tray using the photo cassette
- To print three 4 x 6 inch (10 x 15 cm) photos on a single sheet of paper, load letter size or A4 paper into the In tray

2 Insert a memory card into the printer's memory card slot.

If the printer is connected to a Windows PC, the HP Photosmart 7200 Series Assistant window opens to provide additional information about the photos on the memory card.

Note: If the printer detects camera-selected photos, it prints only those photos when you press one of the Print buttons. If you wish to print both unmarked and camera-selected photos, you must press the **CANCEL** button after inserting the memory card then press one of the Print buttons.

3 Choose one of the following:

- If your digital camera allows you to mark photos for printing and you want to print only the marked photos, press the **PRINT 4 X 6 PHOTOS** button.
- If you have marked photos for printing and you want to print all the photos on the memory card, press **CANCEL**, then press the **PRINT 4 X 6 PHOTOS** button.
- If there are no marked photos on the memory card and you want to print **all** of the photos on the memory card, press the **PRINT 4 X 6 PHOTOS** button.
- If there are no marked photos on the memory card and you want to print **only the new** (previously unprinted from the control panel) photos on the memory card, press and hold the **PRINT 4 X 6 PHOTOS** button for three to five seconds.

If there are no new photos (previously unprinted from the control panel) on the memory card, nothing happens if you press and hold this print button.

Note: The photos print in reverse order; the last photo taken is the first photo printed.

To stop printing, press the **CANCEL** button.

Note: If the printer runs out of paper while printing, load more paper in the In tray or photo cassette, and press one of the Print buttons to resume printing.

print a photo collage

Press the **PRINT PHOTO COLLAGE** button to print small photos from the memory card. If the photo cassette is loaded with 4 x 6 inch (10 x 15 cm) photo paper, four images print on a single sheet. If the In tray is loaded with letter size or A4 paper, nine images print on a single sheet of paper.

To print a photo collage:

- 1 Load the appropriate paper:
 - To print four images on a 4 x 6 inch (10 x 15 cm) sheet of photo paper, load 4 x 6 inch (10 x 15 cm) photo paper into the photo cassette. For more information see **load paper in the photo cassette** on page 8.
 - To print nine photos on a single sheet of paper, load letter size or A4 paper into the In tray. For more information see **load paper in the in tray** on page 7.

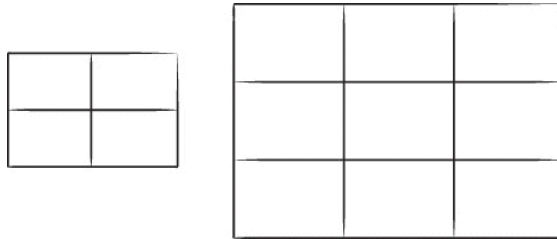

- 2 Insert a memory card into the printer's memory card slot.

If the printer is connected to a Windows PC, the HP Photosmart 7200 Series Assistant window opens to provide additional information about the photos on the memory card.

Note: If the printer detects camera-selected photos, it prints only those photos when you press one of the Print buttons. If you wish to print both unmarked and camera-selected photos, you must press the **CANCEL** button after inserting the memory card, and then press one of the Print buttons.

3 Choose one of the following:

- If your digital camera allows you to mark photos for printing and you want to print only the marked photos, press the **PRINT PHOTO COLLAGE** button.
- If you have marked photos for printing and you want to print all the photos on the memory card, press **CANCEL**, and then press the **PRINT PHOTO COLLAGE** button.
- If there are no marked photos on the memory card and you want to print **all** of the photos on the memory card, press the **PRINT PHOTO COLLAGE** button.
- If there are no marked photos on the memory card and you want to print **only the new** (previously unprinted from the control panel) photos on the memory card, press and hold the **PRINT PHOTO COLLAGE** button for three to five seconds.

If there are no new photos (previously unprinted from the control panel) on the memory card, nothing happens if you press and hold this print button.

Note: The photos print in reverse order; the last photo taken is the first photo printed.

Note: To stop printing, press the **CANCEL** button.

Note: If the printer runs out of paper while printing, load more paper in the In tray or photo cassette, and press one of the Print buttons to resume printing.

print camera-selected photos using the control panel

Your printer can print camera-selected digital photos that are stored on your memory card. For a list of supported digital photo file types, see **printer specifications** on page 44.

If the printer is connected to a computer and a memory card with camera-selected photos is inserted into a memory card slot, the HP Photosmart Assistant displays instructions for how to print camera-selected photos on the computer screen.

Note: Camera-selected photos usually include information about the size and number of copies to print. If your camera-selected photos specify a size other than the standard size options provided by your printer, the size you specified in your camera overrides the size that you specify by pressing a print button on the printer's control panel.

- 1 Use your digital camera to select the photos you want to print. For more information, see the documentation that came with your camera.
- 2 Load the appropriate paper:
 - To print individual 4 x 6 inch photos or a photo collage on 4 x 6 inch (10 x 15 cm) photo paper, load 4 x 6 inch (10 x 15 cm) photo paper in the In tray using the photo cassette. For more information, see **load paper in the photo cassette** on page 8.
 - To print three 4 x 6 inch (10 x 15 cm) photos on a single sheet of paper or a photo collage, load letter size or A4 paper into the In tray. For more information, see **load paper in the in tray** on page 7.
- 3 Insert the memory card into the printer's memory card slot.
If the printer is connected to a Windows PC, the HP Photosmart Assistant displays information about the photos on the memory card.
- 4 Press the **4 X 6 INCH PHOTO** button or the **PRINT PHOTO COLLAGE** button.
Note: The photos print in reverse order; the last photo taken is the first photo printed.
Note: If the printer runs out of paper while printing, load more paper in the In tray or photo cassette, and press one of the Print buttons to resume printing.

save photos from the control panel

When your printer is connected to a computer, you can save your photos to your Windows PC or Macintosh computer using the printer's control panel. The printer does not overwrite files with the same name.

Note: To save photos using the control panel, your computer must be connected to the USB port on the back of your printer.

Note: If there are camera-selected photos on the memory card, you cannot save photos to your computer using this method. See the HP Photosmart Printer Help for more information about saving photos to your computer.

To save photos from the memory card using the control panel:

- 1 Insert a memory card into the printer.
- 2 Press the **SAVE** button on the printer's control panel.
- 3 Follow the onscreen instructions to save photos to the desired folder on your computer.
Note: To stop saving photos to your computer, press the **CANCEL** button on the printer's control panel.

3

print using the hp photosmart 7200 series assistant

The HP Photosmart 7200 Series Assistant (Assistant) provides information about the printer's control panel and displays messages from your printer on the computer screen when you insert memory cards into the printer and when error conditions occur.

Note: The Assistant is only available if you are using a Windows PC.

use the hp photosmart assistant

- 1 To start the Assistant, do one of the following:
 - Click the **HP Photosmart 7200 Series Assistant** icon on your desktop.
 - From the **Start** menu, select **Programs** (on Windows XP select **All Programs**), **Hewlett-Packard**, **Photosmart 140, 240, 7200, 7600, 7900, Photosmart 7200 Series Assistant**.

The Assistant's Welcome window appears. As you move your cursor over this window, clickable images are outlined in yellow.

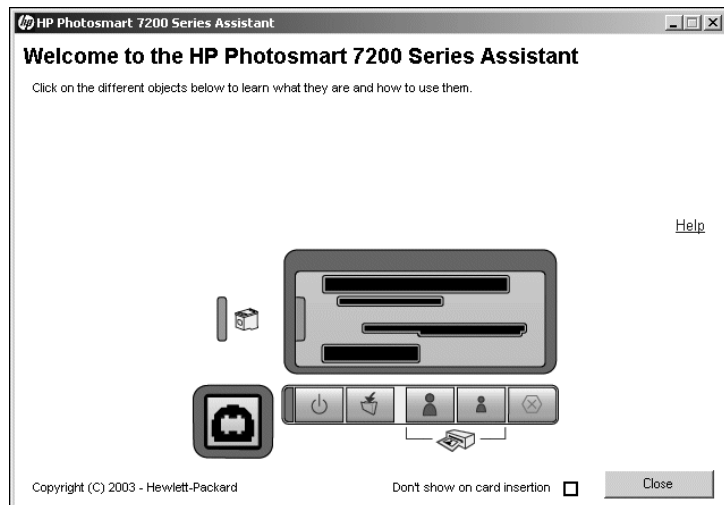

- 2 Do one of the following:
 - Click an item on the window to learn more.
 - Click **Printer Help** to go to the first page of the HP Photosmart Printer Help.

Note: You can turn off these messages on the Assistant's Welcome window by selecting the **Don't show on card insertion** check box.

- 3 Click **Close** to close the Assistant.

view memory card information provided by the assistant

When you insert a memory card into the printer, the Assistant automatically opens on the computer screen and displays information about the files on the memory card.

Note: You can turn off these messages on the Assistant's Welcome window by selecting the **Don't show on card insertion** check box.

Memory card messages from the Assistant include:

- Photo Card Inserted

This message includes the number of photos stored on the memory card and the number of new photos on the memory card (photos that have not been printed from the printer's control panel).

- Click **More Detail on Photo Card Inserted** to open a help topic about photo cards.
- Click **Printer Help** to open the first page of HP Photosmart Printer Help.
- Click **Assistant** to open the Assistant Welcome window where you can view information about the printer's control panel and turn memory card messages on or off.
- Click **Close** to close the Assistant.

- Camera-Selected Photos (DPOF) Detected

This message appears when photos on the memory card have been marked for printing using your digital camera.

- Click **More Detail on Camera-Selected Photos (DPOF) Detected** to open a help topic about camera-selected photos.
- Click **Printer Help** to open the first page of HP Photosmart Printer Help.
- Click **Assistant** to open the Assistant's Welcome window where you can view information about the printer's control panel and turn memory card messages on or off.
- Click **Close** to close the Assistant.

- Card Access Error

This message appears when the printer cannot read photos stored on the memory card.

- Click **More Detail on Card Access Error** to open a troubleshooting help topic.
- Click **Printer Help** to open the first page of HP Photosmart Printer Help.
- Click **Assistant** to open the Assistant's Welcome window where you can view information about the printer's control panel and turn memory card messages on or off.
- Click **Close** to close the Assistant.

view error condition information provided by the assistant

The Assistant automatically opens when any of the following occur:

- The main cover is opened
- The printer is out of paper
- One or more of the print cartridges is low on ink
- A print cartridge is missing
- There is a paper jam
- A memory card is inserted incorrectly
- One or more of the print cartridges has failed
- An incompatible print cartridge has been installed
- A print cartridge was not installed correctly
- One of the print cartridges has been removed

Note: If you need help fixing an error condition reported by the Assistant, the HP Photosmart Printer Help provides troubleshooting information about a wide range of topics. For information about viewing the Printer Help, see **view the hp photosmart printer help** on page 2.

When the Assistant displays information about an error condition:

- 1 Fix the problem reported by the Assistant.
- 2 Click **Close** to close the Assistant window.

4

print using the direct-printing port

For quick and easy printing, your printer allows you to connect a notebook computer or an HP direct-printing digital camera to the direct-printing port located on the front of the printer.

Note: If your direct-printing digital camera has a docking station, you can connect the docking station to the printer's USB port. For more information, see the documentation that came with the docking station.

Note: Only HP direct-printing digital cameras are supported for use with your printer.

connect your hp digital camera to the direct-printing port

Your printer allows you to print beautiful photos from an HP direct-printing digital camera without using your computer.

To see a list of the HP direct-printing digital cameras that work with your printer, go to www.hp.com/support, select your country or region, and type **direct-printing digital cameras** in the search window.

- 1 Use the Share menu on your HP direct-printing digital camera to select the photos you want to print. For more information, see the documentation that came with your camera.
- 2 Connect the digital camera to the front direct-printing port of your printer using the USB cable that came with the camera. The front direct-printing port is located to the left of the control panel buttons.

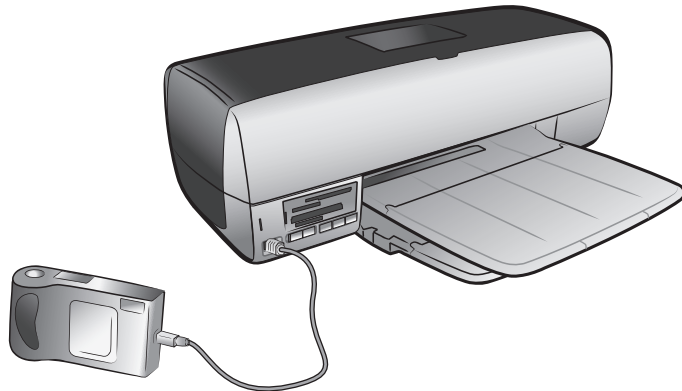

- 3 When you connect the digital camera to the printer, a Print Setup menu appears on the camera's LCD screen. Use this menu to:
 - Change the photos you have selected for printing
 - Select the paper type
 - Select the paper size
- 4 When you are ready to print, follow the instructions on your camera's LCD screen.

Note: For more information about using camera-selected photos, see the documentation that came with your digital camera.

Note: For best results, be sure to load photo paper into the In tray or the photo cassette before printing.

For more information about printing from a memory card, see **print from the control panel** on page 24.

connect your notebook computer to the direct-printing port

To print the photos or files from your notebook computer using the direct-printing port, the files must already be saved on your notebook computer.

You must install the HP Photosmart 7200 Series printer software on your notebook computer to print using the front port. For information about installing the software on your notebook computer, see the reference guide that came with your printer.

To print from your Windows notebook computer:

- 1 Connect one end of a USB cable to the notebook computer, then connect the other end of the cable to the direct-printing port located on the front of the printer. The direct-printing port is located to the left of the control panel buttons.

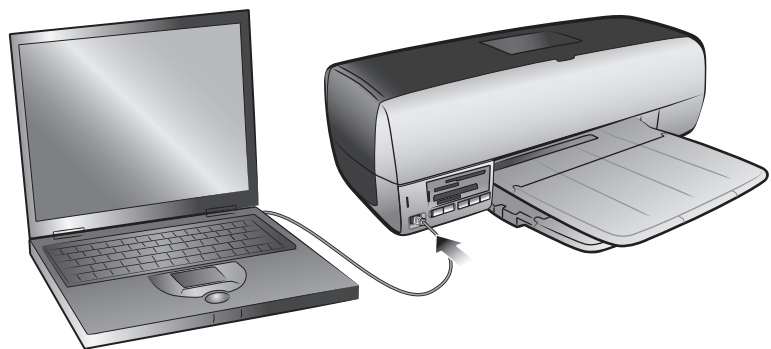

- 2 Using your software application, open the file you want to print.
- 3 From the **File** menu of the software application, select **Print**.

- 4 To access more advanced settings, click **Properties** or **Preferences**.
- 5 Select the settings appropriate for your project, and click **OK**.

print from your Macintosh notebook computer:

- 1 Connect one end of a USB cable to the notebook computer, then connect the other end of the cable to the direct-printing port located on the front of the printer. The direct-printing port is located to the left of the control panel buttons.

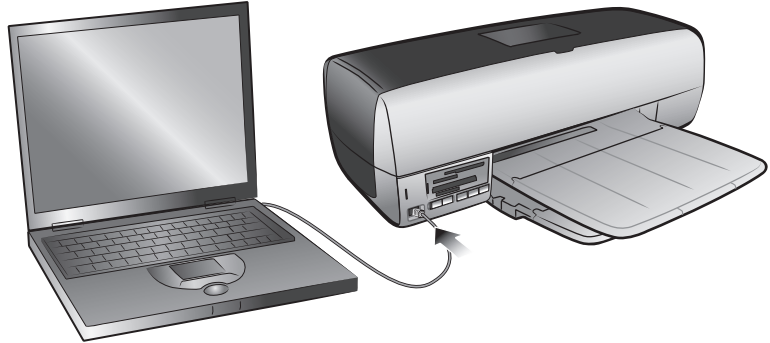

- 2 Using your software application, open the file you want to print.
- 3 From the **File** menu of the software application, select **Page Setup**.
- 4 In the **Format for** pop-up menu, select **photosmart 7200 series**.
- 5 Select the page attributes:
 - Select the paper size.
 - Select whether you would like to print borderless or bordered photos.
If you are using OS 9, the borderless option appears as a check box. If you are using OS X, the borderless options appear under the **Paper Size** pop-up menus.
 - Select the orientation.
 - Enter the scaling percentage.
- 6 Click **OK**.
- 7 From the **File** menu in your software application, select **Print**.
The Print dialog box appears.

Note: If you are using OS X, the Copies & Pages panel opens. If you are using OS 9, the General panel opens.
- 8 Select the print settings appropriate for your project. Use the pop-up menus to open the other panels.

Note: To learn more about the settings, click the **?** in the lower-left corner of the dialog box (OS X only).
- 9 Click **Print** (OS X) or **OK** (OS 9) to begin printing.

5

print from your computer

You can use your printer with Windows PC or Macintosh software applications that allow printing.

If you already know how to use a printer with your computer, you are ready to begin printing as usual. If you are new to printing, or if you have questions, use this chapter to learn more.

When you print from your computer, the control panel settings on the printer do not apply; the software on your computer overrides the print settings.

print using your Windows PC

Before you begin, make sure your printer is connected to your computer, that the printer software is installed, and that there is paper in the printer. For more information about setup, see the *HP Photosmart Setup Guide* that came with your printer. For more information about loading the paper, see **load paper in the in tray** on page 7.

To print from a software application:

- 1 From the **File** menu in your software application, select **Print**.

Depending on the software application you are using and the operating system running on your computer, a Print dialog box may appear or the HP Photosmart Series Properties or Printing Preferences dialog box may appear.

- 2 Select the pages and the number of copies you want to print.

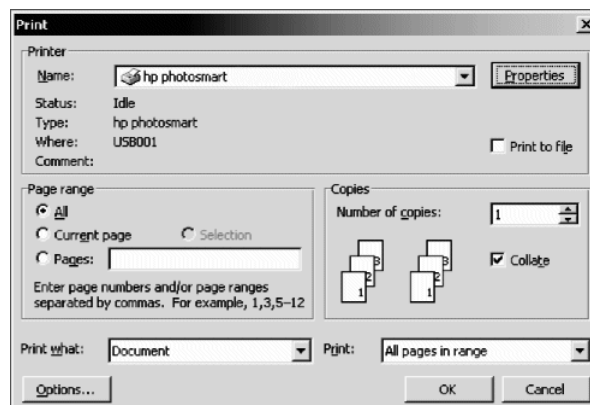

- 3 To access the printing properties tabs, you may have to click **Properties** or **Preferences**. For information about the HP Photosmart Series printing properties, see the HP Photosmart Printer Help.

Note: Depending on the operating system running on your computer, the HP Photosmart Series Properties dialog box may be titled HP Photosmart Printing Preferences.

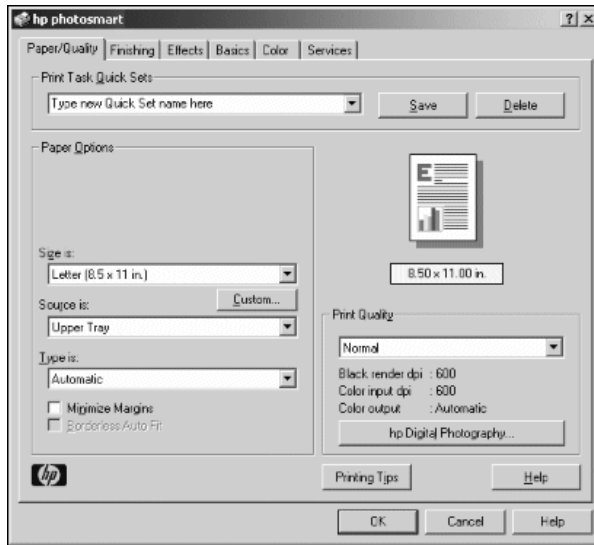

Note: To learn more about the available settings, click the ? in the upper-right corner of the printing properties dialog box, then click the item you want more information about. You can also click **Help**.

- 4 Click **OK** to begin printing.

Note: If the printer runs out of paper while printing, load more paper in the In tray or photo cassette, and press one of the Print buttons to resume printing.

use the Windows PC taskbar icons

After you install the printer software, two icons appear in the Windows taskbar:

- **hp photosmart printer icon** 
- **hp photosmart memory card icon** 

These icons help you perform a variety of tasks.



Printer icon

Memory card icon

hp photosmart printer icon



Use the HP Photosmart printer icon in the Windows taskbar to open the HP Photosmart Series Properties dialog box, select a default printer, or open the HP Photosmart Series Toolbox.

- When you click the printer icon, the printing properties dialog box appears.
- When you right-click the printer icon, a menu appears. Make your selection from the following menu items:
 - **Change default print settings**—Click to open the printing properties dialog box.
 - **Open HP Photosmart Series Toolbox**—Click to open the HP Photosmart Series Toolbox.
 - **HP Photosmart Series**—Select the HP Photosmart Series printer you want to use from the list of installed printers. A check mark indicates the currently selected printer.
 - **Exit**—Click to close the menu and remove the printer icon from the taskbar. Restart your computer to make these icons appear again. To close the menu without removing the printer icon from the taskbar, click anywhere outside the menu.

hp photosmart memory card icon

Use the HP Photosmart memory card icon to determine the status of your printer, access the files stored on your memory card, and display connection messages on your computer screen.

The appearance of the icon tells you the status of the printer:

	When the memory card icon is green, a memory card is inserted in the printer and the printer is ready to access the files stored on the memory card.
	When the memory card icon is gray, a memory card is not inserted in the printer.
	When a red “x” appears on the memory card icon, the connection between the printer and the computer has been lost. To print from the computer you must re-establish communication. For information about re-establishing communication, see the HP Photosmart Printer Help.

When you right-click the memory card icon, a menu appears. Make your selection from the following menu items:

- **Open F: HP Photosmart Series**—Click to open Windows Explorer, where you can move, copy, delete, or open files. You can also double-click the memory card icon to open Windows Explorer. Note that “F:” may not be the drive assigned by your computer.
- **Prepare to remove card**—Click to prepare the memory card for safe removal from the printer.
- **Show disconnect warning**—Click if you want a warning message to appear when the printer loses communication or attempts to regain communication with your computer. A check mark indicates a connection message will appear.
- **Show safe to remove card message**—Click if you want a message to appear notifying you when it is safe to remove the memory card from the printer. A check mark indicates a message will appear.

print using your Macintosh

Before you begin, make sure your printer is connected to your computer, that the printer software is installed, and that there is paper in the printer. For more information about setup, see the *HP Photosmart Setup Guide* that came with your printer. For more information about loading the paper, see **load paper in the in tray** on page 7.

To print from a software application (OS X or OS 9):

Note: The following steps are specific to OS X. For OS 9, the steps may be slightly different. Be sure you have selected your HP Photosmart printer in the Print Center (OS X) or in the Chooser (OS 9) before you begin printing. For more information, see the reference guide that came with your printer.

- 1 From the **File** menu in your software application, select **Page Setup**.
The Page Setup dialog box appears.

- 2 In the **Format for** pop-up menu, select **photosmart 7200 series**.

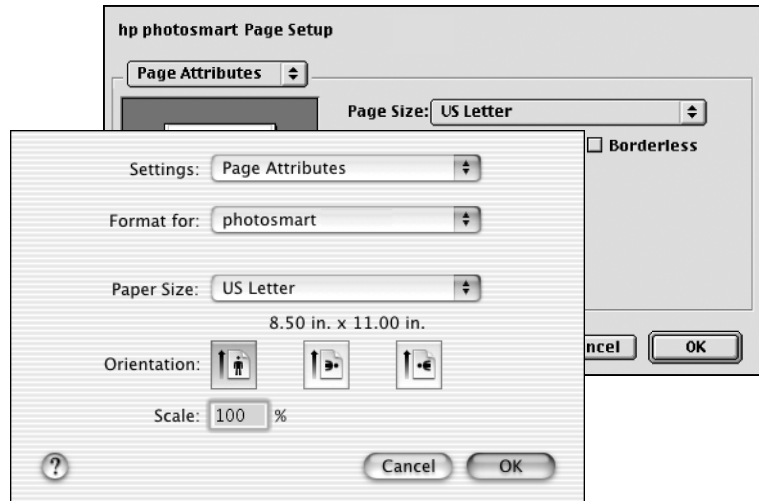

- 3 Select the page attributes:
- Select the paper size.
 - Select whether you would like to print borderless or bordered photos.
If you are using OS 9, the borderless option appears as a check box. If you are using OS X, the borderless options appear under the **Paper Size** pop-up menus.
 - Select the orientation.
 - Enter the scaling percentage.
- 4 Click **OK**.
- 5 From the **File** menu in your software application, select **Print**.

The Print dialog box appears.

Note: If you are using OS X, the Copies & Pages panel opens. If you are using OS 9, the General panel opens.

- 6 Select the print settings appropriate for your project. Use the pop-up menus to open the other panels.

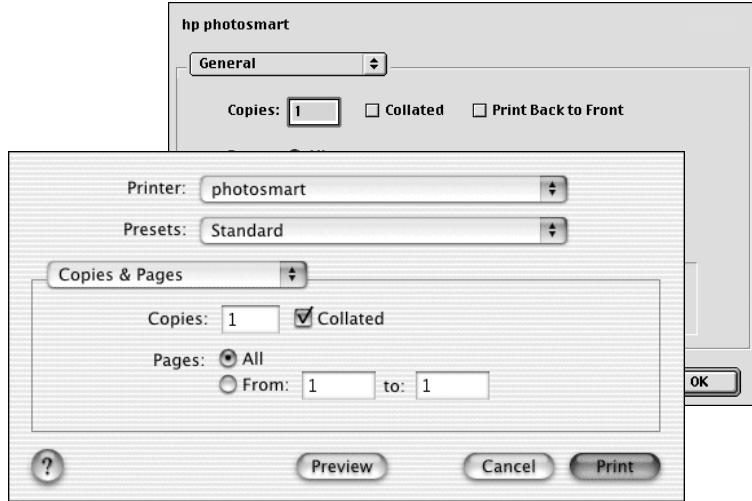

Note: To learn more about the settings, click the ? in the lower left corner of the dialog box (OS X only).

- 7 Click **Print** (OS X) or **OK** (OS 9) to begin printing.

Note: If the printer runs out of paper while printing, load more paper in the In tray or photo cassette, and press one of the Print buttons to resume printing.

6

specifications

This chapter lists recommended papers for your printer and provides selected printer specifications.

Note: For a complete list of printer specifications and system requirements, see the HP Photosmart Printer Help.

recommended paper

For a list of available HP-designed inkjet papers, or to purchase supplies, go to:

- www.hpshopping.com (U.S.)
- www.hp-go-supplies.com (Europe)
- www.hp.com/paper (Asia/Pacific)
- www.jpn.hp.com/supply/inkjet (Japan)

Note: You can also purchase HP-designed inkjet paper at most computer and office supply stores.

HP photo papers	Best for	Sizes
HP premium plus photo paper	<ul style="list-style-type: none"> • Borderless printing on paper with a 0.5 inch tab • High-value prints • Important photos • High-resolution images from scanners or digital cameras • Photo enlargements or reprints to frame or give as gifts 	Letter (8.5 x 11 inches, 216 x 280 mm) A4 (8.27 x 11.7 inches, 210 x 297 mm) 4 x 6 inches with 0.5 inch tab (10 x 15 cm with 1.25 cm tab)
HP premium photo paper	<ul style="list-style-type: none"> • Making and sharing photos with friends and families • Medium- to high-resolution images from scanners and digital cameras • Medium value prints from parties, team events, or celebrations 	Letter (8.5 x 11 inches, 216 x 280 mm) A4 (8.27 x 11.7 inches, 210 x 297 mm) 4 x 6 inches with 0.5 inch tab (10 x 15 cm with 1.25 cm tab)
HP photo paper	<ul style="list-style-type: none"> • Casual photos or high-volume photos • School or business reports, photo projects • Business applications: real-estate proposals, sales and marketing materials 	Letter (8.5 x 11 inches, 216 x 280 mm) A4 (8.27 x 11.7 inches, 210 x 297 mm) 4 x 6 inches with 0.5 inch tab (10 x 15 cm with 1.25 cm tab)

HP photo papers	Best for	Sizes
HP everyday photo paper	<ul style="list-style-type: none"> • Everyday photos, short-term, or one-time uses • E-mail or internet photos for bulletin boards or refrigerators • Kid's photos • Testing and proofing 	Letter (8.5 x 11 inches, 216 x 280 mm) A4 (8.27 x 11.7 inches, 210 x 297mm)

printer specifications

Connectivity, maximum	HP JetDirect External Print Servers: 175x, 310x, 380x
Connectivity, standard	USB: Front and back ports Windows 98, 2000 Professional, ME, XP Home, and XP Professional Mac® OS 9 v9.1 or later, OS X v10.1 through v10.2
Image file formats	JPEG Baseline TIFF 24-bit RGB uncompressed interleaved TIFF 24-bit YCbCr uncompressed interleaved TIFF 24-bit RGB packbits interleaved TIFF 8-bit gray uncompressed/packbits TIFF 8-bit palette color uncompressed/packbits TIFF 1-bit uncompressed/packbits/1D Huffman
In tray capacity	25 sheets of photo paper 100 sheets of plain paper 20–40 cards (depending on thickness) 15 envelopes 20 sheets of banner paper 20 sheets of labels 25 transparencies 25 sheets of iron-on transfers
Media sizes	Photo paper (4 x 6 inches, 10 x 15 cm) Photo paper with tab (4 x 6 inches with 0.5 inch tab, 10 x 15 cm with 1.25 cm tab) Index cards (4 x 6 inches, 10 x 15 cm) Hagaki cards (3.9 x 5.8 inches, 100 x 148 mm) A6 cards (4.1 x 5.8 inches, 105 x 148 mm) L-size cards (3.5 x 5 inches, 90 x 127 mm) L-size cards with tab (3.5 x 5 inches with 0.5 inch tab, 90 x 127 mm with 12.5 mm tab)

Media specifications, maximum	<p>Recommended maximum length: 14 inches (356 mm)</p> <p>Recommended maximum thickness: 11.5 mil (292 μm) per sheet</p>
Media sizes, standard	<p>Photo paper 3 x 3 inches to 8.5 x 14 inches (76 x 76 mm to 216 x 356 mm)</p> <p>Plain paper Letter, 8.5 x 11 inches (216 x 280 mm) Legal, 8.5 x 14 inches (216 x 356 mm) Executive, 7.5 x 10 inches (190 x 254 mm) A4, 8.27 x 11.7 inches (210 x 297 mm) A5, 5.8 x 8.3 inches (148 x 210 mm) B5, 6.9 x 9.8 inches (176 x 250 mm)</p> <p>Cards Hagaki, 3.9 x 5.5 inches (100 x 148 mm) L-size, 3.5 x 5 inches (90 x 127mm) L-size with tab, 3.5 x 5 with 0.5 inch tab (90 x 127 mm with 12.5 mm tab) Index, 3 x 5 inches, 4 x 6 inches, and 5 x 8 inches (76 x 127 mm, 10 x 15 cm, and 127 x 203 mm) A6, 4.13 x 5.8 inches (105 x 148 mm)</p> <p>Envelopes No. 9, 3.875 x 8.875 inches (98.4 x 225.4 mm) No. 10, 4.125 x 9.5 inches (105 x 240 mm) A2 Invitation, 4.375 x 5.75 inches (110 x 146 mm) DL, 4.33 x 8.66 inches (110 x 220 mm) C6, 4.5 x 6.4 inches (114 x 162 mm)</p> <p>Custom 3 x 5 inches to 8.5 x 14 inches (76 x 127 mm to 216 x 356 mm)</p> <p>Transparencies Letter, 8.5 x 11 inches (216 x 280 mm) A4, 8.27 x 11.7 inches (210 x 297 mm)</p> <p>Label sheets Letter, 8.5 x 11 inches (216 x 280 mm) A4, 8.27 x 11.7 inches (210 x 297 mm)</p> <p>Media types Paper (plain, inkjet, photo, and banner) Envelopes Transparencies Labels Cards (index, greeting, Hagaki, A6, L-size) Iron-on transfers</p>

Memory cards	CompactFlash Type I and II IBM Microdrive MultiMediaCard Secure Digital SmartMedia Sony Memory Sticks xD-Picture Card
Memory card-supported file formats	Printing: See supported Image file formats on page 44 Saving: All file formats
Out tray capacity	20 sheets of photo paper 50 sheets of plain paper 10 cards 10 envelopes 20 transparencies 20 sheets of banner paper 25 sheets of labels 25 sheets of iron-on transfers
Paper trays	One letter-size tray One 4 x 6 inch (10 x 15 cm) photo cassette
Photo cassette capacity	24 sheets of photo paper
Print cartridges	1 black HP #56 (C6656A) 1 tri-color HP #57 (C6657A) 1 photo HP #58 (C6658A)
USB support	USB: Front and back ports Windows 98, 2000 Professional, ME, XP Home, and XP Professional Mac OS 9 v9.1 or later, OS X v10.1 through v10.2 HP recommends that the USB cable be less than 10 feet (3 meters) in length

7

troubleshooting

Your HP Photosmart printer is designed to be reliable and easy to use. This chapter answers frequently asked questions and contains information about the following topics:

- hardware problems
- printing problems

For more troubleshooting information about software installation, see the reference guide that came with your printer. For advanced troubleshooting information, see the HP Photosmart Printer Help. For information about viewing the printer help, see **view the hp photosmart printer help** on page 2.

hardware problems

Before contacting HP support, read this section for troubleshooting tips or go to the online support services at www.hp.com/support.

Note: HP recommends using a USB cable of less than 10 feet (3 meters) in length to minimize injected noise due to potential high electromagnetic fields.

Problem	Possible cause	Solution
The Printer Status light is blinking green but the printer is not printing.	The printer is processing information.	Wait a moment for the printer to finish processing the information.
The Printer Status light is blinking red.	The printer requires attention.	Try the following: <ul style="list-style-type: none">• If you have a digital camera connected to the printer, check the camera's LCD screen for instructions.• If this does not work, turn off the printer. Unplug the printer's power cord, wait one minute, then plug it in again. Turn on the printer.

Problem	Possible cause	Solution
The Printer Status light is blinking amber.	An unrecoverable error has occurred.	Try the following: <ul style="list-style-type: none"> • Turn off the printer. Unplug the printer's power cord, wait one minute, then plug it in again. Turn on the printer. • If this does not work, go to www.hp.com/support or contact HP support. For contact information, see the reference guide that came with your printer.

printing problems

Before contacting HP support, read this section for troubleshooting tips or go to the online support services at **www.hp.com/support**.

Note: In the presence of high electromagnetic fields, printed documents and photos may be slightly distorted.

Problem	Possible cause	Solution
The printer does not generate 4 x 6 inch (10 x 15 cm) borderless print output.	You need to select the appropriate paper size.	<p>Windows</p> <ol style="list-style-type: none"> 1 Open the printing properties dialog box. For more information, see print using your Windows PC on page 37. 2 Select the Paper/Quality tab. 3 From the Size is drop-down menu, select Borderless Photo 4 x 6 in. (with tab). <p>Macintosh OS X</p> <p>From the Paper Size pop-up menu in the Page Setup dialog box, select Borderless 4 x 6 Photo.</p> <p>Macintosh OS 9</p> <ol style="list-style-type: none"> 1 From the Page Setup dialog box, select 4 x 6 Photo from the Page Size pop-up menu. 2 Click to select the Borderless check box.

Problem	Possible cause	Solution
Printing is very slow. <i>(Continued on next page.)</i>	Your computer may have less than the recommended system requirements.	Check the amount of RAM (system memory), the processor speed, and the amount of free hard disk space on your computer. Having less than 500 MB of free hard disk space can extend processing time. For information about system requirements, see the HP Photosmart Printer Help. For information about viewing the printer help, see view the hp photosmart printer help on page 2.
	Too many software programs may be running at the same time.	Close all unnecessary software programs.
	You may be using outdated printer software.	Update the version of the printer software you are using. For more information, see the HP Photosmart Printer Help. For information about viewing the printer help, see view the hp photosmart printer help on page 2.

Problem	Possible cause	Solution
<p>Printing is very slow. (Continued from previous page.)</p>	<p>You may have chosen Maximum dpi (Windows) or High Resolution (Macintosh).</p> <p>You may need to calibrate the print cartridges.</p>	<p>Windows PC</p> <ol style="list-style-type: none"> 1 Open the printing properties dialog box. For more information, see print using your Windows PC on page 37. 2 Select the Paper/Quality tab. 3 Set the Print Quality to Best instead of Maximum dpi. 4 Try printing again. <p>Macintosh</p> <ol style="list-style-type: none"> 1 On the Paper Type/Quality panel in the Print dialog box, deselect High Resolution. 2 Try printing again. <p>Calibrate your printer using the HP Photosmart software that came with your printer.</p> <p>Windows PC</p> <p>Go to the Device Services tab of the HP Photosmart Series Toolbox and click Calibrate the Device.</p> <p>Macintosh</p> <p>Go to the Calibrate panel in the HP Inkjet Utility and click Align. For more information, see the HP Photosmart Printer Help. For information about viewing the printer help, see view the hp photosmart printer help on page 2.</p>
<p>The printer does not print new photos on the memory card.</p>	<p>There are no new photos on the memory card or the photos have already been printed.</p>	<p>Press and release the desired print button on the control panel to print all photos on the memory card. For more information about printing new photos, see print from the control panel on page 24.</p> <p>Windows PC only</p> <p>Print the desired photo(s) from the HP Photo & Imaging software that you installed with your printer. For more information, see the HP Photo & Imaging software help.</p>

Problem	Possible cause	Solution
All photos print instead of just new photos.	The print button was not held down long enough.	Press and hold the desired print button on the control panel. For more information, see print from the control panel on page 24.
Photo paper does not feed into the printer correctly.	The photo cassette may not be engaged.	Insert the photo cassette until it snaps into place. For more information, see load paper in the photo cassette on page 8.
	Your printer may be in an extremely high or low humidity environment.	Load one sheet of photo paper at a time.
	The photo paper may be curled.	If the photo paper is curled, place the paper in a plastic bag and gently bend it the opposite direction of the curl until the paper lies flat. If the problem persists, then use photo paper that is not curled.
Paper does not feed into the printer correctly. OR Paper does not come out of the printer correctly.	There may be too much paper loaded in the In tray.	Remove some paper from the In tray and try printing again. For paper-loading instructions, see load paper in the in tray on page 7.
	The paper may be too thin or too thick.	For a list of supported paper weights, see the HP Photosmart Printer Help. For information about viewing the printer help, see view the hp photosmart printer help on page 2.
	Two or more pieces of paper are stuck together.	<ol style="list-style-type: none"> 1 Remove the paper from the paper tray and shuffle the paper so it does not stick together. 2 Reload the paper into the paper tray and try printing again. For paper-loading instructions, see load paper in the in tray on page 7.

Problem	Possible cause	Solution
No page came out of the printer.	There may be a paper jam.	<p>Try the following:</p> <ul style="list-style-type: none"> • Remove the paper from the In tray and the Out tray. • If you were printing labels, make sure a label did not become unglued from the label sheet while going through the printer. <p>If the paper is still jammed, try the following:</p> <ol style="list-style-type: none"> 1 Turn off the printer. 2 Remove the rear access door. 3 Unplug the printer. 4 Gently remove the jammed paper from the printer. 5 Replace the rear access door. 6 Plug the printer back in and turn it on. 7 When you have cleared the paper jam, print your document again. <p>If you experience paper jams when printing on photo paper, try the following:</p> <ul style="list-style-type: none"> • Insert the photo paper as far as it will go into the photo cassette. • Load one sheet of photo paper at a time.

Problem	Possible cause	Solution
A blank page came out of the printer.	The print cartridges may be out of ink.	<p>Windows PC Check the ink levels of the print cartridges from the Estimated Ink Level tab of the HP Photosmart Series Toolbox.</p> <p>Macintosh Check the ink level status in the HP Inkjet Utility. For more information about checking ink levels, see the HP Photosmart Printer Help. For information about viewing the printer help, see view the hp photosmart printer help on page 2. If a print cartridge is low on ink, replace it. For more information, see install or replace a print cartridge on page 13.</p>
	You may have begun printing and cancelled the process.	If you cancelled the process before the file started printing, the printer may have already loaded paper in preparation for printing. The next time you print, the printer will eject the blank page before continuing with the new project.
	You may be printing in Ink-backup Printing Mode with only the black print cartridge installed and borderless printing turned on.	Replace the missing print cartridge with a new one. For more information, see install or replace a print cartridge on page 13. OR Turn off borderless printing.

Problem	Possible cause	Solution
The document printed at an angle or is off-center.	The paper may not be loaded correctly.	Make sure the paper is correctly oriented in the In tray. For paper-loading instructions, see load paper in the in tray on page 7.
	The print cartridges may not be properly calibrated.	<p>Windows PC</p> <ol style="list-style-type: none"> 1 Open the HP Photosmart Series Toolbox. To access the Toolbox, click the icon on the Windows PC taskbar. For more information, see use the Windows PC taskbar icons on page 38. 2 Go to the Device Services tab of the HP Photosmart Series Toolbox and click Calibrate the Device. <p>Macintosh</p> <p>Go to the Calibrate panel in the HP Inkjet Utility and click Align.</p> <p>For more information about the HP Inkjet Utility, see the HP Photosmart Printer Help. For information about viewing the printer help, see view the hp photosmart printer help on page 2.</p>

Problem	Possible cause	Solution
Print quality is poor.	You may be printing in Ink-backup Printing Mode. The printer enters Ink-backup Printing Mode when one of the print cartridges is missing.	Replace the missing print cartridge with a new one. For more information, see install or replace a print cartridge on page 13.
	You may be printing in Ink-backup Printing Mode with the black print cartridge installed and borderless printing turned off.	Replace the missing print cartridge with a new one. For more information, see install or replace a print cartridge on page 13. For more information about using Ink-backup Printing Mode, see use ink-backup printing mode on page 18.
	One of the print cartridges may be running out of ink.	<p>Windows PC Check the ink levels of the print cartridges from the Estimated Ink Level tab of the HP Photosmart Series Toolbox.</p> <p>Macintosh Check the ink level status in the HP Inkjet Utility. For more information about checking ink levels, see the HP Photosmart Printer Help. For information about viewing the printer help, see view the hp photosmart printer help on page 2</p> <p>If a print cartridge is running low on ink, replace it. For more information, see install or replace a print cartridge on page 13.</p>
	You may need to clean the print cartridges.	<p>Windows PC From the Device Services tab of the HP Photosmart Series Toolbox, click Clean the Print Cartridges.</p> <p>Macintosh From the Clean panel in the HP Inkjet Utility, click Clean.</p>

Problem	Possible cause	Solution
Photos are not printing correctly.	You may have used your software application's Page Setup dialog box to select the paper size or type.	Windows PC From the software application's File menu, select Print , then click Properties to set the correct paper size and type. Macintosh <ul style="list-style-type: none">• From the software application's File menu, select Print to set the correct paper type.



A

Assistant, HP Photosmart, 29

B

blinking indicator lights, 6

buttons

Cancel, 4, 5

control panel, 4

On, 4

Print 4 x 6 Photos, 4, 5

Print Photo Collage, 4, 5

Save, 4

C

calibrate print cartridges, 15

camera, digital, print from, 33

camera-selected photos

print, 27

Cancel button, 4, 5

cards, memory

indicator light, 6

insert, 20

print 4 x 6 photos, 24

print photo collage, 26

remove, 23

slots, 6

supported, 19

view information about, 30

cartridges, print

cradle location, 3

install, 13

remove, 16

status light, 6

storage area location, 3

store, 17

supported, 12

cassette, photo

load paper, 8

remove, 10

control panel, 4

buttons, 4

location, 3

print camera-selected

photos from, 27

print from, 24

save from, 28

view information about, 29

D

digital camera, print from, 33

direct printing

from digital camera, 33

from laptop, 34

port location, 4

E

errors, view information

about, 31

G

green indicator lights, 6

H

HP Photosmart Assistant, 29

I

icons

memory card, 39

printer, 39

Windows taskbar, 38

illustrations

back of printer, 4

control panel, 4

front of printer, 3

indicator lights, 6

memory card slots, 6

In tray, 3, 7

indicator lights, 6

ink-backup printing mode, 18

insert memory cards, 20

install print cartridges, 13

L

laptop, print from, 34

lights

memory card, 6

print cartridge status, 6

printer status, 6

location

control panel, 3

direct printing port, 4

indicator lights, 6

main cover, 3

power cord connection, 4

print cartridge cradle, 3

print cartridge storage

area, 3

rear access door, 4

top cover, 3

USB port, 4

M

Macintosh, print from, 40

main cover location, 3

memory cards

icon, 39

indicator light, 6

insert, 20

print 4 x 6 photos, 24

print photo collage, 26

remove, 23

slots, 6

supported, 19

view information about, 30

O

On button, 4

Out tray, 3

P

panel, control, 4

paper

load in In tray, 7

load in photo cassette, 8

recommended paper, 43

trays, location, 3

trays, store, 11

parts, printer, 3–6

photo cassette

load paper, 8

remove, 10

photo paper

handle, 11

maintain, 11

store, 11

photos

4 x 6 inch, 24

collage, 26

print camera-selected, 27

print from control panel, 24

save from control panel, 28

ports

direct printing, 33

USB, 4

power cord connection

location, 4

print

- 4 x 6 photos, 24
- camera-selected photos, 27
- direct-printing port, 33
- from control panel, 24
- from digital camera, 33
- from laptop, 34
- from Macintosh
 - application, 40
- from Windows
 - application, 37
- ink-backup mode, 18
- photo collage, 26
- Print 4 x 6 Photos button, 4, 5
- print cartridges
 - calibrate, 15
 - cradle location, 3
 - indicator light, 6
 - install, 13
 - remove, 16
 - status light, 6
 - storage area location, 3
 - store, 17
 - supported, 12
- Print Photo Collage button, 4, 5
- printer
 - icon, 39
 - indicator lights, 6
 - parts, 3–6

- print camera-selected
 - photos from, 27
- specifications, 44

R

- rear access door location, 4
- recommended paper, 43
- red indicator lights, 6
- remove
 - memory cards, 23
 - photo cassette, 10
 - print cartridges, 16
- replace print cartridges, 13

S

- Save button, 4
- save photos from control
 - panel, 28
- slots, memory card, 6
- software
 - print from Macintosh, 40
 - print from Windows, 37
- specifications, printer, 44
- store
 - In and Out paper trays, 11
 - print cartridges, 17
- supported
 - memory cards, 19

- print cartridges, 12

T

- taskbar, Windows, icons, 38
- top cover location, 3
- trays
 - In, 3, 7
 - Out, 3
 - photo cassette, 8
 - photo cassette, remove, 10
 - store, 11

U

- USB port location, 4





V

- view
 - control panel
 - information, 29
 - error information, 31
 - memory card
 - information, 30

W

- Windows
 - print from, 37
 - taskbar icons, 38

printer control panel quick reference

Button	Description
	ON Press this button to turn the printer on or off.
	SAVE Press this button to save the contents of the memory card to your computer.
	PRINT 4 X 6 PHOTOS Use this button to print 4 x 6 inch photos: <ul style="list-style-type: none">• Press this button to print all photos or all camera-selected photos on the memory card.• Press and hold this button to print all photos on a memory card that have not been previously printed from the control panel.• Press this button to continue printing after resolving a printing error.• Press this button to continue printing after reloading paper.
	PRINT PHOTO COLLAGE Use this button to print photo collage pages: Note: A photo collage prints four images on 4 x 6 inch paper or nine images on 8.5 x 11 inch paper. <ul style="list-style-type: none">• Press this button to print all photos or all camera-selected photos on the memory card on photo collage pages.• Press and hold this button to print on photo collage pages all photos on a memory card that have not been previously printed from the printer's control panel.• Press this button to continue printing after resolving a printing error.• Press this button to continue printing after reloading paper.
	CANCEL Use this button to stop a process: <ul style="list-style-type: none">• Press this button to stop printing.• Press this button to stop saving images from the memory card to your computer.• Press this button to skip printing camera-selected photos on a memory card so you can print unmarked photos.



Printed on recycled paper
Printed in U.S., 5/03



ENERGY STAR® is a U.S. registered mark.
As an ENERGY STAR® partner,
Hewlett-Packard Company has determined that this
product meets the ENERGY STAR® guidelines for
energy efficiency.

www.hp.com

©2003 Hewlett-Packard Company



Q3005-90167



i n v e n t

v1.3.0