

hp photosmart
240 series



basics guide



All rights are reserved. No part of this document may be photocopied, reproduced, or translated to another language without the prior written consent of Hewlett-Packard Company.

The information contained in this document is subject to change without notice. Hewlett-Packard shall not be liable for errors contained herein or for consequential damages in connection with the furnishing, performance, or use of this material.

HP, the HP logo, and Photosmart are property of Hewlett-Packard Company.

The Secure Digital logo is a trademark of the SD Association.

Microsoft and Windows are registered trademarks of Microsoft Corporation.

CompactFlash, CF, and the CF logo are trademarks of the CompactFlash Association (CFA).

Sony Memory Stick and Sony Memory Stick Duo are trademarks or registered trademarks of Sony Corporation.

MultiMediaCard is a trademark of Infineon Technologies AG of Germany, and is licensed to the MMCA (MultiMediaCard Association).

SmartMedia is a trademark of Toshiba Corporation.

xD-Picture Card is a trademark of Fuji Photo Film Co., Ltd., Toshiba Corporation, and Olympus Optical Co., Ltd.

Mac, the Mac logo, and Macintosh are registered trademarks of Apple Computer, Inc.

Other brands and their products are trademarks or registered trademarks of their respective holders.

The embedded software in your printer is based in part on the work of the Independent JPEG Group.

The copyrights to certain photos within this document are retained by the original owners.

Regulatory Model Identification Number SDGOA-0324

For regulatory identification purposes, your product is assigned a Regulatory Model Number. The Regulatory Model Number for your product is SDGOA-0324. This regulatory number should not be confused with the marketing name (hp photosmart 240 series printer) or product number (Q3046A).

safety information

Always follow basic safety precautions when using this product to reduce risk of injury from fire or electric shock.

Warning! To prevent fire or shock hazard, do not expose this product to rain or any type of moisture.

Warning! Potential shock hazard.

- Read and understand all instructions in the *HP Photosmart Setup Guide*.
- Use only a grounded electrical outlet when connecting the unit to a power source. If you do not know whether the outlet is grounded, check with a qualified electrician.
- Observe all warnings and instructions marked on the product.
- Unplug this product from wall outlets before cleaning.
- Do not install or use this product near water or when you are wet.
- Install the product securely on a stable surface.
- Install the product in a protected location where no one can step on or trip over the power cord, and where the power cord will not be damaged.
- If the product does not operate normally, see the troubleshooting information in the HP Photosmart Printer Help.
- There are no operator serviceable parts inside. Refer servicing to qualified service personnel.
- Use in a well-ventilated area.



contents

1	get started	1
	welcome	1
	documentation	2
	printer parts	3
	front of the printer	3
	back of the printer	3
	indicator lights	4
	memory card slots	4
	control panel	5
	printer menu	5
	printer menu structure	6
	paper information	8
	load the paper	8
	maintain the quality of your photo paper	9
	print cartridge information	10
	install or replace the print cartridge	10
	remove the print cartridge	12
2	print from a memory card	13
	supported memory cards	13
	insert a memory card	14
	remove a memory card	17
	decide which photos to print	17
	view photos on the printer's LCD screen	17
	print a photo index	18
	select photos to print	19
	select a photo	19
	deselect a photo	20
	deselect all photos	20
	print photos	21
	print a single photo	21
	print multiple photos	22
	print more than one copy of a photo	22
	print a continuous range of photos	23
	print all photos	24
	print new photos	24
	print video clips	25
	print camera-selected photos	26
3	print from an hp direct-printing digital camera	27
	connect your hp direct-printing digital camera to the printer	27

4	get creative	29
	change the photo layout	29
	change the number of copies	30
	crop a photo	31
	adjust the photo brightness	32
	add frames to your photos	32
	change the photo color effect	33
	change the print quality	34
	view a slide show	34
5	set printer preferences	35
	deselect all photos after printing	35
	default number of copies	36
	default photo layout	36
	default layout for video action prints	37
	date and time stamp	37
	borderless printing	38
	Exif printing	39
	improve contrast	39
	extend colors	40
	unmark camera-selected photos after printing	40
	revert to the factory default settings	41
	LCD screen language and country/region	42
6	maintain and transport your printer	43
	clean and maintain your printer	43
	clean the printer	43
	clean the print cartridge	43
	print a test page	44
	calibrate the print cartridge	45
	store your printer	45
	store the printer	46
	store the print cartridge	46
	transport your printer	46
7	troubleshooting	47
	hardware problems	47
	printing problems	48
	error messages	51
8	specifications	53
	recommended paper	53
	printer specifications	54
	index	57



get started

welcome

Thank you for purchasing an HP Photosmart 240 Series printer! With your new, compact photo printer, you can print beautiful photos quickly and easily with or without a computer.

For information about:

- Printing photos stored on your digital camera's memory card, see **print from a memory card** on page 13.
- Printing camera-selected photos stored on your digital camera's memory card, see **print camera-selected photos** on page 26.
- Printing camera-selected photos by connecting your HP direct-printing digital camera to your printer, see **print from an hp direct-printing digital camera** on page 27.
- Adding decorative frames to your photos, changing photo color effects, adjusting the photo brightness, cropping your photos, changing the photo layout and number of copies, and other creative features, see **get creative** on page 29.
- Changing printer settings, such as setting the default photo layout, automatically improving photo contrast and color saturation, and setting your photos to print with or without white borders, see **set printer preferences** on page 35.
- Saving photos to your computer and printing from a computer, see the HP Photosmart Printer Help. For information about viewing the Printer Help, see **view the hp photosmart printer help** on page 2.

documentation

Your new printer comes with the following documentation to help you get started and get the most out of your printer:

- **Setup Guide**—The *HP Photosmart Setup Guide* contains quick and easy instructions to help you set up your printer and print your first photo.
- **Basics Guide**—The *HP Photosmart 240 Series Basics Guide* is the booklet you are reading. This booklet helps you get acquainted with your new printer. It describes how to use your printer without a computer and contains hardware troubleshooting information.
- **Setup & Support Reference Guide**—The *HP Photosmart Setup & Support Reference Guide* explains how to install and set up the software that comes with your printer. It contains software troubleshooting information, describes how to get support from **www.hp.com**, and explains how to contact HP support.
- **HP Photosmart Printer Help**—The HP Photosmart Printer Help provides comprehensive information about your printer's features, describes how to use your printer with a computer, and contains advanced troubleshooting information.

After you have installed the HP Photosmart printer software on your computer, you can view and print the HP Photosmart Printer Help.

view the hp photosmart printer help

- **Windows® PC**: From the **Start** menu, select **Programs** or **All Programs**; **Hewlett-Packard**; **Photosmart 140, 240, 7200, 7600, 7700, 7900 Series**; **Photo & Imaging Director**. From the **Photo & Imaging Director**, click **Help**.
- **Macintosh®**: Insert the HP Photosmart CD. In the **User Docs** folder, select your language, then double-click the **photosmart 240.html** file.

print the hp photosmart printer help

- **Windows PC**: Click **Print** in the top navigation bar of the HP Photosmart Printer Help window.
- **Macintosh**: Click in the frame you want to print. From the **File** menu, select **Print**, or click **Print** in the top navigation bar of the browser.

printer parts

front of the printer

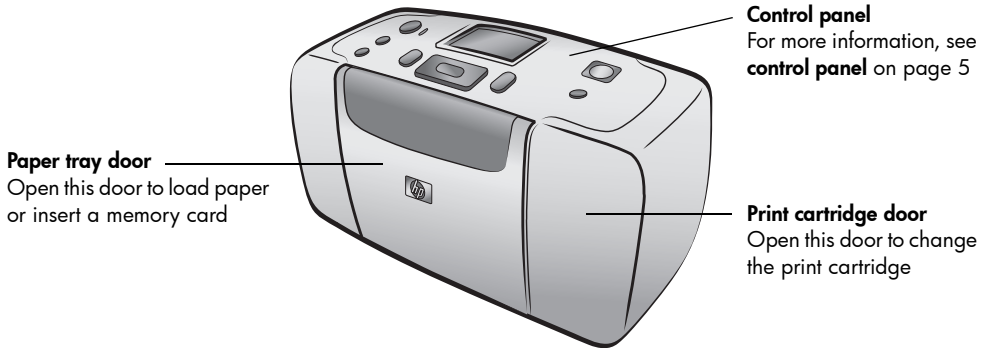

back of the printer

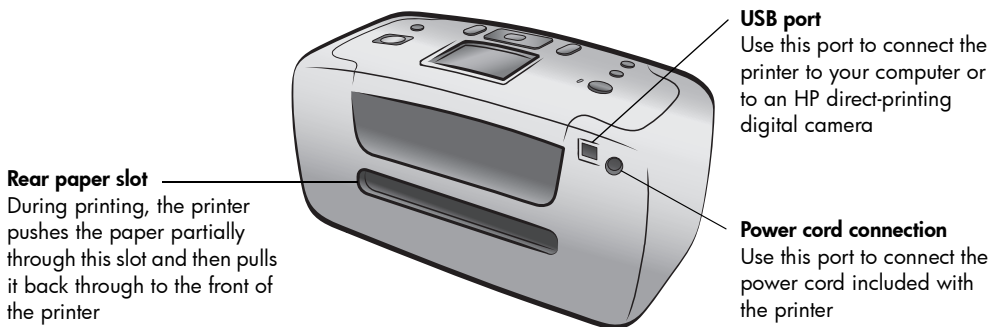

Note: Place the printer on a flat, stable surface with the back of the printer at least 10 inches (250 mm) away from any obstruction to allow space for the paper to move during printing. Make sure the power cord and USB cable do not block the rear paper path.



indicator lights

**On/Attention light
On (Green)**

The power is on
Off

The printer is in
power-save mode

Blinking (Green)

The printer is busy

Blinking (Red)

The printer requires
attention



**Memory card light
On**

The memory card is
inserted correctly

Off

No memory card is
inserted

Blinking

Information is being
transmitted between
the memory card and
the printer or computer

memory card slots

CompactFlash™ memory card slot

You can insert a CompactFlash memory card
into this slot

SmartMedia™/xD-Picture Card™ memory card slot

You can insert a SmartMedia memory card into the
upper portion of this slot or an xD-Picture Card
memory card into the lower right portion of this slot

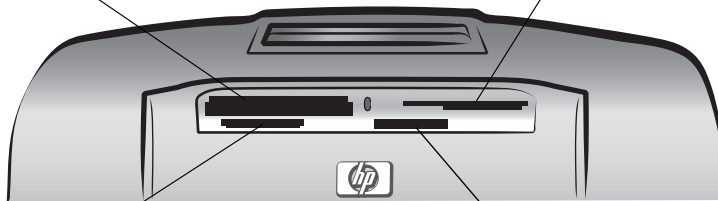

MultiMediaCard™/Secure Digital™ memory card slot

You can insert a MultiMediaCard or Secure Digital
memory card into this slot

Sony® Memory Sticks memory card slot

You can insert a supported Sony Memory Stick
memory card into this slot

Note: For information about how to insert a memory card into your printer, see **insert a memory card** on page 14.

control panel

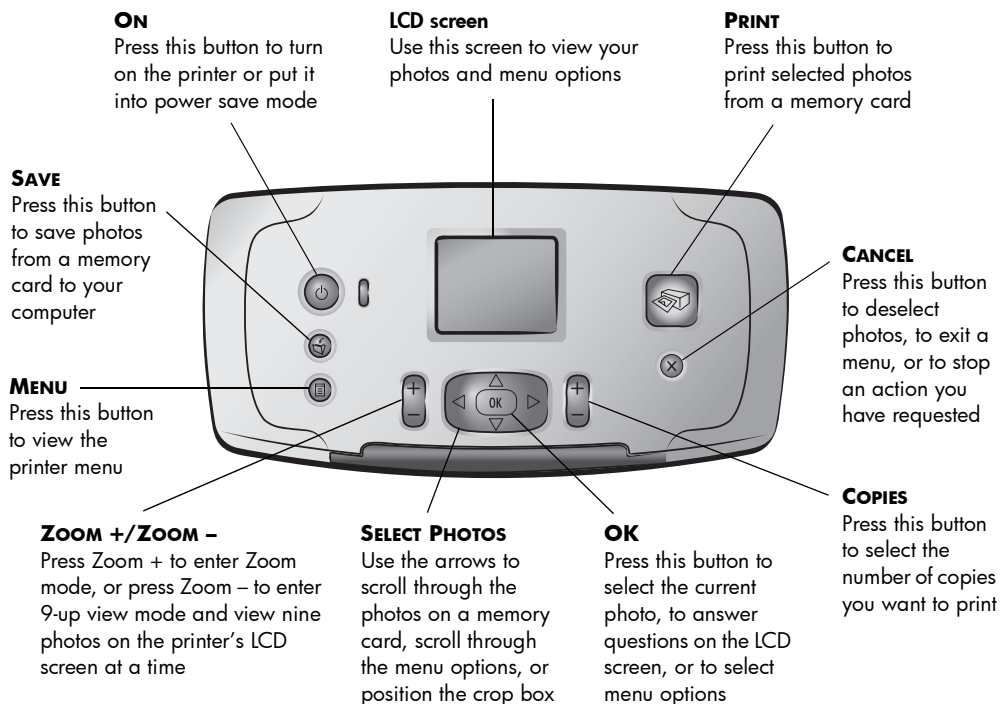

Note: The **SAVE** button works only when your printer is connected to a computer. For more information, see the HP Photosmart Printer Help. For information about viewing the Printer Help, see **view the hp photosmart printer help** on page 2.

printer menu

Press the **MENU** button on the printer's control panel to access the printer menu.

To navigate the printer menu:

- Press the **SELECT PHOTOS** ▲ or ▼ button to scroll through the menu options displayed on the printer's LCD screen.
- Press the **OK** button to open a menu or select an option.
- Press the **CANCEL** button to exit the current menu.

Note: You cannot access the printer menu while you are viewing photos in 9-up view mode on the printer's LCD screen. Press the **ZOOM +** button to exit 9-up view mode and return to viewing one photo at a time before pressing the **MENU** button.

printer menu structure

Top level menu	Submenus/options	Additional submenus/options
Change layout	Select Layout: <ul style="list-style-type: none"> • 1 photo • 2 photos • 4 photos 	
Print special	Print all	
	Print range	Select beginning of range: Select end of range:
	Print new	
	Print index	
Enhance image	Photo brightness	Photo brightness: (select -3 to +3; default is 0 and represents no change)
	Add frame	Select pattern: Select color:
	Add color effect	Choose color effect: <ul style="list-style-type: none"> • Black & white • Sepia • Antique • No effect (default)
Tools	Slide show	
	Print quality	Print quality: <ul style="list-style-type: none"> • Best (default) • Normal
	Print test page	
	Clean cartridge	Continue to second level cleaning? <ul style="list-style-type: none"> • Yes • No
		Continue to third level cleaning? <ul style="list-style-type: none"> • Yes • No
	Calibrate printer	

Top level menu	Submenus/options	Additional submenus/options
Preferences	After printing	After printing, deselect all photos: <ul style="list-style-type: none"> • Always • Never • Ask (default)
	# of copies	Set default number of copies: (select 1 to 99; default is 1)
	Photo layout	Set default photo layout: <ul style="list-style-type: none"> • Ask (default) • 1 photo • 2 photos • 4 photos
	Video print	Set default video print frames: <ul style="list-style-type: none"> • 9 per page (default) • 16 per page • 25 per page
	Add date/time	Date/time stamp: <ul style="list-style-type: none"> • Date/time • Date only • Off (default)
	Borderless	Turn borderless printing: <ul style="list-style-type: none"> • On (default) • Off
	Exif printing	Turn Exif printing: <ul style="list-style-type: none"> • On (default) • Off
	Improve contrast	Turn improve contrast: <ul style="list-style-type: none"> • On (default) • Off
	Extend colors	Turn extend colors: <ul style="list-style-type: none"> • On • Off (default)
	Camera selections	Unmark camera selected photos: <ul style="list-style-type: none"> • Always • Never • Ask (default)
	Restore defaults	Restore original factory preferences: <ul style="list-style-type: none"> • Yes • No
	Language	Select language: Select country/region:

paper information

You can print photos on photo paper, plain paper, or index cards. Your printer supports the following paper types and sizes:

Type	Size	Purpose
Photo paper	4 x 6 inches (10 x 15 cm)	Printing photos
Photo paper with tab	4 x 6 inches with 0.5 inch tab (10 x 15 cm with 1.25 cm tab)	Printing borderless photos
Index cards	4 x 6 inches (10 x 15 cm)	Printing drafts, calibration pages, and test pages
Hagaki cards	3.9 x 5.8 inches (100 x 148 mm)	Printing photos
A6 cards	4.1 x 5.8 inches (105 x 148 mm)	Printing photos
L-size cards	3.5 x 5 inches (90 x 127 mm)	Printing photos
L-size cards with tab	3.5 x 5 inches with 0.5 inch tab (90 x 127 mm with 12.5 mm tab)	Printing borderless photos

To get the best performance from your printer, use genuine HP photo paper. For more information, see **recommended paper** on page 53.

Note: If you are printing from the computer and using HP photo paper, select the paper type when you set the print settings. For more information, see the HP Photosmart Printer Help. For information about viewing the Printer Help, see **view the hp photosmart printer help** on page 2.

load the paper

During printing, the printer pushes the paper partially through the rear paper slot on the back of the printer and then pulls it back through to the front of the printer. Make sure the back of the printer is at least 10 inches (250 mm) away from any obstruction and that the power cord and USB cable do not block the rear paper path.

To load paper:

- 1 Open the paper tray door and push it down as far as it will go.
- 2 Place a stack of paper on the paper tray and slide it underneath the output guide.
 - The printer prints on the side of the paper that is facing up. If you are using photo paper, load the paper with the **glossy side up**. If you are using tabbed paper, load the paper into the paper tray so the **tab feeds into the printer first**.
 - Load 10 to 20 sheets of photo paper or index cards.
 - Use one type and size of paper at a time. Do not mix paper types or sizes in the paper tray.

- 3 Move the paper width guide on the paper tray to fit close to the left edge of the paper without bending the paper. This helps the paper feed straight into the printer.

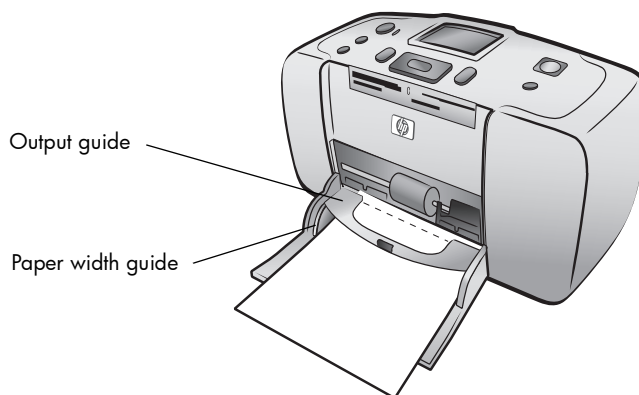

Tip: With paper other than HP premium plus photo paper, you may experience paper feeding or ejecting problems. Try loading fewer sheets of paper at a time and make sure the edges of the paper stack are lined up.

maintain the quality of your photo paper

To ensure high-quality prints, it is important to maintain the quality of your photo paper by storing and handling it properly.

store photo paper

Keep unused photo paper in its original packaging inside a resealable plastic bag. Store the packaged photo paper on a flat surface in a cool, dry place.

When you are ready to print, remove only the paper you plan to use immediately. When you are finished printing, return any unused photo paper to the plastic bag.

Note: Do not leave unused paper in the printer's paper tray. The paper may start to curl, which may reduce the quality of your photographs. Photo paper should be flat before printing. For information about flattening curled paper, see the following section.

handle photo paper

Always hold photo paper by the edges. Fingerprints on photo paper can reduce print quality.

If the corners of the photo paper curl, place the paper in a resealable plastic bag and gently bend it in the opposite direction of the curl until the paper lies flat.

print cartridge information

Your HP Photosmart 240 Series printer can print color and black and white photos. HP provides two types of print cartridges so you can choose the best print cartridge for your project.

For the highest quality photos, follow these guidelines:

To print...	Use...
Color photos	HP #57 (C6657A) tri-color print cartridge
Black and white photos	HP #59 (C9359A) photo gray print cartridge (available Fall 2003)

Caution! Check that you are using the correct print cartridge. Also, note that HP does not recommend modifying or refilling HP print cartridges. Damage that results from modifying or refilling HP print cartridges is not covered by HP's warranty.

install or replace the print cartridge

To get the best performance from your printer, use only genuine HP factory-filled print cartridges.

Note: When you install a new print cartridge, the printer calibrates the print cartridge and prints a calibration page.

To install or replace the print cartridge:

- 1 If the printer is off, press the **ON** button on the printer's control panel to turn on the printer.
- 2 Load an index card in the paper tray so the printer can print a calibration page after you install the print cartridge. For information about loading index cards, see **load the paper** on page 8.
- 3 Take the new print cartridge out of its package and pull the **pink tab** to remove the clear plastic tape. Be sure to install the print cartridge immediately after removing the tape; ink nozzles exposed longer than one minute may dry out and cause printing problems later. Once the tape is removed, do not attempt to replace it.

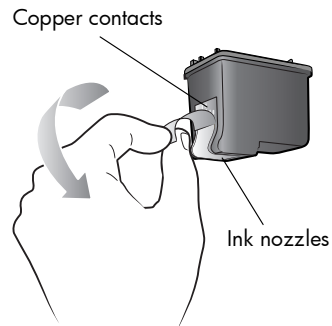

Caution! Do **not** touch the ink nozzles or the copper contacts on the print cartridge. Touching these parts may cause the print cartridge to fail.

- 4 Open the print cartridge door.

The red On/Attention light flashes when the print cartridge door is open.

Note: For instructions on removing a previously installed print cartridge, see **remove the print cartridge** on page 12.

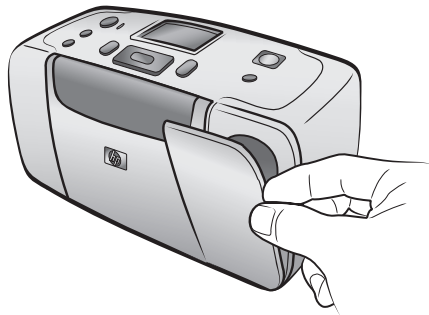

- 5 Place the print cartridge in the print cartridge cradle with the copper contacts facing toward the inside of the printer and the ink nozzles facing down.

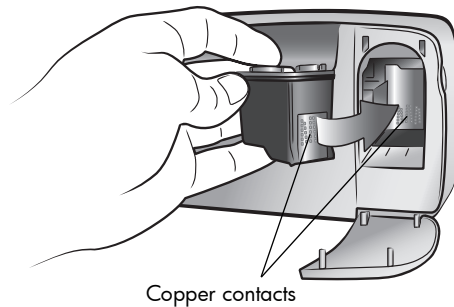

- 6 Push the print cartridge into the print cartridge cradle until you feel it snap into place.



- 7 Close the print cartridge door.

After you install a new print cartridge, a message appears on the printer's LCD screen asking you to load plain paper in the paper tray and press the **OK** button. When you press the **OK** button, the printer automatically calibrates the new print cartridge and prints a calibration page to confirm that the print cartridge is installed correctly and functioning properly. For more information, see **calibrate the print cartridge** on page 45.

remove the print cartridge

To remove the print cartridge:

- 1 Open the print cartridge door.
- 2 Push down and pull outward on the top of the print cartridge to unsnap it from the print cartridge cradle.



- 3 Remove the print cartridge from the printer.

If there is ink in the print cartridge, place the cartridge in a print cartridge protector for storage. If the print cartridge is empty, discard or recycle the print cartridge. For information about recycling print cartridges, go to www.hp.com/recycle.

2

print from a memory card

It's easy to print high-quality photos for yourself, family, and friends. If your digital camera uses a memory card to store photos, you can insert the memory card into the printer to print your photos. Messages on the printer's LCD screen guide you through the process—you don't have to turn on your computer or even have your printer connected to a computer!

Note: You can also print photos using your computer. For more information, see the HP Photosmart Printer Help. For information about viewing the Printer Help, see **view the hp photosmart printer help** on page 2.

supported memory cards

Your HP Photosmart printer can read the following memory cards: CompactFlash Association (CFA) certified Type I and II, MultiMediaCard, Secure Digital, SmartMedia, Sony Memory Sticks, and xD-Picture Card.

These cards are manufactured by several vendors and are available in a variety of storage capacities. You can purchase memory cards where you purchased your digital camera or at most computer supply stores.

Caution! Using any other type of memory card may damage the memory card and the printer.

The following illustration shows the side of the memory card that faces up when you insert the memory card into your printer.

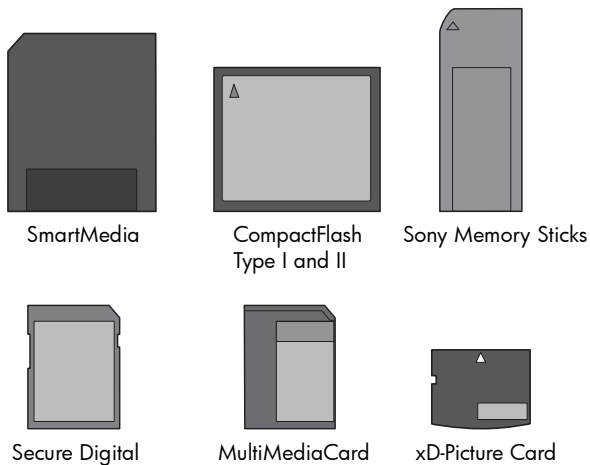

supported file formats

You can print photos from JPEG and uncompressed TIFF image files directly from the memory card. You can also print video action prints from Motion JPEG AVI, Motion JPEG Quicktime, and MPEG-1 video files directly from the memory card. If your digital camera supports other file formats, such as FlashPix and RAW, save the files to your computer and print them using a software application. For more information, see the HP Photosmart Printer Help. For information about viewing the Printer Help, see **view the hp photosmart printer help** on page 2.

insert a memory card

After you have taken pictures with your digital camera, remove the memory card from the camera and insert it into your printer. When the memory card is inserted correctly, the memory card light blinks and then remains solid.

Caution! Do not pull out the memory card while the memory card light is blinking. Removing a memory card while it is being accessed may damage the printer or the memory card, or corrupt the information on the memory card. For more information, see **remove a memory card** on page 17.



To insert a memory card:

- 1 Remove any memory cards that are already inserted into any of the memory card slots.

Caution! Do not pull out a memory card while the memory card light is blinking. For more information, see **remove a memory card** on page 17.

- 2 Hold the memory card so the correct side faces up. To determine the correct orientation for your memory card, see the table after these steps.

Note: If you are using a Sony Memory Stick Duo™ memory card, attach the adapter that came with the memory card before you insert it into the printer's memory card slot.

- 3 Insert the memory card into the appropriate memory card slot. The end with the metal contacts must go into the printer first.



Caution! Inserting the memory card any other way may damage the memory card or the printer.

- 4 Gently push the memory card into the printer until it stops. The memory card does not insert all the way into the printer.

Caution! Forcing the memory card into the printer too far may damage the memory card or the printer.

Note: If you insert a SmartMedia memory card upside down, the red On/Attention light will begin blinking. Remove the memory card and reinsert it properly.

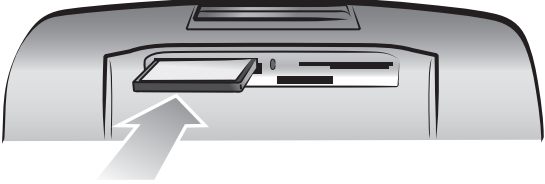
Once the memory card is inserted correctly, the printer reads the card and briefly displays how many photos and video clips were found.

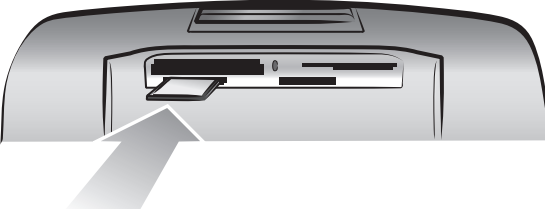
Memory card	Memory card slot	How to hold and insert the memory card
CompactFlash Type I or II	Top left slot	<ul style="list-style-type: none"> • Front label faces up, and if the label has an arrow, the arrow points toward the printer • Pinholes insert into the printer first 
MultiMediaCard	Bottom left slot	<ul style="list-style-type: none"> • Label faces up, angled corner is on the right, and arrow points toward the printer • Metal contacts face down 
Secure Digital	Bottom left slot	<ul style="list-style-type: none"> • Label faces up, and angled corner is on the right • Metal contacts face down 

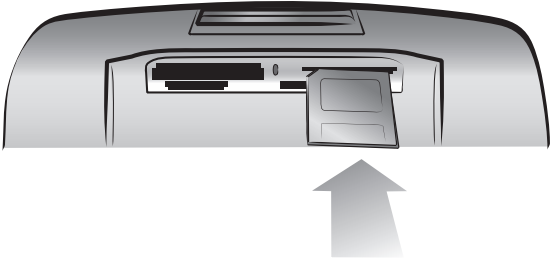
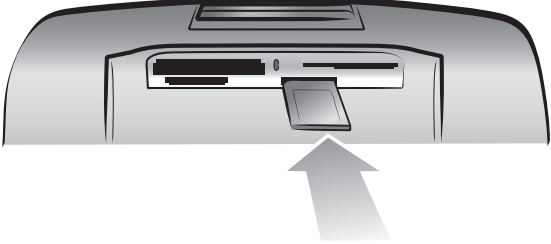
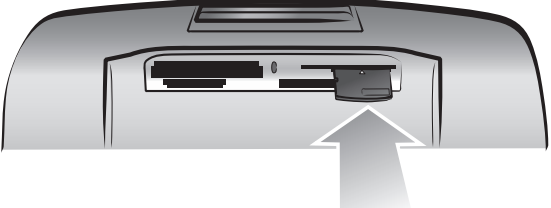
Memory card	Memory card slot	How to hold and insert the memory card
SmartMedia	Upper portion of the top right double slot	<ul style="list-style-type: none"> • Angled corner is on the left, and if the label has an arrow, the arrow points toward the printer • Metal contacts face down 
Sony Memory Sticks	Bottom right slot	<ul style="list-style-type: none"> • Angled corner is on the left, and arrow points toward the printer • Metal contacts face down 
xD-Picture Card	Lower right portion of the top right double slot	<ul style="list-style-type: none"> • Label faces up, and arrow points toward the printer • Metal contacts face down 

Note: If you used your digital camera to select photos on the memory card for printing, a message appears on the printer's LCD screen asking if you want to print camera-selected photos. For more information, see **print camera-selected photos** on page 26.

remove a memory card

Once the memory card light stops blinking, gently pull the memory card to remove it from the printer's memory card slot.

Caution! Do not pull out the memory card while the memory card light is blinking. A blinking light means that the printer is accessing the memory card. Wait until the memory card light remains solid. Removing a memory card while it is being accessed may damage the printer and the memory card or corrupt the information on the memory card.

decide which photos to print

You can decide which photos to print by viewing the photos on the printer's LCD screen or by printing a photo index.

view photos on the printer's LCD screen

You can use the printer's LCD screen to view the first 2000 photos on a memory card.

Note: If your memory card contains more than 2000 photos, save the photos to your computer and access them from there. For more information, see the HP Photosmart Printer Help. For information about viewing the Printer Help, see **view the hp photosmart printer help** on page 2.

To view photos on the printer's LCD screen:

- 1 Insert the memory card into the printer's memory card slot. For more information, see **insert a memory card** on page 14.

The printer reads the memory card and briefly displays how many photos and video clips were found on the card.

Note: If you used your digital camera to select photos on the memory card, a message appears on the printer's LCD screen asking if you want to print camera-selected photos. For more information, see **print camera-selected photos** on page 26.

- 2 If you have not changed the default photo layout in the printer preferences, you will be asked to select a layout for your photos. Press the **SELECT PHOTOS** ▲ or ▼ button to highlight the photo layout you want to print, then press the **OK** button. For information about changing the default photo layout, see **default photo layout** on page 36.

The first photo on the memory card appears on the printer's LCD screen.

- 3 You can view the photos in two ways:
 - **To view the photos one at a time:** Press the **SELECT PHOTOS** ◀ or ▶ button to navigate through the photos.
 - **To view nine photos at a time:** Press the **ZOOM –** button to enter 9-up view mode. Use the arrows on the **SELECT PHOTOS** button to navigate through the photos. To exit 9-up view mode and return to viewing one photo at a time, press the **ZOOM +** button.

Tip: To move quickly through the photos, press and hold the arrows on the **SELECT PHOTOS** button. When you reach the last photo in either direction, the printer cycles back to the first or last photo and continues.

Note: If you use your computer to delete files from your memory card, the files you delete may still appear on the printer's LCD screen. After deleting the files, remove the memory card following the instructions in **remove a memory card** on page 17. Reinsert the memory card to update the printer's LCD screen.

print a photo index

A photo index shows thumbnail views and index numbers for all the photos stored on the memory card, up to a maximum of 2000 photos. The photos appear in the order in which they are stored on the memory card. The photo index will print up to 28 photos per page.

Note: Depending on the number of photos stored on the memory card, a photo index could be several pages long.

The thumbnail views in a photo index print at low resolution in order to print quickly, so they do not represent the final print quality of the photos.

Index numbers appear in the bottom left corner of each thumbnail view and indicate the order of the photos on the memory card.

Note: If an icon of a video camera appears in the bottom right corner of an image in the photo index, the image is the first frame of a video clip. For more information, see **print video clips** on page 25.

To print a photo index:

- 1 Insert a memory card into the printer's memory card slot. For more information, see **insert a memory card** on page 14.



The printer reads the memory card and briefly displays how many photos and video clips were found on the card.

Note: If you used your digital camera to select photos on the memory card, a message appears on the printer's LCD screen asking if you want to print camera-selected photos. For more information, see **print camera-selected photos** on page 26.

- 2 Load paper in the paper tray. To conserve photo paper, use plain paper or index cards. For more information, see **load the paper** on page 8.

- 3 If you have not changed the default photo layout in the printer preferences, you will be asked to select a layout for your photos. Since the layout setting is ignored when you print a photo index, simply press the **OK** button to continue. For information about changing the default photo layout, see **default photo layout** on page 36.

The first photo on the memory card appears on the printer's LCD screen.

- 4 Press the **MENU** button on the printer's control panel.
- 5 Press the **SELECT PHOTOS** ▾ button until **Print special** is highlighted on the printer's LCD screen. Press the **OK** button.
- 6 Press the **SELECT PHOTOS** ▾ button until **Print index** is highlighted on the printer's LCD screen. Press the **OK** button.

A photo index showing all the photos stored on the memory card, up to a maximum of 2000 photos, begins printing.

select photos to print

You can select one or more photos to print using the printer's control panel.

select a photo

- 1 Insert a memory card into the printer's memory card slot. For more information, see **insert a memory card** on page 14.

Note: If you used your digital camera to select photos on the memory card, a message appears on the printer's LCD screen asking if you want to print camera-selected photos. For more information, see **print camera-selected photos** on page 26.

- 2 If you have not changed the default photo layout in the printer preferences, you will be asked to select a layout for your photos. Press the **SELECT PHOTOS** ▲ or ▾ button to highlight the photo layout you want to print, then press the **OK** button. For information about changing the default photo layout, see **default photo layout** on page 36.

The first photo on the memory card appears on the printer's LCD screen.

- 3 Press the **SELECT PHOTOS** ◀ or ▶ button to navigate to the photo you want to select.

Tip: To move quickly through the photos, press and hold the **SELECT PHOTOS** ◀ or ▶ button.

- 4 When the photo you want to select appears on the printer's LCD screen, press the **OK** button to select it.

A small printer icon appears in the bottom left corner of the photo on the printer's LCD screen to indicate that the photo has been selected. The default number of copies and an icon showing the current photo layout also appear at the bottom of the photo. In addition, a green crop box is displayed around the photo to indicate the portion of the photo that will be printed. A message telling you the photo is selected for printing appears briefly.



- 5 To select additional photos to print, repeat steps 3 and 4.

To select a photo in 9-up view mode:

- 1 Press the **ZOOM –** button to enter 9-up view mode. (In 9-up view mode, nine photos appear on the printer's LCD screen at a time.)
- 2 Use the arrows on the **SELECT PHOTOS** button to navigate through the photos.
Tip: To move quickly through the photos, press and hold the arrows on the **SELECT PHOTOS** button.
- 3 When the photo you want to select appears highlighted on the printer's LCD screen, press the **OK** button to select it.
 A small printer icon appears in the bottom left corner of the photo on the printer's LCD screen to indicate that the photo has been selected.
- 4 To select additional photos to print, repeat steps 2 and 3.
Note: To exit 9-up view mode and return to viewing one photo at a time, press the **ZOOM +** button.
Note: You cannot access the printer menu while you are viewing photos in 9-up view mode.

deselect a photo

- Press the **SELECT PHOTOS ◀** or **▶** button to display the photo you want to deselect, then press the **CANCEL** button.
- In 9-up view mode, use the arrows on the **SELECT PHOTOS** button to highlight the photo you want to deselect, then press the **CANCEL** button.

The printer deselects the photo and discards any changes you made to that photo's print settings—number of copies, cropping, brightness, decorative frame, or color effect.

Note: The global printer preferences described in **set printer preferences** on page 35 are not affected when you deselect a photo.

deselect all photos

- 1 To deselect all selected photos, press the **CANCEL** button one or more times until a message appears on the printer's LCD screen asking if you want to deselect all photos.
- 2 Press the **SELECT PHOTOS ▼** button to highlight **Yes**, then press the **OK** button.
Note: Deselecting photos does not delete them from the memory card.

print photos

You can print the photos stored on a memory card using your printer's control panel. Printing photos from a memory card is easy—just insert the memory card into the printer, make your selections, and press the **PRINT** button.

Your printer supports two different types of digital photos stored on a memory card:

- **Unmarked photos**—Standard digital photos that you stored on the memory card but have not marked for printing.
- **Camera-selected photos**—Photos you marked for printing using your digital camera. For more information, see **print camera-selected photos** on page 26.

Note: Not all digital cameras allow you to mark your photos for printing.

For more information about how to:

- Print a single photo, see page 21
- Print multiple photos, see page 22
- Print more than one copy of a photo, see page 22
- Print a continuous range of photos, see page 23
- Print all photos, see page 24
- Print new photos, see page 24
- Print video clips, see page 25
- Print camera-selected photos, see page 26

print a single photo

- 1 Insert a memory card into the printer's memory card slot. For more information, see **insert a memory card** on page 14.
- 2 If you have not changed the default photo layout in the printer preferences, you will be asked to select a layout for your photos. Press the **SELECT PHOTOS** ▲ or ▼ button to highlight the photo layout you want to print, then press the **OK** button. For information about changing the default photo layout, see **default photo layout** on page 36.

The first photo on the memory card appears on the printer's LCD screen.

- 3 Press the **SELECT PHOTOS** ◀ or ▶ button to navigate to the photo you want to print.
- 4 When the photo you want to print appears on the printer's LCD screen, press the **PRINT** button to print it.

print multiple photos

- 1 Insert a memory card into the printer's memory card slot. For more information, see **insert a memory card** on page 14.
- 2 If you have not changed the default photo layout in the printer preferences, you will be asked to select a layout for your photos. Press the **SELECT PHOTOS** ▲ or ▼ button to highlight the photo layout you want to print, then press the **OK** button. For information about changing the default photo layout, see **default photo layout** on page 36.
The first photo on the memory card appears on the printer's LCD screen.
- 3 Press the **SELECT PHOTOS** ◀ or ▶ button to navigate through the photos.
- 4 When a photo you want to print appears on the printer's LCD screen, press the **OK** button to select it.
- 5 If you like, you can change the print settings for the selected photo—number of copies, cropping, brightness, decorative frame, or color effect—as described in **get creative** on page 29.
- 6 To select additional photos, press the **SELECT PHOTOS** ◀ or ▶ button until another photo you want to print appears on the printer's LCD screen. Press the **OK** button to select the photo.
- 7 When you have selected all the photos you want to print and have made any desired changes to the print settings, press the **PRINT** button to begin printing.

Note: If you press the **CANCEL** button during printing, the printer stops printing but retains your photo selections and print settings.

print more than one copy of a photo

- 1 Insert a memory card into the printer's memory card slot. For more information, see **insert a memory card** on page 14.
- 2 If you have not changed the default photo layout in the printer preferences, you will be asked to select a layout for your photos. Press the **SELECT PHOTOS** ▲ or ▼ button to highlight the photo layout you want to print, then press the **OK** button. For information about changing the default photo layout, see **default photo layout** on page 36.
The first photo on the memory card appears on the printer's LCD screen.
- 3 Press the **SELECT PHOTOS** ◀ or ▶ button to navigate to the photo you want to print.
- 4 When the photo you want to print appears on the printer's LCD screen, press the **COPIES +** or **-** button to change the number of copies to print.
- 5 Press the **OK** button when the desired number of copies appears on the printer's LCD screen.

- 6 If you like, you can change the other print settings for the selected photo—cropping, brightness, decorative frame, or color effect—as described in **get creative** on page 29.
- 7 Press the **PRINT** button to begin printing.

Note: If you press the **CANCEL** button during printing, the printer stops printing but retains your photo selections and print settings.

Note: You can print a different number of copies of each selected photo by using the **COPIES +** or **-** button as described in this section. If you do not change the number of copies for a selected photo, the default number of copies will print. The factory default for number of copies is one. For information about changing the default number of copies, see **default number of copies** on page 36.

print a continuous range of photos

You can print a continuous range of the photos stored on a memory card.

- 1 Insert a memory card into the printer's memory card slot. For more information, see **insert a memory card** on page 14.
- 2 If you have not changed the default photo layout in the printer preferences, you will be asked to select a layout for your photos. Press the **SELECT PHOTOS ▲** or **▼** button to highlight the photo layout you want to print, then press the **OK** button. For information about changing the default photo layout, see **default photo layout** on page 36.

The first photo on the memory card appears on the printer's LCD screen.

- 3 Press the **MENU** button on the printer's control panel.
- 4 Press the **SELECT PHOTOS ▼** button until **Print special** is highlighted on the printer's LCD screen. Press the **OK** button.
- 5 Press the **SELECT PHOTOS ▼** button until **Print range** is highlighted on the printer's LCD screen. Press the **OK** button.
- 6 Press the **SELECT PHOTOS ◀** or **▶** button until the first photo you want to print appears in the left box on the printer's LCD screen. Press the **OK** button to select this photo as the beginning of the range of photos you want to print.

The arrows move to the photo in the right box on the printer's LCD screen and you are asked to select the photo at the end of the range.

- 7 Press the **SELECT PHOTOS ◀** or **▶** button until the last photo you want to print appears in the right box on the printer's LCD screen. Press the **OK** button to select this photo as the end of the range of photos you want to print.

The printer's LCD screen displays the selected range of photos.

- 8 If you like, you can change the number of copies to print of the selected range of photos by pressing the **COPIES +** or **-** button. Press the **OK** button when the desired number of copies appears on the printer's LCD screen.
- 9 Press the **PRINT** button to begin printing.

print all photos

You can choose to print all the photos on a memory card.

- 1 Insert a memory card into the printer's memory card slot. For more information, see **insert a memory card** on page 14.
- 2 If you have not changed the default photo layout in the printer preferences, you will be asked to select a layout for your photos. Press the **SELECT PHOTOS** ▲ or ▼ button to highlight the photo layout you want to print, then press the **OK** button. For information about changing the default photo layout, see **default photo layout** on page 36.

The first photo on the memory card appears on the printer's LCD screen.

- 3 Press the **MENU** button on the printer's control panel.
- 4 Press the **SELECT PHOTOS** ▼ button until **Print special** is highlighted on the printer's LCD screen. Press the **OK** button.
- 5 Press the **SELECT PHOTOS** ▼ button until **Print all** is highlighted on the printer's LCD screen. Press the **OK** button.

The first and last photos stored on the memory card appear on the printer's LCD screen.

- 6 If you like, you can change the number of copies to print of all photos by pressing the **COPIES +** or **-** button. Press the **OK** button when the desired number of copies appears on the printer's LCD screen.
- 7 Press the **PRINT** button to begin printing all the photos on the memory card, or press the **CANCEL** button to cancel the operation.

print new photos

You can choose to print all the "new" photos on a memory card at once. "New" photos are photos that haven't previously been printed from the printer's control panel.

Each time you insert a memory card into the printer's memory card slot and print photos using the printer's control panel, the printer tags the photos that you print. The next time you insert the same memory card, the printer will remember which photos have already been printed. When you choose to print new photos, the printer selects all photos on the memory card that have not yet been printed from the printer's control panel.

Note: If you print or modify your photos using a computer, the tags placed by the printer might be removed, causing previously printed photos to be selected as new photos.

To print the new photos on a memory card:

- 1 Insert a memory card into the printer's memory card slot. For more information, see **insert a memory card** on page 14.
- 2 If you have not changed the default photo layout in the printer preferences, you will be asked to select a layout for your photos. Press the **SELECT PHOTOS** ▲ or ▼ button to highlight the photo layout you want to print, then press the **OK** button. For information about changing the default photo layout, see **default photo layout** on page 36.

The first photo on the memory card appears on the printer's LCD screen.

- 3 Press the **MENU** button on the printer's control panel.
- 4 Press the **SELECT PHOTOS** ▼ button until **Print special** is highlighted on the printer's LCD screen. Press the **OK** button.
- 5 Press the **SELECT PHOTOS** ▼ button until **Print new** is highlighted on the printer's LCD screen. Press the **OK** button.

The printer's LCD screen displays the number of new photos found on the memory card and asks if you want to continue.

- 6 If you like, you can change the number of copies to print of the new photos by pressing the **COPIES +** or **-** button. Press the **OK** button when the desired number of copies appears on the printer's LCD screen.
- 7 Press the **PRINT** button to begin printing the new photos, or press the **CANCEL** button to cancel the operation.

print video clips

Your printer can display and print frames from video clips recorded on a memory card. Your printer recognizes the following video file formats: Motion JPEG AVI, Motion JPEG Quicktime, and MPEG-1. Video clips recorded in other formats will be ignored.

Note: Not all digital cameras allow you to record video clips.

When you insert a memory card containing a video clip into one of the printer's memory card slots, the printer uses the first frame of the video clip to represent the clip on the printer's LCD screen and in the photo index. A small video camera icon in the corner of the image indicates that the image is the first frame of a video clip rather than a photo.



You can select video clips for printing the same way that you select photos. For more information, see **select photos to print** on page 19. When you print a selected video clip, you get a video action print—nine frames from throughout the video clip printed on one page. You can change the default number of frames on your video action prints to 16 or 25. For more information, see **default layout for video action prints** on page 37.

Note: When you select a combination of photos and video clips for printing, the video action prints will print after the photos.

print camera-selected photos

Camera-selected photos are photos you marked for printing using your digital camera. When you select photos using your camera, the camera creates a Digital Print Order Format (DPOF) file that identifies which photos have been selected for printing.

Your printer can read the DPOF file from the memory card so you do not have to reselect the photos to print. Review the documentation that came with your digital camera to see if it supports camera-selected photos. Your printer supports DPOF file format 1.1.

Note: Not all digital cameras allow you to mark your photos for printing.

When you print camera-selected photos, the printer's control panel settings do not apply; the settings in the DPOF file for photo layout and number of copies override the printer's control panel.

To print camera-selected photos from a memory card:

- 1 Use your digital camera to select the photos you want to print. For more information, see the documentation that came with your camera.
- 2 Remove the memory card from your digital camera and insert it into the printer's memory card slot. For more information, see **insert a memory card** on page 14.

The printer automatically recognizes the camera-selected photos on the memory card and displays the message PRINT THE CAMERA SELECTED PHOTOS (DPOF)?

- 3 To print all camera-selected photos, press the **SELECT PHOTOS** ▾ button to highlight **Yes**, then press the **OK** button. To ignore the selections made with the camera, press the **SELECT PHOTOS** ▾ button to highlight **No**, then press the **OK** button.

Note: If the printer cannot find all of the camera-selected photos on the memory card, it may be because some of the photos have been deleted using a computer. The printer will print the camera-selected photos it finds.

- 4 After printing the camera-selected photos, the printer's default setting is to ask whether you want to unmark the camera-selected photos.
 - To unmark the photos and delete the DPOF file, press the **SELECT PHOTOS** ▾ button to highlight **Yes**, then press the **OK** button.
 - To keep your selections so you can print the same set of camera-selected photos again, press the **SELECT PHOTOS** ▾ button to highlight **No**, then press the **OK** button.

For more information, see **unmark camera-selected photos after printing** on page 40.

Note: Unmarking photos does not delete the photos from the memory card.

If you have an HP direct-printing digital camera, you can also print camera-selected photos by connecting the camera directly to the printer. For more information, see **print from an hp direct-printing digital camera** on page 27.

3

print from an hp direct-printing digital camera

Your printer allows you to print beautiful photos from an HP direct-printing digital camera without using your computer.

To see a list of the HP direct-printing digital cameras that work with your printer, go to www.hp.com/support, select your country or region, then type **direct-printing digital cameras** in the search window.

Note: If your direct-printing digital camera has a docking station, you can connect the docking station to the printer's USB port. For more information, see the documentation that came with the docking station.

connect your hp direct-printing digital camera to the printer

- 1 Use the Share menu on your HP direct-printing digital camera to select the photos you want to print. For more information, see the documentation that came with your camera.
- 2 Connect the digital camera to your printer's USB port using the USB cable that came with the camera.

Note: If the printer is connected to a computer, disconnect the computer's USB cable before connecting the digital camera's USB cable.

- 3 When you connect the digital camera to the printer, a Print Setup menu appears on the camera's LCD screen. Use this menu to:
 - Change the photos you have selected for printing
 - Select the paper type
- 4 When you are ready to print, follow the instructions on your digital camera's LCD screen.

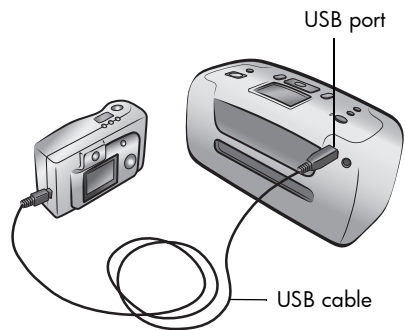

Note: For more information about using camera-selected photos, see the documentation that came with your digital camera.

You can also print photos you marked for printing using your digital camera by inserting the memory card into the printer. For more information, see **print camera-selected photos** on page 26.

4

get creative

The control panel on your printer is designed to make photo projects fun and easy. You can print more than one photo on each sheet of paper and print a different number of copies of each photo. You can crop your photos, adjust the brightness of your photos, add decorative frames and special color effects to your photos, change the print quality, and view photo slide shows right from the printer. The affordable projects are endless—just use your imagination!

For information about how to:

- Change the photo layout, see page 29
- Change the number of copies, see page 30
- Crop a photo, see page 31
- Adjust the photo brightness, see page 32
- Add frames to your photos, see page 32
- Change the photo color effect, see page 33
- Change the print quality, see page 34
- View a slide show, see page 34

All of the print settings described in this chapter, except for the photo layout and print quality, are applied to individual photos and are discarded when you deselect the photo.

You can also enhance your photos by setting the printer preferences. Printer preferences are global settings—they apply to all photos that you print. You can print borderless photos or photos with white borders, automatically improve contrast and color saturation in your photos, or adjust your photos using Exif Print information. For more information, see **set printer preferences** on page 35.

change the photo layout

When you first insert a memory card into the printer's memory card slot, a message appears on the printer's LCD screen asking you to select the photo layout. However, you can change the photo layout at any time using the **MENU** button on the printer's control panel.

- 1 Press the **MENU** button on the printer's control panel.
- 2 Press the **SELECT PHOTOS** ▾ button until **Change layout** is highlighted on the printer's LCD screen. Press the **OK** button.

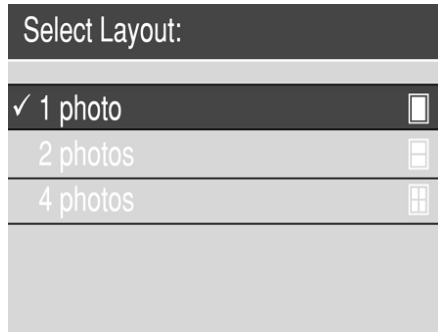

- 3 Press the **SELECT PHOTOS** ▾ button until the photo layout you want—one, two, or four photos per page—is highlighted on the printer's LCD screen. Press the **OK** button.

The photo layout is a global setting—it applies to all photos you print from the memory card. When you view a selected photo on the printer's LCD screen, the current photo layout is indicated by an icon in the bottom right corner of the LCD screen.

Note: The changed photo layout will apply to all photos you print until you choose a different photo layout from the printer menu or until you remove the memory card from the printer. When the memory card is removed, the photo layout returns to the printer's default photo layout. For information about setting the default photo layout, see **default photo layout** on page 36.

change the number of copies

When you print from a memory card, you can change the number of copies to print of a selected photo to a number other than the default. For information about changing the default number of copies, see **default number of copies** on page 36.

- 1 Press the **SELECT PHOTOS** ◀ or ▶ button to navigate to the photo for which you want to change the number of copies. When the photo you want appears on the printer's LCD screen, press the **OK** button to select it.
- 2 Press the **COPIES +** or **-** button to change the number of copies to print of the selected photo. When the correct number of copies is displayed on the printer's LCD screen, press the **OK** button. The changed number of copies applies to the displayed photo only.

Note: You can set the number of copies to a different number for each selected photo.

- 3 Press the **PRINT** button to begin printing.

Note: The changed number of copies setting will be discarded and the number of copies to print will return to the default value when the photo is deselected.

crop a photo

When you print from a memory card, you can use the printer's control panel to crop a photo so only your favorite portion of the photo prints.

- 1 Press the **SELECT PHOTOS** ◀ or ▶ button to navigate to the photo you want to crop. When the photo you want to crop appears on the printer's LCD screen, press the **OK** button to select it.
- 2 Press the **ZOOM +** button on the printer's control panel.

Four arrows on the printer's LCD screen blink briefly to indicate that you are entering Zoom mode. The print settings at the bottom of the display are replaced by the Zoom icon and magnification level.



Note: Make sure to press the **ZOOM +** button first. If you press the **ZOOM -** button first, the printer will exit Zoom mode and go to 9-up view mode. (In 9-up view mode, nine photos appear on the printer's LCD screen at a time.) To return to Zoom mode for the selected photo, press the **ZOOM +** button twice.

- 3 Press the **ZOOM +** button to increase the magnification level by 0.25x. The maximum magnification level is 5.0x. Press the **ZOOM -** button to decrease the magnification level by 0.25x. The minimum magnification level is 1.0x.

Note: The crop box changes from green to yellow if printing at the selected magnification will noticeably reduce the print quality.

Note: If you increase the magnification beyond 3.0x, the photo will no longer be magnified on the printer's LCD screen. Instead, the crop box will shrink to indicate that a smaller portion of the photo is being selected.

- 4 At any magnification level, use the arrows on the **SELECT PHOTOS** button to move the crop box left, right, up, or down.
- 5 Press the **OK** button when the portion of the image you want to print is inside the crop box.
- 6 Press the **PRINT** button to begin printing.

Note: The zoom and crop settings are discarded when the photo is deselected.

adjust the photo brightness

When you print from a memory card, you can adjust the photo brightness to print your photos lighter or darker than the originals. The brightness setting ranges from -3 to +3. Normal brightness is 0.

- 1 Press the **SELECT PHOTOS** ◀ or ▶ button to navigate to the photo for which you want to adjust the photo brightness. When the photo you want appears on the printer's LCD screen, press the **OK** button to select it.
- 2 Press the **MENU** button on the printer's control panel.
- 3 Press the **SELECT PHOTOS** ▼ button until **Enhance image** is highlighted on the printer's LCD screen. Press the **OK** button.
- 4 Press the **SELECT PHOTOS** ▼ button until **Photo brightness** is highlighted on the printer's LCD screen. Press the **OK** button.
- 5 Use the arrows on the **SELECT PHOTOS** button to adjust the photo brightness:
 - Press the **SELECT PHOTOS** ▶ or ▲ button to increase the brightness.
 - Press the **SELECT PHOTOS** ◀ or ▼ button to decrease the brightness.
- 6 Press the **OK** button when you are satisfied with the brightness.
- 7 Press the **PRINT** button to begin printing.

Note: The brightness setting returns to the default value of 0 when the photo is deselected.

add frames to your photos

When you print from a memory card, you can select decorative borders in various patterns and colors and add them to print as frames around your photos.

- 1 Press the **SELECT PHOTOS** ◀ or ▶ button to navigate to the photo to which you want to add a frame. When the photo you want appears on the printer's LCD screen, press the **OK** button to select it.
- 2 Press the **MENU** button on the printer's control panel.
- 3 Press the **SELECT PHOTOS** ▼ button until **Enhance image** is highlighted on the printer's LCD screen. Press the **OK** button.
- 4 Press the **SELECT PHOTOS** ▼ button until **Add frame** is highlighted on the printer's LCD screen. Press the **OK** button.
- 5 Use the arrows on the **SELECT PHOTOS** button to highlight the frame pattern you want to use, then press the **OK** button to select it.

- 6 Use the arrows on the **SELECT PHOTOS** button to highlight the frame color you want to use, then press the **OK** button to select it.

The printer displays the frame around the selected photo. If you cropped the photo before adding a frame, the frame automatically shrinks to fit around the cropped photo.

- 7 Press the **PRINT** button to begin printing.

Note: The frame settings are discarded when the photo is deselected.

change the photo color effect

When you print from a memory card, you can set the printer to change the color effect of your prints to black and white, sepia, or antique. Photos printed in sepia print in brown tones and look similar to photos produced in the early 1900s. Photos printed in antique print in the same brown tones as sepia but with some pale colors added to give the appearance that they are hand colored.

Note: These effects work best on photos taken in color using your digital camera.

- 1 Press the **SELECT PHOTOS** ◀ or ▶ button to navigate to the photo for which you want to change the photo color effect. When the photo you want appears on the printer's LCD screen, press the **OK** button to select it.
- 2 Press the **MENU** button on the printer's control panel.
- 3 Press the **SELECT PHOTOS** ▼ button until **Enhance image** is highlighted on the printer's LCD screen. Press the **OK** button.
- 4 Press the **SELECT PHOTOS** ▼ button until **Add color effect** is highlighted on the printer's LCD screen. Press the **OK** button.
- 5 Press the **SELECT PHOTOS** ▼ button until the photo color effect you want to use is highlighted on the printer's LCD screen, then press the **OK** button to select it. You may choose from the following color effects:
 - Black & white
 - Sepia
 - Antique
 - No effect (default)

The printer displays the photo with the selected photo color effect applied.

- 6 Press the **PRINT** button to begin printing.

Note: The photo color effect returns to the default setting (No effect) when the photo is deselected.

change the print quality

When you print from a memory card, you can set the print quality for your photos. Best quality is the default print quality and produces the highest quality photos. Normal quality conserves ink and prints faster.

Note: If you select normal quality, it will be used only once, the next time you print.

- 1 Press the **MENU** button on the printer's control panel.
- 2 Press the **SELECT PHOTOS** ▾ button until **Tools** is highlighted on the printer's LCD screen. Press the **OK** button.
- 3 Press the **SELECT PHOTOS** ▾ button until **Print quality** is highlighted on the printer's LCD screen. Press the **OK** button.
- 4 Select from the following:
 - **Best** to print the highest quality photos.
 - **Normal** to print normal quality photos.
- 5 With your selection highlighted on the printer's LCD screen, press the **OK** button.

If you selected **Normal**, the printer's LCD screen briefly displays a message to remind you that the normal quality setting will be used only once. Print quality reverts to best quality after the selected photos are printed.

view a slide show

You can view all the photos stored on your memory card in sequence like a slide show. Viewing a slide show on your printer's LCD screen does not affect any photo selections or print settings you have made.

- 1 Press the **MENU** button on the printer's control panel.
- 2 Press the **SELECT PHOTOS** ▾ button until **Tools** is highlighted on the printer's LCD screen. Press the **OK** button.
- 3 Press the **SELECT PHOTOS** ▾ button until **Slide show** is highlighted on the printer's LCD screen. Press the **OK** button.

The printer shows the photos in sequence at approximately five-second intervals. Some photos may take longer to appear.

To pause or cancel a slide show:

- Press the **OK** button to pause a slide show. Press the **OK** button again to resume the slide show.
- Press the **CANCEL** button to end the slide show.

5

set printer preferences

You can change the printer's factory default settings to your own personal preferences using the printer menu on the printer's control panel. Printer preferences are global settings—they apply to every photo you print from the printer's control panel.

You can set the following printer preferences:

- Deselect all photos after printing. See page 35.
- Default number of copies. See page 36.
- Default photo layout. See page 36.
- Default layout for video action prints. See page 37.
- Date and time stamp. See page 37.
- Borderless printing. See page 38.
- Exif printing. See page 39.
- Improve contrast. See page 39.
- Extend colors. See page 40.
- Unmark camera-selected photos after printing. See page 40.
- Revert to the factory default settings. See page 41.
- LCD screen language and country/region. See page 42.

Note: When you print from your computer, the control panel settings on the printer do not apply. The software on your computer overrides the printer preferences you set using the printer's control panel.

deselect all photos after printing

You can choose whether to deselect all photos after printing or keep your photo selections for further printing. When you choose to deselect all photos after printing, the printer discards any existing photo selections and any print settings you applied before printing, such as color effects or number of copies. Default print settings are not discarded.

Note: Deselecting photos does not delete them from the memory card.

The printer's factory default setting is to **Ask** whether you want to deselect all photos after printing. You can change the default setting by following these steps:

- 1 Press the **MENU** button on the printer's control panel.
- 2 Press the **SELECT PHOTOS** ▾ button until **Preferences** is highlighted on the printer's LCD screen. Press the **OK** button.
- 3 Press the **SELECT PHOTOS** ▾ button until **After printing** is highlighted on the printer's LCD screen. Press the **OK** button.

- 4 Select from the following options:
 - **Always** if you want the printer to discard the existing photo selections and print settings after printing.
 - **Never** if you want the printer to keep the existing photo selections and print settings for further printing.
 - **Ask** if you want the printer to ask each time it prints whether you want to keep the existing photo selections and print settings for further printing.
- 5 With your selection highlighted on the printer's LCD screen, press the **OK** button.

default number of copies

You can set the printer to print up to 99 copies of each photo. The printer's factory default setting is one copy. You can change the default setting by following these steps:

- 1 Press the **MENU** button on the printer's control panel.
- 2 Press the **SELECT PHOTOS** ▾ button until **Preferences** is highlighted on the printer's LCD screen. Press the **OK** button.
- 3 Press the **SELECT PHOTOS** ▾ button until **# of copies** is highlighted on the printer's LCD screen. Press the **OK** button.
- 4 Press the **SELECT PHOTOS** ▲ button to increase the default number of copies, or press the **SELECT PHOTOS** ▾ button to decrease the default number of copies. Press the **OK** button.

Note: This default setting applies every time you print. To override the default setting and print a different number of copies of a photo, display the photo on the printer's LCD screen and press the **COPIES** button. The changed number of copies applies to the displayed photo only.

default photo layout

You can set the printer to print one, two, or four photos per page, or to ask you to select the photo layout each time you insert a memory card into the printer's memory card slot. The printer's factory default setting is to **Ask** you to select the photo layout each time you insert a memory card. You can change the default setting by following these steps:

Note: If you change the default photo layout to either one, two, or four photos per page, you will not see the Select Layout screen when you insert a memory card into the printer's memory card slot.

- 1 Press the **MENU** button on the printer's control panel.
- 2 Press the **SELECT PHOTOS** ▾ button until **Preferences** is highlighted on the printer's LCD screen. Press the **OK** button.
- 3 Press the **SELECT PHOTOS** ▾ button until **Photo layout** is highlighted on the printer's LCD screen. Press the **OK** button.

- 4 Select from the following options:
 - **Ask** if you want the printer to ask you to select a photo layout each time you insert a memory card into the printer's memory card slot.
 - **1 photo** if you want the printer to print one photo per page.
 - **2 photos** if you want the printer to print two photos per page.
 - **4 photos** if you want the printer to print four photos per page.
- 5 With your selection highlighted on the printer's LCD screen, press the **OK** button.

The photo layout is a global setting—it applies to all the photos you print from the printer's control panel. When you insert a memory card into the printer's memory card slot, the printer sets the photo layout to the default setting.

Note: You can choose a different photo layout for the photos on a memory card at any time by pressing the **MENU** button. With **Change layout** highlighted on the printer's LCD screen, press the **OK** button. Press the **SELECT PHOTOS ▾** button until the desired photo layout is highlighted, then press the **OK** button. The changed photo layout will apply to all photos you print until you remove the memory card from the printer or choose a different photo layout from the printer menu. For more information, see **change the photo layout** on page 29.

default layout for video action prints

You can set the printer to print 9, 16, or 25 frames from a selected video clip as a one-page video action print. The printer's factory default setting for video action prints is 9 frames. You can change the default setting by following these steps:

- 1 Press the **MENU** button on the printer's control panel.
- 2 Press the **SELECT PHOTOS ▾** button until **Preferences** is highlighted on the printer's LCD screen. Press the **OK** button.
- 3 Press the **SELECT PHOTOS ▾** button until **Video print** is highlighted on the printer's LCD screen. Press the **OK** button.
- 4 Press the **SELECT PHOTOS ▾** button until the number of frames you want to include in each video action print is highlighted on the printer's LCD screen. Press the **OK** button.

date and time stamp

You can set the printer to print a stamp on the front of your photos that shows when the photo was taken. You can choose to print the date and time or just the date. The printer's factory default setting for the date and time stamp is **Off**. You can change the default setting by following these steps:

Note: If you use your computer to modify the photo and then save your changes, the original date and time information will be lost. Changes that you make to the photo using the printer's control panel do not affect the date and time information.

- 1 Press the **MENU** button on the printer's control panel.
- 2 Press the **SELECT PHOTOS** ▾ button until **Preferences** is highlighted on the printer's LCD screen. Press the **OK** button.
- 3 Press the **SELECT PHOTOS** ▾ button until **Add date/time** is highlighted on the printer's LCD screen. Press the **OK** button.
- 4 Select from the following:
 - **Date/time** if you want the date and time to print on the front of your photos.
 - **Date only** if you want the date to print on the front of your photos.
 - **Off** if you do not want the date or time to print on the front of your photos.
- 5 With your selection highlighted on the printer's LCD screen, press the **OK** button.

Note: The date and time stamp will print on every photo until you turn off the option.

The date format in the date and time stamp is controlled by the country/region setting. For more information, see **LCD screen language and country/region** on page 42.

borderless printing

You can set the printer to print your photos with or without white borders. When you select borderless printing, photos print all the way to the edges of the paper on three sides, and the fourth side prints with a 0.5 inch (12.5 mm) white border that you can trim off. For truly borderless photos, use photo paper with a 0.5 inch (12.5 mm) tear-off tab, such as HP premium plus photo paper.

The printer's factory default setting for borderless printing is **On**. You can change the default setting by following these steps:

- 1 Press the **MENU** button on the printer's control panel.
- 2 Press the **SELECT PHOTOS** ▾ button until **Preferences** is highlighted on the printer's LCD screen. Press the **OK** button.
- 3 Press the **SELECT PHOTOS** ▾ button until **Borderless** is highlighted on the printer's LCD screen. Press the **OK** button.
- 4 Select from the following:
 - **On** if you want to print borderless photos.
 - **Off** if you want to print photos with a white border on all four sides.
- 5 With your selection highlighted on the printer's LCD screen, press the **OK** button.

Note: HP does not recommend printing borderless photos on plain paper. For more information about recommended paper types, see **recommended paper** on page 53.

Exif printing

Your printer supports Exif Print (Exchangeable Image File Format 2.2), an international open standard that simplifies digital imaging and enhances printed photos. When you take a photo with a digital camera that supports Exif Print, information such as exposure time, flash setting, and color saturation is added to the image file.

You can set the printer to use the Exif Print information it finds in an image file to automatically adjust and enhance the printed photo. The printer's factory default setting for Exif printing is **On**. You can change the default setting by following these steps:

- 1 Press the **MENU** button on the printer's control panel.
- 2 Press the **SELECT PHOTOS** ▾ button until **Preferences** is highlighted on the printer's LCD screen. Press the **OK** button.
- 3 Press the **SELECT PHOTOS** ▾ button until **Exif printing** is highlighted on the printer's LCD screen. Press the **OK** button.
- 4 Select from the following:
 - **On** if you want the printer to use Exif Print information to enhance your prints.
 - **Off** if you want the printer to ignore Exif Print information.
- 5 With your selection highlighted on the printer's LCD screen, press the **OK** button.

improve contrast

You can set the printer to improve the quality of underexposed photos by enhancing the contrast in the shadows and highlights. The printer's factory default setting for automatically improving contrast is **On**. You can change the default setting by following these steps:

- 1 Press the **MENU** button on the printer's control panel.
- 2 Press the **SELECT PHOTOS** ▾ button until **Preferences** is highlighted on the printer's LCD screen. Press the **OK** button.
- 3 Press the **SELECT PHOTOS** ▾ button until **Improve contrast** is highlighted on the printer's LCD screen. Press the **OK** button.
- 4 Select from the following:
 - **On** if you want the printer to automatically improve the contrast when it prints your photos.
 - **Off** if you do not want the printer to adjust the contrast when it prints your photos.
- 5 With your selection highlighted on the printer's LCD screen, press the **OK** button.

extend colors

You can set the printer to automatically deepen and intensify the colors in the photos you print. Extending colors is a good way to improve color photos that look washed out or faded, but it will increase printing time and may not have a noticeable effect on all photos.

The printer's factory default setting for automatically extending colors is **Off**. You can change the default setting by following these steps:

- 1 Press the **MENU** button on the printer's control panel.
- 2 Press the **SELECT PHOTOS** ▾ button until **Preferences** is highlighted on the printer's LCD screen. Press the **OK** button.
- 3 Press the **SELECT PHOTOS** ▾ button until **Extend colors** is highlighted on the printer's LCD screen. Press the **OK** button.
- 4 Select from the following:
 - **On** if you want the printer to automatically increase the intensity of the colors (color saturation) when it prints your photos.
 - **Off** if you do not want the printer to adjust the color saturation when it prints your photos.
- 5 With your selection highlighted on the printer's LCD screen, press the **OK** button.

unmark camera-selected photos after printing

Camera-selected photos are photos you selected for printing using your digital camera. When you select photos using your camera, the camera creates a Digital Print Order Format (DPOF) file that identifies which photos have been selected. For information about printing camera-selected photos, see **print camera-selected photos** on page 26.

After printing camera-selected photos, you can choose to unmark (deselect) them or to keep them marked so you can print the same set of photos again. Unmarking the photos deletes the DPOF file from the memory card.

Note: Unmarking photos does not delete the photos from the memory card.

The printer's factory default setting is to **Ask** if you want to unmark camera-selected photos after they have been printed. You can change the default setting by following these steps:

- 1 Press the **MENU** button on the printer's control panel.
- 2 Press the **SELECT PHOTOS** ▾ button until **Preferences** is highlighted on the printer's LCD screen. Press the **OK** button.
- 3 Press the **SELECT PHOTOS** ▾ button until **Camera selections** is highlighted on the printer's LCD screen. Press the **OK** button.

- 4 Select from the following options:
 - **Always** if you want the printer to unmark the camera-selected photos after printing.
 - **Never** if you want the printer to leave the camera-selected photos marked after printing.
 - **Ask** if you want the printer to ask if you want to unmark the camera-selected photos after printing.
- 5 With your selection highlighted on the printer's LCD screen, press the **OK** button.

revert to the factory default settings

If you made changes to the printer preferences, you can reset the printer to the original factory default settings at any time by following these steps:

- 1 Press the **MENU** button on the printer's control panel.
- 2 Press the **SELECT PHOTOS** ▼ button until **Preferences** is highlighted on the printer's LCD screen. Press the **OK** button.
- 3 Press the **SELECT PHOTOS** ▼ button until **Restore defaults** is highlighted on the printer's LCD screen. Press the **OK** button.
- 4 Select from the following:
 - **Yes** to revert to the original factory default settings for all printer preferences.
 - **No** to keep the current printer preferences.

Note: The printer's LCD screen language and country/region settings will not change if you revert to the factory default settings.

Preference	Factory default setting
After printing	Ask (whether photos should be deselected)
# of copies	1
Photo layout	Ask (user to select photo layout)
Video print	9 per page
Add date/time	Off
Borderless	On
Exif printing	On
Improve contrast	On
Extend colors	Off
Camera selections	Ask (whether to unmark camera-selected photos after printing)
Restore defaults	no default setting
Language	no default setting

LCD screen language and country/region

If you purchased your printer in a country other than the U.S. or Canada, you are asked to set the language and country/region for the printer's LCD screen the first time you turn on the printer. There is no factory default setting. You can change the printer's language and country/region settings at any time by following these steps:

- 1 Press the **MENU** button on the printer's control panel.
- 2 Press the **SELECT PHOTOS** ▾ button until **Preferences** is highlighted on the printer's LCD screen. Press the **OK** button.
- 3 Press the **SELECT PHOTOS** ▾ button until **Language** is highlighted on the printer's LCD screen. Press the **OK** button.

A list of languages appears.

- 4 Press the **SELECT PHOTOS** ▾ button until your desired language is highlighted on the printer's LCD screen. Press the **OK** button.

A message asking you to confirm your language selection appears.

- 5 To confirm your language selection, press the **SELECT PHOTOS** ▾ button until **Yes** is highlighted on the printer's LCD screen. Press the **OK** button.

A list of countries and regions appears.

- 6 Press the **SELECT PHOTOS** ▾ button until your desired country or region is highlighted on the printer's LCD screen. Press the **OK** button.

The prompts and options on your printer's LCD screen now appear in the language you selected.

The country/region setting controls the date format in the date and time stamp. If the country/region is set to **U.S.A./Canada** or **Japan**, the date format is **mm/dd/yy**. For any other country/region, the date format is **dd/mm/yy**. For information about printing dates on your photos, see **date and time stamp** on page 37.

Note: The language and country/region settings will not change if you revert to the factory default settings. You can change the language and country/region settings only by following the steps in this section.

6

maintain and transport your printer

Your printer requires very little maintenance. For best results, keep your printer and supplies clean and store them properly.

Because it is compact and light, your printer is easy to transport and set up almost anywhere. Take it with you on vacations and to family gatherings and social events to instantly print and share photos with family and friends.

clean and maintain your printer

You can extend the life span of your printer and print cartridges by keeping them clean and properly maintained.

clean the printer

To clean the outside of the printer:

- 1 Turn off the printer, disconnect the power cord from the back of the printer, and close the paper tray door.
- 2 Wipe the outside of the printer with a soft cloth that has been lightly moistened with water.

Caution! Do not use any type of cleaning solution, as solutions may damage the printer's finish. Do not clean the inside of the printer. Be careful to keep all fluids away from the inside of the printer.

clean the print cartridge

If you notice white lines or single-color streaks on your photos, the print cartridge may need to be cleaned.

- 1 Press the **MENU** button on the printer's control panel.
- 2 Load paper in the paper tray. To conserve photo paper, use plain paper or index cards. For more information, see **load the paper** on page 8.
- 3 Press the **SELECT PHOTOS** ▾ button until **Tools** is highlighted on the printer's LCD screen. Press the **OK** button.
- 4 Press the **SELECT PHOTOS** ▾ button until **Clean cartridge** is highlighted on the printer's LCD screen. Press the **OK** button.
- 5 When the message LOAD PLAIN PAPER THEN PRESS OK. appears on the printer's LCD screen, press the **OK** button.

The message CLEANING PRINT CARTRIDGE... appears on the printer's LCD screen and the On/Attention light blinks while the printer cleans the print cartridge. When the printer finishes cleaning the print cartridge, it prints a test page. For more information about test pages, see **print a test page** on page 44.

- 6 When the printer's LCD screen displays a message asking if you want to continue to a second level of cleaning, select from the following options:
 - If the test page has white streaks or missing colors, the print cartridge needs to be cleaned again. Press the **SELECT PHOTOS** ▾ button to highlight **Yes** on the printer's LCD screen, then press the **OK** button.
 - If the print quality of the test page looks good, press the **SELECT PHOTOS** ▾ button to highlight **No**, then press the **OK** button.

You can clean the cartridge up to three times. Each successive cleaning is more thorough and uses more ink.

print a test page

You can print a test page to check the condition of the print cartridge and to obtain diagnostic information that is useful to HP support.

- 1 Press the **MENU** button on the printer's control panel.
- 2 Load paper in the paper tray. To conserve photo paper, use plain paper or index cards. For more information, see **load the paper** on page 8.
- 3 Press the **SELECT PHOTOS** ▾ button until **Tools** is highlighted on the printer's LCD screen. Press the **OK** button.
- 4 Press the **SELECT PHOTOS** ▾ button until **Print test page** is highlighted on the printer's LCD screen. Press the **OK** button.

The message PRINTING TEST PAGE... appears on the printer's LCD screen and the On/Attention light blinks while the test page prints.

Image print quality

If this looks good, your photos should print well.

Diagnostic information

Use this when working with HP support.

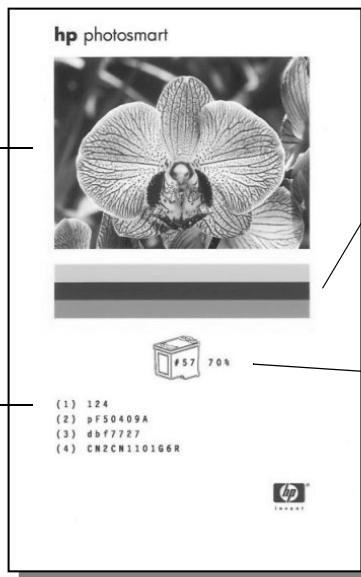

Ink nozzle quality

If there are white streaks in these solid bars, try cleaning the print cartridge. For more information, see **clean the print cartridge** on page 43.

Estimated ink level

Use this to determine when you should buy a new print cartridge.

calibrate the print cartridge

You can calibrate the print cartridge by using your printer's control panel. Try calibrating the print cartridge if colors in your photos are misaligned or if the calibration page did not print correctly when you installed a new print cartridge.

Note: The first time you install a print cartridge in your printer, the printer automatically calibrates the print cartridge. For more information see **install or replace the print cartridge** on page 10.

- 1 Press the **MENU** button on the printer's control panel.
- 2 Load paper in the paper tray. To conserve photo paper, use plain paper or index cards. For more information, see **load the paper** on page 8.
- 3 Press the **SELECT PHOTOS** ▾ button until **Tools** is highlighted on the printer's LCD screen. Press the **OK** button.
- 4 Press the **SELECT PHOTOS** ▾ button until **Calibrate printer** is highlighted on the printer's LCD screen. Press the **OK** button.
- 5 When the message **PRINTER CALIBRATION. LOAD PLAIN PAPER THEN PRESS OK.** appears on the printer's LCD screen, press the **OK** button.

The message **PRINTING CALIBRATION PAGE...** appears on the printer's LCD screen and the On/Attention light blinks while the printer calibrates the print cartridge. When the printer finishes calibrating the print cartridge, it prints a calibration page to confirm that the calibration was successful.

Calibration page

- The check marks verify that the print cartridge is installed correctly and functioning properly.
- If an "x" appears to the left of any of the bars, calibrate the print cartridge again. If the "x" still appears, replace the print cartridge.



store your printer

Protect the printer and print cartridge by storing them properly when you are not using them.

Note: For information about storing and handling photo paper, see **maintain the quality of your photo paper** on page 9.

store the printer

Your printer is built to withstand long or short periods of inactivity. Close the paper tray door when the printer is not in use. Store the printer indoors out of direct sunlight in a place without temperature extremes.

store the print cartridge

Always transport and store the active print cartridge inside the printer. The printer stores the print cartridge in a protective cap.

Make sure the printer completes its power-down cycle before you unplug the power cord. This allows the printer to store the print cartridge properly.

If the printer and print cartridge have been unused for one month or more, clean the print cartridge before using it. For more information, see **clean the print cartridge** on page 43.

transport your printer

Your printer can travel with you. Be sure to always carry the printer upright.

To transport your printer:

- 1 Turn off the printer.
- 2 Remove all paper from the paper tray.
- 3 Remove any memory cards from the memory card slots.
- 4 Close the paper tray door.
Note: Make sure the printer completes its power-down cycle before you unplug the power cord. This allows the printer to store the print cartridge properly.
- 5 Unplug the power cord.
- 6 If your printer was connected to your computer, disconnect the USB cable from the computer.

Note: When transporting your printer, do not remove the print cartridge.

When transporting your printer, make sure to bring the following items with you:

- Paper
- Power cord
- Digital camera or a memory card containing photos
- Extra print cartridges (if you plan to print a lot of photos)

Note: If you are going to connect your printer to a computer, make sure to also bring the USB cable and HP Photosmart printer software CD.

7

troubleshooting

Your HP Photosmart printer is designed to be reliable and easy to use. This chapter answers frequently asked questions and contains information about the following topics:

- Hardware problems. See page 47.
- Printing problems. See page 48.
- Error messages. See page 51.

For troubleshooting information about software installation, see the reference guide that came with your printer. For advanced troubleshooting information, see the HP Photosmart Printer Help. For information about viewing the Printer Help, see **view the hp photosmart printer help** on page 2.

hardware problems

Before contacting HP support, read this section for troubleshooting tips or go to the online support services at **www.hp.com/support**.

Note: HP recommends using a USB cable of less than 10 feet (3 meters) in length to minimize injected noise due to potential high electromagnetic fields.

Problem	Possible cause	Solution
The On/Attention light is blinking green but the printer is not printing.	The printer is processing information.	Wait a moment for the printer to finish processing the information.
The On/Attention light is blinking red.	The printer requires attention.	Try the following: <ol style="list-style-type: none">1 Check the printer's LCD screen and the computer monitor for instructions.2 If this does not work and you have a digital camera connected to the printer, check the camera's LCD for instructions.3 If this does not work, turn off the printer. Unplug the printer's power cord, wait about 10 seconds, then plug it in again. Turn on the printer.

Problem	Possible cause	Solution
The On/Attention light is blinking amber.	An unrecoverable error has occurred.	Try the following: <ul style="list-style-type: none"> • Turn off the printer. Unplug the printer's power cord, wait about 10 seconds, then plug it in again. Turn on the printer. • If this does not work, go to www.hp.com/support or contact HP support. For contact information, see the reference guide that came with your printer.

printing problems

Before contacting HP support, read this section for troubleshooting tips or go to the online support services at **www.hp.com/support**.

Note: In the presence of high electromagnetic fields, printed documents and photos may be slightly distorted.

Problem	Possible cause	Solution
The printer does not generate borderless output when I print from the control panel.	The borderless printing option may be turned off.	Change the printer preferences to turn borderless printing on. For more information, see borderless printing on page 38.
Printing is very slow.	You may have the Extend colors menu option turned on.	Turn off the option by using the printer's MENU button. For more information, see extend colors on page 40.
Paper does not feed into the printer correctly. OR Paper does not come out of the printer correctly.	There may be too much paper loaded in the paper tray.	Remove some of the paper from the paper tray and try printing again. For paper-loading instructions, see load the paper on page 8.
	The paper width guide may be adjusted incorrectly.	Make sure that the paper width guide fits close to the edge of the paper without bending the paper. For paper-loading instructions, see load the paper on page 8.
	Two or more pieces of paper may be stuck together.	<ol style="list-style-type: none"> 1 Remove the paper from the paper tray and leaf through the stack so the sheets of paper do not stick together. 2 Reload the paper into the paper tray and try printing again. For paper-loading instructions, see load the paper on page 8.
	The paper may be too thin or too thick.	Try using recommended paper. For more information, see recommended paper on page 53.

Problem	Possible cause	Solution
Photo paper does not feed into the printer correctly.	Your printer may be in an extremely high or low humidity environment.	Try the following: <ul style="list-style-type: none"> • Insert the photo paper as far as it will go into the paper tray. • Load one sheet of photo paper at a time.
	The photo paper may be curled.	Place the paper in a resealable plastic bag and gently bend it in the opposite direction of the curl until the paper lies flat. If the problem persists, use different photo paper that is not curled.
The printer does not print the new photos on the memory card.	There are no new photos on the memory card, or the photos have already been printed from the printer's control panel.	Select and print the desired photos. For more information about selecting photos, see select photos to print on page 19. For more information about the Print new menu option, see print new photos on page 24.
I chose the Print new menu option to print the new photos on my memory card, and the printer printed more photos than I expected.	To the printer, a "new" photo is one that you have not printed from the printer's control panel. When you select Print new , the printer will print all photos that have not previously been printed from the control panel.	Select the exact photo or photos you want to print. For more information about selecting photos, see select a photo on page 19. For more information about the Print new menu option, see print new photos on page 24.
A blank page came out of the printer.	The print cartridge may be out of ink.	Print a test page to determine the ink level of the print cartridge, and replace the print cartridge if necessary. For more information about printing a test page, see print a test page on page 44.
	You may have begun printing and then cancelled the process.	If you cancelled the process before the file started printing, the printer may have already loaded paper in preparation for printing. The next time you print, the printer will eject the blank page before continuing with the new project.

Problem	Possible cause	Solution
No page came out of the printer.	The paper jammed while printing.	<p>To clear the paper jam, try the following:</p> <ol style="list-style-type: none"> 1 Turn off the printer. 2 Unplug the printer's power cord. 3 Gently remove the jammed paper from the printer. 4 Plug the printer back in and turn it on. 5 When you have cleared the paper jam, try printing again. <p>If you experience paper jams when printing on photo paper, try the following:</p> <ul style="list-style-type: none"> • Insert the photo paper as far as it will go into the paper tray. • Load one sheet of photo paper at a time.
The photo printed at an angle or is off center.	The paper may not be loaded correctly.	<p>Try the following:</p> <ul style="list-style-type: none"> • Make sure the paper is correctly oriented in the paper tray. • Make sure the paper width guide fits close to the edge of the paper. <p>For paper-loading instructions, see load the paper on page 8.</p>
	The print cartridge may not be properly calibrated.	Calibrate the print cartridge from the printer's control panel. For more information, see calibrate the print cartridge on page 45.
Print quality is poor.	The print cartridge may be running out of ink.	<p>Print a test page to determine the ink level of the print cartridge. For more information, see print a test page on page 44.</p> <p>If the print cartridge is low on ink, replace it. For information about replacing the ink cartridge, see print cartridge information on page 10.</p>
	You may have magnified the photo too much.	Press the ZOOM – button one or more times to reduce the magnification.
	You may not be using the best paper type.	Make sure you are using a paper type intended for the printer. Use HP-designed paper for best results. For more information, see recommended paper on page 53.
	You may be printing on the wrong side of the paper.	Make sure the paper is loaded with the glossy side up.
	You may need to clean the print cartridge.	Clean the print cartridge from the printer's control panel. For more information, see clean the print cartridge on page 43.

error messages

Before contacting HP support, read this section for troubleshooting tips or go to the online support services at www.hp.com/support.

Message	Possible cause	Solution
PAPER JAM. CLEAR JAM THEN PRESS OK.	The paper jammed while printing.	Clear the paper jam. For more information, see the troubleshooting instructions for clearing a paper jam on page 50.
AUTOMATIC PAPER SENSOR FAILED.	The automatic paper sensor is obstructed or damaged.	Try moving the printer out of direct sunlight, then press the OK button and try printing again. If this does not work, go to www.hp.com/support or contact HP support. For contact information, see the reference guide that came with your printer.
CARTRIDGE IS NOT COMPATIBLE. USE APPROPRIATE HP CARTRIDGE.	You have inserted a print cartridge that does not work with your printer.	Replace the print cartridge with one that is compatible with your printer. For more information, see print cartridge information on page 10.
CARTRIDGE SERVICE STATION IS STUCK.	There is an obstruction blocking the print cartridge service station.	<ol style="list-style-type: none"> 1 Open the print cartridge door. The print cartridge service station is located beneath the print cartridge cradle. 2 Move the print cartridge cradle to the left to access the print cartridge service station. 3 Clear any obstruction and press the OK button to continue.
PRINT CARTRIDGE CRADLE IS STUCK. CLEAR JAM THEN PRESS OK.	The print cartridge cradle is stuck.	Clear any obstruction in the path of the print cartridge cradle, then press the OK button to continue. The current page will eject and printing will continue on the next available sheet of paper.
MEMORY CARD IN BACKWARDS. THE BLACK SIDE SHOULD FACE UP.	Your SmartMedia memory card is inserted upside down.	Gently pull the memory card out and reinsert it properly. For more information, see insert a memory card on page 14.

8

specifications

This chapter lists recommended papers for your printer and provides selected printer specifications.

Note: For a complete list of printer specifications and system requirements, see the HP Photosmart Printer Help. For information about viewing the Printer Help, see **view the hp photosmart printer help** on page 2.

recommended paper

For a list of available HP-designed inkjet papers, or to purchase supplies, go to:

- www.hpshopping.com (U.S.)
- www.hp-go-supplies.com (Europe)
- www.hp.com/paper (Asia/Pacific)
- www.jpn.hp.com/supply/inkjet (Japan)

Note: You can also purchase HP-designed inkjet paper at most computer and office supply stores.

HP photo papers	Best for	Size
HP premium plus photo paper	<ul style="list-style-type: none"> • Borderless printing • High-value photos • Important photos • High-resolution images from scanners or digital cameras • Photo enlargements or reprints to frame or give as gifts 	4 x 6 inches with 0.5 inch tab (10 x 15 cm with 1.25 cm tab)
HP premium photo paper	<ul style="list-style-type: none"> • Borderless printing • Making and sharing photos with friends and family • Medium- to high-resolution images from scanners and digital cameras • Medium-value photos from parties, team events, or celebrations 	4 x 6 inches with 0.5 inch tab (10 x 15 cm with 1.25 cm tab)
HP photo paper	<ul style="list-style-type: none"> • Borderless printing • Casual photos or high-volume photos • School or business reports, photo projects • Business applications: real estate proposals, sales and marketing materials 	4 x 6 inches with 0.5 inch tab (10 x 15 cm with 1.25 cm tab)

printer specifications

Connectivity	USB: Microsoft® Windows 98, 2000 Professional, ME, XP Home, and XP Professional; Mac® OS 9 v9.1 or later, OS X v10.1 through v10.2
Image file formats	JPEG Baseline TIFF 24-bit RGB uncompressed interleaved TIFF 24-bit YCbCr uncompressed interleaved TIFF 24-bit RGB packbits interleaved TIFF 8-bit gray uncompressed/packbits TIFF 8-bit palette color uncompressed/packbits TIFF 1-bit uncompressed/packbits/1D Huffman
Margins	Borderless printing: <ul style="list-style-type: none"> • Top 0.0 inch (0.0 mm) • Bottom 0.50 inch (12.5 mm) • Left/right 0.0 inch (0.0 mm) Bordered printing: <ul style="list-style-type: none"> • Top 0.16 inch (4 mm) • Bottom 0.50 to 0.66 inch (12.5 to 16.8 mm) • Left/right 0.16 inch (4 mm)
Media sizes	Photo paper (4 x 6 inches, 10 x 15 cm) Photo paper with tab (4 x 6 inches with 0.5 inch tab, 10 x 15 cm with 1.25 cm tab) Index cards (4 x 6 inches, 10 x 15 cm) Hagaki cards (3.9 x 5.8 inches, 100 x 148 mm) A6 cards (4.1 x 5.8 inches, 105 x 148 mm) L-size cards (3.5 x 5 inches, 90 x 127 mm) L-size cards with tab (3.5 x 5 inches with 0.5 inch tab, 90 x 127 mm with 12.5 mm tab)
Media types	Paper (plain, photo) Cards (index, Hagaki, A6, L-size)
Memory cards	CompactFlash Type I and II MultiMediaCard Secure Digital SmartMedia Sony Memory Sticks xD-Picture Card
Memory card-supported file formats	Printing: Supported image and video file formats Saving: All file formats

Operating temperature	32–113°F (0–45°C) [Optimum 59–95°F (15–35°C)]
Paper tray	One 4 x 6 inch (10 x 15 cm) photo paper tray
Paper tray capacity	20 sheets, maximum thickness 11.5 mil (292 μm) per sheet
Power consumption	Printing: 8.1 W Idle: 2.1 W Off: 2.0 W
Print cartridge	1 tri-color HP #57 (C6657A) OR 1 photo gray HP #59 (C9359A) (available Fall 2003)
USB support	Microsoft Windows 98, 2000 Professional, ME, XP Home, and XP Professional; Mac OS 9 v9.1 or later, OS X v10.1 through v10.2 HP recommends that the USB cable be less than 10 feet (3 meters) in length
Video file formats	Motion JPEG AVI Motion JPEG Quicktime MPEG-1



Numerics

9-up view mode 17

A

adjust

- brightness 32
- color 40
- contrast 39

all photos

print 24

antique effect 33

B

black & white effect 33

borderless printing 38

troubleshoot 48

brightness

adjust 32

buttons

control panel 5

C

calibrate print cartridge 45

calibration page 45

Cancel button 5

clean

print cartridge 43

printer 43

color

effect 33

extend 40

saturation 40

CompactFlash memory card

slot 4, 14

contrast 39

control panel

buttons 5

location 3

quick reference 5

copies

change number 30

default number 36

print multiple 22

Copies button 5

copper contacts on print

cartridge 10

country/region setting 42

crop photos 31

D

date/time stamp 37

default settings

for your printer 35

restore factory 41

deselect

a photo 20

all photos 20

digital camera

connect to the printer 27

documentation 2

DPOF file 26

delete 40

E

effect

antique 33

black & white 33

color 33

sepia 33

error messages 51

Exif Print 39

extend colors 40

F

factory default settings 41

file formats

photos 14, 54

video clips 14, 25, 54

frames 32

H

hardware problems 47

I

improve contrast 39

index page 18

indicator lights 4

insert

memory card 14

print cartridge 10

L

language setting 42

layout

change 29

set default for photos 36

set default for video action

prints 37

LCD screen settings 42

lights

memory card 4

on/attention 4

load

paper 8

print cartridge 10

location

Cancel button 5

Copies button 5

memory card light 4

memory card slots 3

On button 5

output guide 3

paper tray 3

paper tray door 3

paper width guide 3

Print button 5

print cartridge door 3

printer 3

printer control panel 3

rear paper slot 3

Save button 5

Select Photos button 5

USB port 3

M

maintenance 43

media types and sizes 8, 53

memory cards

camera-selected photos 26

file formats 14

insert 14

print from 21

remove 17

slots 4

supported 13

move your printer 46

MultiMediaCard memory card

slot 4, 14

multiple photos

default number of copies 36

deselect 20

print 22

O

On button 5

open

paper tray door 8

print cartridge door 11

output guide 3

P

paper

feed in straight 9

- load 8
- problems 48
- recommended types 53
- store 9
- supported types 8
- paper tray
 - door 3, 9
 - extension 9
 - location 3
- paper width guide
 - adjust 9
 - location 3
- photo index 18
- photo paper
 - handle 9
 - recommended types 53
 - store 9
 - troubleshoot 49
- photos
 - add frames 32
 - color effects 33
 - crop 31
 - deselect 20
 - index numbers 18
 - layout 29, 36
 - number of copies 30
 - print all 24
 - print from memory card 21
 - print multiple copies 22
 - print new 24
 - print range 23
 - print several different 22
 - print single 21
 - print using color effects 33
 - problems with quality 50
 - select 19
 - set date/time stamp 37
 - set default layout 36
 - view index numbers 17
- power cord connection 3
- print
 - all photos 24
 - borderless photos 38
 - calibration page 45
 - camera-selected photos 26
 - color 33
 - digital camera direct
 - connect 27
 - from memory card 21
 - multiple copies 22
 - new photos 24
 - number of copies 30
 - one photo 21
 - photos with white borders 38

- quality menu setting 34
- range of photos 23
- select photos 19
- several different photos 22
- test page 44
- using Exif Print 39
- video action prints 25
- Print button 5
- print cartridge 10
 - calibrate 45
 - clean 43
 - copper contacts 10
 - ink nozzles 10
 - insert 10
 - problems 44
 - remove 12
 - store 46
 - tape removal 10
- print cartridge door
 - location 3
 - open 11
- printer
 - change default settings 35
 - clean 43
 - documentation 2
 - front view 3
 - menu 5
 - rear view 3
 - specifications 54
 - store 46
 - transport 46
 - where to place 3
- printer menu 5
 - # of copies 36
 - after printing 35
 - camera selections 40
 - change layout 36
 - date/time stamp 37
 - Exif Print 39
 - language 42
 - print quality 34
 - restore defaults 41
 - video print 37
- printer parts
 - buttons 5
 - control panel 5
 - memory card slots 4
 - print cartridge door 11
- problems
 - borderless printing 48
 - hardware 47
 - paper 48
 - printing 48

R

- rear paper slot 3
- recommended paper 53
- remove
 - memory card 17
 - print cartridge 12
- revert to factory default settings 41

S

- Save button 5
- Secure Digital memory card
 - slot 4, 14
- Select Photos button 5
- sepia effect 33
- single photo
 - print 21
- size of photos 29
- slide show 34
- SmartMedia memory card slot 4, 14
- Sony Memory Stick memory card
 - slot 4, 14
- specifications 54
- store
 - photo paper 9
 - print cartridge 46
 - printer 46
- supported
 - file formats 14, 25
 - memory cards 13
 - paper types and sizes 8

T

- test page 44
- thumbnails 18
- troubleshoot
 - hardware problems 47
 - paper problems 48
 - printing problems 48

U

- unmark camera-selected photos 40
- USB port 3

V

- video action prints 25
 - default layout 37
 - file formats 25, 55

X

- xD-Picture Card memory card
 - slot 4, 14

Z

- zoom and crop photos 31

DECLARATION OF CONFORMITY

according to ISO/IEC Guide 22 and EN 45014

Manufacturer's Name: Hewlett-Packard Company
Manufacturer's Address: 16399 West Bernardo Drive
San Diego CA 92127, USA
Regulatory Model Number (RMN): SDGOA-0324

declares, that the product

Product Name: Photosmart 245 Series (Q3046A)
Model Number(s): Photosmart 245 (Q3046A)
Power Adapter(s): HP Part # Q3025-60177

conforms to the following Product Specifications:

Safety: IEC 60950: 3rd Edition:1999
EN 60950:2000
UL1950/CSA22.2 No.950, 3rd Edition:1995
NOM 019-SFCI-1993
GB4943:2001

EMC: CISPR 22:1997 / EN 55022:1998+A1:2000 Class B
CISPR 24:1997 / EN 55024:1998+A1:2001
IEC 61000-3-2:1995 / EN 61000-3-2:1995 A1+A2:1998
IEC 61000-3-3:1994 / EN 61000-3-3:1995
EN 61000-6-3:2001
FCC Part15-Class B / CNS13438
AS/NZS3548 / ICES-003, Issue 2
GB9254-1998

Supplementary Information:

The Product herewith complies with the requirements of the Low Voltage Directive 73/23/EEC and the EMC Directive 89/336/EEC and carries the CE marking accordingly.

- The product was tested in a typical configuration.



Printed on recycled paper
Printed in U.S., 5/03



ENERGY STAR® is a U.S. registered mark.
As an ENERGY STAR® partner,
Hewlett-Packard Company has determined
that this product meets the ENERGY STAR®
guidelines for energy efficiency.

www.hp.com

© 2003 Hewlett-Packard Company



Q3046-90114



i n v e n t

v1.3.0