

**hp**  
photosmart  
930  
series  
digital  
camera



user's manual





## Trademark and copyright information

© Copyright 2003 Hewlett-Packard Company

All rights are reserved. No part of this document may be photocopied, reproduced, or translated to another language without the prior written consent of Hewlett-Packard Company.

The information contained in this document is subject to change without notice. Hewlett-Packard shall not be liable for errors contained herein or for consequential damages in connection with the furnishing, performance, or use of this material.

Microsoft® and Windows® are U.S. registered trademarks of Microsoft Corporation.

Apple®, Macintosh®, and Mac® are registered trademarks of Apple Computer, Inc.

PENTAX® is a registered trademark of PENTAX Corporation.

 The SD logo is a trademark of the SD Card Association.

MultiMediaCard™ is a trademark of Infineon Technologies AG.

# Table of Contents

<b>Chapter 1:</b>	
<b>Getting started</b> .....	<b>8</b>
Camera parts .....	9
Setup .....	15
Attaching the wrist strap .....	15
Installing the batteries .....	16
Installing the memory card .....	16
Turning on power .....	17
Understanding the status screen .....	17
Restoring previous settings .....	18
Choosing the language .....	18
Setting the date and time .....	18
Installing the software .....	19
Windows .....	19
Macintosh .....	20
Camera states and menus .....	21
<b>Chapter 2:</b>	
<b>Taking pictures and recording video clips</b> . . . .	<b>22</b>
Taking still pictures .....	22
Recording audio with still pictures .....	23
Recording video clips .....	24
Taking self-timer pictures .....	25
Using the focus brackets .....	26
Using focus lock .....	27
Using live view .....	28
Setting the focus range .....	30
Setting the exposure mode .....	31
Using exposure compensation .....	32
Setting the flash .....	33

Using zoom . . . . .	35
Optical zoom . . . . .	35
Digital zoom . . . . .	35
Using the capture menu . . . . .	36
Help for the menu options . . . . .	37
Self-timer . . . . .	38
White balance . . . . .	39
AE metering . . . . .	41
ISO speed . . . . .	42
Color . . . . .	43
Red-eye reduction . . . . .	43
Resolution . . . . .	44
Compression . . . . .	45
Saturation . . . . .	46
Sharpness . . . . .	47
Contrast . . . . .	48
Setup . . . . .	48
<b>Chapter 3:</b>	
<b>Reviewing images and video clips . . . . .</b>	<b>49</b>
Using playback . . . . .	49
Using the playback menu . . . . .	51
Play/Record audio . . . . .	54
Play . . . . .	54
Record audio . . . . .	54
Delete . . . . .	55
Magnify . . . . .	56
Rotate . . . . .	56
Image info . . . . .	57
Setup . . . . .	58
<b>Chapter 4:</b>	
<b>Using hp instant share . . . . .</b>	<b>59</b>
Using the share menu . . . . .	60
Using hp instant share to print pictures . . . . .	61

Using the hp instant share e-mail service . . . . .	62
Adding e-mail addresses and group distribution lists . . . . .	62
Selecting images to be e-mailed . . . . .	65
Windows . . . . .	66
Macintosh . . . . .	66
<b>Chapter 5:</b>	
<b>Unloading and printing images . . . . .</b>	<b>67</b>
Unloading to a computer . . . . .	67
Printing images . . . . .	68
<b>Chapter 6:</b>	
<b>Using the setup menu . . . . .</b>	<b>70</b>
Camera sounds . . . . .	71
Date & time . . . . .	72
USB configuration . . . . .	72
TV configuration . . . . .	73
Language . . . . .	74
<b>Chapter 7:</b>	
<b>Troubleshooting and support . . . . .</b>	<b>75</b>
Problems and solutions . . . . .	75
Resetting the camera . . . . .	83
Error messages on the camera . . . . .	84
Error messages on the computer . . . . .	91
Getting assistance . . . . .	93
HP accessibility website . . . . .	93
HP photosmart website . . . . .	93
Support process . . . . .	93
Phone support in the United States . . . . .	95
Phone support in Europe, the Middle East, and Africa . . . . .	96
Other phone support worldwide . . . . .	98

<b>Appendix A:</b>	
<b>Batteries and camera accessories</b> . . . . .	<b>100</b>
Managing batteries . . . . .	100
Extending battery life . . . . .	101
Rechargeable batteries . . . . .	102
Power conservation . . . . .	102
Purchasing camera accessories . . . . .	103
<b>Appendix B:</b>	
<b>Specifications</b> . . . . .	<b>105</b>
Memory card capacity . . . . .	110

# Chapter 1:

## Getting started

Congratulations on your purchase of this digital camera! Your new camera has many features to enhance your picture-taking experience, including **HP Instant Share™**, direct printing capability, manual and automatic controls, on-camera Help, and an optional camera dock.

With **HP Instant Share**, you can easily select pictures on your camera to e-mail or print automatically the next time you connect the camera to your computer. So, within minutes, your friends and family can be viewing your pictures without burdening them with large e-mail attachments. Or you can use the direct printing capability with any HP Photosmart printer or other select HP printer without ever connecting to your computer. What a great way to keep others close while you capture precious memories!

To further enhance your experience, you may purchase an HP Photosmart 8886 camera dock (see page 103). The camera dock allows you to easily download images to a computer, send images to a printer or television, and recharge the camera batteries.

**NOTE** A dock insert is included in your camera box which enables your camera (and others of the same model) to use the HP camera dock.

Please do not use the dock insert without the camera dock and do not discard it. See the **HP 8886 Camera Dock User's Manual** for instructions on using the dock insert with the camera dock.









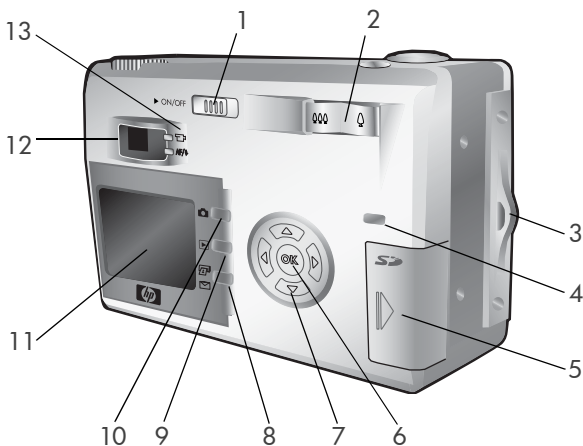









# Camera parts

**NOTE** Refer to the pages in parentheses after the part names for more information about those parts.









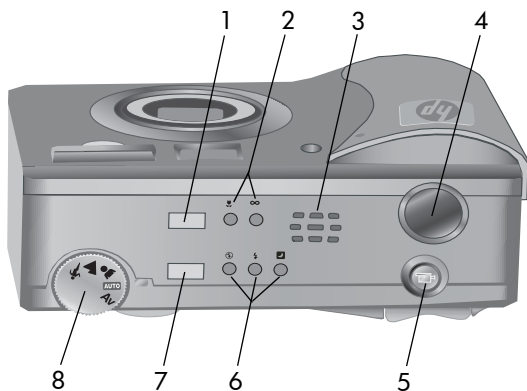









#	Name	Description
1	<b>▶ ON/OFF</b> switch (page 17)	Turns the camera power on and off
2	<b>◀◀ Zoom Out</b> and <b>▶▶ Zoom In</b> controls (page 35)	Zooms out the lens to the wide angle position, and zooms in the lens to the telephoto position
3	Wrist strap mount (page 15)	Allows you to attach a wrist strap

#	Name	Description
4	Power/Memory light (page 17)	<p><b>Solid</b>—camera is on</p> <p><b>Fast blinking</b>—camera is writing to the memory card</p> <p><b>Slow blinking</b>—camera is off and is charging the batteries</p> <p><b>Off</b>—camera is off</p>
5	Memory card door (page 16)	Allows you access to insert or remove the memory card
6	OK button (pages 36, 51)	Allows you to display the <b>Capture</b> and <b>Playback</b> menus and to select menu options on the Image Display
7	 <b>Controller</b> with   and   buttons	Allows you to move through menus and images on the Image Display
8	 <b>Share</b> button (page 60)	Turns the <b>Share</b> menu on and off the Image Display
9	 <b>Playback</b> button (page 49)	Turns <b>Playback</b> on and off the Image Display
10	 <b>Live View</b> button (page 28)	Turns <b>Live View</b> on and off the Image Display
11	Image Display (page 28)	Allows you to frame pictures and video clips using <b>Live View</b> and review them afterward in <b>Playback</b> , and to view all the menus

#	Name	Description
12	Viewfinder (page 22)	Allows you to frame the subject of your picture or video clip
13	Viewfinder lights:  Video and <b>AF/</b>  Auto Exposure/Auto Focus and Flash	<p> is <b>solid red</b>—video is recording</p> <p><b>AF/</b> is <b>solid green</b>—after you pressed the <b>Shutter</b> button halfway down, the camera is ready (auto exposure and auto focus are locked, and the flash is ready)</p> <p><b>AF/</b> is <b>blinking green</b>—either a focus error occurred when you pressed the <b>Shutter</b> button halfway down, the flash is charging, or the camera is processing a picture (see the following <b>NOTE</b>)</p> <p><b>Both</b>  and <b>AF/</b> <b>are blinking</b>—an error has occurred, for example, the memory card is full or there is no memory card in the camera (see the following <b>NOTE</b>)</p> <p><b>NOTE</b> If an error prevents a picture from being taken, then an error message will display on the Image Display. See <b>Error messages on the camera</b> on page 84.</p>



#	Name	Description
1	Focus button (page 30)	Allows you to select the <b>Macro</b>  focus range setting (to take close-up pictures), or the <b>Infinity</b> $\infty$ focus range setting (to take pictures of distant objects and landscapes)
2	Focus lights:  Macro and $\infty$ Infinity focus (page 30)	Lights solid when you select the <b>Macro</b>  or the <b>Infinity</b> $\infty$ focus range setting
3	Speaker	Plays camera sounds and audio clips
4	Shutter button (pages 22, 25)	Takes a picture and records audio
5	 <b>Video</b> button (page 24)	Starts and stops recording a video clip

#	Name	Description
6	Flash lights:  Flash Off,  Flash On, and  Night (page 33)	Lights solid when you select the <b>Flash Off</b>  , <b>Flash On</b>  , or <b>Night</b>  flash setting
7	<b>Flash button</b> (page 33)	Allows you to select the <b>Flash Off</b>  , <b>Flash On</b>  , or <b>Night</b>  flash setting
8	<b>Exposure Mode dial</b> with  <b>Action</b> ,  <b>Landscape</b> ,  <b>Portrait</b> ,  <b>Auto</b> , and <b>Av Aperture Priority</b> settings (page 31)	Allows you to select the exposure mode

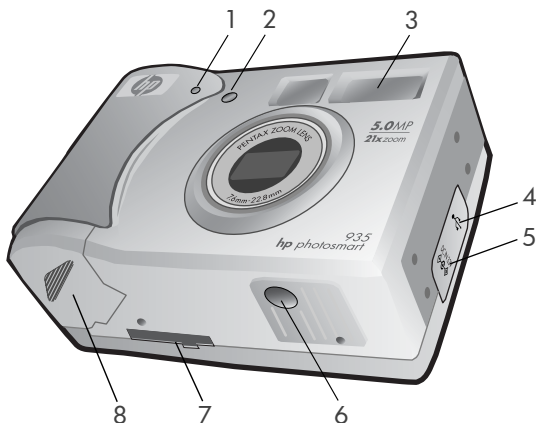

#	Name	Description
1	Microphone (page 23)	Records audio clips
2	Self-Timer light (page 25)	Blinks during the 10-second countdown before taking a picture when <b>Self-Timer</b> in the <b>Capture</b> menu is set to <b>On</b> or <b>On - 2 shots</b> . When set to <b>On - 2 shots</b> , blinks during the additional time between the first and second shots.
3	Flash (page 33)	Provides additional light to improve picture-taking
4	USB connector (pages 67, 68)	Allows you to connect a USB cable from the camera to a USB-enabled computer or printer

#	Name	Description
5	Power adapter connector (page 104)	Allows you to connect an optional HP AC power adapter to the camera to either operate the camera without batteries, or recharge the batteries in the camera
6	Tripod mount	Allows you to mount the camera to a tripod
7	Camera dock connector (page 103)	Allows you to connect the camera to the optional HP 8886 camera dock
8	Battery door (page 16)	Allows access to insert and remove the batteries

## Setup

### Attaching the wrist strap

Attach the wrist strap to the wrist strap mount on the side of the camera as shown.

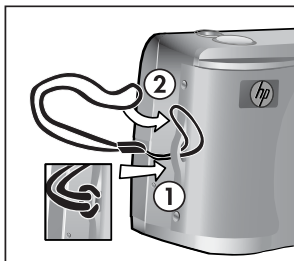

## Installing the batteries

- 1 Open the battery door on the bottom of the camera.
- 2 Insert the batteries as indicated inside the door.
- 3 Close the battery door.

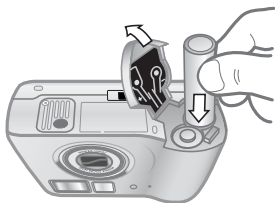

**NOTE** For more information about batteries, see **Managing batteries** on page 100. You can also use an optional HP AC power adapter to power the camera and recharge batteries in the camera. For more information about the HP AC power adapter, see **Purchasing camera accessories** on page 103.

## Installing the memory card

- 1 With the camera turned off and the back of the camera facing you, open the memory card door by sliding the door to the right.
- 2 Insert the memory card, making sure that it snaps into place.
- 3 Close the memory card door.

To remove the memory card, first make sure the camera is turned off. Open the memory card door, then push the memory card in and it will spring outward from the connector.

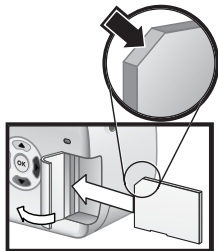



## Turning on power

Turn the camera on by sliding the ► **ON/OFF** switch to the right and then releasing it.

The lens extends, the Image Display turns on, and the Power/Memory light turns on solid.

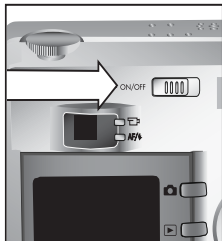

## Understanding the status screen

When you turn on the camera, the HP logo screen and then the status screen display for a few seconds on the Image Display.

The main part of the status screen shows the current focus, flash, **Resolution**, and **Compression** settings, as well as the battery level and pictures remaining count. Any non-default **Capture** menu settings are also shown across the top of the status screen.

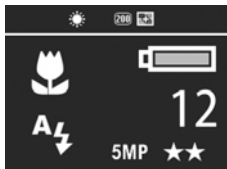

The status screen is also displayed for a few seconds any time you change the focus range, exposure mode, or flash settings on the camera. (See **Setting the focus range** on page 30, **Setting the exposure mode** on page 31, and **Setting the flash** on page 33.)

## Restoring previous settings

Some of the settings that you can change in the camera menus do not remain set after you turn the camera off. However, you can restore the settings from the last time the camera was on and had at least one non-default setting (which could actually be several power cycles ago) by holding down the OK button while also sliding the ► ON/OFF switch to turn the camera on. The restored settings are then displayed across the top of the status screen. (See the previous section.)

## Choosing the language

The first time you turn the camera on, the following screen appears and prompts you to choose a language.

- 1 Scroll to the language that you want by using the ▲ ▼ buttons on the Controller .
- 2 Press the OK button to select the highlighted language.

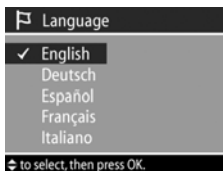

## Setting the date and time

The camera has a clock that records the date and time at which you take each picture. The first time you turn the camera on, the following screen appears after you choose the language.

- 1 Adjust the value of the highlighted selection by using the ▲ ▼ buttons.
- 2 Press the ◀ ▶ buttons to move to the other selections.

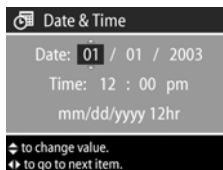

Repeat steps 1 and 2 until the correct date, time, and date/time format are set.

**NOTE** In the date/time format, **mm**=month, **dd**=day, and **yyyy**=year.

- 3 Press the **OK** button when the proper values are entered. The Image Display then turns off.

## Installing the software

The camera software allows you to unload images from the camera, view them, print them, and e-mail them. It also allows you to configure the **Share** menu on the camera.

See **Chapter 4: Using hp instant share** on page 59 for information about configuring the **Share** menu on the camera, and **Chapter 5: Unloading and printing images** on page 67 for information about connecting the camera to a computer or printer.

**NOTE** Copies of this User's Manual are located on the HP Photo & Imaging software CD. Look in the `\docs\Readme` file on the CD to see where the manual in your language is located.

## Windows

**NOTE** For the HP Instant Share component of the HP Photo & Imaging software to function properly on your Windows computer, you must have installed at least Internet Explorer 5.01 on Windows 2000 or XP, or Internet Explorer 5.01 Service Pack 2 on Windows 98, 98 SE, or Me.

- 1 Insert the HP Photo & Imaging software CD into the CD drive of your computer. The installation window automatically appears.

**NOTE** If the installation window does not appear, click **Start**, and then click **Run**. Type **X:\Setup.exe**, where **X** is the letter of your CD drive.

- 2 Click **Next**, and then follow the on-screen instructions to install the software.

Your Windows CD may also include bonus software from other manufacturers. To install any bonus software:

- 1 Click **Start**, click **Run**, and in the **Open** box, type **X:\Bonus\setup.exe** (where **X** is the letter of your CD drive).
- 2 Click **OK**, and then follow the on-screen instructions to install the bonus software.

## Macintosh

- 1 Insert the HP Photo & Imaging software CD into the CD drive of your computer.
- 2 Double-click the CD icon on the computer desktop.
- 3 Double-click the installer icon, and then follow the on-screen instructions to install the software.

**NOTE** Before you can unload images from the camera to a Macintosh computer, you must first change the **USB Configuration** setting to **Disk Drive** in the **Setup** menu on the camera. See **Chapter 6: Using the setup menu** on page 70, and then see **USB configuration** on page 72.

Your Macintosh CD may also include bonus software from other manufacturers. To install any bonus software:

- 1 Double-click the **Bonus** folder icon.
- 2 Double-click the installer icon for the bonus software.
- 3 Follow the on-screen instructions to install the software.

# Camera states and menus

Your camera has three main states that allow you to complete certain tasks. Each of these states has an associated menu you can use to adjust camera settings or perform tasks in that state.

- **Capture**—Allows you to take still pictures and record video clips. For information on using **Capture**, see **Chapter 2: Taking pictures and recording video clips** on page 22.
- **Playback**—Allows you to review the still images and video clips that you capture. For information on using **Playback**, see **Chapter 3: Reviewing images and video clips** on page 49.
- **Share**—Allows you to use the HP Instant Share technology to select images in the camera that will be automatically processed later when the camera is connected to your computer or to a compatible, USB-enabled HP printer. For information on using **Share**, see **Chapter 4: Using hp instant share** on page 59.

Your camera also has a fourth menu, the **Setup** menu, which allows you to adjust a number of camera settings. For information on using the **Setup** menu, see **Chapter 6: Using the setup menu** on page 70.

# Chapter 2:

## Taking pictures and recording video clips

### Taking still pictures

You can take a picture almost any time the camera is on, regardless of what is being shown on the Image Display. For example, if a menu is currently displayed when you press the **Shutter** button, the menu will be canceled, and the camera will take a picture.

To take a still picture:

- 1 Frame the subject for your picture in the viewfinder.
- 2 Hold the camera steady and press the **Shutter** button halfway down. The camera measures and then locks the focus and exposure.
- 3 Press the **Shutter** button all the way down to take the picture. You will hear a shutter click when the camera takes the picture.

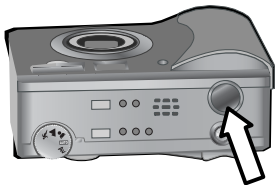

After the picture is taken, the image is displayed for several seconds in **Instant Review** on the Image Display. You can delete the image during **Instant Review** by pressing the **OK** button.

You can use **Playback** to review the pictures you have taken. See **Using playback** on page 49.

**NOTE** If you release the **Shutter** button only halfway after taking a picture, the focus and exposure measurements from the previous picture are retained. You can then press the **Shutter** button all the way down again and take another picture with the same focus and exposure as the previous picture. You can continue to do this to capture a sequence of pictures using the same focus and exposure. This is helpful when rapidly taking pictures and for capturing panoramas.

## Recording audio with still pictures

You can record audio clips that are attached to the still pictures you take. An audio clip can be a maximum of 60 seconds long.

The following procedure explains how to record an audio clip while you are taking a still picture. You can also record an audio clip later to attach to a still image by using the **Record Audio** menu option in the **Playback** menu. See **Using the playback menu** on page 51, and then see **Record audio** on page 54.

- 1 Press the **Shutter** button all the way down to take the picture.
- 2 Continue to hold the **Shutter** button down to start recording the audio clip. **Instant Review** remains on the Image Display, and a microphone  icon and audio counter appear on the Image Display as well.
- 3 Release the **Shutter** button to stop recording audio.

**NOTE** You must hold the **Shutter** button down for longer than 2 seconds after the picture is taken to have the recorded audio saved. Otherwise, it is discarded.

Audio recording stops when you release the **Shutter** button, the maximum audio clip length of 60 seconds is reached, or the memory card is full, whichever comes first. After recording has stopped, the image is displayed for several seconds in **Instant Review** on the Image Display. You can delete the image and the audio clip that is attached to the image during **Instant Review** by pressing the **OK** button.



You can use **Playback** to review the audio clips you have recorded. See **Using playback** on page 49.

**NOTE** If you are unhappy with an audio clip you record, you can delete just the audio clip (not the still image to which it is attached) by using the **Audio Only** option in the **Delete** sub-menu of the **Playback** menu. See **Delete** on page 55.

## Recording video clips

**NOTE** Zoom does not work while recording video clips.

A video clip includes audio and can be up to 2 minutes long.

- 1 Frame the subject for your video in the viewfinder.
- 2 Press and release the **Video**  button to start recording video. The Video  viewfinder light turns on solid red. If **Live View** is on when the camera starts recording, **REC** and a video counter appear on the Image Display. See **Using live view** on page 28.
- 3 Press and release the **Video**  button again to stop recording video.

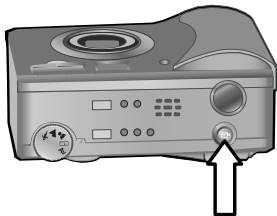



**NOTE** If you have set **Self-Timer** to **On** or **On - 2 shots** in the **Capture** menu (see page 38), the camera will start recording 10 seconds after you press the **Video** button. However, with the **On - 2 shots** setting, the camera only records one video clip.

The camera automatically stops recording when the maximum video clip length of approximately 2 minutes is reached, or the memory card is full, whichever comes first. After recording has stopped, the first frame of the video clip and **Processing...** appear on the Image Display. While it is processing, you can delete the video clip by pressing the **OK** button.

You can use **Playback** to review the video clips you have taken. See **Using playback** on page 49.

## Taking self-timer pictures

You can also take still pictures using the **Self-Timer** settings in the **Capture** menu.

- 1 Set **Self-Timer** to either **On** or **On - 2 shots** in the **Capture** menu. See **Using the capture menu** on page 36, and then see **Self-timer** on page 38.
- 2 Secure the camera to a tripod or set it on a stable surface.
- 3 Frame the subject for your picture in the viewfinder.
- 4 Press the **Shutter** button halfway down. The camera measures and then locks the focus and exposure. The camera will hold these settings for the 10 seconds until it takes the picture.

**NOTE** If you immediately press the **Shutter** button all the way down instead, the camera locks focus and exposure just before the end of the 10-second countdown. This is useful when one or more subjects will be entering the picture during the 10-second countdown period.



- 5 Press the **Shutter** button all the way down. A 10-second countdown appears on the Image Display. The Self-Timer light on the front of the camera blinks slowly for 7 seconds and then quickly for the final 3 seconds before the camera takes the picture. If you set **Self-Timer** to **On - 2 shots**, the Self-Timer light blinks for a few more seconds until the second picture is taken.

## Using the focus brackets

The two brackets in the middle of the viewfinder or the **Live View** screen (see **Using live view** on page 28) show the focus region for the picture you are taking. When you press the **Shutter** button halfway down, the camera uses this focus region to measure and then lock the focus.

The focus brackets turn green in the **Live View** screen and the **AF/** viewfinder light turns on solid green when the image is in focus and the camera can lock the focus. However, the focus brackets turn red and the **AF/** viewfinder light blinks green when the camera is unable to focus.

If the focus brackets turn red and the viewfinder light blinks, release the **Shutter** button, re-frame the subject for your picture, and then press the **Shutter** button halfway down again. If the focus brackets continue to turn red and the viewfinder light continues to blink after several tries, the lighting may be too low, or there may not be enough contrast in the focus region. Try using **Focus Lock**. See **Using focus lock** on page 27.

If the focus brackets turn red, the viewfinder light blinks, and the **Macro**  icon blinks on the Image Display, either the camera is set to the **Macro**  focus range but detects the focus is farther away than the macro (close-up) range, or the camera is set to the **Normal** focus range but detects the focus is closer than the normal range. For more information, see **Setting the focus range** on page 30.

**NOTE** When set to the **Macro**  focus range, the camera will not take a picture if it cannot find focus. However, when set to the **Normal** focus range (the default), the camera will still take a picture if it cannot find focus.

## Using focus lock

**Focus Lock** allows you to focus on a subject that is not in the center of the picture, or to capture action shots more quickly by pre-focusing in the area where action will occur. You can also use **Focus Lock** to help achieve focus in low lighting or low contrast situations.

- 1 Frame the subject for your picture within the focus brackets in the viewfinder or in **Live View**. (See **Using live view** on page 28.)
- 2 Press the **Shutter** button halfway down to lock the focus and exposure.
- 3 Continue to hold the **Shutter** button halfway down while you re-frame or adjust your subject for proper positioning.
- 4 Press the **Shutter** button all the way down to take the picture.

# Using live view





The Image Display allows you to frame pictures and video clips using Live View. To activate Live View on the Image Display, press the Live View  button.

**NOTE** Using the Image Display consumes a lot of battery power. To conserve batteries, use the viewfinder instead.

The following table describes the information that is displayed in the Live View screen of the Image Display when the camera settings are at their default values.

**NOTE** If you change other camera settings, icons for those settings will also be displayed in the Live View screen.



#	Icon	Description
1		Auto flash setting
2	 or 	 — Battery level (actual icon shown depends on the state of your camera batteries; see <a href="#">Managing batteries</a> on page 100)  — AC power when using the optional HP AC power adapter or HP camera dock

#	Icon	Description
3	12	Pictures remaining on the memory card (depends on how much space is remaining on the memory card)
4	★★	Compression setting (default is <b>Better</b> , which is indicated by the two stars)
5	5MP	Resolution setting (default is 5MP)
6	□ □	Focus brackets (see <b>Using the focus brackets</b> on page 26)

**NOTE** The F-number and shutter speed also appear in the **Live View** screen whenever you press the **Shutter** button halfway down.

**NOTE** If the light is too low when taking a still picture using **Live View**, a shaking hand  icon will display on the Image Display. This cautions you that the picture you will take is likely to be blurry due to the long exposure that will be required. Therefore, you may want to use the flash (see **Setting the flash** on page 33) or a tripod.



# Setting the focus range

The **Focus** button lets you toggle between the three focus range settings on the camera. **Normal** is the default setting. The focus range setting resets to **Normal** when you turn the camera off.



To change the focus range setting, press the **Focus** button on the top of the camera until the **Macro**  or **Infinity**  $\infty$  focus light is lit. The default **Normal** focus range setting is selected when neither focus light is lit. The following table describes each of the focus range settings on the camera.

Icon	Setting	Description
None	<b>Normal</b>	Use when taking pictures of subjects greater than 0.5 m (19.7 in) away. Auto focus is limited to a distance range of 0.5 m (19.7 in) to infinity.
	<b>Macro</b>	Use when taking close-up pictures of subjects less than 0.5 m (19.7 in) away. Auto focus is limited to a distance range of 0.14 to 0.7 m (5.5 to 27.6 in) at wide, and 0.4 to 0.7 m (15.7 - 27.6 in) at zoom ranges greater than wide.
$\infty$	<b>Infinity</b>	Use when taking pictures of distant objects and landscapes. Focus is fixed at infinity.

**NOTE** When set to the **Macro**  focus range, the camera will not take a picture if it cannot find focus (the focus brackets turn red in **Live View** and the **AF/**  viewfinder light blinks green). However, when set to the **Normal** focus range, the camera will still take a picture if it cannot find focus.





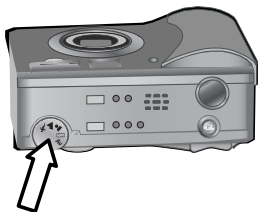

# Setting the exposure mode



**NOTE** The exposure mode setting does not apply when you are recording video clips.

The **Exposure Mode** dial lets you select between five exposure modes for the still pictures you take. The exposure mode setting determines how the camera selects the ISO speed, F-number (aperture), and shutter speed for the given scene brightness.



Simply turn the **Exposure Mode** dial to the setting you want. The following table describes each of the exposure mode settings on the camera.



Icon	Setting	Description
	<b>Auto</b>	The camera automatically selects an aperture and shutter speed.
	<b>Action</b>	The camera biases toward faster shutter speeds and higher ISO speeds to stop action.
	<b>Landscape</b>	The camera biases toward smaller apertures and lower ISO speeds for better depth of focus and quality.
	<b>Portrait</b>	The camera biases toward wider apertures to blur the background and uses lower contrast for professional-looking portraits.
<b>Av</b>	<b>Aperture Priority</b>	You select one of two specific apertures (F-numbers) in <b>Live View</b> by using the   buttons. Then the camera selects the appropriate shutter speed.

**NOTE** When you set the exposure mode to **Action** , **Landscape** , or **Portrait** , the **ISO Speed** menu option is grayed-out in the **Capture** menu, and the camera automatically selects the best **ISO Speed** setting.

**NOTE** If you set the exposure mode to **Action** and release and then re-press the **Shutter** button all the way down within 2 seconds after taking a picture, the camera takes the next picture using the same focus and exposure measurements as the previous picture. This allows you to take multiple pictures in rapid succession without having to wait for the camera to measure focus and exposure for each picture.

## Using exposure compensation

In difficult lighting conditions, you can use **Exposure Compensation** to override the automatic exposure setting that the camera makes. **Exposure Compensation** settings range from **-3.0 EV** (Exposure Value) to reduce the exposure of the image (darkening it), to **+3.0 EV** to increase the exposure of the image (brightening it).

By default, **Exposure Compensation** is set to **0** (zero) and no indication is given on the Image Display. When **Live View** is turned on and you press the   buttons, a meter appears in the middle of the Image Display, and the **Exposure Compensation** value is shown on the bottom of the display.





When you have not changed **Exposure Compensation** for 2 seconds, the meter disappears, but the value remains at the bottom of the screen flanked by arrows (unless it has been set to 0).



**Exposure Compensation** resets to the default 0 (zero) setting when you turn the camera off.



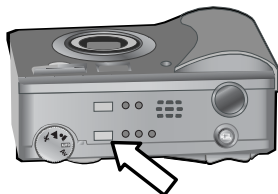

## Setting the flash

**NOTE** The flash does not work while recording video clips.



The **Flash** button lets you toggle between the four flash settings on the camera. **Auto**  $A_{\text{f}}$  is the default flash setting. The flash setting resets to **Auto** when you turn the camera off.



To change the flash setting, press the **Flash** button on the top of the camera until the Flash Off  $\text{f}$ , Flash On  $\text{f}$ , or Night  $\text{f}$  flash light is lit. The default **Auto**  $A_{\text{f}}$  flash setting is selected when none of the three flash lights is lit. The following table describes the different flash settings.

Icon	Setting	Description
	<b>Auto</b>	The camera measures the available light and fires the flash if necessary.
	<b>Flash Off</b>	The camera will not fire the flash.
	<b>Flash On</b>	The camera always fires the flash. If the light is behind your subject, you can use this setting to increase the light on the front of your subject. (This is called “fill-flash.”)
	<b>Night</b>	The camera fires the flash to illuminate objects in the foreground. It then continues to expose as if the flash had not fired to gather the background. This setting only works when taking pictures of still objects. You may also want to use a tripod for better results.



**NOTE** With each of the flash settings, you can also set **Red-eye Reduction** to **On** in the **Capture** menu. When **Red-eye Reduction** is **On**, you will see the **Red-eye Reduction**  icon displayed with the icon for the flash setting in the status screen and in **Live View**. To turn **Red-eye Reduction On**, see **Red-eye reduction** on page 43.

**NOTE** Only the **Flash Off**  and **Flash On**  settings are available when you set the **Exposure Mode** dial to **Aperture Priority Av**. See **Setting the exposure mode** on page 31.

# Using zoom

**NOTE** Zoom does not work while recording video clips.

## Optical zoom

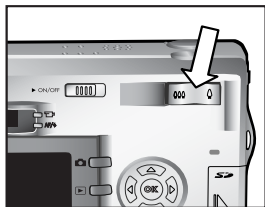

Press the **Zoom Out**  and **Zoom In**  controls on the **Zoom** lever to move the lens between wide angle and telephoto positions (1x to 3x). If **Live View** is on, a zoom indicator displays at the bottom of the **Image Display** to show you the current zoom setting.



**NOTE** The zoom indicator in the **Live View** screen contains a divider to show when you cross-over from optical to digital zoom.

## Digital zoom

**NOTE** For better results when using digital zoom, you may want to use a tripod to minimize camera shake.

- 1 Press the **Live View**  button to turn on **Live View**.
- 2 Press the **Zoom In**  control to optically zoom in to the maximum level, then release the control.
- 3 Press the **Zoom In**  control again and hold it until you reach the desired size in the **Image Display**. A yellow cropping frame surrounds the area of the image that will be captured.



The **Resolution** number on the right side of the screen also becomes smaller as you digitally zoom. For example, **2.9** appears in place of **5 MP**, indicating that the image is being cropped down to a size of 2.9 Megapixels.

- 4 When the cropping frame is at the right size, press the **Shutter** button to take the picture.

To turn digital zoom off and return to optical zoom, press the **Zoom Out** **⏪** control until digital zooming stops. Release the control, and then press the control again.

## Using the capture menu

The **Capture** menu allows you to adjust various camera settings that affect the qualities of the images and video clips you capture with your camera, such as their exposure, color, and resolution.

- 1 To display the **Capture** menu, press the **OK** button at any time when the Image Display is turned off, or when **Live View** is turned on in the Image Display.

Screen one

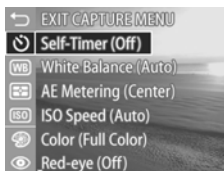

Screen two

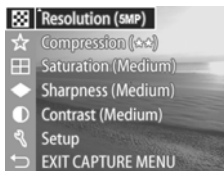

- 2 Use the **▲** **▼** buttons to scroll through the **Capture** menu options.

- 3 Either press the **OK** button to select a highlighted option and display its sub-menu, or use the ◀ ▶ buttons to change the setting for the highlighted option without going to its sub-menu.
- 4 Within a sub-menu, use the ▲ ▼ buttons and then the **OK** button to change the setting for the **Capture** menu option.

**NOTE** When you highlight a menu option within a sub-menu, a short Help description for that menu option is displayed at the bottom of the screen.

- 5 To exit the **Capture** menu, highlight the ↩ **EXIT CAPTURE MENU** option and press the **OK** button.

## Help for the menu options

**Help...** is the last option in each of the **Capture** sub-menus. The **Help...** option provides information about that **Capture** menu option and its settings. For example, if you press **OK** when **Help...** is highlighted in the **AE Metering** sub-menu, the **AE Metering Help** screen is displayed, as shown.

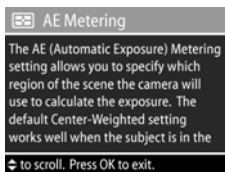

Use the ▼ ▲ buttons to scroll through the Help screens. To exit the Help and return to the particular **Capture** sub-menu, press the **OK** button.

## Self-timer

If you press OK when the **Self-Timer** option is highlighted in the **Capture** menu, the **Self-Timer** sub-menu displays. This sub-menu allows you to turn the self-timer on and off.

When you set **Self-Timer** to either **On** or **On - 2 shots**, the camera will take a picture 10 seconds after you press the **Shutter** button all the way down. If you set **Self-Timer** to **On - 2 shots**, the camera will also take a second picture 3 seconds after the first picture is taken.

**Self-Timer** is good for situations where you need to minimize camera shake. For example, keeping the camera steady on a tripod for a long exposure is easier if you use **Self-Timer**.

You can also use **Self-Timer** when recording video clips. The camera will start recording video 10 seconds after you press the **Video** button. However, with the **On - 2 shots** setting, the camera only records one video clip.

The default **Self-Timer** setting is **Off**. The **Self-Timer** setting resets to **Off** after each picture is captured or video clip is recorded, and when you turn the camera off. For information on using **Self-Timer**, see **Taking self-timer pictures** on page 25, or **Recording video clips** on page 24.

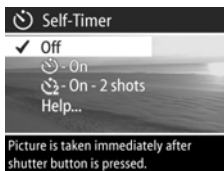



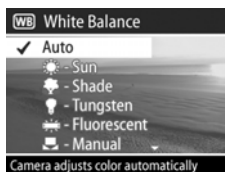

## White balance

If you press OK when the **White Balance** option is highlighted in the **Capture** menu, the **White Balance** sub-menu displays. In some cases, it may be necessary to pre-set the light source so the camera can reproduce colors more accurately and ensure that whites appear white in the captured image. The setting in this sub-menu determines how the camera will adjust the colors in the image to match the scene illuminant.



The default **White Balance** setting is **Auto**. The **White Balance** setting resets to **Auto** when you turn the camera off. Set the **White Balance** according to the situations explained in the following table.

Icon	Setting	Description
None	Auto	The camera automatically identifies and corrects for the scene illuminant.
	Sun	The camera balances color assuming it is outdoors under sunny or bright cloudy conditions.
	Shade	The camera balances color assuming it is outdoors in shade, in dark cloudy conditions, or at dusk.
	Tungsten	The camera balances color assuming incandescent or halogen lighting (typically found in homes).

Icon	Setting	Description
	<b>Fluorescent</b>	The camera balances color assuming fluorescent lighting.
	<b>Manual</b>	The camera calculates a custom <b>White Balance</b> based on your target image (see the following subsection).

If you press **OK** when the **Manual** option is highlighted in the **White Balance** sub-menu, the **Manual White Balance** screen displays. The **Live View** portion of the screen shows the color tint from the previous **Manual White Balance** setting that was made.



**NOTE** To restore the previous **Manual White Balance** setting, simply press the **OK** button in the **Manual White Balance** screen without pressing the **Shutter** button.

To change the **Manual White Balance** setting:

- 1 Point the camera at a white or gray target (such as a piece of paper), making sure that the region inside the focus brackets encompasses the white or gray target.
- 2 Press the **Shutter** button (the camera will not take a picture). The camera then calculates a custom **White Balance** setting based on the region inside the focus brackets. During the calculation, **PROCESSING...** is displayed on the screen. When the calculation is complete, the color tint in **Live View** changes to match the new **Manual White Balance** setting, and **WHITE BALANCE SET** is displayed.





- 3 If needed, repeat steps 1 and 2 until you get the desired **Manual White Balance** setting.
- 4 When you are satisfied with the **Manual** setting you have made, press the **OK** button to exit the **Manual White Balance** screen and return to the **Capture** menu.

## AE metering

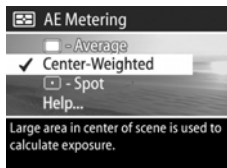
If you press **OK** when the **AE Metering** option is highlighted in the **Capture** menu, the **AE Metering** sub-menu displays. This sub-menu allows you to specify which region of the scene the camera will use to measure and calculate the exposure.



The following table describes the **AE Metering** settings. The default setting is **Center-Weighted**. The **AE Metering** setting resets to **Center-Weighted** when you turn the camera off.

Icon	Setting	Description
	<b>Average</b>	The camera uses the entire scene region to measure and calculate exposure.
<b>None</b>	<b>Center-Weighted</b>	The camera uses the center half of the scene region to measure and calculate exposure.
	<b>Spot</b>	The camera uses a small area in the center of the scene region to measure and calculate exposure.

## ISO speed

**NOTE** The ISO Speed setting does not apply to recording video clips.



If you press OK when the ISO Speed option is highlighted in the Capture menu, the ISO Speed sub-menu displays. This sub-menu allows you to adjust the sensitivity of the camera to light.



Because lower ISO numbers allow slower shutter speeds, use the ISO 100 setting to capture higher quality images that have the least grain or “noise.” In contrast, because higher ISO numbers allow higher shutter speeds, use a higher ISO Speed setting when taking either pictures in dark areas without a flash, or pictures of fast moving objects. However, higher ISO speeds produce pictures with more grain or “noise” and, thus, can be of lower quality.

**NOTE** If you are taking a picture in low light conditions without a flash and have set the camera to ISO 100, you may want to use a tripod because of the resulting slow shutter speed.

The default ISO Speed setting is Auto, which allows the camera to pick the best ISO Speed for the scene. The ISO Speed setting resets to Auto when you turn the camera off.

**NOTE** When you set the exposure mode to Action , Landscape , or Portrait , the ISO Speed menu option is grayed-out, and the camera automatically selects the best ISO Speed setting.

## Color

If you press OK when the **Color** option is highlighted in the **Capture** menu, the **Color** sub-menu displays. This sub-menu allows you to set the color in which your images will be captured.

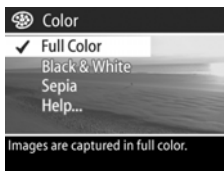

**NOTE** When you set **Color** to **Sepia**, your images will be captured in brown colors to make them look aged or old-fashioned.

**NOTE** Once you have taken a picture using either the **Black & White** or **Sepia** setting, the image cannot be adjusted back to **Full Color** later.

The default **Color** setting is **Full Color**. The **Color** setting resets to **Full Color** when you turn the camera off.

## Red-eye reduction

If you press OK when the **Red-eye** option is highlighted in the **Capture** menu, the **Red-eye Reduction** sub-menu displays. This sub-menu allows you to turn red-eye reduction on and off. When set to **On**, the **Red-eye Reduction** setting works in conjunction with the current flash setting.

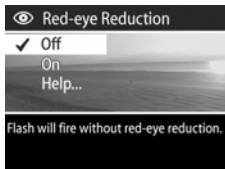

The red-eye phenomenon is caused by light from the flash reflecting off the subjects' eyes, which sometimes makes a human's or animal's eyes appear red in the captured image. When you set **Red-eye Reduction** to **On**, the camera flashes twice, minimizing the red-eye in the captured images of humans or animals.

The default **Red-eye Reduction** setting is **Off**, causing the flash to fire without red-eye reduction. The **Red-eye Reduction** setting remains set when you turn the camera off.

**NOTE** It will take longer to take a picture with **Red-eye Reduction** set to **On**. The shutter is delayed because of the additional flash. In turn, make sure your subjects wait for the second flash.

## Resolution

If you press **OK** when the **Resolution** option is highlighted in the **Capture** menu, the **Resolution** sub-menu displays. This sub-menu allows you to set the resolution (number of pixels) at which your images will be captured.

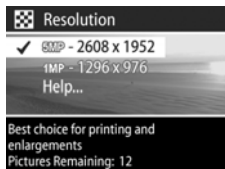

The default **Resolution** setting is **5MP - 2608 x 1952**. The **Resolution** setting remains set when you turn the camera off.

**NOTE** The **Resolution** number becomes smaller when you are using digital zoom. For example, **2.9** appears in place of **5 MP** on the right side of the Image Display, indicating that the image is being cropped down to a size of 2.9 Megapixels.

At the default **5MP - 2608 x 1952** pixels (5 Megapixels) setting, the captured image will be full size. At the **1MP - 1296 x 976** pixels (1 Megapixel) setting, the image will be 1/4 size.

**NOTE** The **Pictures Remaining** count at the bottom of the screen updates when you select a new setting.

**NOTE** The **Resolution** setting affects the number of images that can be saved on your memory card. Fewer images will be saved on the memory card at the default, higher **Resolution** setting of 5MP - 2608 x 1952 than at the lower setting of 1MP - 1296 x 976. See **Memory card capacity** on page 110.

## Compression

If you press OK when the **Compression** option is highlighted in the **Capture** menu, the **Compression** sub-menu displays. This sub-menu allows you to set how much JPEG compression your images will have.



The following table describes the **Compression** settings. The default setting is **Better**. The **Compression** setting remains set when you turn the camera off.

Icon	Setting	Description
★★★	<b>Best</b>	This setting produces the highest-quality images, but uses the most memory. This is recommended if you plan to enlarge images, or print images to a size larger than 18 by 24 cm (or 8 by 10 in).
★★	<b>Better</b>	This setting produces high-quality images and requires less memory than the <b>Best</b> setting. This is recommended for printing images up to 18 by 24 cm (or 8 by 10 in).
★	<b>Good</b>	This is the most memory-efficient setting, ideal for images that you want to e-mail or post to the Internet.

**NOTE** The **Pictures Remaining** count at the bottom of the screen updates when you select a new setting.

**NOTE** The **Compression** setting affects the number of images that can be saved on your memory card. Fewer images will be saved on the memory card at the **Best** setting than at the default **Better** setting. Similarly, fewer images will be saved at the default **Better** setting than at the **Good** setting. See **Memory card capacity** on page 110.

## Saturation

If you press **OK** when the **Saturation** option is highlighted in the **Capture** menu, the **Saturation** sub-menu displays. This sub-menu allows you to set how saturated the colors will be in your captured images.

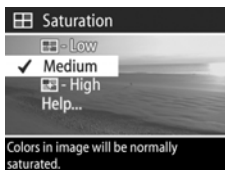

The following table describes the **Saturation** settings. The default setting is **Medium**. The **Saturation** setting remains set when you turn the camera off.

Icon	Setting	Description
	Low	The colors in your images will be more muted.
None	Medium	The colors in your images will be normally saturated.
	High	The colors in your images will be more vivid.



# Sharpness

**NOTE** The **Sharpness** setting does not apply to recording video clips.

If you press **OK** when the **Sharpness** option is highlighted in the **Capture** menu, the **Sharpness** sub-menu displays. This sub-menu allows you to set how sharp the edges will be in your pictures.



The following table describes the **Sharpness** settings. The default setting is **Medium**. The **Sharpness** setting remains set when you turn the camera off.



Icon	Setting	Description
	<b>Low</b>	The edges in your images will be softer.
<b>None</b>	<b>Medium</b>	The edges in your images will have normal sharpness.
	<b>High</b>	The edges in your images will be more pronounced.

## Contrast

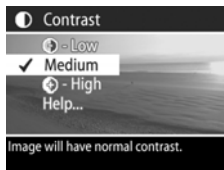
If you press OK when the **Contrast** option is highlighted in the **Capture** menu, the **Contrast** sub-menu displays. This sub-menu allows you to set how much contrast there will be between the dark and light colors in your captured images, including the amount of detail there will be in the highlights and shadows within the images.



The following table describes the **Contrast** settings. The default setting is **Medium**. The **Contrast** setting remains set when you turn the camera off.

Icon	Setting	Description
	<b>Low</b>	Your images will have less contrast: dark and light colors in the image will be less distinct, and there will be more details in the highlights and shadows.
<b>None</b>	<b>Medium</b>	Your images will have normal contrast.
	<b>High</b>	Your images will have more contrast: dark and light colors in the image will be more distinct, and there will be less details in the highlights and shadows.

## Setup

If you press OK when the **Setup** option is highlighted in the **Capture** menu, the **Setup** menu displays. See **Chapter 6: Using the setup menu** on page 70.







# Chapter 3:

## Reviewing images and video clips

### Using playback

After you have taken pictures or recorded video clips, you can use **Playback** to review them.







- 1 Press the **Playback**  button to activate **Playback**. The most recently taken or reviewed image or video clip appears on the Image Display.
- 2 Use the   buttons to scroll through your images and video clips. Press and hold the  or  button to scroll faster.





**NOTE** You only see the first frame of each video clip, which is indicated by the **Video**  icon. You can use the **Play** option in the **Playback** menu to play video or audio clips. See **Using the playback menu** on page 51.

- 3 To turn the Image Display off after reviewing your images and video clips, press the **Playback**  button again.

In addition to seeing the images or the first frames of video clips on the Image Display, some information about each image or video clip is also displayed in **Playback**. The following table describes the information that you may see displayed for each image or video clip while in **Playback**.









#	Icon	Description
1	 or 	 — Battery level (actual icon shown depends on the state of your camera batteries; see <b>Managing batteries</b> on page 100)   — AC power when using the optional HP AC power adapter or HP camera dock
2		Displays for the first few seconds when you enter <b>Playback</b> to indicate that you can scroll through all the images or video clips
3	 1  2	Indicates this image has been marked for HP Instant Share, including e-mailing one copy and printing two copies in this example (see <b>Chapter 4: Using hp instant share</b> on page 59), or blank if it is a video clip

#	Icon	Description
4	5 of 14	Shows the number of this image or video clip out of the total number of images and video clips on the memory card
5	 or 	 —Indicates this image has an audio clip  —Indicates this is a video clip

## Using the playback menu

The **Playback** menu allows you to play or record audio clips, play video clips, delete images, audio clips, or video clips or format the memory card, magnify an image on the Image Display, rotate an image, or view all of the settings that were used when capturing an image. From the **Playback** menu, you can also access the **Setup** menu to set a number of preferences on the camera.

- 1 To display the **Playback** menu, press the **OK** button while you are in **Playback**. If you are not currently in **Playback**, press the **Playback**  button first, then press the **OK** button.
- 2 Use the   buttons to move to the image or video clip you want to use.
- 3 Use the   buttons to highlight the menu options on the left of the Image Display. Select a highlighted option by pressing the **OK** button.









**NOTE** While a **Playback** menu option is highlighted, you can use the   buttons to scroll to other images and video clips. This is useful for performing the same action on several images or video clips, such as deleting multiple images or video clips.

- 4 To exit the **Playback** menu and return to viewing images in **Playback**, highlight the ↶ **EXIT PLAYBACK MENU** option and press the **OK** button.

The following table summarizes each of the **Playback** menu options and describes the information in the bottom right corner of each image while the **Playback** menu is displayed.



#	Icon	Description
1	↶	Exits the <b>Playback</b> menu
2	🗣️ or 🎤 or 📺	🗣️—Plays an audio clip that is attached to this image  🎤 —Records an audio clip to attach to this image  📺—Plays this video clip
3	🗑️	Provides options to either delete this image or video clip, delete only the audio clip attached to this still image, delete all images and video clips, or format the memory card
4	🔍	Magnifies this image by 4.5x (not available for video clips)

#	Icon	Description
5		Rotates this image automatically 90 degrees clockwise (not available for video clips)
6		Allows you to view all of the settings that were used when capturing this image
7		Displays the <b>Setup</b> menu, which allows you to set a number of preferences on the camera
8	<b>5 MP</b> ★★	Shows the <b>Resolution</b> (such as <b>5MP</b> ) and <b>Compression</b> (such as the 2 stars for <b>Better</b> ) for this image, or blank if it is a video clip
9	0:25  or 0:25 	 —Visible if this image has an audio clip attached to it, with the length of the audio clip displayed to the left of the icon   —Visible if this is a video clip, with the length of the video clip displayed to the left of the icon
10	<b>5 of 14</b>	Shows the number of this image or video clip out of the total number of images and video clips on the memory card
11	date	Shows the date that this image was captured or this video clip was recorded
12	 1  2	Indicates this image has been marked for HP Instant Share, including e-mailing one copy and printing two copies in this example (see <b>Chapter 4: Using hp instant share</b> on page 59), or blank if it is a video clip

## Play/Record audio

This **Playback** menu option is either **Play** or **Record Audio** depending on the still image or video clip that is currently displayed, as explained in the following subsections.

### Play

If you press **OK** when the **Play** option is highlighted in the **Playback** menu, the camera will play either an audio clip that is attached to the currently displayed image, or the current video clip.

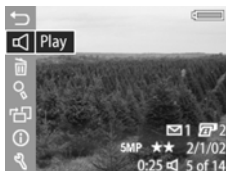

**NOTE** If there is no audio clip attached to the current image, the menu option is **Record Audio** instead, as explained in the next subsection.

You can adjust the audio volume by pressing the ▲ ▼ buttons while the audio clip or video clip is playing. To stop the clip while it is playing, press the **OK** button.

### Record audio

If you press **OK** when the **Record Audio** option is highlighted in the **Playback** menu, you can record an audio clip that will be attached to the currently displayed image. Audio recording starts immediately after you select this menu option. A microphone icon and audio counter are displayed during recording.

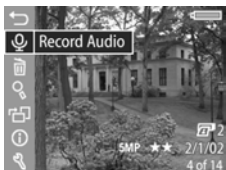

Audio recording stops when you press the **OK** button, the maximum audio clip length of 60 seconds is reached, or the memory card is full, whichever comes first.

**NOTE** If you are unhappy with an audio clip you record, you can delete the audio clip by using the **Audio Only** option in the **Delete** sub-menu, as explained in the next section. You can then use the **Record Audio** menu option again to re-record an audio clip, if you wish.

## Delete

If you press **OK** when the **Delete** option is highlighted in the **Playback** menu, the **Delete** sub-menu displays, which lists several options:

- **Cancel**—Returns you to the **Playback** menu
- **This Image**—Deletes the currently displayed image or video clip
- **Audio Only**—Deletes only the audio clip attached to the currently displayed image and keeps the current image
- **All Images**—Deletes all of the images and video clips on the memory card
- **Format Card**—Deletes all of the images, video clips, and files on the memory card, and then formats the memory card

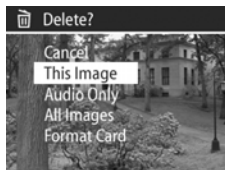
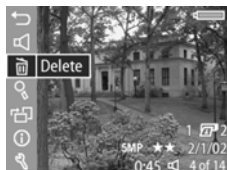

Use the **▲ ▼** buttons to highlight an option, and then press the **OK** button to select it.

## Magnify

If you press **OK** when the **Magnify** option is highlighted in the **Playback** menu, the currently displayed image is automatically magnified. This option is only for viewing a magnified image on the Image Display; it does not permanently alter the image.



**NOTE** You cannot select this option if a video clip is currently displayed.

Selecting this option magnifies the image 4.5x. The center portion of the magnified image is displayed along with four arrows, which indicate that you can pan around the magnified image by pressing the ▲ ▼ and ◀ ▶ buttons.



Press the **OK** button to exit the magnified image and return to the **Playback** menu.

## Rotate

If you press **OK** when the **Rotate** option is highlighted in the **Playback** menu, the currently displayed image is automatically rotated 90 degrees clockwise. The camera then returns to the **Playback** menu overlaying the rotated image.

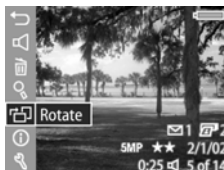

**NOTE** If you select this option for an image that has already been rotated, the image will be rotated again.



## Image info

If you press **OK** when the **Image Info** option is highlighted in the **Playback** menu, the **Image Info** screen displays, which shows all of the settings that were used when capturing the currently displayed image. The following table explains the information that is displayed for each image when you select the **Image Info** option.

**NOTE** The information in the last three rows in the bottom, right-hand corner of the image is the same information that is provided in the **Playback** menu view of the image.

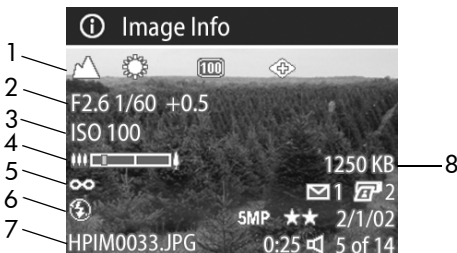

#	Description
1	Non-default exposure mode setting ( <b>Action</b> , <b>Landscape</b> , <b>Portrait</b> , or <b>Aperture Priority</b> ) and all non-default <b>Capture</b> menu settings
2	F-number (aperture) or blank if it is a video clip, shutter speed or blank if it is a video clip, and <b>Exposure Compensation (EV)</b> setting
3	<b>ISO Speed</b> setting that was used (100, 200, or 400), or blank if it is a video clip
4	Zoom position of lens when the picture was taken

#	Description
5	Non-default focus range setting ( <b>Macro</b> or <b>Infinity</b> )
6	Flash setting that was used ( <b>Flash Off</b> , <b>Flash On</b> , <b>Flash On with Red-eye Reduction</b> , <b>Night</b> , or <b>Night with Red-eye Reduction</b> ), or blank if it is a video clip
7	File name of the image on the memory card
8	File size of the image on the memory card

Use the ◀ ▶ buttons to scroll to other images and view their information. Then press the OK button to return to the **Playback** menu.

## Setup

If you press OK when the **Setup** option is highlighted in the **Playback** menu, the **Setup** menu displays. See **Chapter 6: Using the setup menu** on page 70.

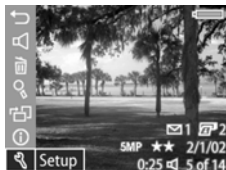

# Chapter 4:

## Using hp instant share

This camera has an exciting feature called **HP Instant Share**. This feature lets you select images in the camera to be automatically processed later when the camera is connected to your computer or to certain HP printers.

For example, you can select images that you want to have printed, then connect the camera to the computer or printer, and the selected images will be printed automatically.





As another example, you can select images in the camera to be automatically processed by HP's e-mail service. When the camera connects to your computer, the selected images are e-mailed to family, friends, or any e-mail address or group e-mail distribution list that you specify. The details about this are explained later in this chapter.

When you press the **Share** /  button on the camera, the most recently taken or viewed image appears on the Image Display, along with any print or other destinations that have been selected for the image. You can use the   buttons to scroll through the images to see destinations for the other images in the camera.

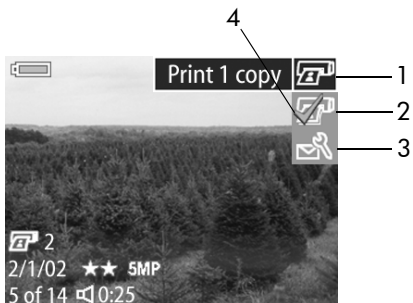

# Using the share menu

When you press the Share  button, the Share menu displays in the upper right-hand corner of the Image Display. The following table describes each of the Share menu options.





#	Icon	Description
1		<b>Print 1 copy</b> of the currently displayed image when connected to a computer or printer. By default, the picture is printed 10 by 15 cm (4 by 6 in).
2		<b>Print 2 copies</b> of the currently displayed image when connected to a computer or printer.
3		<b>Customize this menu...</b> lets you add e-mail addresses and other e-services to the Share menu. This procedure is explained later in this chapter.
4		Check mark indicates the destination has been selected for the currently displayed image. (You can select more than one destination per image.)



# Using hp instant share to print pictures

- 1 Turn on the camera, and then press the **Share**  button.
- 2 Use the   buttons to scroll to the image you want to print.

**NOTE** Video clips cannot be selected for printing.

- 3 Use the   buttons to scroll to the print option you want in the **Share** menu.
- 4 Press the **OK** button to select the print option, and a ✓ appears over that print option. To un-select a print option, simply press the **OK** button again.

**NOTE** You can select the **Print 1 copy** and the **Print 2 copies** print options for an image so that 3 copies of the image will be printed when connected to a computer or printer.

- 5 Scroll to other images by using the   buttons, and repeat steps 3 and 4 to select print options for each image.
- 6 When you are finished selecting all the images you want to have printed, press the **Share**  button to exit the **Share** menu.
- 7 The next time you connect the camera to your computer or a compatible printer, the images you selected will be printed. See **Chapter 5: Unloading and printing images** on page 67 for information about connecting the camera to a computer or printer.

**NOTE** The **Share** menu creates a standard Digital Print Order Format (DPOF) file for print options.

# Using the hp instant share e-mail service



Using HP Instant Share to e-mail images involves three steps:

- 1 Adding e-mail addresses or group distribution lists to the camera's **Share** menu (using your computer and the camera together).
- 2 Selecting images to be e-mailed (using the **Share** menu on the camera).
- 3 Connecting the camera to your computer to e-mail the images you selected.

**NOTE** If you are using a Macintosh computer, you must have an active Internet e-mail account that is accessible when e-mailing the images you selected.

## Adding e-mail addresses and group distribution lists

**NOTE** You will need an Internet connection to complete this procedure on a Windows computer.

- 1 Turn on the camera, and then press the **Share** /  button.
- 2 Highlight the **Customize this menu...**  option and press the OK button. A message on the Image Display appears asking you to connect the camera to your computer.

**NOTE** If your computer is running Windows XP, when you connect the camera to your computer in the next step, a dialog box will display that requests you to **Select the program to launch for this action**. Simply click on **Cancel** to close this dialog box.

- 3 Connect the camera to your computer by using the USB cable or an optional HP 8886 camera dock. This activates the Camera Share Menu Setup Wizard.

**NOTE** You need to have a memory card installed in your camera that is not locked and has some free space on it in order for the computer to recognize the camera from the Camera Share Menu Setup Wizard.

- 4 In the first window, click on either **Retrieve from Camera** on a Windows computer or **Next** on a Macintosh computer.

- 5 In the screen called **Modify Share Menu**:

- On Windows, check to see that **HP Instant Share E-mail** is visible above the **Add...** button, then click on the **Add...** button.
- On Macintosh, click on the **Add...** button.

- 6 If you are using a:

- Windows computer, you will be asked to sign in to HP's Passport program. HP Passport allows you to use HP's free e-mail service and other services that may be available in the future. The first time you see this screen, you will need to register as a new user. Follow the instructions on the screen to register.
- Macintosh computer, add the e-mail addresses you want. Then skip to step 8.

- 7** Once you have successfully registered, sign in to the HP Passport program, and then the **HP Instant Share E-mail Setup** screen will appear. Here you can either enter individual e-mail addresses or create group distribution lists, and specify how you want them to appear in the camera's **Share** menu. You can also enter a subject and message to go with all e-mails that will be sent to each e-mail address or distribution list. After completing the form, click **Next**. In the confirmation screen that appears, click **Finish**.
- 8** The names you specified for your newly added e-mail destinations or group distribution lists should now appear in the **Modify Share Menu** screen (in the **Current Share Menu** section). To add additional e-mail addresses or distribution lists to the camera **Share** menu, repeat steps 5-7 on Windows, or steps 5-6 on Macintosh. If you are using a Windows computer, you will not need to sign in to the HP Passport program again.

**NOTE** You can configure a maximum of 32 **Share** destinations (individual e-mail addresses or group distribution lists) that can be listed in the **Share** menu on your camera.

- 9** When you have finished adding e-mail addresses or distribution lists, click on either **Save to Camera** on a Windows computer or **Next** on a Macintosh computer to add the new addresses or distribution lists to the camera **Share** menu. When the computer confirms that the addresses or lists were saved to your camera, disconnect the camera from the computer, and press the **Share**  button on the camera to view the new e-mail destinations in the **Share** menu.
- 10** You are now ready to select images on the camera to be e-mailed. See the next section for how to do this.



## Selecting images to be e-mailed

- 1 Turn on the camera, and then press the **Share** /✉ button.
- 2 Use the ◀ ▶ buttons to scroll to the image you want to e-mail.

**NOTE** Video clips cannot be selected for e-mail.

- 3 Use the ▲ ▼ buttons to scroll to the e-mail destination that you want to select.
- 4 Press the **OK** button to select the e-mail destination, and a ✓ appears over that e-mail destination.

**NOTE** You can select more than one e-mail destination or print option for an image.

- 5 Scroll to other images by using the ◀ ▶ buttons, and repeat steps 3 and 4 to select e-mail destinations for each image.
- 6 When you are finished selecting all the images you want to e-mail, press the **Share** /✉ button to exit the **Share** menu.
- 7 The next time you connect the camera to your computer, the images you selected for e-mail will be sent to their respective destinations. See **Chapter 5: Unloading and printing images** on page 67 for information about connecting the camera to a computer.

The way images are e-mailed works differently on Windows and Macintosh computers, as explained in the following subsections.

## Windows

Images are not e-mailed directly to anyone. Rather, a message is sent to each e-mail address or group distribution list that you selected in the **Share** menu. The message contains thumbnail images of the photos that you selected for that address or list, as well as a link to a web page where the recipient can view the images. From that web page, the recipient can do things like reply to you or print the image. This makes it easy for people who use different e-mail programs to be able to see your images without the difficulty of dealing with e-mail attachments.

## Macintosh

Images are e-mailed directly to recipients using the default e-mail program on your computer.

# Chapter 5: Unloading and printing images

Once you have taken pictures, you can unload them from your camera to a computer or print them directly to a printer, as explained in this chapter.

**NOTE** You can also use the optional HP 8886 camera dock to unload images to a computer or print them directly to a printer, as well as display them on a television. See the *HP 8886 Camera Dock User's Manual* that was included with your camera dock.

## Unloading to a computer

**NOTE** If you are using a Macintosh computer, you must first change the **USB Configuration** setting to **Disk Drive** in the **Setup** menu. See **USB configuration** on page 72.

- 1 Turn off the camera.
- 2 Your camera came with a special USB cable for connecting the camera to a computer. Connect the larger end of that USB cable to the computer.
- 3 Open the rubber door on the side of the camera and connect the small end of the USB cable to the USB connector on the camera.

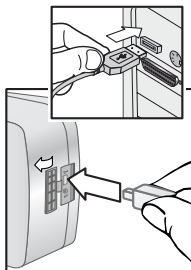

**NOTE** If your computer is running Windows XP, when you turn on the camera in the next step, a dialog box will display that requests you to **Select the program to launch for this action**. Simply click on **Cancel** to close this dialog box.

- 4 Turn on the camera. The HP Image Unload software will launch on your computer. If you have set the software to automatically unload the images in the camera, the images will automatically unload to the computer. Otherwise, in the **Welcome** screen, click **Start Unload**. If there were any images in the camera that were selected in the **Share** menu for printing or e-mail, those actions are started after the images have been unloaded to the computer.
- 5 When the unload screen on the computer says **Finished**, your images have been saved and shared. You can now disconnect the camera from the computer.

**NOTE** To unload images to a computer that does not have the HP Photo & Imaging software installed on it, change the **USB Configuration** setting to **Disk Drive** in the **Setup** menu. See **USB configuration** on page 72. This allows the camera to appear as another disk drive on the computer so that you can easily copy the image files from the camera to the hard drive of your computer.

## Printing images

To print images that have been unloaded to the computer, you can use the HP Photo & Imaging software that was shipped with the camera.

You can also connect the camera directly to any HP Photosmart printer or to any other HP printer with a front panel USB port, then print images selected from the camera **Share** menu or all images in the camera.



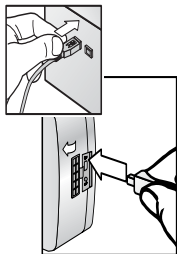

To print directly to an HP Photosmart printer or to any other HP printer with a front panel USB port:

- 1 Check that the printer is turned on and is online. (There should be no blinking lights on the printer or error messages displayed about the printer.) Load paper into the printer, if needed.
- 2 Your camera came with a special USB cable for connecting the camera directly to a printer. Connect the square end of the USB cable to the printer.
- 3 Open the rubber door on the side of the camera and connect the small end of the USB cable to the USB connector on the camera.

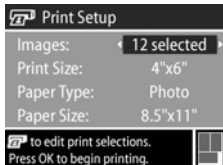

The **Print Setup** menu displays on the camera. If you already selected images to print from the camera **Share** menu, the number of images selected will be shown, as in this example **Print Setup** menu. Otherwise, **Images: ALL** will be displayed.



- 4 Adjust the settings in the **Print Setup** menu by using the   buttons to highlight a menu option and the   buttons to change the setting for each option.

**NOTE** There is a print preview in the lower right-hand corner of the **Print Setup** screen showing the page layout that will be used for printing images. This print preview updates as you change the settings for the **Print Size** and **Paper Size**.

- 5 Press the **OK** button to begin printing.

# Chapter 6:

## Using the setup menu

The **Setup** menu allows you to adjust a number of camera settings, such as the camera sounds, date and time, and the configuration of the USB or TV connection. You can access the **Setup** menu from either the **Capture** or **Playback** menu.

- 1 To display the **Setup** menu, open either the **Capture** or **Playback** menu and use the ▲ ▼ buttons to highlight the **Setup** ⚙ menu option. (For information about these other menus, see **Using the capture menu** on page 36, or **Using the playback menu** on page 51.) Then press the **OK** button.

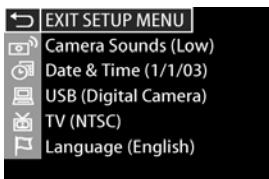

- 2 Use the ▲ ▼ buttons to scroll through the **Setup** menu options.
- 3 Either press the **OK** button to select a highlighted option and display its sub-menu, or use the ◀ ▶ buttons to change the setting for the highlighted option without going to its sub-menu.
- 4 Within a sub-menu, use the ▲ ▼ buttons and the **OK** button to change the setting for the **Setup** menu option.

- 5 To exit the **Setup** menu and return to the **Capture** menu or **Playback** menu, highlight the  **EXIT SETUP** menu option and press the **OK** button.

## Camera sounds

Camera sounds are the sounds that the camera makes when you turn it on, press a button, or take a picture. Camera sounds are not the audio sounds recorded with images or video clips.

If you press **OK** when the **Camera Sounds** option is highlighted in the **Setup** menu, the **Camera Sounds** sub-menu displays. This sub-menu allows you to set the volume level of the camera sounds, or turn camera sounds off.

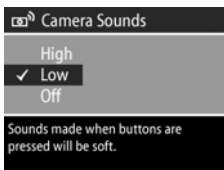

The default **Camera Sounds** setting is **Low**.

**NOTE** The volume level of camera sounds is not affected by the audio level adjustment provided with the **Play** menu option in the **Playback** menu.

## Date & time

If you press OK when the **Date & Time** option is highlighted in the **Setup** menu, the **Date & Time** screen displays. This screen allows you to set the current date and time, as well as the date/time format, for the camera. This is usually done when you first set up the camera; however, you may need to re-set the date and time when you are travelling to different time zones, or when the batteries are removed from the camera for more than 10 minutes.

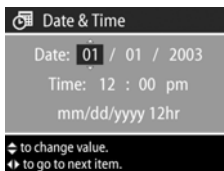

To set the date, time, and date/time format, follow the same procedure used in **Setting the date and time** on page 18.

## USB configuration

If you press OK when the **USB** option is highlighted in the **Setup** menu, the **USB Configuration** sub-menu displays. This sub-menu determines how the camera is recognized when connected to a computer.

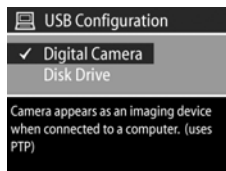

- **Digital Camera**—Causes the computer to recognize the camera as a digital camera using the Picture Transfer Protocol (PTP) standard. This is the default setting on the camera. Use this setting for unloading and sharing on a Windows computer that has the HP Photo & Imaging software installed on it.



- **Disk Drive**—Causes the computer to recognize the camera as a disk drive using the Mass Storage Device Class (MSDC) standard. Use this setting for unloading and sharing on a Macintosh computer, or on a Windows computer that does not have the HP Photo & Imaging software installed on it.

## TV configuration

If you press OK when the TV option is highlighted in the Setup menu, the TV Configuration sub-menu displays. This sub-menu allows you to set the format of the video out signal for displaying camera images on a television (TV) that is connected to the camera with an optional HP 8886 camera dock.

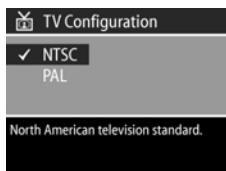

- **NTSC**—Format used primarily in North America and Japan
- **PAL**—Format used primarily in Europe

The default setting depends on the language that you selected when you powered on the camera for the first time. For more information, see **Choosing the language** on page 18.

For more information on connecting the camera to a TV, see the **HP 8886 Camera Dock User's Manual**.

# Language

If you press OK when the **Language** option is highlighted in the **Setup** menu, the **Language** sub-menu displays. This sub-menu allows you to set the language used in the camera interface, including the text in menus and on the Image Display.

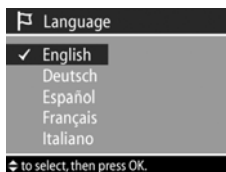

The default **Language** setting is **English**.

To set the language on the camera, follow the same procedure used in **Choosing the language** on page 18.

# Chapter 7: Troubleshooting and support

## Problems and solutions

**NOTE** If you still cannot solve your problem after reviewing the troubleshooting information provided in the following table, you can run diagnostic tests on your camera to try to isolate and solve the problem yourself. The diagnostic tests for the HP Photosmart 930 series digital camera are provided on the following website: [www.hp.com/support](http://www.hp.com/support).

Problem	Possible cause	Solution
The camera does not turn on.	The batteries are functioning incorrectly, are dead, are installed incorrectly, or are missing.	The charge in the batteries can be low or completely drained. Try installing new or recharged batteries.  Ensure that the batteries are inserted correctly.  Do not use ordinary alkaline batteries. For best results, use photo-lithium batteries or rechargeable NiMH batteries. If you must use alkaline batteries, use high-grade "ultra" or "premium" varieties.

Problem	Possible cause	Solution
<p>The camera does not turn on. (continued)</p>	<p>The HP AC power adapter is not connected to the camera, or is not plugged into a power outlet.</p>	<p>Ensure that the HP AC power adapter is connected to the camera and is plugged into a working electrical outlet.</p>
	<p>The HP AC power adapter is not functioning correctly.</p>	<p>Ensure that the HP AC power adapter is not damaged or defective and is plugged into a working electrical outlet.</p>
<p>I replace the camera batteries frequently.</p>	<p>Extended Image Display use for Live View or video recording, excessive flash use, and excessive zooming consume a lot of battery power.</p>	<p>Minimize the use of Live View and video, especially if using alkaline batteries. Also use the flash and zoom only when necessary.</p> <p>Use an HP AC power adapter to power the camera when you are using the Image Display for an extended period of time, or use the viewfinder instead of the Image Display whenever possible.</p> <p>Do not use ordinary alkaline batteries. For best results, use photo-lithium batteries or rechargeable NiMH batteries. If you must use alkaline batteries, use high-grade “ultra” or “premium” varieties.</p>







Problem	Possible cause	Solution
I replace the camera batteries frequently. (continued)	The NiMH batteries you are using were recharged incorrectly, or have drained on their own because they have not been used lately.	When NiMH batteries are brand new or have not been used in several months, they should be charged and fully drained 3-4 times to reach optimum capacity. Also, NiMH batteries discharge on their own when not in use and when not installed in the camera. So if you have not used them in a week or more, they may benefit from being charged.
The camera batteries will not charge.	Rechargeable batteries are not inserted.	Install NiMH batteries. Lithium and alkaline batteries cannot be recharged.
	Batteries are already charged.	Battery charging will not start if the batteries were recently charged. Try charging them again after they have drained awhile.
	Battery voltage is too low for charging to start.	The camera will not attempt to charge batteries that may be damaged or over-discharged. Remove the batteries from the camera and charge them in an external battery charger, then try them in the camera again. If this does not work, it is likely that one or more of the batteries are bad. Purchase new NiMH batteries and try again.



Problem	Possible cause	Solution
The camera batteries will not charge. (continued)	The wrong AC power adapter is being used.	Use only the HP AC power adapter approved for use with this camera. See <b>Purchasing camera accessories</b> on page 103.
	The batteries are damaged or bad.	NiMH batteries degrade over time and can fail. If the camera detects a problem with the batteries, it will not start charging or will stop charging prematurely. Purchase new batteries.
The Power/Memory light blinks as if the batteries are being recharged, but there are no batteries installed.	The camera does not recognize that there are no batteries installed.	Do nothing. The blinking is harmless and should stop after 5-30 minutes.
The wrong date and/or time is shown.	The batteries are drained or were removed from the camera for too long.	The date and time will be maintained for about 10 minutes without batteries installed. Reset the date and time by using the <b>Date &amp; Time</b> option in the <b>Setup</b> menu. (See <b>Date &amp; time</b> on page 72.)

Problem	Possible cause	Solution
The camera does not respond when I press a button.	The camera is turned off or has shut down.	Turn on the camera, or turn it off and then on again.
	The camera is connected to a computer.	Most of the camera buttons, except for the ► ON/OFF switch, do not respond when the camera is connected to a computer. If they respond, it is only to turn the Image Display on if it is off, or, in some cases, turn the Image Display off if it is on.
	The batteries are drained.	Replace or recharge the batteries.
	The camera has stopped operating.	Press the <b>Reset</b> switch to reset the camera. See <b>Resetting the camera</b> on page 83.
A long delay occurs between pressing the Shutter button and the camera taking a picture.	The camera needs time to lock focus and exposure.	Use <b>Focus Lock</b> . (See <b>Using focus lock</b> on page 27.)
	The camera is taking a long exposure.	Use a tripod or the flash.
	The camera is set to <b>Red-eye Reduction On</b> .	It will take longer to take a picture with <b>Red-eye Reduction</b> set to <b>On</b> . The shutter is delayed because of the additional flash. In turn, make sure your subjects wait for the second flash.

Problem	Possible cause	Solution
The camera does not take a picture when I press the Shutter button.	You did not press the <b>Shutter</b> button hard enough.	Press the <b>Shutter</b> button all the way down.
	The memory card is not installed.	Install the memory card.
	The memory card is full.	Unload images from the camera to your computer, then delete all images on the memory card. Or replace the card with a new one.
	The memory card is locked.	Switch the locking tab on the memory card to the unlocked position.
	The flash is recharging.	Wait until the flash has recharged before taking another picture.
	The camera is set to <b>Macro</b>  focus, but the focus is farther away than the macro (close-up) range.	Re-focus the camera so that it is within the macro (close-up) range. (See the range for <b>Macro</b> focus in <b>Setting the focus range</b> on page 30.)
	The camera is still saving the last picture you took.	Wait a few seconds for the camera to finish processing the last image before taking another picture.



Problem	Possible cause	Solution
My image is blurry.	The camera was set to <b>Normal</b> focus when it should have been set to <b>Macro</b>  focus, or vice versa.	Set the camera to <b>Macro</b>  focus or to <b>Normal</b> focus, and try taking the picture again. (See <b>Setting the focus range</b> on page 30.)
	You moved the camera while you took the picture.	Hold the camera steady as you press the <b>Shutter</b> button or use a tripod.
	The light is low and the flash is set to <b>Flash Off</b>  .	In dim light, the camera requires a longer exposure. Use a tripod to hold the camera steady, improve lighting conditions, or set the flash to <b>Flash On</b>  (see page 33).
	The camera focused on the wrong thing, or was unable to focus.	Use <b>Focus Lock</b> . (See <b>Using focus lock</b> on page 27.)
My image is too bright.	The flash provided too much light.	Use the <b>Flash Off</b>  setting (see page 33).
	You were too close to the subject to use the flash.	Move back from the subject or use the <b>Flash Off</b>  setting (see page 33), and take the picture again.

Problem	Possible cause	Solution
My image is too bright. (continued)	A natural or artificial source other than the flash provided too much light.	Try taking the picture from a different angle. Avoid pointing the camera directly toward a bright light or reflective surface on a sunny day. Use the <b>Flash On</b>  setting (see page 33) or adjust the <b>Exposure Compensation</b> (see page 32).
	The scene had many dark objects, such as a black dog on a black couch.	Decrease the <b>Exposure Compensation</b> (see page 32) so the dark objects in the scene will not look “washed-out.”
My image is too dark.	There was not enough light.	Wait for natural lighting conditions to improve, add indirect lighting, use the flash (see page 33), or adjust the <b>Exposure Compensation</b> (see page 32).
	The flash was on, but the subject was too far away.	Make sure your subject is within the flash working distance (see <b>Appendix B: Specifications</b> on page 105). If so, try using the <b>Flash Off</b>  setting (see page 33), which will require a longer exposure.
	A light shone behind the subject.	Use the <b>Flash On</b>  setting (see page 33) to brighten the subject, or adjust the <b>Exposure Compensation</b> (see page 32).

Problem	Possible cause	Solution
My image is too dark. (continued)	Your finger blocked the flash.	Be sure to move your fingers away from the flash when you take a picture.
	The scene had many light-colored objects, such as a white dog in snow.	Increase the <b>Exposure Compensation</b> (see page 32) so the light-colored objects in the scene will not look “muddy.”

## Resetting the camera

If your camera does not respond when you press any buttons, use the camera **Reset** switch to reset the camera:

- 1 Open the battery door on the bottom of the camera and remove both batteries.
- 2 Press the straightened end of a paper clip into the **Reset** switch until the switch is depressed, then remove the paper clip. The camera is reset.
- 3 Reinsert the batteries and close the battery door. You may now use the camera again.

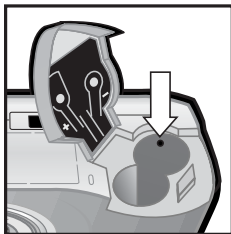

## Error messages on the camera

Message	Possible cause	Solution
<b>Batteries depleted. Camera is shutting down.</b>	Battery power is too low to continue operation.	Replace or recharge batteries, or use an optional HP AC power adapter.
<b>Batteries low</b>	Battery power is low (less than 1/3).	Either recharge or replace the batteries soon.
<b>Batteries too low for Live View</b>	Battery power is too low to use <b>Live View</b> on the Image Display.	Take pictures with the viewfinder instead of the Image Display. Replace or recharge batteries, or use an optional HP AC power adapter.
<b>Batteries are defective</b>	One or both cells are shorted or severely overdischarged.	Purchase new batteries.
<b>Batteries cannot be charged</b>	Either an error occurred during charging, an AC power disruption occurred during charging, the wrong AC power adapter is being used, batteries are defective, or no batteries are installed in the camera.	Retry charging the batteries a couple of times. If that fails, purchase new batteries and try again.

Message	Possible cause	Solution
<b>Lens is obstructed</b>	Something is blocking the lens from extending at power up.	Clear space for the lens so it can extend.
<b>Unsupported card</b>	The card in the memory slot is not a memory card or is not a supported memory card.	Ensure that the memory card is the proper type for your camera. (See <b>Appendix B: Specifications</b> on page 105.)
<b>No card in camera</b>	The camera does not have a memory card installed.	Install a memory card.
<b>Card is unformatted</b>	The memory card needs to be formatted.	Format the memory card by using the <b>Format Card</b> option in the <b>Delete</b> sub-menu of the <b>Playback</b> menu. (See <b>Delete</b> on page 55.) This will delete all data on the card.
<b>Card has wrong format</b>	The memory card is formatted for a different device such as an MP3 player.	Re-format the card by using the <b>Format Card</b> option in the <b>Delete</b> sub-menu of the <b>Playback</b> menu. (See <b>Delete</b> on page 55.)
<b>Unable to format</b>	The memory card is corrupted.	Replace the memory card.

Message	Possible cause	Solution
Card is locked	The memory card is locked.	Switch the locking tab on the memory card to the unlocked position.
Card is full	There is insufficient room to save more images on the memory card.	Unload images from the camera to your computer, then delete all images on the memory card (see <b>Delete</b> on page 55). Or replace the card with a new one.
Card is unreadable	The memory card is not a supported card or is corrupted.	Ensure that the memory card is the proper type for your camera. (See <b>Appendix B: Specifications</b> on page 105.) If it is the proper type, try formatting it (see the <b>Format</b> option in the <b>Delete</b> sub-menu on page 55). If it will not format, it is probably corrupted. Replace the memory card.
PROCESSING...	The camera is processing data, such as saving the last picture you took.	Wait a few seconds for the camera to finish processing before taking another picture.
Charging Flash	The camera is recharging the flash.	It takes longer to charge the flash when the batteries are low. If you see this message a lot, you may need to replace or recharge the batteries.

Message	Possible cause	Solution
Focus too far	The focus distance is beyond where the camera can focus.	Make sure the camera is not set to <b>Macro</b> 🌸 focus. Consider setting the camera to <b>Infinity</b> ∞ focus if your picture subject is far in the distance.
Focus too close	The focus distance is closer than the camera can focus.	Set the camera to <b>Macro</b> 🌸 focus, or if set to <b>Macro</b> focus, move further away from the subject.
Low light - unable to focus	The scene is too dark and the camera cannot focus.	Add an external light source, or use <b>Focus Lock</b> (see page 27) and point at a part of the scene that is brighter.
Unable to focus and blinking 🌸	The camera is set to <b>Macro</b> 🌸 focus, but the subject for the picture is too far.	Set the camera to <b>Normal</b> focus, and try taking the picture again. (See <b>Setting the focus range</b> on page 30.)
	The subject did not provide enough contrast for the camera to focus properly.	Use <b>Focus Lock</b> before taking the picture (see page 27).
	The light is low and the image is likely to be blurry due to the long exposure required.	Use the flash (see <b>Setting the flash</b> on page 33), or use a tripod.

Message	Possible cause	Solution
<b>F-number and shutter speed turn red in Live View</b>	The camera is out of range for the selected aperture.	Select a different aperture when using the <b>Aperture Priority Av</b> exposure mode.
<b>No images in camera</b>	There are no images or video clips on the memory card and you are trying to review them in <b>Playback</b> .	Take some pictures or video clips.
<b>Cannot display image</b>	Possibly comes from copying images to the memory card from a computer, or a corrupted image caused by the camera not shutting down properly.	Use the HP software to edit the images copied on the memory card. Also, do not remove batteries or the memory card when the camera is turned on.
<b>Unknown device</b>	The camera is connected to a USB device that it does not recognize.	Make sure that the camera is connected to a supported printer or computer.



Message	Possible cause	Solution
<b>Unable to communicate with printer</b>	There is no connection between the camera and printer.	Make sure the cable is connected between the camera or the optional HP 8886 camera dock and the printer. If that does not work, turn off the camera and disconnect it. Turn the printer off and then on again. Re-connect the camera and turn it on.
	A supported printer is either turned off or not connected to the camera.	Make sure the camera is connected to a supported printer and that the printer is turned on.
<b>Unsupported printer</b>	The printer is an unsupported device.	Connect the camera to a supported printer, such as an HP Photosmart printer or another HP printer with a front panel USB port. Or connect the camera to a computer and print from there instead.
<b>Photo tray is engaged</b>	The selected paper size cannot be used with the printer photo tray.	Disengage the printer photo tray, or change the paper size.
<b>Printer top cover is open</b>	The printer is open.	Close the top cover of the printer.

Message	Possible cause	Solution
Incorrect or missing print cartridge	The printer cartridge is the incorrect model or is missing.	Install a new printer cartridge, turn the printer off, then turn it back on.
Printer has a paper jam or The print carriage has stalled	There is a paper jam or the printer carriage has stalled.	Turn off the printer. Clear the paper jam, and then turn on the printer.
Printer is out of paper	Your printer is out of paper.	Load paper into the printer, and then press the <b>OK</b> or <b>Continue</b> button on the printer. To cancel the print job, press the <b>OK</b> button on the camera.
Printing canceled	The print job has been canceled.	Press the <b>OK</b> button on the camera. Complete the print request again.
Any error code numbers that appear	The camera may have a hardware or firmware problem.	Turn the camera off and then on again. If that does not fix the problem, try resetting the camera (see page 83). If the problem persists, call HP Support (see page 93).

## Error messages on the computer

Message	Possible cause	Solution
Connection between the imaging device and computer failed	The camera might be connected to a computer through a USB hub.	Try connecting the camera directly to the computer, or disconnect other devices attached to the USB hub.
The software cannot retrieve the Share Menu information from your camera	The computer needs to write files to the memory card during HP Instant Share setup, but the memory card is either missing, full, or locked.	Either install a memory card, make room on the memory card, or unlock it by switching the locking tab on the card to the unlocked position.
Computer cannot find the connected camera	The camera is turned off.	Turn on the camera.
	The camera is not working correctly.	Try connecting the camera directly to an HP Photosmart printer or an HP printer with a front panel USB port, and print an image. This will verify that the image, memory card, USB connection, and the USB cable are functioning correctly, or not.
	The cable is not connected correctly.	Make sure that the cable is firmly connected to the computer and camera.

Message	Possible cause	Solution
Computer cannot find the connected camera (continued)	The camera is set to the <b>Digital Camera</b> setting in the <b>USB Configuration</b> sub-menu of the <b>Setup</b> menu, but the computer cannot recognize the camera as a digital camera.	Change the <b>USB Configuration</b> setting to <b>Disk Drive</b> in the <b>Setup</b> menu. (See <b>USB configuration</b> on page 72.) This allows the camera to appear as another disk drive on the computer so that you can easily copy the image files from the camera to the hard drive of your computer.
	The camera is connected to the computer through a USB hub, and your USB hub is not compatible with the camera.	Connect the camera directly to a USB port on the computer.
	You are using the HP 8886 camera dock and forgot to press the <b>Save/Print</b> button.	Press the <b>Save/Print</b> button on the camera dock.
	The memory card is locked.	Switch the locking tab on the memory card to the unlocked position.
	The USB connection failed.	Reboot the computer.

## Getting assistance

This section contains support information for your digital camera, including support website information, an explanation of the support process, and support phone numbers.

### HP accessibility website

Customers with disabilities can get help by visiting [www.hp.com/hpinfo/community/accessibility/prodserv](http://www.hp.com/hpinfo/community/accessibility/prodserv).

### HP photosmart website

Visit [www.photosmart.hp.com](http://www.photosmart.hp.com) or [www.hp.com/photosmart](http://www.hp.com/photosmart) for the following information:

- Tips on using your camera more effectively and creatively
- HP digital camera driver updates and software
- Register your product
- Subscribe to newsletters, driver and software updates, and support alerts

### Support process

The HP support process works most effectively if you perform the following steps in the order specified:

- 1 Review the troubleshooting section of this User's Manual, which starts on page 75.
- 2 Access the HP Customer Care Center website for support. If you have access to the Internet, you can obtain a wide range of information about your digital camera. Visit the HP website for product help, drivers, and software updates at [www.hp.com/support](http://www.hp.com/support).

Customer Care is available in the following languages: Dutch, English, French, German, Italian, Portuguese, Spanish, Swedish, Traditional Chinese, Simplified Chinese, Japanese, Korean. (Danish, Finnish, and Norwegian support information is available in English only.)

- 3** Access HP e-support. If you have access to the Internet, connect with HP via e-mail by going to: [www.hp.com/support](http://www.hp.com/support). You will receive a personal reply from an HP Customer Care technician. E-mail support is available in the languages listed at that website.
- 4** Contact your local HP dealer. If your digital camera has a hardware failure, take it to your local HP dealer for a solution. Service is free during your digital camera's limited warranty period. After the warranty period, the dealer will quote a service charge.
- 5** Contact the HP Customer Care Center for support by phone. Please consult the following website to check the details and conditions of phone support in your country/region: [www.hp.com/support](http://www.hp.com/support). As a part of HP's continuing efforts to improve phone support information services, we advise you to check the HP website on a regular basis for new information regarding service features and delivery. If you cannot solve the problem using the above options, call HP while you are in front of your computer and digital camera. For faster service, please be prepared to provide the following information:
  - The digital camera's model number (located on the front of the camera)
  - The digital camera's serial number (located on the bottom of the camera)
  - The computer's operating system

- The version of the digital camera software (located on the camera's CD label)
- Messages displayed at the time the situation occurred

The applicable conditions for HP phone support are subject to change without notice.

Telephone support is free from the date of purchase for the period specified unless otherwise noted.

Locations	Free Phone Support Period
Africa	30 days
Asia Pacific	1 year
Canada	1 year
Europe	1 year
Latin America	1 year
Middle East	30 days
United States	1 year

## Phone support in the United States

Support is available both during and after the warranty period.

Within the period of your warranty, telephone support is provided free of charge. Call (208) 323-2551. If this is a long distance call for you, long distance charges will apply.

US phone support is available in both English and Spanish 24 hours a day, 7 days a week (days and hours of support may change without notice).

After the warranty period, call (208) 323-2551. Charges are \$25.00 per issue, and are charged to your credit card. If you think your HP product needs service, call the HP Customer Care Center, which can help determine if service is required.

## **Phone support in Europe, the Middle East, and Africa**

HP Customer Care Center phone numbers and policies may change. Visit the following website to check the details and conditions of phone support in your country/region:  
[www.hp.com/support](http://www.hp.com/support).

**Algeria** +213 (0)61 56 45 43

**Austria** +43 (0)820 87 4417

**Bahrain** +973 800 728

**Belgium** +32 070 300 005 (Dutch)  
+32 070 300 004 (French)

**Czech Republic** +42 (0) 2 6130 7310

**Denmark** +45 70202845

**Egypt** +20 02 532 5222

**Finland** +358 (0)203 66 767

**France** +33 (0) 8 92 69 60 22 (Euro 0.34/min)

**Germany** +49 (0)180 5652 180 (Euro 0.12/min)

**Greece** +30 10 60 73 603

**Hungary** +36 (0) 1 382 1111

**Ireland** +353 (0) 1890 923902

**Israel** +972 (0) 9 830 4848



**Italy** +39 (0)848 800 871

**Luxembourg** 900 40 006 (French)  
900 40 007 (German)

**Morocco** +212 224 04747

**Netherlands** 0900 2020 165 (Euro 0.10/minute)

**Norway** +47 815 62 070

**Poland** +48 22 865 98 00

**Portugal** +351(0) 808 201 492

**Romania** +40 1 315 44 42

**Russian Federation** +7 095 797 3520 (Moscow)  
+7 812 346 7997 (St Petersburg)

**Saudi Arabia** +966 800 897 14440

**Slovakia** +421 2 6820 8080

**South Africa** 086 000 1030 (RSA)  
+27-11 258 9301 (outside RSA)

**Spain** +34 902 010 059

**Sweden** +46 (0) 77-120 4765

**Switzerland** +41 0848 672 672 (German, French, Italian—  
Peak time 0.08 CHF/Outside peak 0.04 CHF)

**Tunisia** +216 1 891 222

**Turkey** +90 216 579 71 71

**Ukraine** +7 (380 44) 490-3520

**United Arab Emirates** +971 4 883 8454

**United Kingdom** +44 0870 010 4320

## Other phone support worldwide

HP Customer Care Center phone numbers and policies may change. Visit the following website to check the details and conditions of phone support in your country/region:  
[www.hp.com/support](http://www.hp.com/support).

**Argentina** +54 0 810 555 5520

**Australia** +63 (3) 8877 8000 (or local (03) 8877 8000)

**Brazil** +55 (11) 3747 7799 (Grande São Paulo)  
+55 0800 157751 (outside Grande São Paulo)

**Canada** +1 905 206 4663 (during the warranty period)  
+1 877 621 4722 (after the warranty period)

**Central America and the Caribbean** +1 800 711 2884

**Chile** +56 800 22 5547 (Post-sales Business Computing)  
+56 800 360 999 (Post-sales Home Computing)

**China** +86 (10) 6564 5959

**Colombia** +57 9 800 114 726

**Guatemala** +502 1 800 999 5105

**Hong Kong SAR** +852 3002 8555

**India** 1 600 112267 or +91 11 682 6035 (Hindi & English)

**Indonesia** +62 (21) 350 3408

**Japan** 0570 000 511 (inside Japan)  
+81 3 3335 9800 (outside Japan)

**Korea, Republic of** +82 (2) 3270 0700 (Seoul)  
0 80-999-0700 (outside Seoul)

**Malaysia** +60 1 800 805 405

**Mexico** +52 58 9922 (Mexico City)  
+52 01 800 472 6684 (outside Mexico City)

**New Zealand** +64 (9) 356 6640

**Peru** +51 0 800 10111

**Philippines** +63 (2) 867 3551

**Puerto Rico** +1 877 2320 589

**Singapore** +65 6272 5300

**Taiwan** +886 0 800 010055

**Thailand** +66 (2) 661 4000

**United States** +1 (208) 323-2551

**Venezuela** +58 0 800 4746 8368

**Vietnam** +84 (0) 8 823 4530





# Appendix A:

## Batteries and camera accessories

### Managing batteries

When the batteries are removed from the camera, the date and time settings are preserved for about 10 minutes. If the camera is without batteries for longer than 10 minutes, the clock is set to the last date and time at which the camera was used. You may be prompted to update the date and time.

The following battery levels may be displayed on the status screen, in **Live View**, in **Playback**, and when the camera is connected to a computer or printer.

Icon	Description
	Batteries have 65-100 percent battery life remaining.
	Batteries have 35-65 percent battery life remaining.
	Batteries have 10-35 percent battery life remaining.
	Batteries have less than 10 percent battery life remaining. Camera will power down soon. <b>Live View</b> is disabled.
 Blinking	Batteries are depleted. Camera will proceed to power down.

Icon	Description
	Camera is operating on AC power (with full or non-rechargeable batteries).
<b>Animated battery filling up</b>	Camera is operating on AC power and is charging the batteries.

The camera uses two AA batteries. Do not use ordinary alkaline batteries. For best results, use photo-lithium or rechargeable NiMH batteries. If you must use alkaline batteries, use high-grade “ultra” or “premium” varieties.

**NOTE** If you do not intend to use your camera for extended periods of time (more than a month), we strongly recommend that you remove the batteries.

## Extending battery life

- Minimize the use of **Live View** and video, especially when using alkaline batteries.
- Use the viewfinder to frame pictures instead of the Image Display. Leave the Image Display off whenever possible.
- Use zoom only when necessary.
- Use the **Auto** flash setting rather than **Flash On**.
- Minimize power cycling. If you expect to average more than one picture every five minutes, leave the camera on rather than turning it off after each shot. This minimizes the number of times the lens has to extend and retract.
- Use an optional HP AC power adapter or HP 8886 camera dock when the camera will be on for extended periods of time, or when unloading pictures to your computer or printing.

## Rechargeable batteries

Nickel Metal Hydride (NiMH) batteries can be recharged by using a battery charger. NiMH batteries can also be recharged in the camera when the camera is connected to an optional HP AC power adapter or HP 8886 camera dock. Batteries are fully recharged via the HP AC power adapter or camera dock in 15 hours.

Some things to keep in mind when using NiMH batteries are:

- Always recharge both NiMH batteries at the same time. One low-charged battery will reduce the battery life for both batteries in the camera.
- For NiMH batteries to reach optimal capacity and performance, they should first be discharged completely and recharged four separate times.
- NiMH batteries discharge when not in use, whether they are installed in a device (such as in the camera) or not. If they have not been used for more than two weeks, recharge them before using them again.

## Power conservation

To conserve battery power, the Image Display turns off automatically if there is no button activity for 60 seconds. If no buttons are pressed for 6 minutes, the camera turns off (unless it is connected to a computer or printer).

## Purchasing camera accessories

You can purchase additional accessories for your camera from your local retailer or online at [www.hpshopping.com](http://www.hpshopping.com). Some accessories for the HP Photosmart 930 series digital camera are listed below:

- HP Photosmart 8886 camera dock:
  - United States and Canada—C8886A #A2L
  - Mexico, Brazil, Chile, Argentina, and Uruguay—C8886A #ABM
  - Korea, Australia, and New Zealand—C8886A #UUF
  - Europe (except for the United Kingdom, see the next option below)—C8886A #AC2
  - United Kingdom and South Africa—C8886A #ABU
- Memory card—Secure Digital (SD) or MultiMediaCard™ (MMC) (512 MB is the maximum usable card size)

This product only supports the use of MultiMediaCard memory cards that have been verified compliant to the MultiMediaCard specification as of January 2000. Compliant MultiMediaCard memory cards have the MultiMediaCard logo on the card.

SD memory cards sold online at [www.hpshopping.com](http://www.hpshopping.com) include:

- 32 MB SD card—C8895A
- 64 MB SD card—C8896A
- 128 MB SD card—C8897A

- HP AC power adapter (HP supports only HP AC power adapters and other accessories expressly approved by HP):
  - United States and Canada—C8912 #A2L
  - Korea, Australia, and New Zealand—C8912 #UUF
  - Europe—C8912 #UUS
- HP Digital Camera Accessory Kit—Y1789B #UUS for Europe (continent), Y1789B #ABU for the United Kingdom, Y1789B #A2L for North America. Contents include:
  - Universal camera case
  - Battery recharger
  - 4 rechargeable NiMH batteries
- HP Digital Camera Accessory Kit—C8884B #UUS for Europe (continent), C8884B #ABU for the United Kingdom, C8889A for North America. Contents include:
  - Universal camera case
  - Battery recharger
  - 4 rechargeable NiMH batteries
  - DC car adapter for battery recharger
  - 32 MB Secure Digital (SD) memory card



# Appendix B:

## Specifications

Feature	Description
Resolution	Still pictures: <ul style="list-style-type: none"><li>● 5.26 MP (2668 by 1970) total pixel count</li><li>● 5.08 MP (2608 by 1952) effective pixel count</li></ul> Video clips: 288 by 208 total pixel count
Sensor	Diagonal 9.04 mm (1/1.8-inch, 4:3 format) CCD
Color depth	36-bit (12 bits by 3 colors)
Storage	Slot for memory card; Secure Digital (SD) and MultiMediaCard (MMC) memory card supported. (One 32 MB SD memory card included.) See <b>Memory card capacity</b> on page 110.
Lens	Focal length: <ul style="list-style-type: none"><li>● Wide—7.6 mm</li><li>● Telephoto—22.8 mm</li></ul> F-Number: <ul style="list-style-type: none"><li>● Wide—f/2.6</li><li>● Telephoto—f/4.8</li></ul>
Viewfinder	Zooming optical viewfinder
Zoom	3x optical, 7x digital zoom. <ul style="list-style-type: none"><li>● Wide—37 mm</li><li>● Telephoto—111 mm</li></ul>

Feature	Description												
Focus	TTL auto focus. Focus range settings: <ul style="list-style-type: none"> <li>● Normal (default)—Auto focus range of 0.5 m (19.7 in) to infinity.</li> <li>● Macro—Auto focus range of 0.14 to 0.7 m (5.5 to 27.6 in) at wide, 0.4 to 0.7 m (15.7 to 27.6 in) at zoom ranges greater than wide.</li> <li>● Infinity—Focus is fixed at infinity.</li> </ul>												
Shutter speed	1/2000 to 15 seconds												
Tripod mount	Yes												
Built-in flash	Built-in flash assembly, 5 second recharge.												
Flash working distance	<table border="1"> <thead> <tr> <th>Zoom Position</th> <th>ISO 100</th> <th>ISO 200</th> <th>ISO 400</th> </tr> </thead> <tbody> <tr> <td>Wide</td> <td>2.5 m</td> <td>3.5 m</td> <td>5.1 m</td> </tr> <tr> <td>Telephoto</td> <td>1.3 m</td> <td>1.9 m</td> <td>2.5 m</td> </tr> </tbody> </table>	Zoom Position	ISO 100	ISO 200	ISO 400	Wide	2.5 m	3.5 m	5.1 m	Telephoto	1.3 m	1.9 m	2.5 m
Zoom Position	ISO 100	ISO 200	ISO 400										
Wide	2.5 m	3.5 m	5.1 m										
Telephoto	1.3 m	1.9 m	2.5 m										
External flash	No												
Flash settings	Auto (default), Flash On, Flash Off, Night. Red-eye reduction can be added independently to any of these settings through the <b>Capture</b> menu (default is Red-eye Reduction Off).												
Image Display	1.5-inch color LED backlit, polysilicon TFT LCD with 521 by 218 dots (113,578 dots)												
Status LCD	No												

Feature	Description
Image capture options	<ul style="list-style-type: none"> <li>● Still (default)</li> <li>● Self-Timer—Can be set to On or On - 2 shots through the <b>Capture</b> menu; 10 second delay for both settings. On - 2 shots setting takes a second shot about 3 seconds later.</li> <li>● Video—15 frames per second; includes audio. Up to 2 minutes of video can be recorded.</li> </ul>
Audio capture	<ul style="list-style-type: none"> <li>● Still pictures—Maximum of 60 seconds of audio can be captured with each still picture.</li> <li>● Video—Audio is captured automatically with video.</li> </ul>
Exposure Mode settings	Auto (default), Action, Landscape, Portrait, Aperture Priority
Exposure Compensation	Can be set manually from -3.0 to +3.0 EV (Exposure Value) in 0.5 EV increments.
White Balance settings	Auto (default), Sun, Shade, Tungsten, Fluorescent, Manual
AE Metering settings	Average, Center-Weighted (default), Spot
ISO Speed settings	Auto (default), 100, 200, 400
Color settings	Full Color (default), Black & White, Sepia
Resolution settings	<ul style="list-style-type: none"> <li>● 5 MP - 2608 x 1952 (default)</li> <li>● 1MP - 1296 x 976</li> </ul>
Compression settings	<ul style="list-style-type: none"> <li>★★★ - Best</li> <li>★★ - Better (default)</li> <li>★ - Good</li> </ul>

Feature	Description
Saturation settings	Low, Medium (default), High
Sharpness settings	Low, Medium (default), High
Contrast settings	Low, Medium (default), High
Playback zoom	Yes, 4.5x
Compression format	<ul style="list-style-type: none"> <li>● JPEG (EXIF) for still images</li> <li>● MPEG1 for video clips</li> </ul>
Interfaces	<ul style="list-style-type: none"> <li>● USB to a computer, or USB to an HP Photosmart printer or to any other HP printer with a front panel USB port</li> <li>● DC IN 3.3 to 3.7V</li> <li>● HP Photosmart 8886 camera dock</li> </ul>
Standards	<ul style="list-style-type: none"> <li>● PTP transfer (15740)</li> <li>● MSDC transfer</li> <li>● NTSC/PAL</li> <li>● JPEG</li> <li>● MPEG1</li> <li>● DPOF 1.1</li> <li>● EXIF 2.2</li> <li>● DCF 1.0</li> </ul>

Feature	Description
Power	<p>2 AA batteries (2 non-rechargeable AA batteries included) or optional HP AC power adapter. Acceptable batteries include photo-lithium, "ultra" or "premium" grade alkaline, or rechargeable NiMH. NiMH batteries can be recharged in the camera using the optional HP AC power adapter or HP camera dock.</p> <p>Optional HP AC power adapter (Input: 100 to 240Vac; Output: 3.3 to 3.7Vdc @ 571 to 2500mA):</p> <ul style="list-style-type: none"> <li>● United States and Canada—C8912 #A2L</li> <li>● Korea, Australia, and New Zealand—C8912 #UUF</li> <li>● Europe—C8912 #UUS</li> </ul> <p>Optional HP Photosmart 8886 camera dock:</p> <ul style="list-style-type: none"> <li>● United States and Canada—C8886A #A2L</li> <li>● Mexico, Brazil, Chile, Argentina, and Uruguay—C8886A #ABM</li> <li>● Korea, Australia, and New Zealand—C8886A #UUF</li> <li>● Europe (except for the United Kingdom, see the next option below)—C8886A #AC2</li> <li>● United Kingdom and South Africa—C8886A #ABU</li> </ul> <p>Slow trickle recharging in camera with the optional HP AC power adapter or HP camera dock (100% in 15 hours).</p> <p>Automatic advanced power management. Camera has a maximum AC power consumption of 3 Volts dc (2700 mA).</p>

Feature	Description
External body dimensions	97 mm (L) by 45 mm (W) by 67 mm (H) 3.8 in (L) by 1.8 in (W) by 2.6 in (H)
Weight	225 grams (7.9 ounces) without batteries
Temperature range	Operational: 5 to 45° C (41 to 113° F) at 15 to 85% Relative Humidity  Storage: -30 to 65° C (-22 to 149° F) at 15 to 90% Relative Humidity
Warranty	HP 1 year exchange warranty

## Memory card capacity

The following table lists the approximate number of still images that can be stored on a 32 MB Secure Digital (SD) memory card when the camera is set to the different **Resolution** and **Compression** settings available in the **Capture** menu (see page 44).

**NOTE** The actual file sizes and number of still images that can be stored on the memory card will vary, depending on the content of each still image.

	5MP - 2608 x 1952 Resolution	1 MP - 1296 x 976 Resolution
★★★ - Best Compression	11 images (2.6 MB each)	23 images (1.25 MB each)
★★ - Better Compression	23 images (1.25 MB each)	48 images (600 KB each)
★ - Good Compression	48 images (600 KB each)	96 images (300 KB each)

# Index

## A

- AA batteries 101
- AC power adapter
  - connector on camera 15
  - HP part number 109
  - purchasing 104
- accessories for camera 103
- AE Metering, setting 41
- alkaline batteries 101
- Aperture Priority (Av), setting 31
- aperture, setting 31
- arrow buttons on Controller 10
- audio clips
  - delete 55
  - play 54
  - record 23, 54
- Auto Exposure/Auto Focus and
  - Flash light, description 11
- automatic exposure, override 31
- Av Aperture Priority, setting 31

## B

- batteries
  - door on camera 15
  - extend life of 101
  - icons 100
  - install 16
  - levels 100
  - rechargeable 102
  - types to use 101
- Best Compression setting 45
- Better Compression setting 45
- blinking lights on camera 10,  
11, 14

- bonus software 20
- brackets in Live View screen 26
- brightening an image 32

## C

- calibrating color of images 40
- camera
  - accessories 103
  - reset switch 83
  - specifications 105
  - states 21
  - turn on/off 17
- Camera Sounds, setting 71
- Capture menu
  - Help for menu options 37
  - using 36
- Color of images, setting 43
- compression format 108
- Compression, setting 45
- computer, connect camera to 67
- connections
  - as a digital camera 72
  - as a USB Mass Storage Device
    - Class (MSDC) 73
  - to computer 67
  - to printer 68
- connectors, descriptions 15
- Contrast, setting 48
- Controller, description 10
- customer support 93

## D

- darkening an image 32
- Date & Time, setting 18, 72
- delete
  - audio only 55
  - during Instant Review 22
  - images and video clips from memory card 55
- Digital Print Order Format 61
- digital zoom 35
- disk drive, camera as 73
- display, using 28
- DPOF 61

## E

- e-mail
  - addresses, customizing the Share menu 62
  - images from computer 68
- enlarge image 56
- error messages
  - on camera 84
  - on computer 91
- Exposure Compensation, setting 32
- Exposure Mode dial, description 13
- Exposure Mode, setting 31

## F

- files
  - Compression setting 46
  - delete from memory card 55
  - DPOF 61
  - Resolution setting 45
- flash
  - description 14
  - lights (LEDs) 13

- setting 33
- working distance 106
- Flash button, description 13
- Flash Off light, description 13
- Flash On light, description 13
- F-number, setting 31
- focus
  - lights (LEDs) 12
  - lock 27
  - range 106
  - range setting 30
- focus brackets, using 26
- Focus button, description 12
- format memory card 55

## G

- Good Compression setting 45

## H

- Help for Capture menu
  - options 37
- help from customer support 93
- HP AC power adapter
  - connector on camera 15
  - purchasing 104
- HP camera dock
  - connect to 15
  - description 8
  - dock insert 8
  - purchasing 103
- HP Instant Share
  - description 8, 59
  - Share button 10, 59
  - Share menu 60
  - turn on/off 59
- HP web sites 93



## I

- Image Display
  - description 10
  - Live View button 10
  - status screen 17
  - using 28
- Image Info, using 57
- images
  - AE Metering setting 41
  - brightening 32
  - Color setting 43
  - color tint 40
  - Compression setting 45
  - Contrast setting 48
  - darkening 32
  - delete 55
  - Exposure Mode setting 31
  - Image Info in Playback 57
  - ISO Speed setting 42
  - magnify 56
  - number remaining 29
  - number saved on memory
    - card 45, 46, 110
  - record audio clips 23
  - Red-eye Reduction setting 43
  - Resolution setting 44
  - rotate 56
  - Saturation setting 46
  - Self-Timer setting 38
  - Sharpness setting 47
  - too dark/light 32
  - unloading camera to
    - computer 67
  - White Balance setting 39
- Infinity focus light 12
- Infinity focus range
  - setting 30

## install

- batteries 16
  - memory card 16
  - software 19, 20
  - wrist strap 15
- ISO Speed, setting 42

## L

- Language
  - change setting 74
  - choose at first startup 18
- LEDs (lights) on camera
  - Auto Exposure/Auto Focus and Flash 11
  - Flash Off 13
  - Flash On 13
  - Infinity focus 12
  - Macro focus 12
  - Night flash 13
  - Power/Memory 10
  - Self-Timer 14
  - Video 11
- Live View
  - button 10
  - using 28
- lock focus 27

## M

- Macintosh computer
  - bonus software 20
  - connect to 67
  - install software 20
- Macro focus light 12
- Macro focus range
  - setting 30
- magnify image 56
- Manual White Balance,
  - setting 40

- memory card
  - Compression setting, effect of 46
  - delete images, audio only, or video clips 55
  - door 10
  - image capacity 45, 46, 110
  - install 16
  - pictures remaining 29
  - Resolution setting, effect of 45
- memory light 10
- Menu/OK button, description 10
- menus
  - Capture 36
  - list of 21
  - Playback 51
  - Setup 70
  - Share 60
- messages
  - on camera 84
  - on computer 91
- microphone, description 14

## N

- Night light, description 13
- NiMH batteries 101
- number of images on memory card 45, 46, 110

## O

- online Help for Capture menu options 37
- optical zoom 35
- over-exposing an image 32
- override automatic exposure 31

## P

- photo-lithium batteries 101
- Picture Transfer Protocol (PTP) 72
- pictures
  - record audio clips 23
  - share 59
  - take self-timer 25
  - take stills 22
- pictures remaining on memory card 29
- play audio or video clips 54
- Playback
  - Playback button 10
  - using 49
- Playback button, description 10
- Playback menu, using 51
- power
  - battery level icons 100
  - light 10
  - restoring previous settings 18
  - specifications 109
  - turn on/off 17
- power adapter, HP AC
  - connector on camera 15
  - purchasing 104
- Power ON/OFF switch, description 9
- Power/Memory light, description 10
- previous settings, restoring 18
- print images
  - directly from camera 68
  - from computer 68
  - using HP Instant Share 59
- printer, connect to camera 68
- problems, troubleshooting 75
- product support 93

## R

- range
  - Exposure Compensation 107
  - flash 106
  - F-number 105
  - focus 106
  - focus settings 30
- rechargeable batteries 102
- record
  - audio clips 23, 54
  - video clips 24
- Red-eye Reduction, setting 43
- remaining pictures on memory card 29
- Reset switch, using 83
- Resolution, setting 44
- restoring previous settings 18
- reviewing images and video clips 49
- rotate image 56

## S

- Saturation, setting 46
- Self-Timer light, description 14
- Self-Timer, setting 38
- settings, restoring previous 18
- Setup menu, using 70
- Share button, description 10
- Share menu
  - customize 62
  - description 60
  - e-mail service 62
  - printing options 61
  - using 60
- share pictures 59
- Sharpness, setting 47

## Shutter button

- description 12
- lock exposure and focus 26
- shutter speed range 106
- software, install 19, 20
- sounds of camera 71
- space remaining on memory card 29
- speaker, description 12
- specifications 105
- states of camera 21
- status screen 17
- still pictures, take 22
- support for users 93

## T

- technical support 93
- Time & Date, setting 18, 72
- tripod mount, description 15
- troubleshoot problems 75
- turn on/off
  - camera sounds 71
  - HP Instant Share 59
  - Live View 28
  - Playback 49
  - power 17
- TV (television) configuration, setting 73

## U

- under-exposing an image 32
- unload images, camera to computer 67
- USB
  - configuration setting 72
  - connector on camera 14

## V

Video button, description 12

video clips

delete 55

play 54

record 24

Video light, description 11

viewfinder lights (LEDs),

description 11

viewfinder, description 11

viewing images and video  
clips 49

## W

web sites for HP 93

White Balance, setting 39

Windows computer

bonus software 20

connect to 67

install software 19

working distance of flash 106

wrist strap

attaching to camera 15

mount on camera 9

## Z

zoom

specifications 105

use optical or digital 35

Zoom lever, description 9

Zoom Out and Zoom In

controls 9



[www.hp.com/photosmart](http://www.hp.com/photosmart)

Printed in China 2003



i n v e n t



Q2214-90154