



Startup and Reference Guide

HP Notebook Series

Document Part Number: 345561-001

September 2003

Part 1: Startup

The Startup part of this guide explains how to set up your notebook for the first time.

Part 2: Reference

The Reference part of this guide explains how to identify and use the hardware and software features on your notebook.

Contents

1 Startup

2 Hardware

3 Keyboard

4 Power

5 Drives and Drive Media

6 Multimedia

7 Communications

8 Hardware Options and Upgrades

**9 Software Updates, Restorations and
Utilities**

A Specifications

Index

Part 1

Startup

This *Startup and Reference Guide* provides information about setting up and using your notebook.

- To set up your notebook hardware and software for the first time, follow the procedures in this “Startup” part.
- To learn more about using your notebook, refer to the remaining “Reference” part of this book. To find information about a specific topic:
 - Refer to the chapter Contents on the first page of each chapter, or
 - Refer to the Index.

The illustrations throughout this book show the features and procedures for several notebook models. Whenever more than one notebook is illustrated, refer only to the illustration(s) for your notebook model.

Setting Up the Hardware

To set up the notebook for the first time, you need the notebook, the AC adapter ❶, the power cord ❷, and the battery pack ❸.

During hardware setup, you will:

- Insert the battery pack into the notebook, so the battery can begin to charge as soon as the notebook is connected to external power.
- Open the notebook.
- Connect the notebook to external power and turn on the notebook.

You will then proceed to software setup.

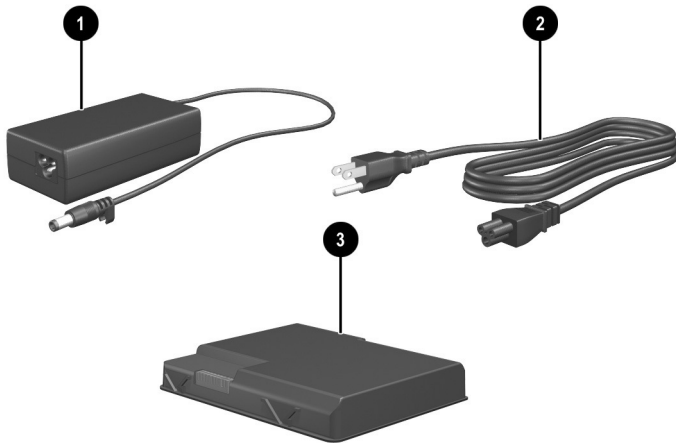

Identifying the AC adapter, the power cord, and the battery pack (Power cords vary by region and country.)

Inserting a Battery Pack

To insert the battery pack into the battery bay:

1. Turn the notebook underside up on a flat surface.
2. Insert the alignment tab on the battery pack into the alignment slot on the notebook ❶.
3. Tilt the battery pack downward until it snaps into place ❷.

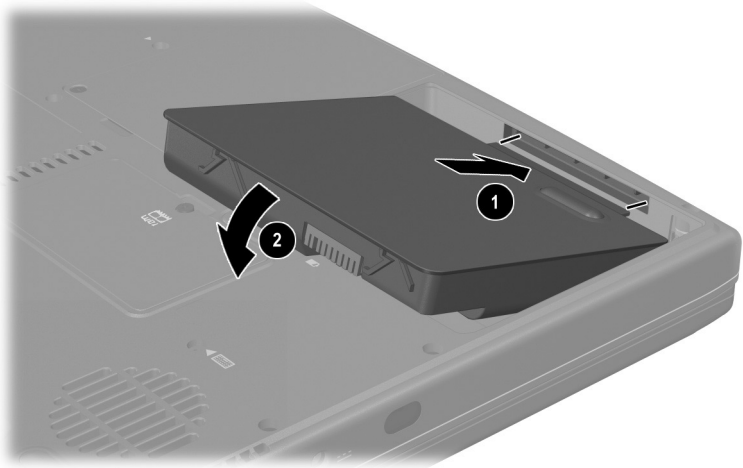

Inserting a battery pack



CAUTION: To ensure that the correct drivers load and to prevent file corruption or damage to components, do not remove the battery pack until the notebook has been connected to external AC power.

Opening the Notebook

To open the notebook:

1. Place the notebook display side up on a flat surface near an electrical outlet.
2. Slide the display release latch **1** as you raise the display **2**.

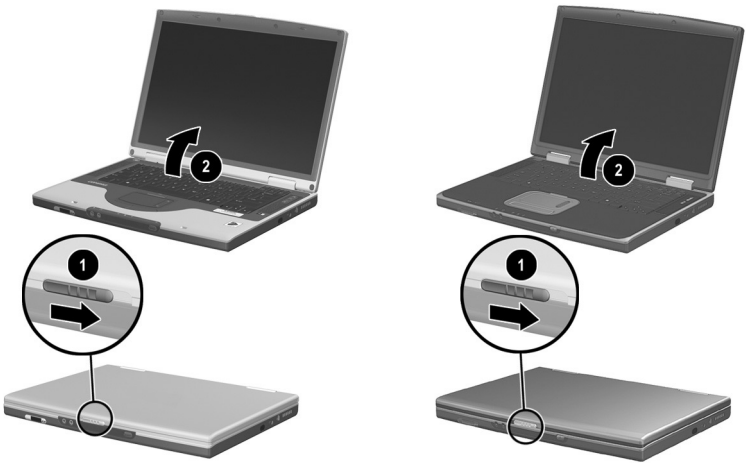

Opening the notebook

Connecting the Notebook to External Power

To connect the notebook to external AC power:

1. Plug the AC adapter cable into the power connector ❶.
2. Plug the power cord into the AC adapter ❷, then into an electrical outlet ❸.

When the notebook is receiving external power, the battery light ❹ turns on.

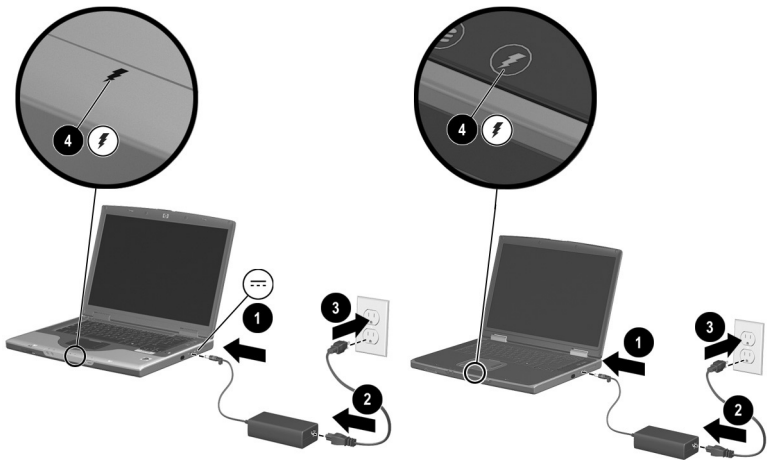

Connecting the notebook to external power (Power cords and outlets vary by region and country.)

Charging a New Battery Pack

The battery pack you inserted earlier begins to charge as soon as the notebook is connected to external power. Charge status is indicated by the battery light.

- The battery light is on and *orange* while a battery pack inserted into the notebook is charging.
- The battery light is on and *green* when a battery pack inserted into the notebook is fully charged.

HP recommends that you leave the notebook connected to external power until the battery pack is fully charged and the battery light turns green. (A partially charged new battery pack can run the notebook after initial software setup is complete, but battery charge displays will not be accurate until the new battery pack has been fully charged.)

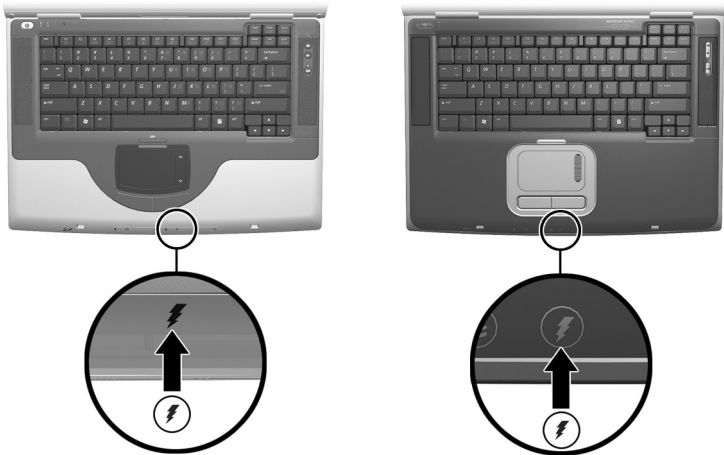

Identifying the battery light

Turning On the Notebook

To turn on the notebook, press the power button ❶. When the notebook turns on, the power/standby light ❷ turns on, and you are prompted to begin software setup.

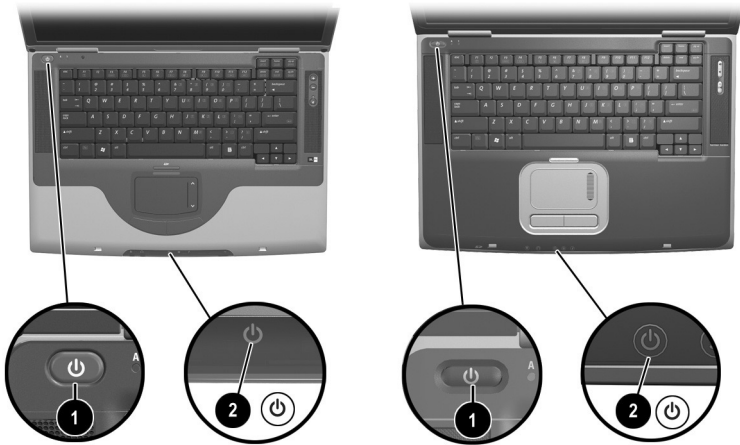

Turning on the notebook

If the notebook does not turn on:

- Make sure that the AC adapter is securely plugged into an electrical outlet.
- Make sure that the outlet is providing power. (To confirm that the outlet is providing power, plug another device into the outlet.)
- If you have installed a battery pack, make sure that the battery pack is firmly seated.
- Refer to the *Worldwide Telephone Numbers* booklet (English only) included with the notebook to contact an HP Customer Care Center.

Setting Up the Software



CAUTION: To prevent file corruption and ensure that the correct drivers are installed, install software only when the notebook is connected to external power through the AC adapter. During the installation:

- Do not unplug the notebook from external power.
 - Do not shut down the notebook or initiate Standby or Hibernation.
 - Do not insert, remove, connect, or disconnect any device, cable, or cord.
-

Installing Basic Software

When the notebook is connected to external power and turned on for the first time, a prompt to set up the operating system and other basic software is displayed on the screen.

Before responding to the prompt and proceeding through the on-screen instructions, read the following caution and other installation information.

- After beginning the software setup, you must complete the entire process without interruption. Setup time varies.
 - If you are prompted to select a language, choose carefully. On some models, the languages that you do not choose are deleted from the system and cannot be restored during the installation.
 - Regional settings and most other preferences that you may select as you set up the basic software can be selected or changed later, after the operating system is installed.
 - When you are prompted to accept the End User License Agreement, you must choose Accept to continue the software setup.
-



During setup, it is normal for some notebook models to pause occasionally for up to 2 minutes and to restart several times. These pauses and restarts occur only during initial software setup. They will not occur during standard Windows startups.

Installing Optional Software

Step-by-step instructions for installing and using many of the applications and utilities included with the notebook are provided later in this guide. If you prefer to install optional software now, the following information may be helpful.

To install an application or a utility from a CD, refer to the instructions included with the CD. If printed instructions are not included in the CD package, they may be displayed on the screen when the CD is inserted.

To view or install preloaded utilities or applications, select Start > All Programs > Software Setup. Then:

- To display the descriptions and space requirements of a preloaded item without installing it, select the Next button, then select an item. After viewing the information that is displayed, select the Cancel button.
- To install a preloaded item, select the check box for the item, select the Next button, then follow the instructions on the screen.

Setting Regional and Display Preferences

Keyboard language and other regional preferences, such as time, date, and currency format, are set in the Regional Options window of the operating system. To access the Regional Options window, select Start > Control Panel > Date, Time, Language and Regional Options icon.

Screen appearance settings are accessed from the operating system Appearance and Themes window. To access the Appearance and Themes window, select Start > Control Panel > Appearance and Themes icon. To access the settings that control the size of the items displayed on the screen, select the Change Resolution task.

Turning Off the Notebook

Turn off the notebook by using the Windows shutdown procedure: Select Start > Turn Off Computer > Turn Off.

If the notebook does not respond, try the following emergency shutdown procedures in the sequence provided:

- If the notebook is running Microsoft Windows XP Professional: press **ctrl+alt+delete**. Select the Shut Down button, then select Shut down from the drop down list.
- Press and hold down the power button for at least 4 seconds.
- Unplug the notebook from external power and remove the battery pack. For instructions see “Replacing a Battery Pack” in Chapter 4.

Setting Up a Wireless Device

Your notebook model may have a Bluetooth device, a wireless LAN device, or no wireless devices.

To display the names of any preinstalled wireless LAN devices in Device Manager: Select Start > My Computer. Right-click on the My Computer window, then select Properties > Hardware tab > Device Manager > Network Adapters.

Using the Wireless Device Light and Button

The wireless device light ❶ available on select models indicates whether integrated wireless devices have been turned on or off with the wireless device button ❷. The integrated wireless devices may include a Bluetooth device, another wireless device, or both wireless devices. An integrated wireless device must be turned on with the wireless device button before the wireless device can be set up.

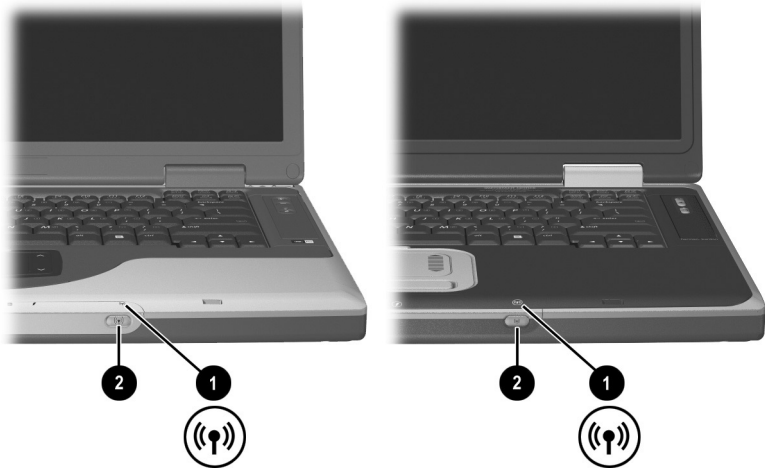

Identifying the wireless device light and button

- When the wireless device button is turned on, the wireless device light turns on and the integrated wireless devices are hardware enabled.
- When the wireless device button is turned off, the wireless device light turns off and the integrated wireless devices are hardware disabled.

The light remains on if either or both wireless devices are turned off by using the device software rather than by using the wireless device button.

Setting Up a Bluetooth Device

To set up a Bluetooth device, install the Bluetooth software preloaded on your notebook:

1. To enable the Bluetooth device and the software setup, press the wireless device button. (The wireless device light turns on.)
2. Select Start > All Programs > Software Setup. Select the Bluetooth software, then follow the setup instructions on the screen.

For more configuration information and usage instructions, refer on the *Documentation Library—Bluetooth* CD included with your notebook to the *Bluetooth Getting Started* guide and to the *Bluetooth User's Guide*.

Setting Up a Wireless Device

To set up an Integrated Wireless LAN 54g Network Adapter, follow the instructions at the HP Web site at <http://www.hp.com> for downloading and installing the SoftPaq for the Integrated Wireless LAN 54g Network Adapter. For general information about accessing, downloading, and installing a SoftPaq, see Chapter 9, in section “Updating Software.”

To set up any other wireless device, you may use the HP setup and configuration utility preloaded on your notebook or the default Windows XP wireless network connection utility.

The HP setup and configuration utility supports legacy operating systems and Cisco Compatible Extension program features. The Cisco Compatible Extensions program for WLAN devices assures compatibility between Cisco Aironet WLAN products and certain notebook models through extensive independent testing. Because a Cisco Compatible wireless device is IEEE 802.11 compliant and WiFi certified, it is fully compatible with other WiFi certified products.

For optimal wireless device functionality, HP recommends that you set up the device using the HP setup and configuration utility.

- To set up a wireless LAN device using the default Windows XP wireless network connection utility:
 1. Press the wireless device button. (The wireless device light turns on.)
 2. Follow the instructions available through Start > Windows Help and Support.
- To set up a wireless LAN device using the HP setup and configuration utility, you must first disable the Windows XP wireless network connection utility, then install the HP setup and configuration utility.
 1. To disable the Windows XP wireless network connection utility:
 - a. Select Start > Control Panel > Network and Internet Connections > Network Connections.
 - b. Right-click Wireless Network Connection, then select Properties.
 - c. On the Wireless Networks tab, clear the Use Windows to configure my wireless network settings check box.
 - d. Select OK.

The Windows XP wireless network connection utility remains disabled until you enable it again.

2. Press the wireless device button. (The wireless device light turns on.)
3. To install the HP setup and configuration utility: Select Start > All Programs > Software Setup > WLAN Utility Installer, then select OK.
4. To install and configure your wireless device, follow the installation and configuration instructions on the screen.

Accessing Instructions for Using a Wireless Device

Instructions for installing and using an Integrated Wireless LAN 54g Network Adapter are included with the Integrated Wireless LAN 54g Network Adapter SoftPaq available at the HP Web site at <http://www.hp.com>.

Instructions for any other integrated wireless device included with your model are provided with your notebook. Depending on the wireless device, the instructions may be provided in a Help file within the device software or in documentation included with your notebook.

Protecting the Notebook from Power Surges

To protect the notebook from the power surges that may be caused by an uncertain power supply or an electrical storm:

- Plug the notebook power cord into an optional, high-quality surge protector. Surge protectors are available from most computer or electronics retailers.
- Provide surge protection on the cable that connects a modem to the telephone line.
- During an electrical storm, run the notebook on battery power or shut down the notebook and disconnect the power cord.

Protecting the Notebook Against Viruses

When you use the notebook for email, network, or Internet access, you expose the notebook to computer viruses. Computer viruses can disable the operating system, your applications, or your utilities or cause them to function abnormally.

Antivirus software can detect most viruses, destroy them, and, in most cases, repair damage they have caused. To provide protection against newly discovered viruses, antivirus software must be updated.

The Norton AntiVirus 2003 software installed on your notebook provides 60 days of free virus updates.

For Norton AntiVirus 2003 instructions and more information about virus updates, refer to the Help file within the application or select Start > Help and Support.

Using the Notebook Safely

This equipment has been tested and found to comply with the limits for a Class B digital device, pursuant to part 15 of the FCC Rules.

For more safety and regulatory information refer to the *Regulatory and Safety Notices* guide on the *Documentation Library* CD and to the printed *Wireless Device Regulatory Notices* document included with your notebook. The *Regulatory and Safety Notices* guide also includes information about protecting the notebook against electrostatic discharge.



WARNING: To reduce the risk of electric shock or damage to your equipment:

- Plug the power cord into an electrical outlet that is easily accessible at all times.
 - Disconnect power from the product by unplugging the power cord from the electrical outlet.
 - If provided with a three-conductor power cord with a three-pin attachment plug, plug the cord into a grounded (earthed) outlet. Do not disable the power cord grounding pin. The grounding pin is an important safety feature.
-



WARNING: To reduce the risk of serious injury, read the *Safety & Comfort Guide*. It describes proper workstation setup and proper posture, health, and work habits for computer users. The *Safety & Comfort Guide* also provides important electrical and mechanical safety information. This guide is available on the Web at <http://www.hp.com/ergo>, on the hard drive, or on the *Documentation Library* CD that is included with the product.



WARNING: This notebook is designed to run demanding applications at full power. As a result of increased power consumption, it is normal for the notebook to feel warm or hot when used continuously. To avoid potential discomfort or burns, do not block the air vents or use the notebook on your lap for extended periods. The notebook complies with the user-accessible surface temperature limits defined by the International Standard for Safety of Information Technology Equipment (IEC 60950).

Part 2

Reference



Contents

| | |
|---|------|
| Display | 2-2 |
| Top | 2-3 |
| TouchPad | 2-3 |
| Keys and Antenna | 2-4 |
| Power Controls | 2-5 |
| Lights | 2-6 |
| Audio Buttons and Speakers | 2-7 |
| Front Panel | 2-8 |
| Rear Panel | 2-9 |
| Connectors and Jacks | 2-9 |
| Vent | 2-10 |
| Left Side | 2-11 |
| Right Side | 2-12 |
| Underside | 2-13 |
| Bays and Memory Compartment | 2-13 |
| Docking Connector and Vents | 2-14 |
| Labels | 2-15 |
| Additional Standard Components | 2-16 |
| Cables and Cord | 2-16 |
| Adapters and Battery Pack | 2-17 |
| Restoration and Documentation CDs | 2-18 |

Display

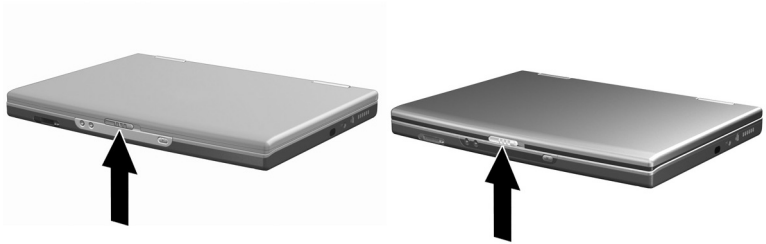

Display

Display release latch

Opens the notebook.

Top

TouchPad

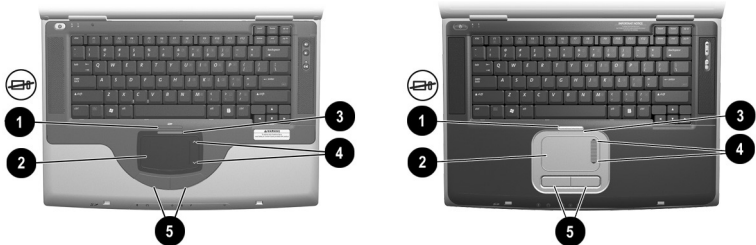

Top: TouchPad

| | | |
|---|----------------------------------|---|
| ❶ | TouchPad on/off button | Enables/disables the TouchPad. |
| ❷ | TouchPad* | Moves the pointer and selects or activates items on the screen. |
| ❸ | TouchPad light | On: TouchPad is enabled. |
| ❹ | TouchPad scroll zones (2)* | Scroll upward or downward. |
| ❺ | Left and right TouchPad buttons* | Function like the left and right buttons on an external mouse. |

*This table describes default settings. For information about changing the functions of TouchPad features, see “Setting TouchPad Preferences” in Chapter 3.

Keys and Antenna

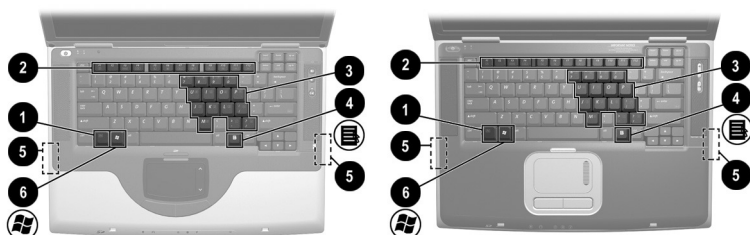

Top: Keys and Antenna

| | | |
|---|---|---|
| ❶ | Fn key | Combines with other keys to perform system tasks. For example, pressing Fn+F7 increases screen brightness. |
| ❷ | Function keys (12) | Perform system and application tasks. When combined with the Fn key, the function keys F1 and F3 through F12 perform additional tasks as hotkeys. |
| ❸ | Keypad keys (15) | Can be used like the keys on an external numeric keypad. |
| ❹ | Applications key | Displays a shortcut menu for items beneath the pointer. |
| ❺ | Antenna (available on select models and not visible from outside the notebook)* | Sends and receives wireless device signals. |
| ❻ | Windows logo key | Displays the Windows Start menu. |

*The notebook has 2 antennas. The second is on the right side of the notebook. For optimal transmissions, keep the areas immediately over the antennas free from obstructions.

Power Controls

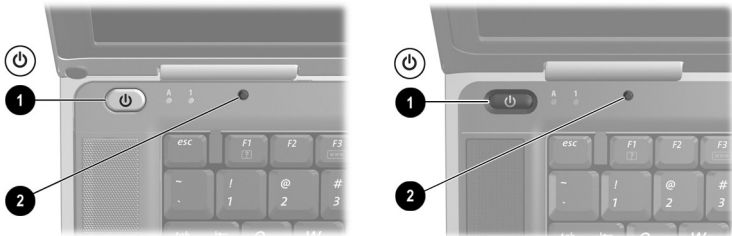

Top: Power Controls

1 Power button*

When the notebook is:

- Off, press to turn on the notebook.
- On, briefly press to initiate Hibernation.
- In Standby, briefly press to resume from Standby.
- In Hibernation, briefly press to restore from Hibernation.



If the system has stopped responding and Windows shutdown procedures cannot be used, press and hold for at least 4 seconds to turn off the notebook.

2 Display switch*

- If the notebook is closed while on, turns off the display.
 - If the notebook is opened while in Standby, turns on the notebook (resumes from Standby).
-

*This table describes default settings. For information about changing the function of the power button or display switch, see “Setting Power Control Preferences” in Chapter 4.

Lights

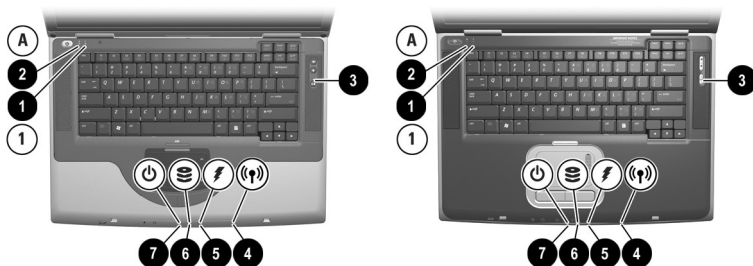

Top: Lights

| | | |
|----------|---|---|
| 1 | Num lock light | On (green): Num lock or the internal keypad is on. |
| 2 | Caps lock light | On (green): Caps lock is on. |
| 3 | Mute light | On (orange): Volume is muted. |
| 4 | Wireless device light (available on select models) | On: The wireless device button is turned on and an integrated wireless device is hardware enabled. |
| 5 | Battery light | On: The notebook is receiving adequate external power. <ul style="list-style-type: none"> ■ On orange: A battery pack is charging. ■ On green: A battery pack is fully charged. ■ Flashing: A battery pack is malfunctioning and may need to be replaced. |
| 6 | IDE (Integrated Drive Electronics) drive light | On: The internal hard drive or optical drive is being accessed. |
| 7 | Power/standby light | On: Notebook is turned on. Flashing: Notebook is in Standby. |

Audio Buttons and Speakers



Top: Audio Buttons and Speakers

| | | |
|---|------------------------|---------------------------|
| ❶ | Increase volume button | Increases system volume. |
| ❷ | Decrease volume button | Decreases system volume. |
| ❸ | Mute button | Mutes or restores volume. |
| ❹ | Stereo speakers (2) | Produce stereo sound. |

Front Panel

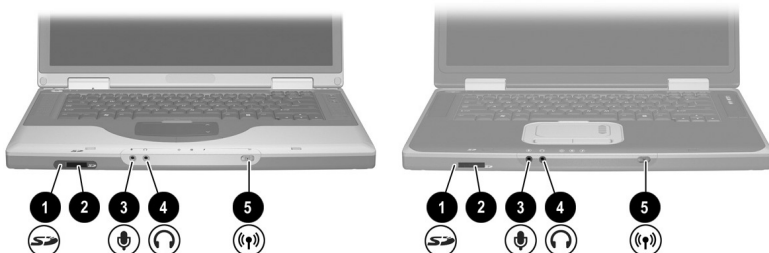

Front Panel

| | | |
|----------|---|---|
| 1 | SD (Secure Digital) Card light | On: An SD Card or MMC is being accessed. |
| 2 | SD Card slot | Supports SD Cards and MMCs (multimedia cards). |
| 3 | Microphone jack | Connects an optional monaural or stereo microphone. |
| 4 | Audio-out jack | Connects optional headphones or powered stereo speakers. Also connects the audio function of an audio/video device such as a television or VCR. |
| 5 | Wireless device button (available on select models) | On: The wireless device light is on and an integrated wireless device is hardware enabled. |

Rear Panel

Connectors and Jacks

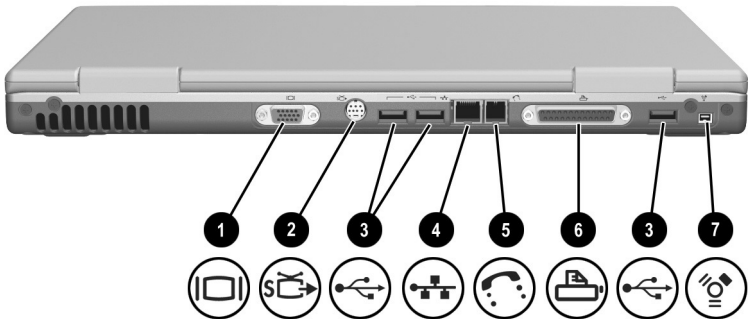

Rear Panel: Connectors and Jacks

| | | |
|---|---|--|
| ❶ | External monitor connector | Connects an optional VGA external monitor or projector. |
| ❷ | S-Video jack | Connects an optional S-Video device, such as a television, VCR, camcorder, projector, or video capture card. |
| ❸ | USB connectors (3) | Connect optional 2.0-compliant USB devices. |
| ❹ | RJ-45 network jack | Connects an Ethernet network cable. (An Ethernet network cable is included with select models.) |
| ❺ | RJ-11 telephone jack | Connects a modem cable. (A modem cable is included with select models.) |
| ❻ | Parallel connector (available on select models) | Connects an optional parallel device such as a printer. |
| ❼ | 1394 connector | Connects an optional 1394 device such as a camcorder. |

Vent



Rear Panel: Vent

Exhaust vent*

Provides airflow to cool internal components.



To prevent overheating, do not obstruct vents. Do not allow a hard surface, such as a printer, or a soft surface, such as pillows or thick rugs or clothing, to block airflow.

*The notebook has 3 vents. The other vents are on the underside of the notebook.

Left Side

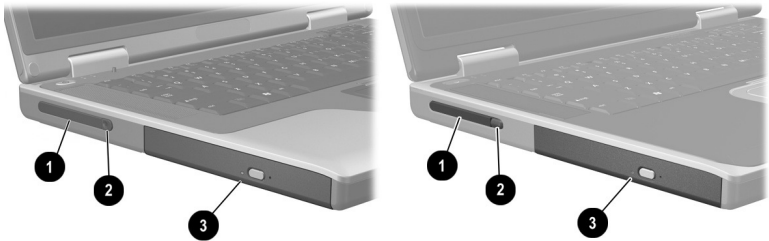

Left Side

| | | |
|---|----------------------|--|
| ❶ | PC Card slot | Supports an optional Type I or Type II 32-bit (CardBus) or 16-bit PC Card. |
| ❷ | PC Card eject button | Ejects an optional PC Card from the PC Card slot. |
| ❸ | Optical drive* | Supports an optical disc. |

*The type of optical drive, for example a CD, DVD, or combination CD/DVD drive, varies by model.

Right Side

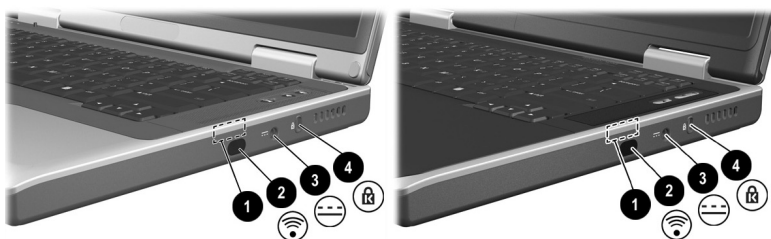

Right Side

| | | |
|---|---|---|
| ❶ | Antenna (available on select models and not visible from outside the notebook)* | Sends and receives wireless device signals. |
| ❷ | Infrared port | Provides wireless communication between the notebook and an optional IrDA-compliant device. |
| ❸ | Power connector | Connects an AC adapter cable. |
| ❹ | Security cable slot | Attaches an optional security cable to the notebook. |

*The notebook has 2 antennas. The second is on the left side of the notebook. For optimal transmissions, keep the areas immediately over the antennas free from obstructions.

Underside

Bays and Memory Compartment

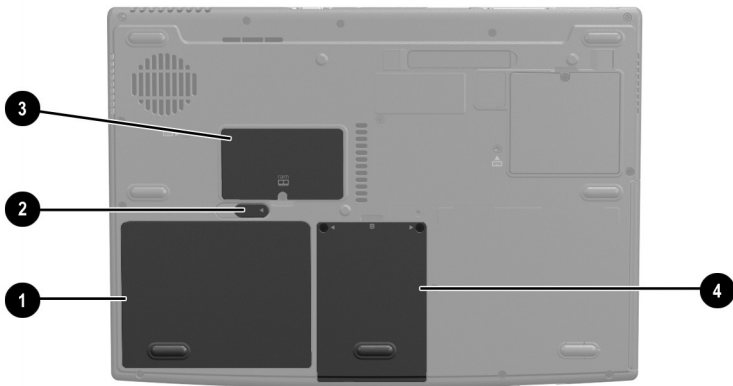

Underside: Bays and Memory Compartment

| | | |
|---|----------------------------|---|
| ❶ | Battery bay | Holds a battery pack. |
| ❷ | Battery pack release latch | Releases a battery pack from the battery bay. |
| ❸ | Memory compartment | Contains 1 memory slot for an optional 128-MB, 256-MB, 512-MB, or 1024-MB memory module. As shipped, the memory slot may be filled with a replaceable memory module or vacant, depending on the notebook model. |
| ❹ | Hard drive bay | Holds the internal hard drive. |

Docking Connector and Vents

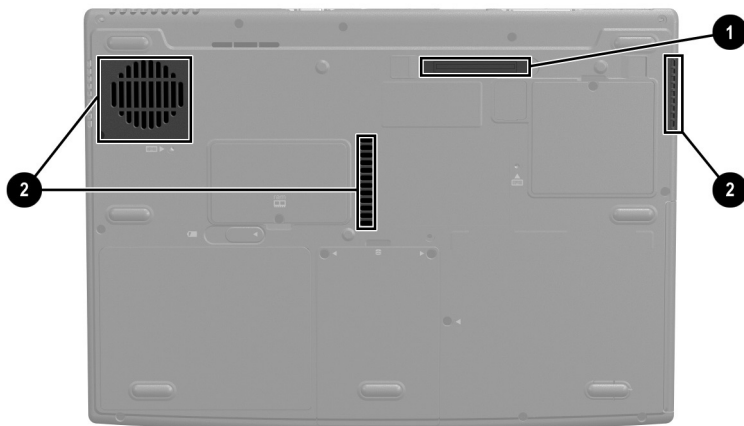

Underside: Docking Connector and Vent

- | | | |
|---|--------------------|---|
| ❶ | Docking connector* | Connects the notebook to an optional port replicator. |
| ❷ | Vents (3) | Allow airflow to cool internal components. |
-

⚠ To prevent overheating, use the notebook only on hard surfaces which cannot obstruct the vents. Do not allow a soft surface, such as bedding, clothing or a thick rug, to block airflow.

*As shipped, the docking connector is not visible. The docking connector is beneath the docking connector cover, which protects the connector when the connector is not in use.

Labels

The labels affixed to the notebook and some notebook components provide information you may need when troubleshooting system problems or traveling internationally with the notebook.

- The Microsoft Certificate of Authenticity label contains the Product Key number. You may need this number to update or troubleshoot the operating system.
- The system label provides regulatory information about the notebook.
- The product identification label contains the serial number of the notebook and a code describing the original configuration of the notebook. You will need the notebook serial number if you call customer support.
- The modem approvals label, which is affixed to an optional internal modem, provides regulatory information.
- Wireless certification labels, which are specific to various types of optional wireless devices, are affixed to the notebook and provide regulatory information.



Additional Standard Components

The components included with the notebook vary by region, country, notebook model, and the optional hardware ordered. The following sections identify the standard external accessories and components included with most notebook models.

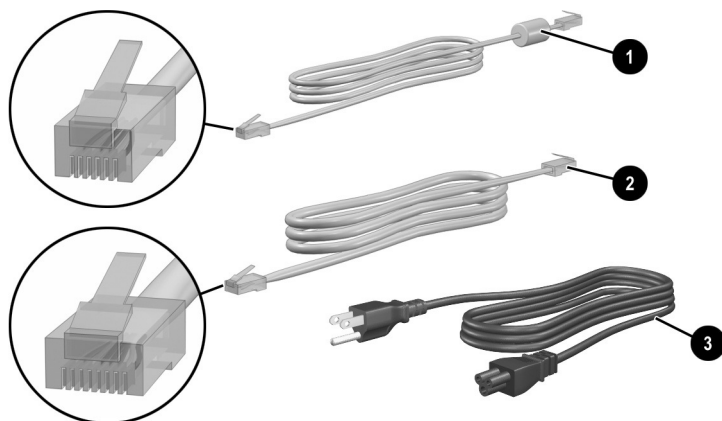
Cables and Cord



Additional Standard Components: Cables and Cord

- | | |
|--|---|
| 1 Modem cable (included with select models) | Connects a modem to an RJ-11 telephone jack or to a country-specific modem adapter. |
| <p> A modem cable has a <i>6-pin</i>, RJ-11 telephone connector at each end.</p> | |
| 2 Network cable (included with select models) | Connects the notebook to an Ethernet network jack. |
| <p> A network cable has an <i>8-pin</i>, RJ-45 network connector at each end.</p> | |
| 3 Power cord* | Connects an AC adapter to an AC electrical outlet. |

*Power cords vary in appearance by region and country.

Adapters and Battery Pack

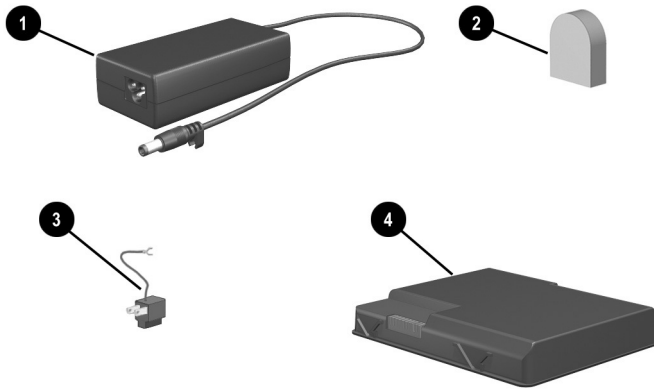

Additional Standard Components: Adapters and Battery Pack

| | | |
|---|---|---|
| ❶ | AC adapter | Converts AC power to DC power. |
| ❷ | Country-specific modem adapter (included by region as required) | Adapts the modem cable to a non-RJ-11 telephone jack. |
| ❸ | Japan-specific outlet adapter (Japan only) | Connects the AC adapter to a 2-prong electrical outlet. |
| ❹ | Battery pack | Runs the notebook when the notebook is not connected to external power. |

Restoration and Documentation CDs

CDs for repairing or reinstalling software and for obtaining supplementary information about the notebook are included with the notebook.

- For information about restoring, repairing, or reinstalling software, refer to Chapter 9, “Software Updates, Restorations and Utilities.”
- For supplementary information about the notebook, refer to the *Documentation Library* CD. The *Documentation Library* CD included with all models includes the following guides. Additional guides—for example, instruction manuals for using an optional Bluetooth device—are included with select models.

| For Information About These Topics | Select This Guide |
|---|---|
| <ul style="list-style-type: none"> ■ Caring for the notebook and drives ■ Preparing the notebook for transport ■ Traveling with the notebook internationally | <i>Maintenance, Shipping and Travel</i> |
| <ul style="list-style-type: none"> ■ Solving notebook problems yourself ■ Getting help | <i>Troubleshooting</i> |
| <ul style="list-style-type: none"> ■ Governmental and safety information ■ Protecting the notebook from static electricity | <i>Regulatory and Safety Notices</i> |
| Ergonomic and safety information | <i>Safety & Comfort Guide</i> |
| General instructions for using modem AT commands | <i>Modem Command Guidelines (Advanced Users Only)</i> |
| AT commands supported by an Agere modem. (An optional internal modem supports the Agere command set.) | <i>Agere Command Set (Advanced Users Only)*</i> |
| *Available in English only. | |

Contents

| | |
|--|------|
| TouchPad | 3-2 |
| Identifying TouchPad Components | 3-2 |
| Using the TouchPad | 3-3 |
| Setting TouchPad Preferences | 3-3 |
| Hotkeys | 3-4 |
| Identifying Hotkeys | 3-4 |
| Hotkey Quick Reference | 3-5 |
| Hotkey Procedures | 3-6 |
| Hotkey Commands | 3-6 |
| Keypad | 3-9 |
| Turning the Keypad On and Off | 3-10 |
| Switching the Functions of Keypad Keys | 3-10 |

TouchPad

Identifying TouchPad Components

The TouchPad includes the following components:

- ❶ TouchPad
- ❷ Left and right TouchPad buttons
- ❸ TouchPad scroll zones (2)
- ❹ TouchPad on/off button
- ❺ TouchPad light

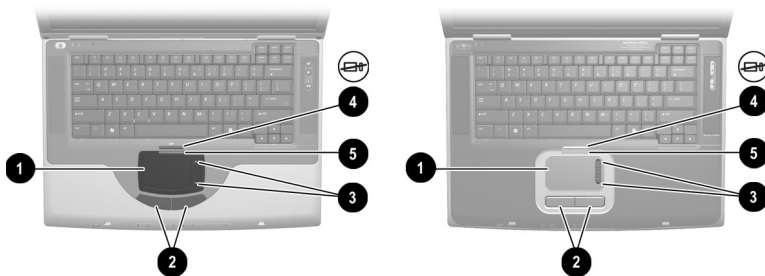

Identifying TouchPad components

Using the TouchPad

The TouchPad provides the navigation, selection, and scroll functions of an optional external mouse.

- To move the pointer, slide your finger across the TouchPad surface in the direction you want to move the pointer.
- If the pointer continues to move after you lift your finger from the TouchPad surface, wait a few seconds and the pointer will stop moving.
- To execute the click functions of the left or right button on an external mouse, press the left or right TouchPad button.
- To scroll upward, press the icon in the upward scroll zone. To scroll downward, press the icon in the downward scroll zone.
- To enable or disable the TouchPad, press the TouchPad button. When the TouchPad is enabled, the TouchPad light is on.

The notebook turns on with the TouchPad enabled. Users who work with keystrokes rather than mouse actions may prefer to disable the TouchPad to prevent accidental TouchPad activity.

Setting TouchPad Preferences

Pointer speed and shape, click speed, mouse trails, and other pointing device preferences are set in the operating system Mouse Properties window. To access Mouse Properties, select Start > Control Panel > Printers and Other Hardware icon > Mouse icon.

Hotkeys

Identifying Hotkeys

Hotkeys are preset combinations of the **Fn** key **1** and one of the function keys **2**.

The icons on the function keys **F1** and **F3** through **F12** represent the hotkey functions available on the notebook.

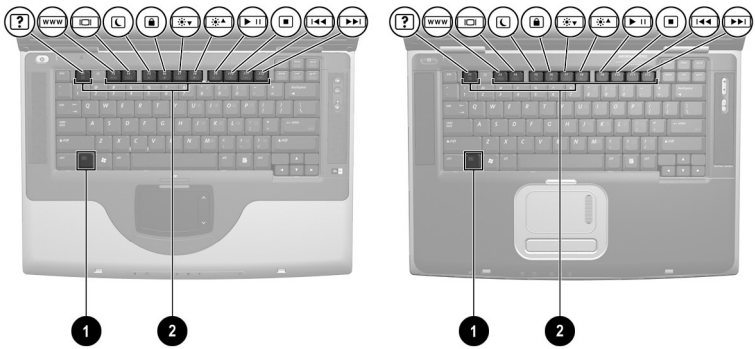

Identifying hotkeys

Hotkey Quick Reference

The following table identifies the default hotkey functions. For information about changing the function of the **Fn+F5** hotkeys, see the “Setting Power Control Preferences” section in Chapter 4.

| Default Function | Hotkeys |
|---|----------------|
| Open Help and Support window. | Fn+F1 |
| Open Microsoft Internet Explorer. | Fn+F3 |
| Switch display and image. | Fn+F4 |
| Initiate Standby. | Fn+F5 |
| Initiate QuickLock. | Fn+F6 |
| Decrease display brightness. | Fn+F7 |
| Increase display brightness. | Fn+F8 |
| Play, pause, or resume an audio CD or DVD. | Fn+F9 |
| Stop an audio CD or DVD. | Fn+F10 |
| Play the previous track or chapter on an audio CD or DVD. | Fn+F11 |
| Play the next track on an audio CD or DVD. | Fn+F12 |

Hotkey Procedures

To use a hotkeys command on the notebook keyboard, use either of the following procedures:

- Briefly press the **Fn** key, then briefly press the second key of the hotkeys command.
- Press and hold down the **Fn** key, briefly press the second key of the hotkeys command, then release both keys at the same time.

Hotkey Commands

Open Help and Support Window (**Fn+F1**)

The **Fn+F1** hotkeys open the Help and Support window. From the Help and Support window you can access general information about your notebook, links to software updates and online technical support specialists, and other support features.

For more information about the Help and Support window, see the “Using the Help and Support Window” section in Chapter 9, “Software Updates, Restorations and Utilities.”

Open Internet Explorer (**Fn+F3**)

The **Fn+F3** hotkeys open Internet Explorer. After you have set up your Internet or network services and your Internet Explorer home page, you can use the **Fn+F3** hotkeys for quick access to your home page and the Internet.

Switch Image (**Fn+F4**)

The **Fn+F4** hotkeys switch the image among display devices connected to the external monitor connector or the S-Video jack on the notebook. For example, if an external monitor is connected to the notebook, pressing the **Fn+F4** hotkeys switches the image among the notebook display, the external monitor display, and a simultaneous display on both the notebook and the monitor.

Initiate Standby (Fn+F5)

The **Fn+F5** hotkeys are set by default to initiate Standby. Standby can be initiated only while the notebook is on. If the notebook is in Hibernation, you must restore from Hibernation before you can initiate Standby.

To restore from Hibernation or resume from Standby, briefly press the power button. For more information about using Standby and Hibernation, refer to Chapter 4, “Power.”

For information about changing the function of the **Fn+F5** hotkeys, refer in Chapter 4 to the “Setting Power Control Preferences” section.

Initiate QuickLock (Fn+F6)

The **Fn+F6** hotkeys initiate the operating system QuickLock security feature. The QuickLock feature disables the keyboard and displays the log on screen. QuickLock does not disable the TouchPad.

Before you can use the QuickLock feature, you must set a Windows system password. For instructions, refer to your operating system documentation.

After you have set a Windows system password:

- To initiate QuickLock, press **Fn+F6**.
- To exit QuickLock, enter your Windows system password.

Decrease Brightness (Fn+F7)

The **Fn+F7** hotkeys decrease notebook screen brightness.

Increase Brightness (Fn+F8)

The **Fn+F8** hotkeys increase notebook screen brightness.

Play, Pause, or Resume an Audio CD or DVD (Fn+F9)

The **Fn+F9** hotkeys function only when an audio CD or DVD is inserted. If the audio CD or DVD is

- Not playing, press the **Fn+F9** hotkeys to begin or resume the play.
- Playing, press the **Fn+F9** hotkeys to pause the play.

Stop an Audio CD or DVD (Fn+F10)

The **Fn+F10** hotkeys stop the play of an audio CD or DVD that is playing.

Play Previous Track of an Audio CD or DVD (Fn+F11)

The **Fn+F11** hotkeys play the previously played track of an audio CD or DVD that is playing.

Play Next Track of an Audio CD or DVD (Fn+F12)

The **Fn+F12** hotkeys play the next track of an audio CD or DVD that is playing.

Keypad

The keypad consists of 15 keys that can be used like the keys on an external keypad. When the keypad is turned on, each keypad key performs the functions indicated by the icon in the upper right corner of the key.



Identifying the keypad keys

Turning the Keypad On and Off

When the keypad is off, press **Fn+num lk** ❶ to turn the keypad on. When the keypad is on, press **Fn+num lk** to turn the keypad off. The num lock light ❷ turns on when the keypad is on.

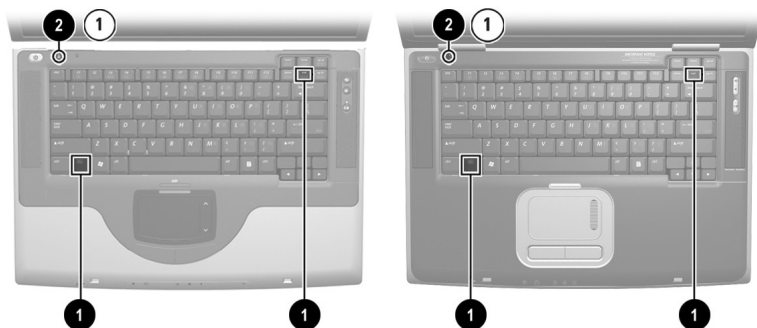

Identifying the Fn and num lk keys and the num lock light

Switching the Functions of Keypad Keys

You can temporarily switch the functions of a keypad key between its standard function and its keypad function.

- To use a key on the keypad as a keypad key while the keypad is turned off, press and hold **Fn** while pressing the key.
- To use a key on the keypad as a standard key while the keypad is turned on:
 - ❑ Press and hold **Fn** to type with the key in lowercase.
 - ❑ Press and hold **Fn+shift** to type with the key in uppercase.

Releasing the **Fn** key returns a keypad key to its set function. For example, a keypad key returns to its keypad function if the keypad is turned on or to its standard function if the keypad is turned off.

Contents

| | |
|---|------|
| Understanding Standby, Hibernation and Shutdown . . . | 4-2 |
| Standby | 4-2 |
| Hibernation | 4-2 |
| Shutdown | 4-3 |
| Choosing Standby, Hibernation or Shutdown | 4-4 |
| Using Standby, Hibernation and Shutdown Procedures | 4-5 |
| Identifying Power Controls and Indicators | 4-5 |
| Turning the Notebook or Display On or Off | 4-6 |
| Using Emergency Shutdown Procedures | 4-6 |
| Initiating or Resuming from Standby | 4-7 |
| Initiating or Restoring from Hibernation | 4-8 |
| Setting Power Control Preferences | 4-9 |
| Using Battery Power | 4-10 |
| Identifying the Battery and Power/Standby Lights | 4-10 |
| Switching Between Battery and External Power . . . | 4-11 |
| Charging a Battery Pack | 4-11 |
| Monitoring the Charge in a Battery Pack | 4-12 |
| Managing Low-Battery Conditions | 4-13 |
| Calibrating a Battery Pack | 4-14 |
| Storing a Battery Pack | 4-16 |
| Battery Conservation Settings and Procedures | 4-17 |
| Replacing a Battery Pack | 4-18 |
| Recycling or Disposing of a Used Battery Pack | 4-19 |

Understanding Standby, Hibernation and Shutdown

This section describes Standby, Hibernation, and shutdown and explains when to implement them. Standby, Hibernation, and shutdown procedures are provided later in the chapter. Standby and Hibernation are energy-saving features that can be initiated by you or by the system.

Standby

Standby reduces power to system components that are not in use. When Standby is initiated, your work is saved in random access memory (RAM) and the screen is cleared.

- Saving your work before initiating Standby is not usually necessary, but is a recommended precaution.
- When the notebook is in Standby, the power/standby light flashes.

When you resume from Standby, your work returns to the screen where you left off.

Hibernation

Hibernation saves system memory to the hard drive, takes a snapshot of the notebook image, then shuts down the notebook. When you resume from Hibernation, your work returns to the screen exactly as you left it.

The following information may be useful as you manage Hibernation:

- Saving your work before initiating Hibernation is not usually necessary, but is a recommended precaution.

- To determine whether the notebook is in Hibernation or turned off, press the power button:
 - ❑ If the notebook is in Hibernation, your work returns to the screen.
 - ❑ If the notebook is off, Windows loads.
- Hibernation is enabled by default, but can be disabled. To prevent loss of work during a critical low-battery condition, disable Hibernation only during a battery pack calibration.

To verify that Hibernation is enabled, select Start > Control Panel > Performance and Maintenance > Power Options icon > Hibernate tab. If Hibernation is enabled, the Enable Hibernation check box is selected.



CAUTION: If the configuration of the notebook system is changed during Hibernation, it may not be possible to resume from Hibernation. When the notebook is in Hibernation:

- Do not add or remove a memory module.
 - Do not connect or disconnect an external device.
 - Do not insert or remove a CD, DVD, PC Card, SD Card, or MMC.
-

Shutdown

Shutdown procedures turn off the notebook. Whether to leave a battery pack in the notebook or in storage depends on how you work:

- Leaving the battery pack in the notebook enables the battery pack to charge whenever the notebook is connected to external power and also protects your work during a power outage.
- A battery pack in the notebook discharges more quickly, even when the notebook is turned off, than a battery pack that has been removed from the notebook and stored in a cool, dry location.

Choosing Standby, Hibernation or Shutdown

If you plan to resume shortly: Initiate Standby for shorter times and Hibernation for longer times or power conservation.

The amount of time a battery pack can support Standby or Hibernation or hold a charge varies by notebook configuration and the condition of the battery pack.

- Initiating Standby clears the screen, uses less power than leaving the notebook on, and your work returns quickly to the screen when you resume from Standby. A fully charged new battery pack can typically support Standby for up to 48 hours.
- Initiating Hibernation clears the screen and uses much less power than Standby. Returning to work saved in Hibernation takes longer than returning to work saved in Standby, but is faster than returning to your place manually after restarting the notebook. A fully charged new battery pack can typically support Hibernation for several weeks.

If you plan to resume within 2 weeks: Shut down the notebook. If possible, connect the notebook to external power to keep an inserted battery pack fully charged.

If the notebook will be disconnected from external power for more than 2 weeks: To extend the life of an inserted battery pack, shut down the notebook. Remove the battery pack and store it in a cool, dry location.

If an external power supply is uncertain, for example, because of an electrical storm, save your work, then initiate Hibernation or shut down the notebook.

Using Standby, Hibernation and Shutdown Procedures

This section explains the default Standby, Hibernation, and shutdown procedures and includes information about turning the display on or off.

Identifying Power Controls and Indicators

Standby, Hibernation, shutdown, and display procedures use the following controls and indicators:

- ❶ Power button
- ❷ Display switch
- ❸ Fn+F5 hotkeys (to initiate Standby)
- ❹ Power/standby light

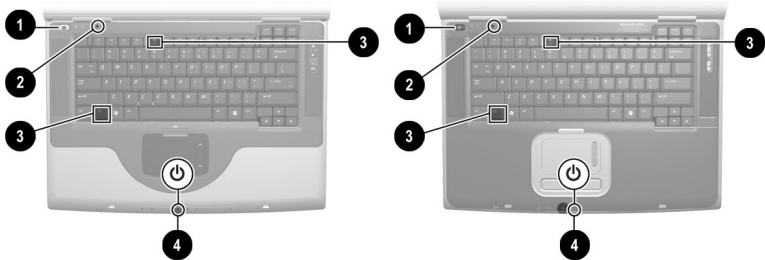

Identifying Standby, Hibernation, shutdown, and display controls and indicators

Turning the Notebook or Display On or Off

| Task | Procedure | Results |
|---|--|---|
| Turn on the notebook. | Press the power button.  Pressing the power button turns on the notebook from Standby, Hibernation, or shutdown. | <ul style="list-style-type: none"> ■ Power/standby light turns on. ■ Operating system loads. |
| Shut down the notebook.* | Select Start > Turn Off Computer > Turn Off. | <ul style="list-style-type: none"> ■ Power/standby light turns off. ■ Operating system shuts down. ■ Notebook turns off. |
| Turn off the display when the notebook is closed. | Close the notebook. | When the notebook is closed, the display presses the display switch, which then turns off the display. |

*If the system is unresponsive, and you are unable to shut down the notebook with this procedure, see “Using Emergency Shutdown Procedures” next in this section.

Using Emergency Shutdown Procedures



If the notebook does not respond to the Windows shutdown procedure (Start > Turn Off Computer > Turn Off), try the following emergency shutdown procedures in the sequence provided:

- If the notebook is running Windows XP Professional: Press **ctrl+alt+delete**. Select the Shut Down button, then select Shut down from the drop down list.
- Press and hold down the power button for at least 4 seconds.
- Unplug the notebook from external power and remove the battery pack. For battery pack removal instructions see the “Replacing a Battery Pack” section, later in this chapter.

Initiating or Resuming from Standby

| Task | Procedure | Result |
|---|--|---|
| User-initiated Standby | <p>With the notebook on, use either of the following procedures:</p> <ul style="list-style-type: none"> ■ Press the Fn+F5 hotkeys. ■ Select Start > Turn off Computer > Stand by. | <ul style="list-style-type: none"> ■ Power/standby light flashes. ■ Screen clears. |
| System-initiated Standby | <p>If the notebook is running on external power, the system does not initiate Standby.</p> <hr/> <p>If the notebook is running on battery power, the system initiates Standby after 10 minutes of notebook inactivity.</p> | <ul style="list-style-type: none"> ■ Power/standby light flashes. ■ Screen clears. |
| Resume from user-initiated or system-initiated Standby. | <ul style="list-style-type: none"> ■ Briefly press the power button, or move (or click any button on) an optional external USB mouse. ■ If the display was closed while the notebook was in Standby, open the display. | <ul style="list-style-type: none"> ■ Power/standby light turns on. ■ Your work returns to the screen. |

Initiating or Restoring from Hibernation

| Task | Procedure | Result |
|--|--|---|
| User-initiated Hibernation | <p>With the notebook on, use either of the following procedures:</p> <ul style="list-style-type: none"> ■ Briefly press the power button. ■ Select Start > Shut Down > Hibernate. (If the Hibernate option is not displayed, press and hold shift.) <p> If the notebook is in Standby, you must resume from Standby before you can initiate Hibernation.</p> | <ul style="list-style-type: none"> ■ Power/standby light turns off. ■ Screen clears. |
| System-initiated Hibernation | <p>If the notebook is running on external power, the system does not initiate Hibernation.</p> <hr/> <p>If the notebook is running on battery power, the system initiates Hibernation:</p> <ul style="list-style-type: none"> ■ After 30 minutes of notebook inactivity, or ■ When an inserted battery pack reaches a critical low-battery condition (1 percent of a full charge remaining). | <ul style="list-style-type: none"> ■ Power/standby light turns off. ■ Screen clears. |
| Restore from user-initiated or system-initiated Hibernation. | <p>Press the power button.</p> <p> If the system initiated Hibernation because of a critical low-battery condition, connect external power or insert a charged battery pack before you press the power button.</p> | <ul style="list-style-type: none"> ■ Power/standby light turns on. ■ Your work returns to the screen. |

Setting Power Control Preferences

By default, when the notebook is on:

- Briefly pressing the power button initiates Hibernation.
- Pressing the **Fn+F5** hotkeys, called the “sleep button” in the operating system, initiates Standby.
- The display switch turns off the display. The display switch is activated by closing the display. (At default and all custom settings, the display switch also turns on the notebook if the display is opened while the notebook is in Standby.)

To change the function of the power button, the **Fn+F5** hotkeys, or the display switch:

1. Select Start > Control Panel > Performance and Maintenance icon > Power Options icon > Advanced tab.
 - ❑ To change the power button function, select a function from the drop-down list for When I Press The Power Button On My Computer.
 - ❑ To change the function of the **Fn+F5** hotkeys, select a function from the drop-down list for When I Press The Sleep Button On My Computer.
 - ❑ To change the display switch function, select a function from the drop-down list for When I Close The Lid Of My Portable Computer.
2. Select the OK button.

The Hibernate function is available in the power button, sleep button, and display switch drop-down lists only if Hibernation is enabled.

Using Battery Power

Identifying the Battery and Power/Standby Lights

Battery pack procedures refer to the:

- ❶ Power/standby light
- ❷ Battery light

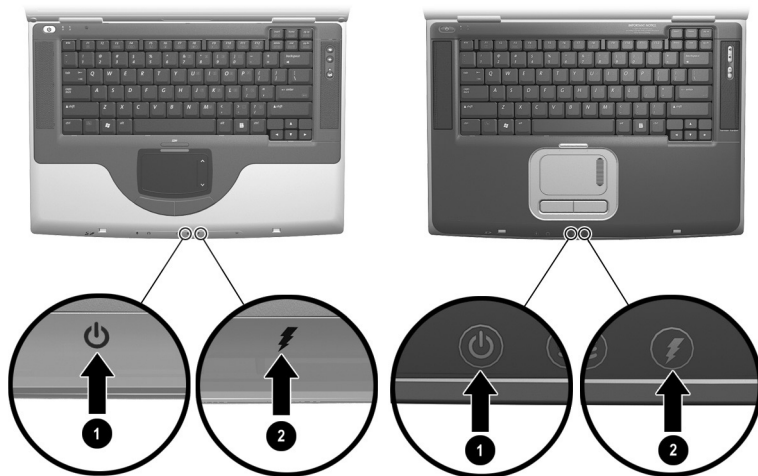

Identifying the battery and power/standby lights

Switching Between Battery and External Power

The notebook switches between external power and battery power according to the availability of external power. To conserve the charge in an inserted battery pack, the notebook runs on external power whenever external power is available. External power can be supplied from an electrical outlet through an AC adapter or an optional DC cable.

If the notebook contains a charged battery pack and is running on external power, the notebook switches to battery power only if the AC adapter or DC cable is disconnected from the notebook.

The Power Meter icon in the system tray changes shape whenever the power source changes between battery power and external power.

Charging a Battery Pack

The battery pack charges whenever the notebook is connected to external power through an AC adapter or an optional DC cable.

The battery pack charges whether the notebook is turned off or turned on, but charges most quickly when the notebook is turned off. When the notebook is turned on, charging times are longer and vary with system activity.

The battery light displays charge status:

- On and orange: the battery pack is charging.
- On and green: the battery pack is fully charged.
- Flashing: the battery pack is malfunctioning and may need to be replaced.

Monitoring the Charge in a Battery Pack

Obtaining Accurate Charge Information

To increase the accuracy of all battery charge displays:

- Allow the battery pack to discharge to less than 10 percent of a full charge through normal use before charging it.
- Charge the battery pack fully. Even a new battery pack can display charge information inaccurately if it has not been fully charged.
- If a battery pack has not been used for one month or more, the battery pack may need to be calibrated.

Displaying Charge Information

To display battery charge information on the screen, use the operating system Power Meter feature. To access Power Meter displays, select Start > Control Panel > Performance and Maintenance icon > Power Options icon > Power Meter tab.

Power Meter displays battery status in both percent and time:

- The percent indicates the amount of charge remaining in the battery pack.
- The time indicates the approximate running time remaining on the battery pack *if the battery pack continues to provide power at the current level*. For example, the time remaining will decrease if you start playing a DVD and will increase if you stop playing a DVD.

Managing Low-Battery Conditions

The information in this section describes default alerts and system responses.

Identifying Low-Battery Conditions

When the battery pack is the only power source for the notebook and drops to 10 percent of a full charge, the notebook has reached a *low-battery condition*. A text warning message appears on the screen.

If a low-battery condition is not resolved and the amount of charge remaining in the battery pack continues to drop, the notebook eventually enters a *critical low-battery condition*. Then, if the notebook is on or in Standby:

- If Hibernation is enabled, the system initiates Hibernation. Unsaved work may be lost.
- If Hibernation is disabled, the notebook remains briefly in Standby, then shuts down. The power/standby light turns off, and the notebook cannot save system memory to the hard drive.

Resolving Low-Battery Conditions



CAUTION: If the notebook has reached a critical low-battery condition and has begun to initiate Hibernation, do not restore power until Hibernation is complete. When Hibernation is complete, the power/standby light turns off.

If external power is available, connect the notebook to the external power source.

If a charged battery pack is available, shut down the notebook or initiate Hibernation. Insert a charged battery pack, then turn on the notebook.

If no power source is available, save your work. Then initiate Hibernation or shut down the notebook.

Calibrating a Battery Pack

When to Calibrate

Even if a battery pack is heavily used, it should not be necessary to calibrate it more than once a month. It is not necessary to calibrate a new battery pack before first use. Calibrate the battery pack under the following conditions:

- When battery charge displays seem inaccurate.
- When you observe a significant change in battery run time.
- When the battery pack has not been used for one month or more.

How to Calibrate

To calibrate a battery pack, you must fully charge, fully discharge, then fully recharge the battery pack.

Charging the Battery Pack

Charge the battery pack while the notebook is in use. To charge the battery pack:

1. Insert the battery pack into the notebook. For instructions, see “Replacing a Battery Pack” later in this chapter.
2. Connect the notebook to external power. (The battery light is on and orange as the battery pack charges.)
3. Leave the notebook connected to external power until the battery pack is fully charged. (The battery light turns green.)

Discharging the Battery Pack

Before you begin the full discharge, disable Hibernation. To disable Hibernation, select Start > Control Panel > Performance and Maintenance > Power Options > Hibernate tab. Then clear the Enable Hibernation check box.

If you use the notebook occasionally during the discharge procedure and have set energy-saving timeouts, expect the following performance from your system during the discharge process:

- The monitor will not turn off automatically.
- Hard drive speed will not decrease automatically while the notebook is idle.
- System-initiated Standby will not occur.



CAUTION: If you plan to leave the notebook unattended during discharge, save your work before starting the discharge procedure.

To fully discharge the battery pack:

1. Select the power icon on the taskbar or select Start > Control Panel > Performance and Maintenance icon > Power Options icon > Power Schemes tab.
2. Record all settings in the Plugged In column and all settings in the Running On Batteries column, so you can reset them after calibration.
3. Use the drop-down lists to set each item in both columns to Never.
4. Select the OK button.
5. Disconnect the notebook from the external power source, but do *not* turn off the notebook.
6. Run the notebook on battery power until the battery pack is fully discharged. When the battery pack is fully discharged, the battery light turns off and the notebook shuts down.

Recharging the Battery Pack

1. Connect the notebook to external power and keep the notebook connected until the battery pack is fully recharged and the battery light turns green.

You can use the notebook while the battery pack is recharging, but the battery pack will charge faster if the notebook is turned off.

2. Select the Power icon on the taskbar or select Start > Control Panel > Performance and Maintenance icon > Power Options icon > Power Schemes tab.
3. Reenter the settings you recorded for the items in the Plugged In column and the Running on Batteries column.
4. Select the OK button.



CAUTION: After calibrating the battery pack, reenable Hibernation: select Start > Control Panel > Performance and Maintenance > Power Options > Hibernate tab, then select the Enable Hibernation check box.

Storing a Battery Pack

If the notebook will be unused and unplugged for more than 2 weeks, remove and store the battery pack.



CAUTION: To prevent damage to a battery pack, do not expose it to high temperatures for extended periods of time.

High temperatures, which may be present in parked cars or some workplaces, accelerate the self-discharge rate of a stored battery pack. To prolong the charge of a stored battery pack, place it in a location that is cool and dry.

To maintain the accuracy of battery charge displays, calibrate a battery pack that has been stored for one month or more before using it.

Battery Conservation Settings and Procedures

Using the following battery conservation settings and procedures extends the run time of a battery pack.

- Turn off wireless and local area network (LAN) connections and exit modem applications when you are not using them.
- Disconnect from the notebook any external devices that use power from the notebook. Battery run time is not affected by external devices that are plugged into an external power source.
- Stop or remove a PC Card you are not using.
- Disable or remove an SD (Secure Digital) Card or MMC (multimedia card) you are not using.
- Lower screen brightness. Screen brightness can be lowered by pressing the **Fn+F7** hotkeys.
- Lower system volume. Volume can be lowered with the decrease volume button.
- Turn off a device connected to the S-Video connector. A device connected to the S-Video connector can be turned off by using the **Fn+F4** hotkeys to switch the image from the S-Video device to the notebook display.
- If you leave your work, initiate Standby or Hibernation or shut down the notebook.
- Select a short wait time, 5 minutes or less, for the monitor timeout. To change monitor timeout settings, select Start > Control Panel > Performance and Maintenance icon > Power Options icon > Power Meter tab. Select a short wait time from the Turn Off Monitor drop-down list, then select OK.

Replacing a Battery Pack



CAUTION: To prevent loss of work when removing a battery pack that is the only power source, initiate Hibernation or turn off the notebook before removing the battery pack.

To replace the battery pack:

1. Turn the notebook underside up.
 - ❑ To remove a battery pack, slide the battery release latch **1**. (The battery pack tilts upward.) Then pull the battery pack out of the battery bay **2**.

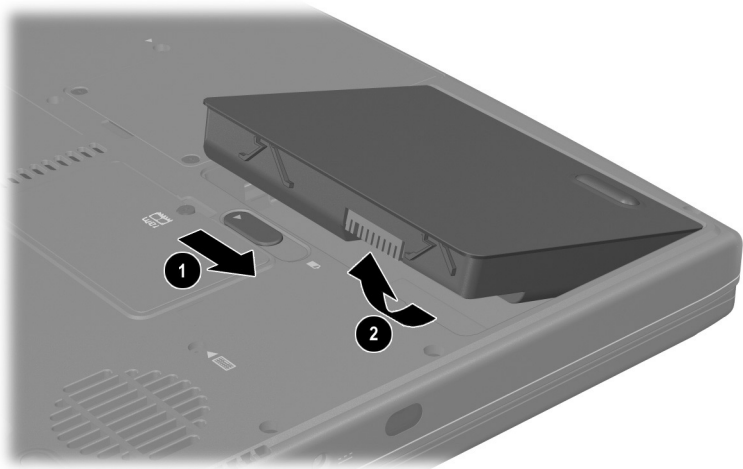

Removing a battery pack

- ❑ To insert a battery pack, insert the alignment tab on the battery pack into the alignment slot on the notebook ❶, then tilt the battery pack downward until it snaps into place ❷.

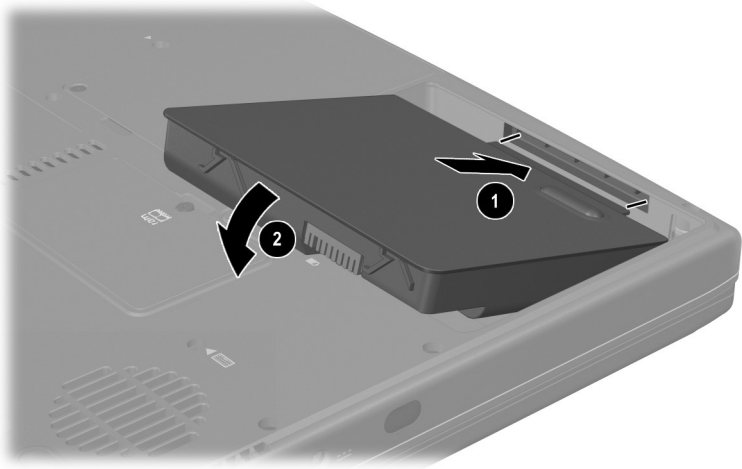

Inserting a battery pack

2. To restore from Hibernation or to turn on the notebook, press the power button.

Recycling or Disposing of a Used Battery Pack



For information about recycling or disposing of a used battery pack, refer on the *Documentation Library CD* to the *Regulatory and Safety Notices* guide, “Battery Notice” section.

Drives and Drive Media

Contents

| | |
|---|------|
| Understanding Drive and Drive Media Terms | 5-2 |
| Caring for Drives and Drive Media | 5-3 |
| Adding a Drive to the System | 5-4 |
| Using the IDE Drive Light | 5-4 |
| Inserting or Removing a Disc | 5-5 |
| Inserting a Disc | 5-5 |
| Removing a Disc (With Power) | 5-6 |
| Removing a Disc (Without Power) | 5-7 |
| Playing a Disc | 5-8 |
| Displaying Media Contents | 5-8 |
| Protecting Playback | 5-9 |
| Observing the Copyright Warning | 5-9 |
| Setting the Boot Order | 5-10 |
| Replacing the Internal Hard Drive | 5-10 |

Understanding Drive and Drive Media Terms

Hard drives are for the permanent storage of data files and of software such as system files, applications, and drivers. A hard drive is sometimes called a *hard disk drive*.

Diskette drives support *diskettes*, which are used to store or transport data. The notebook can read or write to any diskette. A diskette drive is sometimes called a *floppy disk drive*.

Optical drives include CD and DVD drives. Optical drives support CDs and DVDs, often called *discs*, which are used to store or transport data and to play music and movies. DVDs have higher capacities than CDs. The notebook can read or write to optical drives as described in the following table.

| Optical Drive | Read | Write |
|----------------------|-------------|--------------|
| CD-ROM drive | Yes | No |
| DVD-ROM drive | Yes | No |
| CD-RW drive | Yes | Yes |
| DVD/CD-RW drive | Yes | Yes |

A *drive designation* is a letter of the alphabet that the notebook uses to identify the drive. To display the drive designation of all the drives in the system, select Start > My Computer.

A *diskette* or *disc* that can be inserted or removed from a drive is referred to as a *drive medium*. For example, the term *drive media* includes diskettes, CDs, and DVDs.

Caring for Drives and Drive Media



CAUTION: To prevent damage to the notebook or a drive and loss of work:

- Do not remove the internal hard drive except for repair or replacement. For instructions, see the “Replacing the Internal Hard Drive” section later in this chapter.
 - Electrostatic discharge can damage electronic components. To prevent electrostatic damage to the notebook or a drive, follow these 2 precautions: (1) Discharge yourself from static electricity before handling a drive by touching a grounded metal object and (2) Avoid touching the connectors on a drive. For more information about preventing electrostatic damage, refer on the *Documentation Library* CD to the *Regulatory and Safety Notices* guide, “Electrostatic Discharge” section.
 - Excessive force can damage drive connectors. When you insert a drive, use only enough force to seat the drive.
 - Handle a drive carefully. Do not drop it.
 - Avoid exposing a hard drive or a diskette to devices with magnetic fields. Products with magnetic fields include video and audio tape erasure products, monitors, and speakers. Security devices with magnetic fields include airport walk-through devices and security wands. The airport security devices that check carry-on luggage, usually while it is placed on a conveyor belt, use x-rays instead of magnetism and will not damage a hard drive or a diskette.
 - Do not spray a drive with cleaners.
 - Avoid exposing a drive to liquids or temperature extremes.
 - If you mail a drive, ship it in packaging that protects it from shock, vibration, extreme temperatures, and high humidity. Label the package “FRAGILE.”
-



CAUTION: To prevent damage to drive media:

- Do not open the metal shutter of a diskette or touch the disk within the diskette case.
 - Do not expose a diskette to a strong magnetic field, such as the security field used by a walk-through security device or a handheld security wand.
 - Clean a CD or DVD only with a disc cleaning kit, available from most electronics retailers.
-

Adding a Drive to the System

The internal hard drive and optical drive are standard features of the notebook. The type of optical drive varies by notebook model.

An optional drive can be added to the system by connecting it, as instructed in the drive documentation, to one of the USB (universal serial bus) connectors or to the 1394 connector. Hard drive capacity can also be added with a microdrive PC Card. An SD Card or MMC (multimedia card) can provide additional data storage.

Using the IDE Drive Light

The IDE (Integrated Drive Electronics) light turns on when the internal hard drive or optical drive is being accessed.

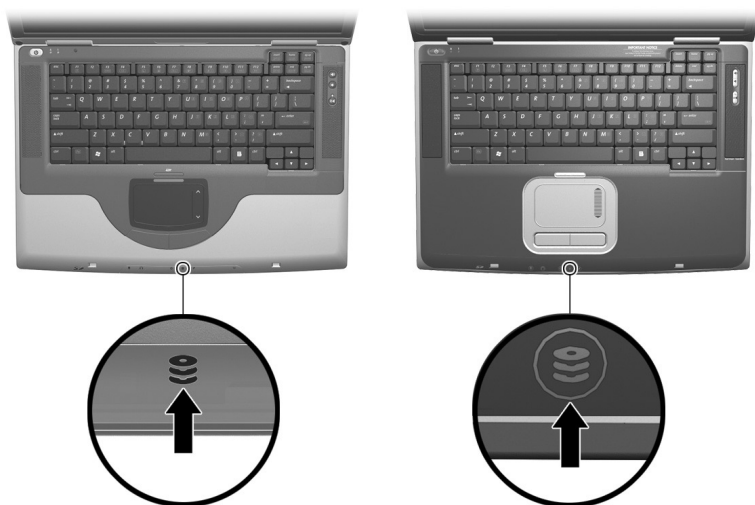

Identifying the IDE drive light

Inserting or Removing a Disc

Inserting a Disc

1. Turn on the notebook.
2. Press the release button **1** on the drive bezel to release the media tray, then pull the tray outward until it is fully extended **2**.
3. Position a CD or one-sided DVD over the tray, label side up.
4. Gently press the center of the disc onto the tray spindle **3** until the disc snaps into place. Handle the disc by the edges, not the flat surfaces. (If the media tray is not fully extended, tilt the disc to position it over the tray spindle, then press it downward into position.)
5. Close the media tray **4**.

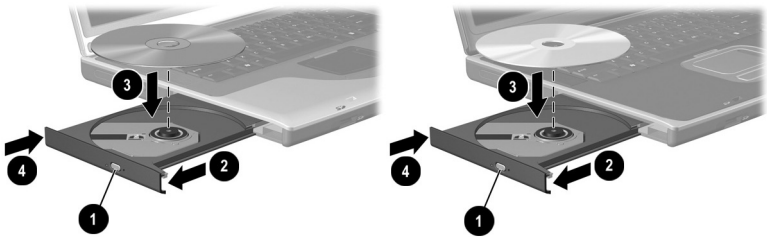

Inserting a disc into the optical drive

Removing a Disc (With Power)

1. Turn on the notebook.
2. Press the release button **1** on the drive bezel to release the media tray, then pull the tray outward until it is fully extended **2**.
3. Remove the disc from the tray by gently pushing down on the spindle while pulling up on the outer edges of the disc **3**. Handle the disc by the edges, not the flat surfaces. If the media tray is not fully extended, tilt the disc as you remove it.
4. Close the media tray **4**.
5. Place the disc in a protective case.

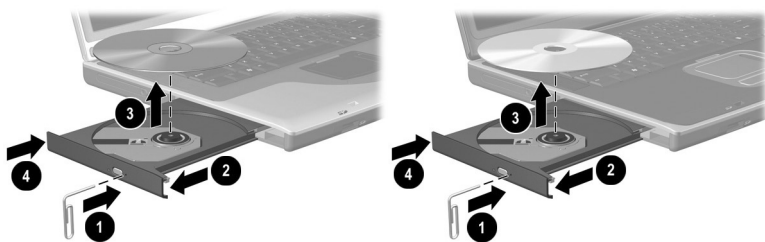

Removing a disc from the optical drive when power is available

Removing a Disc (Without Power)

If the notebook is turned off or if no power is available, the release button on the optical drive will not work. To remove a disc from an optical drive without using the release button:

1. Insert the end of a small object like a paper clip into the release access ❶ in the front bezel of the drive.
2. Press gently on the paper clip until the media tray is released, then pull the tray outward until it is fully extended ❷.
3. Remove the disc from the tray by gently pushing down on the spindle while pulling up on the outer edges of the disc ❸. Handle the disc by the edges, not the flat surfaces. If the media tray is not fully extended, tilt the disc as you remove it.
4. Close the media tray ❹.
5. Place the disc in a protective case.

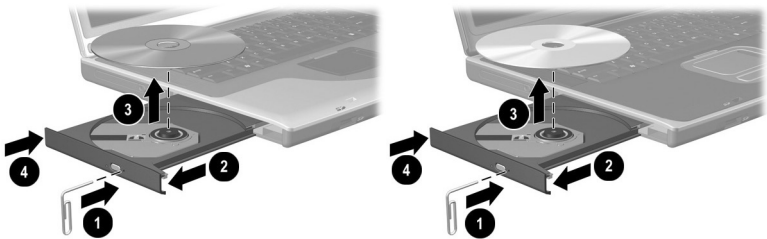

Removing a disc from the optical drive when power is not available

Playing a Disc

You can play a CD in a CD drive or a DVD drive. You can play a DVD only in a DVD drive.

The information in this section applies to most optical drives and most disc software. For information about specific disc software, including Windows Media Player, WinDVD, and Easy CD Creator, see the “Using Multimedia Software” section in Chapter 6.

Displaying Media Contents

When you insert a CD or DVD into the system, the notebook can play the medium, display its contents, take no action, or display a response prompt on the screen. You can choose how the notebook responds to the insertion of a medium by using the operating system AutoPlay feature.

The notebook responds to the following procedures at most AutoPlay settings:

- To prevent an audio CD from opening when AutoPlay is enabled on the drive containing it, press the **shift** key as you insert the CD.
- To display the contents of a drive medium when the contents are not displayed by AutoPlay:
 1. Insert the medium into the drive.
 2. Select Start > Run, then type:
explorer x:
(where x = the drive designation of the drive containing the medium)
 3. Select the OK button.

Protecting Playback



CAUTION: Inserting or removing any device while running any multimedia application may pause or stop the play.



CAUTION: Initiating Standby or Hibernation while playing a drive medium may stop the play or diminish the quality of the play.

If Standby or Hibernation is accidentally initiated during playback:

- If you see the warning message “Putting the computer into Hibernation or Standby may stop the playback. Do you want to continue?” select No. (Audio and video may resume or you may need to restart the drive medium.)
- If Standby or Hibernation initiates and no warning message is displayed, resume from Hibernation or Standby by briefly pressing the power button, then restart the medium.

Observing the Copyright Warning

It is a criminal offense, under applicable copyright laws, to make unauthorized copies of copyright-protected material, including computer programs, films, broadcasts, and sound recordings. This notebook should not be used for such purposes.

Setting the Boot Order

By default, the notebook starts up from the internal hard drive. You can set the notebook to start up from any bootable CD or DVD in the optical drive. A bootable CD or DVD contains files needed by the notebook to start up and operate properly. On some models, you can also start up from a drive connected to the notebook by USB.

Startup preferences are set in the Setup utility. The Setup utility is not a Windows utility and does not support the TouchPad. For information about using the Setup utility, see the “Using the Setup Utility” section in Chapter 9.

Replacing the Internal Hard Drive

The hard drive in the hard drive bay is the internal hard drive. Remove the internal hard drive only for repair or replacement.



CAUTION: To prevent an unresponsive system and loss of work, do not begin this procedure until you have:

- Saved your work, closed all open applications, and shut down the notebook.
 - Disconnected the notebook from external power and removed the battery pack.
-

1. Save your work and close all open applications.
2. Shut down the notebook and close the display.
3. Disconnect the notebook from external power.
4. Remove the battery pack.

5. Turn the notebook underside up.
6. Remove the 2 hard drive retaining screws.

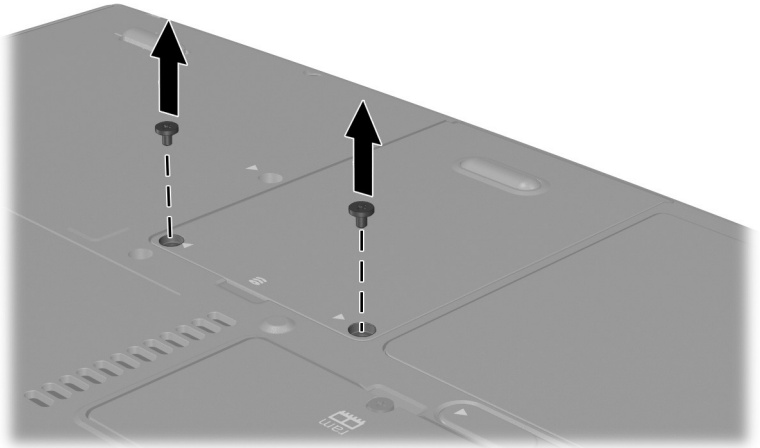

Removing the hard drive retaining screws

7. To remove a hard drive, grasp the hard drive assembly (the hard drive, the hard drive cover, and the hard drive bracket) using the hard drive recess **1**. Tilt the hard drive assembly upward **2**, then pull the assembly from the hard drive bay **3**.

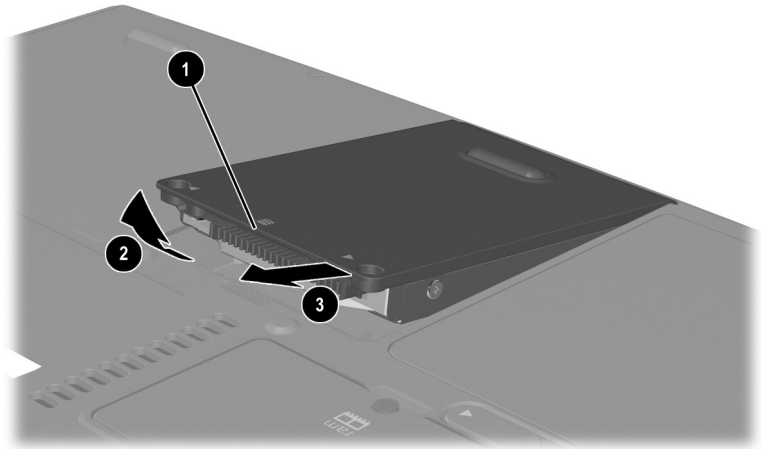

Removing an internal hard drive from the hard drive bay

8. To insert a hard drive, insert the 2 alignment tabs on the hard drive cover into the 2 alignment slots on the hard drive bay ❶, then tilt the hard drive assembly downward into the hard drive bay until it is seated ❷.

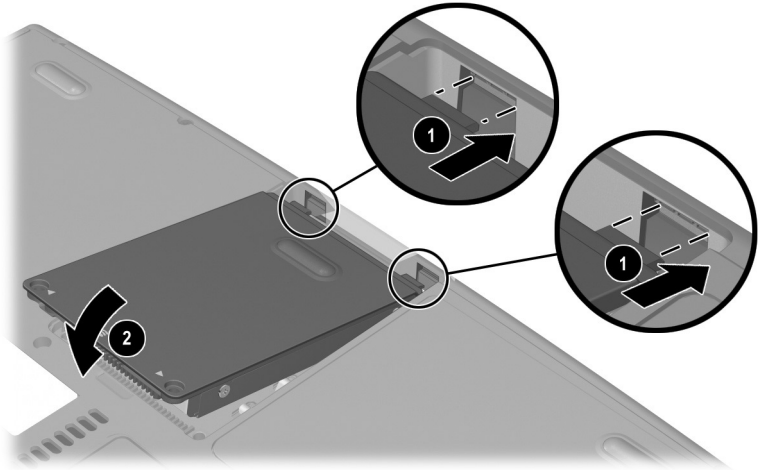

Inserting an internal hard drive into the hard drive bay

9. If you have inserted a hard drive, reinsert the 2 hard drive retaining screws. (If you removed but did not replace a hard drive, put the retaining screws in a safe place.)

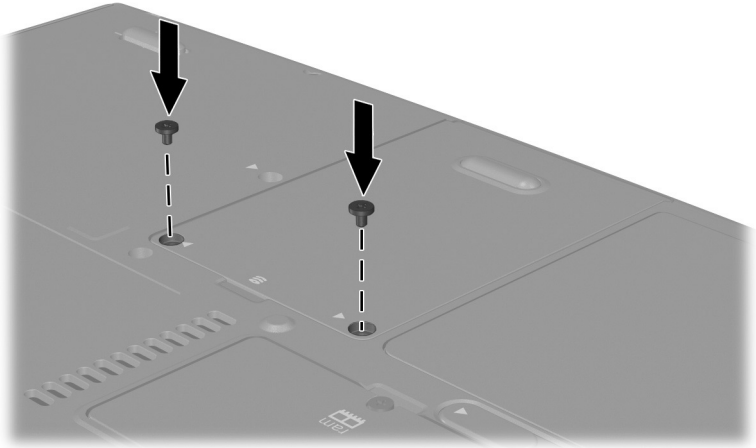

Replacing the hard drive retaining screw

Contents

| | |
|--|-----|
| Adjusting Volume | 6-2 |
| Using the Internal Speakers | 6-3 |
| Connecting an Audio Device | 6-4 |
| Connecting an S-Video Device | 6-5 |
| Connecting the Audio | 6-5 |
| Connecting the Video | 6-5 |
| Turning a Video Device On and Off | 6-6 |
| Changing the Color Television Format | 6-6 |
| Using Multimedia Software | 6-7 |
| Using Windows Media Player | 6-7 |
| Using WinDVD | 6-7 |
| Using Easy CD Creator | 6-9 |

Adjusting Volume

Volume can be adjusted by using the audio buttons on the notebook or by using operating system or application volume control software. The mute button overrides all software volume settings.

To adjust volume using the audio buttons:

- To increase volume, press the increase volume button ❶.
- To decrease volume, press the decrease volume button ❷.
- To mute or restore volume, press the mute button ❸.

When volume is muted, the mute light ❹ turns on. When volume is restored, the mute light turns off.

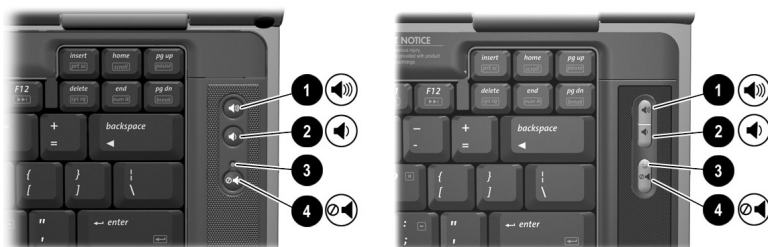

Identifying the audio buttons and mute light

Using the Internal Speakers

The internal speakers play sound in stereo from applications, the operating system, games, drive media, the Internet, and other sources.

If an external device, such as a headset, is connected to the audio-out jack, the internal speakers are disabled.

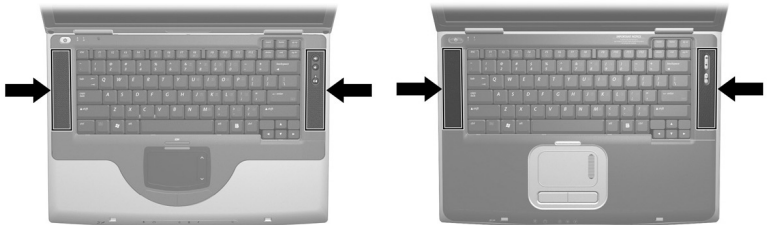

Identifying the internal speakers

Connecting an Audio Device



WARNING: To reduce the risk of personal injury, adjust the volume before putting on headphones or a headset.



CAUTION: To prevent possible damage to an external device, do not plug a monaural (single sound channel) plug into the audio-out jack.

The notebook has 2 audio jacks:

- The microphone jack ❶ connects an optional monaural or stereo microphone. If a monaural microphone is connected, the same information is recorded on both channels.
- The audio-out jack ❷, sometimes called a *line-out* jack, connects headphones or powered external stereo speakers. The audio-out jack is also used to connect the audio functions of an audio/video device such as a television or VCR. When you connect a device to the audio-out jack:
 - ❑ Use only a 3.5-mm plug.
 - ❑ The internal speakers are disabled.



Identifying the audio jacks

Connecting an S-Video Device

Connecting the Audio

The S-Video jack supports video signals only.

If you are setting up a configuration that combines audio and video functions, such as playing a DVD movie on your notebook and displaying it on your television, you will need a standard 3.5-mm audio cable available from most computer or electronics retailers.

Plug the stereo end of the audio cable into the notebook audio-out jack. Plug the other end of the cable into the audio *input* jack on the external device.

Connecting the Video

To transmit video signals through the S-Video jack, you will need a standard S-Video cable available from most computer or electronics retailers.

Plug either end of the S-Video cable into the notebook S-Video jack. Plug the other end of the cable into the S-Video *input* jack on the external device.

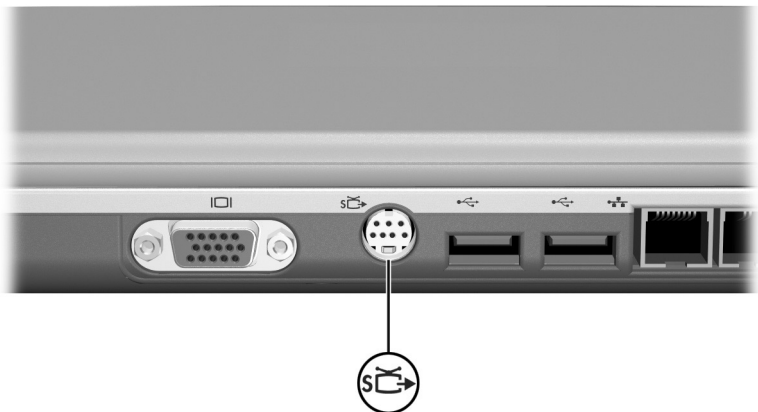

Identifying the S-Video jack

Turning a Video Device On and Off

To turn on a video device that is connected to the notebook, start or restart the notebook. Or, repeatedly press the **Fn+F4** hotkeys to switch the image. Pressing the **Fn+F4** hotkeys switches the image among the notebook display, any connected displays, and simultaneous display on the notebook and all connected displays.

- Switching the image to a connected video device turns on the video device.
- Switching the image to the notebook display only turns off the video device.

Changing the Color Television Format

Color television formats are modes by which television video signals are sent and received. To send signals between the notebook and a television, both the notebook and the television must be using the same color television format.

The NTSC format is common in the United States, Canada, Japan, and South Korea. The PAL format is common in Europe, China, Russia, and Africa, and the PAL-M format is common in Brazil. Other South American and Central American countries may use NTSC, PAL, or PAL-M.

Region-specific formats are set at the factory for most notebooks, but the region setting can be changed on any notebook.

Color television format settings are changed in the Setup utility. The Setup utility is not a Windows utility and does not support the TouchPad. For information about using the Setup utility, see the “Using the Setup Utility” section in Chapter 9.

Using Multimedia Software

Using Windows Media Player

Use Windows Media Player primarily for playing audio CDs. Although video CDs can be played using Windows Media Player, InterVideo WinDVD provides higher quality playback.

To open Windows Media Player, insert a CD into the optical drive, then close the tray. Wait several seconds. If Windows Media Player does not open, select Start > All Programs > Windows Media Player.

To play or stop the CD, use the on-screen Play button or Stop button, or use the media hotkeys described in the “Hotkeys” section of Chapter 3.

Using WinDVD

WinDVD is an application that enables you to play DVD movies or video CDs. If WinDVD is included with your notebook, the application is preinstalled.

Playing a DVD or Video CD

For best playback quality, save and close all files and software unrelated to playing the DVD or video CD.

If a DVD displays a Playback Of Content From This Region Is Not Permitted error message, stop the DVD, change the region setting, then restart the DVD. For information about changing the region setting, see “Managing DVD Region Settings” next in this chapter.

To play a DVD or video CD:

1. Insert the DVD or video CD into the optical drive.
2. Assign WinDVD to play the video:
 - ❑ If the Microsoft Windows XP AppPicker window is displayed, select Play Video By Using WinDVD.
 - ❑ If the Microsoft Windows XP AppPicker window is not displayed, select Start > All Programs > InterVideo WinDVD > InterVideo WinDVD.
3. Follow the instructions on the screen.

Managing DVD Region Settings

Most DVDs that contain copyrighted files also contain region codes. The region codes help protect copyrights internationally.

You can play a DVD containing a region code only if the region code on the DVD matches the region setting on your DVD drive.

If the region code on a DVD does not match the region setting on your drive, a Playback Of Content From This Region Is Not Permitted message is displayed when you insert the DVD. To play the DVD, you must change the region setting on your DVD drive.



CAUTION: The region setting on your DVD drive can be changed only 5 times.

- The region setting you select the fifth time becomes the permanent region setting on the drive.
- The number of allowable region changes remaining on the drive is displayed in the Remaining Times Until Permanent field in the WinDVD window. The number in the field includes the fifth and permanent change.

To change the region setting on drive media:

1. Insert the DVD into the optical drive.
2. If WinDVD does not open after a short pause, select Start > All Programs > InterVideo WinDVD > InterVideo WinDVD.

3. Select the Properties icon in the lower right corner of the window.
4. Select the General tab.
5. Select the button for the region.
6. Select the OK button.

Using Easy CD Creator

Easy CD Creator is a data transfer utility that enables you to create or duplicate optical drive media. The utility is installed on select models and can be used with any CD or DVD supported by any optical drive in the system.

When Easy CD Creator is installed, a “Burn CD & DVDs with Roxio” icon is displayed at Start > All Programs > Start Menu.

Understanding Easy CD Creator Features

Easy CD Creator includes 2 applications: DirectCD and Easy CD Creator. The Easy CD Creator application includes CD Copier.

- Use DirectCD with Windows Explorer to drag-and-drop data files between your hard drive and a CD or DVD or between your hard drive and a network drive. DirectCD is often used to back up data files or to share them with other people. Although DirectCD can be used with most application data files, including Microsoft Office data files, it cannot be used with audio files such as MP3 files.
- Use Easy CD Creator, which includes CD Copier, to copy either data files such as Microsoft Office files, or audio files such as MP3 files, to a CD or DVD.
 - ❑ Use Easy CD Creator to copy individual audio files to a CD or DVD, for example, to create a CD containing only your favorites.
 - ❑ Use CD Copier to duplicate a CD or DVD.

Preparing to Use Easy CD Creator



CAUTION: To prevent loss of work and damage to a CD or DVD:

- Before writing to a CD or DVD, connect the notebook to a reliable external power source. Do not write to a CD or DVD while the notebook is running on battery power.
 - Before writing to a CD or DVD, close all open applications (including screen savers and antivirus software) except Easy CD Creator Basic.
 - Do not copy directly from a CD or DVD to another CD or DVD or from a network drive to a CD or DVD. Instead, copy from a CD, DVD, or a network drive to your hard drive, then copy from your hard drive to the CD or DVD.
 - Do not type on the notebook keyboard or move the notebook while the notebook is writing to a CD or DVD. The write process is sensitive to vibration.
-

Choosing Recording Media

HP recommends using high-quality media that correspond to the maximum speed of the optical drive. The notebook can write or copy to CDs and DVDs which provide one-time, non-erasable recording or to CDs and DVDs which provide erasable recording.

Responding to the UDF Prompt

The first time you insert a CD or DVD into an optical drive, you may be prompted to install Universal Disk Format (UDF) Reader. When UDF Reader is installed, a CD or DVD created with DirectCD on your notebook can be used in another computer on which DirectCD is not installed.



Even if UDF Reader is installed on your notebook, a CD or DVD created with DirectCD software can be used in a compatible optical drive only if you select the Rearrange the Files option as you create the CD or DVD.

Formatting Recording Media

You can purchase optical drive media that either are or are not formatted for DirectCD.

- To use DirectCD, use a CD or DVD formatted for DirectCD.
- To use Easy CD Creator or CD Copier, do not use a CD or DVD formatted for DirectCD.

To erase DirectCD formatting from a CD or DVD so the CD or DVD can be used with Easy CD Creator or CD Copier:

1. Insert the CD or DVD into the optical drive.
2. Select Start > All Programs > Easy CD Creator Basic > CD-RW Eraser.
3. Select the Erase button.
4. Select the OK button.

Selecting Easy CD Creator Settings

To use DirectCD, Easy CD Creator, or CD Copier, the default settings shown in the following table must be selected. These settings are compatible; for example, the settings for DirectCD do not conflict with the settings for CD Copier.

| Application | Required Settings |
|--------------------|---|
| DirectCD | Enable Auto Insert Notification |
| Easy CD Creator | Disable Disk-at-Once and Enable Track-at-Once |
| CD Copier | Disable Disk-at-Once |

- Auto Insert Notification settings are selected through the operating system.
- To select Disk-at-once settings:
 1. Select Start > All Programs > Roxio Easy CD Creator 5 > Applications > CD Copier.
 2. Select the Advanced tab.
 3. Clear the Disk-at-Once check box.
 4. Select the Set as Default button.
- To select Track-at-once settings:
 1. Select Start > All Programs > Roxio Easy CD Creator 5.
 2. The fourth item on the status bar at the lower edge of the CD Project window indicates whether Track-at-Once or Disk-at-Once is selected.
 - ◆ If Track-at-Once is displayed on the status bar, Track-at-Once is already enabled.
 - ◆ If Disk-at-Once is selected, double-click Disk-at-Once to enable Track-at-Once.

Communications

Contents

| | |
|---|------|
| Modem | 7-2 |
| Connecting the Modem | 7-3 |
| Using the Modem While Traveling | |
| Internationally | 7-6 |
| Accessing Communication Software. | 7-9 |
| Finding AT Command Information. | 7-9 |
| Network | 7-10 |
| Connecting the Network Cable | 7-11 |
| Turning a Network Connection Off and On | 7-12 |
| Accessing the Network at Startup | 7-12 |
| Infrared. | 7-13 |
| Setting Up an Infrared Transmission. | 7-14 |
| Avoiding Standby While Using Infrared. | 7-14 |

Modem

All notebook models include an RJ-11 telephone jack, and some models ship with a preinstalled modem. A modem cable with RJ-11 connectors at each end is included with select models.

You need a modem cable to connect a modem. If your model did not include a modem cable, a modem cable can be purchased from most computer or electronics retailers.

If you purchased a notebook with an internal modem in a country where RJ-11 telephone jacks are not standard, a country-specific modem adapter is included with the notebook.

An internal modem supports:

- All applications supported by the operating system.
- V.34 ITU (International Telecommunications Union) analog modem recommendations for speeds up to 33.6 Kbps.
- V.44 data compression algorithm.
- V.90/V.92 ITU digital/analog modem pair recommendations for speeds up to 56 Kbps.

The digital/analog modem pair rates allow faster downloads only from compliant digital sources. Maximum achievable download rates are currently unknown, may not reach 56 Kbps, and will vary with line conditions. Maximum achievable upload rates are limited to 48 Kbps, may not reach 48 Kbps, and will vary with line conditions.

Connecting the Modem

Selecting Connectors

A modem must be connected to an analog telephone line.



WARNING: To reduce the risk of electric shock, fire, or damage to the equipment, do not plug a telephone cable into the RJ-45 network jack.



CAUTION: Jacks for digital PBX systems may resemble RJ-11 telephone jacks, but are not compatible with the modem.

Jacks for analog telephone lines and procedures for connecting the modem vary by country:

- If you are connecting a modem in a country where RJ-11 telephone jacks are standard, follow the instructions in “Connecting a Modem to an RJ-11 Jack” next in this section.
- If you are connecting a modem in a country where RJ-11 telephone jacks are not standard, a modem adapter specific to the country in which you purchased the notebook is included with the notebook. Follow the instructions in “Connecting a Modem with an Adapter” later in this section.
- If you plan to use a modem outside the country in which you purchased the notebook, you can purchase adapters specific for the countries on your itinerary from most computer or electronics retailers. For information about using country-specific software configurations, see “Using the Modem While Traveling Internationally” later in this section.

Connecting a Modem to an RJ-11 Jack

To connect a modem to an analog telephone line that has an RJ-11 telephone jack:

1. Identify the RJ-11 ❶ jack on the notebook.
2. If your modem cable has noise suppression circuitry ❷, which prevents interference with TV and radio reception, orient the circuitry end of the cable toward the notebook.
3. Plug the modem cable into the RJ-11 telephone jack (not the RJ-45 network jack) on the notebook ❸.
4. Plug the other end of the modem cable into an RJ-11 telephone jack (not into an RJ-45 network jack or a PBX jack) ❹.

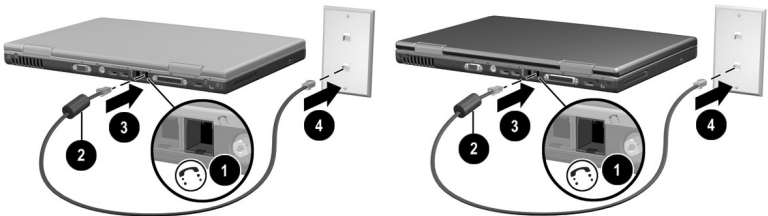

Connecting a modem to an RJ-11 telephone wall jack (Telephone wall jacks vary in appearance by region and country.)



WARNING: To reduce the risk of electric shock, disconnect the modem from the telephone network before accessing an internal compartment of the notebook. Internal compartments include the memory compartment and the battery and hard drive bays.

Connecting a Modem with an Adapter

To connect a modem to an analog telephone line that does not have an RJ-11 telephone jack:

1. Identify the RJ-11 jack ❶ on the notebook.
2. If the modem cable has noise suppression circuitry ❷, which prevents interference with TV and radio reception, orient the circuitry end of the cable toward the notebook.
3. Plug the modem cable into the RJ-11 telephone jack (not the RJ-45 network jack) on the notebook ❸.
4. Plug the modem cable into the country-specific modem adapter ❹.
5. Plug the country-specific modem adapter into the telephone jack ❺.

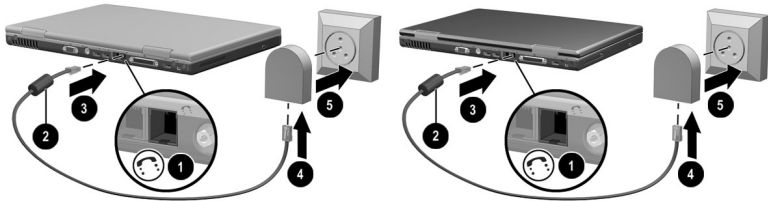

Connecting a modem with a modem adapter (Telephone wall jacks vary in appearance by region and country.)



WARNING: To reduce the risk of electric shock, disconnect the modem from the telephone network before accessing an internal compartment of the notebook. Internal compartments include the memory compartment and the battery and hard drive bays.

Using the Modem While Traveling Internationally

An internal modem is configured to function in, and meet the operating standards of, the country in which you purchased the notebook. To use an internal modem in other countries, you must add country-specific modem configurations.

Displaying the Current Country Configuration

To display the current country configuration, select Start > Control Panel > Date, Time, Language, and Regional Options category > Regional and Language Options icon > Regional Options tab. The current country configuration of the modem is displayed in the Location panel.

Adding a Country Configuration



CAUTION: To prevent the loss of your current country configuration, do not delete or replace your current country configuration. Additional country configurations can be added without deleting the current configuration.



CAUTION: To prevent modem malfunction and violation of telecommunications regulations and laws, use the modem only with the country configuration for the country in which you are using the modem.

To add a country configuration:

1. Select Start > Control Panel > Network and Internet Connections category.
2. From the See Also menu in the left column of the window, select Phone and Modem Options > Dialing Rules tab.

3. Select the New button, then type a name for the new location in the Location Name field.
4. Select a country or region for the new location from the Country/Region list.
If you select a country or region that is not supported by the modem, the country configuration defaults to USA or UK.
5. Select the OK button > OK button.

Solving Travel Connection Problems

If you experience connection problems while using a modem outside the country in which you purchased the notebook, the following suggestions may be helpful.

Before changing any settings, you may want to write down your current settings so you can quickly replace those settings when you return home.

Check the Line

A modem requires an analog, not a digital, telephone line. A line described as a PBX line is usually a digital line. A telephone line described as a data line, fax machine line, modem line, or standard telephone line is probably an analog line.

Check the Dialing Mode

Dial a few digits on the telephone, then listen for clicks or tones. Clicks indicate that the telephone line supports pulse dialing. Tones indicate that the telephone line supports tone dialing. To set an internal modem to support a dialing mode:

1. Select Start > Control Panel > Network and Internet Connections category.
2. From the See Also menu in the left column of the window, select Phone and Modem Options > Dialing Rules tab.
3. Select your location, then select the Edit button.
4. Select the Tone or Pulse radio button.
5. Select the OK button > OK button.

Check the Telephone Number

Dial the telephone number on the telephone, verify that the remote modem is answering, then hang up.

Check the Dial Tone

If a modem receives a dial tone it does not recognize, the modem will not dial and will display a No Dial Tone error message.

- To set the modem to ignore all dial tones before dialing:
 1. Select Start > Control Panel > Network and Internet Connections category.
 2. From the See Also menu in the left column of the window, select Phone and Modem Options > Modems tab.
 3. Select your modem > Properties button > Modem tab.
 4. Clear the Wait For Dial Tone Before Dialing check box.
 5. Select the OK button > OK button.
- If you continue to receive the No Dial Tone error message after clearing the check box:
 1. Select Start > Control Panel > Network and Internet Connections category.
 2. From the See Also menu in the left column of the Network and Internet Connections window, select Phone and Modem Options > Dialing Rules tab.
 3. Select your location, then select the Edit button.
 4. Select your location from the Country/Region list.

If you select a country or region that is not supported by the modem, the country configuration defaults to USA or UK.
 5. Select the OK button.

6. In the Phone and Modem Options window, select the Modems tab.
7. Select your modem > Properties button > Modem tab.
8. Clear the Wait For Dial Tone Before Dialing check box.
9. Select the OK button > OK button.

Accessing Communication Software

To access preinstalled modem software, including software for terminal emulation and data transfer, select Start > All Programs > Accessories > Communications, then select an application, wizard, or utility.

Finding AT Command Information

It is not necessary to use AT commands with most modem software. If you prefer to use AT commands, refer on the *Documentation Library* CD to:

- *Modem Commands Guidelines (Advanced Users Only)* for information about accessing HyperTerminal, identifying the modem model in your notebook, and using AT commands.
- *Agere Command Set (Advanced Users Only)* for the AT commands supported by an Agere modem. If your notebook shipped with an internal modem, that modem supports the Agere command set. For command updates and supplementary information about your Agere modem, visit:
<http://www.agere.com>

Agere Command Set (Advanced Users Only) is provided on the *Documentation Library* CD in English only.

Network

All notebook models ship with an RJ-45 network jack. A network cable with RJ-45 connectors at each end is included with select models.

The notebook can be connected to a network whether or not the internal modem is connected to a telephone line.

If your notebook is connected to a network, you may want to confer with your network administrator before changing network settings.

The notebook supports network speeds up to 10 Mbps when connected to a 10BaseT network and 100 Mbps when connected to a 100BaseTX network.

Connecting the Network Cable

A network cable has an 8-pin RJ-45 network connector at each end and may contain noise suppression circuitry, which prevents interference with TV and radio reception. To connect the cable:

1. Identify the RJ-45 network jack **1** on the notebook.
2. Orient the end of a network cable with noise suppression circuitry **2** toward the notebook.
3. Plug the network cable into the notebook RJ-45 network jack **3**.
4. Plug the other end of the cable into the network RJ-45 jack **4**.

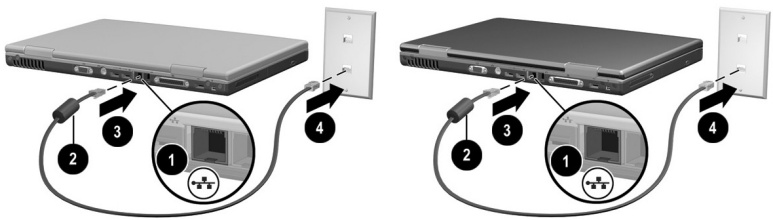

Connecting a network cable



WARNING: To reduce the risk of electric shock, disconnect the network cable before accessing an internal compartment of the notebook. Internal compartments include the memory compartment and the battery and hard drive bays.

Turning a Network Connection Off and On

To conserve power, turn off a network connection you are not using.

- To turn off a network connection, log off the network, then disconnect the network cable.
- To turn on a network connection, connect the network cable, then log on to the network.

Accessing the Network at Startup

To connect the notebook to a PXE (Preboot eXecution Environment) server during startup, you must enable the internal NIC for startup, then respond to the Network Service Boot prompt each time you want to connect to the server.

- To enable the NIC for startup and set the notebook to display the Network Service Boot prompt each time the notebook is started or restarted, set your preferences in the Setup utility. The Setup utility is not a Windows utility and does not support the TouchPad. For more information about using the Setup utility, refer to the “Using the Setup Utility” section in Chapter 9 of this guide.
- To respond to the Network Service Boot prompt, press **F12** while the prompt F12 = Boot from LAN appears very briefly in the lower left corner of the screen before Windows loads.

Infrared

The notebook is IrDA-compliant and can communicate with another infrared-equipped device that is also IrDA-compliant. The IrDA connection speed standard is 4 megabits per second (Mbps).

The infrared port supports low-speed connections up to 115 kilobits per second (Kbps) as well as high-speed connections up to 4 Mbps.

Infrared signals are sent through an invisible beam of infrared light and must have an unobstructed line of sight. Infrared performance may vary with the performance of infrared peripherals, the distance and angle between infrared devices, and the applications being used.

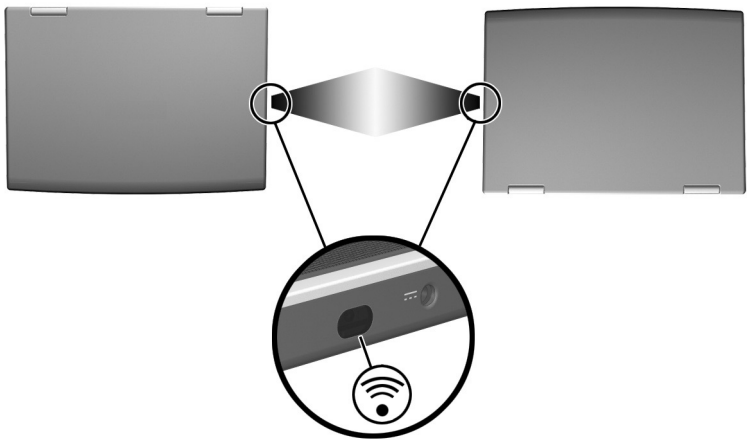

Linking to an infrared device

Setting Up an Infrared Transmission

For information about using infrared software and enabling or disabling infrared ports, refer to the operating system Help files and to the documentation included with the external infrared device.

To set up 2 infrared devices, such as the notebook and an optional printer, for optimal transmission:

- Position the devices so that their infrared ports face each other at a distance of no more than 3.3 feet (1 meter).
- Position the ports so that they face each other directly. The maximum capture angle is 30 degrees, so the ports must be aligned no more than 15 degrees off center vertically or horizontally.
- Shield the ports from direct sunlight, flashing incandescent light, and fluorescent light.
- Be sure that signals from a remote control or other wireless device (such as a cell phone, a headset, or an audio device) do not aim at either port.
- During the transmission, do not move either device and do not allow objects or movement to disrupt the beam.

Avoiding Standby While Using Infrared

Standby is not compatible with infrared transmission. If the notebook is in Standby, an infrared transmission cannot be initiated.

If Standby initiates *during* an infrared transmission, the transmission stops. To resume from Standby, briefly press the power button. The transmission resumes when the notebook resumes from Standby.

Hardware Options and Upgrades

Contents

| | |
|---|------|
| Connecting a Powered Device | 8-2 |
| Connecting a USB Device | 8-2 |
| Using a PC Card | 8-3 |
| Selecting a PC Card | 8-3 |
| Configuring a PC Card | 8-4 |
| Inserting a PC Card | 8-4 |
| Stopping and Removing a PC Card | 8-5 |
| Using an SD Card or MMC | 8-6 |
| Using the SD Card Light | 8-6 |
| Inserting an SD Card or MMC | 8-7 |
| Removing an SD Card or MMC | 8-8 |
| Disabling or Restarting an SD Card or MMC | 8-8 |
| Increasing Memory | 8-9 |
| Displaying Memory Information | 8-9 |
| Removing or Inserting a Memory Module | 8-10 |
| Connecting an Optional Cable Lock | 8-15 |

Connecting a Powered Device

To connect the notebook to an optional external device that has a power cord:

1. Be sure the device is turned off.
2. Connect the device to the jack or connector on the notebook specified by the device manufacturer.
3. Plug the device power cord into a grounded electrical outlet.
4. Turn on the device.



If a properly connected external monitor or other display device does not display an image, try pressing the **Fn+F4** hotkeys to switch the image to the new device.

To disconnect a powered external device from the notebook:

1. Turn off the device.
2. Disconnect the device from the notebook.

Connecting a USB Device

USB (universal serial bus) is a hardware interface that can be used to connect external devices such as a USB keyboard, mouse, drive, printer, scanner, or hub to the notebook.

A hub is a connecting device that can be either powered or unpowered. USB hubs can be connected to a USB connector on the notebook or to other USB devices. Hubs support varying numbers of USB devices and are used to increase the number of USB devices in the system.

- Powered hubs must be connected to external power.
- Unpowered hubs must be connected either to a USB connector on the notebook or to a port on a powered hub.

The USB connectors on the notebook support USB 2.0- and 1.1-compliant devices.

By default, USB devices function only while the operating system is loaded. To use a USB keyboard or hub connected to a USB connector on the notebook during startup (before Windows loads) or in a non-Windows application or utility, enable USB legacy support in the Setup utility. For more information about using the Setup utility, see the “Using the Setup Utility” section in Chapter 9.

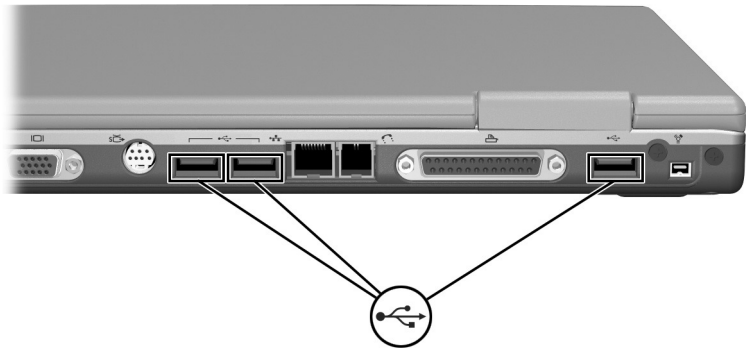

Identifying the 3 USB connectors on the notebook

Using a PC Card

A PC Card is a credit card–sized accessory designed to conform to the standard specifications of the Personal Computer Memory Card International Association (PCMCIA). The notebook PC Card slot supports both 32-bit CardBus and 16-bit PC Cards.

PC Cards can be used to add modem, sound, storage, wireless communication, or digital camera functions to the notebook.

Selecting a PC Card

A Type I or Type II PC Card can be used. Zoomed video cards are not supported.

Configuring a PC Card



CAUTION: If you install all of the software or any of the enablers provided by a PC Card manufacturer, you may not be able to use other PC Cards. If you are instructed by the documentation included with your PC Card to install device drivers:

- Install only the device drivers for your operating system.
 - Do not install other software, such as card services, socket services, or enablers, that may also be supplied by the PC Card manufacturer.
-

Inserting a PC Card



CAUTION: To prevent damage to the PC Card connectors:

- Use minimal force when inserting a PC Card into a PC Card slot.
 - Do not move or transport the notebook while a PC Card is inserted.
-

1. Hold the PC Card label-side up with the connectors facing the notebook.
2. Gently push the card into the slot until the card is seated.



Inserting a PC Card

Stopping and Removing a PC Card



CAUTION: To prevent loss of work or an unresponsive system, stop the PC Card before removing it.



Stopping a PC Card, even if it is not in use, conserves power.

1. Close all applications and complete all activities that are supported by the PC Card.
2. To stop a PC Card, select the Safely Remove Hardware icon on the taskbar, then select the PC Card. (To display the Safely Remove Hardware icon, select in the taskbar the icon for Show Hidden Icons.)
3. To release the PC Card, press the PC Card eject button ❶. (If the PC Card button does not extend while a PC Card is in the PC Card slot, press the button once to extend the button, then press the button again to release the PC Card.)
4. Gently pull out the PC Card ❷.



Removing a PC Card

Using an SD Card or MMC



CAUTION: To prevent damage to the SD Card connectors:

- Use minimal force when inserting an SD Card or MMC into an SD Card slot.
- Do not move or transport the notebook while an SD Card or MMC is inserted.

SD (Secure Digital) Cards and MMCs (multimedia cards) are flash memory cards that provide secure data storage and convenient data sharing. These cards are often used with SD-equipped cameras and PDAs as well as notebooks. The SD Card features on the notebook support both SD Cards and MMCs.

Using the SD Card Light

The SD Card light turns on when an inserted SD Card or MMC is being accessed. The SD Card light turns off when an inserted SD Card or MMC is inactive or when the SD Card slot is empty.



Identifying the SD Card light

Inserting an SD Card or MMC

To insert an SD Card or MMC:

1. Hold the card label-side up with the connectors facing the notebook.
2. Gently push the card into the SD Card slot until the card is seated. (The card will extend outward slightly beyond the notebook.)

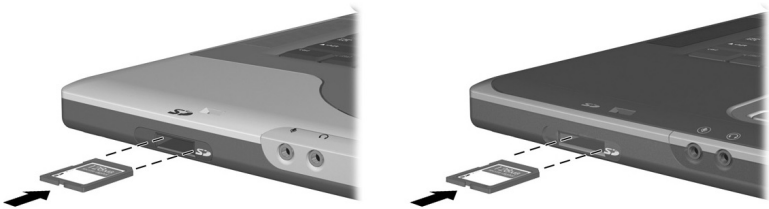

Inserting an SD Card or MMC

Removing an SD Card or MMC

To remove an SD Card or MMC:

1. Close all applications and complete all activities that are supported by the card. (To stop a data transfer, select the cancel button in the operating system Copying window.)
2. Push the card inward until it is released.
3. Pull the card out of the slot.



Releasing and removing an SD Card or MMC

Disabling or Restarting an SD Card or MMC

An inserted SD Card or MMC uses power even when the card is not in use. Disabling the card conserves power.

To disable an inserted SD Card or MMC, double-click the My Computer icon on the Windows Desktop, right-click the drive assigned to the card, then select Eject. (The card is stopped but is not released from the SD Card slot.)

To restart the card, remove, then reinsert, the card. For instructions, see “Inserting an SD Card or MMC” and “Removing an SD Card or MMC” in this chapter.

Increasing Memory

You can increase the amount of RAM (random access memory) in the notebook with an optional HP-approved memory module.

The notebook memory slot supports one 128-MB, 256-MB, 512-MB, or 1024-MB memory module.

Some notebook models ship with a vacant memory slot. On other models the memory slot contains a preinstalled memory module that can be replaced at any time.

Displaying Memory Information

When RAM is increased, the operating system increases the hard drive space reserved for the hibernation file.

If you experience problems with Hibernation after increasing RAM, verify that your hard drive has enough free space for the larger hibernation file.

- To display the amount of RAM in the system:
Select Start > Control Panel > Performance and Maintenance icon > System icon > General tab.
- To display both the amount of free space on your hard drive and the amount of space required by the hibernation file:
Select Start > Control Panel > Performance and Maintenance icon > Power Options icon > Hibernate tab.

Removing or Inserting a Memory Module



WARNING: To prevent exposure to electrical shock, access only the memory compartment during this procedure. The memory compartment and the battery and hard drive bays are the only user-accessible internal compartments on the notebook. All other areas that require a tool to access should be opened only by an HP authorized service provider.



WARNING: To prevent exposure to electrical shock and damage to the notebook, shut down the notebook, unplug the power cord, and remove the battery pack before installing a memory module.



CAUTION: To prevent electrostatic discharge from damaging electronic components: before beginning this procedure, discharge yourself of static electricity by touching a grounded metal object. For more information about preventing electrostatic damage, refer on the *Documentation Library* CD to the *Regulatory and Safety Notices* guide, “Electrostatic Discharge” chapter.

1. Save your work and shut down the notebook. If you are not sure whether the notebook is off or in Hibernation, briefly press the power button. If your work returns to the screen, save your work, exit all applications, then shut down the notebook.
2. Disconnect all external devices connected to the notebook.
3. Disconnect the power cord.
4. Remove the battery pack.

5. Turn the notebook underside up.
6. Remove the memory compartment screw **1**, then lift up and remove the memory compartment cover **2**.

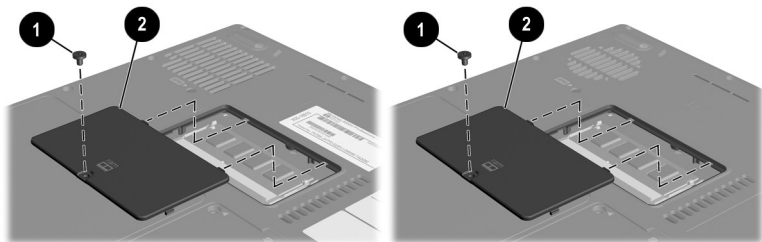

Opening the memory compartment

7. Remove or insert the memory module.

To remove a memory module:

- a. Pull away the retention clips on each side of the module ❶. (The module tilts upward.)
- b. Grasp the edges of the module and gently pull the module out of the memory slot ❷.
- c. To protect a memory module after removal, place it in an electrostatic-safe container.

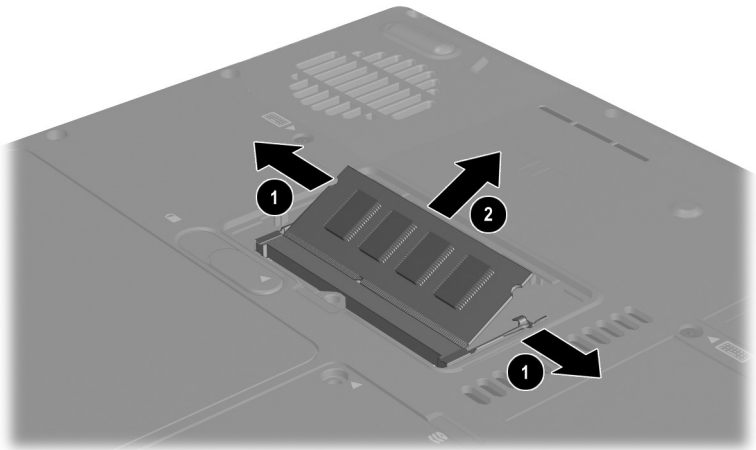

Removing a memory module

To insert a memory module:

- a. Align the keyed (notched) edge of the module with the keyed area in the memory slot **1**.
- b. With the module at a 45-degree angle from the surface of the memory compartment, press the module into the memory slot until it is seated **2**.
- c. Push the module downward until the retention clips snap into place **3**.

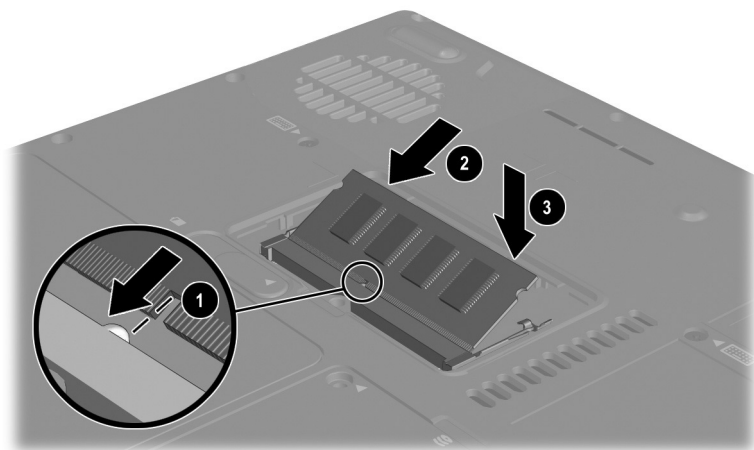

Inserting a memory module

8. Align the tabs on the memory compartment cover with the cover slots on the notebook, then tilt the cover downward until it is seated ❶.
9. Reinsert and tighten the memory compartment screw ❷.
10. Replace the battery pack (if you removed a battery pack at the beginning of this procedure), reconnect the notebook to external power, then restart the notebook.

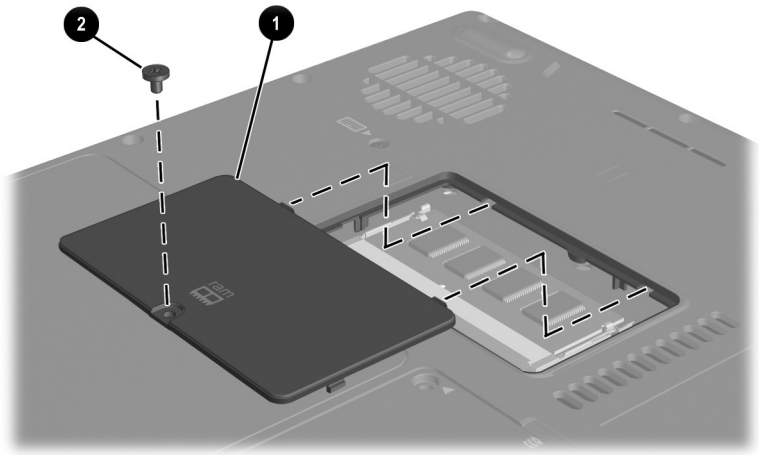

Closing the memory compartment

Connecting an Optional Cable Lock



The purpose of security solutions is to act as a deterrent. These solutions do not prevent the product from being mishandled or stolen.

An optional cable lock is a security device that prevents unauthorized removal of the notebook.

Loop the cable around a secure object, then insert the cable lock **1** into the security cable slot **2** and lock it with the cable lock key **3**.

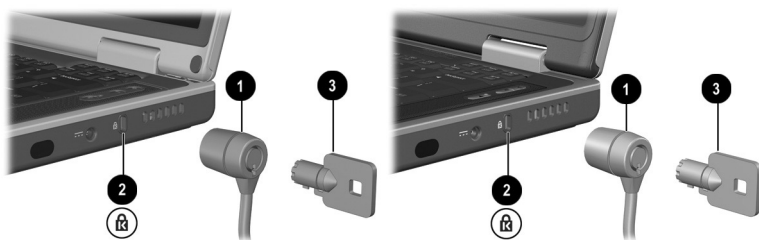

Connecting an optional cable lock

Software Updates, Restorations and Utilities

Contents

| | |
|---|------|
| Updating Software | 9-2 |
| Preparing for a Software Update | 9-2 |
| Downloading and Installing an Update | 9-4 |
| Backing Up and Restoring Data. | 9-7 |
| Setting a System Restore Point | 9-7 |
| Restoring to a System Restore Point | 9-7 |
| Repairing or Reinstalling the Operating System | 9-8 |
| Repairing the Operating System | 9-8 |
| Reinstalling the Operating System | 9-9 |
| Reinstalling Device Drivers and Other Software. | 9-10 |
| Installing a Retail Version of an Operating System. | 9-11 |
| Using the Setup Utility. | 9-11 |
| Opening the Setup Utility | 9-11 |
| Navigating and Selecting in the Setup Utility | 9-12 |
| Restoring Setup Utility Default Settings | 9-12 |
| Exiting the Setup Utility | 9-12 |
| Using the Support Utilities. | 9-13 |
| Using the Help and Support Window | 9-13 |
| Using Support Telephone Numbers | 9-14 |

Updating Software

For optimal notebook performance and to make sure your notebook remains compatible with changing technologies, install the latest versions of the software provided with your notebook as they become available.

To update notebook software:

1. Prepare for any update by identifying your notebook type, series or family, and model.

Prepare for a ROM (read-only memory) update by identifying the ROM version currently installed on the notebook.

2. Access the updates at the HP Web site.
3. Download and install the updates.



The notebook ROM stores the BIOS (basic input-output system). The BIOS determines how the notebook hardware interacts with the operating system and external devices and also supports such notebook services as time and date.

Preparing for a Software Update

If your notebook connects to a network, consult with your network administrator before installing any software updates, particularly a ROM update.

Accessing Notebook Product Information

To access the updates for your notebook, you will need the following information:

- The product *category* is Notebook.
- The product *family name* and *series number* are printed on the display bezel.
- More complete *model* information is provided on the serial number label on the underside of the notebook.

The product name, notebook model, and notebook serial number are also displayed in the same section of the Setup utility that displays ROM information, as described in the next section.

Accessing Notebook ROM Information

To determine whether an available ROM update is a later ROM version than the ROM version currently installed on the notebook, you need to know the version of the currently installed ROM.

ROM information is displayed in the Setup utility. The Setup utility is a non-Windows utility that does not support the TouchPad. For complete information about using the Setup utility, see the “Using the Setup Utility” section in Chapter 9.

1. To open the Setup utility, turn on or restart the notebook.
2. Before Windows opens and while the F10 = ROM Based Setup prompt is displayed in the lower left section of the screen, press **F10**.
3. Use the arrow keys to select the File menu, then press **enter**.

4. Use the down arrow key to select System Info, then press **enter**. (The ROM version and date are displayed in the System BIOS Version field.)
5. To close the System Info window and exit the Setup utility without changing any settings:
 - a. Press **esc** to close the window.
 - b. Use the arrow keys to select the File menu, then press **enter**.
 - c. Use the arrow keys to select Ignore changes and exit, then press **enter**.

Downloading and Installing an Update

Most software at the HP Web site is packaged in a compressed file called a *SoftPaq*. Some ROM updates may be packaged in a compressed file called a *RomPaq*.

Most download packages contain a file named Readme.txt. A Readme.txt file contains detailed descriptive, installation, and troubleshooting information about the download. The Readme.txt files included with RomPaqs are English only.

The following sections provide instructions for downloading and installing:

- A ROM update.
- A SoftPaq containing an update other than a ROM update.

Downloading and Installing a ROM Update



CAUTION: To prevent serious damage to the notebook or an unsuccessful installation, download and install a ROM update only while the notebook is connected to reliable external power using the AC adapter or a DC cable. (Do not download or install a ROM update while the notebook is docked or running on battery power.) During the download and installation:

- Do not unplug the notebook from the electrical outlet.
 - Do not shut down the notebook or initiate Standby or Hibernation.
 - Do not insert, remove, connect, or disconnect any device, cable, or cord.
-

Downloading a ROM Update:

1. Access the page at the HP Web site that provides software for your notebook: Select Start > Help and Support, then select a software update link. Or, visit the HP Web Site at:
<http://www.hp.com/support>
2. Follow the instructions on the screen to identify your notebook and access the ROM update you want to download.
3. At the download area:
 - a. Record the date, name, or other identifier of any ROM update that is later than the ROM currently installed on your notebook. (You may need to identify the update later, after it has been downloaded to the hard drive.)
 - b. Record the path to the default or custom location on the hard drive to which the ROM package will download. (You may need to access the ROM package after it has been downloaded.)
 - c. Follow the online instructions to download your selection to the hard drive.

Installing a ROM Update

ROM installation procedures vary. Follow any instructions that are displayed on the screen after the download is complete. If no instructions are displayed:

1. Open Windows Explorer. To open Windows Explorer from the Start button, select Start > All Programs > Accessories > Windows Explorer.
2. In the left pane of the Windows Explorer window, select My Computer > your hard drive designation. (The hard drive designation is typically Local Disk C.) Then follow the path you recorded earlier to the folder on your hard drive containing the update.
3. To begin the installation, open the folder, then double-click the file with an .exe extension, for example, Filename.exe. (The ROM update installation begins.)
4. To complete the installation, follow the instructions on the screen.



After a message on the screen reports a successful installation, you can delete the downloaded file from the destination folder.

Downloading and Installing a Non-ROM SoftPaq

To update software other than a ROM update:

1. Access the page at the HP Web site that provides software for your notebook: Select Start > Help and Support, then select a software update link. Or, visit the HP Web site at:
<http://www.hp.com/support>
2. Follow the instructions on the screen to identify your notebook and access the SoftPaq you want to download.
3. At the download area:
 - a. Write down the date, name, or other identifier of the SoftPaq you plan to download. (You will need to identify the update later, after it has been downloaded to the hard drive.)
 - b. Follow the online instructions to download the SoftPaq to the hard drive.
4. When the download is complete, open Windows Explorer. To open Windows Explorer from the Start button, select Start > All Programs > Accessories > Windows Explorer.
5. In the left pane of the Windows Explorer window, select My Computer > your hard drive designation, which is typically Local Disk C > HP.
6. In the HP folder, select the name or number of the software package you have downloaded.
7. Select the file that includes an .exe extension, for example, Filename.exe. (The installation begins.)
8. To complete the installation, follow the instructions on the screen.



After a message on the screen reports a successful installation, you can delete the downloaded file from the HP folder.

Backing Up and Restoring Data

The System Restore utility enables you to safeguard your system files and functional configurations by using System Restore points.

System Restore points are restorable, benchmark “snapshots” of your system. The notebook may set System Restore points whenever you change personal settings or add software or hardware. Setting System Restore points manually provides additional protection for your system files and settings. HP recommends that you set System Restore points:

- Before you add or extensively modify software or hardware.
- Periodically, whenever the system is performing optimally.

Setting a System Restore Point

To set a System Restore point manually:

1. Select Start > Help & Support > Tools. (Notebook and diagnostic information is displayed.)
2. Select System Restore, then follow the on-screen instructions for setting a Restore Point.

Restoring to a System Restore Point

To restore the notebook to a System Restore point:

1. Select Start > Help & Support > Tools. (Notebook and diagnostic information is displayed.)
2. Select System Restore, then follow the on-screen instructions for restoring the notebook to a Restore Point.

Repairing or Reinstalling the Operating System

The OS CD included with your notebook can be used to repair or reinstall the operating system. Both operations may take one to 2 hours to complete.

- Repairing the operating system preserves your data and settings.
- Reinstalling the operating system deletes all files on the notebook. After the operating system has been reinstalled, all device drivers must also be reinstalled.

HP recommends that you try to restore your system by using the System Restore utility before you consider repairing or reinstalling your operating system. For restoration instructions, see “Backing Up and Restoring Data” earlier in this chapter.

If a System Restore restoration fails to restore functionality, first try to repair the operating system. If the repair procedure does not restore functionality, you may need to reinstall the operating system.

Repairing the Operating System

To repair the operating system without deleting your personal data:

1. Connect the notebook to external power and turn on the notebook.
2. Immediately insert the OS CD (included with the notebook) into the optical drive.
3. Press and hold the power button for 5 seconds to turn off the notebook.
4. Briefly press the power button to start the notebook.
5. When prompted, press any key to boot from CD. (After a few minutes, the Welcome to Setup screen is displayed.)

6. Press **enter** to continue. (A Licensing Agreement screen is displayed.)
7. Press **F8** to accept the agreement and continue. (The Setup window is displayed.)
8. Press **R** to repair the selected Windows installation. (The repair process begins.)

After the repair process is complete, which may take up to 2 hours, the notebook restarts in Windows.

Reinstalling the Operating System

If the System Recovery and operating system repair procedures did not restore functionality to your notebook, it may be necessary to reinstall the operating system.



CAUTION: Personal data and any software you have installed on the notebook will be lost during the operating system reinstallation procedure described in this section. To protect your data, back up your My Documents folder before beginning the procedure. For back up information and instructions, select Start > Help and Support. Also see "Backing Up and Restoring Data" earlier in this section.



During the reinstallation, you may be prompted for your product key. The product key is displayed on the Microsoft Certificate of Authenticity label affixed to the underside of the notebook.

To reinstall the operating system using the OS CD included with the notebook:

1. Connect the notebook to external power and turn on the notebook.
2. Immediately insert the OS CD into the optical drive.
3. Press and hold the power button for 5 seconds to turn off the notebook.
4. Briefly press the power button to start the notebook.
5. When prompted, press any key to boot from CD. (After a few minutes, the Welcome to Setup screen is displayed.)

6. Press **enter** to continue. (A Licensing Agreement screen is displayed.)
7. Press **F8** to accept the agreement and continue. (The Setup window is displayed.)
8. Press **esc** to continue installing a fresh copy of the operating system.
9. Press **enter** to set up the operating system.
10. Press **C** to continue setup using this partition.
11. Select Format the partition using the NTFS file system (Quick), then press enter. (A caution is displayed. The caution explains that formatting this drive will delete all current files.)
12. Press **F** to format the drive. (The reinstallation process begins.)

After the repair process is complete, which may take up to 2 hours, the notebook restarts in Windows, and you can begin to reinstall device drivers.

Reinstalling Device Drivers and Other Software

After the installation process is complete, you must reinstall drivers.

To reinstall drivers using the Driver Recovery CD included with the notebook:

1. While running Windows, insert the Driver Recovery CD into the optical drive.

If the CD does not open within several seconds, select Start > Run. Then type D:\SWSETUP\APPINSTL\SETUP.EXE (where D indicates the optical drive).

2. Follow the on-screen instructions for installing drivers.

After the drivers are reinstalled, you must reinstall any software you added to the notebook. Reinstallation instructions are usually provided on the software CD, in the CD package, or at the manufacturer's Web site.

Installing a Retail Version of an Operating System

The Windows operating system provided on the notebook or on a restoration CD is enhanced by HP. The HP enhancements add power and security features and provide supplementary support for external devices such as drives and PC Cards.



CAUTION: Replacing an operating system enhanced by HP with a retail version of an operating system will result in the loss of all HP enhancements. In some cases, the loss of these enhancements may result in an unresponsive system or the loss of complete USB support.

Using the Setup Utility

The Setup utility is a preinstalled, ROM-based information and customization utility that can be used even when your operating system is not working or will not load.

The utility reports information about the notebook and provides settings for startup, password, port, Setup utility appearance, and other preferences.

Opening the Setup Utility

To access most settings:

1. Start up or restart the notebook.
2. Before Windows opens and while the F10 = ROM Based Setup prompt is displayed in the lower left corner of the screen, press **F10**.

On some models, you must start up (not restart) the notebook to access the settings for a hard drive password.

Navigating and Selecting in the Setup Utility

Because the Setup utility is not Windows-based, it does not support the TouchPad. Navigation and selection are by keystroke.

- To navigate, use the up and down arrow keys or **tab**.
- To select an item, use the arrow keys to select the item, then press **enter**.
- To close a display but remain in the Setup utility, press **esc**.

An on-screen guide to navigation and selection is displayed at the lower edge of most Setup utility submenu screens. To minimize keystrokes by using the <Alt> Key Activates Accelerators feature:

1. Press and hold **alt**. (A letter or number in most on-screen items is highlighted.)
2. Press the keyboard key corresponding to the highlighted letter or number in the item you want to select.

For example, to select an on-screen OK button, press **alt**. When the “O” in OK is highlighted, press **O**.

Restoring Setup Utility Default Settings

To return all Setup utility settings to default values, select File menu > Restore Defaults. (Identification information, including ROM version information, is retained.)

Exiting the Setup Utility

The Setup Utility exit options are on the File menu. When you select either option, Windows opens after the Setup utility closes.

- To close the utility and save your changes from the current session, select Save changes and exit.
- To close the utility without saving changes from the current session, select Ignore changes and exit.

Using the Support Utilities

If you cannot solve a notebook problem by using this guide or the supplementary information, including the *Troubleshooting* guide, on the *Documentation Library* CD, you may need to contact HP.

Using the Help and Support Window

Select Start > Help and Support or press the **Fn+F1** hotkeys. The Help and Support window provides access to information about using your operating system and to support areas of the HP Web site.

Most of the support areas are available in several languages, but some links may be unavailable in some regions. You can use the links in the Help and Support window to:

- Initiate an online service event with a support specialist.
- Download the latest drivers, utilities, and software updates for your notebook.
- Obtain information about your notebook such as specifications, white papers, customer advisories, and all documentation included with your notebook.

Using Support Telephone Numbers

Obtaining Support Telephone Numbers

To obtain a list of worldwide customer support telephone numbers, use either of the following methods:

- Select Start > Control Panel > Performance and Maintenance icon > System icon. Then, near the lower edge of the System Properties window, select the Support Information button.
- Refer to the *Worldwide Telephone Numbers* booklet (English only) included with your notebook to contact an HP Customer Care Center.

Preparing to Call Technical Support

To provide the fastest possible resolution of your problem, have the notebook and the following information available when you call:

- Serial number and model description, which are provided on labels affixed to the notebook.
- Purchase date on the invoice.
- Conditions under which the problem occurred.
- Error messages that have been displayed.
- Operating system version number and registration number.
- To display the operating system version number and registration number, select Start > Control Panel > Performance and Maintenance icon > System icon > General tab.
- Brand and model of an optional printer.

A

Specifications

The information in this appendix may be helpful if you plan to use or transport the notebook internationally or in extreme environments.

Notebook Dimensions

| Dimension | U.S. | Metric |
|------------------|--------------|---------------|
| Height | 1.24 inches | 3.15 cm |
| Width | 14.06 inches | 35.7 cm |
| Depth | 10 inches | 25.4 cm |

Operating Environment

| Factor | U.S. | Metric |
|--|---------------|---------------|
| Temperature | | |
| Operating | 50° to 95° F | 10° to 35° C |
| Nonoperating | -4° to 140° F | -20° to 60° C |
| Relative humidity (noncondensing) | | |
| Operating | 10% to 90% | 10% to 90% |
| Nonoperating | 5% to 95% | 5% to 95% |
| Maximum altitude (unpressurized) | | |
| Operating | 10,000 ft | 3,048 m |
| Nonoperating | 30,000 ft | 9,144 m |

Rated Input Power

The notebook operates on DC power, which can be supplied by an AC or a DC power source. Although the notebook can be powered from a stand-alone DC power source, HP strongly recommends that the notebook be powered only with an AC adapter or DC cable supplied or approved by HP.

An AC adapter provided by HP for use with this notebook is capable of accepting AC power within the following specifications:

| Input Power | Rating |
|---------------------------|------------------------------|
| Operating voltage | 100–240V AC @ 1.7A - 50–60Hz |
| Operating current | 1.5A rms |
| Operating frequency range | 50 to 60Hz |

The notebook is capable of accepting DC power within the following specifications:

| Input Power | Rating |
|--------------------|-----------------------|
| Operating voltage | 18.5V DC @ 3.5A - 65W |
| Operating current | 4.9A |

This product is designed for IT power systems in Norway with phase-to-phase voltage not exceeding 240 Vrms.

Finding More Environmental Information

The specifications in this appendix contain information about exposing the notebook to environmental extremes.

- For similar information about storing battery packs, see the “Storing a Battery Pack” section in Chapter 4.
- For information about exposing the notebook to sunlight, ultraviolet light, x-rays, or magnetic fields, refer on the *Documentation Library CD* to the *Maintenance, Shipping and Travel* guide.

Index

1394 connector 2–9

A

AC adapter 4–11

connecting 1–5, 4–11

disconnecting 4–11

identifying 2–17

power connector 2–12

AC power 1–16, 4–11

adapter

AC 1–5, 2–17, 4–11

country-specific modem 2–17,
7–3, 7–5

Japan-specific outlet 2–17

Agere 7–9

*Agere Command Set (Advanced
Users Only)* 2–18

Agere modem AT commands 7–9

Aironet, Cisco WLAN products
1–13

airport security devices 5–3

altitude specifications A–1

antennas 2–4, 2–12

antivirus software 1–15

applications key 2–4

applications. *See* software;
software updates

AT commands 2–18, 7–9

audio CD. *See* CD(s)

audio-out jack

connecting 6–4

identifying 2–8

AutoPlay 5–8

B

backup, system 9–8

battery bay

identifying 2–13

inserting battery pack 1–3

removing battery pack 4–18

battery light 2–6

battery pack

calibrating 4–14

causing CD or DVD write

corruption 6–10

charging 1–2, 1–6, 4–11

inserting 1–3

monitoring charge 4–12

removing 4–18

storing 4–16

when to remove 4–3

battery power

conserving 4–17

low-battery conditions 4–13

running notebook on 4–11

- switching to and from 4–11
 - when to use 1–14, 4–4
- BIOS (basic input output system) 9–2
- Bluetooth device 1–11
- boot order 5–10
- button(s)
 - PC Card eject 2–11, 8–6
 - power 2–5
 - TouchPad 2–3, 3–3
 - volume 2–7, 6–2
 - wireless device 1–11, 2–6, 2–8
 - See also* key; latch; switch, display
- C**
- cable
 - AC adapter 1–5
 - audio 6–5
 - DC 2–12
 - modem 2–9, 2–16, 7–2
 - network 2–16, 7–11
 - S-Video 6–5
 - See also* cord, power
- cable lock, connecting 8–16
- calibration, battery 4–14
- caps lock light 2–6
- card and socket services, PC Card 8–4
- card. *See* memory, modules supported; PC Card; SD Card
- CD drive. *See* drives
- CD(s)
 - CD-R vs. CD-RW 6–10
 - copying 6–9
 - creating 6–9
 - playing, with Windows Media Player 6–7
 - playing, with WinDVD 6–7
 - starting from 5–10
 - See also* drive media
- Certificate of Authenticity label 2–15, 9–10
- certification, WiFi 1–13
- Cisco Aironet WLAN products 1–13
- Cisco Compatible Extension program 1–13
- commands, AT 2–18, 7–9
- compartment, memory 2–13, 8–10
- connector(s)
 - 1394 2–9
 - docking 2–14
 - drive 5–3
 - external monitor 2–9
 - infrared port 2–12, 7–13
 - modem 2–9, 7–3
 - network 2–9, 7–10
 - parallel 2–9
 - power 2–12
 - USB 2–9, 8–2
- conservation, power 4–17
- cord, power
 - connecting 1–5
 - identifying 2–16
 - surge protection 1–14
 - See also* cable
- country-specific modem adapter
 - connecting 7–5
 - identifying 2–17
 - when to use 7–3
- critical low-battery condition 4–13

currency formats, setting 1–10
customer support 2–18, 9–14

D

data compression algorithm 7–2
date, setting the 1–10
DC cable 1–8, 2–12
designation, drive 5–2
device drivers, reinstalling 9–11
dialing mode 7–7
dimensions, notebook A–1
disc, diskette. *See* drive media
display release latch 2–2
display switch 2–5
 function, changing 4–9
 function, default 4–6
 identifying 4–5
display, internal
 brightness 3–7
 opening 1–4
 switching image 3–6
docking connector, cover 2–14
drive designation 5–2
drive media
 affected by airport security 5–3
 cancelling AutoPlay on 5–8
 caring for 5–3
 displaying contents of 5–8
 inserting, removing CD or
 DVD 5–5
 types and terms 5–2
drivers, reinstalling 9–11
drives
 adding to system 5–4
 affected by airport security 5–3

 avoiding Standby and
 Hibernation while using
 optical 5–9
 IDE drive light 5–4
 inserting, removing media 5–5
 shipping 5–3
 starting from 5–10
 types and terms 5–2
 USB 8–2
 See also hard drive, internal
DVD drive. *See* drives
DVD(s)
 playing, with WinDVD 6–7
 region settings 6–8
 starting from 5–10
 See also drive media

E

Easy CD Creator
 CD Copier, when to use 6–9
 DirectCD, when to use 6–9
 features 6–9
 formats 6–11
 obtaining 6–9
 preparing to use 6–10
 prompt, UDF 6–10
 settings 6–12
 source drive vs. destination
 drive 6–10
eject button
 optical drive 5–6
 PC Card 8–6
electric shock warning 1–16
electrical storm, safety issues 1–14
electrostatic discharge (ESD) 5–3,
 8–11

- emergency shutdown procedures
 - 1–10, 4–6
- enablers, PC Card 8–4
- End User License Agreement 1–8
- environmental specifications A–1
- error message
 - No Dial Tone 7–8
 - Playback Of Content From This Region Not Permitted 6–7
- ESD (electrostatic discharge) 5–3, 8–11
- exhaust vent 2–10
- external monitor
 - connecting 8–2
 - connector 2–9
 - switching image 3–6
- F**
- fan, vents 2–10, 2–14
- FCC notice 1–16
- FDD (floppy disk drive) 5–2
- flash memory card 8–7
- flash RAM card 8–7
- Fn key
 - changing Standby function 4–9
 - hotkeys function 3–4
 - identifying 2–4
 - keypad functions 3–10
 - Standby function 4–5
 - video device function 6–6
- function keys 2–4, 3–4
- H**
- hard drive bay
 - identifying 2–13
 - replacing hard drive 5–10
- hard drive, internal
 - defined 5–2
 - displaying amount of free space on 8–10
 - replacing 5–10
 - retaining screws 5–11, 5–14
 - space on, required for
 - Hibernation file 8–10
 - See also* drives
- headphones 6–4
- Help and Support window 3–6, 9–14
- Hibernation
 - avoiding when playing media 5–9
 - changing configuration during 4–2
 - controls and indicators 4–5
 - defined 4–2
 - identifying 5–10
 - initiated during critical
 - low-battery condition 4–13
 - initiating 2–5, 4–8
 - resuming from 4–8
 - setting preferences 4–9
 - when to use 4–2
- hotkeys
 - changing function of Fn+F5 4–9
 - identifying 3–4
 - procedures 3–6
 - Quick Reference 3–5
- hotkeys commands
 - access Help and Support 3–6
 - display brightness 3–7
 - initiate QuickLock 3–7

- initiate Standby 3–7, 4–7
- media commands 3–8
- Open Internet Explorer 3–6
- Quick Reference 3–5
- switch image 3–6
- hub, USB 8–2
- humidity specifications A–1

I

- IDE (Integrated Drive Electronics)
 - light 5–4
- identifying components
 - additional 2–16
 - display 2–2
- IEC 60950 compliance 1–16
- IEEE 802.11 compliance 1–13
- infrared port 2–12, 7–13
- International Telecommunications Union (ITU) 7–2
- InterVideo WinDVD
 - error message 6–7
 - managing region settings 6–8
 - playing video CDs and DVDs 6–7
- ITU (International Telecommunications Union) 7–2

J

- jack
 - audio-out 2–8, 6–4
 - microphone 2–8, 6–4
 - RJ-11 2–9, 7–3
 - RJ-45 2–9, 7–11
 - S-Video 2–8, 2–9, 6–5
- Japan-specific modem adapter 2–17

K

- key
 - applications 2–4
 - Fn 2–4
 - function (F1, F2, etc.) 2–4
 - hotkeys 3–4
 - keypad 2–4, 3–9
 - num lock 3–10
 - Windows logo 2–4
 - See also* button(s); latch; switch, display
- keyboard language 1–10

L

- label
 - Microsoft Certificate of Authenticity 2–15, 9–10
 - modem approvals 2–15
 - product identification 2–15
 - system 2–15
 - wireless certification 2–15
- language
 - choosing during setup 1–8
 - selecting keyboard 1–10
- latch
 - battery pack locking 4–19
 - battery pack release 2–13
 - display release 2–2
 - See also* button(s); switch, display
- light(s)
 - battery 2–6
 - caps lock 2–6
 - hard drive 2–6
 - IDE drive 5–4
 - mute 2–6

- num lock 3–10
- power/standby 2–6
- wireless device 1–11, 2–6
- line-out jack 2–8, 6–4
- lock, security cable 8–16
- locked system
 - emergency shutdown procedures 1–10, 4–6
- locking latches, battery pack 4–19
- lock-up, system 2–5
- low-battery conditions
 - identifying 4–13
- M**
- Maintenance, Shipping and Travel* guide 2–18
- media hotkeys 3–8
- Media Player, Windows 6–7
- media, drive
 - affected by airport security 5–3
 - cancelling AutoPlay on 5–8
 - caring for 5–3
 - displaying contents of 5–8
 - inserting, removing CD or DVD 5–5
 - types and terms 5–2
 - See also* drives
- memory
 - compartment 2–13
 - displaying amount of 8–10
 - increasing RAM 8–10
 - module, removing or inserting 8–11
 - modules supported 8–10
- microphone jack 2–8

- microphone, connecting 6–4, 8–2
- Microsoft Certificate of Authenticity label 2–15
- mode, dialing 7–7
- model, identifying notebook 9–3
- modem
 - Agere Command Set (Advanced Users Only)* 2–18
 - approvals label 2–15
 - cable 2–16
 - connecting 7–3
 - country configurations 7–6
 - country-specific adapter 2–17
 - Modem Command Guidelines (Advanced Users Only)* 2–18
 - specifications 7–2
 - speed 7–2
 - troubleshooting travel connections 7–7
 - virus protection 1–15
- monitor, external
 - connecting 8–2
 - external monitor connector 2–9
 - switching display 3–6
- mouse, external
 - connecting 8–2
 - USB connectors 2–9
- multimedia card 8–7
- N**
- network
 - cable 2–16
 - connecting 7–11
 - RJ-45 jack 2–9
 - specifications 7–10
 - speed 7–10

No Dial Tone error message 7–8
Norton AntiVirus 2003 1–15
notebook model, family, type, and
 serial number 9–3
NTSC television format 6–6
num lock
 key 3–10
 light 2–6
number
 Product Key 2–15
 serial 2–15
numeric keypad 3–9

O

opening the notebook 1–4
operating environment
 specifications A–1
operating system
 installing retail version of 9–12
 loading 4–6
 Microsoft Certificate of
 Authenticity label 2–15
 Product Key number 2–15
 reinstalling 9–9
 repairing 9–9
 shutting down 4–6
optical disc. *See* CD(s); DVD(s)
optical drive
 avoiding Standby and
 Hibernation while using 5–9
 boot order 5–10
 identifying 2–11
 See also drives

P

PAL, PAL-M television formats
 6–6
parallel connector 2–9
passwords 9–12
PC Card
 configuring 8–4
 functions 8–4
 inserting, removing 8–5
 stopping 8–6
 types available 8–4
PC Card eject button 2–11
pointing device 3–3
port, infrared 2–12, 7–13
power
 button 2–5
 connecting the notebook to
 external 1–5
 conservation 4–2, 4–17
 controls 4–5
 cord 2–16
 emergency shutdown
 procedures 4–6
 Hibernation procedures 4–6
 low-battery conditions 4–13
 power connector 2–12
 power/standby light 2–6
 rated input A–2
 setting preferences 4–9
 shutting down the notebook
 1–10
 Standby procedures 4–7
 surge protection 1–14

- switching between AC and battery 4–11
- turning on the notebook 1–7
- See also* battery pack
- power button
 - function, changing 4–9
 - identifying 4–5
 - resetting with 4–6
- power connector
 - connecting 1–5
 - identifying 2–12
- power cord
 - connecting 1–5
 - surge protection 1–14
- Power Meter 4–12
- power, AC 1–16
- power/standby light 4–5
- Preboot eXecution Environment (PXE) 7–12
- preloaded utilities
 - Bluetooth device 1–12
 - displaying descriptions 1–9
 - HP setup and configuration utility for wireless LAN devices 1–13
- Product Key number 2–15
- projector
 - connecting 2–9, 8–2
 - switching display 3–6
- PXE (Preboot eXecution Environment) 7–12

R

- RAM (Random Access Memory) 8–10
- recovery CD 2–18
- region settings
 - currency, date, language, time 1–10
 - DVD 6–8
 - modem 7–6
- Regulatory and Safety Notices* guide 2–18
- regulatory information
 - modem approvals label 2–15
 - notices 1–16
 - Regulatory and Safety Notices* guide 2–18
 - system label 2–15
 - wireless certification label 2–15
- release latch
 - battery pack 2–13
 - display 2–2
- repairing the operating system 9–9
- reset (emergency shutdown procedures) 1–10, 4–6
- resolution, screen 1–10
- restoring software 2–18
- RJ-11 telephone jack
 - connecting 7–3
 - identifying 2–9
 - modem cable 2–16
- RJ-45 network jack
 - connecting 7–11
 - identifying 2–9
 - network cable 2–16

-
- ROM
 - defined 9-2
 - determining current version of 9-3
 - downloading and installing 9-5
 - obtaining updates 9-4
 - RomPaq, downloading 9-4
 - S**
 - Safety & Comfort Guide* 1-16, 2-18
 - SD Card 8-7
 - security cable
 - lock, connecting 8-16
 - slot 2-12
 - serial number, notebook 2-15, 9-3
 - series, notebook 9-3
 - Setup utility 9-12
 - shutdown procedures 1-10, 4-6
 - sleep button 3-7, 4-9
 - Sleep. *See* Standby
 - slot
 - memory 8-10
 - PC Card 2-11
 - SD Card 8-7
 - security cable 2-12
 - socket services, PC Card 8-4
 - SoftPaq
 - described 9-4
 - downloading and installing 9-7
 - software
 - antivirus protection 1-15
 - AutoPlay 5-8
 - Easy CD Creator 6-9
 - Help and Support window 9-14
 - infrared 7-13
 - installing optional 1-9
 - modem 7-6
 - network 7-12
 - Norton AntiVirus 2003 1-15
 - Power Meter 4-12
 - regional settings 1-10
 - reinstalling 9-9, 9-11
 - repairing 9-9
 - restoring 2-18
 - RomPaq 9-4
 - Setup utility 9-12
 - SoftPaq 9-4
 - UDF Reader 6-10
 - updating preloaded software 9-2
 - Windows Media Player 6-7
 - WinDVD 6-7
 - software updates
 - downloading and installing 9-5, 9-7
 - obtaining 9-4
 - preparing for 9-3
 - speakers, external 6-4
 - speakers, internal 6-3
 - specifications
 - dimensions A-1
 - modem 7-2
 - network 7-10
 - operating environment A-1
 - rated input power A-2
 - Standby
 - avoiding when playing media 5-9
 - avoiding when using infrared 7-14
 - controls and indicators 4-5

- initiated during critical
 - low-battery condition 4–13
 - initiating 3–7, 4–7
 - power/standby light 2–6
 - resuming from 4–7
 - setting preferences 4–9
- S-Video**
- connections 6–5
 - jack 2–9
- switch, display 2–5
- system label 2–15
- system lock-up 1–10, 4–6
- System Restore utility 9–8
- T**
- technical support 9–14
 - notebook documentation 2–18
- telephone (RJ-11) jack
 - connecting 7–3
 - identifying 2–9
 - modem cable 2–16
- telephone numbers, service and support 9–14
- television
 - changing color format 6–6
 - connecting audio 6–4
 - connecting video 6–5
- temperature
 - notebook surface 1–16
 - specifications A–1
 - storage, battery pack 4–16
- 1394 connector 2–9
- time, setting 1–10
- TouchPad
 - components 3–3
 - setting preferences 3–3
- traveling with notebook
 - battery pack temperature considerations 4–16
 - environmental specifications A–1
 - modem approvals label 2–15
 - serial number 2–15
 - wireless certification label 2–15
- traveling with the notebook
 - modem country configurations 7–6
 - regional settings 1–10
- troubleshooting
 - modem travel connections 7–7
 - Troubleshooting* guide 2–18
- turning off notebook 1–10, 4–6
- turning on notebook 1–7, 4–6
- U**
- UDF Reader 6–10
- unresponsive system, emergency shutdown procedures 1–10, 4–6
- USB**
- connectors, identifying 2–9
 - devices, connecting 8–2
- utilities, preloaded
 - displaying descriptions 1–9
 - HP wireless setup and configuration 1–13
 - installing 1–9
 - See also* software

V

VCR

- audio-out jack
 - function 6–4
- connecting 6–5

vents, fan 2–10, 2–14

video CDs, DVDs. *See* CD(s); DVD(s)

video device

- connecting audio 6–5
- S-Video jack 6–5
- turning on and off 6–6

viruses, computer 1–15

volume, adjusting 6–2

W

WiFi certification 1–13

Windows applications key 2–4

Windows logo key 2–4

Windows Media Player

- accessing with Digital Audio button 6–7
- using with audio CDs

WinDVD

- error message 6–7
- managing region settings 6–8
- playing video CDs and DVDs 6–7

wireless device

- button 1–11, 2–8
- certification label 2–15
- identifying 1–11
- light 1–11, 2–6
- setting up 1–11

WLAN products, Cisco Aironet 1–13

© 2003 Hewlett-Packard Development Company, L.P.

Microsoft and Windows are trademarks of Microsoft Corporation in the U.S. and/or other countries. SD Logo is a trademark.

The information contained herein is subject to change without notice. The only warranties for HP products and services are set forth in the express warranty statements accompanying such products and services. Nothing herein should be construed as constituting an additional warranty. HP shall not be liable for technical or editorial errors or omissions contained herein.

Startup and Reference Guide
HP Notebook Series
First Edition September 2003
Reference Number: zf3000
Document Part Number: 345561-001