

10 choose connection • velg tilkobling • välj anslutning • valitse yhteys • savienojuma izvēle
pasirinkite prisijungimą • valige ühendus

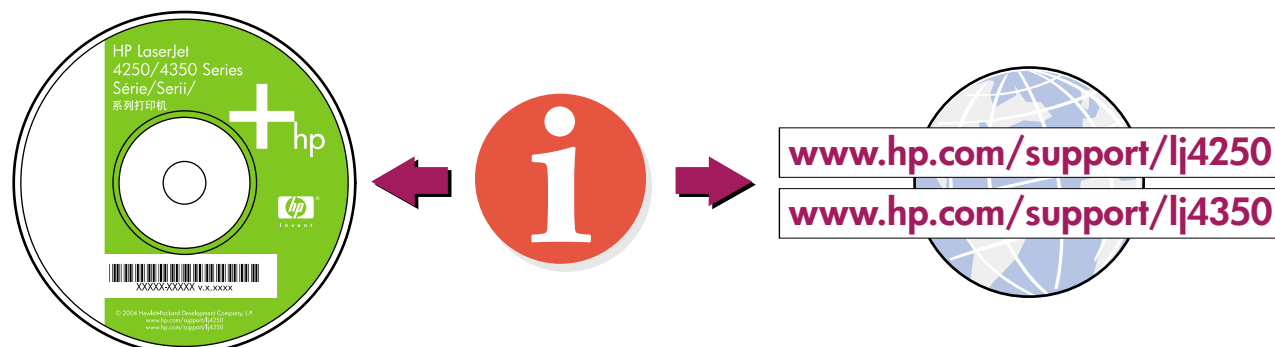
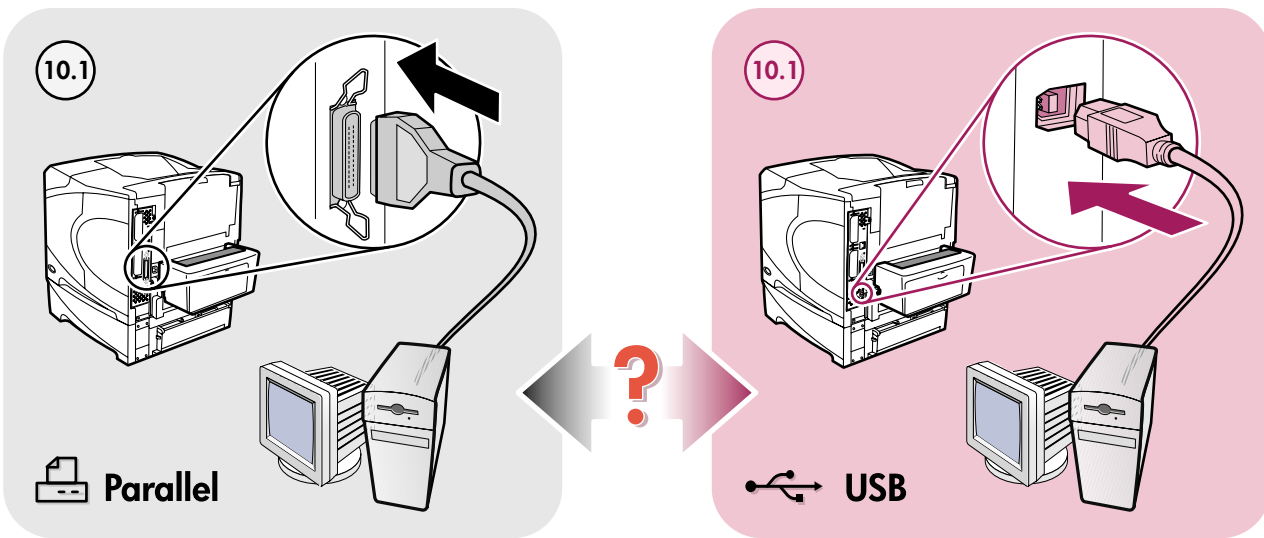

Additional Information

See the **electronic User Guide** on the CD-ROM that came with the printer for more information about the following topics.

- Detailed user instructions
- Troubleshooting information
- Important safety notice
- Regulatory information

This information is also available at www.hp.com/support/lj4250.

This information is also available at www.hp.com/support/lj4350.

Tilleggsinformasjon

Se i den elektroniske brukerhåndboken på CD-ROM-en som følger med skriveren, hvis du vil ha mer informasjon om følgende emner:

- Detaljerte bruksinstruksjoner
- Feilsøkningsinformasjon
- Viktige merknader om sikkerhet
- Spesielle bestemmelser

Disse opplysningene er også tilgjengelige på www.hp.com/support/lj4250.

Disse opplysningene er også tilgjengelige på www.hp.com/support/lj4350.

Mer information

Mer information om avsnitten nedan finns i den elektroniska användarhandboken på CD-ROM-skivan som medföljer skrivaren.

- Detaljerade användaranvisningar
- Felsökningsinformation
- Viktig säkerhetsinformation
- Föreskrifter

Den här informationen finns också på www.hp.com/support/lj4250.

Den här informationen finns också på www.hp.com/support/lj4350.

Lisätietoja

Katso lisätietoja seuraavista aiheista tulostimen mukana toimitetulla CD-levyllä olevasta sähköisestä käyttöoppaasta.

- Yksityiskohtaiset ohjeet
- Vianmääritystiedot
- Tärkeä turvaohje
- Tietoja säännöksistä

Nämä tiedot ovat saatavissa myös osoitteesta www.hp.com/support/lj4250.

Nämä tiedot ovat saatavissa myös osoitteesta www.hp.com/support/lj4350.

Papildinformācija

Skatiet elektronisko lietotāja rokasgrāmatu printera komplektācijā ietilpstošajā kompaktdiskā, lai iegūtu plašāku informāciju par šādām tēmām:

- detalizēta lietotāja pamācība;
- informācija par problēmu novēršanu;
- svarīgi paziņojumi par drošību;
- noteikumi.

Šī informācija ir pieejama arī internetā: <http://www.hp.com/support/lj4250>.

Šī informācija ir pieejama arī internetā: <http://www.hp.com/support/lj4350>.

Papildoma informācija

Prie spausdintuvo pridėtame vartotojo vadovo kompaktiniame diske ieskokite daugiau informacijos šiomis temomis.

- Išsamios vartotojo instrukcijos
- Trikčių diagnostikos informacija
- Svarbus saugumo įspėjimas
- Reglamentavimo informacija

Šios informācijas taip pat ieskokite www.hp.com/support/lj4250.

Šios informācijas taip pat ieskokite www.hp.com/support/lj4350.

Täiendav teave

Jārgmiste teemāde kohta leiate liseateavet printerikomplekti kuuluva CD-ROM-i elektroonilisest kasutusjuhendist.

- Üksikasjalikud kasutusjuhised
- Veoatsingu nõuanded
- Tähtsad ohutusnõuded
- Normatiivandmed

Sama teave on saadaval ka aadressil www.hp.com/support/lj4250.

Sama teave on saadaval ka aadressil www.hp.com/support/lj4350.

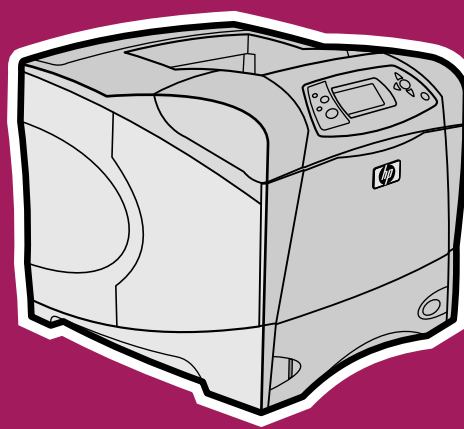

hp LaserJet 4250/4350 series

start
start
komma i gång
aloita
säkt
pradžia
alustage



Copyright Information

© 2005 Copyright Hewlett-Packard Development Company, L.P.
Reproduction, adaptation or translation without prior written permission is prohibited, except as allowed under the copyright laws.
The information contained herein is subject to change without notice.
The only warranties for HP products and services are set forth in the express warranty statements accompanying such products and services. Nothing herein should be construed as constituting an additional warranty. HP shall not be liable for technical or editorial errors or omissions contained herein.

FCC regulations

This equipment has been tested and found to comply with the limits for a Class B digital device, pursuant to Part 15 of the FCC rules. These limits are designed to provide reasonable protection against harmful interference in a residential installation. This equipment generates, uses, and can radiate radio frequency energy. If this equipment is not installed and used in accordance with the instructions, it might cause harmful interference to radio communications. However, there is no guarantee that interference will not occur in a particular installation. If this equipment does cause harmful interference to radio or television reception, which can be determined by turning the equipment off and on, the user is encouraged to try to correct the interference by one or more of the following measures:

- Reorient or relocate the receiving antenna.
- Increase separation between equipment and receiver.
- Connect equipment to an outlet on a circuit different from that to which the receiver is located.
- Consult your dealer or an experienced radio/TV technician.

Any changes or modifications to the printer that are not expressly approved by HP could void the user's authority to operate this equipment. Use of a shielded interface cable is required to comply with the Class B limits of Part 15 of FCC rules.
For more regulatory information, see the HP LaserJet 4250/4350 series printer use guide on the printer CD-ROM.

accessories • ekstrautstyr • tillbehör • lisävarusteet • piederumi • priedai • tarvikud

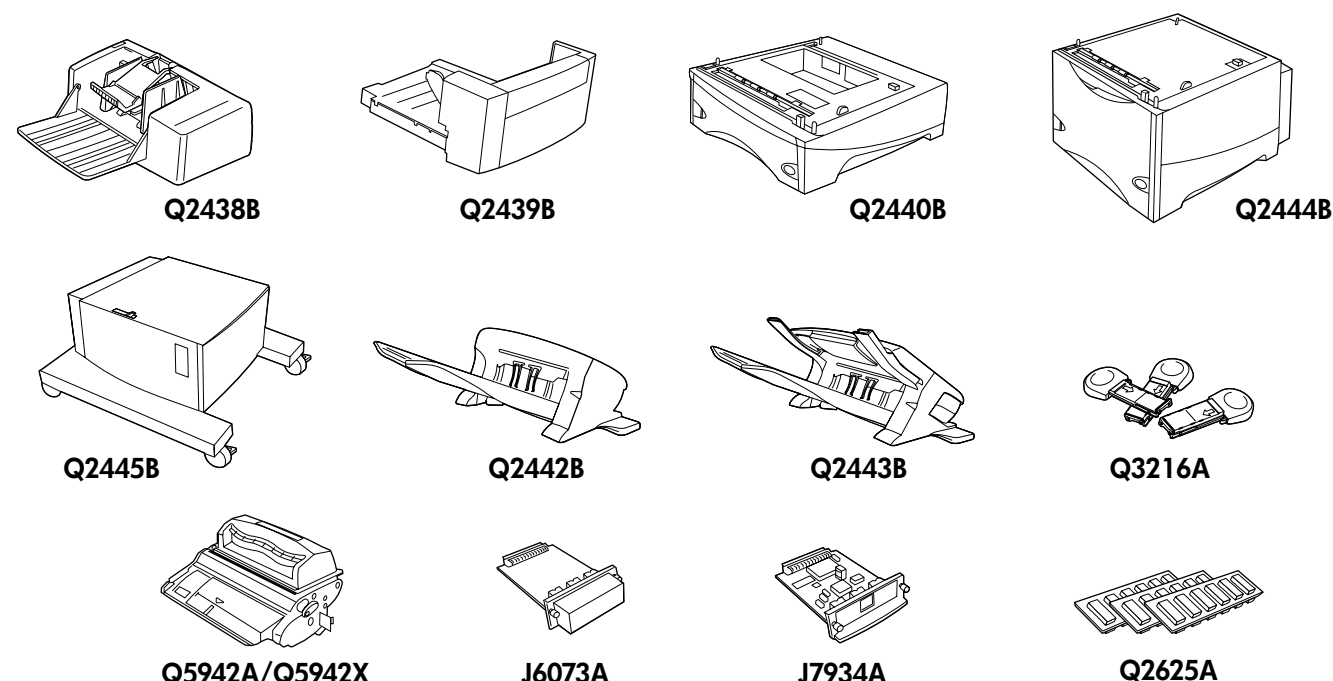

1 unpack printer • pakk ut skriveren • packa upp skrivaren • pura tulostin pakkauksesta • printera izsainošana
 ispakuokite spausdintuvą • pakkige printer lahti

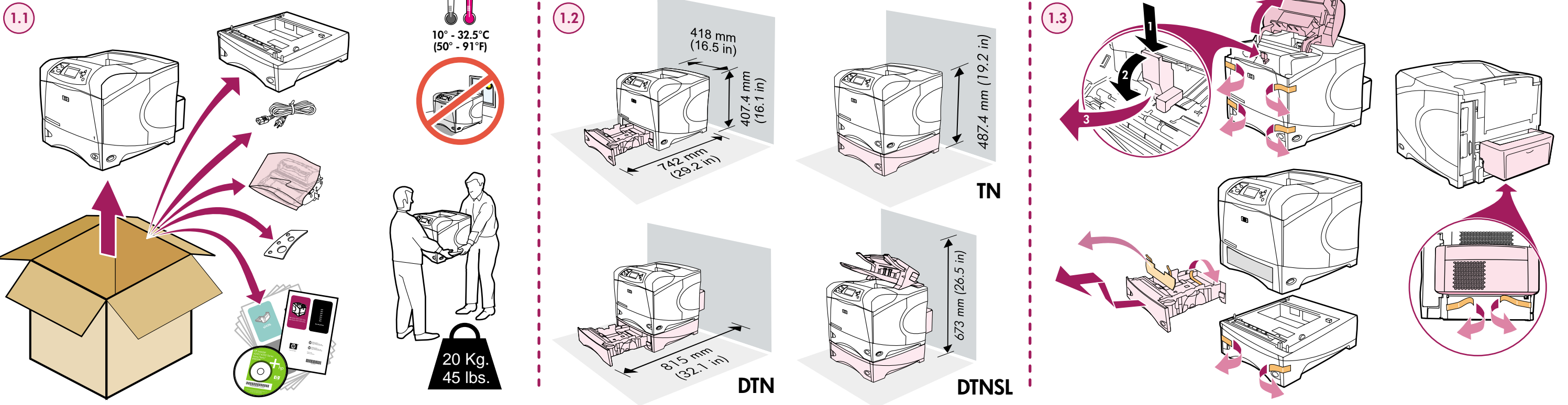

2 install accessories • installer ekstrastyr • installera tillbehör • asenna lisävarusteet • piederumu uzstādīšana
 iđiekite priedus • paigaldage lisaseadmed

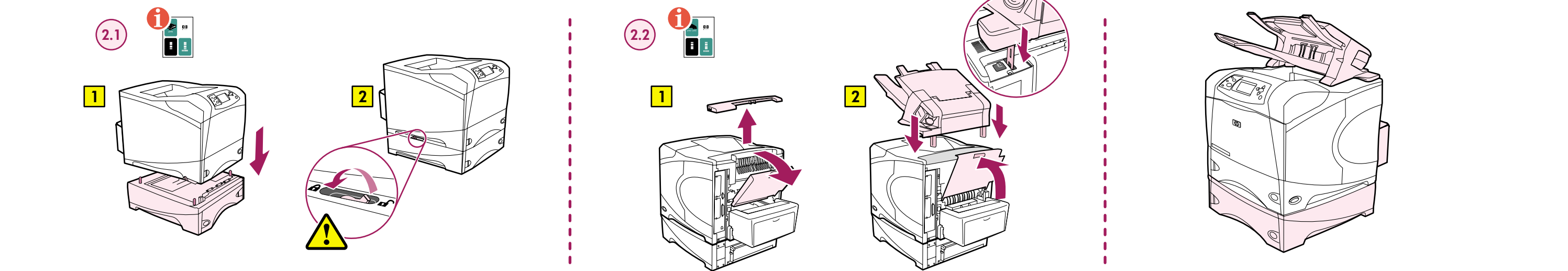

3 load all paper trays • sett pā pļass alle papirskuffer • fyll pā papper i alla fack • lataa paperia kaikkiin paperilokeroihin
 papīra tekņu ievietošana • iđiekite popieriaus i visus dēklus • tātītkte paberīsalved

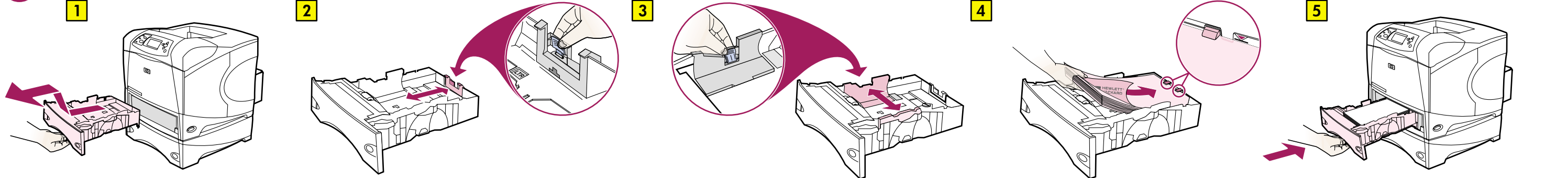

4 install toner • sett inn toner • installera toner • asenna väriaine • tonera uzstādīšana
 iđiekite dažzomuosius mitelius • paigaldage tooner

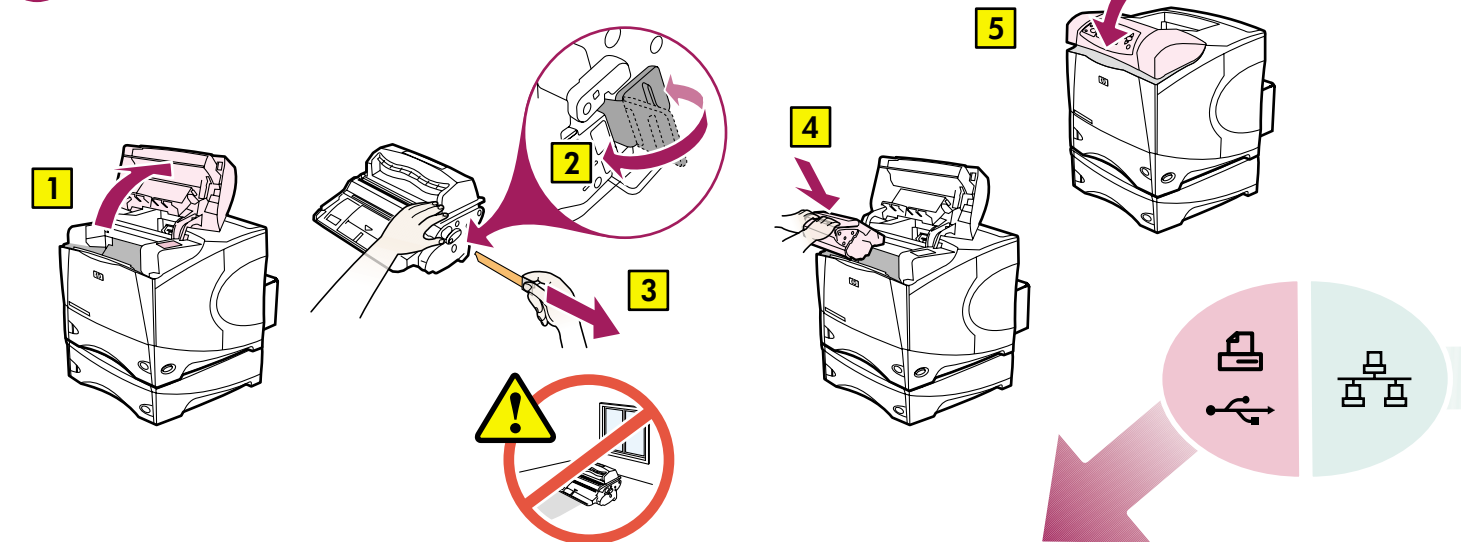

5 connect LAN (optional) • koble til LAN (valgfritt) • anslut LAN (tillval) • muodosta yhteys lähiverkkoon (valinnainen)
 savienojuma izveide ar lokālo tīklu (pēc izvēles) • prijunkite LAN (pasirinktīnai) • ūhendage LAN (soovi korral)

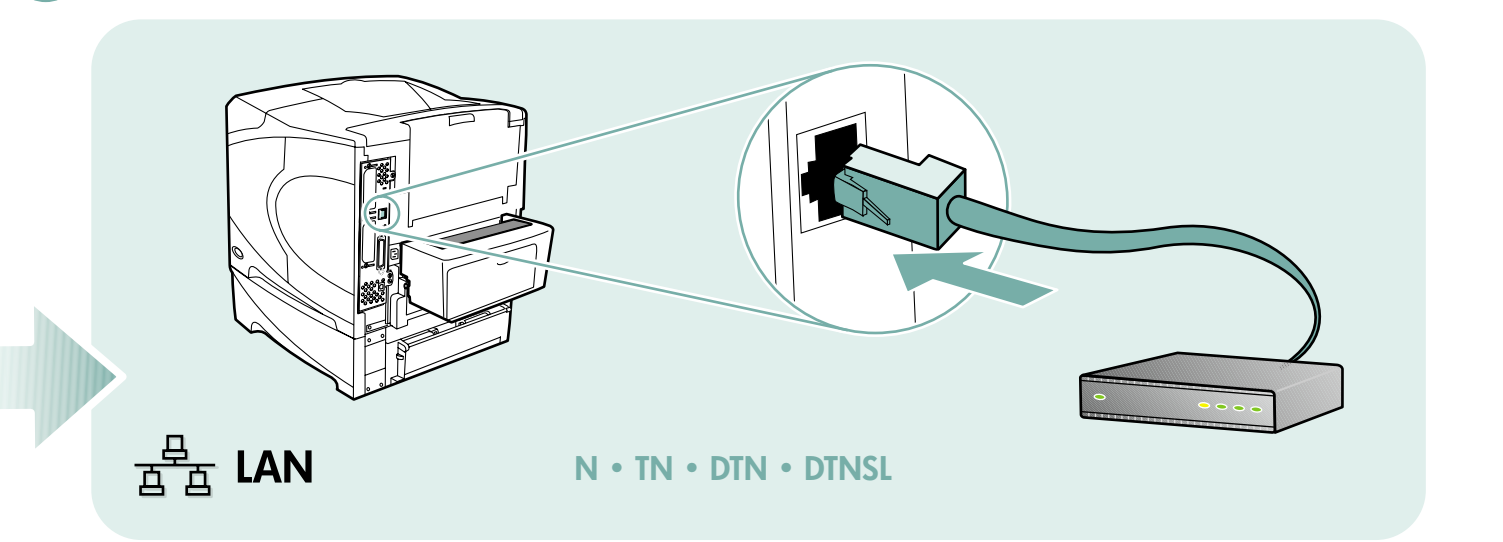

6 connect power • koble til strōmlēdning • anslut strōm • liitā virtajohito • strāvas pievienošana
 prijunkite maitinīq • ūhendage toide

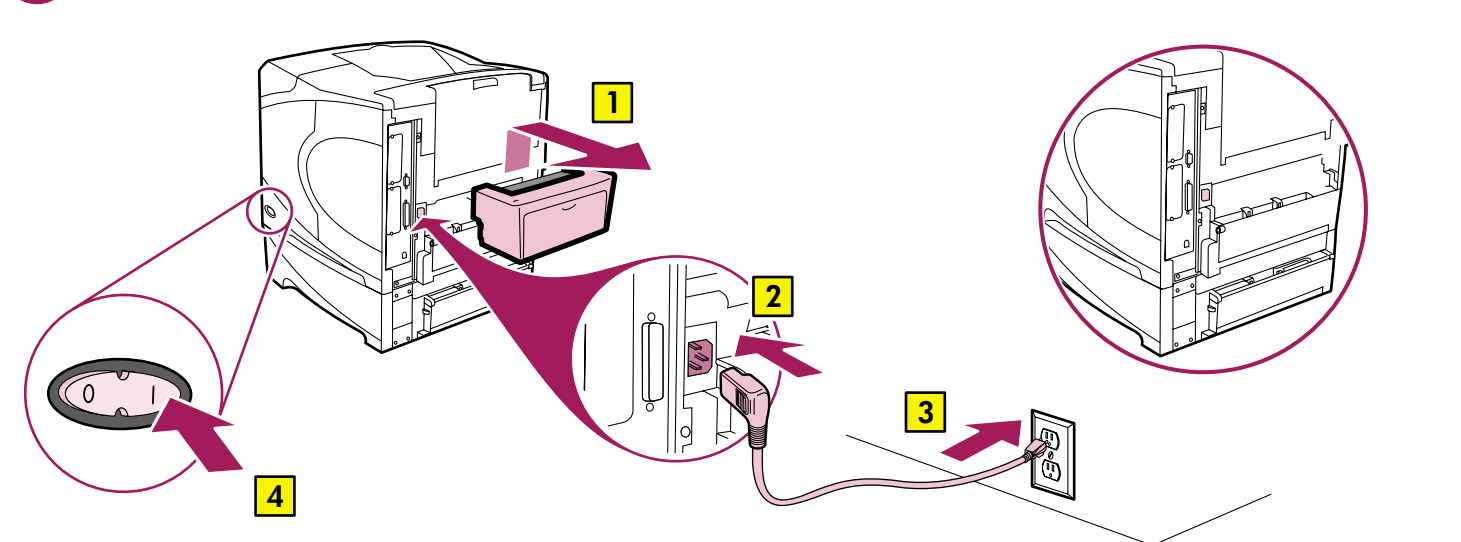

7 set language • angi sprāk • stāll in sprāk • aseta kieli • valodas iestatišana
 nustatītkite kalbā • valīge keel

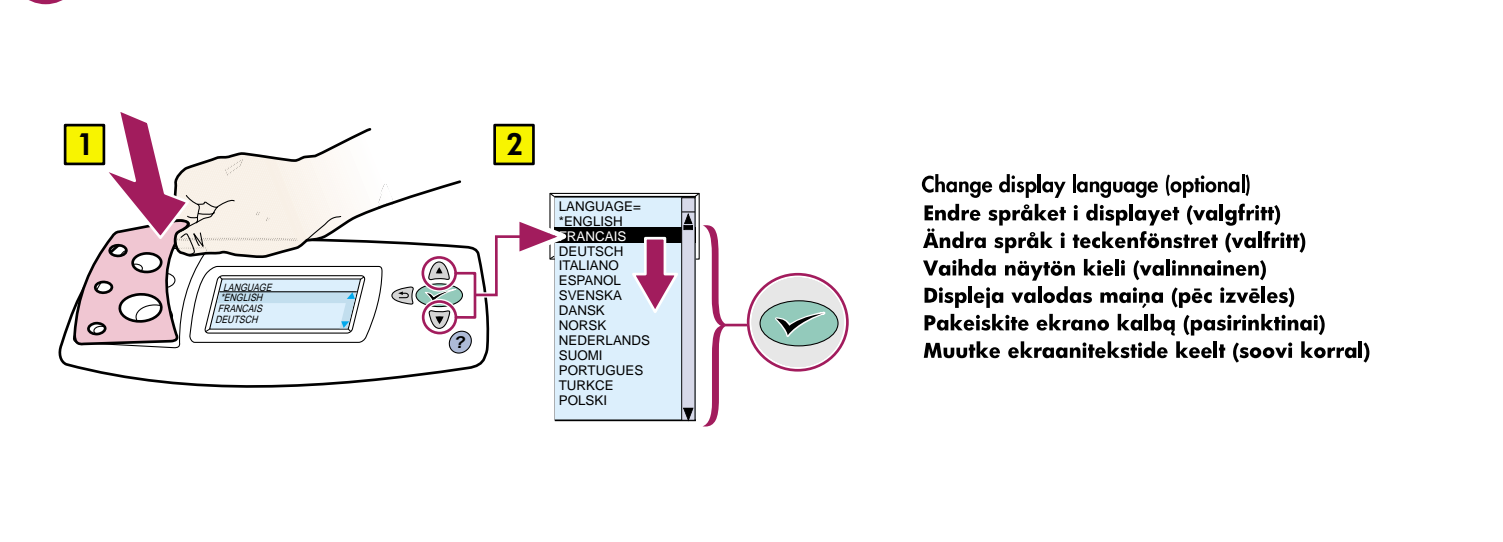

8 print configuration page • skriv ut konfigurāsjonssīde • skriv ut konfigurātionssīda
 tulosta asetussīvu • konfigurācijās lapas drukāšana • īspausdīnkītkte konfigurācijās lapā
 printīdhāēlestusleht

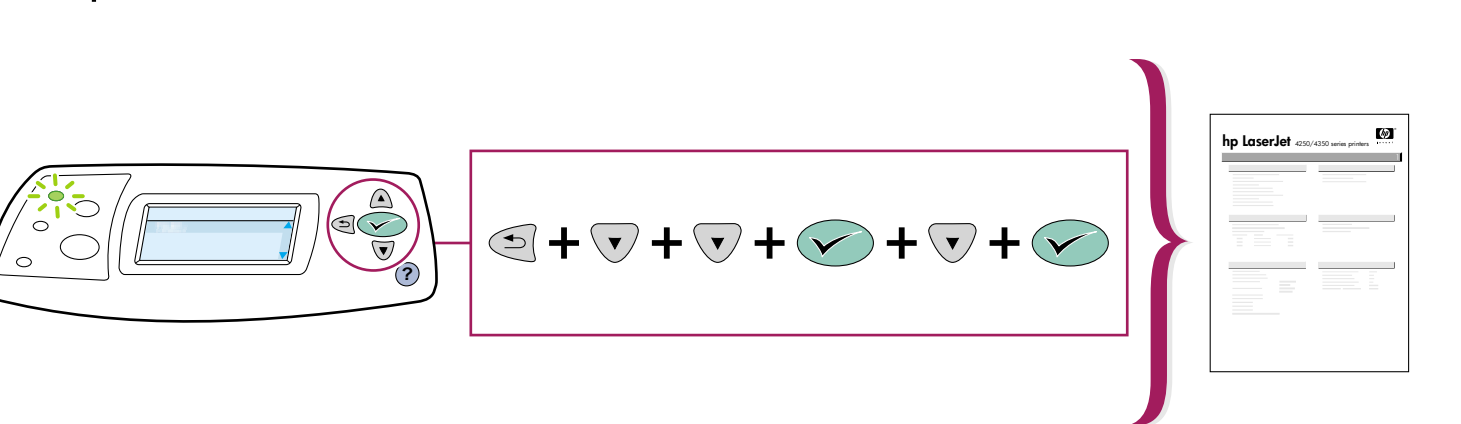

9 install software • installer programvare • installera programvara • asenna ohjelmisto
 programmatūras instalēšana • iđiekite programīnē jīrangā • installīge tarkvara

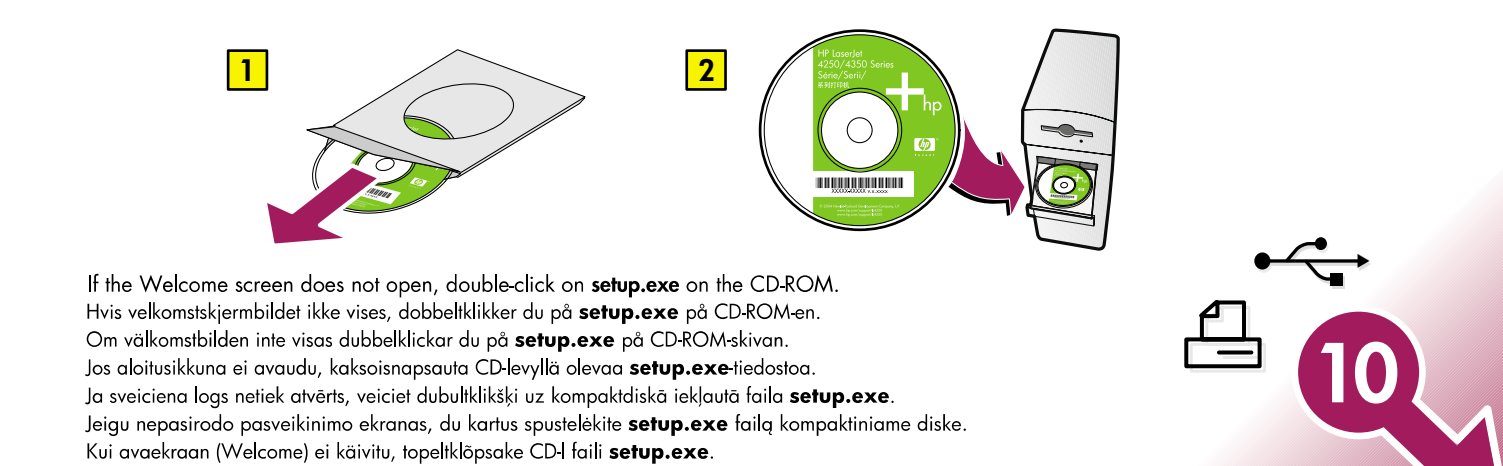

If the Welcome screen does not open, double-click on **setup.exe** on the CD-ROM.
 Hvis velkomstskjermbildet ikke vises, dobbeltklikker du på **setup.exe** på CD-ROM-en.
 Om välkomstbildet inte visas dubbelklickar du på **setup.exe** på CD-ROM-skivan.
 Jos aloitusikkuna ei avaudu, kaksoisnapsauta CD-levyllä olevaa **setup.exe**-liedostoa.
 Ja sveiciens logs netiek atvērts, veiciet dubultklikšķi uz kompaktdiskā iekļauto faila **setup.exe**.
 Jeigu nepasirodo pasveikinimo ekranas, du kartus spūsteleikite **setup.exe** failq kompaktdiskā.
 Kui avaekraan (Welcome) ei kāvītu, topelklīpsake CD-l faili **setup.exe**.