

Warranty and Support Guide

- ✓ 1 Year Parts and Labor
- ✓ 1 Year Technical Telephone Support
- ✓ 24 Hours a Day, 7 Days a Week

IMPORTANT NOTE

If you experience a problem with your new Presario, DO NOT RETURN YOUR COMPUTER TO YOUR RETAILER. At Compaq, we take pride in our ability to service your needs. We are available 24 hours a day, 7 days a week. We have specialists available to help you with your technical support questions as they arise via the Web or phone (see Contact Numbers chart within this document). As our valued customer, we want to make sure that your support needs are met and any issues resolved as quickly as possible.

This document includes warranty information for the United States, Canada, and the Caribbean. The information in this document is subject to change without notice.

Before contacting HP Total Care, it's important to have the following information handy. Please take a moment to write down your product information for future reference.

Model Number: _____

Serial Number: _____

Purchase Date: _____

System or Product Number: _____

COMPAQ

Don't Forget to Register!

Click  "Register with Compaq" on your desktop or go to: <http://register.hp.com>

NOTE: You can view your PC product number, model number, and serial number by pressing the Ctrl, Alt, and S keys on the keyboard at the same time.

Registration is quick, easy and offers:

- E-mail updates containing notifications about product enhancements, the most recent support alerts, and driver updates specific to the product(s) you own.
- The HP newsgam, our monthly online magazine packed full of product news, support tips, project ideas, and much more. Visit us at:
<http://subscription.support.hp.com>

Where to Get Help

HP offers a wide variety of service and support options, which are available around the clock for Compaq branded products that are either in or out of warranty.

Options to use when you need help:

1 Check the setup poster and the user documentation for help with setting up and using your PC.

2 Use the support tools right on your PC.



Help & Support Center for help with hardware and software questions. Click **Start** and then click **Help and Support**.



PC Tune-up and Repair for tools to keep your PC running smoothly. Click **Start, All Programs, PC Help and Tools**.



SW Repair Wizard guides you through options to resolve software issues. Click **Start, All Programs, PC Help and Tools**.

3 Compaq Customer Care Web support. For product information, driver updates, troubleshooting and much more, go to: <http://www.hp.com/support>

4 Chat online with a qualified support specialist to solve your problem. Available through the Help & Support Center on your PC.

5 If you have not solved the problem, you can contact us by phone 24 hours a day, seven days a week, in English, Spanish, and French (Canada only) at:
1-(800)-652-6672 [1-(800)-OK Compaq] or
905-206-4357 (local to Mississauga)

When you call please have your product model number, serial number, and date of purchase available. Telephone support is free during your limited warranty period.

Software Support

America Online

U.S.: 888-346-3704
Canada: 888-265-4357
www.aol.com

Apple – iTunes

www.apple.com

AT&T WorldNet

800-400-1447
www.att.net

CompuServe 2000

800-944-9871
www.compuserve.com

Corel

www3.corel.com

Detto Technologies

866-338-8663
www.detto.com

EarthLink

dial-up customer service
800-890-6356

dial-up technical support
800-890-5128

broadband customer service and technical support
888-829-8466
www.earthlink.net

InterVideo

510-651-0888
www.intervideo.com/home

Microsoft Network

800-386-5550
www.support.msn.com

Symantec – Norton AV

www.symantec.com/techsupp

Quicken Basic (Intuit)

900-555-4688

www.intuit.com

Veritas

(only CD-RW and
DVD+RW/+R models)

www.veritas.com

Yahoo! – User Support

www.yahoo.com

Troubleshooting

For help on problems you may be experiencing when you install your PC, refer to the following pages for possible solutions.

Symptom describes the sign or warning message for the type of problem.

Problem identifies one or more reasons why the symptom may have occurred.

Solution describes what you should do to try to solve the problem.

Look up the description of the symptom or problem, and try the solution listed. Some of the symptoms listed may not apply to your PC. For problems relating specifically to the monitor or printer, refer to the equipment documentation.

Display (Monitor)

NOTE: If you encounter display (monitor) problems, refer to the documentation that came with your monitor and to the common causes and solutions listed in this table.

Symptom	Problem	Solution
Screen is blank, and monitor power light is not lit.	Monitor power cable is not connected to the monitor or to the wall outlet.	Reconnect the power plug on the back of the monitor and on the wall outlet.
	Monitor is off (not turned on).	Press the On button on the front of the monitor.
Screen is blank.	Screen saver is enabled.	Press any key or move the mouse to make the screen display visible again.
	PC is in standby mode.	Press the Standby button (select models only) or press the Esc key on the keyboard to resume from standby mode.
	PC is in hibernation mode or is off.	Press the On button to turn on the PC.
	Monitor connector cable is not properly connected to the back of the PC.	Inspect the monitor video connector for bent pins. If no pins are bent, reconnect the monitor connector cable on the back of the PC.

Hard Disk Drive

Symptom	Problem	Solution
PC seems to be locked up and not responding.	Program in use has stopped responding to commands.	Use the Windows Task Manager to close any programs not responding or to Restart the PC: <ol style="list-style-type: none"> 1 Press the Ctrl, Alt, and Delete keys on the keyboard at the same time. 2 Select the program that is not responding, and click End Task. <p>Or</p> <p>Click Shut Down, and then click Restart.</p> <p>If this does not work, press the On button for 5 or more seconds to turn off the PC. Then, press the On button.</p>

Internet Access

Symptom	Problem	Solution
Cannot connect to the Internet.	Internet Service Provider (ISP) account is not set up properly.	Verify Internet settings, or contact your ISP for assistance.
	Modem is not set up properly.	Reconnect the modem, verifying connections. Note that your PC may also have an Ethernet network interface (also called a network interface card, or NIC) that connects to a LAN (local area network). Although it looks similar to the modem connector, the RJ-45 Ethernet network connector is not the same. Verify that you are using the modem connector. Do not connect a telephone cable to the NIC. Do not plug a network cable into a telephone service line; doing so may damage the NIC.
	Web browser is not set up properly.	Verify that the Web browser is installed and set up to work with your ISP.

Keyboard and Mouse

Symptom	Problem	Solution
Keyboard commands and typing are not recognized by the PC.	Keyboard connector is not properly connected.	Turn off the PC by using the mouse, reconnect the keyboard to the back of your PC, and turn on your PC.
	Program in use has stopped responding to commands.	Restart or turn off your PC using the mouse.
	Keyboard is damaged.	Press the Help ? button on the keyboard to open the Help and Support Center, or contact Support for replacement details.
Wireless keyboard does not work after installation or is not detected.	Keyboard batteries are low or empty.	Replace the two AA alkaline batteries in the wireless keyboard; then set the ID channel by pressing the Connect button on the wireless receiver and then on the keyboard. Refer to the documentation that came with your wireless set.
Mouse does not respond to movement or is too slow.	Mouse connector is not properly plugged into the back of the PC.	Turn off your PC using the keyboard: <ol style="list-style-type: none"> 1 Press the Ctrl and Esc keys on the keyboard at the same time to display the Start menu. 2 Use the up arrow or down arrow key to select Turn Off Computer, and then press the Enter key on the keyboard. 3 Use the up arrow or down arrow key to select Turn Off, and then press the Enter key. After the shutdown is complete, plug the mouse connector into the back of your PC and turn on your PC.
	Program in use has stopped responding to commands.	Restart your PC by using the keyboard. If possible, save any open files and close open applications before restarting.
	Surface in use for roller-ball type mouse is too smooth.	Use a mouse pad or other rough surface for the mouse.
Mouse does not work after installation or is not detected.	Mouse is not connected properly.	Try unplugging and then reconnecting the mouse cable to your PC.
	Wireless mouse batteries are low or empty.	Replace the two AA alkaline batteries in the mouse; then set the ID channel by pressing the Connect button on the wireless receiver and then on the mouse. Refer to the documentation that came with your wireless set.

Power

Symptom	Problem	Solution
PC will not turn on or start.	PC is not securely connected to an external power source.	Ensure that cables connecting the PC to the external power source are plugged in properly.
	Green power supply light on back of PC is out.	When the cables connecting the PC to the external power source are plugged in properly and the wall outlet is functioning, the green power supply light should be on; if the light is not on, refer to the <i>Warranty and Support Guide</i> to contact Support.
	Monitor is not connected or is not on.	Connect the monitor to the PC, plug it in, and turn it on.
	Line voltage selection switch is not in the proper position for your country/region (115V~/230V~).	Set the line voltage selection switch to the correct setting for your country/region, or refer to Support.
	Wall outlet is defective.	Test the outlet by connecting a different electrical device to the outlet.
<i>Invalid system disk</i> Or <i>Non-System disk or disk error</i> message displays	A diskette has been left in the drive during startup.	When drive activity stops, remove the diskette and press the spacebar. The PC should start up.
PC appears locked up and won't turn off when the On button is pressed.	PC is not working.	Press and hold the On button until the PC turns off.

Recovering From Software Problems

The PC uses the operating system and installed software programs during normal operation. If your PC works improperly or stops because of the software, you may be able to repair it.

The Software Repair Wizard (select models only) is an icon on the desktop or in the Organize software program, or in the Help and Support Center. To start the wizard, click the icon or click **Start**, choose **All Programs, PC Help & Tools**, and then click **Software Repair Wizard**.

Click the Software Repair Wizard icon to repair software problems with programs, printers, or peripherals that stop working, or to resolve erratic PC behavior. Repair options include using the Compaq Application Recovery or Compaq System Recovery programs.



You need recovery discs (CDs or DVDs) for some repairs that use the Compaq Application Recovery program or the Compaq System Recovery program. The PC does not include recovery discs in the accessory box, but you can make your own recovery CDs or DVDs; see "Creating Recovery CDs/DVDs."



CAUTION: It is strongly recommended that you create your recovery discs before you need them.

You should also make the Compaq Recovery Tools CD. This CD contains utilities that allow you to make changes to your hard disk drive, including removing the recovery partition. See "Using the Recovery Tools CD."

There are several methods to fix your PC, including using the System Recovery program. Try these methods in the order listed here, or refer to the table that follows the list.

- **Restart** When you restart the computer, the PC *starts over* using the operating system and software in its memory. This is the simplest repair for your PC; just click **Start**, choose **Turn Off Computer**, and then click **Restart**.
- **Turn Off Computer** When you turn off the computer and then turn it on again, you force the PC to copy the operating system into its memory and to clear some tracking information. This may eliminate some problems that can remain after performing a Restart. To turn off the computer just click **Start**, choose **Turn Off Computer**, and then click **Turn Off**.
- **Driver Rollback** This Microsoft Windows XP feature is part of the Windows Installer program used with the *Add or Remove Programs* utility in the Control Panel. It can revert to the previous version of a driver program if an installation fails when you are installing a new version of the driver program. For more information, type *Rollback* into the Search box in Help and Support.
- **System Restore** This Microsoft Windows XP feature allows you to bring your computer configuration back to a previous time when a current software problem may not have existed. The feature does this by creating a “restore point” where it records the PC settings at that time and date. The installation of some software automatically sets a restore point for you, but it is recommended to manually set restore points, especially before installing or downloading additional software. When using *Add Programs* from the Add or Remove Programs feature under the computer Control Panel, the operating system automatically creates a restore point before it adds the software. If you experience a problem that you think may be due to software on your computer, use System Restore to return the PC to a previous restore point. For more information, type *System Restore* into the Search box in Help and Support.

- **Application and Driver Recovery** If the problem with the PC seems to be with only one program or one driver, it may be that the application program or the driver program is damaged. You can reinstall individual factory-installed application programs and driver programs by using the Compaq Application Recovery program (select models only); see “Application Recovery.”
- **System Recovery** Use the Compaq System Recovery program as a last resort to reinstall the software. Perform System Recovery using the hard disk drive partition first; see “System Recovery.” If necessary, next perform System Recovery using the recovery discs and choose Standard Recovery; see “System Recovery Using Recovery Discs.” Finally, if necessary, perform System Recovery using the recovery discs and choose full System Recovery.

Before using the Compaq System Recovery program or the Compaq Application Recovery program, use System Restore.

NOTE: Your PC hard disk drive contains the System Recovery image in a partition area of the disk drive. The PC does not include recovery discs in the accessory box, but you can make your own recovery CDs or DVD; see “Creating Recovery CDs/DVDs.”

When your PC stops working correctly, the Restart, Turn Off Computer, and Driver Rollback methods (described above) may resolve the problem. After you have tried these three methods, if needed, try the remaining actions, using the table that follows as a quick reference.

For the specific PC problem, try the method listed as #1, then #2, and then #3.

Problem/Status	Microsoft System Restore	Application Recovery program	System Recovery from the hard disk partition	System Recovery from the recovery CDs/DVDs
You installed a new application or device driver	1			
An application does not work	1	2	3	
A device driver does not work		1	2	
PC stops responding or does not work	1		2	3
You replaced the hard disk drive or removed the partition				1

Creating Recovery CDs/DVDs

1 You can **recover (bring back)** the operating system and programs that were included on your hard drive just as they were when you bought the computer.

NOTE: A **hard disk drive** is a disk inside the computer that stores the operating system, programs, and data.

2 You recover the operating system and programs directly from your hard drive, where a copy was placed for your convenience.

We call this part of your hard drive the “**recovery partition.**”

The recovery partition takes up some space on your hard drive.

3 You can copy the information of this recovery partition onto CDs or DVDs.

4 Then, if you would like to make extra space available on your hard drive, you can delete the recovery partition using a special software tool.

5 **Do not delete** your hard drive partition unless you have made recovery CDs or DVDs.

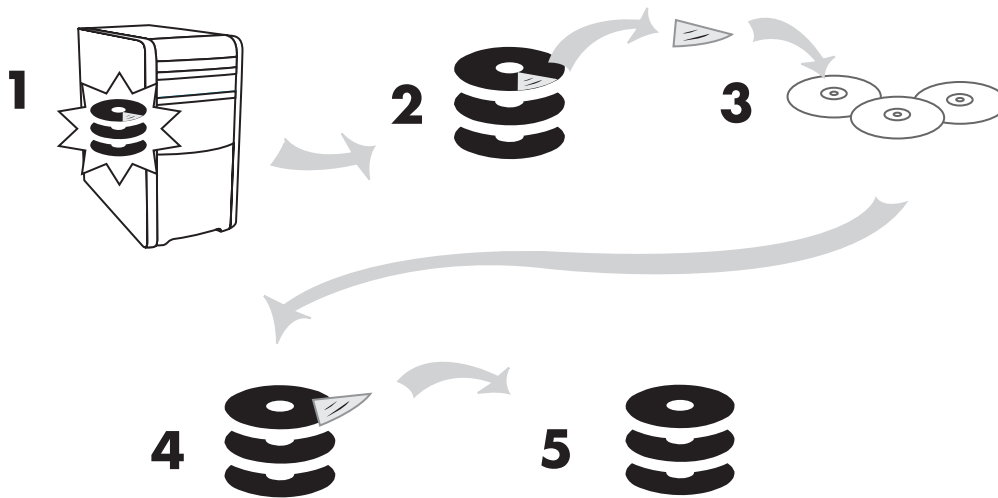

The recovery discs can be used only with the specified PC model. The discs are licensed for use only with your PC. The recovery CDs/DVDs can install the operating system and software on your PC hard disk drive if the software becomes corrupted or is accidentally erased.

Using Recovery CD-DVD Creator

Make recovery CDs or DVDs for your PC by using the Compaq Recovery CD-DVD Creator program before you experience any problem.

The recovery discs set is a complete image of the original PC hard disk drive contents and is matched to your PC model number. The discs set contains the operating system, drivers, and application software that were originally installed on the PC at the factory.

You can use this program to make only one set of recovery CDs or DVDs for your PC. The recovery discs you create can be used only on your PC.

There are several advantages in using DVDs instead of CDs when creating your recovery discs set:

- With a faster data transfer rate, a set of DVD recovery discs will have your PC running much sooner than a CD set will.
- A set of DVDs will probably take you less time to create than a set of CDs.
- A DVD has more capacity than a CD, so there are fewer discs to record and store.

To use this program, your PC must have a CD-RW drive, DVD Writer drive, or other drive that can write to the CDs or DVDs. If necessary, purchase a Windows XP-compatible drive from your local PC or electronics store.

The number of CDs/DVDs in the recovery set depends on your PC model. The program tells you the number of blank discs needed to make the set. The process takes some time, including up to 15 minutes per disc to verify that the information written on the disc is correct.

You can quit the process at any time. The next time you run the program, it begins where you left off.

To run the Recovery CD-DVD Creator program:

- 1 Close any open programs. To close programs, click **X** in the upper-right corner of each window.
- 2 Click **Start** on the taskbar.
- 3 Choose **All Programs**.
- 4 Choose **PC Help & Tools**.
- 5 Click **Compaq Recovery CD-DVD Creator**. The creator window appears.
- 6 Follow the onscreen instructions. Label each disc as you make it.

Store the System Recovery discs in a safe place.

Using the Recovery Tools CD

Your PC allows you to create (burn) a Recovery Tools CD. After you make the Compaq Recovery Tools CD, you can use it to:

- Read instructions to use each utility on the Recovery Tools CD.
- Start the System Recovery program from the recovery partition.
- Remove the System Recovery partition from your PC hard disk drive to increase space for data.
- Create a new data partition on your PC hard disk drive.
- Start the Microsoft Recovery Console (a utility from Microsoft that can perform operating system diagnostics and repairs).



WARNING: Before using the Compaq Recovery Tools CD to change your hard disk drive, make System Recovery CDs for your PC by using the Compaq Recovery CD-DVD Creator program. You cannot make System Recovery CDs after you remove the system recovery partition.

You must create (burn) the Recovery Tools CD before you can use it.

To Create or to Start the Recovery Tools CD:

- 1 Click **Start** on the taskbar.
- 2 Choose **All Programs**.
- 3 Choose **PC Help & Tools**.
- 4 Click **Compaq Recovery Tools CD**. The tools window appears.
- 5 Follow the onscreen instructions.

Store the Recovery Tools CD in a safe place.

System Restore



WARNING: Try System Restore before using the Compaq System Recovery program.

If software on your hard drive accidentally gets erased or damaged, first use the Microsoft *System Restore* feature in Windows XP to restore the PC system and program settings.

System Restore returns the PC settings to a selected restore point without affecting user programs or document files. For more information, type *System Restore* into the Search box in Help and Support.

To Start System Restore:

- 1 Close all open programs.
- 2 Click the **Start** button.
- 3 Choose **All Programs**.
- 4 Choose **Accessories**.
- 5 Choose **System Tools**.
- 6 Click **System Restore**.

Follow the onscreen instructions.

Application Recovery

NOTE: Not all PC models include the Application Recovery program. Perform steps 3 through 5 of the following procedure. If *Compaq Application Recovery* appears in the folder, your PC includes the program.

If an individual factory-installed application or driver accidentally gets erased or damaged, you can reinstall the software using the Compaq Application Recovery program (select models).

NOTE: Do not use the Application Recovery program to reinstall software programs that came on CDs or DVDs included in the PC box. Reinstall these programs directly from the CDs or DVDs.

To Start Application Recovery:

- 1 Close all applications and folders.
 - 2 Uninstall the existing (damaged) application.
 - 3 Click **Start** on the taskbar.
 - 4 Choose **All Programs**.
 - 5 Choose **PC Help & Tools**.
 - 6 Click **Compaq Application Recovery**, and then click **Yes**.
 - 7 Click **Application Installation** or **Driver Installation**, and then click **Next**.
 - 8 Select the driver or application program to install, and then click **Install**.
 - 9 Follow the onscreen instructions.
 - 10 Repeat steps 7 through 9 to install other drivers or applications.
 - 11 When you have finished recovering applications or drivers, close the Application Recovery program. Then click **Start**, click **Turn Off Computer**, and click **Restart** to restart the PC.
-



WARNING: Do not skip this last step! You must restart the PC when you are finished recovering applications or drivers.

System Recovery

When you've tried other methods of repairing your system software (like System Restore or Application Recovery), you may want to use the Compaq System Recovery program as a last resort to reinstall the software.

When necessary, you can reinstall the operating system and the application software that was originally installed on the PC at the factory by using the System Recovery program.



WARNING: The Compaq System Recovery program will delete any data or programs that you installed after purchase. Be sure to back up any data that you want to keep onto a removable disc.

The System Recovery program uses a special *recovery partition* on the hard disk drive that stores an image of the original software.

NOTE: The System Recovery image is in a partition area of the hard disk drive and takes up part of the total drive space. This disk space is not usually available for your use.

In the unlikely event that you replace the hard disk drive, or somehow damage the data in the special recovery partition on the hard disk drive, use recovery discs to reinstall the operating system and software on the hard disk drive. See "System Recovery Using Recovery Discs."

Make your own recovery discs (CDs or DVDs) before you need them; see "Creating Recovery CDs/DVDs." You can also make the Recovery Tools CD. This CD contains utilities that allow you to make changes to your hard disk drive; see "Using the Recovery Tools CD."

Starting System Recovery If the PC Is Responding

- 1 Turn off the PC. Disconnect all peripheral devices from the PC except the monitor, the keyboard, and the mouse. Turn on the PC.
- 2 Click **Start** on the taskbar, choose **All Programs**, choose **PC Help & Tools**, and then click **Compaq System Recovery**.
- 3 Wait until the System Recovery window appears asking *Do you really want to start System Recovery?*
- 4 Click **Yes** to continue with the recovery process. If you created recovery discs, you may be directed to insert recovery disc #1. If the recovery disc is a DVD, be sure to put the disc in a DVD drive.
- 5 The PC starts the recovery; wait for the onscreen instructions to display, and then follow those instructions.
- 6 Complete the PC startup, finish the registration process, and wait until you see the desktop. Then, turn off the PC, reconnect all peripheral devices, and then turn on the PC.

Starting System Recovery If the PC Is Not Responding

- 1 Turn off the PC. If necessary, press and hold the On button until the PC turns off.
- 2 Disconnect all peripheral devices from the PC except the monitor, the keyboard, and the mouse.
- 3 Press the On button to turn on the PC.
- 4 During the startup, do the following to enter the System Recovery program:
When the black screen with the Compaq logo appears, press the F10 key on the keyboard. (You have only a few seconds to press the F10 key before the normal startup process continues.)
- 5 The PC starts the recovery; wait for the onscreen instructions to display, and then follow those instructions.
- 6 Complete the PC startup, finish the registration process, and wait until you see the desktop. Then, turn off the PC, reconnect all peripheral devices, and turn on the PC.

System Recovery Using Recovery Discs

Make your own recovery CDs/DVDs before you need them; recovery discs are not included with your PC. See "Creating Recovery CDs/DVDs."

Starting System Recovery Using Recovery Discs

The recovery discs provide two recovery options:

- **Standard Recovery:** This option recovers factory-shipped programs, drivers, and the operating system without affecting any data files that you may have created since purchasing this PC. Some data files may be difficult to find after the System Recovery, so it is best to back up all hard disk drive files before performing a System Recovery.
- **Full System Recovery:** This recovery function completely erases and reformats the hard disk drive. The program performs a full System Recovery to reinstall the operating system, programs, and drivers from the recovery discs. However, you must reinstall any software that was not installed on the PC at the factory. This includes software that came on CDs included in the PC accessory box, and software programs you installed since your purchase.

NOTE: If your PC has a blank or corrupted hard disk drive, you will see only the full System Recovery option.

To Run System Recovery Program Using Recovery Discs:

- 1 If the PC works, back up all data files that you want to save onto removable media, such as CD-RW or diskette. Remove the backup CD or diskette you've made.
- 2 Press the Eject button on the top disc drive, and wait for the tray to open. Insert recovery disc #1 and close the tray. If the recovery disc is a DVD, be sure to put the disc in a DVD drive.
- 3 Turn off the PC:
 - If the PC works: Click **Start** on the taskbar, click **Turn Off Computer**, and then click **Turn Off**.

Or

 - Press and hold the On button approximately 5 seconds until the PC turns off.
- 4 Disconnect all peripheral devices from the PC except the monitor, the keyboard, and the mouse.
- 5 Press the On button to turn on the PC.
- 6 The PC starts the recovery; wait for the onscreen instructions to display, and then follow those instructions.
 - For standard recovery, press R. Choose **Next** to proceed with the System Recovery. Choose **Yes** to start the recovery. Insert the remaining recovery discs when directed.

Or

 - For full System Recovery, press F. Choose **Yes** to perform a full System Recovery. Insert the remaining discs when directed.

Or

 - If your PC hard disk drive is blank or corrupted, press R to perform a full System Recovery. Insert the remaining recovery discs when directed.
- 7 When the recovery program finishes, the drive tray ejects. Remove the disc.
- 8 Click **Restart** to restart the PC.
- 9 After the PC restarts, a series of startup screens appears. To proceed with the initial Microsoft Windows setup, you must answer a few questions.
- 10 Complete the PC startup, finish the registration process, and wait until you see the desktop. Then, turn off the PC, reconnect all peripheral devices, and turn on the PC.
- 11 Reinstall software not originally installed on the PC by the factory.
- 12 Copy data files that you saved on the backup CD or diskette you made to your hard disk drive.

Warranty and License Information

HP Total Care

HP Total Care provides fast, friendly, and effective expert advice for all your Compaq branded products. If you have a question or if a problem arises, we offer extensive service and support options around the clock to better handle your needs. Go to your PC's Help and Support Center for the fastest resolutions. For more information on your support and services options visit:

<http://www.hp.com/home/ownerservices>

When should I contact Compaq phone service and support?

- The Help and Support Center or other support tools on your PC did not identify or help solve your problem.
- You either do not have Internet access, or cannot connect to the Internet to use the Compaq Customer Care Web support site or to chat with qualified online support specialists.
- There is obvious damage or a mechanical breakdown with your product and it does not work.

HP Total Care Technical Agents are available 24 hours a day via:

1-(800)-652-6672

[1-(800)-OK Compaq] or **905-206-4357** (local to Mississauga) to provide expert assistance.

NOTE: Support options, availability and hours vary by product, country/region, and language and are subject to change.

For Caribbean

<http://clac.compaq.com/soporte/index.html>

Aruba: **800-8000: 877-219-8671**

Bahamas: **1-800-711-2884**

Barbados: **001800-872-2881:1-800-771-2884**

Jamaica: **0-800-711-2884**

Trinidad: **1-800-711-2884** or **1-800-799-3477**

If Necessary: Get Repair Customer-replaceable Parts

You can easily replace many of the internal and external PC parts yourself. This is the fastest method of repair, where the part is conveniently sent with next-day service to your home or business. We pay the shipping and handling. Detailed

instructions are included to guide you through an easy repair, and if you have questions, call us for assistance. This service is free for the duration of the hardware warranty period.

In some cases, HP will ask for a credit card as collateral for the part and will charge you for the retail price of the part if the failed part is not returned within thirty (30) days.

Availability of this program may vary depending on your country/region.

Return to Depot Repair Service

HP will arrange to have your PC picked up and delivered to a Central Repair Center. We pay for the round-trip shipping and handling. This service is free for the duration of the hardware warranty period.

There are a few limitations and exclusions to this warranty (as well as some important details) and you'll find them described, in legal language, beginning on the next page.

Carry-In Service

You also have the option of taking your PC to an HP Authorized Service Provider (ASP). The ASP can facilitate the service on your PC. For a select number of ASPs, same day repair service is available for your convenience. Visit <http://www.hp.com/us/support> to find the nearest authorized support provider in your area.

Software Support

HP provides technical software support for 90 days from the date of purchase. This support includes assistance with installation, setup and basic configuration of software included by HP with the PC, excluding system optimization, customization and network configuration. Support for technical issues caused by viruses or spyware is available for a fee.

Compaq Out-of-Warranty Support Options

Even after your warranty has ended, HP can still provide you with service and support options on your Compaq branded product:

- For Visa and MasterCard holders in the United States or calls from Canada, please call **1-(800)-652-6672** [1-(800) OK Compaq] or **905-206-4357** (local to Mississauga).
- 1 time technical support, \$40* U.S. per call
- 1 year unlimited technical support \$75* U.S.

*Prices are subject to change without notice and may vary based on your product.

Fees are charged to your Visa or MasterCard.

Protect Your Investment

Obtaining a Warranty Upgrade

Upgrade your standard factory warranty to two or three years with an extended service plan. Service coverage begins on product purchase date and you must purchase the service within the first year after purchasing the computer. The hardware service offering will be determined based on the outcome of system self-test programs run by the customer through the initial call to HP Total Care.

For more information please visit

US Only

<http://www.hp.com/home/ownerservices>

Canada Only

<http://www.hp.ca/ownerservices>

or call: 1 (866)-234-1377

Recycle – HP/Compaq Planet Partners

Compaq is sensitive to the environment and has a program, Planet Partners, to make it simple for us to reclaim your old product for recycling. Compaq will help you recycle your old equipment even if it is not a Compaq product; we take back all makes and models. Visit our Web site to find out how easy it is to recycle: <http://www.hp.com/recycle>

COMPAQ PRESARIO DESKTOP PRODUCTS

Hardware Limited Warranty

General Terms

This HP Hardware Limited Warranty gives you, the customer, express limited warranty rights from HP, the manufacturer. Please refer to HP's Web site for an extensive description of your limited warranty entitlements. In addition, you may also have other legal rights under applicable local law or special written agreement with HP.

EXCEPT AS EXPRESSLY SET FORTH IN THIS LIMITED WARRANTY, HP MAKES NO OTHER WARRANTIES OR CONDITIONS, EXPRESS OR IMPLIED, INCLUDING ANY IMPLIED WARRANTIES OF MERCHANTABILITY AND FITNESS FOR A PARTICULAR PURPOSE. HP EXPRESSLY DISCLAIMS ALL WARRANTIES AND CONDITIONS NOT STATED IN THIS LIMITED WARRANTY. ANY IMPLIED

WARRANTIES THAT MAY BE IMPOSED BY LAW ARE LIMITED IN DURATION TO THE LIMITED WARRANTY PERIOD. SOME STATES OR COUNTRIES/REGIONS DO NOT ALLOW A LIMITATION ON HOW LONG AN IMPLIED WARRANTY LASTS OR THE EXCLUSION OR LIMITATION OF INCIDENTAL OR CONSEQUENTIAL DAMAGES FOR CONSUMER PRODUCTS. IN SUCH STATES OR COUNTRIES/REGIONS, SOME EXCLUSIONS OR LIMITATIONS OF THIS LIMITED WARRANTY MAY NOT APPLY TO YOU.

THE LIMITED WARRANTY TERMS CONTAINED IN THIS STATEMENT, EXCEPT TO THE EXTENT LAWFULLY PERMITTED, DO NOT EXCLUDE, RESTRICT, OR MODIFY BUT ARE IN ADDITION TO THE MANDATORY STATUTORY RIGHTS APPLICABLE TO THE SALE OF THIS PRODUCT TO YOU.

This Limited Warranty is applicable in all countries/regions and may be enforced in any country or region where HP or its authorized service providers offer warranty service subject to the terms and conditions set forth in this Limited Warranty. However, warranty service availability and response times may vary from country/region to country/region and may also be subject to registration requirements in the country/region of purchase. If so, your HP authorized service provider can provide you with details.

This Limited Warranty applies only to HP-branded and Compaq-branded hardware products (collectively referred to in this Limited Warranty as "HP Hardware Products") sold by or leased from Hewlett-Packard Company, its worldwide subsidiaries, affiliates, authorized resellers, or country/region distributors (collectively referred to in this Limited Warranty as "HP") with this Limited Warranty. The term "HP Hardware Product" is limited to the hardware components and required firmware. The term "HP Hardware Product" DOES NOT include any software applications or programs; non-HP products or non-HP branded peripherals. All non-HP products or non-HP branded peripherals external to the HP Hardware Product — such as external storage subsystems, displays, printers and other peripherals — are provided "AS IS" without HP warranty. However, non-HP manufacturers and suppliers, or publishers may provide their own warranties directly to you.

HP warrants that the HP Hardware Products that you have purchased or leased from HP are free from defects in materials or workmanship under normal use during the Limited Warranty Period. The Limited Warranty Period starts on the date of purchase or lease from HP, or from the date HP completes installation. Your dated sales or delivery receipt, showing the date of purchase or lease of the product, is your proof of the purchase or lease date. You may be required to provide proof of purchase or lease as

a condition of receiving warranty service. You are entitled to hardware warranty service according to the terms and conditions of this document if a repair to your HP Hardware Product is required within the Limited Warranty Period.

Unless otherwise stated, and to the extent permitted by local law, new HP Hardware Products may be manufactured using new materials or new and used materials equivalent to new in performance and reliability. HP may repair or replace HP Hardware Products (a) with new or previously used products or parts equivalent to new in performance and reliability, or (b) with equivalent products to an original product that has been discontinued. Replacement parts are warranted to be free from defects in material or workmanship for ninety (90) days or, for the remainder of the Limited Warranty Period of the HP Hardware Product they are replacing or in which they are installed, whichever is longer.

During the Limited Warranty Period, HP will, at its discretion, repair or replace any defective component. All component parts or hardware products removed under this Limited Warranty become the property of HP. In the unlikely event that your HP Hardware Product has recurring failures, HP, at its sole discretion, may elect to provide you with (a) a replacement unit of HP's choosing that is the same or equivalent to your HP Hardware Product in performance or (b) to give you a refund of your purchase price or lease payments (less interest) instead of a replacement. This is your exclusive remedy for defective products.

Exclusions

HP does not warrant that the operation of this product will be uninterrupted or error-free. HP is not responsible for damage that occurs as a result of your failure to follow the instructions intended for the HP Hardware Product.

This Limited Warranty does not apply to expendable or consumable parts and does not extend to any product from which the serial number has been removed or that has been damaged or rendered defective (a) as a result of accident, misuse, abuse, contamination, improper or inadequate maintenance or calibration or other external causes; (b) by operation outside the usage parameters stated in the user documentation that shipped with the product; (c) by software, interfacing, parts or supplies not supplied by HP; (d) improper site preparation or maintenance; (e) virus infection; (f) loss or damage in transit; or (g) by modification or service by anyone other than (i) HP, (ii) an HP authorized service provider, or (iii) your own installation of end-user replaceable HP or HP approved parts if available for your product in the servicing country or region.

YOU SHOULD MAKE PERIODIC BACKUP COPIES OF THE DATA STORED ON YOUR HARD DRIVE OR

OTHER STORAGE DEVICES AS A PRECAUTION AGAINST POSSIBLE FAILURES, ALTERATION, OR LOSS OF THE DATA. BEFORE RETURNING ANY UNIT FOR SERVICE, BE SURE TO BACK UP DATA AND REMOVE ANY CONFIDENTIAL, PROPRIETARY, OR PERSONAL INFORMATION. HP IS NOT RESPONSIBLE FOR DAMAGE TO OR LOSS OF ANY PROGRAMS, DATA, OR REMOVABLE STORAGE MEDIA. HP IS NOT RESPONSIBLE FOR THE RESTORATION OR REINSTALLATION OF ANY PROGRAMS OR DATA OTHER THAN SOFTWARE INSTALLED BY HP WHEN THE PRODUCT IS MANUFACTURED.

Exclusive Remedy

TO THE EXTENT ALLOWED BY APPLICABLE LOCAL LAW, These terms and conditions constitute the complete and exclusive warranty agreement between you and HP regarding the HP Hardware Product you have purchased or leased. These terms and conditions supersede any prior agreements or representations — including representations made in HP sales literature or advice given to you by HP or an agent or employee of HP — that may have been made in connection with your purchase or lease of the HP Hardware Product. No change to the conditions of this Limited Warranty is valid unless it is made in writing and signed by an authorized representative of HP.

Limitation of Liability

IF YOUR HP HARDWARE PRODUCT FAILS TO WORK AS WARRANTED ABOVE, HP'S MAXIMUM LIABILITY UNDER THIS LIMITED WARRANTY IS EXPRESSLY LIMITED TO THE LESSER OF THE PRICE YOU HAVE PAID FOR THE PRODUCT OR THE COST OF REPAIR OR REPLACEMENT OF ANY HARDWARE COMPONENTS THAT MALFUNCTION IN CONDITIONS OF NORMAL USE.

EXCEPT AS INDICATED ABOVE, IN NO EVENT WILL HP BE LIABLE FOR ANY DAMAGES CAUSED BY THE PRODUCT OR THE FAILURE OF THE PRODUCT TO PERFORM, INCLUDING ANY LOST PROFITS OR SAVINGS OR SPECIAL, INCIDENTAL, OR CONSEQUENTIAL DAMAGES. HP IS NOT LIABLE FOR ANY CLAIM MADE BY A THIRD PARTY OR MADE BY YOU FOR A THIRD PARTY.

THIS LIMITATION OF LIABILITY APPLIES WHETHER DAMAGES ARE SOUGHT, OR A CLAIM MADE, UNDER THIS LIMITED WARRANTY OR AS A TORT CLAIM (INCLUDING NEGLIGENCE AND STRICT PRODUCT LIABILITY), A CONTRACT CLAIM, OR ANY OTHER CLAIM. THIS LIMITATION OF LIABILITY CANNOT BE WAIVED OR AMENDED BY ANY PERSON. THIS LIMITATION OF LIABILITY WILL BE EFFECTIVE EVEN IF YOU HAVE ADVISED HP OR AN AUTHORIZED REPRESENTATIVE OF HP OF THE

POSSIBILITY OF ANY SUCH DAMAGES. THIS LIMITATION OF LIABILITY, HOWEVER, WILL NOT APPLY TO CLAIMS FOR PERSONAL INJURY.

THIS LIMITED WARRANTY GIVES YOU SPECIFIC LEGAL RIGHTS. YOU MAY ALSO HAVE OTHER RIGHTS THAT MAY VARY FROM STATE TO STATE OR FROM COUNTRY/REGION TO COUNTRY/REGION. YOU ARE ADVISED TO CONSULT APPLICABLE STATE OR COUNTRY/REGION LAWS FOR A FULL DETERMINATION OF YOUR RIGHTS.

Limited Warranty Period

The Limited Warranty Period for an HP Hardware Product is a specified, fixed period commencing on the date of purchase. The date on your sales receipt is the date of purchase unless HP or your reseller informs you otherwise in writing.

Hardware:

Original Systems —	1 year
Technical phone assistance to diagnose potential hardware issues —	1 year

Types of Warranty Service

To enable HP to provide the best possible support and service during the Limited Warranty Period, you may be directed by HP to verify configurations, load most recent firmware, install software patches, run HP diagnostics tests or use HP remote support solutions where applicable.

HP strongly encourages you to accept the use of, or to employ available support technologies provided by HP. If you choose not to deploy available remote support capabilities, you may incur additional costs due to increased support resource requirements. Listed below are the types of warranty support service that may be applicable to the HP Hardware Product you have purchased.

Customer Self Repair Warranty Service

In countries/regions where it is available, your HP Limited Warranty may include a Customer Self Repair warranty service. If applicable, HP will determine in its sole discretion that Customer Self Repair is the appropriate method of warranty service. If so, HP will ship approved replacement parts directly to you to fulfill your HP Hardware Product warranty service. This will save considerable repair time. After you contact HP and the fault diagnosis identifies that the problem can be fixed using one of these parts, a replaceable part can be sent directly to you. Once the part arrives, replace the defective part pursuant to the provided

instructions and documentation. If further assistance is required, call the HP Technical Support Center and a technician will assist you over the phone. In cases where the replacement part must be returned to HP, you must ship the defective part back to HP within a defined period of time, normally fifteen (15) days. The defective part must be returned with the associated documentation in the provided shipping material. Failure to return the defective product may result in HP billing you for the replacement. With a Customer Self Repair, HP will pay all shipping and part return costs and determine the courier/carrier to be used. If Customer Self Repair applies to you, please refer to your specific HP Hardware Product announcement. You can also obtain information on this warranty service on the HP Web site at: <http://www.hp.com/support>

Pick Up and Return Warranty Service

Your HP Limited Warranty may include a pick up and return warranty service. Under the terms of pick up and return service, HP will pick up the defective unit from your location, repair it and return it back to your location. HP will incur all repair, logistics and insurance costs in this process.

Carry-in Warranty Service

Under the terms of carry-in service, you will be required to deliver your HP Hardware Product to an authorized service location for warranty repair. You must prepay any shipping charges, taxes, or duties associated with transportation of the product to and from the service location. In addition, you are responsible for insuring any product shipped or returned to an authorized service location and assume risk of loss during shipping.

Limited Warranty Transfer to Another Country/Region

Under the HP Global Limited Warranty program, products may be purchased in one country/region and transferred to another country/region, where HP has a service presence, without voiding the warranty. Warranty terms, service availability, and service response times may vary from country/region to country/region. Also, standard warranty service response time is subject to change due to local parts availability. A customer may be required to provide product specific information, in accordance with the HP Global Warranty Notification process, prior to moving the products. The required information ensures that HP is prepared to provide the required level of warranty service in the destination country/region and that the product is designed to work in the destination country/region. When the product has been transferred to another country/region it will be entitled to the same warranty as if the product had been

purchased in the country/region to which it has been transferred.

Contact HP, your local HP authorized reseller, or refer to the Web site at: <http://www.hp.com/support> to begin the HP Global Warranty Notification process prior to transferring HP Products to another country/region.

HP is not responsible for any tariffs or duties that may be incurred in transferring the products. Transfer of the products may be covered by export controls issued by the United States or other governments.

Service Upgrades

HP has a range of additional support and service coverage for your product that can be purchased locally. However, some support and related products may not be available in all countries/regions. For information on availability of service upgrades and the cost for these service upgrades, refer to the HP Web site at:

<http://www.hp.com/support>

Options and Software Limited Warranties

The Limited Warranty terms and conditions for most HP-branded options (HP Options) are as set forth in the Limited Warranty applicable to the HP Option and are included in the HP Option product packaging. If your HP Option is installed in an HP Hardware Product, HP may provide warranty service for either the period specified in the warranty documents (HP Option Limited Warranty Period) that shipped with the HP Option or for the remaining warranty period of the HP Hardware Product in which the HP Option is being installed, whichever period is the longer, but not to exceed three (3) years from the date you purchased the HP option. The HP Option Limited Warranty Period starts from the date of purchase from HP or an HP authorized reseller. Your dated sales or delivery receipt, showing the date of purchase of the HP Option, is your warranty start date. See your HP Option Limited Warranty for more details. Non-HP options are provided "AS IS". However, non-HP manufacturers and suppliers may provide warranties directly to you.

EXCEPT AS PROVIDED IN THE APPLICABLE SOFTWARE END-USER LICENSE OR PROGRAM LICENSE AGREEMENT, OR IF OTHERWISE PROVIDED UNDER LOCAL LAW, SOFTWARE PRODUCTS, INCLUDING ANY SOFTWARE PRODUCTS OR THE OPERATING SYSTEM PREINSTALLED BY HP ARE PROVIDED "AS IS".

HP's only warranty obligations with respect to software distributed by HP under the HP brand name are set forth in

the applicable end-user license or program license agreement provided with that software. If the removable media on which HP distributes the software proves to be defective in materials or workmanship within ninety (90) days of purchase, your sole remedy shall be to return the removable media to HP for replacement.

It is your responsibility to contact non-HP manufacturers or suppliers for their warranty support.

Software Technical Support

Software Technical Support for your HP Software, HP pre-installed third-party software and third-party software purchased from HP is available from HP via multiple contact methods, including electronic media and telephone, for ninety (90) days from date of purchase. See "Contacting HP" for online resources and telephone support. Any exceptions to this will be specified in your End User License Agreement (EULA).

Software Technical Support includes assistance with:

- Answering your installation questions (how to, first steps, and prerequisites).
- Setting up and configuring the software (how-to and first steps). **Excludes** system optimization, customization and network configuration.
- Interpreting system error messages.
- Isolating system problems to software usage problems.
- Obtaining support pack information or updates.

Software technical support does NOT include assistance with:

- Generating or diagnosing user-generated programs or source codes.
- Installation of non-HP products.

Contacting HP

If your product fails during the Limited Warranty Period and the suggestions in the product documentation do not solve the problem, you can receive support by doing the following:

Locate your nearest HP Support location via the World Wide Web at: <http://www.hp.com/support>

Contact your authorized HP dealer or Authorized Service Provider and be sure to have the following information available before you call HP:

- Product serial number, model name, and model number
- Applicable error messages
- Add-on options

- Operating system
- Third-party hardware or software
- Detailed questions

End User License Agreement

PLEASE READ CAREFULLY BEFORE USING THIS EQUIPMENT: This End-User License Agreement (“EULA”) is a legal agreement between (a) you (either an individual or a single entity) and (b) Hewlett-Packard Company (“HP”) that governs your use of any Software Product, installed on or made available by HP for use with your HP product (“HP Product”), that is not otherwise subject to a separate license agreement between you and HP or its suppliers. Other software may contain a EULA in its online documentation. The term “Software Product” means computer software and may include associated media, printed materials and “online” or electronic documentation. An amendment or addendum to this EULA may accompany the HP Product.

RIGHTS IN THE SOFTWARE PRODUCT ARE OFFERED ONLY ON THE CONDITION THAT YOU AGREE TO ALL TERMS AND CONDITIONS OF THIS EULA. BY INSTALLING, COPYING, DOWNLOADING, OR OTHERWISE USING THE SOFTWARE PRODUCT, YOU AGREE TO BE BOUND BY THE TERMS OF THIS EULA. IF YOU DO NOT ACCEPT THESE LICENSE TERMS, YOUR SOLE REMEDY IS TO RETURN THE ENTIRE UNUSED PRODUCT (HARDWARE AND SOFTWARE) WITHIN 14 DAYS FOR A REFUND SUBJECT TO THE REFUND POLICY OF YOUR PLACE OF PURCHASE.

1. GRANT OF LICENSE. HP grants you the following rights provided you comply with all terms and conditions of this EULA:

- Use.** You may use the Software Product on a single computer (“Your Computer”). If the Software Product is provided to you via the Internet and was originally licensed for use on more than one computer, you may install and use the Software Product only on those computers. You may not separate component parts of the Software Product for use on more than one computer. You do not have the right to distribute the Software Product. You may load the Software Product into Your Computer’s temporary memory (RAM) for purposes of using the Software Product.
- Storage.** You may copy the Software Product into the local memory or storage device of the HP Product.
- Copying.** You may make archival or back-up copies of the Software Product, provided the copy contains all of the original Software Product’s proprietary notices and that it is used only for back-up purposes.

d. **Reservation of Rights.** HP and its suppliers reserve all rights not expressly granted to you in this EULA.

e. **Freeware.** Notwithstanding the terms and conditions of this EULA, all or any portion of the Software Product which constitutes non-proprietary HP software or software provided under public license by third parties (“Freeware”), is licensed to you subject to the terms and conditions of the software license agreement accompanying such Freeware whether in the form of a discrete agreement, shrink wrap license or electronic license terms accepted at time of download. Use of the Freeware by you shall be governed entirely by the terms and conditions of such license.

f. **Recovery Solution.** Any software recovery solution provided with/for your HP Product, whether in the form of a hard disk drive-based solution, an external media-based recovery solution (e.g. floppy disk, CD or DVD) or an equivalent solution delivered in any other form, may only be used for restoring the hard disk of the HP Product with/for which the recovery solution was originally purchased. The use of any Microsoft operating system software contained in such recovery solution shall be governed by the Microsoft License Agreement.

2. **UPGRADES.** To use a Software Product identified as an upgrade, you must first be licensed for the original Software Product identified by HP as eligible for the upgrade. After upgrading, you may no longer use the original Software Product that formed the basis for your upgrade eligibility.

3. **ADDITIONAL SOFTWARE.** This EULA applies to updates or supplements to the original Software Product provided by HP unless HP provides other terms along with the update or supplement. In case of a conflict between such terms, the other terms will prevail.

4. **TRANSFER.**

a. **Third Party.** The initial user of the Software Product may make a one-time transfer of the Software Product to another end user. Any transfer must include all component parts, media, printed materials, this EULA, and if applicable, the Certificate of Authenticity. The transfer may not be an indirect transfer, such as a consignment. Prior to the transfer, the end user receiving the transferred product must agree to all the EULA terms. Upon transfer of the Software Product, your license is automatically terminated.

b. **Restrictions.** You may not rent, lease or lend the Software Product or use the Software Product for commercial timesharing or bureau use. You may not sublicense, assign or transfer the license or Software Product except as expressly provided in this EULA.

5. PROPRIETARY RIGHTS. All intellectual property rights in the Software Product and user documentation are owned by HP or its suppliers and are protected by law, including but not limited to United States copyright, trade secret, and trademark law, as well as other applicable laws and international treaty provisions. You shall not remove any product identification, copyright notices or proprietary restrictions from the Software Product.

6. LIMITATION ON REVERSE ENGINEERING. You may not reverse engineer, decompile, or disassemble the Software Product, except and only to the extent that the right to do so is mandated under applicable law notwithstanding this limitation or it is expressly provided for in this EULA.

7. TERM. This EULA is effective unless terminated or rejected. This EULA will also terminate upon conditions set forth elsewhere in this EULA or if you fail to comply with any term or condition of this EULA.

8. CONSENT TO USE OF DATA. You agree that HP and its affiliates may collect and use technical information you provide in relation to support services related to the Software Product. HP agrees not to use this information in a form that personally identifies you except to the extent necessary to provide such services.

9. DISCLAIMER OF WARRANTIES. TO THE MAXIMUM EXTENT PERMITTED BY APPLICABLE LAW, HP AND ITS SUPPLIERS PROVIDE THE SOFTWARE PRODUCT "AS IS" AND WITH ALL FAULTS, AND HEREBY DISCLAIM ALL OTHER WARRANTIES AND CONDITIONS, EITHER EXPRESS, IMPLIED, OR STATUTORY, INCLUDING, BUT NOT LIMITED TO, WARRANTIES OF TITLE AND NON-INFRINGEMENT, ANY IMPLIED WARRANTIES, DUTIES OR CONDITIONS OF MERCHANTABILITY, OF FITNESS FOR A PARTICULAR PURPOSE, AND OF LACK OF VIRUSES ALL WITH REGARD TO THE SOFTWARE PRODUCT. Some states/jurisdictions do not allow exclusion of implied warranties or limitations on the duration of implied warranties, so the above disclaimer may not apply to you in its entirety.

10. LIMITATION OF LIABILITY. Notwithstanding any damages that you might incur, the entire liability of HP and any of its suppliers under any provision of this EULA and your exclusive remedy for all of the foregoing shall be limited to the greater of the amount actually paid by you separately for the Software Product or U.S. \$5.00. TO THE MAXIMUM EXTENT PERMITTED BY APPLICABLE LAW, IN NO EVENT SHALL HP OR ITS SUPPLIERS BE LIABLE FOR ANY SPECIAL, INCIDENTAL, INDIRECT, OR CONSEQUENTIAL DAMAGES WHATSOEVER (INCLUDING, BUT NOT LIMITED TO, DAMAGES FOR LOSS OF PROFITS OR CONFIDENTIAL OR OTHER

INFORMATION, FOR BUSINESS INTERRUPTION, FOR PERSONAL INJURY, FOR LOSS OF PRIVACY ARISING OUT OF OR IN ANY WAY RELATED TO THE USE OF OR INABILITY TO USE THE SOFTWARE PRODUCT, OR OTHERWISE IN CONNECTION WITH ANY PROVISION OF THIS EULA) EVEN IF HP OR ANY SUPPLIER HAS BEEN ADVISED OF THE POSSIBILITY OF SUCH DAMAGES AND EVEN IF THE REMEDY FAILS OF ITS ESSENTIAL PURPOSE. Some states/jurisdictions do not allow the exclusion or limitation of incidental or consequential damages, so the above limitation or exclusion may not apply to you.

11. U.S. GOVERNMENT CUSTOMERS. Consistent with FAR 12.211 and 12.212, Commercial Computer Software, Computer Software Documentation, and Technical Data for Commercial Items are licensed to the U.S. Government under HP's standard commercial license.

12. COMPLIANCE WITH EXPORT LAWS. You shall comply with all laws and regulations of the United States and other countries/regions ("Export Laws") to assure that the Software Product is not (1) exported, directly or indirectly, in violation of Export Laws, or (2) used for any purpose prohibited by Export Laws, including, without limitation, nuclear, chemical, or biological weapons proliferation.

13. CAPACITY AND AUTHORITY TO CONTRACT. You represent that you are of the legal age of majority in your state of residence and, if applicable, you are duly authorized by your employer to enter into this contract.

14. APPLICABLE LAW. This EULA is governed by the laws of the State of California, U.S.A.

15. ENTIRE AGREEMENT. This EULA (including any addendum or amendment to this EULA which is included with the HP Product) is the entire agreement between you and HP relating to the Software Product and it supersedes all prior or contemporaneous oral or written communications, proposals and representations with respect to the Software Product or any other subject matter covered by this EULA. To the extent the terms of any HP policies or programs for support services conflict with the terms of this EULA, the terms of this EULA shall control.

© 2004 Hewlett-Packard Development Company, L.P. The information contained herein is subject to change without notice. All other product names mentioned herein may be trademarks of their respective companies. The only warranties for HP products and services are set forth in the express warranty statements accompanying such products and services. Nothing herein should be construed as constituting an additional warranty. HP shall not be liable for technical or editorial errors or omissions contained herein.

DECLARATION OF CONFORMITY

according to ISO/IEC Guide 22 and EN 45014

Manufacturer's Name: Hewlett-Packard Company

Manufacturer's Address: Hewlett-Packard Company
10500 Ridgeview Court
Cupertino, CA 95014

declares, that the product(s)

Product: Personal computer
Model Number(s): S0000, SR1000, SA3000, m000, m1000, m5000, d1000, a000, t000, 8000, 9000 series
Product Options: All

conforms to the following Product Specifications:

Safety: IEC 60950: 1999 / EN60950: 2000
IEC 60825-1:1993 +A1 / EN 60825-1:1994 +A11 Class 1 (Laser/LED)
GB4943: 2001

EMC: CISPR 22: 1997 / EN 55022: 1998 +A1 Class B
CISPR 24: 1997 / EN 55024: 1998
IEC 61000-3-2:2000 / EN 61000-3-2: 2000
IEC 61000-3-3:1994 + A1: 2001 / EN 61000-3-3: 1995 + A1: 2001
GB9254: 1998
FCC Title 47 CFR, Part 15 Class B / ICES-002, issue 2
AS/NZS CISPR 22: 2002

Telecom: TBR 21: 1998, EG 201 121: 1998

Radio: ETSI 300-826 General EMC requirements for Radio equipment.
ETSI 300-328 Technical requirements for Radio equipment.

Supplementary Information:

The product herewith complies with the requirements of the Low Voltage Directive 73/23/EEC, the EMC Directive 89/336/EEC and the R&TTE Directive 1999/5/EC and carries the "CE Marking" accordingly.

This device complies with Part 15 of FCC rules. Operation is subject to the following two conditions: (1) this device may not cause harmful interference, and (2) this device must accept any interference received, including interference that may cause undesired operation.

Cupertino, CA. USA June 8, 2004 Signature / Manager: _____
Ervin Gomez, Hardware Quality Eng. Manager

For regulatory compliance information only, contact:

Australia Contact: Product Regulations Manager, Hewlett-Packard Australia Ltd., 31-41 Joseph Street, Blackburn, Victoria 3130

European Contact: Hewlett-Packard GmbH, HQ-TRE, Herrenberger Straße 140, 71034 Böblingen, Germany (FAX: +49-7031-14-3143).

North America Contact: Hardware Quality Eng. Manager, Hewlett-Packard, CPC, 10500 Ridgeview Ct., Cupertino, CA 95015-4010. Phone: (408)-343-5000

Operating Specifications

Electrical ratings:	100–127 V _~ /200–240 V _~ , 4/2 A or 6/3 A or 8/4 A, 50/60 Hz
Operating temperature:	5° to 35° C (On models with DVD+RW/+R drives, the operating temperature is 5° to 30° C.)
Storage temperature:	–30° to 65° C
Operating humidity:	15 to 80% @ 26° C
Operating altitude:	0–2286 m
Storage altitude:	0–4572 m

Regulatory and Safety Information

 **WARNING:** Text set off in this manner indicates that failure to follow directions could result in damage to equipment, loss of information, bodily harm, or loss of life.

 **WARNING:** The PC is heavy; be sure to use ergonomically correct lifting procedures when moving the computer.

 **WARNING:** Please read the “Additional Safety Information” located later in this document before installing and connecting your PC to the electrical power system.



Batteries are delivered with this product. When empty, do not throw them away but collect as small chemical waste.

Bij dit product zijn batterijen geleverd. Wanneer deze leeg zijn, moet u ze niet weggooien maar inleveren als Klein Chemisch Afval (KCA).

FCC Regulatory and Safety Information (USA Only)

Federal Communications Commission (FCC) Radio Frequency Interference Statement

 **WARNING:** This equipment has been tested and found to comply with the limits for a Class B digital device, pursuant to Part 15 of the FCC Rules. These limits are designed to provide reasonable protection against harmful interference in a residential installation. This equipment generates, uses, and can radiate radio frequency energy and, if not installed and used in accordance with the instructions, may cause harmful interference to radio communications. However, there is no guarantee that interference will not occur in a particular installation. If this equipment does cause harmful interference to radio or television reception, which can be determined by turning the equipment off and on, the user is encouraged to correct the interference by one or more of the following measures:

- Reorient or relocate the receiving antenna.
- Increase the separation between the equipment and the receiver.
- Connect the equipment into an outlet that is on a circuit different from the receiver.
- Consult the dealer or an experienced radio/TV technician for help.

The system RFI and Radiated Immunity tests were conducted with supported peripheral devices and shielded cables, such as those you receive with your system. Changes or modifications not expressly approved by the manufacturer could void the user's authority to operate the equipment. To comply with the limits for an FCC Class B computing device, always use shielded signal cables and the power cord supplied with this unit.

Consumer Information and FCC Requirements

Telephone Connection

- This equipment complies with Part 68 of the Federal Communications Commission rules. These rules permit this device to be directly connected to the telephone network. Standardized jacks are used for these connections. This equipment should not be used on party lines or coin lines.
- If this device is malfunctioning, it may also cause harm to the telephone network; this device should be disconnected until the source of the problem can be determined and until it has been repaired. If this is not done, the telephone company may temporarily disconnect your service.
- The telephone company may make changes in its technical operations and procedures. If such changes affect the compatibility or use of this device, the telephone company is required to give adequate notice of the changes.
- If the telephone company requests information on what equipment is connected to their lines, inform them of:
 - a The telephone number this unit is connected to
 - b The ringer equivalence number
 - c The USOC jack required: RJ-11C
 - d The FCC Registration Number

Items (b) and (c) are indicated on the label. The ringer equivalence number (REN) is used to determine how many devices can be connected to your telephone line. In most areas, the sum of the RENs on any one line should not exceed five (5.0). If too many devices are attached, they may not ring properly.

- In the event of equipment malfunction, the manufacturer or an authorized repair center should perform all repairs. It is the responsibility of users requiring service to report the problem to the manufacturer, or an authorized agent. Refer to "Where to Get Help" in this document for contact information.

Statement of Fax Branding

The Consumer Protection Act of 1991 makes it unlawful for any person to use a computer or other electronic device to send any message via telephone fax machine, unless it clearly contains: a margin at the top or bottom of each transmitted page or on the first page of the transmission, the date and time it is sent, identification of the business or other entity, or individual sending the message, the telephone number of the sending machine or such business, entity, or individual.

ENERGY STAR Compliance

Products marked with the ENERGY STAR® logo on the packaging box qualify with the U.S. Environmental Protection Agency's ENERGY STAR guidelines for energy efficiency.



Products with the ENERGY STAR label are designed to use less energy, help you save money on utility bills, and help protect the environment.

ENERGY STAR® is a registered trademark owned by the U.S. government.

Canada Department of Communications (DOC) Notice

Telephone Connection

The Canada Department of Communications label identifies certified equipment. This certification means that the equipment meets certain telecommunications network protective, operational, and safety requirements. The department does not guarantee the equipment will operate to the user's satisfaction.

Before installing this equipment, the user should ensure it is permissible to connect it to the facilities of the local communications company. The equipment must be installed using an acceptable method of connection. In some cases, the company's inside wiring associated with a single line individual service may be extended by means of a certified connector assembly (telephone extension cord). The customer should be aware that compliance with the above conditions may not prevent degradation of service in some situations.

Repairs to certified equipment should be made by an authorized Canadian maintenance facility designated by the supplier. Any repairs or alterations made by the user to this equipment, or equipment malfunctions, may give the telecommunications company cause to request that the user disconnect the equipment.

Users should ensure, for their own protection, that the electrical ground connections of the power utility, telephone lines, and internal metallic water pipe systems, if present, are connected together. This precaution may be particularly important in rural areas.



WARNING: Users should not attempt to make such connections themselves, but should contact the appropriate electrical inspection authority or electrician, as appropriate.



WARNING: The Load Number .9 assigned to each terminal device denotes the percentage of the total load to be connected to a telephone loop; this is used by the device to prevent overloading. The termination on a loop may consist of any combination of devices, subject only to the requirement that the sum of the Load Numbers does not exceed 100.



WARNING: When using this device, basic safety precautions should always be followed to reduce the risk of fire, electric shock, and injury to persons, including the following:

- Do not use this product near water; for example, near a bathtub, wash bowl, kitchen sink, or laundry tub, in a wet basement, or near a swimming pool.
- Avoid using this product during an electrical storm. There may be a remote risk of electric shock from lightning.
- Do not use this product to report a gas leak in the vicinity of the leak.
- Always disconnect the modem cable before opening the equipment enclosure or touching an uninsulated modem cable, jack, or internal components.
- If this product was not provided with a telephone line cord, use only No. 26 AWG or larger telecommunication line cord in order to reduce the risk of fire.
- Do not plug a modem or telephone cable into the Network Interface Card (NIC) receptacle.

SAVE THESE INSTRUCTIONS

DOC Statement (Canada Only)

This Class B digital apparatus meets all requirements of the Canadian Interference-Causing Equipment Regulations.

Additional Safety Information

This product has not been evaluated for connection to an "IT" power system (an AC distribution system with no direct connection to earth, according to IEC 60950).

This equipment meets the applicable Industry Canada Terminal Equipment Technical Specifications. This is confirmed by the registration number. The abbreviation, IC, before the registration number signifies that registration was performed based on a Declaration of Conformity indicating that Industry Canada technical specifications were met. It does not imply that Industry Canada approved the equipment.

AC Power Safety Warning



WARNING: Install the computer near an AC outlet. The AC power cord is your PC's main AC disconnecting device and must be easily accessible at all times. For your safety, the power cord provided with your PC has a grounded plug. Always use the power cord with a properly grounded wall outlet, to avoid the risk of electrical shock.



WARNING: Your PC is provided with a voltage select switch for use in a 115 or 230 VAC power system. The voltage select switch has been preset to the correct voltage setting for use in the particular country/region where it was initially sold. Changing the voltage select switch to the incorrect position can damage your PC and void any implied warranty.



WARNING: To reduce the possibility of an electric shock from the telephone network, plug your computer into the AC outlet before connecting it to the telephone line. Also, disconnect the telephone line before unplugging your computer from the AC power outlet.



WARNING: Always disconnect the modem cord from the telephone system before installing or removing your computer cover.



WARNING: Do not operate the computer with the cover removed.



WARNING: For your safety, always unplug the PC from its power source and from any telecommunications systems (such as telephone lines), networks, or modems before performing any service procedures. Failure to do so may result in personal injury or equipment damage. Hazardous voltage levels are inside the power supply and modem of this product.

Lithium Battery Caution



WARNING: The PC uses a lithium battery, type CR2032. There is danger of an explosion if the battery is incorrectly replaced. Replace only with the same, or equivalent, type recommended by the manufacturer. Dispose of used batteries according to the manufacturer's instructions.

Laser Safety Statement

Class 1 LED Product

The CD and DVD drives contain a laser system and are classified as a "Class 1 Laser Product" under a U.S. Department of Health and Human Services (DHHS) Radiation Performance standard according to the Radiation Control for Health and Safety Act of 1968.

Should the unit ever require maintenance, contact an authorized service location.



WARNING: Use of controls, adjustments, or performance procedures other than those specified in the *Upgrading and Servicing Guide* may result in hazardous radiation exposure. To prevent direct exposure to laser beam, do not try to open the enclosure of the CD or DVD drives.

Laser Product Label

The following label or equivalent is located on the surface of laser products:



This label indicates that the product is classified as a CLASS 1 LASER PRODUCT. This label appears on a laser device installed in your product.

TV Antenna Connectors Protection

External Television Antenna Grounding

If an outside antenna or cable system is connected to the product, be sure the antenna or cable system is electrically grounded so as to provide some protection against voltage surges and built-up static charges. Article 810 of the National Electrical Code, ANSI/NFPA 70, provides information with regard to proper electrical grounding of the mast and supporting structure, grounding of the lead-in wire to an antenna-discharge unit, size of grounding conductors, location of antenna-discharge unit, connection to grounding electrodes, and requirements for the grounding electrode.

Lightning Protection

For added protection of any product during a lightning storm, or when it is left unattended and unused for long periods of time, unplug the product from the wall outlet and disconnect the antenna or cable system. This will prevent damage to the product from lightning and power line surges.

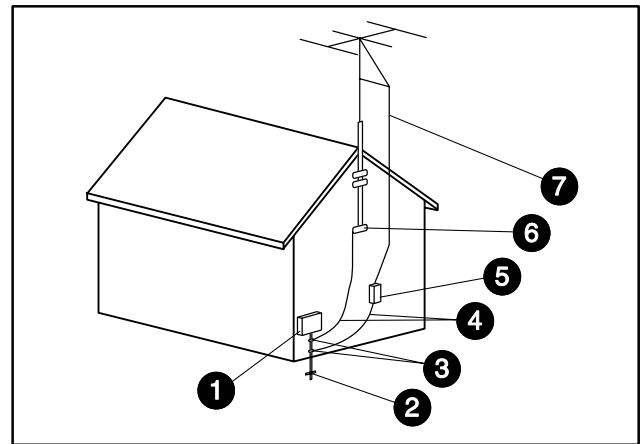

Antenna Grounding

Antenna Grounding

Reference	Grounding Component
1	Electric Service Equipment
2	Power Service Grounding Electrode System (NEC Art 250, Part H)
3	Ground Clamps
4	Grounding Conductors (NEC Section 810-21)
5	Antenna Discharge Unit (NEC Section 810-20)
6	Ground Clamp
7	Antenna Lead in Wire

Power Lines

An outside antenna system should not be located in the vicinity of overhead power lines or other electric light or power circuits, or where it can fall into such power lines or circuits.



WARNING: When installing an outside antenna system, extreme care should be taken to keep from touching such power lines or circuits as contact with them could be fatal.

© 2004 Hewlett-Packard Development Company, L.P.

Printed in

