

# HP Photosmart 8100 series Reference Guide

English

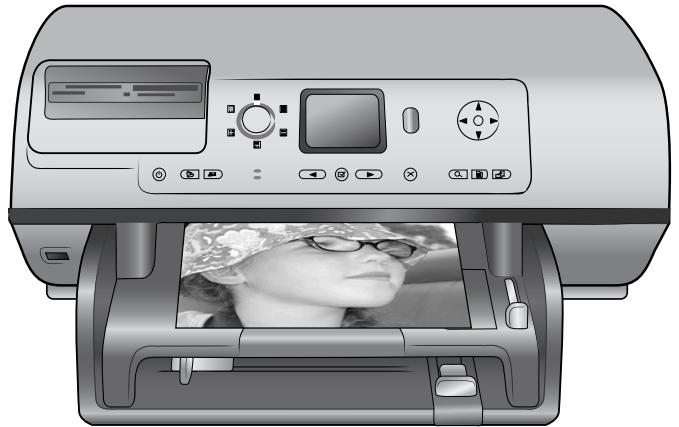

## Copyrights and trademarks

© Copyright 2004 Hewlett-Packard Development Company, L.P.

The information contained herein is subject to change without notice. Reproduction, adaptation or translation without prior written permission is prohibited, except as allowed under the copyright laws.

## Notice

The only warranties for HP products and services are set forth in the express warranty statements accompanying such products and services. Nothing herein should be construed as constituting an additional warranty. HP shall not be liable for technical or editorial errors or omissions contained herein.

The Hewlett-Packard Development Company, L.P. shall not be liable for incidental or consequential damages in connection with, or arising out of the furnishing, performance, or use of this document and the program material which it describes.

## Trademarks

HP, the HP logo, and Photosmart are property of Hewlett-Packard Development Company, L.P.

The Secure Digital logo is a trademark of the SD Association.

Microsoft and Windows are registered trademarks of Microsoft Corporation.

CompactFlash, CF, and the CF logo are trademarks of the CompactFlash Association (CFA).

Memory Stick, Memory Stick Duo, Memory Stick PRO, and Memory Stick PRO Duo are trademarks or registered trademarks of Sony Corporation.

MultiMediaCard is a trademark of Infineon Technologies AG of Germany, and is licensed to the MMCA (MultiMediaCard Association).

Microdrive is a trademark of Hitachi Global Storage Technologies.

SmartMedia is a trademark of Toshiba Corporation.

xD-Picture Card is a trademark of Fuji Photo Film Co., Ltd., Toshiba Corporation, and Olympus Optical Co., Ltd.

Mac, the Mac logo, and Macintosh are registered trademarks of Apple Computer, Inc.

The Bluetooth word mark and logos are owned by the Bluetooth SIG, Inc. and any use of such marks by Hewlett-Packard Company is under license.

PictBridge and the PictBridge logo are trademarks of the Camera & Imaging Products Association (CIPA).

Other brands and their products are trademarks or registered trademarks of their respective holders.

The embedded software in the printer is based in part on the work of the Independent JPEG Group.

The copyrights to certain photos within this document are retained by the original owners.

## Regulatory model identification number SDGOA-0402

For regulatory identification purposes, the product is assigned a Regulatory Model Number. The Regulatory Model Number for the product is SDGOA-0402. This regulatory number should not be confused with the marketing name (HP Photosmart 8100 series printer) or product number (Q3399A).

## Safety information

Always follow basic safety precautions when using this product to reduce risk of injury from fire or electric shock.



**Warning** To prevent fire or shock hazard, do not expose this product to rain or any type of moisture.

- Read and understand all instructions in the *HP Photosmart 8100 series Start Here* booklet.
- Use only a grounded electrical outlet when connecting the unit to a power source. If you do not know whether the outlet is grounded, check with a qualified electrician.
- Observe all warnings and instructions marked on the product.
- Unplug this product from wall outlets before cleaning.
- Do not install or use this product near water or when you are wet.
- Install the product securely on a stable surface.

- Install the product in a protected location where no one can step on or trip over the power cord, and where the power cord will not be damaged.
- If the product does not operate normally, see the troubleshooting information in the onscreen HP Photosmart Printer Help.
- There are no operator serviceable parts inside. Refer servicing to qualified service personnel.
- Use in a well-ventilated area.

# Contents

<b>1</b>	<b>Welcome</b> .....	<b>3</b>
	Find more information.....	3
	What's in the box.....	3
	Printer overview.....	4
	Printer menu.....	7
	Paper information.....	13
	Print cartridge information.....	14
<b>2</b>	<b>Printing with your new printer</b> .....	<b>19</b>
	Quick start.....	19
	Printing without a computer.....	20
	Using memory cards.....	20
	Supported file formats.....	20
	Inserting memory cards.....	20
	Selecting photos.....	21
	Printing selected photos.....	22
	Enhancing photos.....	22
	Changing printer preferences.....	22
	Getting connected.....	22
	Connecting to other devices.....	22
	Connecting through HP Instant Share.....	23
	Printing with a computer.....	24
<b>3</b>	<b>Installing the software</b> .....	<b>27</b>
	Installing the software.....	27
	Installation troubleshooting.....	28
<b>4</b>	<b>Support and warranty</b> .....	<b>29</b>
	Customer Care.....	29
	Customer Care by phone.....	29
	Placing a call.....	30
	Limited warranty statement.....	31
<b>5</b>	<b>Specifications</b> .....	<b>33</b>
	System requirements.....	33
	Printer specifications.....	33
	Environmental statements.....	36
	Protecting the environment.....	36
	Ozone production.....	36
	Energy consumption.....	36
	Paper use.....	36
	Plastics.....	36
	Material safety data sheets.....	36
	Recycling program.....	37



# 1 Welcome

Thank you for purchasing an HP Photosmart 8100 series printer! With this new photo printer you can print beautiful photos, save photos to a computer, and create fun and easy projects with or without a computer.

## Find more information

The printer comes with the following documentation:

- **Setup Guide:** The *HP Photosmart 8100 series Setup Guide* explains how to set up the printer, install the printer software, and print your first photo.
- **User's Guide:** The *User's Guide* describes the basic features of the printer, explains how to use the printer without connecting a computer, and contains hardware troubleshooting information. It is available in online format on the *User's Guide* CD.
- **Reference Guide:** The *HP Photosmart 8100 series Reference Guide* is the book you are reading. It provides basic information about the printer, including setup, operation, technical support, and warranty. For detailed instructions, see the *User's Guide* CD.
- **HP Photosmart Printer Help:** The onscreen HP Photosmart Printer Help describes how to use the printer with a computer and contains software troubleshooting information.

After you have installed the HP Photosmart printer software on a computer, you can view the onscreen HP Photosmart Printer Help:

- **Windows PC:** From the **Start** menu, select **Programs** (in Windows XP, select **All Programs**) > **HP** > **Photosmart 320, 370, 7400, 7800, 8100, 8400, 8700 series** > **Photosmart Help**.
- **Macintosh:** Select **Help** > **Mac Help** in the Finder, then select **Library** > **HP Photosmart Printer Help for Macintosh**.

## What's in the box

The printer box contains the following items:

- The HP Photosmart 8100 series printer
- The HP Photosmart 8100 series *Setup Guide*
- The HP Photosmart 8100 series *Reference Guide*
- The HP Photosmart 8100 series printer software CD
- The *User's Guide* CD
- Paper sampler
- Photo paper storage bag
- Tri-color and Photo print cartridges
- Print cartridge protector
- A power supply (power supplies may vary in appearance or have an additional power cord)

**Note** Contents may vary by country/region.

## Printer overview

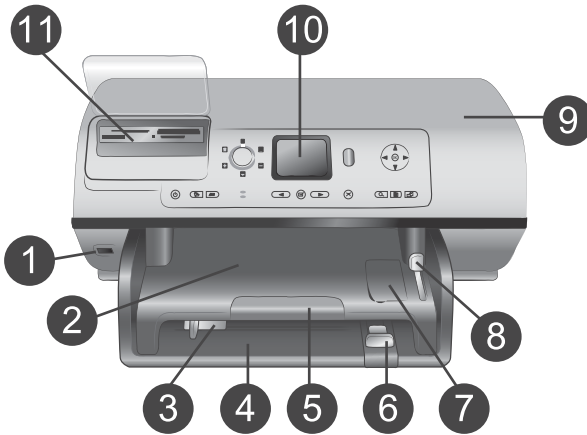

### Front of printer

- 1 **Camera port**  
Use this port to connect a PictBridge™ digital camera to the printer, or to insert the optional HP Bluetooth® wireless printer adapter.
- 2 **Out tray**  
Lift this tray to load small media or to clear front paper jams.
- 3 **Paper-width guide**  
Adjust this guide to fit close to the edge of the paper in the Main tray.
- 4 **Main tray**  
Place plain paper, transparencies, envelopes, or other media in this tray for printing.
- 5 **Out tray extender**  
Lift the tab, then pull it towards you to extend the Out tray to catch the printed paper as it is ejected from the printer.
- 6 **Paper-length guide**  
Adjust this guide to fit close to the end of the paper in the Main tray.
- 7 **Photo tray**  
Lift the Out tray to load small photo paper in the Photo tray.
- 8 **Photo tray slider**  
Push this slider away from you to engage the Photo tray.
- 9 **Top cover**  
Lift this cover to access the print cartridges and the print cartridge storage area, and to clear paper jams.
- 10 **Printer screen**  
Use this screen to view your photos and menu options.
- 11 **Memory card slots**  
Insert memory cards here.

(continued)

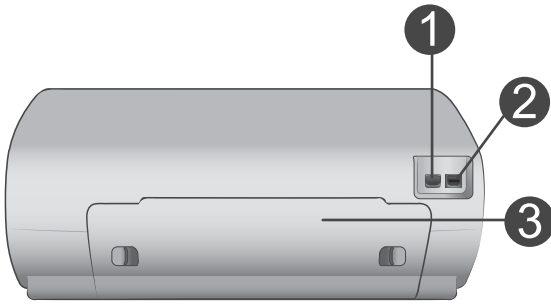

### Back of printer

- 1 Power cord connection**  
Use this port to connect the power cord included with the printer.
- 2 USB port**  
Use this port to connect the printer to a computer or to an HP direct-printing digital camera.
- 3 Rear access door**  
Remove this door to clear paper jams.

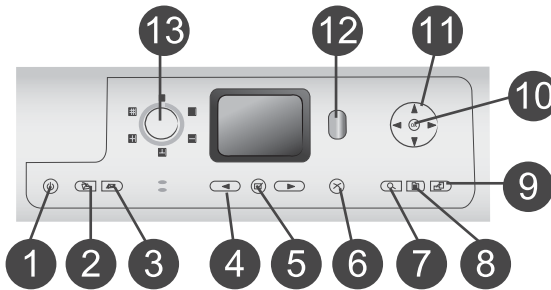

### Control panel

- 1 On**  
Press this button to turn on the printer or put it into power save mode.
- 2 Save**  
Press this button to save photos from a memory card to a computer.
- 3 HP Instant Share**  
Press this button to send a photo via e-mail. The **Save** and **HP Instant Share** buttons work only when the printer is connected to a computer. For more information, see [Getting connected](#).
- 4 Select Photos arrows**  
Use these arrows to scroll through the photos on a memory card.
- 5 Select Photos**  
Use this button to select the currently displayed photo or video frame for printing.
- 6 Cancel**  
Press this button to deselect photos, to exit a menu, or to stop an action you have requested.
- 7 Zoom**  
Press this button to enter Zoom mode and zoom in on the currently displayed photo, and to exit 9-up view mode.
- 8 Menu**

- Press this button to view the printer menu.
- 9 **Rotate**  
Press this button to rotate the currently displayed photo.
- 10 **OK**  
Press this button to answer questions on the printer screen, to select menu options, to enter 9-up view mode, and to play a video.
- 11 **Navigation arrows**  
Use these arrows to scroll through the printer menu options, position the crop box, and control the speed and direction of video playback.
- 12 **Print**  
Press this button to print selected photos from the inserted memory card.
- 13 **Layout**  
Turn this dial to select the print layout for your photos.

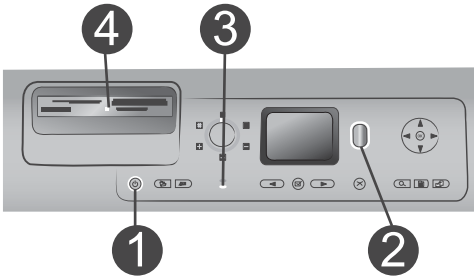

### Indicator lights

- 1 **On light**
- **On**—the power is on
  - **Off**—the printer is in power-save mode
- 2 **Status light**
- **On (Green)**—the power is on and the printer is not printing
  - **Off**—the printer is in power-save mode
  - **Flashing green**—the printer is busy printing
  - **Flashing red**—the printer requires attention



(continued)

	<p>3 <b>Paper tray lights</b></p> <ul style="list-style-type: none"><li>– <b>Photo tray light on</b>—the Photo tray is engaged</li><li>– <b>Main tray light on</b>—the Main tray is engaged</li></ul> <p>4 <b>Memory card light</b></p> <ul style="list-style-type: none"><li>– <b>On</b>—the memory card is inserted correctly</li><li>– <b>Off</b>—no memory card is inserted</li><li>– <b>Flashing</b>—information is being transmitted between the memory card and the printer or computer</li></ul>
--	--

## Printer menu

Press **Menu** to access the printer menu. If you are viewing a submenu, pressing **Menu** returns you to the main printer menu.

### To navigate the printer menu:

- Press **Navigation** ▲ or ▼ to scroll through the menu options displayed on the printer screen. Menu items that are not accessible are grayed out.
- Press **OK** to open a menu or select an option.
- Press **Cancel** to exit the current menu.

### Printer menu structure

Top level menu	Submenus/options	Additional submenus/options
Print Options	Print all	
	Print proof sheet	
	Scan proof sheet	
	Video action prints	
	Print range	Select beginning of range: Select end of range:
	Print index page	
	Print new	
Edit	Remove red eye	
	Photo brightness	Photo brightness:

## Printer menu structure (continued)

Top level menu	Submenus/options	Additional submenus/options
		(Press <b>Navigation</b> ► or ◀ to increase or decrease the photo brightness.)
	<b>Add frame</b>	Select pattern: Select color:
	<b>Add color effect</b>	Choose color effect: <ul style="list-style-type: none"> <li>• Black and white</li> <li>• Sepia</li> <li>• Antique</li> <li>• No effect (default)</li> </ul> The color effect does not affect frames created with the <b>Add frame</b> option.
<b>Tools</b>	<b>View 9-up</b>	
	<b>Slide show</b>	Press <b>OK</b> to pause and unpause the slide show; press <b>Cancel</b> to stop the slide show.
	<b>Print quality</b>	Print quality: <ul style="list-style-type: none"> <li>• Best (default)</li> <li>• Normal</li> </ul>
	<b>Print sample page</b>	
	<b>Print test page</b>	
	<b>Clean cartridges</b>	Continue to second level cleaning? <ul style="list-style-type: none"> <li>• Yes</li> <li>• No</li> </ul> Continue to third level cleaning? <ul style="list-style-type: none"> <li>• Yes</li> <li>• No</li> </ul>
	<b>Align cartridge</b>	
<b>Bluetooth</b>	<b>Device address</b>	Device address: (Some devices with Bluetooth wireless technology require you to enter the address of the device they are trying to locate. This menu option shows the device address.)

Printer menu structure (continued)

Top level menu	Submenus/options	Additional submenus/options
	Device name	<p>Device name:</p> <p>(You can select a device name for the printer that appears on other devices with Bluetooth wireless technology when they locate the printer.)</p>
	Passkey	<p>(Press <b>Navigation</b> ▲ to increase number by one; press <b>Navigation</b> ▼ to decrease the number. Press <b>OK</b> to move to next number.)</p> <p>(You can assign a Bluetooth numerical passkey to the printer that users of devices with Bluetooth wireless technology trying to locate the printer must enter before they can print, if the printer Bluetooth <b>Security level</b> is set to <b>High</b>. The default passkey is 0000.)</p>
	Accessibility	<p>Accessibility:</p> <ul style="list-style-type: none"> <li>• Visible to all</li> <li>• Not visible</li> </ul> <p>When <b>Accessibility</b> is set to <b>Not visible</b>, only devices that know the device address can print to it.</p> <p>(You can set the Bluetooth-equipped printer to be visible or invisible to other devices with Bluetooth wireless technology by changing this accessibility option.)</p>
	Security level	<p>Security Level:</p> <ul style="list-style-type: none"> <li>• High (The printer does require users of other devices with Bluetooth wireless technology to enter the printer passkey)</li> <li>• Low (The printer does not require users of other</li> </ul>

## Printer menu structure (continued)

Top level menu	Submenus/options	Additional submenus/options
		devices with Bluetooth wireless technology to enter the printer passkey)
	Reset Bluetooth options	Reset Bluetooth options: <ul style="list-style-type: none"> <li>• Yes</li> <li>• No</li> </ul>
Help	Cartridges	Print Cartridge Help: (Press <b>Navigation</b> ▲ or ▼ to scroll through the HP print cartridges available for the printer, then press <b>OK</b> to see how to insert the cartridge)
	Photo sizes	Photo Sizes Help: (Press <b>Navigation</b> ▲ or ▼ to scroll through the available photo sizes)
	Paper loading	Paper Loading Help: (Press <b>Navigation</b> ▲ or ▼ to scroll through information on loading paper)
	Paper jams	Paper Jam Help: (Select to see how to remove a paper jam)
	Camera connect	Camera Connect Help: (Select to see where to connect a PictBridge compatible digital camera to the printer)
Preferences	SmartFocus	Turn SmartFocus: <ul style="list-style-type: none"> <li>• On (default)</li> <li>• Off</li> </ul>
	Digital Flash	Turn Digital Flash: <ul style="list-style-type: none"> <li>• On</li> <li>• Off (default)</li> </ul>
	Date/time	Date/time stamp: <ul style="list-style-type: none"> <li>• Date/time</li> <li>• Date only</li> <li>• Off (default)</li> </ul>

Printer menu structure (continued)

Top level menu	Submenus/options	Additional submenus/options
	<p><b>Colorspace</b></p>	<p>Choose colorspace:</p> <ul style="list-style-type: none"> <li>• sRGB</li> <li>• Adobe RGB</li> <li>• Auto-select (default)</li> </ul> <p>The Auto-select default tells the printer to use the Adobe RGB colorspace, if available. The printer defaults to sRGB if Adobe RGB is not available.</p>
	<p><b>Passport photo mode</b></p>	<p>Turn passport photo mode:</p> <ul style="list-style-type: none"> <li>• On</li> <li>• Off (default)</li> </ul> <p>Select Size:</p> <p>If you select <b>On</b>, the printer prompts you to select the passport photo size. Passport mode tells the printer to print all photos in the selected size. Each page contains one photo. However, if you specify several copies of the same photo, they all appear on the same page (if enough space is available).</p> <p>You must let photos printed in passport photo mode dry overnight before they are laminated.</p>
	<p><b>Tray select</b></p>	<p>Select which paper tray to use:</p> <ul style="list-style-type: none"> <li>• Front (default when rear tray <b>not</b> installed)</li> <li>• Rear</li> <li>• Ask each time (default when rear tray is installed)</li> </ul>
	<p><b>Paper detect</b></p>	<p>Auto paper detect:</p> <ul style="list-style-type: none"> <li>• On (default)</li> <li>• Off</li> </ul>
	<p><b>Preview animation</b></p>	<p>Turn preview animation:</p> <ul style="list-style-type: none"> <li>• On (default)</li> <li>• Off</li> </ul>

## Printer menu structure (continued)

Top level menu	Submenus/options	Additional submenus/options
	Video enhancement	Turn video print enhancement: <ul style="list-style-type: none"> <li>• On</li> <li>• Off (default)</li> </ul>
	Restore defaults	Restore original factory preferences: <ul style="list-style-type: none"> <li>• Yes</li> <li>• No</li> </ul> Restores factory settings for all menu items except <b>Select language</b> and <b>Select country/region</b> (under <b>Language</b> in <b>Preferences</b> menu) and Bluetooth settings (under <b>Bluetooth</b> in the main printer menu).
	Language	Select language: Select country/region:

# Paper information

You can print on photo paper, plain paper, or small media such as index cards and envelopes.

## Load paper

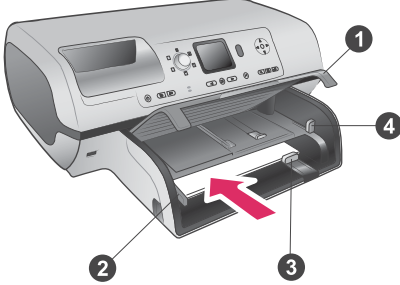
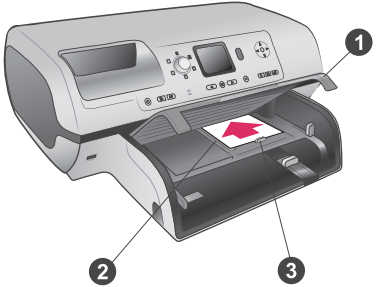
Paper type	How to load	Tray to load								
<ul style="list-style-type: none"> <li>• Letter or A4 paper</li> <li>• Transparencies</li> <li>• 20 x 25 cm (8 x 10 inch) photo paper</li> </ul>	<ol style="list-style-type: none"> <li>1 Raise the Out tray.</li> <li>2 Load plain paper, photo paper, or transparencies print-side down. Check that the stack of paper is no higher than the top of the paper-length guide.</li> <li>3 Pull the Photo tray slider towards you until it stops. The Main light illuminates, meaning that paper from the Main tray will be used for the next print job.</li> <li>4 Lower the Out tray.</li> </ol>	<p><b>Main tray</b></p>  <table border="1" data-bbox="661 720 900 859"> <tr><td>1</td><td>Out tray</td></tr> <tr><td>2</td><td>Paper-width guide</td></tr> <tr><td>3</td><td>Paper-length guide</td></tr> <tr><td>4</td><td>Photo tray slider</td></tr> </table>	1	Out tray	2	Paper-width guide	3	Paper-length guide	4	Photo tray slider
1	Out tray									
2	Paper-width guide									
3	Paper-length guide									
4	Photo tray slider									
<ul style="list-style-type: none"> <li>• 10 x 15 cm (4 x 6 inch) photo paper</li> <li>• Index cards</li> <li>• Hagaki cards</li> <li>• L-size cards</li> </ul>	<ol style="list-style-type: none"> <li>1 Raise the Out tray.</li> <li>2 Load paper print-side down. If you are using tabbed paper, insert the paper so the tab feeds in last.</li> <li>3 Lower the Out tray.</li> <li>4 Push the Photo tray slider away from you until it stops. The Photo light illuminates, meaning that paper from the Photo tray will be used for the next print job.</li> </ol>	<p><b>Photo tray</b></p>  <table border="1" data-bbox="661 1275 900 1380"> <tr><td>1</td><td>Out tray</td></tr> <tr><td>2</td><td>Paper-width guide</td></tr> <tr><td>3</td><td>Paper-length guide</td></tr> </table>	1	Out tray	2	Paper-width guide	3	Paper-length guide		
1	Out tray									
2	Paper-width guide									
3	Paper-length guide									

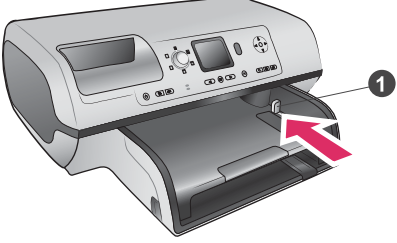
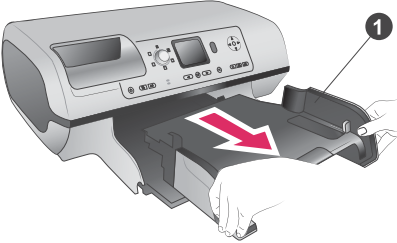
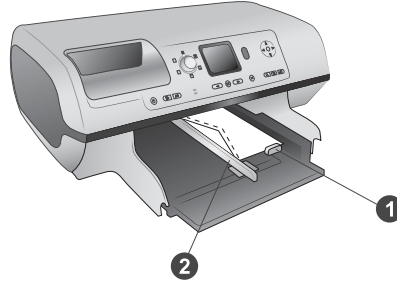
Paper type	How to load	Tray to load
		 <p data-bbox="681 435 887 461">1 Photo tray slider</p>
<ul style="list-style-type: none"> <li>• 13 x 18 cm (5 x 7 inch) photo paper</li> <li>• Envelopes</li> </ul>	<ol style="list-style-type: none"> <li>1 Remove the Out tray by pushing in the buttons on each side and pulling the tray towards you.</li> <li>2 Load photo paper print-side down. Load envelopes with the front-side down and with the flap on the left. Tuck the flaps inside the envelopes to avoid paper jams.</li> <li>3 Replace the Out tray.</li> <li>4 Pull the Photo tray slider towards you until it stops. The Main light illuminates, meaning that paper from the Main tray will be used for the next print job.</li> </ol>	<p data-bbox="681 482 854 508"><b>Main input tray</b></p>  <p data-bbox="681 812 807 838">1 Out tray</p>  <p data-bbox="681 1194 908 1220">1 Paper-length guide</p> <p data-bbox="681 1229 902 1255">2 Paper-width guide</p>

## Print cartridge information

The HP Photosmart 8100 series printer can print color and black-and-white photos. HP provides different types of print cartridges so you can choose the best cartridges for your project. The cartridge numbers you can use in this printer also appear on the back cover.

For optimum printing results, HP recommends using only HP print cartridges. Inserting a cartridge that is not in this table may invalidate the printer warranty.



## Use the correct print cartridges

To print...	Insert this print cartridge in the left stall	Insert this print cartridge in the right stall
Full-color photos	HP Tri-color #343 or #344	HP Photo #348
Black-and-white photos	HP Tri-color #343 or #344	HP Gray Photo #100
Sepia or antique photos	HP Tri-color #343 or #344	HP Photo #348
Text and colored line drawings	HP Tri-color #343 or #344	HP Black #339



**Caution** Check that you are using the correct print cartridge. Also, note that HP does not recommend modifying or refilling HP cartridges. Damage that results from modifying or refilling HP cartridges is not covered by the HP warranty.

For best print quality, HP recommends that you install all retail print cartridges before the date stamped on the box.

## Insert or replace the print cartridges



**Remove the pink tape**



**Do not touch here**

### Prepare the printer and cartridges

- 1 Make sure the power is on and you have removed the cardboard from inside the printer.
- 2 Lift the main cover of the printer.
- 3 Remove the bright pink tape from **both** cartridges.

Do not touch the ink nozzles or the copper-colored contacts, and do not re-tape the cartridges.

## Insert or replace the print cartridges (continued)

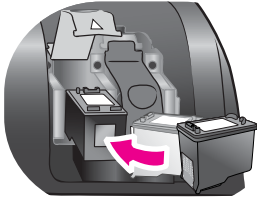
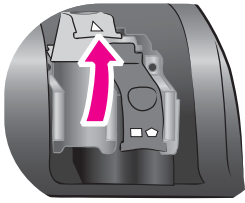
**Insert the cartridges**

- 1 If you are replacing a cartridge, push down and pull outward on the cartridge stall cover to open it and then pull the cartridge out.
- 2 Match the symbol on the cartridge label to the correct stall. Hold the cartridge with the label on top and slide it at a slight upward angle into the stall so the copper-colored contacts go in first. Push the cartridge until it snaps into place.
- 3 Close the cartridge stall cover.
- 4 Repeat the previous steps to install the second cartridge, if necessary.
- 5 When you are finished installing cartridges, close the main cover.

You must install both cartridges in order for the printer to work as intended.

**Tip** Ink-backup printing mode lets you keep printing even if one of the cartridges fails or runs out of ink. Remove the cartridge and close the main cover to enter ink-backup printing mode. The printer continues to print, but at a slower speed and with inferior print quality. A message reminds you that the printer is in ink-backup printing mode. Replace the cartridge as soon as possible.

The idle screen of the printer displays two icons showing the approximate ink level for each cartridge (100%, 75%, 50%, 25%, and nearly empty). Ink-level icons do not appear if one or both installed cartridges are not genuine HP cartridges.

Each time you install or replace a print cartridge, a message prompts you to print an alignment page. This ensures high-quality prints.

**Align the cartridges**

- 1 Load paper in the In tray.
- 2 Follow the onscreen instructions to complete the cartridge alignment.

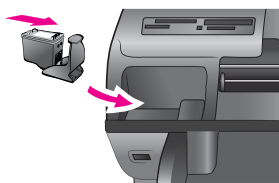
**When you are not using a print cartridge**

Whenever you remove a print cartridge from the printer, store it in a print cartridge protector, if available. The cartridge protector keeps the ink from drying out. Storing the cartridge

improperly can cause the cartridge to malfunction.

- To insert a cartridge into the cartridge protector, slide the cartridge into the protector at a slight angle and snap it securely into place.

Once you have inserted a cartridge into the cartridge protector, place it in the storage area located in the printer under the top cover.

---



# 2 Printing with your new printer

It's easy to print high-quality photos for yourself, family, and friends. This section provides you with a quick start to printing, as well as detailed instructions on using memory cards, selecting photos, and more.

## Quick start

Printing photos is as easy as 1–2–3! Here's how you do it.

### Step 1: Getting ready to print



Inserting a print cartridge

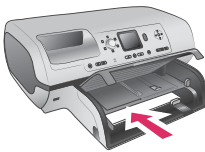

Loading paper

- 1 Install the print cartridges.  
See [Print cartridge information](#).
  - a Unpack a print cartridge and remove the tape. Do not touch the copper-colored contacts or ink nozzles.
  - b Open the top of the printer.
  - c Match the symbol on the cartridge label to the correct stall. Hold the cartridge with the label on top and slide it at a slight upward angle into the stall so the copper-colored contacts go in first. Push the cartridge until it snaps into place.
  - d Repeat for each print cartridge you need to install.
- 2 Load photo paper  
See [Paper information](#).
  - a Open the In tray on the back of the printer.
  - b Load several sheets of photo paper into the In tray.
  - c Adjust the paper width guide to fit.

### Step 2: Selecting photos



Inserting a memory card

- 1 Insert a memory card that has photos on it.  
**Caution** Inserting a memory card incorrectly can damage the card and the printer. For more information on memory cards, see [Inserting memory cards](#).
- 2 Press **Select Photos** ◀ or ▶ to scroll through the photos on the card.
- 3 Press **Select Photos** ☑ to select a photo that you want to print. A check mark appears in the left corner of the photo on the printer screen.  
For more information about selecting photos, see [Selecting photos](#).

(continued)

**Step 2: Selecting photos****Selecting a photo****Step 3: Printing****Printing photos**→ Press **Print** to print the selected photos.**Printing without a computer**

The HP Photosmart 8100 series printer lets you print amazing photos without even going near a computer.

**Using memory cards**

After you have taken pictures with a digital camera, you can remove the memory card from the camera and insert it into the printer to view and print your photos. The printer can read the following types of memory cards: CompactFlash™, Memory Sticks, Microdrive™, MultiMediaCard™, Secure Digital™, SmartMedia™, and xD-Picture Card™.



**Caution** Using any other type of memory card may damage the memory card and the printer.

To learn about other ways of transferring photos from a digital camera to the printer, see [Getting connected](#).

**Supported file formats**

The printer can recognize and print the following file formats directly from the memory card: JPEG, uncompressed TIFF, AVI (JPEG compression), QuickTime (JPEG compression), and MPEG-1. If a digital camera saves photos and video clips in other file formats, save the files to a computer and print them using a software application. For more information, see the onscreen HP Photosmart Printer Help.

**Inserting memory cards**

After you take pictures with a digital camera, remove the memory card from the camera and insert it into the printer.



**Caution** Do not pull out a memory card while the Memory Card light is flashing. A flashing light means that the printer is accessing the memory card. Removing a memory card while it is being accessed may damage the printer and the memory card or corrupt the information on the memory card.

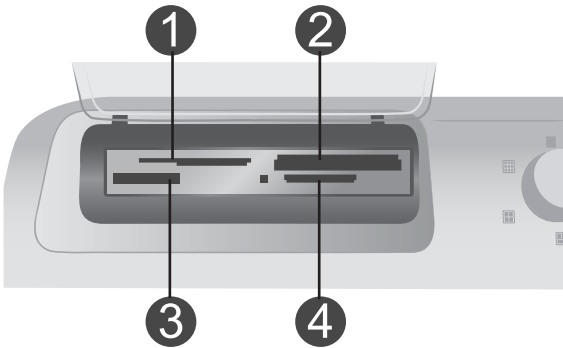

1	SmartMedia, xD-Picture Card
2	Memory Sticks
3	CompactFlash, Microdrive
4	MultiMediaCard, Secure Digital

### To insert a memory card

- 1 Remove any memory cards that are already inserted into any of the memory card slots. You can have only one card inserted at a time.
- 2 Find the correct slot for your memory card.
- 3 Insert the memory card into the slot with the copper-colored contacts down or the metal pinholes facing toward the printer.
- 4 Gently push the memory card into the printer until it stops.

The printer reads the memory card and then displays the first photo on the card. If you used your digital camera to select photos on the card, the printer asks you if you want to print the camera-selected photos.

## Selecting photos

You can select one or more photos to print using the printer control panel.

### Select a photo

- 1 Insert a memory card.
- 2 Press **Select Photos** ◀ or ▶ to navigate to the photo you want to print.

**Tip** To move quickly through the photos, press and hold **Select Photos** ◀ or ▶.

- 3 Press **Select Photos** ☑ to select the photo currently on the printer screen. A check mark appears on the bottom left corner of the printer screen to indicate that the photo is selected for printing. Press **Select Photos** ☑ repeatedly to print more than one copy of the photo. A number indicating how many copies are to be

printed appears next to the check mark. Press **Cancel** to decrease the number of copies by one.

- 4 To select additional photos, repeat these steps.

### Deselect a photo

- 1 Press **Select Photos** ◀ or ▶ to navigate to the photo you want to deselect.
- 2 Press **Cancel**.

Deselecting photos does not delete them from the memory card.

## Printing selected photos

You can print photos from a memory card or directly from a PictBridge or HP direct-printing digital camera. You can print selected photos, all photos, photos selected on a proof sheet, or a range of photos. For instructions, see the *User's Guide* available in online format on the *User's Guide* CD.

## Enhancing photos

The printer provides a variety of tools and effects that let you enhance your photos or use them in creative ways. You can add color effects, remove red eye, and add a decorative frame. The settings do not change your original photo. They only affect printing. For instructions, see the *User's Guide* available in online format on the *User's Guide* CD.

## Changing printer preferences

Change the printer default settings to your own personal preferences by using the printer menu on the printer control panel. Printer preferences are global settings. They apply to every photo you print. For a complete list of available preferences and their default settings, see **Printer menu**. For instructions on changing printer preferences, see the *User's Guide* available in online format on the *User's Guide* CD.

## Getting connected

Use the printer to stay connected to other devices and people.

### Connecting to other devices

This printer offers several ways of connecting to computers or other devices. Each connection type lets you do different things.

Connection type and what you need	What this lets you do
<b>USB</b> <ul style="list-style-type: none"> <li>• A Universal Serial Bus (USB) 1.1 or 2.0 full-speed compliant cable 3 meters (10 feet) or less in length. For instructions about connecting</li> </ul>	<ul style="list-style-type: none"> <li>• Print from a computer to the printer. See <b>Printing with a computer</b>.</li> <li>• Save photos from a memory card inserted in the printer to a computer where you can enhance or organize them in the HP Image Zone software.</li> </ul>



(continued)

Connection type and what you need	What this lets you do
<p>the printer with a USB cable, see the <i>Start Here</i> Booklet.</p> <ul style="list-style-type: none"><li>• A computer with Internet access (to use HP Instant Share).</li></ul>	<ul style="list-style-type: none"><li>• Share photos through HP Instant Share.</li><li>• Print directly from an HP Photosmart direct-printing digital camera to the printer. For more information, see <a href="#">Printing without a computer and the camera documentation</a>.</li></ul>
<p><b>PictBridge</b> A PictBridge-compatible digital camera and a USB cable. Connect the camera to the camera port on the front of the printer.</p>	<p>Print directly from a PictBridge-compatible digital camera to the printer. For more information, see <a href="#">Printing without a computer</a> and the camera documentation.</p>
<p><b>Bluetooth</b> The optional HP Bluetooth wireless printer adapter. If the printer came with this accessory or you have purchased it separately, see the accompanying documentation and the onscreen Help for instructions.</p>	<p>Print from any device with Bluetooth wireless technology to the printer. If you connect the optional HP Bluetooth wireless printer adapter to the printer through the camera port, be sure to set the Bluetooth printer menu options as needed. See <a href="#">Printer menu</a>. The adapter is not compatible with the Macintosh OS.</p>

## Connecting through HP Instant Share

Use HP Instant Share to share photos with friends and relatives using e-mail, online albums, or an online photo finishing service. The printer must be connected through a USB cable to a computer with Internet access and have all the HP software installed. If you try to use HP Instant Share and do not have all the required software installed or configured, a message prompts you through the required steps.

### To use HP Instant Share

- 1 Insert a memory card and select some photos.
- 2 Press **HP Instant Share**.
- 3 Follow the instructions on the computer to share the selected photos with others.



See the onscreen HP Image Zone Help for information about using HP Instant Share.

## Printing with a computer

All HP photo printers come with the HP Image Zone software, which helps you do more with your photos than ever before. Use it to get creative with your pictures: edit them, share them, and create fun projects such as greeting cards. The HP Image Zone is only installed if you choose the **Typical** installation option. See [Installing the software](#).

Software feature	Where to find information
<p><b>Take control of printing</b></p> <p>Harness the power of the HP Photosmart printer driver. This software gives you full control over how your photos print. You can:</p> <ul style="list-style-type: none"> <li>• Produce draft-quality prints to save on ink and photo media</li> <li>• Learn how to get the most out of the printer and your digital photos</li> <li>• Use advanced color settings to produce the highest-quality prints</li> </ul>	<p><b>Windows:</b> In the onscreen Help, click <b>HP Photosmart Printer Help</b>. In the print dialog box itself, right-click any option and click the <b>What's This?</b> box to learn more about that option.</p> <p><b>Macintosh:</b> Select <b>Help &gt; Mac Help</b> in the Finder, then select <b>Library &gt; HP Photosmart Printer Help for Macintosh</b>.</p>
<p><b>HP Instant Share</b></p>  <p>Use HP Instant Share to share photos with family and friends. HP Instant Share lets you easily:</p> <ul style="list-style-type: none"> <li>• E-mail images using HP Instant Share without large file attachments</li> <li>• Create online albums to share, organize, and store photos</li> <li>• Order professionally processed prints online (availability varies by country/region)</li> </ul>	<p>For more information about using HP Instant Share with your specific printer model, see <a href="#">Connecting through HP Instant Share</a>.</p> <p><b>Windows:</b> In the onscreen Help, click <b>Use the HP Image Zone</b>, then click <b>Share your images using HP Instant Share</b>.</p> <p>To use HP Instant Share on Windows, start HP Image Zone, select one or more photos, then click the <b>HP Instant Share</b> tab.</p> <p><b>Macintosh:</b> Start HP Instant Share, then follow the onscreen instructions.</p> <p>To use HP Instant Share on a Macintosh, press and hold on <b>HP Photosmart Menu</b> in the Dock, then select <b>HP Instant Share</b> from the pop-up menu.</p>
<p><b>Creative projects</b></p>	<p><b>Windows:</b> In the onscreen Help, click <b>Use the HP Image Zone</b>, then click <b>Create projects</b>.</p> <p>To do creative projects on Windows, start HP Image Zone, select one or more photos, then click the <b>Projects</b> tab.</p>

(continued)

Software feature	Where to find information
 <p>Think outside the photo album. The HP Image Zone lets you use your digital photos for creative projects such as:</p> <ul style="list-style-type: none"><li>• Iron-on transfers</li><li>• Banners</li><li>• Greeting cards</li></ul>	<p><b>Macintosh:</b> To do creative projects on a Macintosh, press and hold on the active <b>HP Photosmart Menu</b> in the Dock, then select <b>HP Image Print</b> from the pop-up menu. Select a creative printing option from the <b>Print Style</b> drop down menu. Onscreen instructions appear in the <b>HP Image Print</b> window.</p>
 <p><b>Organize your photos</b></p> <p>The HP Image Zone helps you keep on top of your digital photos and video clips by letting you:</p> <ul style="list-style-type: none"><li>• Organize your photos in albums</li><li>• Search through your photos by date, keywords, and more</li><li>• Index images automatically</li></ul>	<p>In the onscreen Help, click <b>Use the HP Image Zone</b>, then click <b>Manage your images</b>.</p> <p>To organize your photos on Windows, start HP Image Zone, then click the <b>My Images</b> tab.</p> <p><b>Macintosh:</b> This feature is not available on the Macintosh.</p>
 <p><b>Edit and enhance your photos</b></p> <p>The HP Image Zone lets you:</p> <ul style="list-style-type: none"><li>• Do manual color correction and make other adjustments to improve your photos before you print them</li><li>• Add text and other graphics</li><li>• Resize your digital photos</li></ul>	<p><b>Windows:</b> In the onscreen Help, click <b>Use the HP Image Zone</b>, then click <b>Edit your images</b>.</p> <p>To edit photos on Windows, start HP Image Zone, select one or more photos, then click the <b>Edit</b> tab.</p> <p><b>Macintosh:</b> To edit photos on a Macintosh, press and hold on the active <b>HP Photosmart Menu</b> in the Dock, then select <b>HP Image Edit</b> from the pop-up menu.</p>



# 3 Installing the software

## Installing the software

The printer comes with optional software you can install on a computer.

After using the *Setup Guide* instructions to setup the printer hardware, use the instructions in this section to install the software.

Windows users	Macintosh users
<p><b>Important:</b> Do not connect the USB cable until you are prompted.</p> <p>HP Image Zone software and full printer functionality is installed automatically when you choose the <b>Typical installation</b> of your HP software.</p> <ol style="list-style-type: none"><li>1 Insert the HP Photosmart CD into your computer's CD-ROM drive.</li><li>2 Click <b>Next</b> and follow the onscreen instructions. If instructions do not appear, locate the <b>setup.exe</b> file on the CD-ROM drive and double-click it. Wait several minutes while the files load.</li></ol> <p><b>Note</b> If the <b>Found New Hardware</b> screen appears, click <b>Cancel</b>, unplug the USB cable, and restart the installation.</p> <ol style="list-style-type: none"><li>3 When prompted, connect one end of the USB cable to the USB port on the back of the printer, and connect the other end to the USB port on your computer.</li><li>4 Follow the onscreen instructions until the installation is finished and your computer restarts. When the Congratulations page appears, click <b>Print a demo page</b>.</li></ol>	<p><b>Important:</b> Do not connect the USB cable until you are prompted.</p> <ol style="list-style-type: none"><li>1 Insert the HP Photosmart CD into your computer's CD-ROM drive.</li><li>2 Double-click the <b>HP Photosmart CD</b> icon.</li><li>3 Double-click the <b>HP Photosmart Install</b> icon. Follow the onscreen instructions to install the printer software.</li><li>4 When prompted, connect one end of the USB cable to the USB port on the back of the printer, and connect the other end to the USB port on your computer.</li><li>5 Select the printer in the Print dialog box. If the printer does not appear in the list, click <b>Edit Printer List</b> to add the printer.</li></ol>

## Installation troubleshooting

If the printer software did not install successfully or if the printer and computer are not communicating properly after software installation, check this page for possible solutions. If you still need help, check the printer documentation or contact Customer Care. Check all cable connections between the printer and computer, and ensure you are using the most recent version of the printer software.

### **The Found New Hardware Wizard opens but doesn't recognize the printer.**

You may have connected the USB cable before completing the software installation. Disconnect the USB cable and restart the software installation. Connect the USB cable when prompted during software installation.

### **The computer stops responding during software installation.**

This may mean that virus protection software or another software program is running in the background and slowing down the installation process. Wait while the software finishes copying files; this may take several minutes. If, after several minutes, the computer is still not responding, restart the computer, pause or disable any active virus protection software, quit all other software programs, and then reinstall the printer software.

**Note** Your virus protection software will turn back on automatically when you restart the computer.

### **The System Requirements dialog box appears during installation.**

A component of the computer system does not meet minimum system requirements. Upgrade the component to the minimum system requirement and then reinstall the printer software.

### **The System Requirements check indicates that the computer is running an outdated version of Internet Explorer.**

Press Ctrl+Shift on the keyboard and click **Cancel** in the System Requirements dialog box to bypass the block and complete the software installation. You must update Internet Explorer immediately after installing the HP Photosmart software, or the HP software will not work properly.

**Note** You do not have to reinstall the HP software after updating Internet Explorer.

### **The computer could not read the HP Photosmart CD.**

Make sure the CD isn't dirty or scratched. If other CDs work but the HP Photosmart CD does not, you may have a damaged CD. You can download the printer software from [www.hp.com/support](http://www.hp.com/support). If other CDs don't work, you may need to service the CD-ROM drive.

# 4 Support and warranty

This section contains information about technical support and the printer warranty.

## Customer Care

If you have a problem, follow these steps:

- 1 Check the documentation that came with the printer.
  - **Start Here booklet:** The *HP Photosmart 8100 series Start Here* booklet explains how to set up the printer and print your first photo.
  - **User's Guide:** The *User's Guide* describes the basic features of the printer, explains how to use the printer without connecting a computer, and contains hardware troubleshooting information. It is available in online format on the *User's Guide* CD.
  - **HP Photosmart Printer Help:** The onscreen HP Photosmart Printer Help describes how to use the printer with a computer and contains software troubleshooting information.
  - **Reference Guide:** The *HP Photosmart 8100 series Reference Guide* is the book you are reading. It provides basic information about the printer, including setup, operation, technical support, and warranty. For detailed instructions, see the *User's Guide* CD.
  - **HP Photosmart Printer Help:** The onscreen HP Photosmart Printer Help describes how to use the printer with a computer and contains software troubleshooting information. See *Installing the software*.
- 2 If you are unable to solve the problem using the information in the documentation, visit [www.hp.com/support](http://www.hp.com/support) to do the following:
  - Access online support pages
  - Send HP an e-mail message for answers to your questions
  - Connect with an HP technician by using online chat
  - Check for software updatesSupport options and availability vary by product, country/region, and language.
- 3 **For Europe only:** Contact your local point of purchase. If the printer has a hardware failure, you will be asked to bring the printer to where you purchased it. Service is free during the printer limited warranty period. After the warranty period, you will be quoted a service charge.
- 4 If you are unable to solve the problem using the onscreen Help or HP websites, call Customer Care using the number for your country/region. For a list of country/region phone numbers, see the following section.

### Customer Care by phone

While the printer is under warranty, you can obtain free phone support. For more information, see *Limited warranty statement*, or go to [www.hp.com/support](http://www.hp.com/support) to check the duration of your free support.

After the free phone support period, you can obtain help from HP at an additional cost. Contact your HP dealer or call the support phone number for your country/region for support options.

To receive HP support by phone, call the appropriate support phone number for your location. Standard phone company charges apply.

**Western Europe:** Customers in Western Europe should go to [www.hp.com/support](http://www.hp.com/support) to access phone support numbers in their country/region.



61 56 45 43	الجزائر
Argentina Argentina	(54) 11-4778-8380 0-810-555-5520
Australia	13 10 47
800 171	البحرين
Brasil (dentro da grande São Paulo) Brasil (fora da grande São Paulo)	(11) 3747-7799 0800-15775 1
Canada	(800) 474-6836
Caribbean	1-800-711-2884
Central America	1-800-711-2884
Chile	800-360-999
中国	(8621) 38814518
Columbia	01-800-011-4726
Costa Rica	0-800-011-4114 + 1-800-711-2884
Česká republika	261 307 310
Ecuador (Andinatel)	1-800-711-2884
Ecuador (Pacifitel)	1-800-225528
2 532 5222	مصر
Greece (international) Greece (in-country) Greece (Cyprus)	+ 30 210 6073603 801 11 22 55 47 800 9 2649
Guatemala	1-800-999-5105
香港特別行政區	852-2802 4098
Magyarország	1 382 1111
India	1 600 44 7737
Indonesia	62 (21) 350 3408
(0) 9 830 4848	ישראל
Jamaica	0-800-7112884
日本	0570-000511
日本 (携帯電話の場合)	+81-3-3335-9800

한국	1588-3003
Malaysia	1800-80-5405
México (Ciudad de México) México (fuera de Ciudad de México)	(55)5258-9922 01-800-4726684
22 404747	المغرب
New Zealand	0800 441 147
Nigeria	1 3204 999
Panama	001-800-7112884
Perú	0-800-10111
Philippines	63 (2) 867-3551
Polska	22 5666 000
Puerto Rico	1-877-232-0589
Republica Dominicana	1-800-7112884
România	(21) 315 4442
Russia (Moscow) Russia (St. Petersburg)	095 7973520 812 3467997
800 897 1444	السعودية
Singapore	65 6272 5300
Slovakia	2 50222444
South Africa (Intl.) South Africa (RSA)	+ 27 11 2589301 086 0001030
Rest Of West Africa	+ 351 213 17 63 80
臺灣	(02) 8722-8000
Thailand	66 (2) 353 9000
71 89 12 22	تونس
Trinidad & Tobago	1-800-7112884
Türkiye	(212) 444 7171
Ukraine	(380 44) 4903520
800 4520	الإمارات العربية المتحدة
United States	(800) 474-6836
Venezuela	01-800-4746.8368
Việt Nam	84 (8) 823 4530
For Bangladesh, Brunei, Cambodia, Pakistan, and Sri Lanka	Fax to: +65-6275-6707

### Placing a call

Call Customer Care while you are near the computer and printer. Be prepared to provide the following information:

- Printer model number (located on the front of the printer).
- Printer serial number (located on the bottom of the printer).
- Computer operating system.
- Version of printer driver:
  - **Windows PC:** To see the printer driver version, right-click the HP icon in the Windows taskbar and select **About**.
  - **Macintosh:** To see the printer driver version, use the Print dialog box.



- Messages displayed on the printer screen or on the computer monitor.
- Answers to the following questions:
  - Has the situation you are calling about happened before? Can you recreate the situation?
  - Did you install any new hardware or software on your computer around the time that the situation occurred?

## Limited warranty statement

The limited warranty statement is included separately in the box.



# 5 Specifications

This section lists the minimum system requirements for installing the HP Photosmart printer software, and provides selected printer specifications.

For a complete list of printer specifications and system requirements, see the onscreen Help. For information about viewing the onscreen Help, see [Find more information](#).

## System requirements

Component	Windows PC minimum	Macintosh minimum
<b>Operating system</b>	Microsoft® Windows 98, 2000 Professional, ME, XP Home, and XP Professional	Mac® OS X 10.1 through 10.3
<b>Processor</b>	Intel® Pentium® II (or equivalent) or higher	G3 or greater
<b>RAM</b>	64 MB (128 MB recommended)	Mac OS 10.1 through 10.3: 128 MB
<b>Free disk space</b>	500 MB	500 MB
<b>Video display</b>	800 x 600, 16-bit or higher	800 x 600, 16-bit or higher
<b>CD-ROM drive</b>	4x	4x
<b>Connectivity</b>	<b>USB:</b> Microsoft Windows 98, 2000 Professional, ME, XP Home, and XP Professional <b>PictBridge:</b> using front camera port <b>Bluetooth:</b> using optional HP Bluetooth Wireless Adapter	<b>USB:</b> Front and back ports (OS X 10.1 through 10.3) <b>PictBridge:</b> using front camera port
<b>Browser</b>	Microsoft Internet Explorer 5.5 or later	—

## Printer specifications

Category	Specifications
<b>Connectivity</b>	USB: Microsoft Windows 98, 2000 Professional, ME, XP Home, and XP Professional; Mac OS X 10.1 through 10.3
<b>Image file formats</b>	JPEG Baseline TIFF 24-bit RGB uncompressed interleaved TIFF 24-bit YCbCr uncompressed interleaved TIFF 24-bit RGB packbits interleaved TIFF 8-bit gray uncompressed/packbits

(continued)

Category	Specifications
	TIFF 8-bit palette color uncompressed/packbits TIFF 1-bit uncompressed/packbits/1D Huffman
<b>Media sizes</b>	Photo paper 10 x 15 cm (4 x 6 inches) Photo paper with tab 10 x 15 cm with 1.25 cm tab (4 x 6 inches with 0.5 inch tab) Index cards 10 x 15 cm (4 x 6 inches) Hagaki cards 100 x 148 mm (3.9 x 5.8 inches) A6 cards 105 x 148 mm (4.1 x 5.8 inches) L-size cards 90 x 127 mm (3.5 x 5 inches) L-size cards with tab 90 x 127 mm with 12.5 mm tab (3.5 x 5 inches with 0.5 inch tab)
<b>Media specifications</b>	Recommended maximum length: 356 mm (14 inches) Recommended maximum thickness: 292 µm (11.5 mil)
<b>Media sizes, standard</b>	<p><b>Photo paper</b></p> 76 x 76 mm to 216 x 356 mm (3 x 3 inches to 8.5 x 14 inches) <p><b>Plain paper</b></p> Letter, 216 x 280 mm (8.5 x 11 inches) Legal, 216 x 356 mm (8.5 x 14 inches) Executive, 190 x 254 mm (7.5 x 10 inches) A4, 210 x 297 mm (8.27 x 11.7 inches) A5, 148 x 210 mm (5.8 x 8.3 inches) B5, 176 x 250 mm (6.9 x 9.8 inches) <p><b>Cards</b></p> Hagaki, 100 x 148 mm (3.94 x 5.83 inches) L-size, 90 x 127 mm (3.5 x 5 inches) L-size with tab, 90 x 127 mm with 12.5 mm tab (3.5 x 5 inches with 0.5 inch tab) Index, 76 x 127 mm, 10 x 15 cm, and 127 x 203 mm (3 x 5 inches, 4 x 6 inches, and 5 x 8 inches) A6, 105 x 148.5 mm (4.13 x 5.85 inches) <p><b>Envelopes</b></p> No. 9, 98.4 x 225.4 mm (3.875 x 8.875 inches) No. 10, 105 x 240 mm (4.125 x 9.5 inches) A2 Invitation, 110 x 146 mm (4.375 x 5.75 inches) DL, 110 x 220 mm (4.33 x 8.66 inches) C6, 114 x 162 mm (4.5 x 6.4 inches) <p><b>Custom</b></p> 76 x 127 mm to 216 x 356 mm (3 x 5 inches to 8.5 x 14 inches) <p><b>Transparencies and label sheets</b></p>

(continued)

Category	Specifications
	Letter, 216 x 280 mm (8.5 x 11 inches) A4, 210 x 297 mm (8.27 x 11.7 inches)
<b>Media types</b>	Paper (plain, inkjet, photo, and banner) Envelopes Transparencies Labels Cards (index, greeting, Hagaki, A6, L-size) Iron-on transfers
<b>Memory cards</b>	CompactFlash Type I and II Microdrive MultiMediaCard Secure Digital SmartMedia Memory Sticks xD-Picture Card
<b>Memory card-supported file formats</b>	Printing: See list earlier in this table Saving: All file formats
<b>Paper trays</b>	<b>Main tray</b> 76 x 127 mm to 216 x 356 mm (3 x 5 inches to 8.5 x 14 inches) <b>Photo tray</b> 10 x 15 cm (4 x 6 inch) and Hagaki <b>Out tray</b> All supported sizes
<b>Paper tray capacity</b>	<b>Main tray</b> 100 sheets of plain paper 14 envelopes 20–40 cards (depending on thickness) 20 sheets of banner paper 30 sheets of labels 25 transparencies, iron-on transfers, or photo paper <b>Photo tray</b> 25 sheets of photo paper <b>Out tray</b> 50 sheets of plain paper 20 sheets of photo paper, banner paper, or transparencies 10 cards or envelopes 25 sheets of labels or iron-on transfers
<b>Power consumption</b>	Printing: 15–45 W

(continued)

Category	Specifications
	Idle: 5 W Off: 2 W
<b>Print cartridges</b>	HP Gray Photo (C9368A) HP Color Photo (C9369E) HP Tri-color (C8766E or C9363E) HP Black (C8767E)
<b>USB support</b>	Microsoft Windows 98, 2000 Professional, ME, XP Home, and XP Professional OS X 10.1 through 10.3 HP recommends that the USB cable be less than 3 meters (10 feet) in length
<b>Video file formats</b>	Motion JPEG AVI Motion-JPEG QuickTime MPEG-1

## Environmental statements

Hewlett-Packard Company is committed to providing quality products in an environmentally sound manner.

### Protecting the environment

This printer has been designed with several attributes to minimize impact on our environment. For more information, go to HP's Commitment to the Environment website at [www.hp.com/hpinfo/globalcitizenship/environment/](http://www.hp.com/hpinfo/globalcitizenship/environment/).

### Ozone production

This product generates no appreciable ozone gas (O<sub>3</sub>).

### Energy consumption

Energy usage drops significantly while in ENERGY STAR® mode, which saves natural resources and saves money without affecting the high performance of this product. This product qualifies for ENERGY STAR, which is a voluntary program established to encourage the development of energy-efficient office products.



ENERGY STAR is a U.S. registered mark of the U.S. EPA. As an ENERGY STAR partner, Hewlett-Packard Company has determined that this product meets the ENERGY STAR guidelines for energy efficiency. For more information, go to [www.energystar.gov](http://www.energystar.gov).

### Paper use

This product is suited for the use of recycled paper according to DIN 19309.

### Plastics

Plastic parts over 24 grams (0.88 ounces) are marked according to international standards that enhance the ability to identify plastics for recycling purposes at the end of the printer life.

### Material safety data sheets

Material Safety Data Sheets (MSDS) can be obtained from the HP website at [www.hp.com/go/msds](http://www.hp.com/go/msds). Customers without Internet access should contact Customer Care.

## Recycling program

HP offers an increasing number of product return and recycling programs in many countries, and partners with some of the largest electronics recycling centers throughout the world.

HP conserves resources by reselling some of its most popular products.

This HP product contains lead in the solder, which may require special handling at the end of its life.





## Declaration of conformity

According to ISO/IEC Guide 22 and EN 45014

---

Manufacturer's name and address:

---

Hewlett-Packard Company, 16399 West Bernardo Drive, San Diego, CA 92127-1899, USA

---

Regulatory model number:	SDGOA-0402
--------------------------	------------

---

Declares that the product:

---

Product name:	Photosmart 8100 series (Q3399A)
Model number(s):	Photosmart 8150 (Q3399A)
Power adapters:	HP Part # Q0950-4476 (domestic) HP Part # Q0950-4476 (international)

---

Conforms to the following product specifications:

---

Safety:	IEC 60950: 3rd Edition: 1999 EN 60950:2000 UL1950/CSA22.1 No.950, 3rd Edition:1995 NOM 019-SFCI-1993 GB4943:2001
EMC:	CISPR 22: 1997 / EN 55022: 1998, Class B CISPR 24: 1997 / EN 55024: 1998 IEC 61000-3-2: 2000 / EN 61000-3-2: 2000 IEC 61000-3-3/A1: 2001 / EN 61000-3-3/A1: 2001 CNS13438: 1998, VCCI-2 FCC Part 15-Class B/ICES-003, Issue 2 GB9254: 1998

---

Supplementary Information:

The Product herewith complies with the requirements of the Low Voltage Directive 73/23/EEC and the EMC Directive 89/336/EEC and carries the CE marking accordingly.

---

European Contact for regulatory topics only: Hewlett Packard GmbH, HQ-TRE, Herrenberger Strasse 140, D-71034 Böblingen Germany. (FAX +49-7031-14-3143)

---