

Compaq Presario Desktop Products

Upgrading and Servicing Guide

COMPAQ

The information in this document is subject to change without notice.

Hewlett-Packard® Company makes no warranty of any kind with regard to this material, including, but not limited to, the implied warranties of merchantability and fitness for a particular purpose.

HP shall not be liable for errors contained herein or for incidental or consequential damages in connection with the furnishing, performance, or use of this material.

HP assumes no responsibility for the use or reliability of its software on equipment that is not furnished by HP.

This document contains proprietary information that is protected by copyright. All rights are reserved. No part of this document may be photocopied, reproduced, or translated to another language without the prior written consent of HP.

Hewlett-Packard Company
P.O. Box 4010
Cupertino, CA 95015-4010
USA

© 2003–2004 Hewlett-Packard Development Company, L.P.
All rights reserved.

Hewlett-Packard is a registered trademark of Hewlett-Packard Company in the United States of America and other countries/regions.

This product incorporates copyright protection technology that is protected by method claims of certain U.S. patents and other intellectual property rights owned by Macrovision Corporation and other rights owners. Use of this copyright protection technology must be authorised by Macrovision Corporation, and is intended for home and other limited viewing uses only unless otherwise authorised by Macrovision Corporation. Reverse engineering or disassembly is prohibited. Apparatus Claims of U.S. Patent Nos. 4,631,603, 4,577,216, 4,819,098, and 4,907,093 licensed for limited viewing uses only.

Other brand or product names are trademarks of their respective holders.

HP supports lawful use of technology and does not endorse or encourage the use of our products for purposes other than those permitted by national copyright law.

Table of Contents

Safety Information	1
Opening and Closing the PC	1
Preparing the PC	1
Before Opening the PC	1
After Closing the PC.....	2
Removing the Side Panel	2
Replacing the Side Panel	2
Removing the Front Panel.....	2
Replacing the Front Panel	3
Locating Components Inside the PC	3
Removing and Replacing Drives	3
Removing a Drive	3
Replacing or Adding a Drive.....	5
Adding Memory	6
Removing a Memory Module	6
Installing a Memory Module	7
Removing or Installing an Add-In Card	7
Removing an Add-In Card	8
Installing an Add-In Card.....	8
Replacing the Battery	9

Safety Information

This product has not been evaluated for connection to an "IT" power system (an AC distribution system with no direct connection to earth, according to IEC 60950).



WARNING: Please read "Safety Information" in the *User's Guide* before installing and connecting your system to the electrical power system.

Opening and Closing the PC

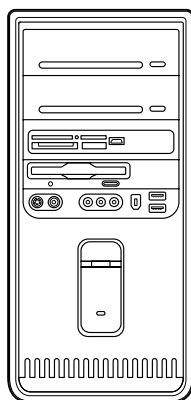

Preparing the PC

Before you upgrade any component in your PC, you need to prepare the PC so that you can safely handle it and the components.

Read the following items before attempting to upgrade or service the PC.

- These procedures assume familiarity with the general terminology associated with personal computers, and with the safety practices and regulatory compliance required for using and modifying electronic equipment.

- Write down and save the system model and serial numbers, all installed options, and other information about the system. It will be easier to consult this information than to open up and examine the PC.
- Compaq recommends that you use an antistatic wrist strap and a conductive foam pad when working on the system.



WARNING: Always disconnect the modem cord from the telephone system, and then disconnect the PC from the power source before removing the front and side panels of the PC. Failure to do so before you open the PC, or do any procedures, can result in personal injury or equipment damage.

Before Opening the PC

- 1 Remove any diskette or optical disc (CD or DVD) from the PC.
- 2 Click the **Start** button, and then click **Turn Off Computer**. Click **Turn Off**.
- 3 Disconnect the modem/telephone cable, if present.



CAUTION: To reduce the risk of personal injury from electrical shock or hot surfaces, disconnect the power cable from the wall outlet, and allow the internal system components to cool before touching.

- 4 Disconnect the power cable from the electrical outlet and then from the PC.
- 5 Disconnect all other attached cables (such as the keyboard, mouse and monitor) and all external devices.



CAUTION: Static electricity can damage the electronic components of the PC or optional equipment. Ensure that you are discharged of static electricity by briefly touching a grounded metal object.

After Closing the PC

To avoid injury and equipment damage, always follow this procedure in this order after closing the PC.

- 1 Reconnect the power cable.



WARNING: To reduce the risk of electrical shock, fire, or damage to the equipment, do not plug telecommunications or telephone connectors into the network interface card (NIC) (labeled as an Ethernet connector).

- 2 Reconnect the modem/telephone cable, and all other cables (such as the keyboard, mouse, and monitor) and external devices.
- 3 Turn on the PC and all peripherals.
- 4 If you installed an add-in card, install any software drivers supplied by the card manufacturer.

Removing the Side Panel

- 1 Remove the side panel by loosening the screw (D) that secures the panel to the PC chassis.

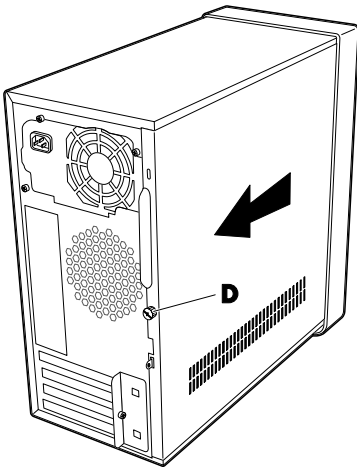

- 2 Slide the panel back about 1 inch (2.5 cm), and then lift it off the unit.



WARNING: Beware of sharp edges inside the chassis.

Replacing the Side Panel

- 1 Place the side panel in the proper position on the chassis, and slide it into place.

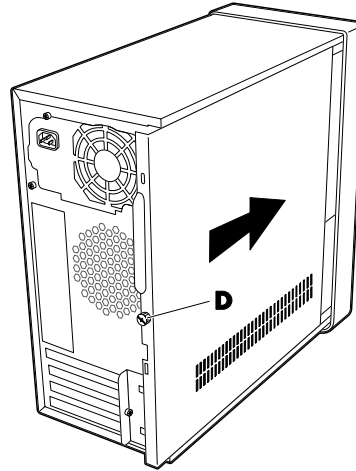

- 2 Ensure that the hole for the thumbscrew aligns with the hole in the chassis, and replace the thumbscrew (D).

Removing the Front Panel

This procedure is necessary only when removing or replacing an optical drive, memory card reader, diskette drive or the hard disk drive.

- 1 Press and hold down the square button (1) near the top front of the inside of the chassis. Press one tab (2), and then press the other tab (3), toward the outside edge of the chassis.

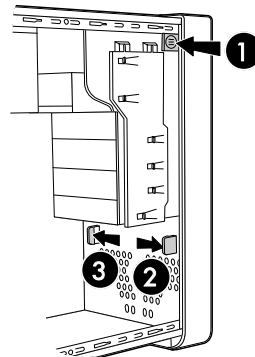

- 2 Remove the front panel.

Replacing the Front Panel

- 1 Align the top of the front panel with the top of the chassis front.
- 2 Press the panel onto the chassis at the top and at each side near the bottom until the panel snaps into place.

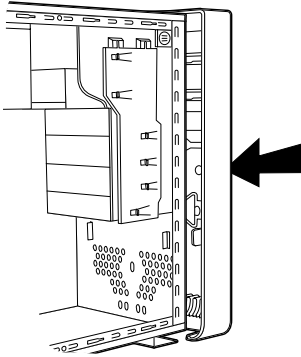

Locating Components Inside the PC

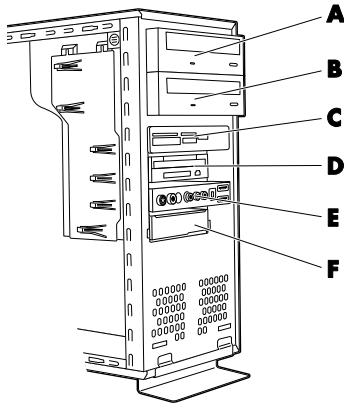

- A** Upper optical drive bay, may be a CD-ROM, CD-RW, DVD-ROM, DVD+RW/+R or combination drive
- B** Lower optical drive bay, may be empty (blank plate) or a CD-ROM, CD-RW, DVD-ROM, DVD+RW/+R or combination drive
- C** Memory card reader (select models)
- D** Diskette (floppy) drive (select models)
- E** Front connector panel (no replacement instructions)
- F** Hard disk drive

Removing and Replacing Drives

Your PC has several drives that you can replace or upgrade. See the preceding topic, "Locating Components Inside the PC" for drive type and location.

The hard disk drive is either a Serial ATA (advanced technology attachment) drive that uses a narrow data cable, or a Parallel ATA drive that uses a wide data cable.



CAUTION: Back up your personal files on the hard disk drive to an external storage device, such as a CD, before removing the hard disk drive. Failure to do so will result in data loss. After replacing the hard disk drive, you need to run System Recovery, using the recovery discs, to load the factory-installed files. See the user documentation that came with your PC for details about the recovery procedure.

You can add an optical drive into an empty lower optical drive bay.

IMPORTANT: Before adding a new optical drive, make sure that it is compatible with the Microsoft® Windows® XP operating system. Also, make sure you have the correct software and drivers for the optical drive to work with the operating system.

Removing a Drive

- 1 Complete the procedures to prepare the PC, to remove the side panel, and to remove the front panel. See "Opening and Closing the PC" on page 1.

2 Locate the drive you want to remove.

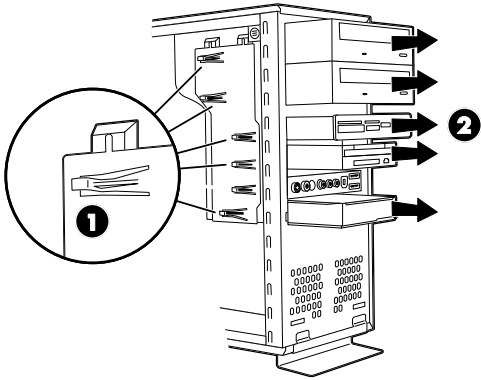

3 Release the drive from the chassis by lifting the tab **(1)** on the latch drive bracket, and then sliding **(2)** the drive partway out of the bay. (The latch drive bracket secures the drives in their respective positions in the chassis.)

4 Disconnect the power cable and data cable from the back of the drive you want to remove, as indicated in the following illustrations:

- For optical drives, disconnect the power cable **(P)** and the data cable **(D)** from the back of the drive you want to remove. If the drive has a sound cable **(S)**, disconnect it also.
- For most drive cables, use a gentle rocking motion to free the plug. For Serial ATA hard disk drive cables, press the latch **(1)** (select models only) in the center of each plug and pull the plug **(2)** from the drive connector.

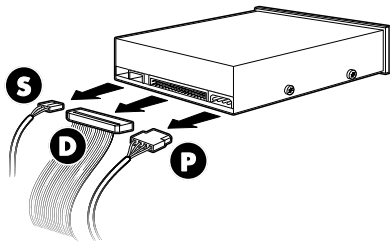

Disconnecting the Optical Drive Cables

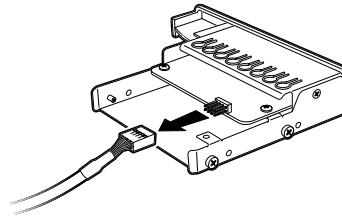

Disconnecting the Memory Card Reader Drive Cable

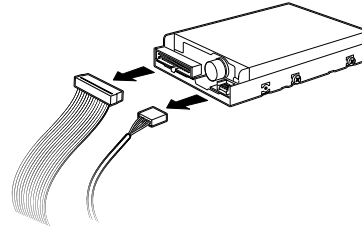

Disconnecting the Diskette (Floppy) Drive Cables

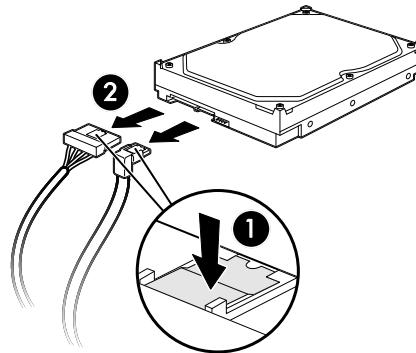

Disconnecting the Serial ATA Hard Disk Drive Cables

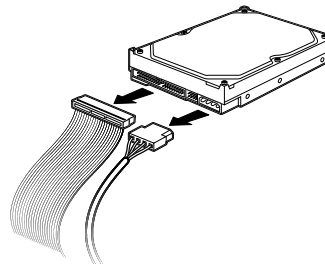

Disconnecting the Parallel ATA Hard Disk Drive Cables

- 5 Pull the drive out of the drive bay.
- 6 If you are replacing the old drive with a new drive, remove the four guide screws (two on each side) from the old drive. You need these screws to install the new drive.

Replacing or Adding a Drive

- 1 If necessary, remove the existing drive. See "Removing a Drive" on page 3.
- 2 If you are adding a drive to an empty lower optical drive bay, you must remove the blank plate from the bay. To do so, insert a flat screwdriver into the blank plate slot (C) and rotate the screwdriver to break the blank plate out of the chassis. Discard the blank plate.

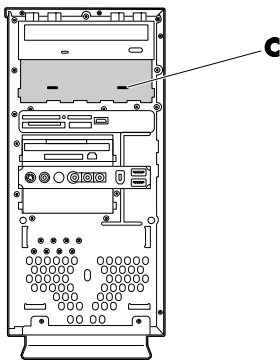

- 3 Make sure the jumper on the new optical drive or new Parallel ATA hard disk drive is in the CS (Cable Select) position. Your drive may vary from the illustration. The Serial ATA hard disk drive does not use cable select.

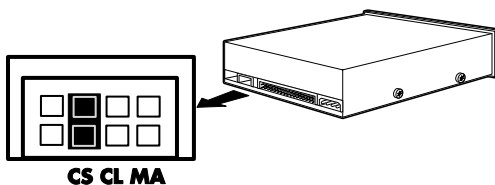

Cable Select Jumper

- 4 Install four guide screws on the sides of the new drive (two on each side). The screws help guide the drive into its proper position in the bay.

- 5 Slide the drive partway into the drive bay, making sure to align the guide screws with the guide slots.

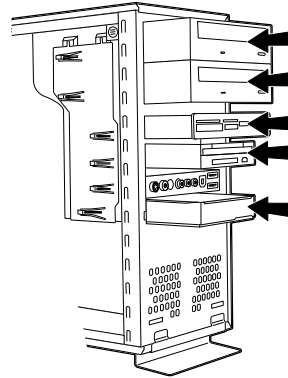

- 6 Reconnect the power and data cables to your drive, as indicated in the following illustrations. If it is present, reconnect the sound cable.

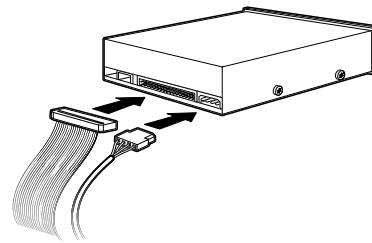

Connecting the Optical Drive Cables

NOTE: An optical drive may include a sound cable. Connect this cable also.

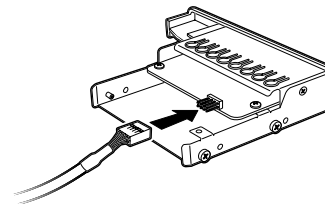

Connecting the Memory Card Reader Drive Cable

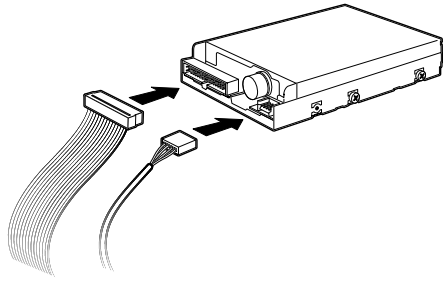

Connecting the Diskette (Floppy) Drive Cables

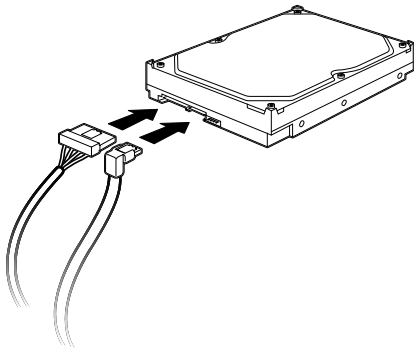

Connecting the Serial ATA Hard Disk Drive Cables

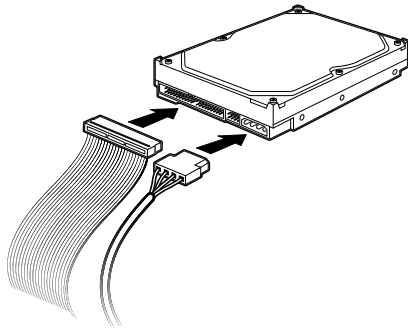

Connecting the Parallel ATA Hard Disk Drive Cables

- 7** Push the drive the rest of the way into the bay until the drive snaps into place.
- 8** Complete the procedures to replace the front panel, replace the side panel, and close the PC. See "Opening and Closing the PC" on page 1.

Adding Memory

Your PC comes with random access memory (RAM), which temporarily stores data and instructions on your PC. The PC ships with one or more memory modules, but you can replace the existing memory module(s) with higher-capacity ones.

The motherboard contains sockets for DDR DIMMs (double data rate dual in-line memory modules). The exact number of sockets and type of DDR memory module depends on which model PC you have.

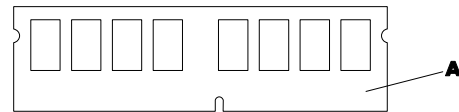

A DDR DIMM

To determine which type of memory module your PC uses, and for specific memory module information and specifications, go to the Web site listed in your *Warranty and Support Guide* and click the Support link.



WARNING: Using the wrong type of memory module could damage the system.

Removing a Memory Module

- 1** Complete the procedures to prepare the PC, and to remove the side panel. See "Opening and Closing the PC" on page 1.
- 2** Gently lay the PC on its side.
- 3** Locate the memory sockets on the motherboard.



CAUTION: When handling a memory module, be careful not to touch any of the contacts. Doing so may damage the module.

- 4** Move any cabling out of the way, if necessary.

- 5 Push down the two retaining clips on the ends of the memory socket until the memory module pops out of the socket.

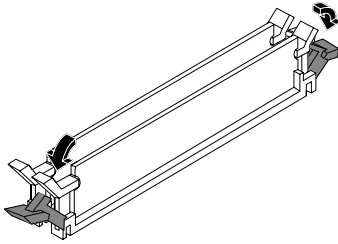

WARNING: Do not pull the memory module out of the socket. Use the retaining clips to eject the module.

- 6 Lift the memory module from the memory socket.

Installing a Memory Module

Upgrade the memory in your PC with memory of the same type and speed as the memory originally installed in your PC.

CAUTION: When handling a memory module, be careful not to touch any of the contacts. Doing so may damage the module.

- 1 Open both latches of the memory module socket.
 - If you are *replacing* a memory module, put the new memory module in the same memory slot from which the old memory was removed.

Or

 - If you are *adding* a memory module, install the new module into the socket nearest the preinstalled module, and install additional modules in the next available sockets.

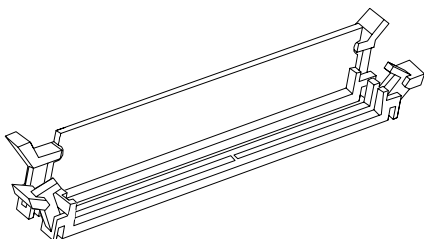

- 2 The memory module can be installed in only one way. Match the notch on the module with the tab on the memory socket (**B**). Push the module carefully and firmly into the slot, ensuring that the latches on both ends snap into place.

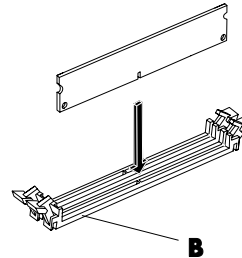

- 3 Set the chassis upright.
- 4 Complete the procedures to replace the side panel, and close the PC. See "Opening and Closing the PC" on page 1.

NOTE: If a blank screen is displayed after replacing or adding a memory module, the memory is installed incorrectly or it is the wrong type of memory. Remove and reinstall the memory module.

Removing or Installing an Add-In Card

An add-in card is a circuit board, such as a PCI or an AGP card that fits into a PC add-in card slot. Your PC contains several add-in card slots that can be used to add components to your PC. The PC component configurations vary by model.

WARNING: Do not overload the system by installing add-in cards that draw excessive current. The system is designed to provide 2 amps (average) of +5 V power for each board/card in the computer. The total +5 V current draw in a fully loaded system (one with all add-in card slots filled) must not exceed the total number of slots multiplied by 2 amps.

A Phillips screwdriver is needed to remove, replace, or add an add-in card.

Removing an Add-In Card

- 1 Complete the procedures to prepare the PC, and to remove the side panel. See "Opening and Closing the PC" on page 1.
- 2 Gently lay the PC on its side.
- 3 On the back of the PC, remove the screw from the bracket cover for the add-in card slots, and then remove the bracket cover.

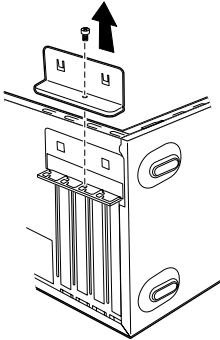

- 4 Inside the PC, locate the add-in card slots on the motherboard.

 **WARNING: Be careful of the sharp edges on the add-in card slot cover.**

- 5 Remove the slot cover.

Or

Holding the card at each end, carefully rock it back and forth until the connectors pull free from the socket, and then remove the card. Be sure not to scrape the card against the other components. Store the old card in the anti-static packaging that contained your new card.

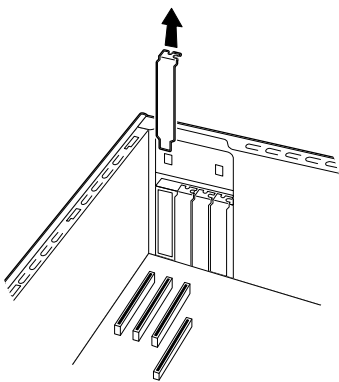

- 6 If you are not replacing the old add-in card with a new add-in card, close the open slot by inserting the metal slot cover into the opened slot.

Installing an Add-In Card

- 1 Align the edge of the add-in card with the slot on the chassis and gently but firmly press the card straight down into the add-in card slot. The whole connector should be seated properly in the card slot.

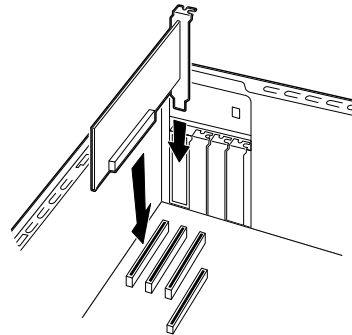

- 2 On the back of the PC, replace the bracket cover for the add-in card slots, and then install the screw.

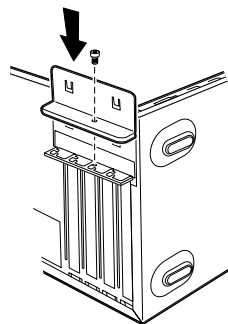

- 3 Set the chassis upright.
- 4 Complete the procedures to replace the side panel, and close the PC. See "Opening and Closing the PC" on page 1.

NOTE: If the new card or device isn't working, read through the card manufacturer's installation instructions, and recheck all connections, including those to the card, power supply, keyboard and monitor.

Replacing the Battery

A lithium battery on the motherboard provides backup power for the PC's timekeeping capability. The battery has an estimated life expectancy of seven years.

When the battery starts to weaken, the date and time may be incorrect. If the battery fails, replace it with a CR2032 lithium battery (3 volt, 220mAh rating) or an equivalent battery.



WARNING: There is danger of explosion if the battery is incorrectly replaced. Replace only with the same, or equivalent, type of battery. Discard used batteries according to the manufacturer's instructions.

- 1** Complete the procedures to prepare the PC, and to remove the side panel. See "Opening and Closing the PC" on page 1.
- 2** Gently lay the PC on its side.
- 3** Remove any cabling, if necessary, to reach the battery.
- 4** Remove any memory modules, if necessary, to reach the battery. See "Adding Memory" on page 6.
- 5** To remove the battery, push the latch away from the battery, and lift the battery from the socket.
- 6** Install the new CR2032 battery in the socket, with the positive (+) side facing the latch.
- 7** Replace memory modules or cables you removed.
- 8** Set the chassis upright.
- 9** Complete the procedures to replace the side panel, and to close the PC. See "Opening and Closing the PC" on page 1.



5 9 9 1 - 0 0 0 2