

Macintosh Setup Poster

HP Deskjet 6540-50 series

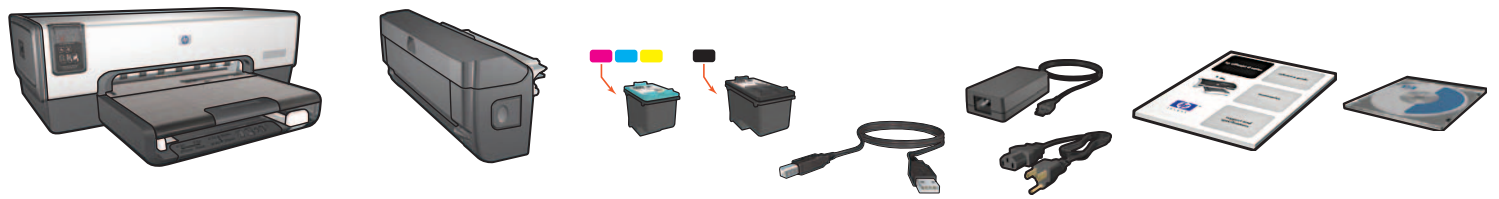

1 Remove rear door. Attach duplexer.

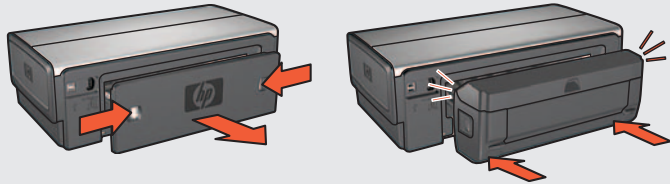

2 Plug in power supply.

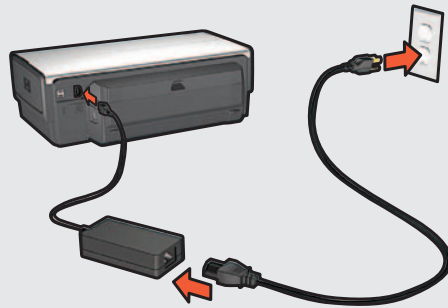

3 Load white paper.

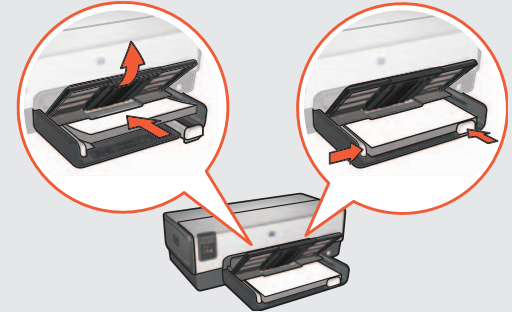

4 Lower Out tray. Pull out extension.

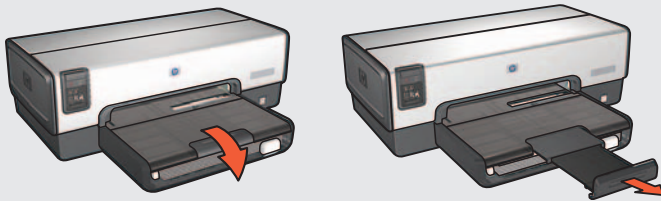

5 **1** Open cover.

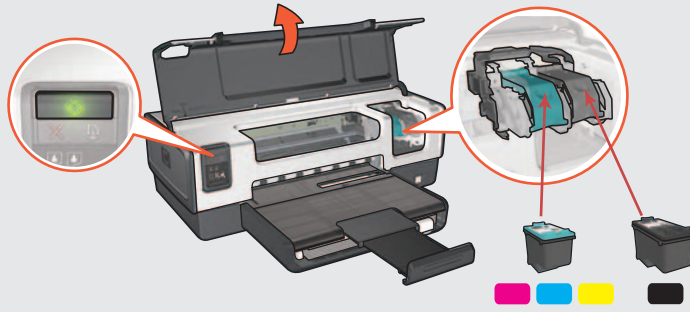

2 Pull pink tab to remove clear tape.



6 Wait until cradle is idle. Raise latches, insert print cartridges, then close latches.

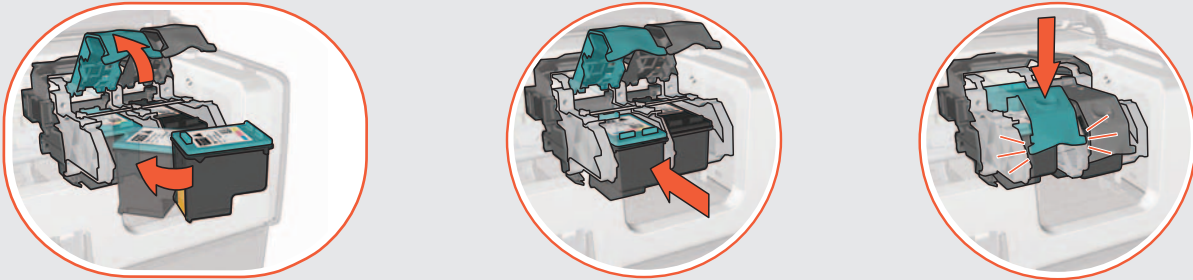

7 Close cover.

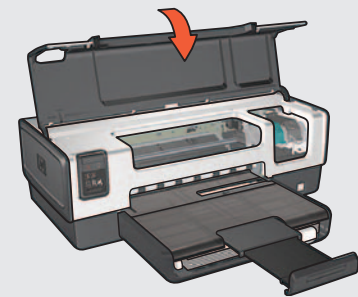

8 Connect printer to computer.

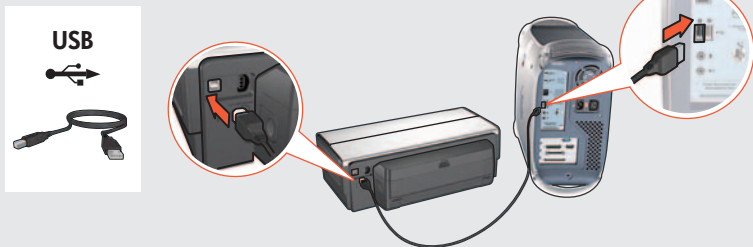

OR

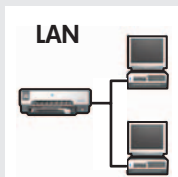

Purchase optional HP Jetdirect external print servers (subject to availability). For network setup, see instructions that came with your print server.

9 Install printer software

- 1 Insert the CD into the CD drive.
- 2 Double-click the CD icon in the Finder window.
- 3 Double-click the installer icon.
- 4 Accept the licensing agreement. Follow the installation instructions for your operating system.

OS X

- 1 Click **Install**.
- 2 Click **Quit** when the installation is complete.

OS 9.x

- 1 Click **Install**.
- 2 Click **Continue** to close all open programs.
- 3 Click **Restart** to restart your computer.
- 4 After your computer restarts, open **Chooser** to add the printer.

Need help? www.hp.com/support