

Copyright © 2004, 2005 Hewlett-Packard Development Company, L.P.  
Printed in  
www.hp.com

### 1 Keyboard and Mouse

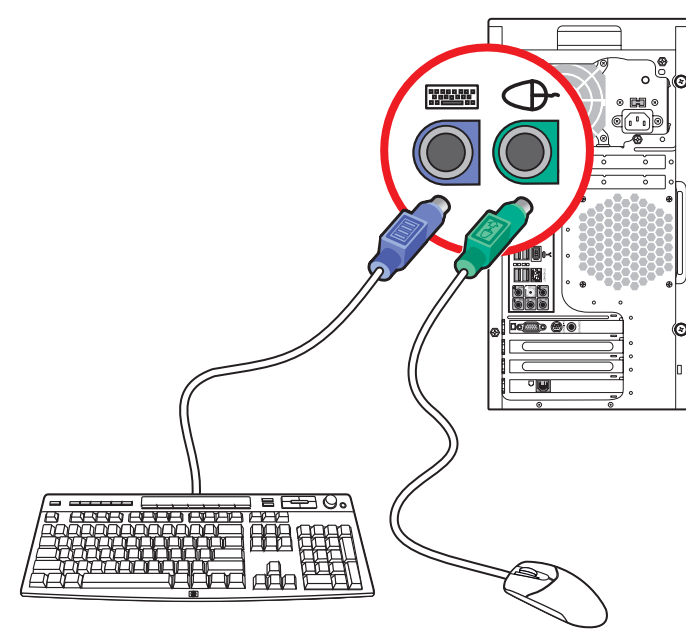

### Wireless option

Refer to the setup instructions located in your mouse/receiver box.

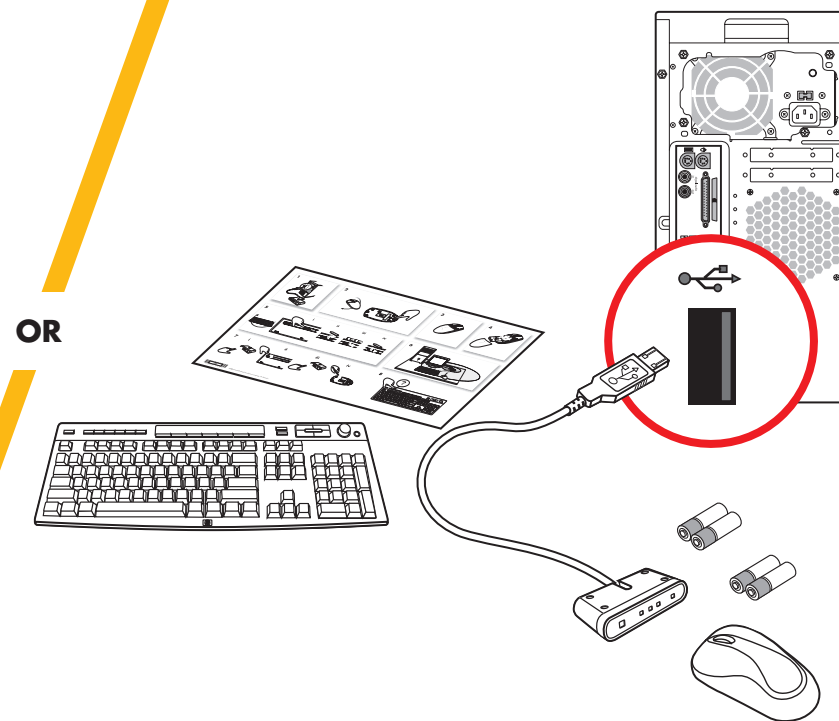

### 2 Monitor

Refer to setup instructions that came with your monitor.  
Monitors may be sold separately.

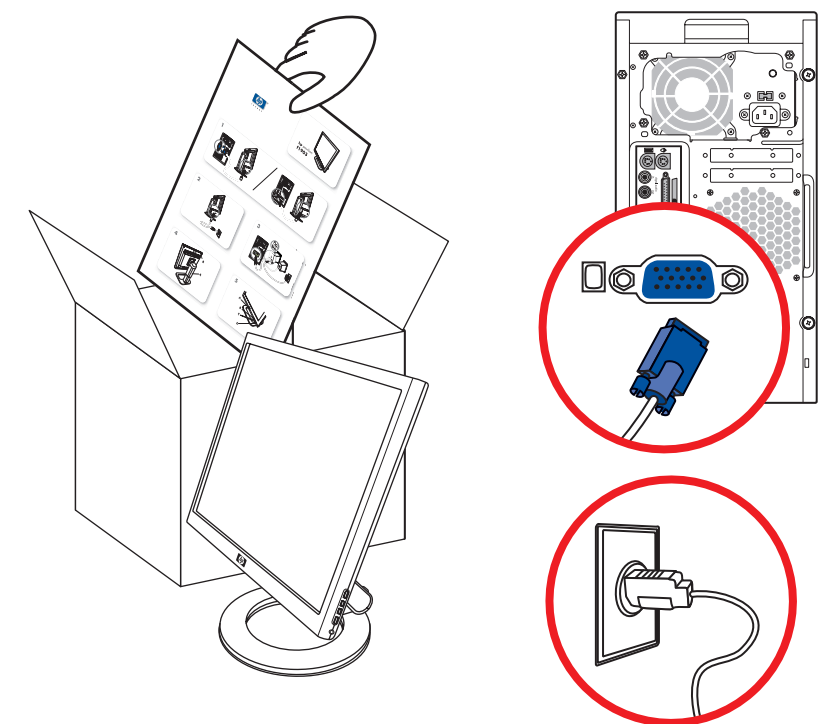

### 3 Speaker System

Refer to the instructions that came with your speakers. Speakers may be sold separately.

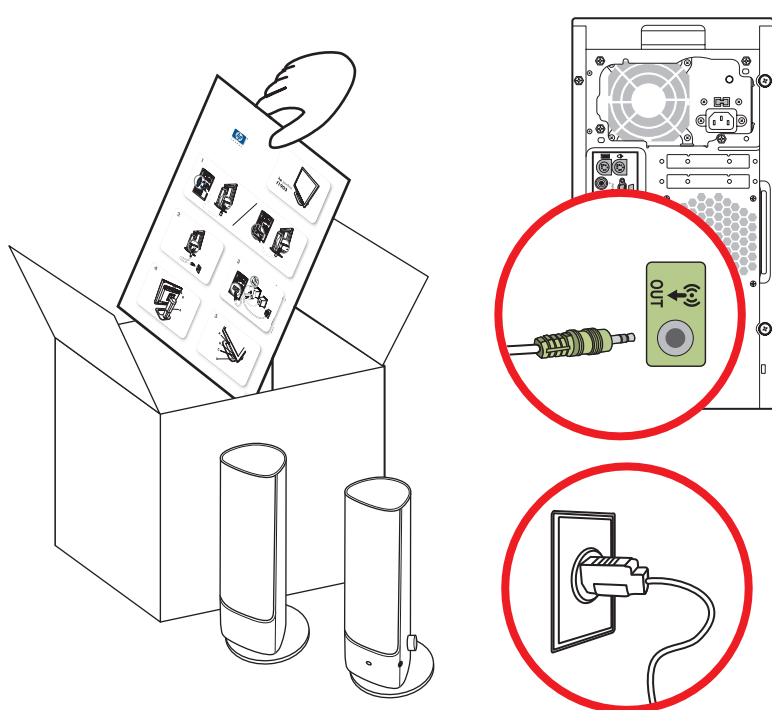

### 4 TV In

Connect TV signal to computer

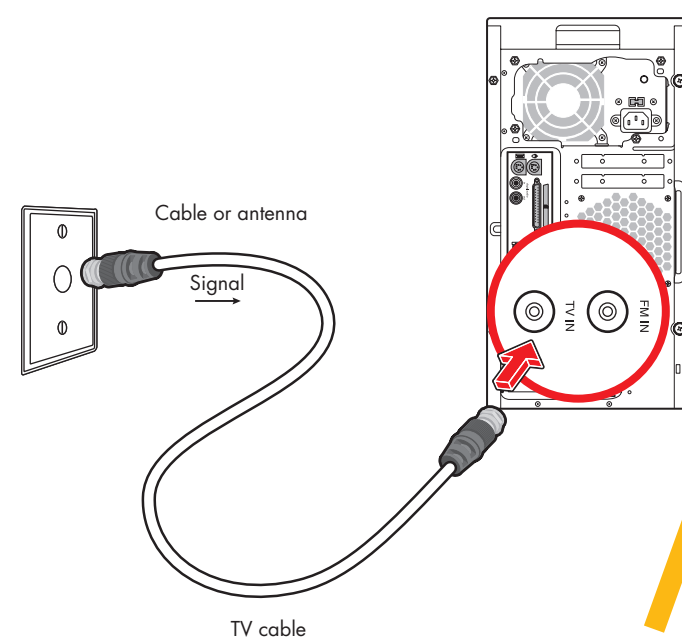

### If you use a cable or satellite set-top box,

pass the signal through the box.

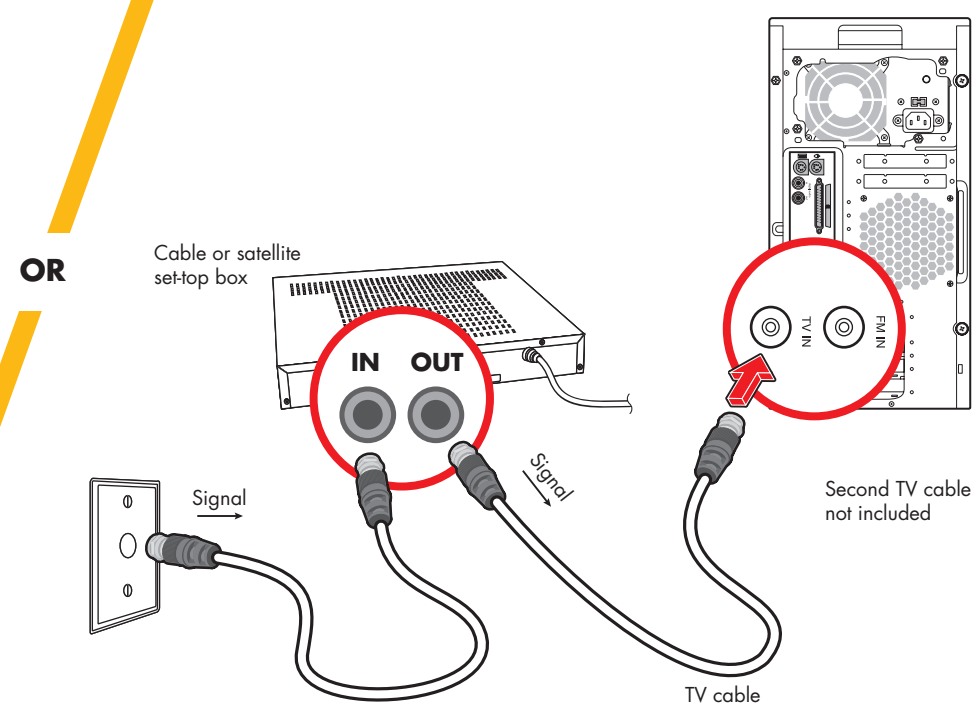

### 5 TV Out (TV connections are optional)

TV signal from computer to TV

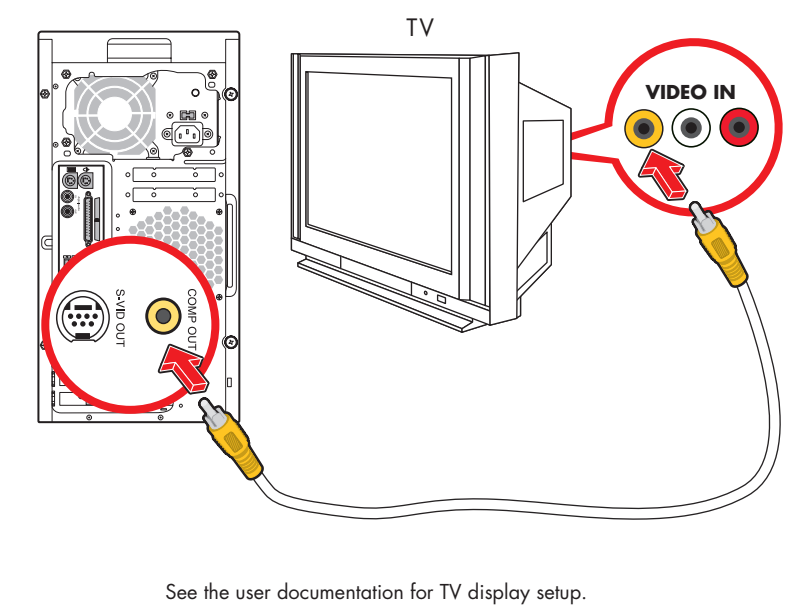

### 6 Remote Sensor

Connect remote control receiver to computer.

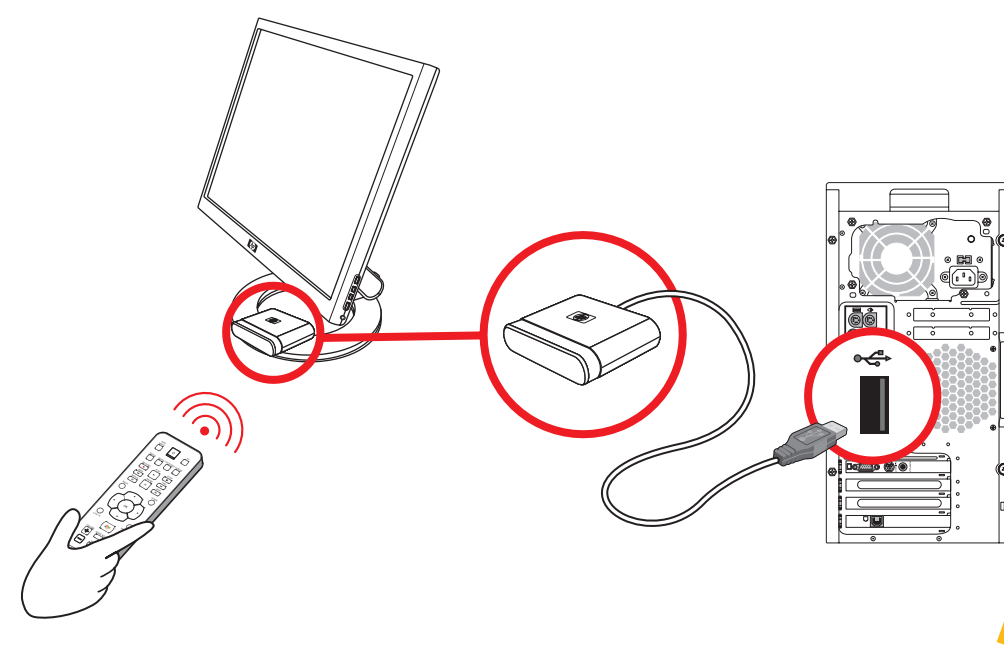

### If you use a cable or satellite set-top box,

pass the signal through the remote sensor control cable.

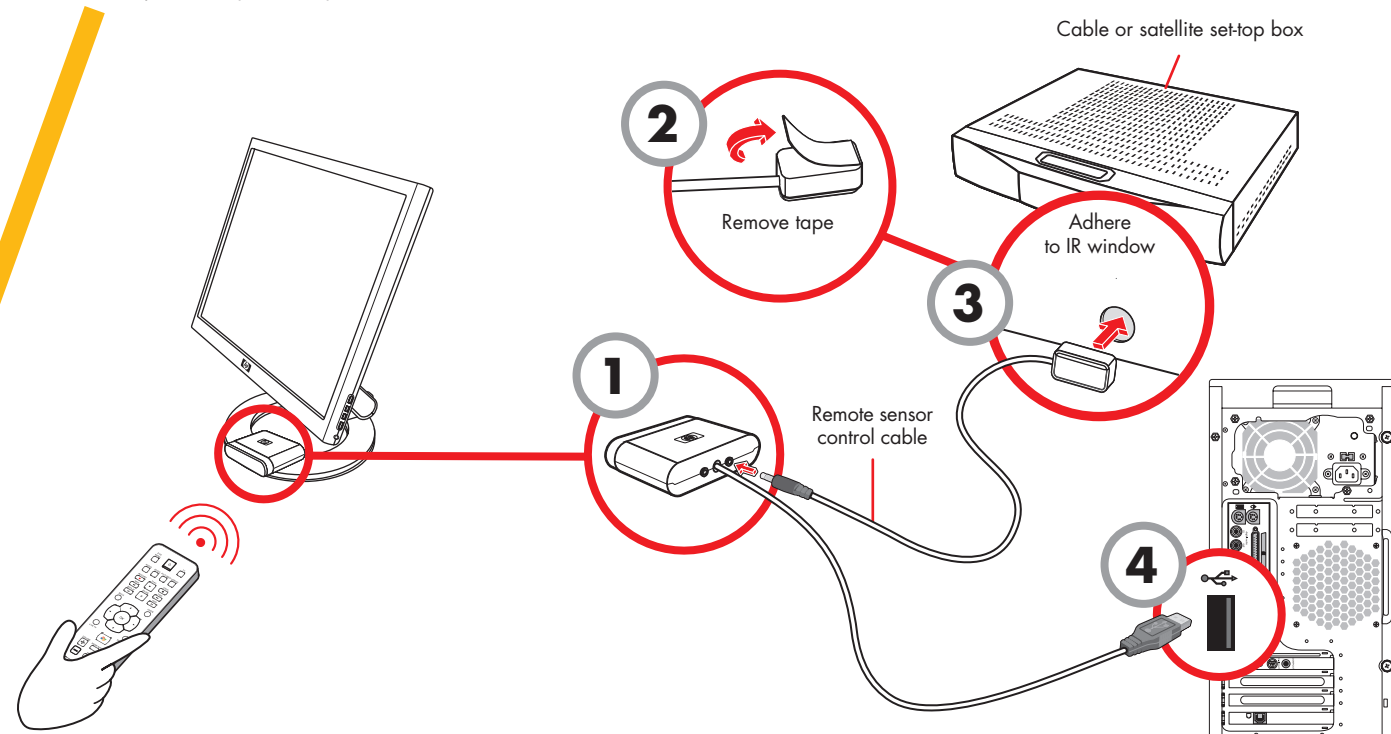

### 7 Remote Control

