

HP Deskjet 5400 series



User's guide

Hewlett-Packard Company notices

The information contained in this document is subject to change without notice.

All rights reserved. Reproduction, adaptation, or translation of this material is prohibited without prior written permission of Hewlett-Packard, except as allowed under copyright laws.

The only warranties for HP products and services are set forth in the express warranty statements accompanying such products and services. Nothing herein should be construed as constituting an additional warranty. HP shall not be liable for technical or editorial errors or omissions contained herein.

Acknowledgements

Microsoft, MS, MS-DOS, and Windows are registered trademarks of Microsoft Corporation.

TrueType is a U.S. trademark of Apple Computer, Inc.

Adobe, AdobeRGB, and Acrobat are trademarks of Adobe Systems Incorporated.

Copyright 2005 Hewlett-Packard Development Company, L.P.

Terms and conventions

The following terms and conventions are used in this user's guide.

Terms

The HP Deskjet printer is also referred to as the **HP printer** or **printer**.

Cautions and warnings

A **Caution** indicates possible damage to the HP Deskjet printer or to other equipment. For example:



Caution Do not touch the print cartridge ink nozzles or copper contacts. Touching these parts will result in clogs, ink failure, and bad electrical connections.

A **Warning** indicates possible harm to you or to others. For example:



Warning Keep both new and used print cartridges out of the reach of children.

Accessibility

Your HP printer provides a number of features that make it accessible for people with disabilities.

Visual

The printer software is accessible for users with visual impairments or low vision through the use of Windows accessibility options and features. It also supports most assistive technology such as screen readers, Braille readers, and voice-to-text applications. For users who are color blind, colored buttons and tabs used in the software and on the HP printer have simple text or icon labels that convey the appropriate action.

Mobility

For users with mobility impairments, the printer software functions can be executed through keyboard commands. The software also supports Windows accessibility options such as StickyKeys, ToggleKeys, FilterKeys, and MouseKeys. The printer doors, buttons, paper trays, and paper guides can be operated by users with limited strength and reach.

Contents

1	Welcome	4
2	Special features	5
3	Get started	6
	Printer features.....	6
	Buttons and lights.....	7
	Paper trays.....	9
	Print cartridges.....	13
	Ink-backup mode.....	14
4	Connect to the printer	15
	USB.....	15
	Networking.....	15
5	Print photos	16
	Print borderless photos.....	16
	Print photos with a border.....	18
	HP Real Life technologies.....	19
	Photo print cartridge.....	20
	PhotoREt.....	21
	Maximum dpi.....	21
	Advanced color settings.....	22
	Exif Print.....	22
	Store and handle photo paper.....	23
	Save money when printing photos.....	23
	Other photo projects.....	23
	Share photos with friends and family.....	24
6	Print photos from a digital camera	25
	About PictBridge.....	25
	PictBridge printing.....	25
7	Print other documents	27
	E-mail.....	27
	Letters.....	28
	Documents.....	29
	Envelopes.....	30
	Brochures.....	31
	Greeting cards.....	33
	Postcards.....	34
	Transparencies.....	35
	Labels.....	35
	Index cards and other small media.....	36
	Booklets.....	37
	Posters.....	39
	Iron-on transfers.....	40
8	Printing tips	42
	Printing shortcuts.....	42
	Fast/economical printing.....	42
	General everyday printing.....	43

	Presentation printing.....	43
	Print in grayscale.....	43
	Set default settings for the printer.....	43
	Select a print quality.....	44
	Set the page order.....	45
	Print multiple pages on a single sheet of paper.....	45
	Print preview.....	45
	Set a custom paper size.....	46
	Select a paper type.....	46
	Print task quick sets.....	46
	Two-sided printing.....	47
	Resize a document	50
	Watermarks.....	51
9	Printer software	53
	Printer Properties dialog box.....	53
	What's This? help.....	53
	Ink Status window.....	53
	Download printer software updates.....	54
10	Maintenance	55
	Install print cartridges.....	55
	Set the auto-off feature.....	58
	Align the print cartridges.....	58
	Calibrate color.....	59
	Calibrate print quality.....	59
	Automatically clean print cartridges.....	59
	Print a test page.....	60
	View estimated ink levels.....	60
	Maintain the printer body.....	60
	Remove ink from your skin and clothing.....	61
	Manually clean print cartridges.....	61
	Maintain print cartridges.....	62
	Printer Toolbox.....	63
11	Troubleshooting	64
	Printer does not print.....	64
	Paper jam.....	65
	Paper problems.....	66
	Printer is stalled.....	67
	Print cartridge problems.....	68
	Photos do not print correctly.....	69
	PictBridge problems.....	72
	Print quality is poor.....	73
	Document is misprinted.....	75
	Problems with borderless documents.....	76
	Error messages.....	80
	Printer lights are on or flashing.....	82
	Document prints slowly.....	83
	If you continue to have problems.....	84
12	Supplies	85
	Paper.....	85
	USB cables.....	85

Contents

13 Specifications	86
Printer specifications.....	86
14 Environmental information	87
Environmental statement.....	87
Print cartridge recovery.....	88
Index	90

1 Welcome

To find an answer to a question, select one of the following topics:



- [Special features](#)
- [Get started](#)
- [Connect to the printer](#)
- [Print photos](#)
- [Print photos from a digital camera](#)
- [Print other documents](#)
- [Printing tips](#)
- [Printer software](#)
- [Maintenance](#)
- [Troubleshooting](#)
- [Supplies](#)
- [Specifications](#)
- [Environmental information](#)

2 Special features

Congratulations! You have purchased an HP Deskjet printer that is equipped with several exciting features:

- **Borderless printing:** Use the entire page surface when printing [photos](#) and [brochures](#) with the borderless printing feature.
- **Six-ink upgradeable printing:** Enhance photo printing with a [photo print cartridge](#) (purchased separately).
- **Ink-backup mode:** Use [ink-backup mode](#) to continue printing with one print cartridge when the other print cartridge has run out of ink.
- **Printing from a digital camera:** Print photos directly from a digital camera using the [PictBridge](#) port.
- **Panoramic printing:** Print panoramic photos [with borders](#) or [without borders](#).
- **Real Life technologies:** [HP Real Life technologies](#) make it easy for you to get better photos. Automatic red-eye removal and adaptive lighting to enhance detail in shadows are just a few of the many technologies included.
- HP Vivera Inks deliver true-to-life photo quality and exceptional fade resistance resulting in vivid colors that last. HP Vivera Inks are specially-formulated and scientifically tested for quality, purity and fade resistance.

3 Get started

- Printer features
- Buttons and lights
- Paper trays
- Print cartridges
- Ink-backup mode

Printer features

The printer has several features to make printing easier and more efficient.



1	Buttons and lights
2	PictBridge port
3	Paper trays



1	Print cartridges
2	Ink-backup mode

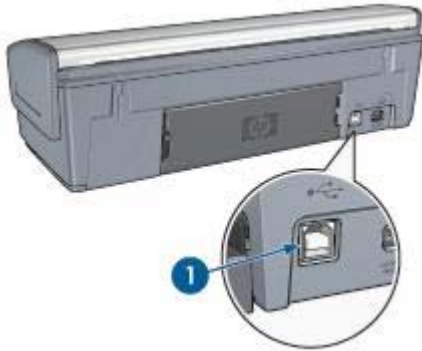

1	USB port
---	----------

Buttons and lights

Use the printer buttons to turn the printer on and off, cancel a print job, and restart a job. The printer lights give you visual cues about the status of the printer.



1	Power button and light
2	Print Cancel button
3	Resume button and light
4	PictBridge lights

Power button and light

Use the Power button to turn the printer on and off. It can take a few seconds for the printer to turn on after you press the Power button.



1	Power button
---	--------------

The Power light flashes when the printer is processing.

 **Caution** Always use the Power button to turn the printer on and off. Using a power strip, surge protector, or a wall-mounted switch to turn the printer on and off might cause printer failure.

Print Cancel and Resume buttons

The printer also has a Print Cancel button and a Resume button and light.



1	Print Cancel button
2	Resume button and light

Pressing the Print Cancel button cancels the current print job.

The Resume light flashes when an action is required, such as loading paper or clearing a paper jam. When the problem is solved, press the Resume button to continue printing.

PictBridge lights

Plug a PictBridge-enabled camera into the printer PictBridge port using a digital camera USB cable to print digital photographs.

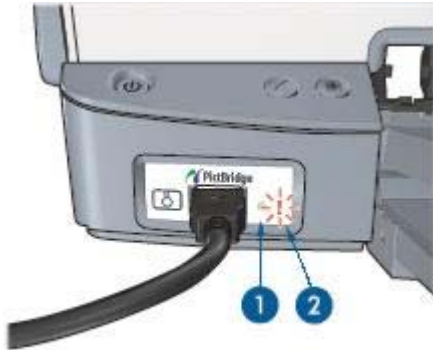

1	Connection light
2	Error light

When the camera is connected correctly, the green Connection light is illuminated. The printer Power light flashes and the Connection light remains lit solid when printing from the camera. If the camera is not PictBridge-compatible or is not in PictBridge mode, the amber Error light flashes.

Paper trays

For information about the paper trays, select one of these topics.

Unfold the paper trays

Follow these steps to unfold the paper trays:

1. Lower the In tray.



2. Lower the Out tray.



3. Pull out the Out-tray extension.



In tray

The In tray holds paper or other media.



1	In tray
---	---------

Paper guide

Print on different sizes of media by sliding the paper guide to the right or to the left.

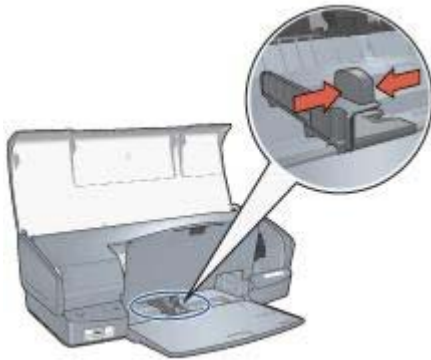

Out tray

Printed pages are deposited in the Out tray.



1	Out tray
---	----------

Raise the Out tray to load paper or other media. Lower the Out tray before printing.

To prevent paper from falling out of the Out tray, fully pull out the Out-tray extension. If you are printing in the FastDraft mode, unfold the Out-tray extension stop.



1	Out-tray extension
2	Out-tray extension stop

Fold the paper trays

Follow these steps to fold the paper trays:

1. Remove paper or other media from the paper trays.
2. If the Out-tray extension stop is raised, lower it and then push it into the Out-tray extension.



3. Push the Out-tray extension into the Out tray.



4. Raise the Out tray.



5. Raise the In tray.



Print cartridges

Three print cartridges can be used with the printer.

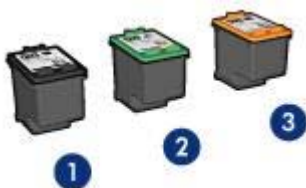

1	Black print cartridge
2	Tri-color print cartridge
3	Photo print cartridge

Use print cartridges

The print cartridges can be used in the following ways:

- **Everyday printing:** Use the black and tri-color print cartridges for everyday print jobs.
- **Quality color photos:** For more vibrant colors when printing color photographs or other special documents, remove the black print cartridge and install a photo print cartridge. The photo print cartridge, in combination with the tri-color print cartridge, provides you with virtually grain-free photos.

Replace print cartridges

When buying print cartridges, look for the print cartridge selection number.

You can find the selection number in three places:

- Selection number label: Look at the label on the print cartridge that you are replacing.

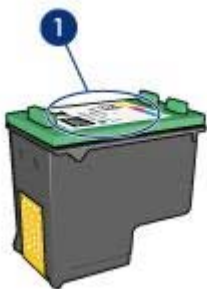

1	Selection number label
---	------------------------

- Printer documentation: For a list of print cartridge selection numbers, see the reference guide that came with the printer.
- Print Cartridge Ordering Information dialog box: For a list of print cartridge selection numbers, open the printer [Toolbox](#), click the **Estimated Ink Level** tab, and then click the **Print Cartridge Information** button.

If a print cartridge runs out of ink, the printer can operate in [ink-backup mode](#).

For information about installing a replacement print cartridge, see the [print cartridge installation](#) page.

Ink-backup mode

Use the ink-backup mode to operate the printer with only one print cartridge. The ink-backup mode is initiated when a print cartridge is removed from the print cartridge cradle.

Ink-backup mode output

Printing in ink-backup mode slows the printer and affects the quality of printouts.

Installed print cartridge	Result
Black print cartridge	Colors print as grayscale.
Tri-color print cartridge	Colors print but black is grayed and is not a true black.
Photo print cartridge	Colors print as grayscale.



Note HP does not recommend using the photo print cartridge for ink-backup mode.

Exit ink-backup mode

Install two print cartridges in the printer to exit ink-backup mode.

For instructions about installing a print cartridge, see the [print cartridge installation](#) page.

4 Connect to the printer

- [USB](#)
- [Networking](#)

USB

The printer connects to the computer with a universal serial bus (USB) cable. The computer must be running Windows 98 or later to use a USB cable.

For instructions about connecting the printer with a USB cable, see the setup poster that came with the printer.



Note A USB cable might not be packaged with your printer.

Networking

The printer can be connected to a network through a networked computer or by using an HP Jetdirect Print Server.

Connect through a networked computer

The printer can be connected directly to a computer on a network and then shared with other computers on the network.

For instructions about sharing the printer on a network, use the printer software CD and follow the onscreen network setup instructions.

Use an HP Jetdirect print server

The printer can be connected to a network by using an HP Jetdirect print server.

For instructions about using an HP Jetdirect print server, see the printer software CD and the documentation that came with the print server.



Note HP Jetdirect print servers are not available in all countries/regions.

5 Print photos

The printer software offers several features that make printing digital photos easier and improve photo quality.

Learn how to perform the following tasks:

- Print a [borderless photo](#).
- Print a photo with a [border](#).
- Use [HP Real Life technologies](#) to touch up photos.
- Use the [photo print cartridge](#) for great colors and virtually grain-free photos.
- Get the best combination of speed and quality by using [PhotoREt](#).
- Achieve the highest printing resolution with [maximum dpi](#).
- Improve printed colors with [advanced color settings](#).
- Print an [Exif Print-formatted](#) photo if you have Exif Print-enabled software.
- Prevent photo paper from curling by following the [photo paper storage and handling guidelines](#).
- Use HP Everyday Photo Paper to [save money and ink](#) when printing photos.

Print borderless photos

Use borderless printing to print to the edges of certain paper types and to print on a range of paper sizes—from 4 x 6 inch photo paper to a 210 x 594 mm (8.5 x 23.4 inch) custom photo size.

Guidelines

- For high-quality results, use a [photo print cartridge](#) in combination with the tri-color print cartridge.
- Do not print borderless photos in [ink-backup mode](#). Always have two print cartridges installed in the printer.
- Open the file in a software program such as HP Image Zone or Adobe Photoshop and assign the photo size. Ensure that the size corresponds to the paper size on which you want to print the photo.
- For maximum fade resistance, use HP Premium Plus Photo Paper.
- Verify that the photo paper that you are using is flat. For information about preventing photo paper from curling, see the [photo paper storage instructions](#).
- Do not exceed the In tray capacity: 30 sheets of photo paper.

Prepare to print

1. Raise the Out tray.
2. Slide the paper guide all the way to the left.
3. Verify that the photo paper is flat.
4. Place the photo paper in the In tray, with the side to be printed on facing down. If you are using photo paper with a tear-off tab, verify that the tab is pointing away from the printer.
5. Slide the paper guide firmly against the edge of the paper.

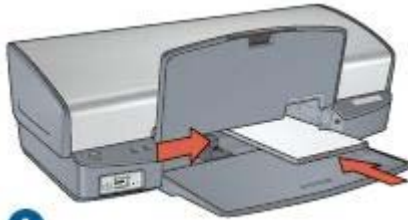

1

1 | Small photos

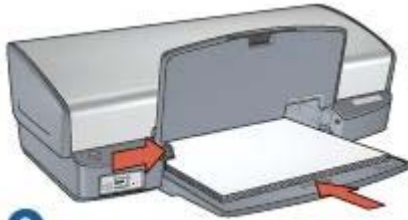

2

2 | Large photos



Note Some panoramic paper sizes might extend beyond the edge of the In tray.

6. Lower the Out tray.

Print



Note If your software program includes a photo printing feature, follow the instructions that are provided with the software program. Otherwise, follow these instructions.

1. Open the photo in an application that allows editing, such as HP Image Zone or Adobe Photoshop.
 2. Open the [Printer Properties](#) dialog box.
 3. Click the **Printing Shortcuts** tab.
 4. In the **What do you want to do?** drop-down list, click **Photo Printing-borderless**, and then select the following options:
 - **Print Quality: Normal** or **Best**
-  **Note** For maximum dpi quality, go to the **Paper/Quality** tab, and then click **Maximum dpi** in the **Print Quality** drop-down list.
- **Paper Type:** An appropriate photo paper type
 - **Paper Size:** An appropriate borderless photo paper size
 - **Orientation: Portrait** or **Landscape**
5. Set the [HP Real Life technologies](#) as appropriate.
 6. Click **OK** to print the photo.

If you printed on photo paper with a tear-off tab, remove the tab to make the document completely borderless.

Use the [What's This? help](#) to learn about the features that appear in the Printer Properties dialog box.

Print photos with a border

Follow these instructions to print photos with a white border.

Guidelines

- For high-quality results, use a [photo print cartridge](#) in combination with the tri-color print cartridge.
- For maximum fade resistance, use HP Premium Plus Photo Paper.
- Open the file in a software program such as HP Image Zone or Adobe Photoshop and assign the photo size. Ensure that the size corresponds to the paper size on which you want to print the photo.
- Verify that the photo paper that you are using is flat. For information about preventing photo paper from curling, see the [photo paper storage instructions](#).
- Do not exceed the In tray capacity: 30 sheets of photo paper.

Prepare to print

1. Raise the Out tray.
2. Slide the paper guide all the way to the left.
3. Verify that the photo paper is flat.
4. Place the photo paper in the In tray with the side to be printed on facing down.
5. Slide the paper guide firmly against the edge of the paper stack.



1	Small photos
---	--------------

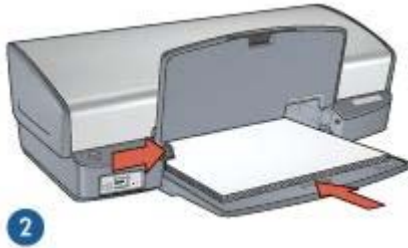

2 | Large photos

6. Lower the Out tray.

Print



Note If your software program includes a photo printing feature, follow the instructions that are provided with the software program. Otherwise, follow these instructions.

1. Open the photo in an application that allows editing, such as HP Image Zone or Adobe Photoshop.
2. Open the [Printer Properties](#) dialog box.
3. Click the **Printing Shortcuts** tab.
4. In the **What do you want to do?** drop-down list, click **Photo printing-with white borders**, and then select the following options:
 - **Print Quality: Normal** or **Best**



Note For maximum dpi quality, go to the **Paper/Quality** tab, and then click **Maximum dpi** in the **Print Quality** drop-down list.

- **Paper Type:** An appropriate photo paper type
 - **Paper Size:** An appropriate photo paper size
 - **Orientation: Portrait** or **Landscape**
5. Set the [HP Real Life technologies](#) as appropriate.
 6. Click **OK** to print the photo.

Use the [What's This? help](#) to learn about the features that appear in the Printer Properties dialog box.

HP Real Life technologies

HP Real Life technologies make it easy for you to get better photos. Automatic red-eye removal and adaptive lighting to enhance detail in shadows are just a few of the technologies included.

Open HP Real Life technologies

Follow these steps to open the HP Real Life technologies dialog box:

1. Open the [Printer Properties](#) dialog box.
2. Click the **Paper/Quality** tab, and then click the **Real Life Digital Photography** button.

Use HP Real Life technologies

Use the HP Real Life technologies dialog box to set these options:

1. **Automatic Red-Eye Removal:** Click **On** to automatically remove or reduce red-eye in the photo.
2. **Photo Brightening:** Automatically enhance colors and contrast for washed-out photos. Click **Automatic** to allow the printer software to intelligently brighten your photo, focusing only on areas that need adjustment.
3. **Adaptive Lighting:** Adjust the exposure in dark areas of photos to bring out detail. Click **Automatic** to allow the printer software to balance lightness and darkness automatically.
4. **SmartFocus:** Enhance the image quality and clarity of low resolution images such as those downloaded from the Internet. Click **On** to allow the printer software to sharpen details in the image automatically.
5. **Sharpness:** Adjust the image sharpness to your preference. Click **Automatic** to allow the printer software to set the level of sharpening for the image automatically.
6. **Smoothing:** Soften an image. Click **Automatic** to allow the printer software to set the level of smoothing for the image automatically.



Note If you installed the HP Image Zone software, you can use it to edit and further enhance digital photos.

Photo print cartridge

The photo print cartridge, when used in conjunction with the tri-color print cartridge, provides virtually grain-free photos. It offers exceptional fade resistance for photos that are printed on HP Premium Plus Photo Paper.



The photo print cartridge can be purchased separately if it is not included with your printer.

Install the photo print cartridge

To install the photo print cartridge, remove the black print cartridge from the printer, and then [install](#) the photo print cartridge in the right side of the print cartridge cradle.



Note To protect a print cartridge when it is not in the printer, follow these storage [guidelines](#).

Use the photo print cartridge

1. Open the [Printer Properties](#) dialog box.
2. Click the **Printing Shortcuts** tab.
3. In the **What do you want to do?** drop-down list, click either **Photo Printing-borderless** or **Photo Printing-with white borders**.
4. In the **Print Quality** drop-down list, click **Normal** or **Best**.



Note For maximum dpi quality, on the **Paper/Quality** tab, click **Maximum dpi** in the **Print Quality** drop-down list.

5. In the **Paper Type** drop-down list, click the appropriate photo paper type.
6. Select any other print settings that you want, and then click **OK**.

Store the photo print cartridge

Follow these [guidelines](#) when storing the photo print cartridge.

PhotoREt

PhotoREt offers the best combination of print speed and quality for your image.

Follow these steps to print with PhotoREt technology:

1. Open the [Printer Properties](#) dialog box.
2. Click the **Printing Shortcuts** tab or the **Paper/Quality** tab.
3. Click **Best** in the **Print Quality** drop-down list.
4. Select any other print settings that you want, and then click **OK**.

Maximum dpi

The maximum dpi print quality setting offers 4800 x 1200 optimized dots per inch (dpi) printing.

The 4800 x 1200 optimized dpi is the highest quality resolution for this printer. When 4800 x 1200 optimized dpi is selected in the printer software, the tri-color print cartridge prints in the 4800 x 1200 optimized dpi mode (up to 4800 x 1200 optimized dpi color and 1200-input dpi).

If a [photo print cartridge](#) is also installed, the print quality is enhanced. A photo print cartridge can be purchased separately if it is not included with the printer.



Note Using maximum dpi increases the printing time and requires a large amount of disk space.

Follow these steps to print in the 4800 x 1200 optimized dpi mode:

1. Open the [Printer Properties](#) dialog box.
2. Click the **Paper/Quality** tab.
3. In the **Type is** drop-down list, click **More**, and then select the appropriate photo paper type.
4. In the **Print Quality** drop-down list, click **Maximum dpi**.
5. Select any other print settings that you want, and then click **OK**.



Note Use an HP premium photo paper when printing in the maximum dpi mode to enhance color matching and detail in the photo.

Advanced color settings

Use the Advanced color settings dialog box to adjust how printed colors appear in your photos.

Adjusting these settings causes the printed colors to differ from the colors that appear on your computer monitor.

To specify advanced color settings, follow these steps:

1. Open the [Printer Properties](#) dialog box.
2. Click the **Color** tab, and then click the **Advanced Color Settings** button. The Advanced Color Settings dialog box appears.
3. Adjust the **Brightness**, **Saturation**, and **Color Tone** to affect how overall colors are printed.



Note When you adjust color settings, the changes are reflected in the Preview box.

4. After specifying the color settings, click **OK**.
5. Select any other print settings that you want, and then click **OK**.

Exif Print

Exif Print (Exchangeable Image File Format 2.2) is an international digital imaging standard that simplifies digital photography and enhances printed photos. When a photo is taken with an Exif Print-enabled digital camera, Exif Print captures information such as exposure time, type of flash, and color saturation, and stores it in the image file. The HP Deskjet printer software then uses this information to automatically perform image-specific enhancements to create outstanding photos.

To print Exif Print-enhanced photos, you must have the following items:

- A digital camera that supports Exif Print
- Exif Print-enabled photo software

Follow these steps to print Exif Print-enhanced photos:

1. Open the photo in an application that allows editing, such as HP Image Zone or Adobe Photoshop.
2. Open the [Printer Properties](#) dialog box.
3. Click the **Paper/Quality** tab.

4. In the **Type is** drop-down list, click **More**, and then select the appropriate photo paper type.
5. In the **Print Quality** drop-down list, click **Normal**, **Best**, or **Maximum dpi**.
6. Select any other print settings that you want, and then click **OK**.

The printer software automatically optimizes the printed image.

Store and handle photo paper

Follow these instructions to maintain the quality of HP brand photo paper.

Storage

- Keep unused photo paper in a plastic bag. Store the packaged photo paper on a flat surface in a cool place.
- When you are ready to print, remove only the paper that you plan to use immediately from the plastic bag. When you have finished printing, return any unused photo paper to the plastic bag.
- Do not leave unused photo paper in the paper tray. The paper might start to curl, which can reduce the quality of your photos.

Handling

- Always hold photo paper by its edges. Fingerprints on photo paper can reduce print quality.
- If the corners of the photo paper curl more than 10 mm (0.4 inch), flatten the paper by putting it in the storage bag, and then gently bending it in the opposite direction of the curl until the paper lies flat.
Photo paper should be flat before it is printed on.

Save money when printing photos

To save money and ink when printing photos, use HP Everyday Photo Paper and set the [print quality](#) to **Normal**.

HP Everyday Photo Paper is designed to create quality photos with less ink.



Note For higher-quality photos, use HP Premium Plus Photo Paper and set the print quality to **Best** or [Maximum dpi](#).

Other photo projects

The HP Image Zone software coordinates the functions of HP imaging devices: scanners, cameras, printers, and all-in-one devices. Depending on the devices you have installed and their capabilities, you can quickly and easily organize, edit, and share digital images.

Organize, edit, and share digital images in creative ways

If you performed the default typical installation of the printer software, you also installed the HP Image Zone software. HP Image Zone lets you easily:

- Print photos and digital images
- Transfer images from a camera or memory card
- View images as a slide show
- Edit images
- Create photo album pages and flyers
- Share photos with friends and family

Share photos with friends and family

If you performed the default typical installation of the printer software, you also installed the HP Image Zone software. If you have installed HP Image Zone, see the HP Image Zone help to learn about how you can use the software to easily select and share images by e-mail without the use of large file attachments.

6 Print photos from a digital camera

Learn how to print photos directly from a digital camera.

- [About PictBridge](#)
- [PictBridge printing](#)

About PictBridge

With a PictBridge-enabled camera, you do not need a computer to print digital photographs. Just plug the camera into the printer's PictBridge port.



Note Do not plug other USB devices into the PictBridge port.



Note When two PictBridge devices communicate, they provide only the services that they have in common. For example, some cameras might allow photos formatted as either TIFFs or JPEGs to be printed over a PictBridge connection, but, since the printer does not support TIFFs over a PictBridge connection, only JPEGs can be printed.

When a camera is connected to the PictBridge port, the default printer settings will print a 4 x 6 inch borderless photo with portrait orientation. For detailed information on printing from the camera, consult the documentation that came with your camera.

PictBridge printing

In order to print photos directly from a digital camera, you need the following items:

- A PictBridge-compatible camera
- A digital camera USB cable



Check the documentation that came with your camera to ensure that your camera supports PictBridge.

Follow these steps to print photos from a PictBridge-compatible camera:

1. Load photo paper into the printer.
For instructions about loading photo paper, click one of the following options:
 - [Print borderless photos](#)
 - [Print photos with a border](#)
2. Connect your camera to the PictBridge port on the front of the printer using the USB cable supplied with your camera.
3. Turn on your camera, and then set it to PictBridge mode.
If you do not know how to set the camera to PictBridge mode, see the documentation that came with the camera.



Note When the camera is connected correctly, the Connection light is illuminated. The Connection light blinks green when printing from the camera. If the camera is not PictBridge-compatible or is not in PictBridge mode, the Error light flashes.



1	Connection light
2	Error light

After you successfully connect the camera to the printer, you can print your photos. Be sure the size of the paper loaded in the printer matches the setting on your camera. Refer to the documentation that came with your camera for detailed information on printing from the camera.

7 Print other documents



E-mail



Letters



Documents



Envelopes



Brochures



Greeting cards



Postcards



Transparencies



Labels



Index cards



Booklets



Posters



Iron-on transfers

Printing tips: Minimize your cost and effort while maximizing the quality of your printouts with [printing tips](#).

Printer software: Learn about the [printer software](#).

E-mail

To print an e-mail, use the Printing Shortcuts tab.

Guidelines

Do not exceed the In tray capacity: 100 sheets of plain paper.

Prepare to print

1. Raise the Out tray.
2. Slide the paper guide all the way to the left.
3. Place plain paper in the In tray, pushing the paper into the printer until it stops.
4. Slide the paper guide firmly against the edge of the paper stack.

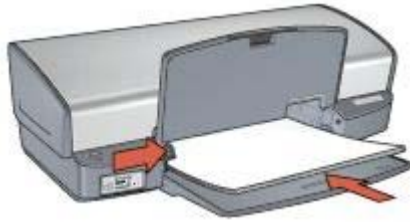

5. Lower the Out tray.

Print

1. Open the [Printer Properties](#) dialog box.
2. Click the **Printing Shortcuts** tab.
3. In the **What do you want to do?** drop-down list, click **General Everyday Printing** or **Fast/Economical Printing**, and then specify the following print settings:
 - **Paper Type: Plain paper**
 - **Paper Size:** An appropriate paper size
4. Click **OK**.

Use the [What's This? help](#) to learn about the features that appear in the Printer Properties dialog box.

Letters

To print a letter, use the Printing Shortcuts tab.

Guidelines

- Learn how to add a [watermark](#) to the letter.
- For help printing on an envelope, see [envelopes](#).
- Do not exceed the In tray capacity: 100 sheets of paper.

Prepare to print

1. Raise the Out tray.
2. Slide the paper guide all the way to the left.
3. Place the paper in the In tray, pushing the paper into the printer until it stops.



Note If you are using letterhead paper, verify that the letterhead is facing down and toward the interior of the printer.

4. Slide the paper guide firmly against the edge of the paper stack.

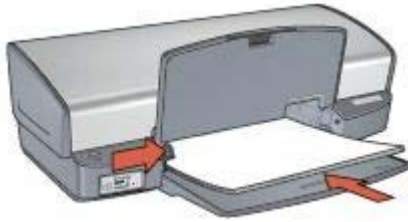

5. Lower the Out tray.

Print

1. Open the [Printer Properties](#) dialog box.
2. Click the **Printing Shortcuts** tab.
3. In the **What do you want to do?** drop-down list, click **Presentation Printing**, and then specify the following print settings:
 - **Paper Type: Plain paper**
 - **Paper Size:** An appropriate paper size
4. Select any other print settings that you want, and then click **OK**.

Use the [What's This? help](#) to learn about the features that appear in the Printer Properties dialog box.

Documents

To print a draft or final document, use the Printing Shortcuts tab.

Guidelines

- For draft documents, use [Fast/economical printing](#).
- Save paper with [two-sided printing](#).
- Learn how to add a [watermark](#) to the document.
- Do not exceed the In tray capacity: 100 sheets of paper.

Prepare to print

1. Raise the Out tray.
2. Slide the paper guide all the way to the left.
3. Place plain paper in the In tray, pushing the paper into the printer until it stops.
4. Slide the paper guide firmly against the edge of the paper stack.

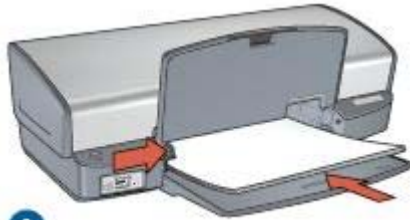

1 Letter or A4 paper



2 Legal paper (extends over the edge of the In tray)

5. Lower the Out tray.

Print

1. Open the [Printer Properties](#) box.
2. Click the **Printing Shortcuts** tab.
3. In the **What do you want to do?** drop-down list, click **General Everyday Printing**, and then specify the following print settings:
 - **Paper Type: Plain paper**
 - **Paper Size:** An appropriate paper size
4. Select the following print settings:
 - [Print Quality](#)
 - [Print On Both Sides](#) if you want to print on both sides of the paper
5. Select any other print settings that you want, and then click **OK**.

Use the [What's This? help](#) to learn about the features that appear in the Printer Properties dialog box.

Envelopes

To print envelopes, use the Paper/Quality tab. You can print a single envelope or multiple envelopes.

Guidelines

- Avoid using envelopes that have the following features:
 - Clasps or windows
 - Thick, irregular, or curled edges
 - Shiny or embossed coatings
 - Wrinkles, tears, or other damage
- Align the envelope edges before inserting the envelopes in the In tray.
- Do not exceed the In tray capacity: 10 envelopes.

Prepare to print

1. Raise the Out tray, and then remove all paper from the In tray.
2. Slide the paper guide all the way to the left.
3. Place the envelopes in the In tray, as far to the right as possible.
The side to be printed on should face down and the flap should be on the left.
4. Push the envelopes into the printer until they stop.
5. Slide the paper guide firmly against the edge of the envelope stack.



6. Lower the Out tray.

Print

1. Open the [Printer Properties](#) dialog box.
2. Click the **Paper/Quality** tab, and then select the following print settings:
 - **Size is:** An appropriate envelope size
 - **Type is: Plain paper**
3. Select any other print settings that you want, and then click **OK**.

Use the [What's This? help](#) to learn about the features that appear in the Printer Properties dialog box.

Brochures

To print a borderless brochure, use the Paper/Quality tab. To print a brochure with borders, use the Printing Shortcuts tab. For great results, use HP brochure paper.

Guidelines

- Do not print borderless documents in [ink-backup mode](#). Always have two print cartridges installed in the printer.
- Open the file in a software program and assign the brochure size. Ensure that the size corresponds to the paper size on which you want to print the brochure.
- Do not exceed the In tray capacity: 20 sheets of brochure paper.

Prepare to print

1. Raise the Out tray.
2. Slide the paper guide all the way to the left.
3. Place brochure paper in the In tray, pushing the paper into the printer until it stops.
4. Slide the paper guide firmly against the edge of the paper stack.

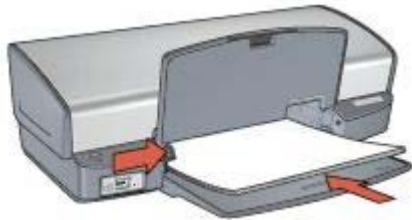

5. Lower the Out tray.

Print borderless brochures

1. Open the [Printer Properties](#) dialog box.
2. Click the **Paper/Quality** tab, and then specify the following print settings:
 - **Size is:** An appropriate paper size
 - **Type is:** Click **More**, and then select an appropriate brochure paper or other paper type.



Note Not all paper sizes and types are available for borderless printing.

3. Select the **Borderless Printing** check box.
4. Set the print quality to **Best**.
5. Click the **Finishing** tab, set the orientation, and then select **Print On Both Sides** to print on both sides of the paper.
For more information, see [Two-sided printing](#).
6. Click **OK** to print.

Use the [What's This? help](#) to learn about the features that appear in the Printer Properties dialog box.

Print brochures with borders

1. Open the [Printer Properties](#) dialog box.
2. Click the **Printing Shortcuts** tab.

3. In the **What do you want to do?** drop-down list, click **Presentation Printing**, and then specify the following print settings:
 - **Paper Type:** Click **More**, and then select an appropriate brochure paper.
 - **Paper Size:** An appropriate paper size
 - **Orientation:** **Portrait** or **Landscape**
 - **Print On Both Sides:** **Manually**For more information, see [Two-sided printing](#).
4. Click **OK** to print.

Use the [What's This? help](#) to learn about the features that appear in the Printer Properties dialog box.

Greeting cards

To print greeting cards, use the Paper/Quality tab. For great results, use HP Greeting Card Paper.

Guidelines

- Unfold prefolded cards, and then place them in the In tray.
- Do not exceed the In tray capacity: 20 cards.

Prepare to print

1. Raise the Out tray, and then remove all paper from the In tray.
2. Slide the paper guide all the way to the left.
3. Fan the edges of the greeting cards to separate them, and then align the edges.
4. Place the greeting cards in the In tray, with the side to be printed on facing down.
5. Push the cards into the printer until they stop.
6. Slide the paper guide firmly against the edge of the cards.



7. Lower the Out tray.

Print



Note If your software program includes a greeting card printing feature, follow the instructions that are provided with the software program. Otherwise, follow the instructions below.

1. Open the [Printer Properties](#) dialog box.

2. Click the **Paper/Quality** tab, and then specify the following print settings.
 - **Size is:** An appropriate card size
 - **Type is:** Click **More**, and then select an appropriate card type.
 - **Print Quality: Normal**
3. Select any other print settings that you want, and then click **OK**.

Use the [What's This? help](#) to learn about the features that appear in the Printer Properties dialog box.

Postcards

To print postcards, use the Paper/Quality tab.

Guidelines

- Use only cards that meet the paper size specifications for the printer. For specifications, see the reference guide that came with the printer.
- Do not exceed the In tray capacity: 30 cards.

Prepare to print

1. Raise the Out tray.
2. Slide the paper guide all the way to the left.
3. Place the cards in the In tray, as far to the right as possible.
The side to be printed on should face down and the short edge should point toward the printer.
4. Push the cards into the printer until they stop.
5. Slide the paper guide firmly against the edge of the cards.

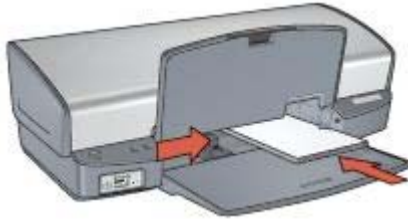

6. Lower the Out tray.

Print

1. Open the [Printer Properties](#) dialog box.
2. Click the **Paper/Quality** tab, and then specify the following print settings:
 - **Size is:** An appropriate card size
 - **Type is:** Click **More**, and then select an appropriate card type.
 - **Print Quality: Normal or Best**
3. Select any other print settings that you want, and then click **OK**.

Use the [What's This? help](#) to learn about the features that appear in the Printer Properties dialog box.

Transparencies

To print transparencies, use the Printing Shortcuts tab. For great results, use HP Premium Inkjet Transparency Film.

Guidelines

Do not exceed the In tray capacity: 30 transparencies.

Prepare to print

1. Raise the Out tray, and then remove all paper from the In tray.
2. Slide the paper guide all the way to the left.
3. Place the transparencies in the In tray.

The side to be printed on should face down and the adhesive strip should face up and toward the printer.

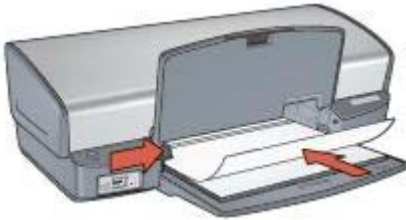

4. Carefully push the transparencies into the printer until they stop, so that none of the adhesive strips catch on one another.
5. Slide the paper guide firmly against the edge of the transparencies.
6. Lower the Out tray.

Print

1. Open the [Printer Properties](#) dialog box.
2. Click the **Printing Shortcuts** tab.
3. In the **What do you want to do?** drop-down list, click **Presentation Printing**, and then specify the following print settings:
 - **Paper Type:** Click **More**, and then select an appropriate transparency film.
 - **Paper Size:** An appropriate paper size
4. Select any other print settings that you want, and then click **OK**.

Use the [What's This? help](#) to learn about the features that appear on the Printer Properties dialog box.

Labels

To print labels, use the Printing Shortcuts tab. For great results, use HP Address Labels.

Guidelines

- Use only paper, plastic, or clear labels that are designed specifically for inkjet printers.
- Use only full sheets of labels.
- Avoid using labels that are sticky, wrinkled, or pulling away from the protective backing.
- Do not exceed the In tray capacity: 20 sheets of labels (use only Letter or A4-size sheets).

Prepare to print

1. Raise the Out tray, and then remove all paper from the In tray.
2. Slide the paper guide all the way to the left.
3. Fan the edges of the label sheets to separate them, and then align the edges.
4. Place the label sheets in the In tray with the label side facing down.
5. Push the sheets into the printer until they stop.
6. Slide the paper guide firmly against the edge of the sheets.

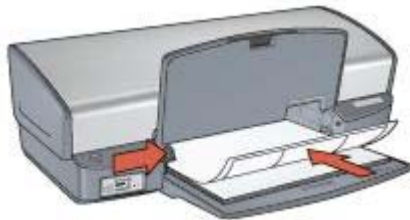

7. Lower the Out tray.

Print



Note If your software program includes a label printing feature, follow the instructions that are provided with the software program. Otherwise, follow the instructions below.

1. Open the [Printer Properties](#) dialog box.
2. Click the **Printing Shortcuts** tab.
3. In the **What do you want to do?** drop-down list, click **General Everyday Printing**, and then specify the following print settings:
 - **Paper Type: Plain paper**
 - **Paper Size:** An appropriate paper size
4. Click **OK**.

Use the [What's This help](#) to learn about the features that appear in the Printer Properties dialog box.

Index cards and other small media

To print index cards and other small media, use the Paper/Quality tab.

Guidelines

- Use only cards and small media that meet the paper size specifications for the printer. For specifications, see the reference guide that came with the printer.
- Do not exceed the In tray capacity: 30 cards.

Prepare to print

1. Raise the Out tray, and then remove all paper from the In tray.
2. Slide the paper guide all the way to the left.
3. Place the cards in the In tray, as far to the right as possible.
The side to be printed on should face down and the short edge should point toward the printer.
4. Push the cards into the printer until they stop.
5. Slide the paper guide firmly against the edge of the cards.

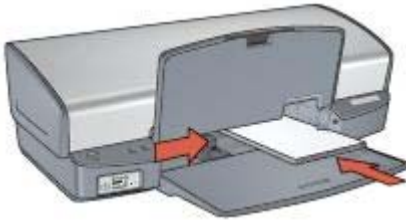

6. Lower the Out tray.

Print

1. Open the [Printer Properties](#) dialog box.
2. Click the **Paper/Quality** tab, and then specify the following print settings:
 - **Size is:** An appropriate card size
 - **Type is:** Click **More**, and then select an appropriate card type.
3. Select any other print settings that you want, and then click **OK**.

Use the [What's This? help](#) to learn about the features that appear on the Printer Properties dialog box.

Booklets

Booklet printing automatically arranges and resizes the pages of a document so that when the document is folded into a booklet, the page order is correct.

For example, when a four-page booklet is printed on both sides of the paper, the pages are reordered and printed like this:

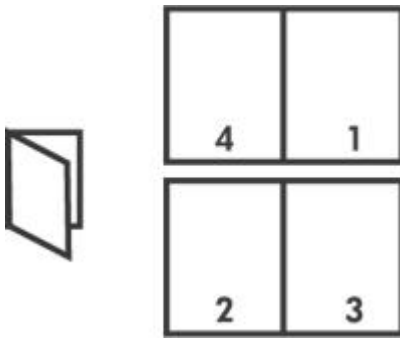

Guidelines

Do not exceed the In tray capacity: 100 sheets of paper.

Prepare to print

1. Raise the Out tray.
2. Slide the paper guide all the way to the left.
3. Place plain paper in the In tray, pushing the paper into the printer until it stops.
4. Slide the paper guide firmly against the edge of the paper stack.

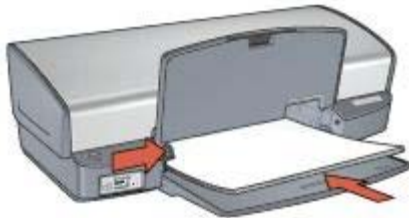

5. Lower the Out tray.

Print

1. Open the [Printer Properties](#) dialog box.
2. Click the **Printing Shortcuts** tab.
3. In the **What do you want to do?** drop-down list, click **Booklet Printing**.
4. In the **Print On Both Sides** drop-down list, click one of the following binding options:
 - **Left Edge Booklet**
 - **Right Edge Booklet**
5. Select any other print settings that you want, and then click **OK**.
6. When prompted, reload the printed pages in the In tray as shown below.

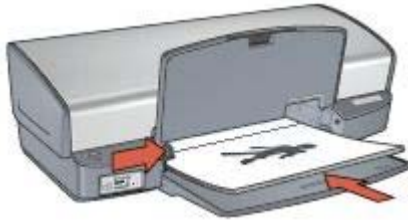

7. Click **Continue** to finish printing the booklet.

Use the [What's This? help](#) to learn about the features that appear in the Printer Properties dialog box.

Posters

For poster printing, sections of the poster are automatically arranged on individual sheets that can be taped together.

Guidelines

- After the sections of a poster have been printed, trim the edges of the sheets and tape the sheets together.



- Do not exceed the In tray capacity: 100 sheets of paper.

Prepare to print

1. Raise the Out tray.
2. Slide the paper guide all the way to the left.
3. Place plain paper in the In tray, pushing the paper into the printer until it stops.
4. Slide the paper guide firmly against the edge of the paper stack.

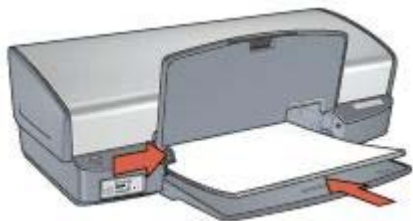

5. Lower the Out tray.

Print

1. Open the [Printer Properties](#) dialog box.
2. Click the **Paper/Quality** tab, and then specify the following print settings:
 - **Size is:** An appropriate paper size
 - **Type is: Plain paper**
3. Click the **Finishing** tab, and then specify the following print settings:
 - **Pages Per Sheet and Posters: Poster 2 x 2, Poster 3 x 3, Poster 4 x 4, or Poster 5 x 5**
 - **Orientation: Portrait or Landscape**
4. Select any other print settings that you want, and then click **OK**.

Use the [What's This? help](#) to learn about the features that appear in the Printer Properties dialog box.

Iron-on transfers

When printing iron-on transfers, use HP Iron-on Transfers for great results.

Guidelines

- When printing a mirror image, the text and the pictures are horizontally reversed from what appears on the computer screen.

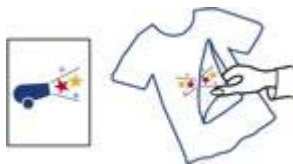

- Do not exceed the In tray capacity: 12 iron-on transfers.

Prepare to print

1. Raise the Out tray, and then remove all paper from the In tray.
2. Slide the paper guide all the way to the left.
3. Place the iron-on transfer paper in the In tray, with the side to be printed on facing down.
4. Push the paper into the printer until it stops.

5. Slide the paper guide firmly against the edge of the paper stack.

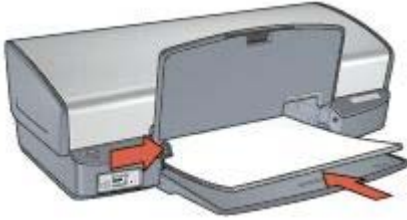

6. Lower the Out tray.

Print



Note If your software program includes an iron-on transfer printing feature, follow the instructions that are provided with the software program. Otherwise, follow the instructions below.

1. Open the [Printer Properties](#) dialog box.
2. Click the **Paper/Quality** tab, and then specify the following print settings:
 - **Size is:** An appropriate paper size
 - **Type is:** Click **More**, and then select **HP Iron-on Transfer**.
 - **Print Quality:** **Normal** or **Best**
3. Click the **Advanced** tab.
4. Click **Printer Features**, and then specify the following print setting:
Mirror Image: On



Note Some iron-on transfer software programs do not require you to print a mirror image.

5. Select any other print settings that you want, and then click **OK**.

Use the [What's This? help](#) to learn about the features that appear in the Printer Properties dialog box.

8 Printing tips

Save time

- Use the [Printing Shortcuts](#) tab.
- Set printer [default settings](#) for options that you often use.
- Create [print task quick sets](#) for documents that you often print.
- Set the [order](#) that the pages print.

Save money

- Use [Fast/economical printing](#).
- Print [multiple pages on a single sheet of paper](#).
- Print a [two-sided document](#).
- Use [HP Everyday Photo Paper](#) to save money and ink when printing photos.

Enhance the quality of printouts

- [Preview](#) the document before printing it.
- Print on a [custom paper size](#).
- Select the correct [paper type](#).
- Select the correct [print quality](#).
- [Resize](#) the document as needed.
- Add a [watermark](#).

Printing shortcuts

The Printing Shortcuts tab makes it easy to set the printing options for the documents that you want to print.

Use the Printing Shortcuts tab for the following print tasks:

- [General everyday printing](#)
- [Photo printing—borderless](#)
- [Photo printing—with white borders](#)
- [Fast/economical printing](#)
- [Presentation printing](#)
- [Two-sided, duplex, printing](#)

Fast/economical printing

Use Fast/economical printing to produce draft-quality printouts quickly.

Follow these steps to use Fast/economical printing:

1. Open the [Printer Properties](#) dialog box.
2. Click the **Printing Shortcuts** tab.
3. In the **What do you want to do?** drop-down list, click **Fast/Economical Printing**.
4. Specify the print settings that you want.
5. Click **OK**.

Use the [What's This? help](#) to learn about the features you see on the Printer Properties dialog box.

General everyday printing

Use General everyday printing to print documents quickly.

- Documents
- E-mail

Presentation printing

Use Presentation printing to print high-quality documents, including:

- Letters
- Brochures
- Transparencies

Print in grayscale

Follow these steps to print in grayscale:

1. Open the [Printer Properties](#) dialog box.
2. Click the **Printing Shortcuts** tab.
3. In the **What do you want to do?** drop-down list, click **Fast/Economical Printing**.
4. In the **Color Option** drop-down list, click one of the following:
 - **Print in high quality grayscale:** Use this option for photos and other high-quality printouts.
 - **Print in black-only grayscale:** Use this option for fast, economical printing.
5. Select any other print settings that you want, and then click **OK**.

Set default settings for the printer

The printer uses the default settings for all documents printed unless you open the [Printer Properties](#) dialog box and specify other settings.

To save time when printing, set the printer default settings to options that you use often. That way, you do not have to specify the options every time you use the printer.

Follow these steps to change the default settings:

1. Click the task tray icon.



1 | Task tray icon

The Printer Properties dialog box appears.

2. Select the options that you want to use as the default settings.
3. Click **OK**.

A dialog box appears stating that the new settings will be used every time you print. If you do not want to see this dialog box again, select the **Don't show me this message again** check box.

4. Click **OK** to save the new default print settings.

Select a print quality

Follow these steps to select a print quality:

1. Open the [Printer Properties](#) dialog box.
2. Click the **Printing Shortcuts** tab.
3. Click one of the following options in the **Print quality** drop-down list:
 - **FastDraft**: Prints at the fastest printing speed while using the least amount of ink.
 - **Fast Normal**: Prints more quickly than Normal mode and at a higher print quality than FastDraft.
 - **Normal**: Provides the best balance between print quality and speed. This is the appropriate setting for most documents.
 - **Best**: Provides high-quality printing.
 - **Maximum dpi**: Provides the highest quality printing, but requires longer to print than **Best** and requires a large amount of disk space.



Note **Maximum dpi** is available on the **Paper/Quality** tab.



Note The print quality options that are available on the **Printing Shortcuts** tab vary depending on the type of document that you are printing.

Set the page order

The page order determines the order in which your multipage documents print.

To set the page order, follow these steps:

1. Open the [Printer Properties](#) dialog box.
2. Click the **Advanced** tab.
3. Click **Document Options**, and then click **Layout Options**.
4. Click one of the following **Page Order** options:
 - **Front to back:** Prints the first page of the document last. This setting saves time because you do not have to reorder the printed pages. It is the appropriate setting for most print jobs.
 - **Back to front:** Prints the last page of the document last.
5. Select any other print settings that you want, and then click **OK**.

Print multiple pages on a single sheet of paper

Use the printer software to print multiple pages of a document on a single sheet of paper. The printer software automatically resizes the document text and images to fit on the printed page.

Follow these steps to print multiple pages of a document on a single sheet of paper:

1. Open the [Printer Properties](#) dialog box.
2. Click the **Finishing** tab.
3. In the **Pages Per Sheet and Posters** drop-down list, click the number of pages that you want to appear on each sheet of paper.
4. If you want a border to appear around each page image that is printed on the sheet of paper, select the **Print Page Borders** check box.
5. In the **Page Order Is** drop-down list, click a layout for each sheet of paper.
6. Select any other print settings that you want, and then click **OK**.

Print preview

Use the print preview function to view a printout on your computer before printing a document. If the printout does not look correct, you can cancel the print job and adjust the print settings as needed.

To preview a printed document, follow these steps:

1. Open the [Printer Properties](#) dialog box.
2. Click the **Effects** tab.
3. Select the **Show print preview** check box.
4. Select any other print settings that you want, and then click **OK**.

Before the document prints, a preview appears.

5. Do one of the following:
 - Click **File** and then click **Print to HP Deskjet** to print the document.
 - Click **File** and then click **Cancel Printing** to cancel the print job. Adjust the print settings as needed before trying to print the document again.

Set a custom paper size

Use the Custom paper size dialog box to print on a special paper size.



Note This feature is not available for all paper types.

Follow these steps to define a custom paper size:

1. Open the [Printer Properties](#) dialog box.
2. Click the **Paper/Quality** tab.
3. Click the **Custom** button.
The Custom paper size dialog box appears.
4. In the **Name** drop-down list, click a custom paper size name.
5. Type the paper dimensions in the **Width** and **Length** boxes.
The minimum and maximum dimensions appear beneath each of the boxes.
6. Click the unit of measurement: **Inches** or **Millimeters**.
7. Click **Save** to save the custom paper size.
8. Click **OK** to exit the Custom Paper Size dialog box.

Select a paper type

When printing a higher-quality document, HP recommends that you select a specific paper type.

Follow these steps to select a specific paper type:

1. Open the [Printer Properties](#) dialog box.
2. Click the **Printing Shortcuts** tab.
3. In the **Paper type** drop-down list, click an appropriate paper type.
4. Select any other print settings that you want, and then click **OK**.

Print task quick sets

Use print task quick sets to print with or save print settings that you use often.

If you frequently print on envelopes, for example, you can create a print task that contains the paper size, print quality, and orientation setting that you normally use for envelopes. After creating the print task, simply select it when printing on envelopes rather than setting each of the print settings separately.



Note The printer software can save up to 25 print task quick sets.

Create your own print task or use the specially designed print tasks that are available in the Print Task Quick Sets drop-down list.

Use a print task quick set

Follow these steps to use a print task quick set:

1. Open the [Printer Properties](#) dialog box.
A Print Task Quick Sets drop-down list appears at the top of most tabs.
2. Go to **Print Task Quick Sets** on any tab where it appears.
3. In the drop-down list, click the print task that you want to use.
4. Click **OK**.



Note To restore default print settings, click **Default Print Settings** in the **Print Task Quick Sets** drop-down list, and then click **OK**.

Create a print task quick set

Follow these steps to create a print task quick set:

1. Open the [Printer Properties](#) dialog box.
2. Select the options that you want to include in the new print task.
3. Go to **Print Task Quick Sets** on any tab where it appears.
4. Type a name for the new print task in the **Print Task Quick Sets** drop-down list, and then click **Save**.
The print task quick set is added to the drop-down list.



Note If you add more options to the print task, rename the print task and then click **OK**.

Delete a print task quick set

Follow these steps to delete a print task quick set:

1. Open the [Printer Properties](#) dialog box.
A Print Task Quick Sets drop-down list appears at the top of most tabs.
2. Go to **Print Task Quick Sets** on any tab where it appears.
3. In the drop-down list, click the print task that you want to delete and then click **Delete**.



Note Some print task quick sets cannot be deleted.

Two-sided printing

Use two-sided printing, also called *duplexing*, to print on both sides of the paper. Printing on both sides of the paper is not only economical, but environmentally conscious as well.

Print a two-sided document

To print a two-sided document, follow these steps:

1. Open the [Printer Properties](#) dialog box.
2. Click the **Printing Shortcuts** tab.
3. In the **What do you want to do?** drop-down list, click **Two-sided (Duplex) Printing**.

4. In the **Print On Both Sides** drop-down list, click **Manually**.
5. Select any other print settings that you want, and then click **OK**.
The printer prints the odd-numbered pages first.
6. After the odd-numbered pages have been printed, reload the printed pages with the printed side facing up.



7. Click **Continue** to print the even-numbered pages.

Create a bound two-sided document

Select the type of binding that you want for the two-sided document, and then follow the steps for that binding.



Book binding



Tablet binding



Note Book binding is the most common type of binding.

Book binding

Follow these steps to print a two-sided document with a book binding:

1. Open the [Printer Properties](#) dialog box.
2. Click the **Printing Shortcuts** tab.
3. In the **What do you want to do?** drop-down list, click **Two-sided (Duplex) Printing**.
4. In the **Print On Both Sides** drop-down list, click **Manually**.
5. Select any other print settings that you want, and then click **OK**.
The printer prints the odd-numbered pages first.
6. After the odd-numbered pages have been printed, reload the printed pages with the printed side facing up.



7. Click **Continue** to print the even-numbered pages.

Tablet binding

Follow these steps to print a two-sided document with a tablet binding:

1. Open the [Printer Properties](#) dialog box.
2. Click the **Finishing** tab.
3. Select the following check boxes:
 - **Print On Both Sides (Manually)**
 - **Preserve Layout**
 - **Flip Pages Up**
4. Select any other print settings that you want, and then click **OK**.
The printer prints the odd-numbered pages first.
5. After the odd-numbered pages have been printed, reload the printed pages, with the printed side facing up according to the document orientation, portrait or landscape.



Portrait



Landscape

6. Click **Continue** to print the even-numbered pages.

Resize a document

Use the printer software for either of these tasks:

- Print a document on a paper size different from the size for which it is formatted.
- Shrink or enlarge text and graphics on the printed page.

Print on a different paper size

Use this feature to print a document that is formatted for one paper size on another paper size. Doing this can be useful if you do not have the correct paper size available.

For example, if you have created a document that is formatted for letter-size paper, but you do not have any letter-size paper available, you can print the document on another paper size that is available.

Follow these steps to resize the document for a different paper size:

1. Open the [Printer Properties](#) dialog box.
2. Click the **Effects** tab.
3. Select the **Print document on** check box, and then click the target paper size in the drop-down list.
The target paper size is the size of the paper on which you are printing, not the size for which the document was formatted.
4. Do one of the following:

Objective	Action
Shrink or enlarge the document to fit on the target paper size.	Select the Scale to fit check box.
Print the document at its original size on the selected paper size.	Do not select the Scale to fit check box.

5. Select any other print settings that you want, and then click **OK**.

Shrink or enlarge text and graphics

Use this feature to shrink or enlarge printed text and graphics without changing the paper size.

Follow these steps to shrink or enlarge text and graphics:

1. Open the [Printer Properties](#) dialog box.
2. Click the **Effects** tab.
3. In the **% of normal size** box, type the percentage by which you want to shrink or enlarge the text and graphics.
One hundred percent represents the actual size of the text and graphics. Type a number less than 100 to shrink the text and graphics. Type a number greater than 100 to enlarge the text and graphics.
4. Select any other print settings that you want, and then click **OK**.

Watermarks

Watermarks appear as background printing on documents.

Apply an existing watermark

Follow these steps to apply an existing watermark to a document:

1. Open the [Printer Properties](#) dialog box.
2. Click the **Effects** tab.
3. Click a watermark in the **Watermarks** drop-down list.
If you do not want to use one of the listed watermarks, [create a new watermark](#).
4. Choose one of the following actions:
 - If you want the watermark to appear on the first page only, select the **First page only** check box.
 - If you want the watermark to appear on all printed pages, leave the **First page only** check box clear.
5. Print the document according to the instructions for the paper type.

Create or change a watermark

Follow these steps to create or change a watermark:

1. Open the [Printer Properties](#) dialog box.
2. Click the **Effects** tab.
3. Click the **Edit** button.
The Watermark Details dialog box appears.
4. Choose one of the following actions:
 - Click the **New** button.
 - Select an existing watermark to change.
5. Type the watermark message, and then select the message angle and the font attributes.
6. After you have set the watermark details, click **OK**.

For instructions about applying watermarks, follow the steps for [applying an existing watermark to a document](#).

Use the [What's This? help](#) to learn about the features that you see on the Printer Properties dialog box.

9 Printer software

- Use the [Printer Properties](#) dialog box to select printing options.
- Use the [What's This? help](#) to learn more about specific print settings.
- View the [Ink Status window](#) for the approximate ink level of each print cartridge.
- Download [printer software updates](#) for the latest features and improvements.

Printer Properties dialog box

The printer is controlled by software that is installed on your computer. Use the printer software, also known as the *printer driver*, to change the print settings for a document.

To change the print settings, open the Printer Properties dialog box.



Note The Printer Properties dialog box is also referred to as the Printing Preferences dialog box.

Open the Printer Properties dialog box

Follow these steps to open the Printer Properties dialog box:

1. Open the file that you want to print.
2. Click **File**, then click **Print**, and then click **Properties** or **Preferences**.

The Printer Properties dialog box appears.



Note The path to the Printer Properties dialog box can vary depending on the software program you are using.

What's This? help

Use the [What's This? help](#) to learn about the features that you see on the Printer Properties dialog box.

What's This? help

Use What's This? help to learn more about the available printing options.

1. Move the cursor over the feature that you want to learn more about.
2. Click the right mouse button.
The What's This box appears.
3. Move the cursor over the **What's This?** box, and then click the left mouse button.
An explanation of the feature appears.

Ink Status window

The Ink Status window appears each time the printer prints a file. The window displays the approximate ink level of each print cartridge. To close the Ink Status window, click **Close**.



Note This feature might not be available in your operating environment.

Print cartridge information and ordering

For print cartridge information and to link to HP's Web site for ordering print cartridges, click the **Print Cartridge Information** button.

Displaying the Ink Status window

If you do not want the Ink Status window to appear when you print, select the **Do not show this again** check box in the lower-left corner of the window.

If you previously chose not to show the Ink Status window but now want it to appear when you print, follow these steps:

1. For Windows 2000, click **Start**, and then click **Settings**. For Windows XP, click **Start**, and then click **Printers and Faxes**.
A list that includes the printers installed on your computer appears.
2. Highlight the printer name, and then right-click to display a list of options.
3. Click **Properties**.
The Printer Properties dialog box appears.
4. Click the **Device Settings** tab.
5. For **Display Ink Status Window**, click **On**, and then click **OK**.

Download printer software updates

Download the latest printer software update every few months to ensure you have the latest features and improvements:

1. Make sure you are connected to the Internet.
2. For Windows 2000, click **Start**, click **Programs**, click **HP**, and then click **HP Software Update**. For Windows XP, click **Start**, click **All Programs**, click **HP**, and then click **HP Software Update**.
The HP Software Update window appears.
3. Click **Next**.
HP Software Update searches the HP Web site for printer software updates.
 - If the computer has the most recent version of the printer software installed, **No updates are available for your system at this time** appears in the HP Software Update window.
 - If the computer does not have the most recent version of the printer software installed, a software update appears in the HP Software Update window.
4. If a software update is available, select the check box beside the update name.
5. Click **Install**.
6. Follow the onscreen instructions.

Download HP Image Zone software

Installing the printer software update you download from the HP Web site does not update the HP Image Zone software you might have installed on the computer. For information about updating the HP Image Zone software, see the HP Image Zone Help.

10 Maintenance

- Install print cartridges
- Set the auto-off feature
- Align the print cartridges
- Calibrate color
- Calibrate print quality
- Automatically clean print cartridges
- Print a test page
- View estimated ink levels
- Maintain the printer body
- Remove ink from your skin and clothing
- Manually clean print cartridges
- Maintain print cartridges
- Printer Toolbox

Install print cartridges

When you need to replace print cartridges, make sure you have the correct print cartridges for your printer, and then install them in the print cartridge cradle.

Print cartridge combinations

For printing most documents, use the tri-color print cartridge and the black print cartridge. When printing photos, use the photo print cartridge along with the tri-color print cartridge.

Always install the tri-color print cartridge in the left side of the print cartridge cradle.

Install the black or photo print cartridge in the right side of the print cartridge cradle.



Note To easily identify the correct side of the cradle in which to install the print cartridge, match the symbol on the print cartridge with the symbol above the print cartridge cradle.

Selection numbers

When buying replacement print cartridges, look for the print cartridge selection number.

You can find the selection number in three places:

- Selection number label: Look at the label on the print cartridge that you are replacing.



1	Selection number label
---	------------------------

- Printer documentation: For a list of print cartridge selection numbers, see the reference guide that came with the printer.
- Print Cartridge Information dialog box: For a list of print cartridge selection numbers, open the printer **Toolbox**, click the **Estimated Ink Level** tab, and then click the **Print Cartridge Information** button.



Note This feature might not be available in your operating environment.

Ink-backup mode

The printer can operate with only one print cartridge installed. For more information, see [Ink-backup mode](#).

Installation instructions

Follow these steps to install a print cartridge:

1. Verify that the printer is turned on.
2. Load Letter or A4 plain, white paper in the In tray.
3. Open the printer cover.
4. Wait until the print cartridge cradle moves to the right side of the printer and is idle and quiet.
5. Press down on the print cartridge, and then slide it out of the print cartridge cradle.

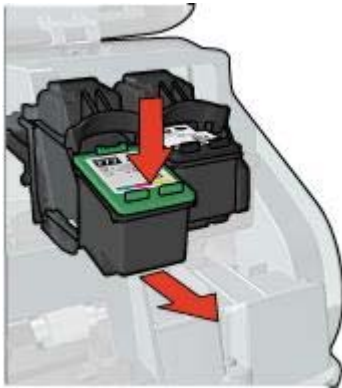

6. Remove the replacement print cartridge from its packaging and carefully remove the plastic tape. Hold the print cartridge so that the copper strips are on the bottom and facing toward the printer.

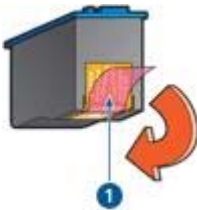

1	Remove plastic tape
---	---------------------

⚠ Caution Do not touch the print cartridge ink nozzles or copper contacts. Touching these parts will result in clogs, ink failure, and bad electrical connections. Do not remove the copper strips. They are required electrical contacts.

7. Slide the print cartridge at a slight upward angle into the cradle until the cartridge snaps into place.

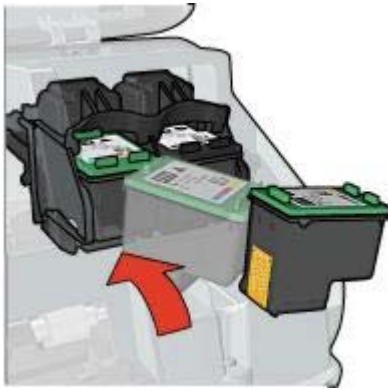

8. Close the printer cover.
Align the print cartridges for optimum print quality.

For information about storing print cartridges, see [Maintain print cartridges](#).

For information about recycling empty print cartridges, see [Print cartridge recovery](#).



Warning Keep both new and used print cartridges out of the reach of children.

Set the auto-off feature

Select the auto-off feature to automatically place the printer into idle mode after 30 minutes and to turn back on automatically when print jobs are sent to the printer. Selecting auto-off cancels the [FEMP](#) energy savings mode.

Follow these steps to activate the auto-off feature:

1. For Windows 2000, click **Start**, click **Settings**, and then click **Printers**. For Windows XP, click **Start**, and then click **Printers and Faxes**.
A list that includes the printers installed on your computer appears.
2. Highlight the printer name, and then right-click to display a list of options.
3. Click **Properties**.
The Printer Properties dialog box appears.
4. Click the **Device Settings** tab.
5. Select **Activate the Hardware Auto-off feature**, click **On**, and then click **OK**.



Note This feature might not be available in your operating environment.

Align the print cartridges

After installing a print cartridge, align the print cartridges to ensure the best print quality.

To align print cartridges:

1. Load Letter or A4 plain, white paper in the In tray.
2. Open the printer [Toolbox](#).
3. Click **Align the Print Cartridges**.

4. Click **Align**, and then follow the onscreen instructions.



Note This feature might not be available in your operating environment.

Calibrate color

Perform a color calibration if the colors in photos that are printed with the [photo print cartridge](#) consistently look incorrect.

Before performing a color calibration, [align the print cartridges](#), and then reprint the photo. If the color is still incorrect, perform a color calibration.

To calibrate color:

1. Load Letter or A4 plain, white paper in the In tray.
2. Verify that both a tri-color print cartridge and a [photo print cartridge](#) are installed in the printer.
3. Open the printer [Toolbox](#).
4. Click **Calibrate Color**.
5. Click **Start**, and then follow the onscreen instructions.



Note This feature might not be available in your operating environment.

Calibrate print quality

Perform a print quality calibration if light or dark horizontal lines appear in documents that are printed with the tri-color and black print cartridges.

Before performing a print quality calibration, [clean the print cartridges](#), and then reprint the document. If the lines still occur, perform a print quality calibration.

Follow these steps to calibrate print quality:

1. Load Letter or A4 plain, white paper in the In tray.
2. Verify that both a black and a tri-color [print cartridge](#) are installed in the printer.
3. Open the printer [Toolbox](#).
4. Click **Print Quality Calibration**.
5. Click **Continue**, and then follow the onscreen instructions.



Note This feature might not be available in your operating environment.

Automatically clean print cartridges

If your printed pages are missing lines or dots, or if they contain ink streaks, the print cartridges might be [low on ink](#) or might need to be cleaned.

If the print cartridges are not low on ink, follow these steps to clean the print cartridges automatically:

1. Open the printer [Toolbox](#).
2. Click **Clean the Print Cartridges**.
3. Click **Clean**, and then follow the onscreen instructions.

If your documents are still missing lines or dots after cleaning, [replace the print cartridges](#).



Caution Clean print cartridges only when necessary. Unnecessary cleaning wastes ink and shortens the life of the cartridge.



Note This feature might not be available in your operating environment.

Print a test page

Follow these instructions to print a test page:

1. Open the printer [Toolbox](#).
2. Click the **Print a Test Page** button, and then follow the onscreen instructions.



Note This feature might not be available in your operating environment.

View estimated ink levels

Follow these instructions to view the estimated ink levels of the print cartridges that are installed in the printer:

1. Open the printer [Toolbox](#).
2. Click the **Estimated Ink Level** tab.



Note If the print cartridges were used before being installed in the printer, the estimated ink levels will not appear on the Estimated Ink Level tab.

The Estimated Ink Level tab also contains print cartridge ordering information. To view this information, click the **Print Cartridge Information** button.



Note This feature might not be available in your operating environment.

Maintain the printer body

Because the printer ejects ink onto the paper in a fine mist, ink smudges will eventually appear on the printer case and adjacent surfaces. To remove smudges, stains, or dried ink from the exterior of the printer, use a soft cloth moistened with water.

When cleaning the printer, keep these tips in mind:

- *Do not* clean the interior of the printer. Keep all fluids away from the interior.
- *Do not* use household cleaners or detergent. If a household cleaner or detergent has been used on the printer, wipe the exterior surfaces with a soft cloth moistened with water.
- *Do not* lubricate the support rod that the print cartridge cradle uses to slide back and forth. Noise is normal when the cradle moves back and forth.

Remove ink from your skin and clothing

Follow these instructions to remove ink from your skin and clothing:

Surface	Remedy
Skin	Wash the area with an abrasive soap.
White fabric	Wash the fabric in <i>cold</i> water and use chlorine bleach.
Color fabric	Wash the fabric in <i>cold</i> water and use sudsy ammonia.



Caution Always use cold water to remove ink from fabric. Warm or hot water can set the ink into the fabric.

Manually clean print cartridges

If the printer is used in a dusty environment, a small amount of debris can accumulate on the print cartridge contacts.

Gather cleaning supplies

You will need the following items to clean the print cartridges.

- Distilled water (tap water can contain contaminants that can damage the print cartridge)
- Cotton swabs or other soft, lint-free material that will not stick to the print cartridge

Be careful not to get **ink on your hands or clothing** as you clean.

Prepare to clean

1. Open the printer cover.
2. Wait until the print cartridge cradle moves to the right side of the printer and is idle and quiet.
3. Remove the print cartridges and place them on a piece of paper, with the copper strips facing up.



Caution Do not leave the print cartridges outside the printer for more than 30 minutes.

Cleaning instructions

1. Lightly moisten a cotton swab with distilled water and squeeze any excess water from the swab.
2. Wipe the print cartridge copper contacts with the cotton swab.



Caution Do not touch the print cartridge ink nozzles. Touching the ink nozzles will result in clogs, ink failure, and bad electrical connections.



1	Ink nozzles (do not touch)
2	Copper contacts

3. Repeat this process until no ink residue or dust appears on the swab.
4. [Insert the print cartridges](#) in the printer, and then close the printer cover.

Maintain print cartridges

The following tips will help maintain HP print cartridges and ensure consistent print quality:

- Keep all print cartridges in their sealed packages until they are needed. Print cartridges should be stored at room temperatures (15° to 35° C or 59° to 95° F).
- Do not remove the plastic tape covering the ink nozzles until you are ready to install the print cartridge in the printer. If the plastic tape has been removed from the print cartridge, do not attempt to reattach it. Reattaching the tape damages the print cartridge.

Follow these instructions to [store print cartridges](#).

Store print cartridges

When print cartridges are removed from the printer, store them in an airtight plastic container or in the print cartridge protector that comes with the photo print cartridge.

If you store the print cartridge in an airtight plastic container, make sure that the ink nozzles are face down but are not in contact with the container.

Insert the print cartridge into the print cartridge protector

Slide the print cartridge at a slight angle into the protector, and snap it securely in place.



Remove the print cartridge from the print cartridge protector

Press down and back on the top of the protector to release the print cartridge. Slide the print cartridge out of the protector.



Caution Do not drop the print cartridge. Dropping the print cartridge can damage it.

Printer Toolbox

The printer Toolbox contains a number of useful tools to enhance the performance of the printer.

Use the printer Toolbox to perform the following tasks:

- Set the auto-off function
- Align the print cartridges
- Calibrate color
- Calibrate print quality
- Clean the print cartridges
- Print a test page
- View estimated ink levels

Use the Toolbox

Follow these instructions to use the printer Toolbox:

1. Open the [Printer Properties](#) dialog box.
2. Click the **Services** tab, and then click the **Service this device** button.



Note This feature might not be available in your operating environment.

11 Troubleshooting

- Printer does not print
- Paper jam
- Paper problems
- Printer is stalled
- Print cartridge problems
- Photos do not print correctly
- PictBridge problems
- Print quality is poor
- Document is misprinted
- Problems with borderless documents
- Error messages
- Printer lights are on or flashing
- Document prints slowly
- If you continue to have problems

Printer does not print

Verify the following

Verify the following conditions if the printer is not printing:

- The printer is connected to the power source.
- The cable connections are secure.
- The printer is turned on.
- The print cartridges are the [correct print cartridges](#) for the printer and are [properly installed](#).
- The paper or other media is correctly loaded in the In tray.
- The printer cover is closed.
- The rear access door is attached.

Check the printer lights

The printer lights indicate the printer status and alert you to potential problems.

For more information, see [Printer lights are on or flashing](#).

Check the printer cable connection

If the printer cable is attached to a USB hub, a printing conflict might exist. Two methods are available for solving the conflict:

- Attach the printer USB cable directly to your computer.
- When printing, do not use other USB devices that are attached to the hub.

Check the print queue

The printer will not print if a print job is stalled in the print queue. To resolve a print job that is stalled in the queue, complete the following steps:

1. For Windows 2000, click **Start**, click **Settings**, and then click **Printers**. For Windows XP, click **Start**, and then click **Printers and Faxes**.
2. Double-click the name of the HP Deskjet printer.
3. Click the **Printer** menu, and then click **Pause Printing**.
4. Click the **Printer** menu again, and then click **Cancel all documents**.
5. Click **Yes**.
6. Click the **Printer** menu, and then click **Resume Printing**.
7. If there are still documents in the list, restart the computer.
8. After restarting, if there are still documents in the list, repeat steps 1–6.

If the printer still does not print

1. Select the topic below that best describes the problem:
 - [Paper jam](#)
 - [Out-of-paper message](#)
 - [Printer ejects paper](#)
 - [Printer is stalled](#)
2. If the printer still does not print, shut down, and then restart your computer.

Paper jam

Follow these steps to remove a paper jam:

1. Press the [Resume](#) button.
If the paper jam does not clear, then go to the next step.
2. Turn off the printer.
3. Remove the rear access door. Press the handle to the right, and then pull out the door.

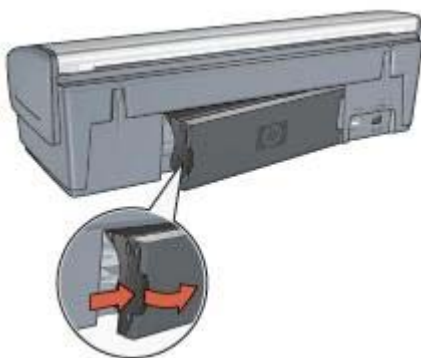

4. Remove any paper that is inside the printer by pulling it out from the back of the printer.

If you are printing labels, verify that a label did not become detached from the label sheet while passing through the printer.

5. Replace the rear access door securely.



6. If the paper jam cannot be removed from the back of the printer, raise the printer cover, remove the paper jam from the front of the printer, and then lower the cover.



Caution Remove the paper jam carefully as it is possible to damage the printer when removing paper from the front.

7. Turn on the printer, and then press the **Resume** button.
8. Reprint the document.



Note If paper jams occur frequently, try using a heavier paper. See the reference guide for paper weight specifications.

Paper problems

Printer does not feed paper

Try one or more of the following solutions:

- Reduce the number of sheets in the In tray.
- Remove the paper from the In tray, and then reload it.
- Use a different type of paper.

Printer ejects paper

If the printer ejects the paper, try one of the following solutions:

- If you are performing a [color calibration](#), install both the tri-color and the photo print cartridges.
- Verify that the protective piece of plastic tape has been removed from the print cartridges.
- If you are printing a borderless document and the Resume light and a Print Cartridge Status light are flashing, you might be trying to print a borderless document with only the black print cartridge installed. When printing a borderless document, always have the tri-color print cartridge and a black or photo print cartridge installed.

Out-of-paper message

If an out-of-paper message appears, follow these [guidelines](#).

Paper jam

For information about clearing a paper jam, see the [paper jam](#) page.

Printer prints on multiple sheets at once

If the printer prints on multiple sheets at once, follow these [guidelines](#).

Printer prints on multiple sheets at once

If the printer prints on multiple sheets at once, check the following:

Paper weight

The printer might print on multiple sheets of paper at once if the paper is under the recommended paper weight. Use paper that is within the recommended specifications. For paper weight specifications, see the reference guide that came with the printer.

Paper might be loaded improperly

The printer might print on multiple sheets of paper at once if the paper is loaded too far toward the back of the printer or if the paper guide is not positioned firmly against the paper. Reload the paper into the In tray, pushing the paper until you feel resistance, and then slide the paper guide firmly against the edge of the paper stack.

The printer might also print on multiple sheets at once if different paper types are loaded in the In tray. For example, photo paper might be mixed with plain paper. Empty the In tray and load only the paper type that is appropriate for the document that you are printing.

Printer is stalled

If the printer stalls while printing a document, press the **Resume** button. If the printer does not start printing again, raise the printer cover, and then disconnect the power cable from the back of the printer.



Caution First, check for any loose or broken parts in the printer. If you find loose or broken parts, go to www.hp.com/support or contact HP. Support phone numbers are listed in the reference guide that came with the printer or at www.hp.com/support.

If there are no loose or broken parts, follow these steps:

1. Check for and remove any obstacles, such as packing tape or materials, that prevent the print cartridges from moving back and forth.
2. Make sure the print cartridges are [installed](#) securely in the print cartridge cradle.
3. Make sure the tri-color print cartridge is [installed](#) in the left side of the cradle and the black or photo print cartridge is installed in the right side of the cradle.
4. Check for and clear any [paper jam](#).
5. Lower the printer cover.
6. Connect the power cable to the back of the printer, and then turn on the printer.
 - If the Resume light is not flashing, continue printing the document.
 - If the Resume light is flashing, press the **Resume** button.

If the light still flashes, repeat the steps.

Print cartridge problems

Incorrect print cartridge

The printer can only print when the correct print cartridges are installed. If you receive a print cartridge error message, one or both of the print cartridges cannot be used in the printer.

To verify that you have the correct print cartridges:

1. Open the printer cover.
2. Read the selection number on the print cartridge label.



1	Selection number label
2	Warranty date

3. Check the list of print cartridges that can be used in the printer.
 - a. Open the printer [Toolbox](#).
 - b. Click the **Estimated Ink Level** tab.
 - c. Click the **Print Cartridge Information** button and view the list of print cartridge selection numbers.

The reference guide that came with the printer also shows the print cartridge selection numbers.
4. Check the warranty date on the print cartridge.
5. If the print cartridge has the wrong selection number, or if the warranty date has expired, [install a new print cartridge](#).
6. Close the printer cover.

If the Resume light is not flashing, then the problem is solved.

If the Resume light is flashing, visit HP Technical Support at www.hp.com/support.

Print cartridge problem message

If you receive a message about a problem with one of the print cartridges, follow these steps:

1. Raise the printer cover and remove the print cartridge that was named in the error message.
2. [Reinstall](#) the print cartridge.

If the Resume light is not flashing, the problem is solved.

If the Resume light is flashing, go to the next step.

3. **Manually clean** the print cartridge.
4. Reinsert the print cartridge in the printer and close the printer cover.
If the Resume light is still flashing, the print cartridge is faulty and must be **replaced**.



Note You can print with one print cartridge in **ink-backup mode** if you do not have a replacement print cartridge available.

5. If the Resume light continues to flash after replacing the print cartridge, visit HP Technical Support at www.hp.com/support.

"Printing in ink-backup mode" message

When the printer detects that only one print cartridge is installed, ink-backup mode is initiated. This printing mode lets you print with a single print cartridge, but it slows the printer and affects the quality of printouts.

If you receive the ink-backup mode message and two print cartridges are installed in the printer, verify that the plastic tape has been removed from each print cartridge. When the protective piece of plastic tape covers the print cartridge contacts, the printer cannot detect that the print cartridge is installed.

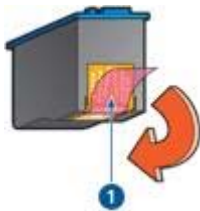

- | | |
|---|---------------------|
| 1 | Remove plastic tape |
|---|---------------------|

"Print cartridge is in the wrong slot" message

If you receive this error message, the print cartridge is installed in the wrong side of the print cartridge cradle.

Always install the tri-color print cartridge in the *left* print cartridge cradle compartment.

Install the black or photo print cartridge in the *right* print cartridge cradle compartment.



Note To easily identify the correct side of the cradle in which to install the print cartridge, match the symbol on the print cartridge with the symbol above the print cartridge cradle.

Photos do not print correctly

Check the paper tray

1. Verify that the photo paper in the In tray with the side to be printed on facing down. Verify that the photo paper is flat.

2. Slide the paper forward until it stops.
3. Slide the paper guide firmly against the edge of the paper.
Do not press the guide so firmly against the paper that the paper bends or curls.

Check the printer properties

Open the [Printer Properties](#) dialog box and verify the following options:

Tab	Setting
Paper/Quality	Size is: An appropriate paper size Type is: An appropriate photo paper Print Quality: Best or Maximum dpi

Colors are tinted or incorrect

If colors in photos appear tinted or incorrect, follow these steps:

1. Verify that neither print cartridge is [low on ink](#).
If neither print cartridge is low on ink, proceed to step 2.
2. [Align](#) the print cartridges.
3. Reprint the photo.
4. If colors are still tinted or incorrect, [calibrate the color](#).
Both a photo print cartridge and a tri-color print cartridge must be installed for color calibration.
5. Reprint the photo.
6. If colors continue to appear tinted or incorrect, open the [Printer Properties](#) dialog box, click the **Color** tab, and then click the **Advanced Color Settings** button.
7. Adjust the colors by using the Advanced Color Settings dialog box.

Horizontal lines appear on a photo



If light or dark horizontal lines appear on photos, follow this procedure:

1. [Clean](#) the print cartridges.
2. Reprint the photo.
3. If horizontal lines still occur, perform a [print quality calibration](#).

- A black and a tri-color print cartridge must be installed for print quality calibration.
4. Reprint the photo.

Part of the photo is faded

If part of the photo is faded, follow these [guidelines](#).

Part of the photo is faded

Fading might occur on the edges or near the edges of a photo.

Fading occurs on the edges of a photo



Verify that the photo paper is not curled. If the photo paper is curled, place the paper in a plastic bag and gently bend it in the opposite direction of the curl until the paper lies flat. If the problem persists, then use photo paper that is not curled.

For instructions about preventing photo paper from curling, see [Store and handle photo paper](#).

Fading occurs near the edges of a photo



If fading occurs approximately 25 to 63 mm (1.0 to 2.5 inches) from the edge of a photo, try the following solutions:

- Install a [photo print cartridge](#) and a tri-color print cartridge in the printer.
- Open the [Printer Properties](#) dialog box, click the **Paper/Quality** tab, and then set the **Print Quality to Maximum dpi**.
- Rotate the image 180°.

PictBridge problems

Images in a connected digital camera do not print

There are several reasons why images in a connected digital camera do not print:

- The digital camera is not PictBridge-compatible.
- The digital camera is not in PictBridge mode.
- The images are not in a supported format.
- You did not select any photos on the camera for printing.

Check the documentation that came with your camera to ensure it supports PictBridge.

If the camera does support PictBridge, make sure the camera is set to PictBridge mode. For instructions on setting the camera to PictBridge mode, see the documentation that came with the camera.

Verify that the digital camera is saving photos in a file format that the PictBridge transfer feature supports:



- EXIF/JPEG
- JPEG

Before you connect the digital camera to the PictBridge port on the printer, select some photos on the camera for printing.

PictBridge lights are flashing

State of the lights	Task
<p>Connection light and the Error light are flashing</p> 	<p>The printer has lost connection with the camera while printing. Check the USB connection.</p>

(continued)

State of the lights	Task
<p data-bbox="221 170 647 222">Connection light is on and the Error light is flashing</p> 	<p data-bbox="687 326 1128 420">The camera has lost power. Replace the camera batteries or connect it to a power supply.</p>
<p data-bbox="221 604 647 656">Connection light is on and the Error light flashes twice</p> 	<p data-bbox="687 777 1013 836">The camera has requested an unsupported command.</p>

Print quality is poor

Streaks and missing lines

If your printed pages are missing lines or dots or if streaks appear, the print cartridges might be [low on ink](#) or might need to be [cleaned](#).

Print is faded

- Verify that neither of the print cartridges is [low on ink](#).
If a print cartridge is low on ink, consider replacing the print cartridge. For the correct part numbers, see the reference guide that came with the printer.
- Verify that a black print cartridge is installed.
If the black text and images on your printouts are faded, you might be printing with only the tri-color print cartridge. Insert a black print cartridge, in addition to the tri-color print cartridge, for optimal black print quality.
- Verify that the protective piece of plastic tape has been removed from the print cartridges.

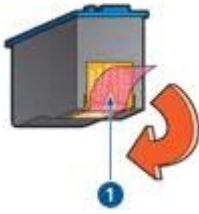

1 Remove plastic tape

- Consider selecting a higher [print quality](#).

Blank pages print

- The protective piece of plastic tape might still be attached to the print cartridges. Verify that the plastic tape has been removed from the print cartridges.

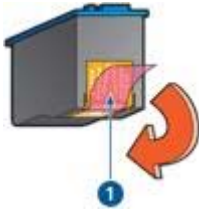

1 Remove plastic tape

- The print cartridges might be [out of ink](#). Replace one or both empty print cartridges.
- You might be trying to print a borderless document with only the black print cartridge installed. When printing a borderless document, always have the tri-color print cartridge and a black or photo print cartridge installed.

Too much or too little ink appears on the page

Adjust the ink volume and dry time:

1. Open the [Printer Properties](#) dialog box.
2. Click the **Advanced** tab.
3. Click **Document Options**, and then click **Printer Features**.
4. Click **Dry Time**, then select **Change** in the drop-down list, and then click the **Change** button. A **Dry Time** slider appears.
5. Move the **Dry Time** slider toward **Less** or **More**.
6. Click **OK**.
7. Click **Ink Volume**, then select **Change** in the drop-down list, and then click the **Change** button. An **Ink Volume** slider appears.
8. Move the **Ink Volume** slider toward **Light** or **Heavy**.



Note If you increase the ink volume, move the **Dry Time** slider toward **More** to avoid smearing the ink.

9. Click **OK**, and then click **OK** again.

Document is misprinted

Text and images are misaligned

If the text and images on your printouts are misaligned, then [align](#) the print cartridges.

Document is printed off-center or at an angle

1. Verify that the paper is correctly placed in the In tray.
2. Verify that the paper guide fits firmly against the edge of the paper.
3. Reprint the document.

Parts of the document are missing or printed in the wrong place

Open the [Printer Properties](#) and confirm the following options:

Tab	Setting
Finishing	Orientation: Verify the appropriate orientation.
Paper/Quality	Size is: Verify the appropriate paper size.
Effects	Scale to fit: Select this option to scale text and graphics to the paper.

If parts of the document are still missing, the printer settings might be overridden by the software program print settings. Select the appropriate print settings from within the software program.

Envelope is printed at an angle

1. Slide the flap inside the envelope before loading it in the printer.
2. Confirm that the paper guide fits firmly against the edge of the envelope.
3. Reprint the envelope.

Document does not reflect the new print settings

The printer settings might differ from the software program print settings. Select the appropriate print settings within the software program.

Problems with borderless documents

Borderless printing guidelines

When printing borderless photos or brochures, follow these guidelines:

- Verify that the paper size that is specified in the **Paper Size** drop-down list on the **Printing Shortcuts** tab matches the size of the paper that is loaded in the In tray.
- Select the appropriate paper type in the **Paper Type** drop-down list on the **Printing Shortcuts** tab.
- If printing in grayscale, select **Print in high quality grayscale** on the **Color Option** drop-down list on the **Printing Shortcuts** tab.
- Do not print borderless documents in [ink-backup mode](#). Always have two print cartridges installed in the printer when printing borderless documents.

Streaks appear in a light portion of a photo



If streaks appear in a light portion of a photo, approximately 63 mm (2.5 inches) from one of the long edges of the photo, try the following solutions:

- Install a [photo print cartridge](#) in the printer.
- Rotate the image 180°.
- Open the [Printer Properties](#) dialog box, click the **Paper/Quality** tab, and then set the **Print Quality** to **Maximum dpi**.

Horizontal lines appear on a photo



If light or dark horizontal lines appear on photos:

1. [Clean](#) the print cartridges.

2. Reprint the photo.
3. If the lines still occur, perform a [print quality calibration](#).
Both a black and a tri-color print cartridge must be installed for print quality calibration.
4. Reprint the photo.

Image is printed at an angle



Verify that no problem exists with the source image. For example, if you are printing a scanned image, verify that the image was not crooked when it was scanned.

If the problem is not caused by the source image, follow these steps:

1. Remove all paper from the In tray.
2. Load the paper correctly in the In tray.
3. Verify that the paper guide fits firmly against the edge of the paper.
4. Follow loading instructions for the paper type.

Ink smears

Follow these guidelines if ink smears appear on the back of the photos, or if the paper sticks together:

- Use an HP photo paper.
- Verify that the photo paper is not curled. If the photo paper is curled, place the paper in a plastic bag and gently bend it the opposite direction of the curl until the paper lies flat.

If the paper is not curled, then follow these steps:

1. Open the [Printer Properties](#) dialog box.
2. Click the **Advanced** tab.
3. Click **Document Options**, and then click **Printer Features**.
4. Click **Dry Time**, then select **Change** in the drop-down list, and then click the **Change** button. A **Dry Time** slider appears.
5. Move the **Dry Time** slider toward **More**, and then click **OK**.
6. Click **Ink Volume**, then select **Change** in the drop-down list, and then click the **Change** button. An **Ink Volume** slider appears.
7. Move the **Ink Volume** slider toward **Light**, and then click **OK**.



Note The colors in the image might become lighter.

8. Click **OK**.

If the problem persists, try the following steps:

1. Remove the photo paper, and then load plain paper in the In tray.
2. Press and hold down the **Print Cancel** button until the printer starts printing a self-test page, and then release the button.
3. Repeat step 2 until the self-test page contains no ink smears.

Part of the photo is faded

If part of the photo is faded, follow these [guidelines](#).

Photo has unwanted border

If the photo has an unwanted border, follow these [guidelines](#).

Part of the photo is faded

Fading can occur on different parts of a photo.

Fading occurs on the edges of a photo



Verify that photo paper is not curled. If the photo paper is curled, place the paper in a plastic bag and gently bend it in the opposite direction of the curl until the paper lies flat. If the problem persists, then use photo paper that is not curled.

For instructions about preventing photo paper from curling, see [Storing and handling photo paper](#).

Fading occurs near the edges of a photo



If fading occurs approximately 25 to 63 mm (1.0 to 2.5 inches) from the edge of a photo, try the following solutions:

- Install a [photo print cartridge](#) in the printer.
- Open the [Printer Properties](#) dialog box, click the **Paper/Quality** tab, and then set the **Print Quality** to **Maximum dpi**.
- Rotate the image 180°.

Photo has an unwanted border

The following conditions can create an unwanted border.

For most paper types



If the photo has an unwanted border, try one of the following solutions:

- [Align the print cartridges](#).
- Open the [Printer Properties](#) dialog box, click the **Paper/Quality** tab, and then verify that the selected paper size matches both the paper size that the photo is formatted for and the size of the paper that is loaded in the In tray.
- Verify that no problem exists with the source image. For example, if you are printing a scanned image, verify that the image was not crooked when it was scanned.

For photo paper with a tear-off tab

If the border appears below the tear-off tab, remove the tab.



If the border appears above the tear-off tab:

- [Align the print cartridges.](#)
- Verify that no problem exists with the source image. For example, if you are printing a scanned image, verify that the image was not crooked when it was scanned.



Error messages

Out of paper message

If you receive an out of paper message, follow these [guidelines](#).

"There was an error writing to USB port"

The printer might not be receiving correct data from another USB device or USB hub. Connect the printer directly to the USB port on the computer.

"Two-way communication cannot be established" or "Printer not responding"

The printer might not be able to communicate with the computer if the USB cable is too long.

If you receive this error message, make sure that the USB cable is not greater than 5 meters (approximately 16 feet, 5 inches) in length.

Incorrect print cartridge message

The printer can only print when the correct print cartridges are installed. If you receive an incorrect print cartridge message, [follow these instructions](#).

Print cartridge problem message

If you receive a message stating there is a problem with the print cartridge, the print cartridge might be faulty. Follow [these instructions](#) to resolve the problem.

"Print cartridge carriage is stalled"

Follow [these steps](#) if the printer stalls while you are printing a document.

"Print cartridge is in the wrong slot"

If you receive this error message, the print cartridge is installed in the wrong side of the print cartridge cradle.

Always install the tri-color print cartridge in the *left* print cartridge cradle compartment.

Install the black or photo print cartridge in the *right* print cartridge cradle compartment.

"Printing in ink-backup mode"

When the printer detects that only one print cartridge is installed, ink-backup mode is initiated. This printing mode lets you print with a single print cartridge, but it slows the printer and affects the quality of printouts.

If you receive the ink-backup mode message and two print cartridges are installed in the printer, verify that the protective piece of plastic tape has been removed from each print cartridge. When plastic tape covers the print cartridge contacts, the printer cannot detect that the print cartridge is installed.

Out-of-paper message

Follow the appropriate steps for the condition that exists.

If the In tray contains paper

1. Verify the following:
 - A sufficient amount of paper is in the In tray (at least ten sheets).
 - The In tray is not overly full.
 - The paper stack is touching the back of the In tray.
2. Slide the paper guide so it fits firmly against the edge of the paper.
3. Press the **Resume** button to continue printing.

If the In tray is empty

1. Load paper in the tray.
2. Press the **Resume** button to continue printing.

Printer lights are on or flashing

What the lights indicate

The printer lights indicate the printer status.



1	Power light
2	Resume light

Power light is flashing



1	Power light
---	-------------

If the Power light is flashing, the printer is preparing to print. The light stops flashing when the printer has received all data.

Resume light is flashing



1	Resume light
---	--------------

If the Resume light is flashing, check the following conditions:

- The printer might be out of paper.
Place paper in the In tray, and then press the **Resume** button.
- There might be a paper jam.
Follow these instructions to [clear a paper jam](#).
- The print cartridges are the [correct print cartridges](#) for the printer and are [properly installed](#).
- A print cartridge might be [low on ink](#).
If a print cartridge is low on ink, consider replacing the print cartridge.
- The printer might be stalled.
Follow these instructions to correct a [stalled printer](#).

Both lights are flashing

The printer might need to be restarted.

1. Press the **Power** button to turn off the printer, and then press the **Power** button to restart the printer.
Proceed to step 2 if the lights continue to flash.
2. Press the **Power** button to turn off the printer.
3. Disconnect the printer power cord from the electrical outlet.
4. Reconnect the printer power cord to the electrical outlet.
5. Press the **Power** button to turn on the printer.

Document prints slowly

Multiple software programs are open

The computer resources are insufficient for the printer to print at its optimum speed.

To increase printer speed, close all unnecessary software programs when printing.

Complex documents, graphics, or photos are printing

Documents containing graphics or photos print more slowly than text documents.

Best or maximum dpi print mode is selected

The printer prints more slowly when Best or maximum dpi is selected as the print quality. To increase the printer speed, select a different print quality mode.

Printer is in ink-backup mode

The printer might print more slowly if it is in [ink-backup mode](#).

To increase the print speed, use two print cartridges in the printer.

Printer software is outdated

Outdated printer software might be installed.

For information about updating the printer software, see the [software update](#) page.

Computer does not meet system requirements

If your computer does not have enough RAM or a large amount of free space on the hard drive, the printer processing time will be longer.

1. Verify that the computer hard disk space, RAM, and processor speed meet the system requirements.
The system requirements are listed in the reference guide that came with the printer.
2. Make space available on the hard drive by deleting unwanted files.

If you continue to have problems

If you continue to have problems after investigating the troubleshooting topics, shut down your computer and then restart it.

If you still have questions after restarting your computer, visit HP Technical Support at www.hp.com/support.

12 Supplies

- Paper
- USB cables

Paper

To order media such as HP Premium Paper, HP Premium Inkjet Transparency Film, HP Iron-On Paper, or HP Greeting Cards, go to www.hp.com.

Choose your country/region, and then select Buy or Shopping.

USB cables

C6518A HP USB A–B 2–meter cable

13 Specifications

- [Printer specifications](#)

Printer specifications

See the reference guide that came with your printer for complete printer specifications, including this information:

- Types, sizes, and weights of paper and other printing media that can be used with your printer
- Print speeds and resolutions
- Power requirements
- Computer operating system requirements

14 Environmental information

- [Environmental statement](#)
- [Print cartridge recovery](#)

Environmental statement

Hewlett-Packard continuously improves the design processes of its deskjet printers to minimize the negative impact on the office environment and on the communities where printers are manufactured, shipped, and used.

Reduction and elimination

Paper use: The [Print Cancel](#) button allows the user to save paper by quickly canceling a print job as needed. This equipment is suitable for using recycled papers (in accordance with EN 12281:2002).

Recycled paper: All paper documentation for this printer is printed on recycled paper.

Ozone: Ozone-depleting chemicals such as CFCs have been eliminated from Hewlett-Packard's manufacturing processes.

Recycling

Design for recycling has been incorporated into this printer. The number of materials has been kept to a minimum while ensuring proper functionality and reliability. Dissimilar materials have been designed to separate easily. Fasteners and other connections are easy to locate, access, and remove using common tools. High priority parts have been designed to access quickly for efficient disassembly and repair.

Printer packaging: The packaging materials for this printer have been selected to provide maximum protection for the least cost possible, while attempting to minimize environmental impact and facilitate recycling. The rugged design of the HP Deskjet printer assists in minimizing both packaging materials and damage rates.

Plastic parts: All major plastics and plastic parts are marked according to international standards. All plastic parts used in the printer housing and chassis are technically recyclable and all use a single polymer.

Product longevity: To ensure the longevity of your HP Deskjet printer, HP provides the following:

- **Extended warranty:** Details can be found in the reference guide that came with your printer.
- **Replacement parts and consumables** are available for a limited period after production has stopped.
- **Product take-back:** To return this product to HP at the end of its useful life, go to www.hp.com/recycle. To return empty print cartridges to HP, see [print cartridge recovery](#).



Note The extended warranty and product take-back options are not available in all countries/regions.

Recycling information for the European Union

Important recycling information for our customers in the European Union: To preserve the environment, this product must be recycled after its useful life as required by law. The symbol below indicates that this product may not be disposed in the general trash. Please return the product for proper recovery/disposal to the authorized collection location nearest to you. For more information regarding return and recycling of HP products generally, please visit www.hp.com/hpinfo/globalcitizenship/environment/recycle/index.html.



Energy consumption

This printer was designed with energy conservation in mind. Not only does this save natural resources, but it also saves money without affecting the high performance of the printer. The printer meets the Federal Energy Management Program (FEMP) requirements, the US government energy savings initiative aimed at reducing power when the printer is turned OFF.

Energy consumption in standby mode: See the reference guide for energy consumption specifications.

Energy consumption in off-mode: When the printer is off, an amount of energy is still being consumed. Energy consumption can be prevented by turning the printer power off, then disconnecting the end of the printer power cord from the electrical source.

Print cartridge recovery

Customers interested in recycling their genuine HP print cartridges can participate in HP's Planet Partner's Program for inkjet cartridges. HP offers this program in more countries/regions than any other inkjet cartridge manufacturer in the world. This program is provided as a free service to HP customers as an environmentally sound solution for these products at end-of-life.

To participate, simply follow the directions provided on HP's Web site at this address: www.hp.com/recycle. This service is not available in all countries/regions. Customers may be asked for their name, phone number, and address.

Because HP's unique recycling processes are very sensitive to material contamination, we cannot take back and recycle cartridges from other manufacturers. The end products of the recycling process are used in the manufacture of new products, and HP must ensure the composition of the material is consistent. To do that, we recycle only HP original cartridges. This program does not extend to refilled cartridges.

Returned cartridges are separated for purification into raw materials for use in other industries to manufacture new products. Examples of products made from recycled HP print cartridge materials include automobile parts, trays used in microchip

fabrication processes, copper wire, steel plates, and the precious materials used in electronics. Depending on the model, HP is able to recycle up to 65% of the print cartridge by weight. The remaining parts that cannot be recycled (ink, foam, and composite parts) are disposed of in an environmentally responsible manner.

Index

A

accessibility 2
adaptive lighting 20
aligning print cartridges 58
auto-off feature 58

B

booklet printing 37
borderless printing guidelines 76
brightness 22
brochure printing 31
buttons
 Power button 7
 Print Cancel button 8
 Resume button 8

C

calibrating print quality 59
cleaning
 print cartridges
 automatically 59
 print cartridges manually 61
 printer body 60
color calibration 59
color tone 22
custom paper size 46

D

default print settings 43
digital photos 19
document printing 29
document prints slowly
 complex documents are
 printing 84
 ink-backup mode 84
 maximum dpi selected 84
 multiple programs are
 open 83
 printer software is
 outdated 84
 system requirements 84
dpi, maximum 21
duplexing 47

E

e-mail printing 27
energy consumption 88
envelope printing 30
environmental statement 87
error messages
 out-of-paper message 81
estimated ink level 60
Exif Print 22

F

Fast/economical printing 42

G

general everyday printing 43
grayscale printing 43
greeting card printing 33

H

Hewlett-Packard Company
 notices 2
HP Image Zone software
 Downloading 54
HP Instant Share 24

I

Image Zone software
 Downloading 54
In tray 10
incorrect print cartridge 68
index card printing 36
Ink Status window 53
ink, removing ink from skin and
 clothing 61
ink-backup mode 14
installing print cartridges 55
Instant Share 24
iron-on transfer printing 40

L

label printing 35
letter printing 28
lights
 all lights are flashing 83
 PictBridge 9
 Power light 7

Power light is flashing 82
Resume light 8
Resume light is flashing 83
low ink 60

M

maintenance
 print cartridges 62
 printer body 60
maximum dpi 21

N

networking 15

O

Other photo projects 23
Out tray 11

P

page order, setting 45
paper guide 10
paper jam 65
paper trays
 folding paper trays 12
 In tray 10
 Out tray 11
 unfolding paper trays 9
paper type, selecting 46
photo brightening 20
photo paper, storing and
 handling 23
photo print cartridge 20
photo printing
 borderless photos 16
 photos with a border 18
 saving money 23
photo printing problems
 colors are incorrect 70
 part of photo is faded 71
 verifying print settings 70
Photo projects 23
PhotoREt printing 21
Photos
 Online sharing 24
 Other projects 23
 Sharing 24

- photos, digital 19
 - PictBridge
 - lights 9
 - PictBridge printing 25
 - PictBridge problems 72
 - postcard printing 34
 - poster printing 39
 - presentation printing 43
 - print cartridge is in the wrong slot message 69
 - print cartridge problem message 68
 - print cartridges
 - aligning 58
 - cleaning automatically 59
 - cleaning manually 61
 - installing 55
 - maintaining 62
 - ordering information 60
 - photo print cartridge 20
 - recycling 88
 - replacing 13
 - selection numbers 55
 - storing 62
 - used with the printer 13
 - print preview 45
 - print quality 44
 - print quality, calibrating 59
 - print settings
 - advanced color settings 22
 - changing 53
 - default settings 43
 - print task quick sets 46
 - printer does not feed paper 66
 - printer ejects paper 66
 - printer features 6
 - printer is not printing 64
 - printer is stalled 67
 - printer lights are flashing 82
 - printer properties 53
 - printer software updates, download 54
 - printer Toolbox 63
 - Printing
 - Other photo projects 23
 - printing
 - 4800 x 1200 optimized dpi 21
 - booklets 37
 - borderless photos 16
 - brochures 31
 - custom paper size 46
 - digital photos 19
 - documents 29
 - e-mails 27
 - envelopes 30
 - Exif Print 22
 - Fast/economical 42
 - from a digital camera 25
 - general everyday printing 43
 - grayscale 43
 - greeting cards 33
 - high quality 21
 - index cards and small media 36
 - iron-on transfers 40
 - labels 35
 - letters 28
 - maximum dpi 21
 - multiple pages on single sheet 45
 - PhotoREt 21
 - photos 16
 - photos with a border 18
 - postcards 34
 - posters 39
 - presentation printing 43
 - print preview 45
 - print quality 44
 - print settings 53
 - print task quick sets 46
 - resizing documents 50
 - selecting a paper type 46
 - setting the page order 45
 - tips 42
 - transparencies 35
 - two-sided printing 47
 - watermarks 51
 - with one print cartridge 14
 - printing in ink-backup mode message 69
 - Printing Shortcuts tab 42
 - printing tips 42
- R**
- Real Life technologies 19
 - recycling
 - print cartridges 88
 - red-eye removal 20
 - removing ink from skin and clothing 61
 - resizing documents 50
- S**
- saturation 22
 - settings 53
 - Sharing photos with family and friends 24
 - sharpness 20
 - SmartFocus 20
 - smoothing 20
- T**
- Terms and conventions in manual 2
 - test page, printing 60
 - Toolbox 63
 - transparency printing 35
 - troubleshooting
 - all lights are flashing 83
 - blank pages print 74
 - borderless printing guidelines 76
 - borderless printing problems 76
 - document does not reflect new print settings 75
 - document is printed off-center or at angle 75
 - document prints slowly 83
 - envelope prints at angle 75
 - error messages 80
 - horizontal lines appear on photo 70
 - image prints at angle 77
 - incorrect print cartridge 68
 - ink smears 77
 - misprinted document 75
 - multiple pages print at once 67
 - out-of-paper message 81
 - paper jam 65
 - parts of the document are missing or in wrong place 75
 - photo printing problems 69
 - PictBridge problems 72
 - poor print quality 73
 - Power light is flashing 82
 - print cartridge is in the wrong slot message 69
 - print cartridge problem message 68
 - print is faded 73
 - printer does not feed paper 66

- printer ejects paper 66
- printer is not printing 64
- printer is stalled 67
- printing in ink-backup mode message 69
- Resume light is flashing 83
- streaks and missing lines 73
- streaks on photo 76
- text and images are misaligned 75
- too little ink on the page 74
- too much ink on the page 74
- unwanted border on photo 79
- two-sided printing 47

U

- updates, download printer software 54
- USB
 - cable 85
 - connecting to the printer 15

W

- watermarks 51
- What's This help 53