

HP xp7010/xp7030 Series Digital Projector

User's Guide

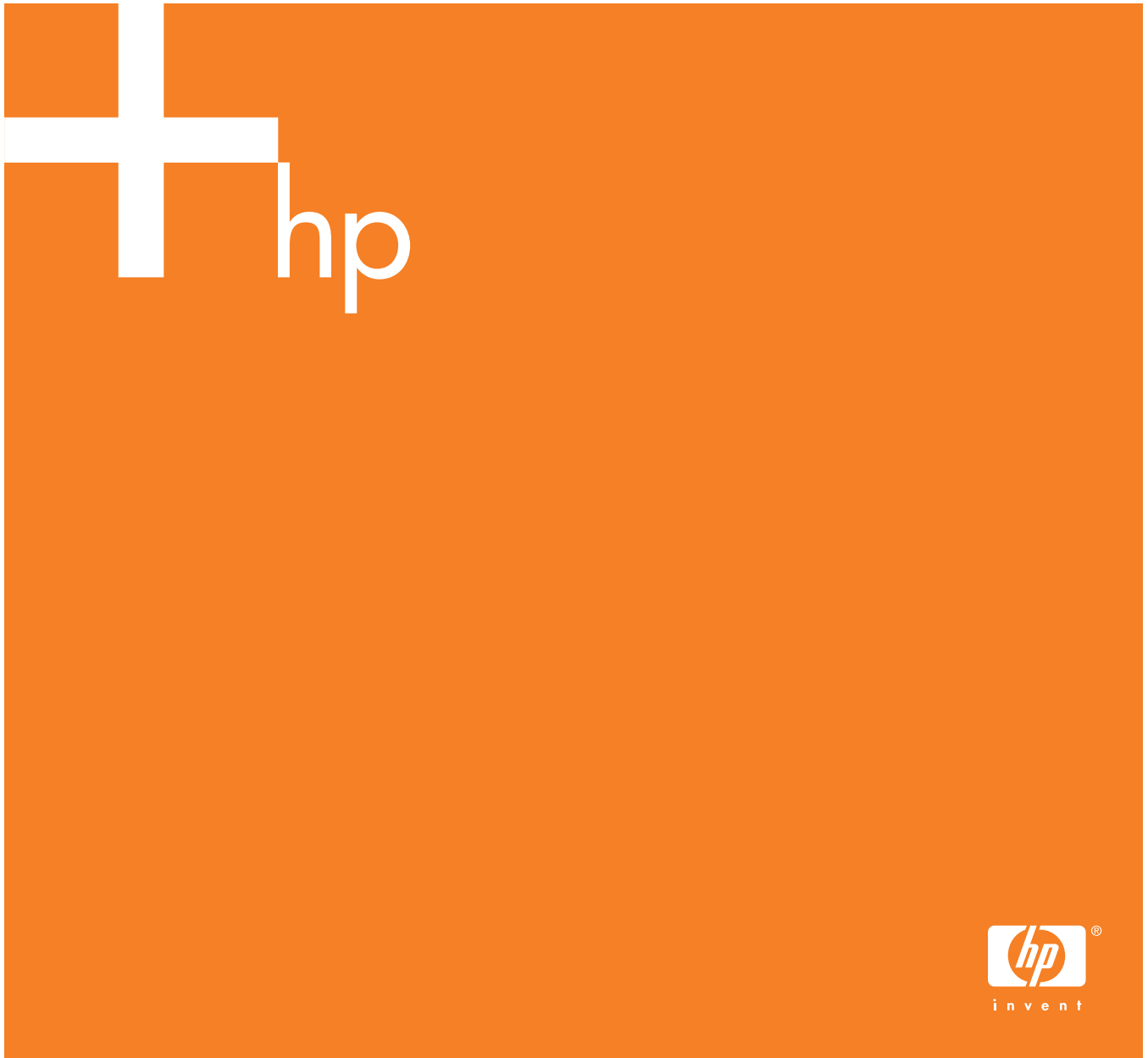

© Copyright 2005 Hewlett-Packard Development Company, L.P.

The information contained herein is subject to change without notice.

The only warranties for HP products and services are set forth in the express warranty statements accompanying such products and services. Nothing herein should be construed as constituting an additional warranty. HP shall not be liable for technical or editorial errors or omissions contained herein.

Hewlett-Packard Company
Display Technologies and Products
1000 NE Circle Blvd.
Corvallis, OR 97330

First Edition, November 2005

Contents

1 Setting Up

Safety precautions	6
What's in the box?	7
Identifying common features.	8
Projector at a glance	8
Projector buttons and lights	9
Back panel	10
Remote control	11
Accessories.	12
Setting up the projector	13
Positioning the projector	13
Connecting power	15
Connecting a computer	16
Connecting a handheld organizer	17
Connecting a video source	18
Turning the projector on and off	23
Turning the projector on	23
Turning the projector off	24
Moving the projector	24
Making basic adjustments	25
Aiming the projector	25
Adjusting the focus and zoom	25
Using the remote control	26

2 Showing Presentations

Showing a computer screen	28
Selecting a different source	28
Hiding or showing the picture	28

3 Adjusting the Projector

Adjusting the picture and sound	29
Choosing the best picture mode	29
Adjusting the shape of the picture	30
Adjusting a slanted picture	31
Adjusting the picture for best color	32
Adjusting other picture settings	32
Adjusting the sound settings (certain models only)	33
Adjusting the projector setup	33
Preventing unauthorized use	33
Using the on-screen menu	34
Changing settings using the on-screen menu	34
Changing the default settings	34
Setup menu	35
Picture menu	36
Source menu	38
Help menu	38

4 Maintaining the Projector

Performing routine maintenance	39
Getting the projector status	39
Cleaning the projector lens	39
Replacing the lamp module	40
Replacing the battery in the remote control	42
Upgrading the projector	43
Updating the firmware	43

5 Installing Permanently

Installing the projector	44
Choosing cables	44
Installing on a table	44
Installing on the ceiling	45
Installing for rear projection	45
Locking the projector	45
Controlling an external accessory	46
Connecting to a room controller	47
Serial connections	47
Examples of room controller commands	48
Room controller commands	50

6 Fixing Problems

Troubleshooting suggestions	55
Warning light problems	55
Start-up problems	56
Picture problems	56
Sound problems	59
Interruption problems	59
Remote control problems	60
Testing the projector	60
Running the projector diagnostics	60

7 Reference

Specifications	61
Safety information	64
Mercury safety	64
Regulatory information	64
U.S.A.	64
Canada	65
Japan	65
Korea	65
International	65
Recycling information	67

1 Setting Up

Safety precautions



WARNING! Read and observe these precautions and all others in this manual to reduce the risk of injury and equipment damage.

- Do not look directly into the lens when the lamp is on.
- Do not expose the projector to rain or moisture, and do not use it near water.
- Do not subject the projector to physical abuse or misuse such as exposure to smoke, unusual stresses, or excessive or continuous (24/7) operation.
- Keep paper, plastic, and combustible material at least 0.5 m (2 ft) away from the projector's lens and exhaust vents.
- Do not allow liquid, food, or small objects to get inside the projector. If material gets inside the projector, contact HP for assistance.
- Do not put anything on top of the projector. Do not place any liquids where they might spill on the projector.
- Do not block any vents on the projector. Do not place the projector near any source of heat, such as a radiator or amplifier.
- Use only an approved power cord rated for the voltage and current marked on the product label. Do not overload any outlet or extension cord. Do not circumvent the grounding prong on the power cord.
- Route all cables so they are not located where people can step on them or trip on them.
- Place the projector flat on its base on a sturdy surface or on an HP ceiling mount. Do not stand the projector on its front surface.
- Do not touch the lens with your fingers. See "Cleaning the projector lens" on page 39. Use a soft, dry cloth to clean the projector case.
- Do not open the projector except as instructed by this manual, and only after allowing the projector to cool down.
- If the projector is damaged in any way, contact HP for assistance.

What's in the box?

Before setting up your projector, be sure its shipping box includes the following items. If the shipping box does not contain all of the following items, contact HP.



TIP: After you open the box and remove the contents, save the box in case you must ship the projector.

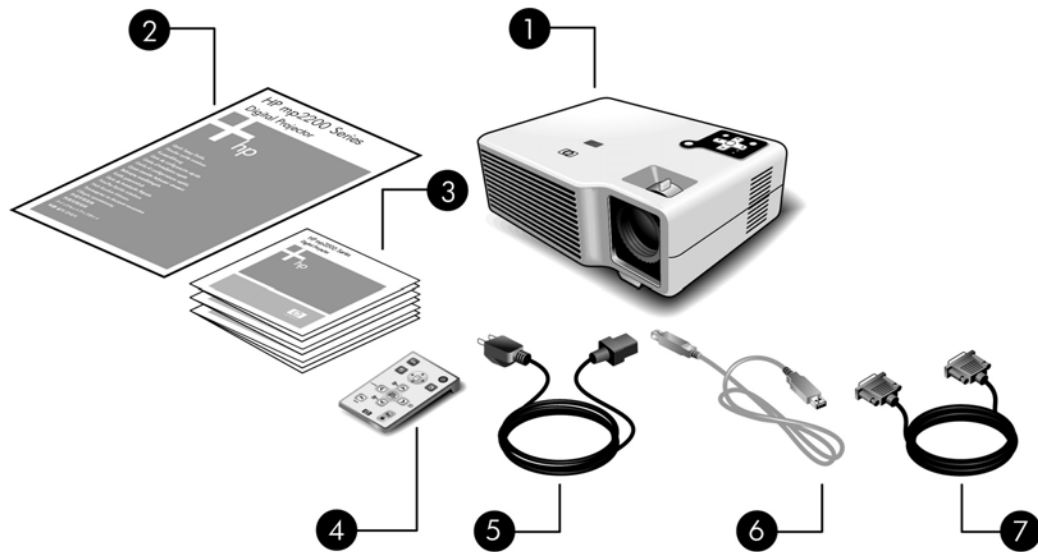

Identifying the contents of the box

Item	Function
1 Projector	Displays images.
2 <i>Quick Setup Guide</i>	Provides instructions to help get started.
3 Literature package	Contains documentation for the setup and use of the projector, plus support and warranty information.
4 Remote control	Controls the projector.
5 Power cord	Connects the projector to a power source.
6 USB cable	Connects the projector's USB output to a computer.
7 VGA cable	Connects a computer video output to the projector.

Identifying common features

Projector at a glance

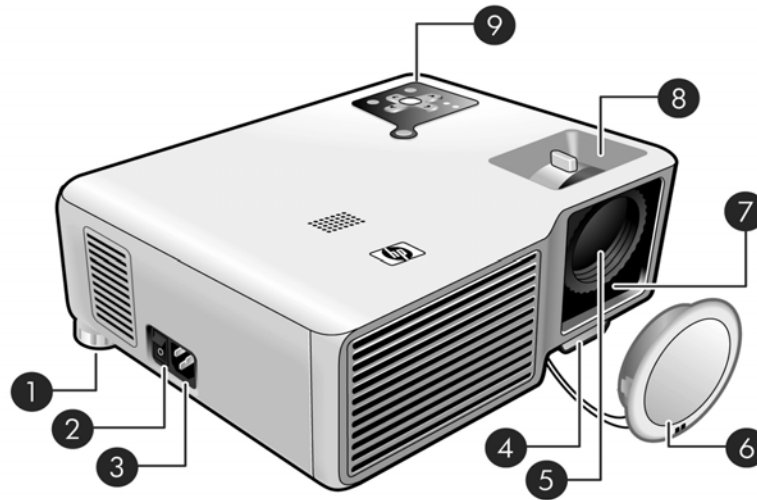

Identifying major components

Item	Function
① Adjustable foot	Levels the projector (one foot on each rear corner).
② Disconnect switch	Disconnects power. Turn off when unplugging the power cord. CAUTION: Do not use this switch to turn off the projector. Use the power button on top of the projector.
③ Power cord socket	Connects the power cord to the projector.
④ Height adjustment button	Adjusts the height of the picture.
⑤ Lens	Projects the image.
⑥ Lens cap	Protects the lens.
⑦ Infrared port	Receives signals from the remote control.
⑧ Focus and zoom rings	Focus ring: focuses at a distance of 1.2 to 10 m (4 to 33 ft). Zoom ring (with tab): enlarges the picture from 100% to 120%.
⑨ Button panel	Contains control buttons and indicator lights.

Projector buttons and lights

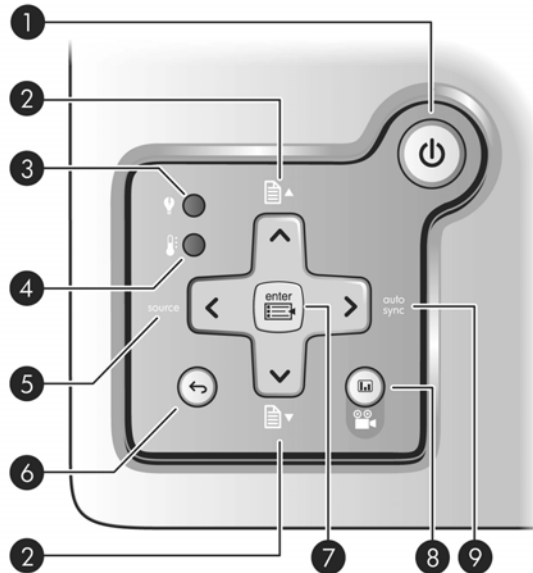

Identifying the projector buttons and lights

Item	Function
① Power button	Turns the projector on or off.
② Page-up and Page-down buttons	Scrolls up and down through pages on a connected computer, or navigates the on-screen menu.
③ Lamp warning light	Lit steady: the lamp is faulty. Flashing: the lamp ballast is faulty.
④ Temperature warning light	Warns if the projector is too hot.
⑤ Source button	Displays the picture from the next input port, or navigates the on-screen menu.
⑥ Back button	Exits the on-screen menu, or re-enters the on-screen menu at the most recently used item.
⑦ Enter button	Opens the on-screen menu or acts on the selected menu item.
⑧ Picture mode button	Selects the next picture and color combination—can be customized.
⑨ Auto sync button	Resynchronizes the projector to the input signal from a computer, or navigates the on-screen menu.

Back panel

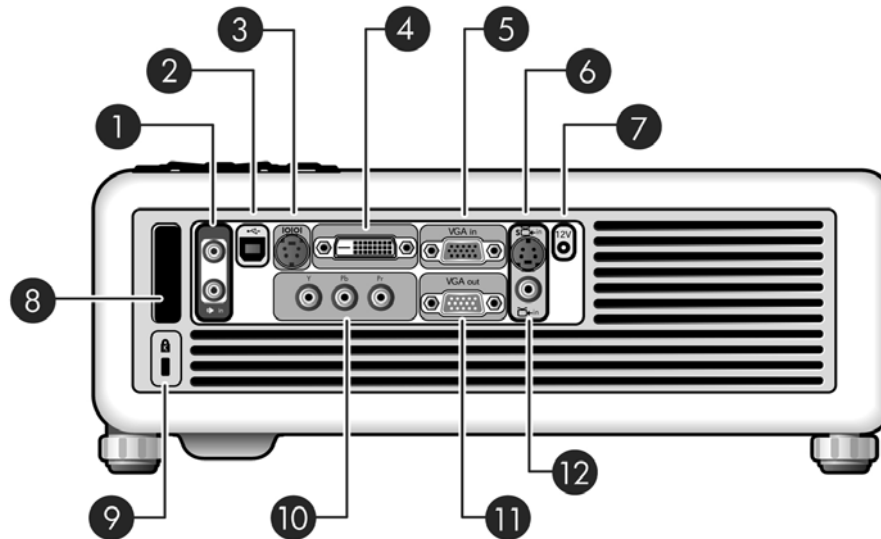

Identifying back panel components

Item	Function
① Audio in and out ports	Connect a stereo audio source using a stereo mini-phone plug, or an optional RCA-to-mini-phone plug. NOTE: Available only on certain models.
② USB port	Connects to a computer and controls the mouse.
③ Serial port	Connects a room controller.
④ DVI input port	Connects a DVI-D digital video source. NOTE: Available only on certain models.
⑤ VGA-in port	Connects video input from a computer or component-video source.
⑥ S-video input port	Connects an S-video source.
⑦ 12-Vdc trigger output	Controls a motorized screen or similar accessory device. NOTE: Available only on certain models.
⑧ Infrared port	Receives signals from the remote control.

Identifying back panel components (continued)

Item	Function
⑨ Lock slot	Locks the projector to a stationary object with the use of a cable and lock.
⑩ Component video input port	Connects a component video source.
⑪ VGA-out port	Sends the VGA-in signal to a monitor.
⑫ Composite-video input port	Connects a composite-video source.

Remote control



TIP: Before using the remote control, remove the battery protector by pulling the plastic tab until it comes out of the remote control.

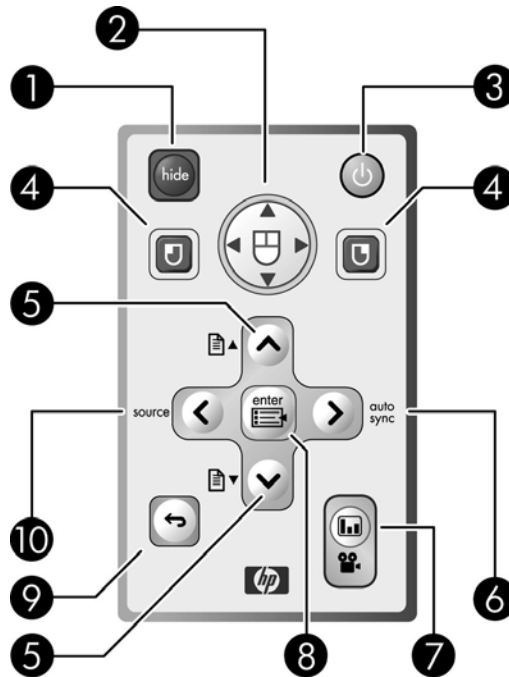

Identifying components of the remote control

Item	Function
① Hide button	Blanks the picture, and mutes the audio (certain models only).
② Mouse pad	Moves the mouse pointer on a connected computer.
③ Power button	Turns the projector on or off.
④ Left-click and right-click mouse buttons	Performs left-click and right-click mouse functions on a connected computer.
⑤ Page-up and Page-down buttons	Scrolls up and down through pages on a connected computer, or navigates the on-screen menu.
⑥ Auto sync button	Resynchronizes the projector to the input signal from a computer, or navigates the on-screen menu.
⑦ Picture mode button	Selects the next picture and color combination—can be customized.
⑧ Enter button	Opens the on-screen menu or acts on the selected menu item.
⑨ Back button	Exits the on-screen menu, or re-enters the on-screen menu at the most recently used item.
⑩ Source button	Displays the picture from the next input port, or navigates the on-screen menu.

Accessories

Get more from your presentations with HP projector accessories. You can purchase accessories at <http://www.hp.com> or through your projector dealer.

- **HP ceiling mount kit**—enables you to simply and discreetly install your projector on the ceiling.
- **HP projection screens**—mobile screens that are easy to carry and set up anywhere, and fixed screens for even greater convenience.
- **HP premium remote control**—allows you to control every aspect of your presentations.
- **HP power cables**—allow you to connect in any region.
- **HP cables**—allow you to connect all audio-video equipment.
- **HP replacement lamp**—brings your projector up to factory-fresh brightness.
- **HP pn1050 Jetdirect projector server**—enables you to connect your projector directly to a network, and manage it from anywhere on the network.
- **HP projector carrying case**—enables you to transport your projector safely.
- **HP SCART to composite S-video adapter**—allows you to connect SCART devices.

Setting up the projector

Positioning the projector

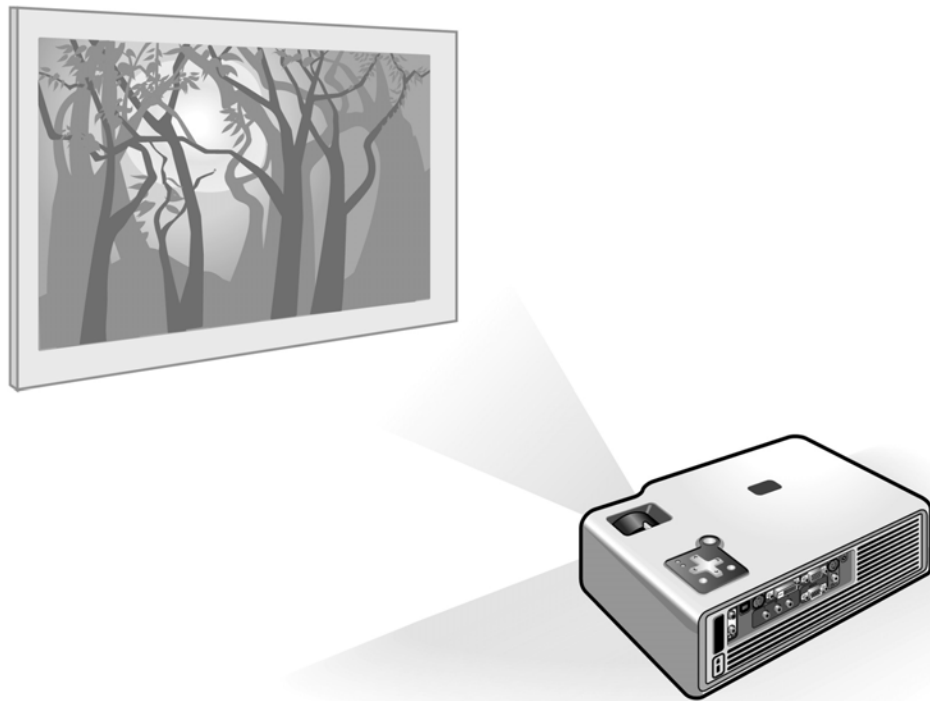

The following tables show you where to position the projector in relation to the screen.



TIP: For more information on adjusting the picture, see “Making basic adjustments” on page 25 and “Adjusting the Projector” on page 29.

Image size relative to distance from the screen — xp7010/xp7030 series

Image size (diagonal)		Image size (width)		Distance — Tele (lens to screen)	
(inches)	(meters)	(inches)	(meters)	(inches)	(meters)
40	1.0	32	0.8	52 to 63	1.3 to 1.6
50	1.3	40	1.0	65 to 79	1.7 to 2.0
60	1.5	48	1.2	79 to 94	2.0 to 2.4
80	2.0	64	1.6	105 to 126	2.7 to 3.2
100	2.5	80	2.0	131 to 157	3.3 to 4.0
150	3.8	120	3.0	197 to 236	5.0 to 6.0
200	5.1	160	4.1	262 to 315	6.7 to 8.0
250	6.4	200	5.1	328 to 394	8.3 to 10.0

If you do not want to use the distance table, you can use the following equations to help determine where to install the projector relative to the screen.

Calculating projection distances

distance from lens to screen = $A \times$ width of screen

minimum and maximum distance from screen = B

width of screen = $0.8 \times$ diagonal of screen (for 4:3 screen)

projector lens below bottom of screen = $C \times$ width of screen (for 4:3 screen, with projector sitting level)

xp7010/xp7030 series

A = 1.6 to 2.0

B = 1.2 to 10 m (4 to 33 ft)

C = 0.12

Connecting power

1. Place the projector on a stable platform located 1.2 to 10 m (4 to 33 ft) in front of the screen. Ideally, the platform should be lower than the bottom of the screen.
2. Connect one end of the power cord to the back of the projector ❶ and the other end to a grounded electrical outlet ❷.
3. Turn on the disconnect switch ❸ on the side of the projector.

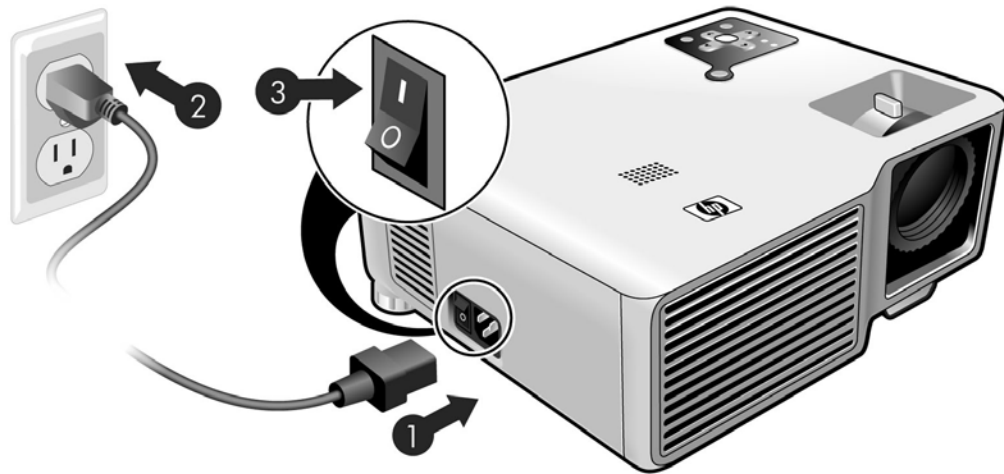

If you want to permanently install the projector on the ceiling or behind the screen, see “Installing the projector” on page 44.

Connecting a computer

Requires:

- VGA cable or other video source cable ❶
- USB cable ❷ (optional)
- Audio cable, mini-phone (optional)

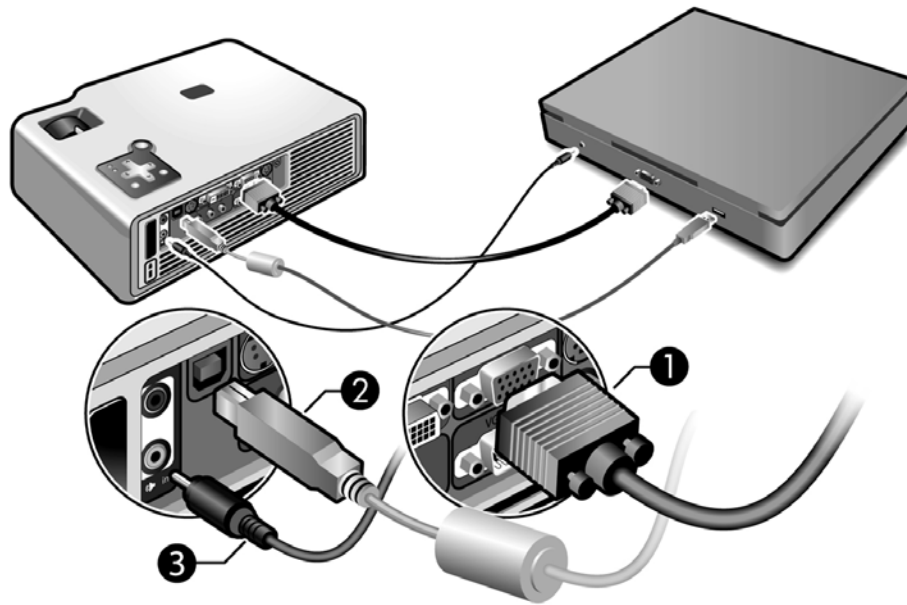

The optional USB connection allows you to use the mouse and page up/down features on the remote control.

See “Showing a computer screen” on page 28.



TIP: If the computer display does not appear on the projector, you might have to press a combination of keys on the computer to turn on the computer’s VGA output. For example, on some computers you must press FN+F4 or FN+F5. For instructions, refer to the user documentation provided with your computer.

TIP: You can connect an external computer monitor to the VGA-out port on the projector. The monitor displays the signal connected to the VGA-in port—even if the projector is turned off or showing a different input.

Connecting a handheld organizer

Not all handhelds come with VGA-out ports. For example, an iPAQ Pocket PC may require a VGA-out PC Card with 15-pin connector. If necessary, install a VGA-out accessory card into the organizer.

Requires:

- VGA cable ❶
- VGA-out accessory card ❷ (in some cases)

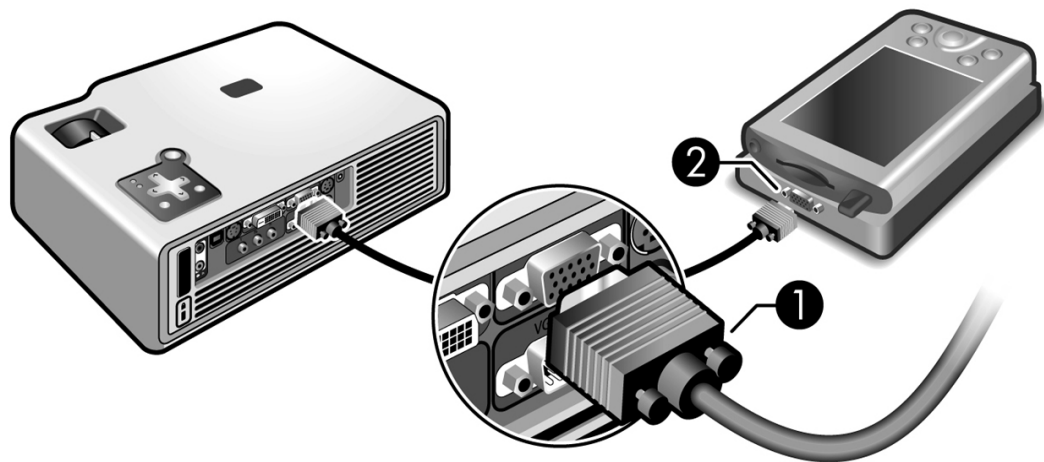

Connecting a video source

Many video devices have more than one type of output port. When you connect the device to the projector, choose the connection that provides the best picture quality. This list shows video connections in order with highest picture quality at the top:

- DVI connection (highest quality)
- Component-video connection
- S-video connection
- Composite-video connection

The video and audio cables shown in the following sections are available from HP.

If you want to connect a SCART video device to the projector, you will need a SCART adapter (available from HP).

Connecting a DVI source

The DVI port is available only on certain models. It supports only DVI digital sources.

Examples: Cable boxes, satellite receivers, and some computers

Requires:

- DVI-D cable ❶
- Audio cable, mini-phone ❷ (optional)

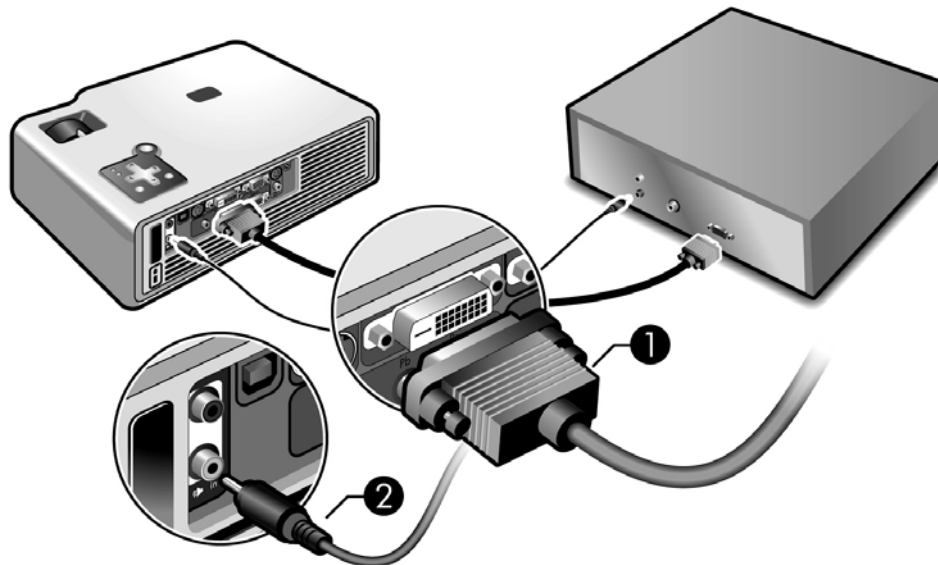

Connecting a component-video source with a component-to-VGA cable

Examples: Cable boxes, DVD players, satellite receivers, and audio-video receivers

Requires:

- Component-to-VGA cable ❶
- Audio cable, mini-phone ❷ (optional)



TIP: Many DVD players and other high-quality video devices provide component video output through three RCA connectors (which might be labeled YPbPr or YCbCr). Connect the component-to-VGA cable to the video device's RCA connectors and the projector's VGA-in port.

If possible, configure the video source to use progressive scan output, such as 480p, 575p, or 720p. For additional information, refer to the user documentation provided with the video source.

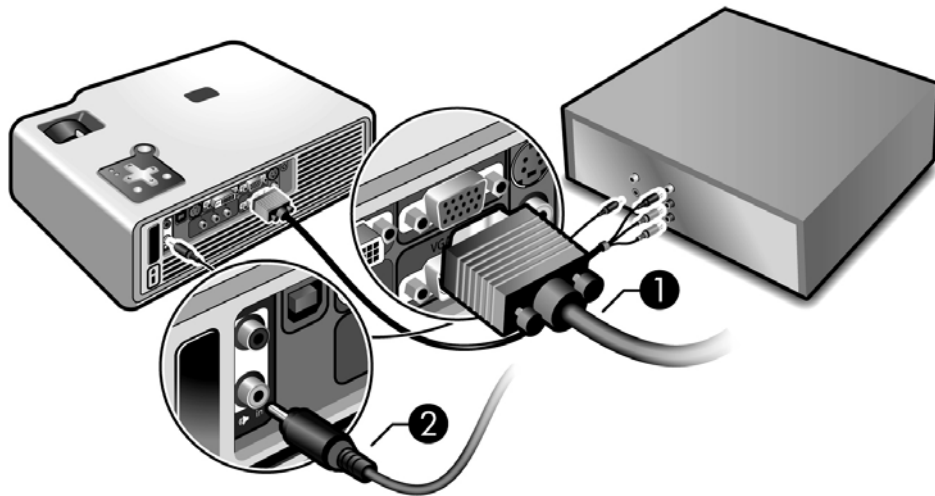

Connecting an RCA component-video source (certain models only)

Examples: Cable boxes, DVD players, satellite receivers, and audio-video receivers

Requires:

- Standard component-video cable ❶
- Audio cable, mini-phone ❷ (optional)



TIP: Many DVD players and other high-quality video devices provide component video output. The three RCA connectors might be labeled YPbPr or YCbCr.

If possible, configure the video source to use progressive scan output, such as 480p, 575p, or 720p. For additional information, refer to the user documentation provided with the video source.

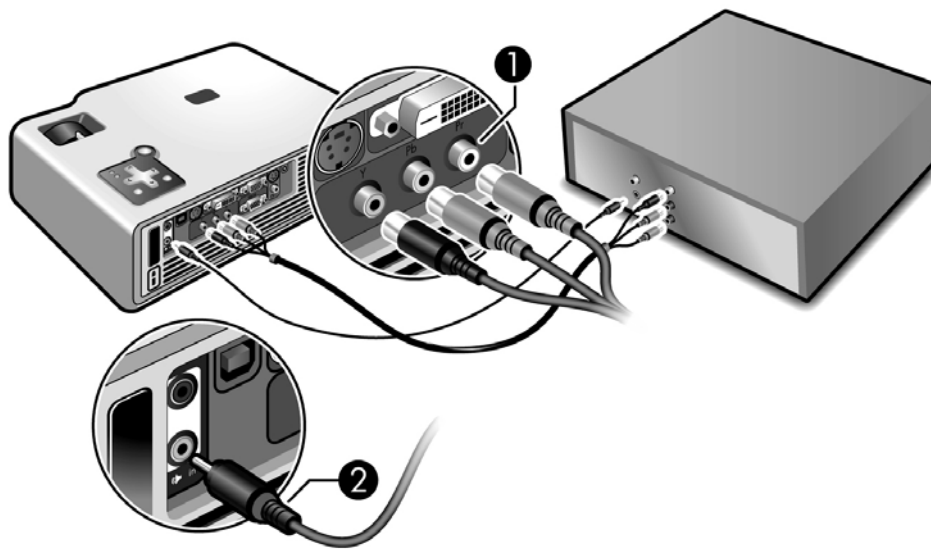

Connecting an S-video source

Examples: DVD players, VCRs, cable boxes, camcorders, and video gaming devices

Requires:

- S-video cable ❶
- Audio cable, mini-phone ❷ (optional)

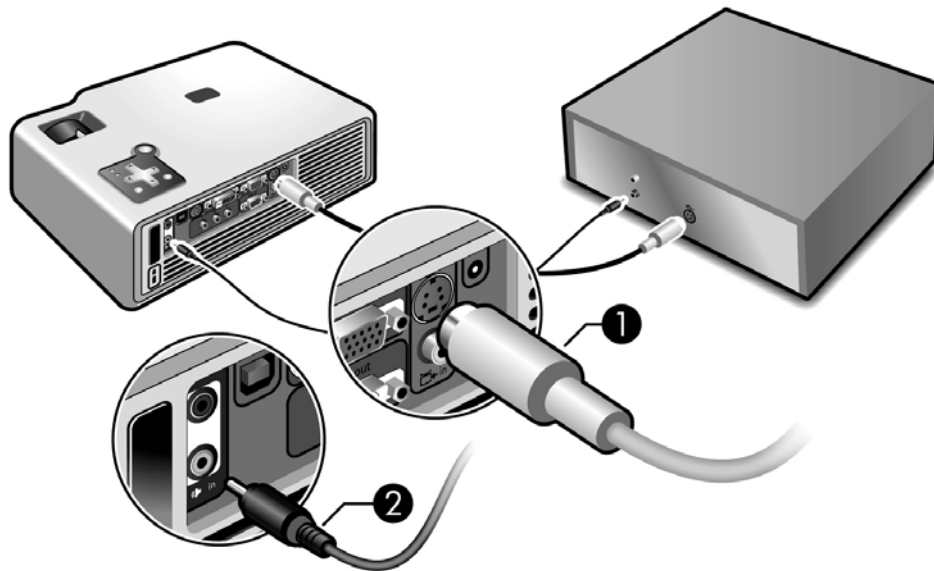

Connecting a composite-video source

Examples: VCRs, DVD players, audio-video receivers, and video gaming devices

Requires:

- Composite-video cable ❶
- Audio cable, mini-phone ❷, or combined video-audio cable (optional)

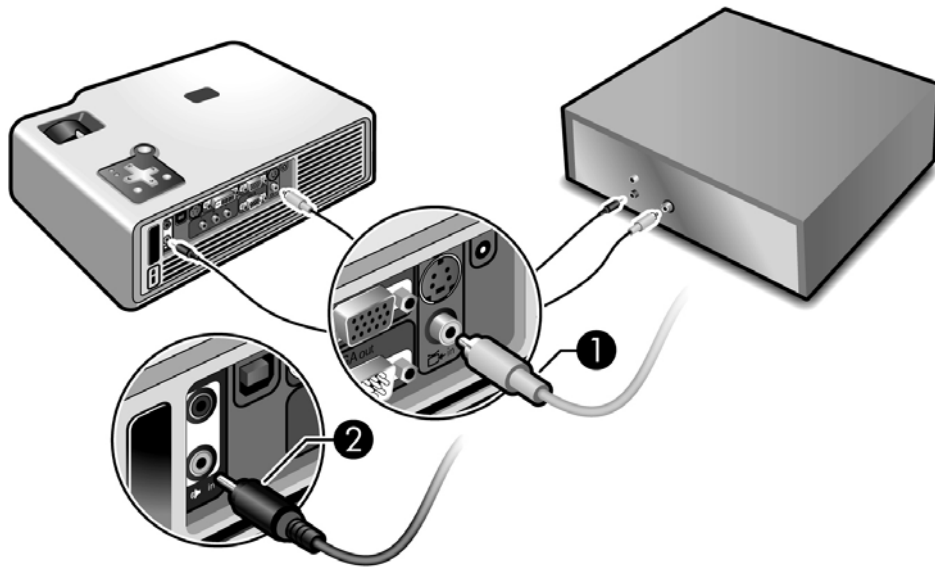

Turning the projector on and off

Turning the projector on

1. Be sure the power cord is connected and the disconnect switch is on.
2. Remove the lens cover ❶.
3. Press the power button ❷ on the projector or on the remote control.

The projector takes a minute or so to warm up. The power button blinks during warm-up.

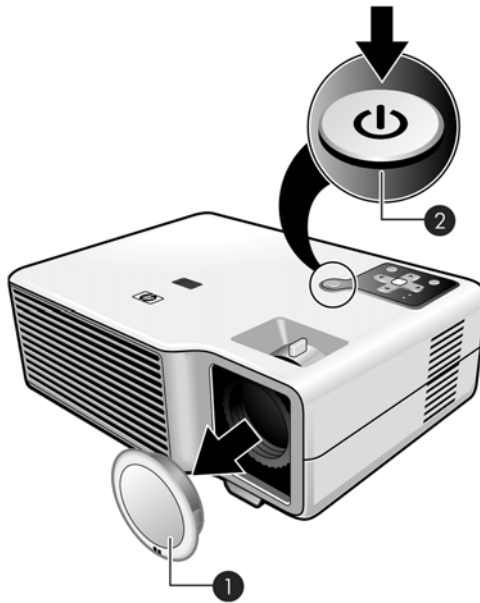

TIP: If the picture does not appear on the screen, try the following:

- If you are using a computer, press the key combination that turns on its video output. For example, press FN+F4 or FN+F5 on some computers.
- On the projector, press the **source** button one or more times to select the correct input port.



NOTE: It is normal for parts of the projector and the air coming out of the projector to be very warm. If the projector starts to overheat, the temperature warning light will turn on and the projector will shut down.

Turning the projector off

1. Press the power button on the projector or remote control to turn off the projector. Do not hold the button down.

The power button blinks during the cool-down period, then the projector turns off. Even though the projector is off, it uses a small amount of power internally.

2. If you want, disconnect video and audio equipment from the projector during the cool-down period or after the power button stops blinking.



CAUTION: Do not disconnect power or turn off the disconnect switch until the projector has cooled down (the fan stops) and the power button stops blinking. Otherwise, you might shorten the life of the lamp.

3. If you must unplug or remove the projector, wait until the power light stops blinking, then unplug the power cord.

If you try to turn on the projector again during the cool-down period, it will not turn on. Wait until the cool-down period ends and the power button stops blinking.

Moving the projector

When moving the projector:

- Allow the projector to cool down before moving it. Then disconnect all cables.
- Avoid bumps and jolts. Use a carrying case or padded container when possible.
- Observe temperature and humidity limits (see “Specifications” on page 61). If the projector is cold, allow it to warm gradually to avoid condensation.

Making basic adjustments

This section provides instructions for making basic adjustments to the projector.

Aiming the projector

- To raise or lower the projected picture on the screen, press the height adjustment button ❶ and raise or lower the front of the projector ❷. Release the button to lock the adjustment.
- To level the picture on the screen, turn the adjustable feet ❸ to lengthen or shorten.

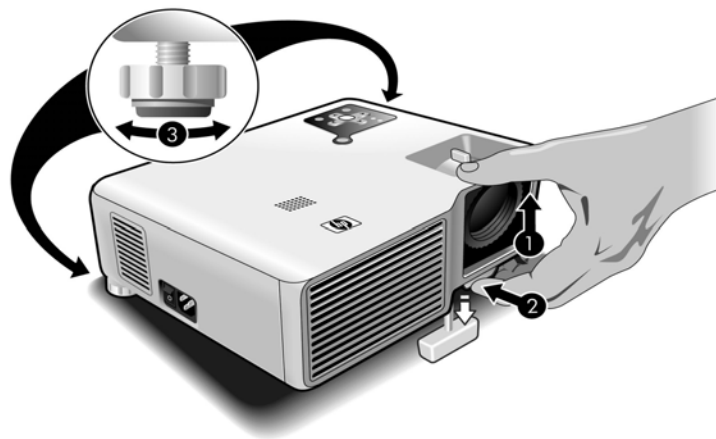

Adjusting the focus and zoom

- Rotate the focus ring until the image becomes clear. The projector can be focused at distances of 1.2 to 10 m (4 to 33 ft).
- Rotate the zoom ring (with tab) to adjust the picture size (100% to 120%).

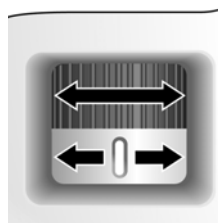

If the picture does not fit the screen, you might have to move the projector closer to or farther away from the screen.



TIP: For more information on adjusting the picture, see “Adjusting the Projector” on page 29.

Using the remote control

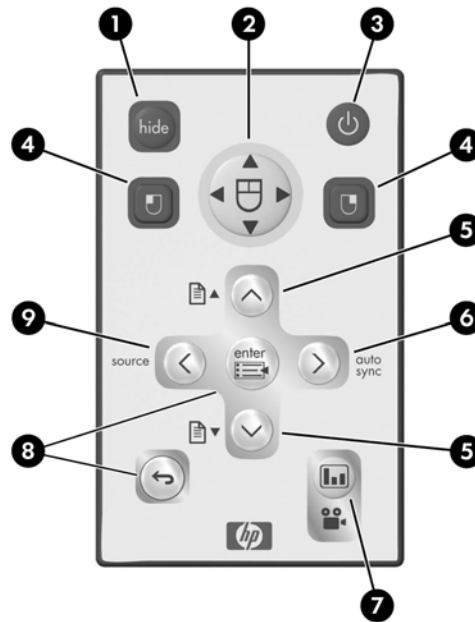

To do this...	Press this...
Hide or unhide the picture, and mute or unmute the audio (certain models only)	hide button 1 .
Move mouse pointer on computer	Edge of the mouse pad 2 in the direction you want the pointer to move. This feature requires a USB connection between the projector and computer.
Turn the projector on or off	Power button 3 .
Click mouse button on computer	Left-click or right-click button 4 . This feature requires a USB connection between the projector and computer.
Page up or page down on computer	Page-up or page-down button 5 . This feature requires a USB connection between the projector and computer.
Readjust picture of computer screen	auto sync button 6 .

To do this...	Press this...
Change picture settings for different type of input signal	Picture mode button 7 one or more times.
Change settings using on-screen menu	enter and navigation buttons 8 . See "Using the on-screen menu" on page 34.
Exit from any on-screen menu or adjustment	Exit ↩ button 8 .
Switch to next input source	source button 9 one or more times.



TIP: From within the distance of 8 m (26 ft), aim the remote control at the screen or at the front or back of the projector.

2 Showing Presentations

Showing a computer screen

1. Be sure the computer is connected to the projector and turned on. See “Connecting a computer” on page 16.
2. Be sure the projector is set up, turned on, and adjusted. See “Making basic adjustments” on page 25.
3. If a different input source is shown on the projector, press the **source** button on the projector or remote control one or more times to select the VGA-in port.
4. If the computer display is not shown on the projector, you might have to turn on the computer’s video output port. For example, some computers require you to press a key combination, such as FN+F4 or FN+F5. Refer to the user documentation provided with your computer.

If you want to adjust the picture, see “Adjusting the picture and sound” on page 29.

Selecting a different source

If the picture from your video source does not appear on the screen, you can quickly select the correct source.

- ▲ Press the **source** button one or more times—until you see the picture or you see the name of the video port where the source is connected.

You should also be sure the video source is turned on and playing video.

Hiding or showing the picture

1. Press the **hide** button on the remote control to blank the picture, and to mute the audio (certain models only). This does not affect the video source, which continues playing.
2. Press any button to restore the picture, as well as the audio (certain models only).

3 Adjusting the Projector

You can change the projector's settings through its built-in on-screen menu system, using the buttons on the projector or the remote control.

To access the on-screen menu, press **enter** on the projector or remote control.

For details, see "Using the on-screen menu" on page 38.

Adjusting the picture and sound

Choosing the best picture mode

You can quickly choose a different picture mode to make adjustments to the picture. Picture modes can control properties such as color and size. They let you easily choose the best settings for ambient lighting and the type of video content.

- ▲ Press the picture mode  button one or more times to select the picture mode that gives the best picture.

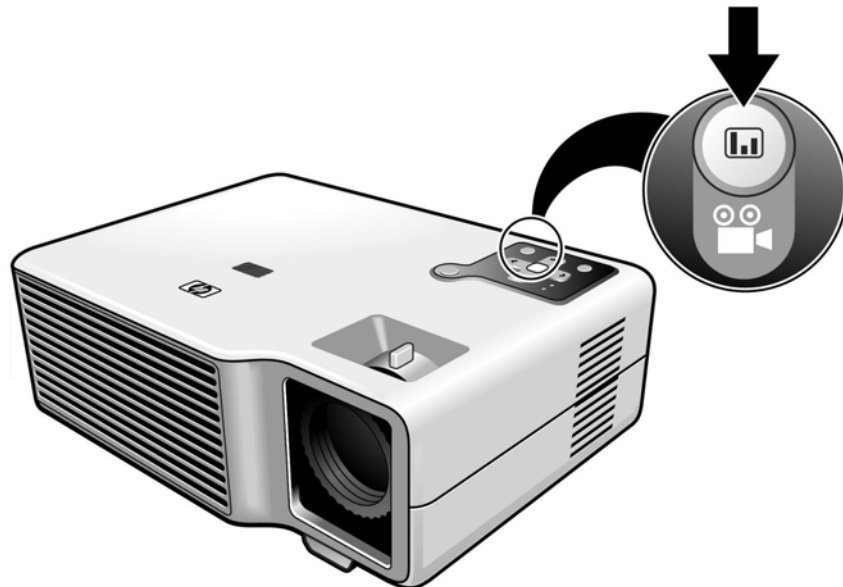

You can also customize the picture modes so they are best for your video sources:

1. Press the picture mode  button to select the picture mode you want to adjust.
2. Press **enter** and go to **Picture > Customize picture mode**.
3. Adjust the settings until you are satisfied with the picture.



TIP: To exit from any on-screen menu or adjustment, press the exit  button.

To return to the most recently used menu item when no on-screen menu or adjustment is displayed, press the exit  button.

Adjusting the shape of the picture

Depending on the type of video source you are viewing, the picture might or might not always look correct or fit on the screen:

- If the active video device sends widescreen output to the projector, press **enter**, go to **Source**, and set **Widescreen input** to **On**. See ❶ in the following diagram.
- If the video device sends standard output, set **Widescreen input** to **Off**.



TIP: If you show widescreen pictures on a wide projection screen, a standard picture might not fit on the screen. One solution is to change the current picture mode so it makes a smaller picture. Press **enter**, go to **Picture > Customize picture mode**, and set **Aspect Ratio** to **Reduced**. See ❷ in the following diagram.

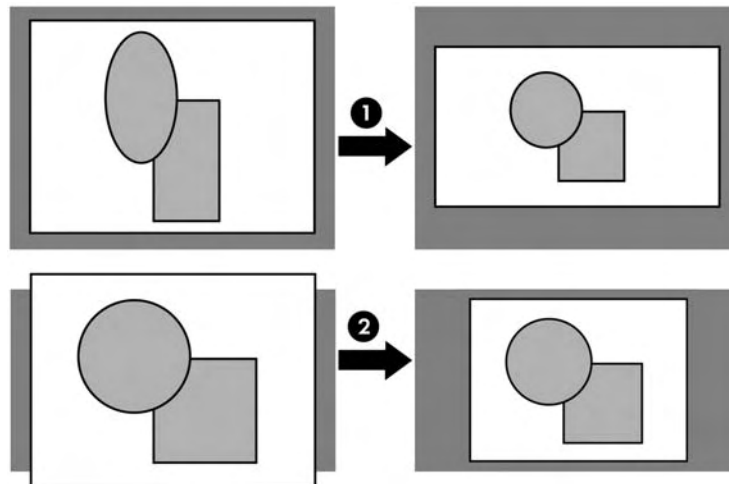

Adjusting a slanted picture

If the projector is tilted up or down, the sides of the picture on the screen might slant in or out, even though the top and bottom are level. The keystone adjustment corrects this problem.

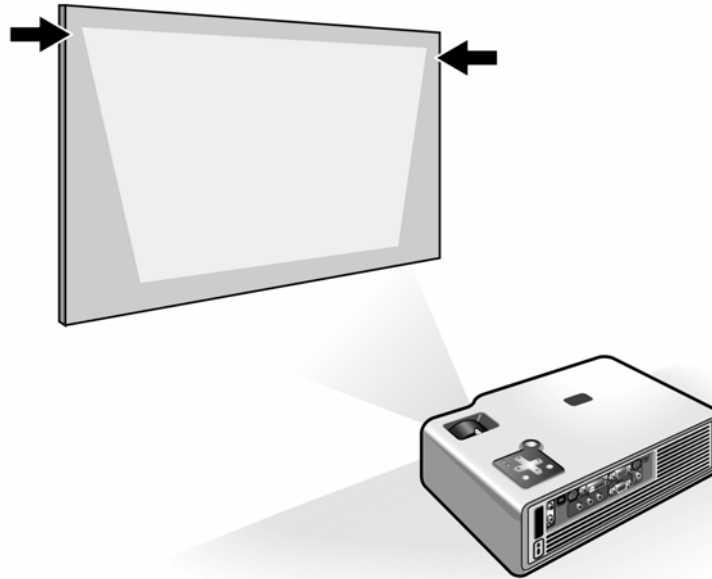

Adjust the picture using the keystone setting in the on-screen menu. Press **enter**, go to **Setup > Keystone**, and adjust until the picture looks correct.



TIP: If the projector is not perpendicular to the screen, the projected image may slant left or right. If this happens, turn the projector until the image is rectangular, with straight corners.

Adjusting the picture for best color

You can fine tune the picture settings on your projector to get the best color and image quality. You should perform these steps for each input source device and each input port that you use. Do them in the order shown. For some input ports, some of these settings may not be available.

1. Press the picture mode  button and select the picture mode you want to use for the current source.
2. Press **enter** and go to the **Picture** menu.
3. Go to **Color settings > Brightness**. Adjust to the highest setting that still gives the darkest black for black areas.
4. Go to **Color settings > Contrast**. Adjust to the highest setting that does not wash out fine detail in bright areas. You can view bright clouds or textured white areas.
5. Go to **Customize picture mode > Picture enhancement**. Adjust to the setting that gives the best overall mid-range brightness. This should have minimal effect on blacks and whites.
6. Go to **Customize picture mode > Color temperature**. Adjust to the setting where whites and colors look best.
7. Go to **Color settings > Color saturation**. Adjust to the setting where colors look most natural.
8. Go to **Color settings > Tint**. Adjust to the setting where colors look most natural.
9. Go to **Advanced Color**. Adjust **Red**, **Green**, and **Blue** to the settings where the colors appear most natural.
10. Go to **Customize picture mode > White intensity**. Adjust this setting above 0 as needed to brighten the picture. Note that color accuracy drops as white intensity increases.
11. Repeat all steps if necessary.

Adjusting other picture settings

The on-screen menu provides many settings that allow you to fine-tune the picture.

1. Press **enter**, and go to **Picture**.
2. Change the picture adjustments as needed.

From the Picture menu, you can change many picture options, such as brightness, contrast, and picture shape, as well as customize the picture modes.

To get descriptions for all available picture adjustments, see “Picture menu” on page 36.

Adjusting the sound settings (certain models only)

You can control the volume of the projector's speaker or any connected speakers:

- To change the volume, press **enter**, go to **Setup > Volume**, and change the setting.
- To turn the sound on or off temporarily, press **enter**, go to **Setup > Mute**, and mute the sound.

Adjusting the projector setup

1. Press **enter**, and go to **Setup**.
2. Set the setup adjustments as needed.

From the **Setup** menu, you can select settings, such as menu language, projector position, and menu timeout.

To get descriptions for all available setup adjustments, see "Setup menu" on page 35.

Preventing unauthorized use

You can prevent unauthorized people from using the projector by creating a secret button sequence that is required for the projector to turn on. The unlock sequence is a series of 4 to 8 arrow buttons. If the buttons are not pressed in the order you specify, the projector does not turn on. Use the following steps to set or clear an unlock sequence.

1. Press **enter**, go to **Setup > Advanced setup > Projector lock**, and press **enter**.
2. If an old unlock sequence is set, press the buttons according to the old sequence when prompted, and then press **enter**.
3. To set a new unlock sequence, press the arrow buttons for the new sequence, and then press **enter**.

To clear the unlock sequence and remove this protection, press only **enter**.

4. When prompted, confirm the new sequence and press **enter**.



NOTE: If you set an unlock sequence, you must press the sequence every time you turn on the projector. The sequence protects the projector only when the projector is turning on, not at any other time.

If you forget the unlock sequence, you must call HP support to unlock the projector. You must have the projector and your proof of purchase.

Using the on-screen menu

Changing settings using the on-screen menu

You can change the on-screen menu settings with the buttons on either the projector or the remote control.

1. Press **enter** on the projector or remote control. This displays the on-screen menu.
2. Press up ▲ or down ▼ to highlight the desired menu icon, then press right ► to move into that menu.
3. Press up ▲ or down ▼ to highlight a setting, then press **enter** to begin adjusting the setting.
4. Press left ◀ or right ▶, or press up ▲ or down ▼, to adjust the setting, as prompted.
5. Press **enter** to return to the menu.
6. To go to a different menu, press left ◀ and select a menu.
7. To close the on-screen menu, press the exit ↵ button.

If you do nothing for a period of time, the on-screen menu closes. To change the amount of time until the on-screen menu closes, press **enter** and select **Setup > Timeout for menu**.



TIP: To exit from any on-screen menu or adjustment, press the exit ↵ button.

Changing the default settings

The on-screen menus enable you to return selected or all projector settings to saved default values. These values are originally the factory defaults, but you may prefer to replace the factory defaults with a custom set of your own, using the following procedure. (You can also restore the original factory defaults if needed.)



NOTE: This procedure will normally be performed by a system administrator.

1. Press **enter** on the projector or remote control. This displays the on-screen menu.
2. Use the on-screen menus to select the desired settings for all inputs and picture modes.
3. Select **Help > Diagnostics...**
4. On the remote or the projector, press the up and down buttons in this sequence to open the default settings menu:
up – up – down – down – up – down (▲ ▲ ▼ ▼ ▲ ▼)
5. Press **enter** to save the projector's current settings as the new defaults. (You can also press the exit ↵ button to restore the original factory default settings.)

Setup menu

Setup menu

Keystone	Corrects the slanted sides of the picture. This compensates for a projector that is too high or low relative to the screen.
Reset keystone	Resets the keystone correction to zero (no correction).
Volume	Adjusts the loudness of the projector's audio (certain models only).
Mute	Temporarily turns off the projector's audio (certain models only).
Projector position	Adjusts the picture to match the orientation of the projector: upright or upside-down, in front of or behind the screen. Inverts or reverses the image accordingly.
Lamp saver	Sets a lower power level for the lamp.
Language...	Selects the language used by the on-screen menu.
Hide	Hides the picture and mutes the sound.
Advanced setup...	Adjusts additional setup settings.
Power timeout	Sets the length of time the projector waits for an input signal before automatically shutting down.
Clean edges	Enlarges and clips video images to remove noise from picture edges.
Timeout for menu	Sets how many seconds the on-screen menu waits for input before it closes.
Horizontal size	Fine-tunes the width of the image for multi-projector setups.
Reset lamp hours	For a new lamp, resets the hours of use.
Projector lock...	Sets or cancels a secret button sequence that must be entered for the projector to operate.
Reset all settings	Restores all menu settings to factory default settings.

Picture menu

Changing these settings affects only the active source. Some picture adjustments are available only when certain input ports are in use. Unavailable adjustments are shown in gray in the on-screen menu.

Picture menu

Color settings...	Adjusts the picture and colors.
Brightness	Brightens or darkens the picture.
Contrast	Sets the difference between light and dark areas.
Sharpness	Sharpens or softens the picture.
Color saturation	Adjusts the intensity of colors.
Tint	Shifts colors toward red or green.
Reset color settings	Restores these color settings to the default settings.
Advanced color...	Adjusts the individual colors in the picture.
Red	Adjusts the amount of red in the picture.
Green	Adjusts the amount of green in the picture.
Blue	Adjusts the amount of blue in the picture.
Reset advanced settings	Restores the advanced color settings to their default values.

Picture menu (continued)

VGA settings...	Adjusts settings for a computer input.
Auto-sync	Resynchronizes the projector with the input. If a VGA input image looks incorrect, press auto-sync to try correcting the image.
Frequency	Adjusts the timing of the projector relative to the computer.
Tracking	Adjusts the phase of the projector relative to the computer.
Vertical offset	Adjusts the picture up or down within the projection area.
Horizontal offset	Adjusts the picture left or right within the projection area.
Picture mode	Adjusts color and picture settings to one of several combinations designed for different types of viewing situations. You can use a different picture mode for each source or each viewing environment. You can also customize each picture mode.
Customize picture mode...	Changes settings associated with the current picture mode.
Picture enhancement	Refines the color, lightness, and other characteristics of the picture.
White intensity	Increases the brightness of white areas.
Color temperature	Shifts color toward red or blue.
Aspect ratio	Selects how the picture fits on the screen: <ul style="list-style-type: none">• Best fit automatically fits the picture without stretching it.• 1-to-1 shows each picture dot as one projected dot.• Reduced fits a standard-shape picture onto a widescreen projection screen.• Full uses the entire projector resolution screen size, with stretching permitted.
Reset this picture mode	Restores the current picture mode to its default settings.

Source menu

For a visual aid, see “Back panel” on page 10.

Source menu

VGA	Shows the source connected to the VGA-in port.
Composite video	Shows the source connected to the composite-video port.
S-video	Shows the source connected to the S-video port.
Component	Shows the source connected to the component video port (available only on certain models).
DVI	Shows the source connected to the DVI port (available only on certain models).
Source scan	Sets whether the projector automatically searches for input signals and displays the next one found.
Widescreen input	Sets whether a widescreen (16:9) input device is in use. Adjusts the height of the picture accordingly.

Help menu

Help

	Displays information and status of the projector.
Diagnostics...	Show tests for checking the operation of the projector and the remote control.
HP digital projector	Displays information about the projector and any network connection.

4 Maintaining the Projector

Performing routine maintenance

Getting the projector status

To get the projector status:

- ▲ Press the **enter** button on the projector or remote control and go to **Help**.

This screen shows information and status for the projector.

Cleaning the projector lens

You can clean the front lens of the projector using the following recommendations. You cannot clean any of the internal surfaces.

- To minimize the risk of damaging or scratching the lens surface, blow dust particles off the lens with clean, dry, deionized air.
- If this method does not work, use the following method:
 - a. Wipe the lens in a single direction with a clean, dry cloth. Do not wipe back and forth across the lens.
 - b. If the cloth is dirty or smears the lens, wash the cloth. If the cloth is still dirty after washing it or the fabric is damaged, replace it.



CAUTION: Cleaning requires special consideration:

- Do not spray any type of fluid or cleaner directly on the lens surface. Cleaners might damage the lens.
 - Do not use fabric softener when washing a cleaning cloth or softener sheets when drying the cloth. Chemicals on the cloth might damage the surface of the lens.
 - Do not store a cleaning cloth in contact with the lens for a long time because doing so contaminates the lens with dye from the cloth. The cloth can be contaminated if left in the open air.
-

Replacing the lamp module

As the projector operates over time, the brightness of the projector lamp gradually decreases and the lamp becomes more susceptible to breakage. You can install a new lamp at any time to bring the projector up to factory-fresh brightness. We recommend replacing the lamp if a warning message is displayed.



WARNING! Replacing the lamp module requires special consideration:

- To reduce the risk of injury, be careful when removing the lamp module as broken glass might be present. HP also recommends wearing goggles and gloves when removing the lamp module. If the lamp is broken, contact HP about repairs that might be required due to glass fragments.
- The lamp in this digital projector contains mercury. If the lamp breaks, adequately ventilate the immediate area, discard any nearby food and drink, and thoroughly clean the table surface around the projector. Wash your hands after cleaning the area or handling a broken lamp. Note that disposal of this lamp may be regulated under applicable environmental laws due to presence of mercury. For disposal or recycling information, please contact your local authorities or the Electronic Industries Alliance (www.eiae.org). For additional safety information about the lamp in this digital projector, please see: www.hp.com/hpinfo/globalcitizenship/environment/productdata
- Because the lamp assembly operates at a very high temperature, wait 30 minutes before removing the lamp module.

-
1. Turn off the projector and allow it to cool for 30 minutes.
 2. If the projector is installed in a ceiling mount, remove it from the mount.
 3. Unplug the power cord.

4. Loosen the two screws in the lamp cover ❶ and remove the cover ❷.

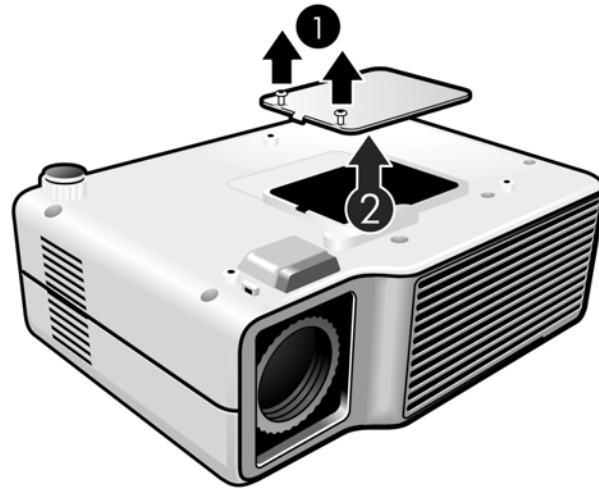

5. Remove the two screws ❸ from the lamp module, raise the handle ❹, and lift out the module ❺.

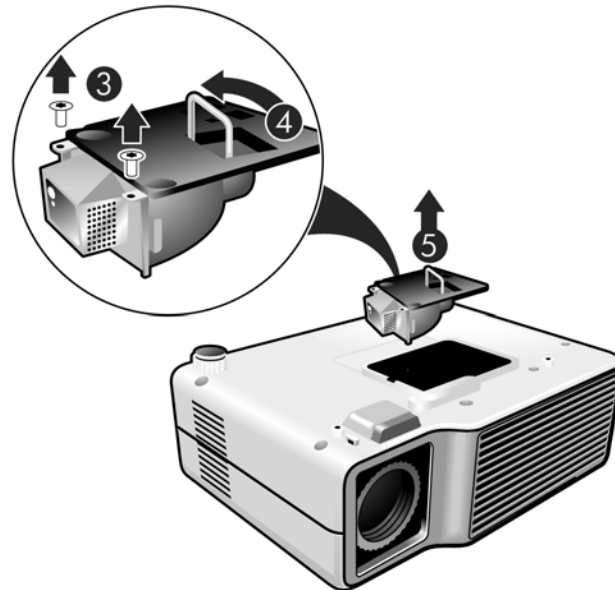

6. Insert the new lamp module into the projector and tighten the two screws.
7. Replace the lamp cover and tighten the two screws.
8. Turn on the projector. If the lamp does not turn on after the warm-up period, try reinstalling the lamp.
9. Press **enter**, go to **Setup > Advanced setup > Reset lamp hours**, and press **enter**.

Replacing the battery in the remote control

1. Use a ballpoint pen to hold the battery latch toward the center, then pull out the battery holder ❶.
2. Insert the new battery ❷ in the holder.
3. Push the holder ❸ into the remote control.

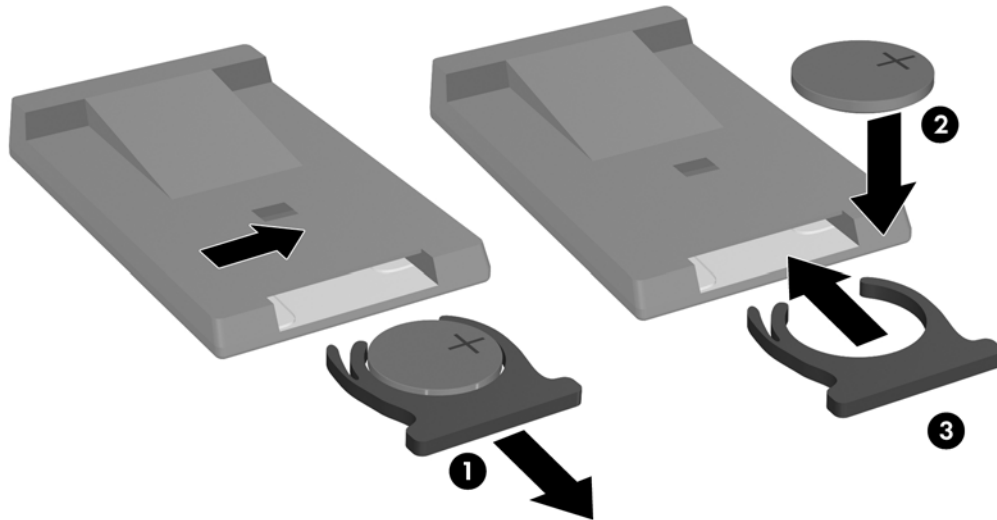

When discarding old batteries, contact your local waste-disposal provider regarding local restrictions on the disposal or recycling of batteries.



Upgrading the projector

Updating the firmware

HP might periodically release updated versions of the projector firmware to enhance the projector performance. The projector firmware version is shown in the on-screen menu at **Help**. Check for updated versions at <http://www.hp.com/support>.

USB method

1. On a computer with a USB port, go to the HP projector upgrade website (see introduction for this section) and download the latest file intended for the xp7010/xp7030 series projector.
2. Connect a USB cable (available from HP) to the USB port on the computer. Do not connect the cable to the projector at this point.
3. On the computer, run the file you downloaded by double-clicking the file.
4. Follow the on-screen instructions. When prompted, connect the USB cable to the projector.



NOTE: Be sure to follow the “new hardware found” instructions exactly as shown on-screen, or the firmware will not be updated.

5 Installing Permanently

Installing the projector

Choosing cables

If you are permanently installing the projector or using it with long cables, consider the following suggestions when planning the installation:

- Use high-quality cables. Use only video cables that are made with 75-ohm cable and connectors. For high-resolution video, use low-loss video cables. For standard audio, use audio cables that are shielded.
- Minimize cable length as much as possible. For video cables longer than 6 m (20 ft), use low-loss cables. For standard audio cables longer than 6 m (20 ft), use 12-gauge wire.
- Do not run audio or video cables next to power or network cables. If they must cross, cross them at 90 degrees.
- If you are installing cables in walls, use cables with necessary approvals, such as Underwriters Laboratories (UL) approval.
- If you are running cables above a dropped ceiling, you must use plenum-rated cables if the space above the ceiling is open to the space above other rooms. You must use plenum-rated cables if you are running cables in a duct.
- Before installing cables permanently, check the setup with the final cables in the open.

Installing on a table

This installation is covered in detail in Chapter 1. See “Setting up the projector,” for more information.

Installing on the ceiling



WARNING! To minimize the risk of injury from improperly installed equipment, it is recommended that a professional installer performs the ceiling installation.

1. Attach the projector to the ceiling using an HP ceiling mount kit. Refer to the installation instructions provided with the ceiling mount kit.
2. After the projector is mounted on the ceiling, adjust the projector settings to match this setup. Press **enter**, go to **Setup > Projector position**, and select **Front Ceiling**.

Installing for rear projection

1. Place the projector 1.2 to 10 m (4 to 33 ft) behind a translucent screen that is designed for rear projection.
See "Setting up the projector," or "Installing on the ceiling," above, for more instructions.
2. Press **enter**, go to **Setup > Projector position**. Then select **Rear Table** or **Rear Ceiling**.

Locking the projector

The projector includes a built in slot to secure the projector with a cable and lock (such as the Kensington MicroSaver lock system, available at many computer stores).

1. Wrap the cable around a secure object, such as a table leg. Loop the cable to create a slip knot around the stationary object, and be sure it cannot slip off.
2. Insert the lock ❶ into the hole and twist the key ❷.

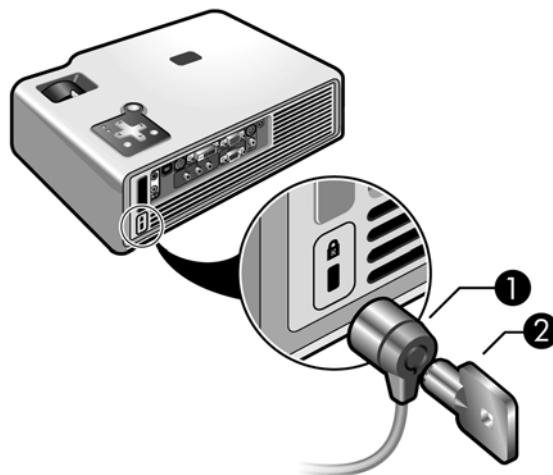

Controlling an external accessory

If your projector has a 12-volt trigger output port, the projector can automatically control one or more accessories. Certain types of accessories can use a 12-volt signal to trigger their actions, such as a motorized screen lowering and raising the screen. The output provides a 12-volt dc signal whenever the projector is on (200 mA maximum current output).

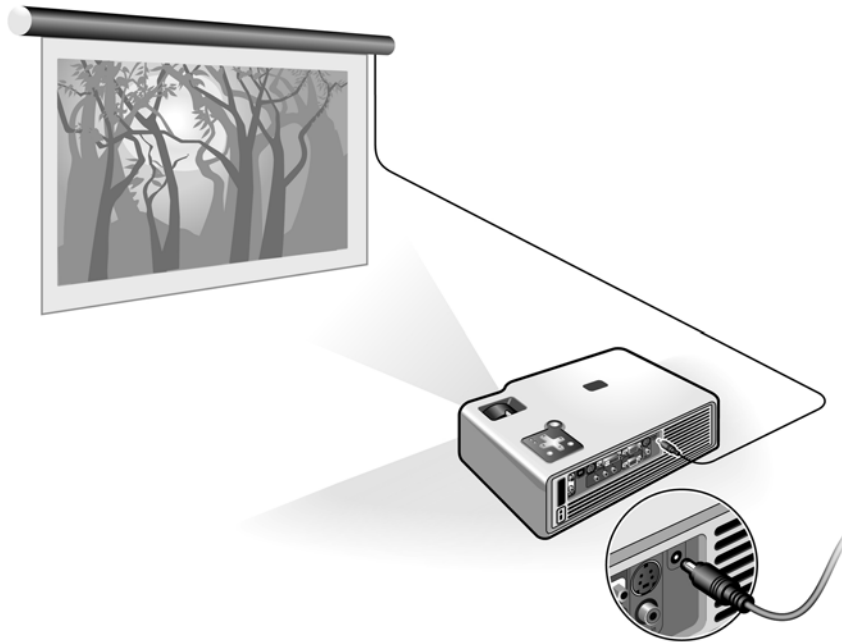

Requires:

- Two-wire cable with 3.5-mm × 1.3-mm barrel connector (+12 V on inner contact) with the following specifications.

+12V output electrical specification

Parameter	Value
Output voltage	12 +/- 10% V
Output ripple	0.1 V _{pp}
Maximum output current	200 mA
Maximum rush current	2.0 A
Maximum rush current duration	10 ms

Connecting to a room controller

If your projector has a serial port, you can connect the projector to a room controller using a serial (RS-232) cable. After you program the room controller using the following commands, you can use the room controller to operate the projector and other components of your installation.

Serial connections

The serial port on the projector uses a female, mini-DIN 6, RS-232 connector:

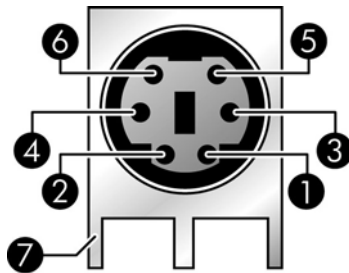

- Pin ③: data sent to the projector (RX)
- Pin ⑤: data sent from the projector (TX)
- Pins ①, ④, and ⑥: not connected
- Pin ②: ground (GND)
- ⑦: metal frame (shroud)

The room controller must use the following serial (RS-232) settings:

- 9600 baud
- 1 start bit + 8 data bits (D0=LSB, D7=MSB) + 1 stop bit
- No parity
- Full duplex communication channels (no flow control)
- No handshaking



TIP: Go to <http://www.hp.com/support> for additional information.

Examples of room controller commands

In the following examples, “<CR>” and “<LF>” represent a carriage return and line feed, respectively.

Commands are sent to the projector as “requests” which consist of an asterisk (*) prefix, the command name, any needed parameter, and a carriage return <CR> as a terminator:

* command = parameter <CR>

Requests can contain only ASCII alphanumeric characters. Blanks (spaces) are allowed, except within keywords and numbers. Line feeds <LF> are ignored.

The following table shows the specific syntax to use for various requested tasks.

To perform this task...	Use this request syntax...
Change a setting to a specified value	*command=value<CR>
Ask the current setting	*command=?<CR>
Increment a setting	*command=+<CR>
Decrement a setting	*command=-<CR>
Invoke an action (no parameter needed)	*command<CR>

In general, every request sent to the projector generates one or more notification messages, which are sent to the room controller. Actions initiated by the projector can also generate notifications.

The projector always sends notifications whenever a setting changes, whether as the result of a request from a controller, or as the result of an action, such as a button press or menu change. Some requested setting changes take time to perform, or are carried out in stages. Because of this, requests might produce delayed notifications.

The following table lists the types of notifications generated in various situations.

This type of request...	Generates this type of notification...
Modify a setting	Echoes the request command and shows the resulting value: Request: *BRT=65<CR> Notification: *BRT=65<CR><LF>
Query a setting	Echoes the request command and shows the resulting value: Request: *CON=?<CR> Notification: *CON=40<CR><LF>
Execute an action	Echoes the request command: Request: *NXT<CR> Notification: *NXT<CR><LF>

Incorrect commands cause the following types of notifications:

- No asterisk at start of command—no response
- Unrecognized command name—command with “?” added
- Command that is currently unavailable—command with “?” added
- Invalid parameter—command with current value
- Action command with unnecessary parameter—action command
- Action command that is unavailable—action command

The following simplified example shows how the projector typically responds to a request to change the active input source. Note that the three latter notifications are delayed.

Request: *RSRC=4<CR>
Notification: *RSRC=4<CR><LF> (acknowledges request)
 *SRC=0<CR><LF> (projector is attempting to acquire source 4, and in the interim has no valid source)
 *SRC=4<CR><LF> (source 4 is now active)
 *BRT=60<CR><LF> (brightness has been modified for source 4)
 *CSPC=?<CR><LF> (color space is not supported for this input)

Room controller commands

In the following tables, if the parameter listing for a particular command is “None,” that command requires no parameter. Some commands are valid only when the projector is turned on, STAT=1. Some commands are available only when specific input sources are active.

Source function

Command	Parameters	Description
SRC	?	Queries the current active input source: 0=no active source, 1=VGA-in, 3=composite video, 4=S-video, 8=DVI.
RSRC	1, 3, 4, 8, ?	Attempts to use the specified source as the active input source, or queries the last source requested: 1=VGA-in, 3=composite video, 4=S-video, 8=DVI.
NXT	None	Switches to the next input source.
AUTO	0, 1, ?	Sets or queries automatic searching inputs for signal: 0=no searching, 1=searching.

Video functions

Command	Parameters	Description
CSPC	0 to 2, ?	Sets or queries the active color space: 0=RGB, 1=YpPr, 2=YCbCr.
PMOD	0,1,5,?	Sets or queries the picture mode: 0=graphics, 1=video, 5=custom.
VSHF	<i>value</i> , +, -, ?	Sets or queries the vertical shift of the projected image: usable range is determined by the active input source.
HSHF	<i>value</i> , +, -, ?	Sets or queries the horizontal shift of the projected image: usable range is determined by the active input source.
WHIT	0 to 10, +, -, ?	Sets or queries the white intensity.
BRT	0 to 100, +, -, ?	Sets or queries the brightness.
CON	0 to 100, +, -, ?	Sets or queries the contrast.
SAT	0 to 100, +, -, ?	Sets or queries the color saturation.

Video functions (continued)

Command	Parameters	Description
TNT	-45 to 45, +, -, ?	Sets or queries the tint.
RADJ	-50 to 50, +, -, ?	Sets or queries the amount of red.
GADJ	-50 to 50, +, -, ?	Sets or queries the amount of green.
BADJ	-50 to 50, +, -, ?	Sets or queries the amount of blue.
CTMP	0 to 2, ?	Sets or queries the color temperature: 0=warm, 1=neutral, 2=cool.
SHRP	0 to 12, +, -, ?	Sets or queries the sharpness.
PENH	0 to 6, +, -, ?	Sets or queries the picture enhancement setting.
KEYV	-50 to 50, +, -, ?	Sets or queries the vertical keystone: 0=no keystone adjustment, 1 to 50=shrinks the top of the display, -1 to -50=shrinks the bottom of the display.
ASPT	0, 1, 4, ?	Sets or queries the aspect ratio: 0=1-to-1, 1=Best Fit, 4=Reduced.
SYNC	None	Automatically resynchronizes the projector to the active computer input source.
FREQ	-50 to 50, +, -, ?	Sets or queries the projector's timing relative to the active computer input source.
TRK	<i>value</i> , +, -, ?	Sets or queries the synchronization of the projector to the active computer input source.
VPOS	<i>value</i> , +, -, ?	Sets or queries the vertical positioning of the projected image: usable range is the maximum and minimum allowed by the active computer input source.
HPOS	<i>value</i> , +, -, ?	Sets or queries the horizontal positioning of the projected image: usable range is the maximum and minimum allowed by the active computer input source.
HIDE	0, 1, ?	Sets or queries picture blanking: 0=not hidden, 1=hidden.
WIDE	0, 1, ?	Sets or queries wide screen mode: 0=normal, 1=wide.
KEYR	None	Resets keystone to zero.

Audio functions

Command	Parameters	Description
MUTE	0, 1, ?	Sets or queries audio muting: 0=not muted, 1=muted.
VOL	0 to 31, +, -, ?	Sets or queries audio volume: 0=off, 31=maximum.
INTSP	0, 1, ?	Sets or queries usage of the internal speaker (certain models only): 0=disabled, 1=enabled.

Setup functions

Command	Parameters	Description
LANG	0 to 10, ?	Sets or queries the language used by the projector: 0=English, 1=French, 2=Italian, 3=German, 4=Portuguese, 5=Spanish, 6=Traditional Chinese, 7=Simplified Chinese, 8=Korean, 9=Japanese, 10=Czech.
LSAV	0, 1, ?	Sets or queries low-power operating mode: 0=normal power, 1=low power.
LHRS	?	Queries the time (in tenths of hours) that the lamp has been in use.
THRS	?	Queries the total time (in tenths of hours) that the projector has been in use.
POS	0 to 3, ?	Sets or queries the projector's position: 0=front table, 1=front ceiling, 2=rear table, 3=rear ceiling.
TMO	5 to 120, ?	Sets or queries the menu timeout setting (seconds)
PTMO	0, 3 to 6, ?	Sets or queries the power timeout: 0=never, 3=15 min, 4=30 min, 5=60 min, 6=120 min.
EDGE	0, 1, ?	Sets or queries the cleaning of noise from edges of image: 0=no cleaning, 1=cleaning.
VERS	?	Queries the projector model number and firmware version. The notification takes this form: *VERS="proj_model:proj_fw"

Setup functions (continued)

Command	Parameters	Description
FWVERS	?	Queries the projector firmware model number and firmware version. Similar to VERS, but used to verify that a firmware update image is appropriate for the projector. The notification takes this form: *VERS="proj_model:M.mmm"
IPADDR	<i>Hex IP address, ?</i>	Used by network module to tell projector the IP address to display in the help menu.
SNET	<i>Hex subnet mask, ?</i>	Used by network module to tell projector the subnet mask to display in the help menu.
MAC	<i>Hex MAC address, ?</i>	Used by network module to tell projector the MAC address to display in the help menu.
SNUM	?	Queries the projector's serial number.
RSET	None	Restores all settings to defaults.

Power and status functions

Command	Parameters	Description
SHDN	None	Puts the projector into cool-down state, and later into standby state. The projector sends a notification when it enters cool-down state (STAT=3), and another when it enters standby state (STAT=0). This keyword requires the projector to be in its on state (STAT=1). Do not send any requests other than STAT in the time between the cool-down and standby state notifications. Otherwise, unexpected results can occur.
W or WAKE	None	Puts the projector into warm-up state, and later into on state. The projector sends a notification when it enters warm-up state (STAT=2), and another when it enters the on state (STAT=1). This keyword requires the projector to be in standby state (STAT=0). Do not send any requests other than STAT in the time between the warm-up and on state notifications. Otherwise, unexpected results can occur.

Power and status functions (continued)

Command	Parameters	Description
STAT	?	Queries the projector's current state: 0=standby state (off), 1=on, 2=warm-up state, 3=cool-down state.
ALERT	Not a request	Notifies when a system alert condition occurs: 0=lamp life warning, 1=lamp life reached, 2=lamp faulty, 3=lamp problem, 4=internal temperature too high, 5=fan problem, 6=ambient temperature too high, 7=color wheel problem, 8=lamp cover open, 9=ballast faulty. ALERT is sent only by the projector, and cannot be used in requests.

Simulated key presses

Command	Parameters	Description
BACK	None	Simulates pressing the Exit Arrow key on keypad
ENTER	None	Simulates pressing the ENTER key on keypad
LEFT	None	Simulates pressing the Left Arrow key on keypad
RIGHT	None	Simulates pressing the Right Arrow key on keypad
UP	None	Simulates pressing the Up Arrow key on keypad
DOWN	None	Simulates pressing the Down Arrow key on keypad

6 Fixing Problems

Troubleshooting suggestions

If you have a problem with your projector, check the following statement that most closely matches the nature of the problem, then look in that section of this chapter:

- “Warning light problems” on page 55
- “Start-up problems” on page 56
- “Picture problems” on page 56
- “Sound problems” on page 59
- “Interruption problems” on page 59
- “Remote control problems” on page 60



TIP: If these suggestions do not solve your problem, go to <http://www.hp.com/support> for additional information. To contact HP, refer to the support guide included with the projector.

Warning light problems

If both red warning lights are blinking:

- Allow the projector to cool down after it turns off. If this condition occurs after you restart the projector, an internal component has failed. Contact HP for assistance.

If the red temperature light is on:

- Allow the projector to cool down after it turns off. Be sure that nothing is near or blocking the vents on the projector, and that the vents are free of lint and other objects. Remove any sources of excess heat in the room. Observe temperature and altitude limits (see “Specifications” on page 61). If the warning light turns on or blinks after you restart the projector, contact HP for assistance.

If the red temperature light is blinking:

- Contact HP for assistance.

If the red lamp light is on:

- Install a new lamp. If the lamp light is on after you install a new lamp module, remove and reinstall the lamp module. If a new lamp does not fix the problem, contact HP for assistance.

If the red lamp light is blinking:

- Contact HP for assistance.

If the red lamp light is flickering quickly:

- Check that the cover over the lamp at the side of the projector is correctly installed and fully attached. Check the tab at the top of the cover and latch at the bottom.

Start-up problems

If no lights or sounds turn on:

- Be sure that the power cable is securely connected to the projector and the other end is plugged into an outlet with power.
- Be sure the disconnect switch is turned on.
- Press the power button again.
- Unplug the power cord for 15 seconds, then plug it in and press the power button again.

Picture problems

If a “scanning” or “waiting” message is displayed on a blank screen:

- Press the **source** button on the projector or remote control one or more times until the correct source name is selected.
- Be sure the external source is turned on and connected.
- For a computer connection, ensure your notebook computer’s external video port is turned on. Refer to the computer manual. On some notebooks, for example, press the FN+F4 or FN+F5 function keys to turn on the external video port.

If the wrong input source is displayed:

- Press the **source** button on the projector or the remote control one or more times to select another active input source.

If the image is out of focus:

- Be sure the lens cover is open.
- While displaying the on-screen menu, adjust the focus ring. (The image size should not change; if it does, you are adjusting the zoom, not the focus.)
- Ensure the projection screen is 1.2 to 10 m (4 to 33 ft) from the projector.
- Check the projection lens to see if it needs cleaning.
- For a computer connection, set the display resolution as the computer to the same resolution as the projector, 800 × 600 or 1024 × 768 (see “Specifications” on page 61). If the computer has multiple monitors, adjust the resolution of the monitor assigned to the projector.
- For a computer connected to the S-video port, the picture cannot be as high resolution as what you see on the computer display.

If an upside-down or reversed image is displayed:

- The projector has been set to the wrong position setting. Press **enter**, go to **Setup > Projector position**, and select the correct setting.

If the image is too small or too large:

- Adjust the zoom ring on top of the projector.
- Move the projector closer to or farther from the screen.
- On the projector or remote control, press the picture mode  button one or more times to see if one of the picture modes makes the image the correct size.
- Press **enter**, go to **Picture > Customize picture mode > Aspect ratio**. Try the different settings.
- If the source device sends wide-screen output, press **enter**, go to **Source**, and try setting **Widescreen input** to **On**. Otherwise, set it to **Off**.

If the image has slanted sides:

- As much as possible, reposition the projector so that it is centered on the screen and below the bottom or above the top of the screen.
- On the projector, press **enter**, go to **Setup > Keystone**, and adjust until the sides are vertical.

If the image is stretched:

- On the projector or remote control, press the picture mode  button one or more times to see if one of the picture modes makes the image the correct size.
- Press **enter**, go to **Picture > Customize picture mode > Aspect ratio**. Try the different settings.
- If the source device sends wide-screen output, press **enter**, go to **Source**, and try setting **Widescreen input** to **On**. Otherwise, set it to **Off**.

If the projected colors seem slightly wrong:

- See “Adjusting the picture for best color” on page 32.
- Press **enter**, go to **Help > Diagnostics**, and run the color test.

If the projected colors seem completely wrong:

- Be sure the pins on the cable connectors are not bent or broken.
- Press **enter**, go to **Help > Diagnostics**, and run the color test.
- Press **enter**, go to **Picture > Color settings > Reset color settings**, and press **enter**.
- Press **enter**, go to **Setup > Advanced settings > Reset all settings**, and press **enter**.

If the picture is not clear (ghost images, smearing, poor quality):

- Be sure the video cable you are using is coaxial cable rated at 75 ohms. Any other cable or impedance rating can reduce picture quality.
- The video cable connecting the video source to the projector probably must be higher quality. See “Choosing cables” on page 44.

If several picture settings seem completely wrong and you cannot fix them:

- Press **enter**, go to **Picture > Color settings > Reset color settings**, and press **enter**.
- Press **enter**, go to **Setup > Advanced settings > Reset all settings**, and press **enter**.

If a scrolling or cut-off image is displayed for a computer connection:

- Press the **auto sync** button on the projector or remote control.
- Turn everything off. Then power on the projector first and power on the notebook or desktop computer second.
- If the previous steps do not correct the display image, adjust the resolution of the notebook or desktop computer to the same resolution as the projector, 800 × 600 or 1024 × 768 (see “Specifications” on page 61). If the computer has multiple monitors, adjust the resolution of the monitor assigned to the projector.

If the image is flickering or unstable for a computer connection:

- Press the **auto sync** button on the projector or remote control.
- Press **enter**, go to **Picture > VGA settings**, and adjust **Frequency** or **Tracking**.

If the image disappears from the computer screen:

- For a notebook computer, you might be able to turn on both the external VGA port and the built-in screen. Refer to the computer manual.
- Connect a monitor to the VGA-out port.

If text or lines from a computer display seem rough or uneven:

- Check the focus adjustment.
- Press **enter**, go to **Setup > Reset keystone**, and press **enter**.

Sound problems

If no sound is coming out of the projector:

- Be sure you have an audio cable securely connected between the projector and the source device.
- Press **enter**, go to **Setup**, and check that **Mute** is set to **Not muted** and **Volume** is correct.
- Press **enter**, go to **Help > Diagnostics**, and run the sound test.
- Be sure that the mute and volume settings are correct on the source device, such as a VCR, camcorder, or computer.

Interruption problems

If the projector stops responding to all controls:

- If possible, turn off the projector, then unplug the power cord and wait at least 15 seconds before reconnecting power.

If the lamp shuts off during a show:

- A minor power surge might cause the lamp to shut off. This is normal. Wait a few minutes, then power on the projector.
- If a red warning light is on or blinking, see “Warning light problems” on page 55.

If the lamp burns out or makes a popping sound:

- If the lamp burns out and makes a popping sound, the projector will not turn back on until the lamp module has been replaced.
- If the lamp breaks, contact HP about repairs that might be required due to glass fragments.

Remote control problems

If the remote control does not operate:

- Be sure nothing is blocking the remote control receiver on the front or back of the projector. Move to within 8 m (26 ft) of the projector.
- Aim the remote control at the screen or at the front or back of the projector.
- Move the remote control so it is more directly in front of or behind the projector and not as far to the side.
- Press **enter**, go to **Help > Diagnostics**, and run the remote control test.
- Replace the battery in the remote control.

Testing the projector

Running the projector diagnostics

The on-screen menu contains diagnostic tests you can use to verify the proper operation of the projector and the remote control.

1. Press **enter** and go to **Help > Diagnostics**.
2. Select a test and press **enter**.
3. Follow the displayed instructions.

7 Reference

This chapter lists the specifications, safety information, and regulatory information for the projector.

Specifications

Because HP continually improves its products, the following specifications are subject to change. For the latest specifications, visit the HP website at <http://www.hp.com>.

Projector specifications

Size	309 × 229 × 102 mm (12.2 × 9.0 × 4.0 in.)
Weight	3.3 kg (7.3 lb)
Resolution	XGA (1024 × 768)
Technology	DLP
Video connectors	VGA-in (D-sub) with optional cable for component-video input VGA-out (D-sub) S-video (mini-DIN) Composite video (RCA) DVI-D (available only on certain models) RCA component video (available only on certain models)
Audio connectors	Stereo-in and out (2 mini-phone, available only on certain models)
Other connectors	USB 1.1 type B RS-232 control 12-Vdc trigger output (available only on certain models)

Projector specifications (continued)

Video compatibility	NTSC-M NTSC 4.43 MHz PAL-60 PAL B, D, G, H, I, M, N SECAM: B, D, G, K, K1, L HDTV (480i/p, 576i/p, 720p, 1080i) DVI with HDCP (available only on certain models)
IR receivers	Front and back of projector
Lamp	300-watt lamp 2000-hour average lamp life (to half of original brightness) Lamp saver mode reduces lamp power to 250 watts, extends life to 3000 hours Replacement lamp: L2139A
Optics	1.2 to 10 m (4 to 33 ft) focus range 7.2 to 8.6 m (23.6 to 28.3 ft) focal length 1.2:1 optical zoom Throw ratio (distance/width) Wide: 1.641 Tele: 1.969 115% \pm 5% offset (relative to half-height)
Light engine	0.7-in. 12° DDR DMD
Audio	Monaural speaker, 2-watt peak output (certain models only)
Noise level	Less than 35 dBA in Normal mode, or 32 dBA in lamp saver mode
Vertical tilt	0° to 8°
Vertical keystone correction	\pm 15%
Remote control	USB mouse
Mounting options	Ceiling and tabletop, front and rear projection
Lens cap	Detachable with connecting leash
Security	Kensington lock compatible Unlock sequence protects against unauthorized use

Projector specifications (continued)

Power	100 to 240 V at 50 to 60 Hz
Environment	Operating: Temperature: 10 to 35 °C (50 to 95 °F) Humidity: 80% RH max, non-condensing Altitude: up to 3,000 m (10,000 ft), up to 25 °C (77 °F) Storage: Temperature: -20 to 55 °C (-4 to 131 °F) Humidity: 80% RH max, non-condensing Altitude: up to 12,000 m (40,000 ft)

Video mode compatibility

Compatibility	Resolution	Refresh rates (Hz)
Analog		
VGA	640 × 350	70, 85
	640 × 400	85
	640 × 480	60, 72, 75, 85
	720 × 400	70, 85
SVGA	800 × 600	56, 60, 72, 75, 85
XGA	1024 × 768	60, 70, 75, 85
SXGA	1280 × 1024	60, 75
SXGA+	1400 × 1050	60

Safety information

Mercury safety



WARNING! The lamp in this digital projector contains mercury. If the lamp breaks, adequately ventilate the immediate area, discard any nearby food and drink, and thoroughly clean the table surface around the projector. Wash your hands after cleaning the area or handling a broken lamp. Note that disposal of this lamp may be regulated under applicable environmental laws due to presence of mercury. For disposal or recycling information, please contact your local authorities or the Electronic Industries Alliance (www.eiae.org). For additional safety information about the lamp in this digital projector, please see: www.hp.com/hpinfo/globalcitizenship/environment/productdata

Regulatory information

This section presents information that shows how your digital projector complies with regulations in certain regions. Any modifications to your digital projector not expressly approved by HP could void the authority to operate the digital projector in these regions.

U.S.A.

This digital projector has been tested and found to comply with the limits for a Class B digital device, pursuant to Part 15 of the FCC Rules. These limits are designed to provide reasonable protection against harmful interference in a residential installation.

This digital projector generates, uses, and can radiate radio frequency energy. If not installed and used in accordance with the instructions, it can cause harmful interference to radio communications. However, there is no guarantee that interference will not occur in a particular installation. If this digital projector does cause harmful interference to radio or television reception (which can be determined by unplugging the unit), try the following:

- Reorienting or relocating the receiving antenna.
- Relocating the digital projector with respect to the receiver.
- Connecting the digital projector's power cord to another power outlet.

Connections to peripheral devices

To maintain compliance with FCC Rules and Regulations, use properly shielded cables with this device.

For more information, consult your dealer, an experienced radio/television technician, or, prepared by the Federal Communications Commission, How to Identify and Resolve Radio-TV Interference Problems. This booklet is available from the U.S. Government Printing Office, Washington, DC 20402, Stock Number 004-000-00345-4. At the first printing of this manual, the telephone number was 202-512-1800.

Canada

This Class B digital apparatus complies with Canadian ICES-003.

Japan

この装置は、情報処理装置等電波障害自主規制協議会（VCCI）の基準に基づくクラスB情報技術装置です。この装置は、家庭環境で使用することを目的としていますが、この装置がラジオやテレビジョン受信機に近接して使用されると受信障害を引き起こすことがあります。

取り扱い説明書に従って正しい取り扱いをして下さい。

製品には、同梱された電源コードをお使い下さい。
同梱された電源コードは、他の製品では使用出来ません。

Korea

사용자 안내문 : B 급 기기

이 기기는 비업무용으로 전자파적합등록을 받은 기기이오니, 주거지역에서는 물론, 모든 지역에서 사용 하실 수 있습니다.

International

For regulatory identification purposes, your product is assigned a regulatory model number. The regulatory model number for your product is listed in the declaration of conformity. This regulatory number is different from the marketing name and product number.

Regulatory model number: CRVSB-05LE

Declaration of conformity

According to ISO/IEC Guide 22 and EN 45014
Manufacturer's name: Hewlett Packard Company
Manufacturer's address: Hewlett Packard Company
Display Technologies and Products
1000 NE Circle Blvd.
Corvallis, OR 97330-4239

Declares, that the product(s):
Product name: Digital Projector
Model numbers: xp7010, xp7030 series
Regulatory model: CRVSB-05LE

Conforms to the following Product Specifications:

Safety:

IEC 60950-1: 2001 / EN 60950-1: 2001
GB4943-1995

EMC:

EN 55022 +A1:2000 +A2:2003 [1]
CISPR 24:1997 / EN 55024:1998 + A1:2001 +A2:2003
IEC 61000-3-2:1995 / EN 61000-3-2:2000
IEC 61000-3-3:1994 / EN 61000-3-3:1995+A1:2001
GB9254-1998
FCC Title 47 CFR, Part 15 Class B/ANSI C63.4: 2003
AS/NZS 3548: 1995 Rules and Regulations of Class B
VCCI

Supplementary information:

The product herewith complies with the requirements of following Directives and carries the CE marking accordingly:

- Low Voltage Directive: 73/23/EEC
- EMC Directive: 89/336/EEC

[1] The product was tested in a typical configuration with Hewlett Packard Personal Computer peripherals.

This device complies with Part 15 of the FCC Rules. Operation is subject to the following two conditions: (1) This device may not cause harmful interference, and (2) this device must accept any interference received, including interference that may cause undesired operation.

Corvallis, Oregon, October 5, 2005



A handwritten signature in black ink, appearing to read 'Steve Brown'.

Steve Brown, General Manager

European Contact for regulatory topics only: Hewlett Packard GmbH, HQ-TRE, Herrenberger Straße 140,
71034 Boeblingen, Germany. (FAX:+49-7031-143143).
USA Contact: Hewlett Packard Co., Corporate Product Regulations Manager, 3000 Hanover Street, Palo Alto, CA 94304.
Phone: (650) 857-1501.

Recycling information



English

Disposal of Waste Equipment by Users in Private Households in the European Union

This symbol on the product or on its packaging indicates that this product must not be disposed of with your other household waste. Instead, it is your responsibility to dispose of your waste equipment by handing it over to a designated collection point for the recycling of waste electrical and electronic equipment. The separate collection and recycling of your waste equipment at the time of disposal will help to conserve natural resources and ensure that it is recycled in a manner that protects human health and the environment. For more information about where you can drop off your waste equipment for recycling, please contact your local city office, your household waste disposal service or the shop where you purchased the product.

Français

Evacuation des équipements usagés par les utilisateurs dans les foyers privés au sein de l'Union européenne

La présence de ce symbole sur le produit ou sur son emballage indique que vous ne pouvez pas vous débarrasser de ce produit de la même façon que vos déchets courants. Au contraire, vous êtes responsable de l'évacuation de vos équipements usagés et à cet effet, vous êtes tenu de les remettre à un point de collecte agréé pour le recyclage des équipements électriques et électroniques usagés. Le tri, l'évacuation et le recyclage séparés de vos équipements usagés permettent de préserver les ressources naturelles et de s'assurer que ces équipements sont recyclés dans le respect de la santé humaine et de l'environnement. Pour plus d'informations sur les lieux de collecte des équipements usagés, veuillez contacter votre mairie, votre service de traitement des déchets ménagers ou le magasin où vous avez acheté le produit.

Deutsch

Entsorgung von Elektrogeräten durch Benutzer in privaten Haushalten in der EU

Dieses Symbol auf dem Produkt oder dessen Verpackung gibt an, dass das Produkt nicht zusammen mit dem Restmüll entsorgt werden darf. Es obliegt daher Ihrer Verantwortung, das Gerät an einer entsprechenden Stelle für die Entsorgung oder Wiederverwertung von Elektrogeräten aller Art abzugeben (z.B. ein Wertstoffhof). Die separate Sammlung und das Recyceln Ihrer alten Elektrogeräte zum Zeitpunkt ihrer Entsorgung trägt zum Schutz der Umwelt bei und gewährleistet, dass sie auf eine Art und Weise recycelt werden, die keine Gefährdung für die Gesundheit des Menschen und der Umwelt darstellt. Weitere Informationen darüber, wo Sie alte Elektrogeräte zum Recyceln abgeben können, erhalten Sie bei den örtlichen Behörden, Wertstoffhöfen oder dort, wo Sie das Gerät erworben haben.

Italiano

Smaltimento di apparecchiature da rottamare da parte di privati nell'Unione Europea

Questo simbolo che appare sul prodotto o sulla confezione indica che il prodotto non deve essere smaltito assieme agli altri rifiuti domestici. Gli utenti devono provvedere allo smaltimento delle apparecchiature da rottamare portandole al luogo di raccolta indicato per il riciclaggio delle apparecchiature elettriche ed elettroniche. La raccolta e il riciclaggio separati delle apparecchiature da rottamare in fase di smaltimento favoriscono la conservazione delle risorse naturali e garantiscono che tali apparecchiature vengano rottamate nel rispetto dell'ambiente e della tutela della salute. Per ulteriori informazioni sui punti di raccolta delle apparecchiature da rottamare, contattare il proprio comune di residenza, il servizio di smaltimento dei rifiuti locale o il negozio presso il quale è stato acquistato il prodotto.

Español	<p>Eliminación de residuos de aparatos eléctricos y electrónicos por parte de usuarios domésticos en la Unión Europea</p> <p>Este símbolo en el producto o en el embalaje indica que no se puede desechar el producto junto con los residuos domésticos. Por el contrario, si debe eliminar este tipo de residuo, es responsabilidad del usuario entregarlo en un punto de recolección designado de reciclado de aparatos electrónicos y eléctricos. El reciclaje y la recolección por separado de estos residuos en el momento de la eliminación ayudará a preservar recursos naturales y a garantizar que el reciclaje proteja la salud y el medio ambiente. Si desea información adicional sobre los lugares donde puede dejar estos residuos para su reciclado, póngase en contacto con las autoridades locales de su ciudad, con el servicio de gestión de residuos domésticos o con la tienda donde adquirió el producto.</p>
Česky	<p>Likvidace vysloužilého zařízení uživateli v domácnosti v zemích EU</p> <p>Tato značka na produktu nebo na jeho obalu označuje, že tento produkt nesmí být likvidován prostým vyhozením do běžného domovního odpadu. Odpovídáte za to, že vysloužilé zařízení bude předáno k likvidaci do stanovených sběrných míst určených k recyklaci vysloužilých elektrických a elektronických zařízení. Likvidace vysloužilého zařízení samostatným sběrem a recyklací napomáhá zachování přírodních zdrojů a zajišťuje, že recyklace proběhne způsobem chránícím lidské zdraví a životní prostředí. Další informace o tom, kam můžete vysloužilé zařízení předat k recyklaci, můžete získat od úřadu místní samosprávy, od společnosti provádějící svoz a likvidaci domovního odpadu nebo v obchode, kde jste produkt zakoupili.</p>
Dansk	<p>Bortskaffelse af affaldsudytyr for brugere i private husholdninger i EU</p> <p>Dette symbol på produktet eller på dets emballage indikerer, at produktet ikke må bortskaffes sammen med andet husholdningsaffald. I stedet er det dit ansvar at bortskaffe affaldsudytyr ved at aflevere det på dertil beregnede indsamlingssteder med henblik på genbrug af elektrisk og elektronisk affaldsudytyr. Den separate indsamling og genbrug af dit affaldsudytyr på tidspunktet for bortskaffelse er med til at bevare naturlige ressourcer og sikre, at genbrug finder sted på en måde, der beskytter menneskers helbred samt miljøet. Hvis du vil vide mere om, hvor du kan aflevere dit affaldsudytyr til genbrug, kan du kontakte kommunen, det lokale renovationsvæsen eller den forretning, hvor du købte produktet.</p>
Nederlands	<p>Afvoer van afgedankte apparatuur door gebruikers in particuliere huishoudens in de Europese Unie</p> <p>Dit symbool op het product of de verpakking geeft aan dat dit product niet mag worden afgevoerd met het huishoudelijk afval. Het is uw verantwoordelijkheid uw afgedankte apparatuur af te leveren op een aangewezen inzamelpunt voor de verwerking van afgedankte elektrische en elektronische apparatuur. De gescheiden inzameling en verwerking van uw afgedankte apparatuur draagt bij tot het sparen van natuurlijke bronnen en tot het hergebruik van materiaal op een wijze die de volksgezondheid en het milieu beschermt. Voor meer informatie over waar u uw afgedankte apparatuur kunt inleveren voor recycling kunt u contact opnemen met het gemeentehuis in uw woonplaats, de reinigingsdienst of de winkel waar u het product hebt aangeschaft.</p>
Eesti	<p>Eramajapidamistes kasutuselt kõrvaldatavate seadmete käitlemine Euroopa Liidus</p> <p>Kui tootel või toote pakendil on see sümbol, ei tohi seda toodet visata olmejäätmete hulka. Teie kohus on viia tarbetuks muutunud seade selleks ettenähtud elektri- ja elektroonikaseadmete utiliseerimiskohta. Utiliseeritavate seadmete eraldi kogumine ja käitlemine aitab säästa loodusvarasid ning tagada, et käitlemine toimub inimeste tervisele ja keskkonnale ohutult. Lisateavet selle kohta, kuhu saate utiliseeritava seadme käitlemiseks viia, saate küsida kohalikust omavalitsusest, olmejäätmete utiliseerimispunktist või kauplusest, kust te seadme otsite.</p>
Suomi	<p>Hävittävien laitteiden käsittely kotitalouksissa Euroopan unionin alueella</p> <p>Tämä tuotteessa tai sen pakkauksessa oleva merkintä osoittaa, että tuotetta ei saa hävittää talousjätteiden mukana. Käyttäjän velvollisuus on huolehtia siitä, että hävitettävä laite toimitetaan sähkö- ja elektroniikkalaiteromun keräyspisteeseen. Hävitettävien laitteiden erillinen keräys ja kierrätys säästää luonnonvaroja. Näin toimimalla varmistetaan myös, että kierrätys tapahtuu tavalla, joka suojelee ihmisten terveyttä ja ympäristöä. Saat tarvittaessa lisätietoja jätteiden kierrätyspaikoista paikallisilta viranomaisilta, jäteyhtiöltä tai tuotteen jälleenmyyjältä.</p>
Ελλάδα	<p>Απόρριψη άχρηστων συσκευών στην Ευρωπαϊκή Ένωση</p> <p>Το παρόν σύμβολο στον εξοπλισμό ή στη συσκευασία του υποδεικνύει ότι το προϊόν αυτό δεν πρέπει να πεταχτεί μαζί με άλλα οικιακά απορρίμματα. Αντίθετα, ευθύνη σας είναι να απορρίψετε τις άχρηστες συσκευές σε μια καθορισμένη μονάδα συλλογής απορριμμάτων για την ανακύκλωση άχρηστου ηλεκτρικού και ηλεκτρονικού εξοπλισμού. Η χωριστή συλλογή και ανακύκλωση των άχρηστων συσκευών θα συμβάλει στη διατήρηση των φυσικών πόρων και τη διασφάλιση ότι θα ανακυκλωθούν με τρόπο ώστε να προστατεύεται η υγεία των ανθρώπων και το περιβάλλον. Για περισσότερες πληροφορίες σχετικά με το πού μπορείτε να απορρίψετε τις άχρηστες συσκευές για ανακύκλωση, επικοινωνήστε με τις κατά τόπους αρμόδιες αρχές ή το κατάστημα από το οποίο αγοράσατε το προϊόν.</p>

Magyar	<p>A hulladékanyagok kezelése a magánháztartásokban az Európai Unióban</p> <p>Ez a szimbólum, amely a terméken vagy annak csomagolásán van feltüntetve, azt jelzi, hogy a termék nem kezelhető együtt az egyéb háztartási hulladékkal. Az Ön feladata, hogy a készülék hulladékanyagait eljuttassa olyan kijelölt gyűjtőhelyre, amely az elektromos hulladékanyagok és az elektronikus berendezések újrahasznosításával foglalkozik. A hulladékanyagok elkülönített gyűjtése és újrahasznosítása hozzájárul a természeti erőforrások megőrzéséhez, egyúttal azt is biztosítja, hogy a hulladék újrahasznosítása az egészségre és a környezetre nem ártalmas módon történik. Ha tájékoztatást szeretne kapni azokról a helyekről, ahol leadhatja újrahasznosításra a hulladékanyagokat, forduljon a helyi önkormányzatához, a háztartási hulladék begyűjtésével foglalkozó vállalatához vagy a termék forgalmazójához.</p>
Latviski	<p>Lietotāju atbrīvošanās no nederīgām ierīcēm Eiropas Savienības privātajās mājāsaimniecībās</p> <p>Šis simbols uz ierīces vai tās iepakojuma norāda, ka šo ierīci nedrīkst izmest kopā ar pārējiem mājāsaimniecības atkritumiem. Jūs esat atbildīgs par atbrīvošanos no nederīgās ierīces, to nododot norādītajā savākšanas vietā, lai tiktu veikta nederīgā elektriskā un elektroniskā aprīkojuma otrreizējā pārstrāde. Speciāla nederīgās ierīces savākšana un otrreizējā pārstrāde palīdz taupīt dabas resursus un nodrošina tādu otrreizējo pārstrādi, kas sargā cilvēku veselību un apkārtējo vidi. Lai iegūtu papildu informāciju par to, kur otrreizējai pārstrādei var nogādāt nederīgo ierīci, lūdzu, sazinieties ar vietējo pašvaldību, mājāsaimniecības atkritumu savākšanas dienestu vai veikalu, kurā iegādājāties šo ierīci.</p>
Lietuviškai	<p>Europos Sąjungos vartotojų ir privačių namų ūkių atliekamos įrangos išmetimas</p> <p>Šis simbolis ant produkto arba jo pakuotės nurodo, kad produktas negali būti išmestas kartu su kitomis namų ūkio atliekomis. Jūs privalote išmesti savo atliekamą įrangą atiduodami ją į atliekamos elektronikos ir elektros įrangos perdirbimo punktus. Jei atliekama įranga bus atskirai surenkama ir perdirbama, bus išsaugomi natūralūs išteklių ir užtikrinama, kad įranga yra perdirbta žmogaus sveikatą ir gamtą tausojančiu būdu. Dėl informacijos apie tai, kur galite išmesti atliekamą perdirbti skirtą įrangą kreipkitės į atitinkamą vietos tarnybą, namų ūkio atliekų išvežimo tarnybą arba į parduotuvę, kurioje pirkote produktą.</p>
Polski	<p>Utylizacja zużytego sprzętu przez użytkowników domowych w Unii Europejskiej</p> <p>Symbol ten umieszczony na produkcie lub opakowaniu oznacza, że tego produktu nie należy wyrzucić razem z innymi odpadami domowymi. Użytkownik jest odpowiedzialny za dostarczenie zużytego sprzętu do wyznaczonego punktu gromadzenia zużytych urządzeń elektrycznych i elektronicznych. Gromadzenie osobno i recykling tego typu odpadów przyczynia się do ochrony zasobów naturalnych i jest bezpieczny dla zdrowia i środowiska naturalnego. Dalsze informacje na temat sposobu utylizacji zużytych urządzeń można uzyskać u odpowiednich władz lokalnych, w przedsiębiorstwie zajmującym się usuwaniem odpadów lub w miejscu zakupu produktu.</p>
Português	<p>Descarte de equipamentos por usuários em residências da União Europeia</p> <p>Este símbolo no produto ou na embalagem indica que o produto não pode ser descartado junto com o lixo doméstico. No entanto, é sua responsabilidade levar os equipamentos a serem descartados a um ponto de coleta designado para a reciclagem de equipamentos eletro-eletrônicos. A coleta separada e a reciclagem dos equipamentos no momento do descarte ajudam na conservação dos recursos naturais e garantem que os equipamentos serão reciclados de forma a proteger a saúde das pessoas e o meio ambiente. Para obter mais informações sobre onde descartar equipamentos para reciclagem, entre em contato com o escritório local de sua cidade, o serviço de limpeza pública de seu bairro ou a loja em que adquiriu o produto.</p>
Slovenčina	<p>Postup používateľ'ov v krajinách Európskej únie pri vyhadzovaní zariadenia v domácom používaní do odpadu</p> <p>Tento symbol na produkte alebo na jeho obale znamená, že nesmie byť vyhodnený s iným komunálnym odpadom. Namiesto toho máte povinnosť odovzdať toto zariadenie na zbernom mieste, kde sa zabezpečuje recyklácia elektrických a elektronických zariadení. Separovaný zber a recyklácia zariadenia určeného na odpad pomôže chrániť prírodné zdroje a zabezpečiť taký spôsob recyklácie, ktorý bude chrániť ľudské zdravie a životné prostredie. Ďalšie informácie o separovanom zbere a recyklácii získate na miestnom obecnom úrade, vo firme zabezpečujúcej zber vášho komunálneho odpadu alebo v predajni, kde ste produkt kúpili.</p>
Slovenščina	<p>Ravnanje z odpadno opremo v gospodinjstvih znotraj Evropske unije</p> <p>Ta znak na izdelku ali embalaži izdelka pomeni, da izdelka ne smete odlagati skupaj z drugimi gospodinjstvenimi odpadki. Odpadno opremo ste dolžni oddati na določenem zbirnem mestu za recikliranje odpadne električne in elektronske opreme. Z ločenim zbiranjem in recikliranjem odpadne opreme ob odlaganju boste pomagali ohraniti naravne vire in zagotovili, da bo odpadna oprema reciklirana tako, da se varuje zdravje ljudi in okolje. Več informacij o mestih, kjer lahko oddate odpadno opremo za recikliranje, lahko dobite na občini, v komunalnem podjetju ali trgovini, kjer ste izdelek kupili.</p>

Kassering av förbrukningsmaterial, för hem- och privat användare i EU

Produkter eller produktförpackningar med den här symbolen får inte kasseras med vanligt hushållsavfall. I stället har du ansvar för att produkten lämnas till en behörig återvinningsstation för hantering av el- och elektronikprodukter. Genom att lämna kasserade produkter för återvinning hjälper du till med att bevara våra gemensamma naturresurser. Dessutom skyddas både människor och miljön när produkter återvinns på rätt sätt. Kommunala myndigheter, sophanteringsföretag eller butiken där varan köptes kan ge mer information om var du lämnar kasserade produkter för återvinning.

欧盟国家/地区用户在私人住宅中对废旧设备的处理

产品或包装上包括此标志表示此产品不得作为住宅垃圾来处理。而且您有责任将废旧设备送到指定的废旧电力电子设备回收点，通过这种方式来处理废旧设备。废旧设备的分类收集与回收有助于节约自然资源，保证以有利于人类健康和环保的方式回收废旧设备。有关废旧设备回收的详细信息，请与当地市政机关、家庭垃圾处理站或购买产品的商店联系。

Index

A

- accessories 12
- adjusting
 - color 32
 - picture 29
 - setup 33
 - shape of picture 30
 - slanted picture 31
 - sound 29
- aiming projector 25
- analog video mode
 - compatibility 63
- audio
 - adjusting 29
 - ports 10
 - troubleshooting 59
- audio, connecting

B

- buttons
 - location 9
 - opening menu 34

C

- cables
 - choosing 44
 - connections 18
- ceiling installation 45
- choosing cables 44
- cleaning 6, 39
- component-video
 - connecting RCA source 20
 - connecting source with component-to-VGA cable 19
 - port 10

- composite-video
 - connecting source 22
 - port 10
- computer screen, showing 28
- computer, connecting 16
- connecting
 - component-video source 19, 20
 - composite-video source 22
 - computer 16
 - DVI source 18
 - external accessory 46
 - handheld organizer 17
 - power 15
 - room controller 47
 - SCART source 18
 - S-video source 21
- controlling external accessory 46

D

- default settings, changing 34
- diagnostics 60
- DVI video
 - connecting source 18
 - port 10

E

- external accessory 46

F

- firmware, updating 43
- focus 25

H

- handheld organizer,
 - connecting 17
- hiding picture 28

I

- image. See picture
- installing projector 13, 44

L

- lamp, replacing 40
- lens, cleaning 39
- lights. See lamp; warning lights
- locking projector 33, 45

M

- menu
 - language 35
 - listing 34
 - using 34
- mercury safety 64
- moving projector 24

O

- on-screen menu. See menu

P

- PC. See computer
- picture
 - focus 25
 - hiding and showing 28
 - quality of 13, 18, 58
 - troubleshooting 56
 - zoom 25
- picture mode, choosing 29

- power
 - connecting 15
 - turning off 24
 - turning on 23
- presentations, showing 28
- projector, locking 33

Q

- quality of picture 18, 58

R

- rear projection installation 45
- recycling information 67
- regulatory information 64
- remote control
 - buttons 11
 - installing batteries 42
 - opening menu 34
 - troubleshooting 60
 - using 26
- replacing lamp 40
- room controller 47
- room layout 13
- RS-232 47

S

- safety information 6, 64
- SCART 18
- screen
 - controlling 46
 - positioning 14
- security
 - locking cable 45
 - security code 33
- selecting video source 28
- serial port 47
 - connector 47
- setting up 13
- shape, adjusting 30
- showing picture 28
- showing presentations 28

- slanted picture, adjusting 31
- specifications 61
- S-video
 - connecting source 21
 - port 10

T

- table installation 13, 44
- triggering external accessory 46
- troubleshooting
 - audio 59
 - interruptions 59
 - picture 56
 - remote control 60
 - start-up 56
 - warning lights 55
- turning on and off 23

U

- unlocking projector 33
- updating firmware 43
- upgrading projector 43
- USB, connecting 16
- using remote control 26

V

- VGA
 - connecting source 16, 17
 - port 11
- video mode compatibility 63
- video source, selecting 28

W

- warning lights
 - location 9
 - meanings 55
 - troubleshooting 55

Y

- YPbPr. See component-video

Z

- zoom 25