

HP DesignJet 700 Plotter

HP DesignJet 750C Plus Plotter

User's Guide

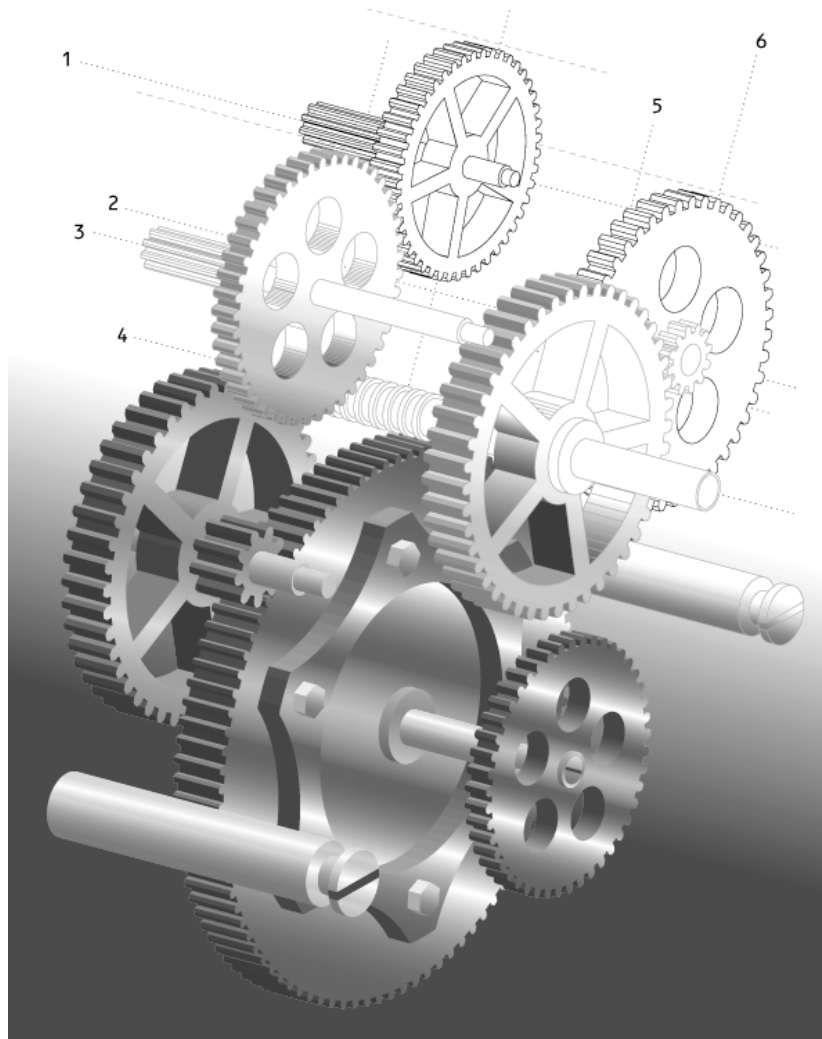

✓ Copyright Hewlett-Packard
Company 1996

Manual part number
C4705-90031
First edition, September 1996
Printed in Europe

Customer re-order number
C4705-60021

All rights are reserved. No part
of the document may be
photocopied, reproduced, or
translated to another language
without the prior written
consent of Hewlett-Packard
Company.

AutoCAD™ is a trademark of
AutoDesk Inc.

Bi-Tronics, HP-GL and
HP-GL/2 are trademarks of
Hewlett-Packard Company.

Macintosh is a product of
Apple Computer Inc.

Microsoft and MS-DOS
are registered trademarks of
Microsoft Corporation.

Microsoft Windows is a
registered trademark of
Microsoft Corporation.

PostScript is a registered
trademark of Adobe Systems
Incorporated.

UNIX is a registered
trademark in the United States
and other countries, licensed
exclusively through X/Open
Company Limited.

Notice

The information contained in
this document is subject to
change without notice and
should not be construed as a
commitment by
Hewlett-Packard Company.

**Hewlett-Packard assumes no
responsibility for any errors
that may appear in this
document nor does it make
expressed or implied
warranty of any kind with
regard to this material,
including, but not limited to,
the implied warranties of
merchantability and fitness
for a particular purpose.**

The Hewlett-Packard
Company shall not be liable
for incidental or consequential
damages in connection with,
or arising out of the furnishing,
performance, or use of this
document and the program
material which it describes.

Safety Symbols



The product is marked with
this symbol when it is
necessary for you to refer to
the instruction manual in order
to protect against damage to
the product.



Hazardous voltage symbol.

WARNING

The Warning symbol calls
attention to a procedure,
practice, or the like, which, if
not correctly performed or
adhered to, could result in
personal injury. Do not
proceed beyond a Warning
symbol until the indicated
conditions are fully understood
and met.

CAUTION

The Caution symbol calls
attention to an operating
procedure, practice, or the like,
which, if not correctly
performed or adhered to, could
result in damage to or
destruction of part or all of the
product. Do not proceed
beyond a Caution symbol until
the indicated conditions are
fully understood and met.

User's Guide



HP DesignJet 700 Plotter
HP DesignJet 750C Plus Plotter
C4705A, C4706A, C4708A and C4709A

Finding Information



This **User's Guide** for the HP DesignJet 700 and 750C Plus plotters contains the following types of information:

- Set Up
- Use
- Maintenance
- Troubleshooting
- Reference Material.

To help find specific information, a comprehensive table of contents is provided at the front and an alphabetical index is provided at the back.

You will notice the use of symbols in the left margin and shaded backgrounds to the text. These are used to identify different types of information as follows:

700

- Information specific only to the HP DesignJet 700 is shown like this.

750C Plus

- Information specific only to the HP DesignJet 750C Plus is shown like this.

All other information is applicable to both plotters.

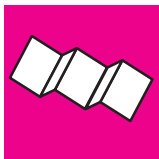

The Quick Reference Guide Contains:

- Some information that you are most likely to need on a day-to-day basis, for example, the front-panel menu structure and media-type selections. It is stored in the pocket at the back of the plotter.

Where To Find the Most Commonly Needed Information

To find how to ...	go to ...
Install the plotter	▶ chapter 1
Connect the plotter	▶ page 1-27
Choose media	▶ page 3-2
Load media	▶ page 3-10
Replace the cartridges	▶ page 3-26
See the plotter's current configuration	▶ pages 7-2 and 7-3
Clear a media jam	▶ page 9-8
Solve print quality problems	▶ page 9-16
Interpret a front-panel message	▶ page 10-2
Order accessories	▶ page 11-13
To find any other information ...	▶ go to the index <i>at the back</i> of this manual.

On page D-1 at the back of this manual, you will find a **Documentation Map**, listing useful documents to help with

- Setting Up and Using the Plotter
- Using Application Software
- Getting Support
- Programmer's References.

Contents

Finding Information	iii
Welcome	xiii
1 Setting Up the Plotter	
<i>Fast Track</i>	1-2
Set Up Checklist	1-4
Task 1: Check that You Have All the Items Required	1-5
Task 2: Install Memory Expansion Modules (Optional)	1-6
Task 3: Switch On and Change the Language From English (Optionally)	1-9
Task 4: Load Media	1-11
Task 5: Load the Print Cartridge(s)	1-20
Task 6: Print a Demonstration Plot (Optional)	1-24
Task 7: Connect the Plotter To Your Computer	1-27
Task 8: Configure the Serial Interface (Serial Interface Users Only)	1-29
Task 9: Set Up Your Software	1-35
Task 10: Print a Test Plot	1-39
Extra Tips for UNIX Users	1-40
2 Learning How to Use the Front-Panel Display (Tutorial)	
The Front Panel	2-2
The Display Section	2-3
Printing the Menus Plot	2-5
Description of the Menus Plot	2-5
Entering the Menu System	2-6
Navigating the Menu System	2-7
Menu Graphics Used in this Manual	2-9
Other Types of Screens	2-10
Examples	2-11

3 Working with Media and Cartridges

Choosing Media	3-2
Five Important Points about Media Types	3-2
Supported Media Types	3-3
Physical Characteristics of Media Types	3-4
Cost And Color Support of Media Types (DesignJet 750C Plus)	3-5
Combinations of Media Type and Print Quality	3-6
Typical Media Type Choices by Application	3-7
Caring For Your Media	3-9
Loading Media	3-10
To Change a Roll	3-10
To Load a Sheet	3-18
Compensating for Badly Cut Media	3-21
To Adjust Skew Tolerance	3-21
Unloading Media	3-22
Drying Time	3-22
To Adjust Drying Time	3-23
To Unload a Sheet After Plotting	3-24
To Remove an Unused Sheet	3-25
Replacing Cartridges	3-26
When to Replace Cartridges	3-26
Before Replacing Cartridges	3-27
To Replace a Cartridge	3-28

4 Controlling the Page Format	
Page Size	4-2
Do You Need to Adjust the Page Size in the Front Panel?	4-3
To Adjust the Page Size from the Front Panel	4-4
Page Size and Clipped Plots	4-5
Page Size and Nesting (Roll Media Only)	4-5
Adjusting the Margins (Roll Media Only)	4-6
Margins and Automatic Cutting	4-6
Rotating a Plot	4-7
Rotating a Drawing from the Front Panel	4-7
To Rotate a Plot from the Front Panel	4-7
Exactly What Is Rotated?	4-8
The Rotate Feature and Clipped Plots	4-8
How Does Rotate Interact with Your Software?	4-9
Plotting a Mirror Image	4-10
5 Controlling a Plot's Overall Appearance	
Ways To Control the Plot's Appearance	5-2
Why Change the Appearance of the Plot Using the Front Panel Rather Than from Your Software?	5-2
Changing Pen Widths and Colors/Shades Using the Plotter's Internal Palettes	5-3
To See the Current Palette Settings	5-3
To See the Colors Available For a Palette (DesignJet 750C Plus)	5-4
To Change the Palette Settings	5-5
To Change the Selection of the Current Palette	5-6
Changing the Treatment of Overlapping Lines (Merge Feature)	5-7
Changing the Overall Lightness/Darkness of a Plot	5-8
Printing Color Drawings in Monochrome	5-9
To Switch between Color and Monochrome	5-10
Choosing an Appropriate Print Quality	5-11
To Change the Print Quality	5-13
Improving Line Quality and Graphics Detail (DesignJet 750C Plus)	5-14

6 Managing Your Plots

Managing Plots Currently Being Printed or Drying	6-2
To Cancel a Plot	6-2
To Cut a Plot Before Drying Is Complete (Roll Media Only)	6-2
To Pause while Printing a Series of Plots	6-3
Managing Plots Not Yet Printed (The Queue)	6-4
To Start Printing a Plot That Is Waiting for a Timeout	6-4
What Is the Queue?	6-5
To Identify a Page in the Queue	6-6
To See the Size of a Page in the Queue	6-7
To Prioritize a Page in the Queue	6-7
To Delete a Page from the Queue	6-7
To Make Copies of a Page in the Queue	6-8
To Replot an Image Using the Plotter's Memory (DesignJet 700)	6-9
Avoiding Media Waste by Nesting Pages (Roll Media Only)	6-10
What Is Nesting?	6-10
When Does the Plotter Try to Nest Pages?	6-11
Which Pages Qualify for Nesting?	6-11
Which Pages May be Rotated?	6-11
To Turn Nesting On or Off and Choose the Nesting Method	6-12
What Happens to Nesting if You Turn Queueing Off?	6-12
How Long Does the Plotter Wait for Another File?	6-12
Getting the Best From Nesting (Nesting and Margins)	6-13
Nesting and the Rotate Feature	6-13

7 Reconfiguring the Plotter	
To See the Current Overall Configuration of the Plotter	7-2
To See the Current Configuration of the Front-Panel Settings	7-3
To Change the Front-Panel Settings	7-4
Recalibrating the Plotter for Accuracy	7-5
When to Recalibrate the Plotter	7-5
A Quick Guide to Whether Recalibration Is Necessary	7-5
To Recalibrate the Plotter	7-6
To Restore the Factory's Calibration	7-6
Changing the Graphics Language Setting for a Different Application	7-7
To Change the Graphics Language Setting	7-7
Graphics Language and Networks	7-8
Changing the Serial Interface Settings	7-9
To Change the Serial-Interface Settings	7-9
Change the I/O Timeout Setting	7-9
To Upgrade Your Plotter with More Memory	7-10
File Size and Memory Usage	7-10
To Upgrade Your Plotter with the Postscript Option	7-11
To Upgrade Your Plotter with a Network Interface	7-12
HP JetDirect Print Server	7-12
8 Maintaining the Plotter	
Replacing the Print Cartridge(s)	8-2
Cleaning the Plotter	8-2
"Normal" Plotter Use	8-3
To Print the Service Configuration Plot	8-4

9 Troubleshooting

Using the Documentation to Help Solve Problems	9-2
Locating the Source of the Problem	9-3
Solving Media-Handling Problems	9-4
If the Front Panel Keeps Telling you Media Is Misaligned or Incorrectly positioned.	9-4
If Media Crumples when you Load It	9-5
If Plots Do Not Feed Out Properly From the Plotter	9-5
If The Automatic Cutter Does Not Cut Immediately When a Plot Has Finished	9-5
If The Automatic Cutter Does Not Work	9-6
If Plots Fall On the Floor After Being Cut	9-6
If a Sheet Is Ejected When You Switch On the Plotter	9-6
If Plots Do Not Stack Properly In the Bin	9-6
Solving Print Cartridge Problems	9-7
If the Access Cartridge(s) Key Does Not Work	9-7
If the Plotter Runs the Cartridge-alignment Routine Unexpectedly	9-7
If Brand New Cartridge(s) Have Problems	9-7
Clearing a Media Jam	9-8
Solving Communication Problems	9-9
If There is a Problem Communicating between Your Computer and the Plotter	9-9
Solving Problems with Plot Position or Content	9-10
If the Plot Is Completely Blank	9-10
If the Output Contains Only a Partial Plot	9-11
If the Plot Is Clipped	9-12
If a Long-axis Plot Is Clipped	9-12
If the Entire Plot Is in One Quadrant of the Correct Plotting Area	9-13
If the Plot Is Unexpectedly Rotated	9-13
If the Plot Is a Mirror Image of Your Drawing	9-13
If the Plot Is Inaccurate	9-13
If the Plot Is Distorted or Unintelligible	9-14
If One Plot Overlays Another Plot On the Same Sheet	9-14
If Pen Settings Seem to Have No Effect	9-14

If the Plotter Produces a Black and White Plot When You Expected a Color Plot (DesignJet 750C Plus)	9-14
If the Plotter Has Printed a Different Plot Than the One You Were Expecting	9-15
If the Quality Of a Color Plot Is Not as Good as You Were Expecting (DesignJet 750C Plus)	9-15
Solving Print Quality Problems	9-16
If the Color Is Not as Expected	9-16
If there are White Streaks in Solid Fill Areas	9-16
If there are Other Gaps in Solid Areas or in Lines (DesignJet 750C Plus)	9-17
If there are Jagged Vertical or Horizontal Lines	9-18
If there are Slightly Warped Lines	9-18
If there are Color “Shadows” (DesignJet 750C Plus)	9-18
If One or More Cartridges are not Printing at All	9-18
If there are Blurred Lines (Ink “Bleeds” from Lines)	9-19
If there are Blotchy Areas (Uneven Fill Density)	9-19
If the Plot Is Too Dark or the Color Too Saturated	9-19
If there Is Pronounced Banding In Area Fills	9-20
If Ink Smears After You Remove a Plot	9-20
Solving Front Panel Problems	9-21
If the Access Cartridges Key Does Not Work	9-21
If None of the Front Panel Keys Work	9-21
If Page Format/Rotate Does Not Work	9-21
If A Display Message Will Not Clear	9-21
If A “System Error” Message Is Displayed	9-22
If An “Out Of Memory/Data Was Lost” Message Is Displayed	9-22
Solving Miscellaneous Problems	9-23
If the Plotter Does Not Plot	9-23
If the Plotter Seems Too Slow	9-23
If the Plotter Waits Too Long to Plot a Nest	9-24
If the Plotter Performs the Cartridge Alignment Routine Unexpectedly	9-24
If the Bail (Black Metal Bar) Does Not Lower All the Way	9-24
Getting Help	9-25
What to Do Before You Call	9-25
If a Repair Is Needed	9-25

10 Front-Panel Messages

Front Panel Messages **10-2**

11 Reference

Plotter Specifications **11-2**
Interface Specifications **11-7**
Interface Cables **11-8**
Regulatory Notices **11-10**
 To Obtain a Material Safety Data Sheet (MSDS) **11-10**
 Electromagnetic Compatibility (EMC) **11-10**
 Telecommunications Statement **11-11**
 Declaration of Conformity **11-12**
Ordering Accessories **11-13**
 HP-GL/2 and HP RTL Programming Information **11-16**
 How to Order Supplies and Accessories **11-16**

12 Glossary

Index

Documentation Map

Please Give Us Your Feedback (Removable)

Welcome

An Introduction To Your Plotter's Main Features

The HP DesignJet 700 and HP DesignJet 750C Plus are large-format inkjet plotters that use HP **disposable print cartridge** technology.

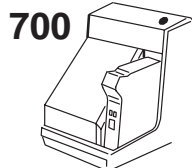
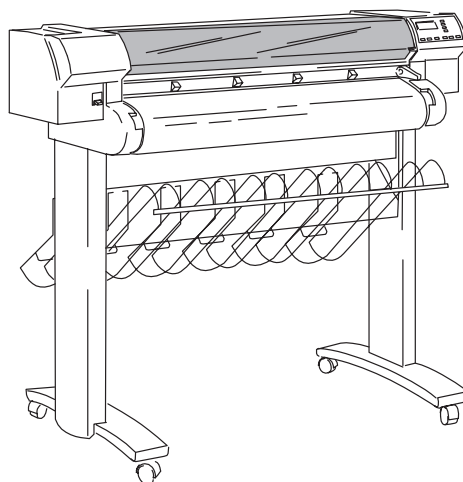

- The HP DesignJet 700 will print only in black. It uses a single cartridge, containing black ink, two of which are supplied with your plotter.

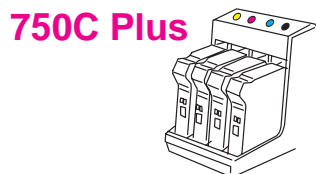

- The HP DesignJet 750C Plus will print in color or black. Your plotter uses a set of *four disposable print cartridges*: yellow, cyan, magenta and black, a set is supplied with your plotter (a spare black cartridge is also included). From time to time, you will need to replace them. All other supported colors are generated using these four cartridges up to a total of over 16 million different colors for all your needs.

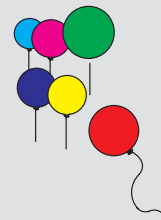

- Product C4705A is the DesignJet 700 and Product C4708A is the DesignJet 750C Plus. Both Plotters are the D/A1-size model.
- Product C4706A is the DesignJet 700 and Product C4709A is the DesignJet 750C Plus. Both Plotters are the E/A0-size model.



Print Quality

In monochrome, the print resolution can be set to either true 300 or true 600 dots per inch (dpi). In color, the print resolution can be set to true 300 or addressable 600 dpi. You can choose between three levels of print quality either from your software or from the plotter's front panel. These are:

- Best
- Normal
- Fast.

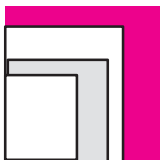

Media

You can plot on *rolls or sheets* up to E/A0 size or D/A1 size, depending on the plotter model you have bought.

A large variety of *media types* are supported:

700

- Opaque bond (one roll is supplied with your plotter)
- Translucent bond
- Natural tracing paper
- Vellum

750C Plus

- Coated paper (one roll is supplied with your plotter)
- Heavy coated paper
- Matte and clear film.

750C Plus

In addition for the HP DesignJet 750C Plus:

- High-gloss and semi-gloss photo paper
- High-gloss film.



User Interface

The plotter's front panel includes an easy-to-use interface with a two-line display, giving you access to a comprehensive set of plotter functions and to a number of useful sample plots.

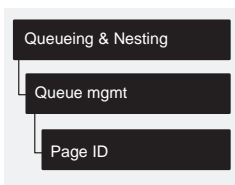

This manual includes a short tutorial to teach you how to navigate around the menus. Wherever a front-panel feature is explained in this manual, a simple graphic shows you how to access that feature from the front-panel menus.



Software Applications and Drivers

To make sure that your plotter prints exactly what you were expecting – in terms of size, position, orientation, color and quality – the key is to use the correct driver for the combination of your application software and your plotter, and to be confident that it is configured correctly.

Two types of HP drivers are supplied with your plotter:

- One or more for AutoCAD™ users,
- One for users of Microsoft® Windows applications.

These drivers come with printed and on line documentation to help you install and configure them correctly.

Generally, software applications include their own drivers too. With this plotter we have provided free of charge a set of Software Application Notes for the most popular applications. If you find your own application in these notes, we recommend that you use the information they contain as an overall guide to configuring the software for your plotter.

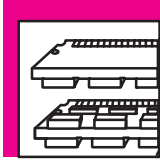

700

750C Plus

Memory and Upgrades

Your plotter comes with a standard memory of 5.5 MB (4 MB of main memory and 1.5 MB of printing memory). In case you need to print particularly large files¹, you can upgrade your plotter with up to two 32 MB memory expansion modules, taking the maximum memory up to 69.5 MB (5.5 + (2 x 32)).

Your plotter comes with a standard memory of 11 MB (8 MB of main memory and 3 MB of printing memory). In case you need to print particularly large files¹, you can upgrade your plotter with up to two 32 MB memory expansion modules, taking the maximum memory up to 75 MB (11 + (2 x 32)).

Other upgrades available are:

- A PostScript® upgrade kit (including a ROM SIMM for the plotter and an Adobe PostScript driver for your software).
- A network interface card (the HP JetDirect Print Server).

¹ Note that there is not a one-for-one relationship between the plotter's memory and the maximum size of file that it can plot.

Front View

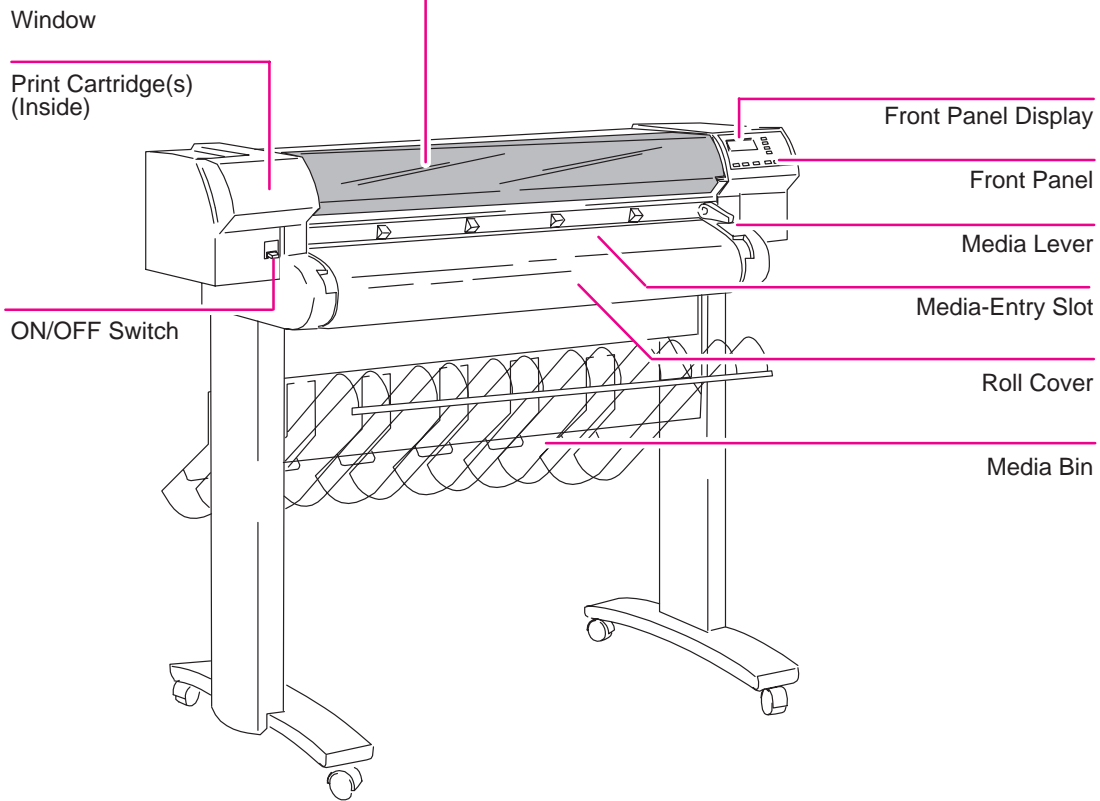

1835

Rear View

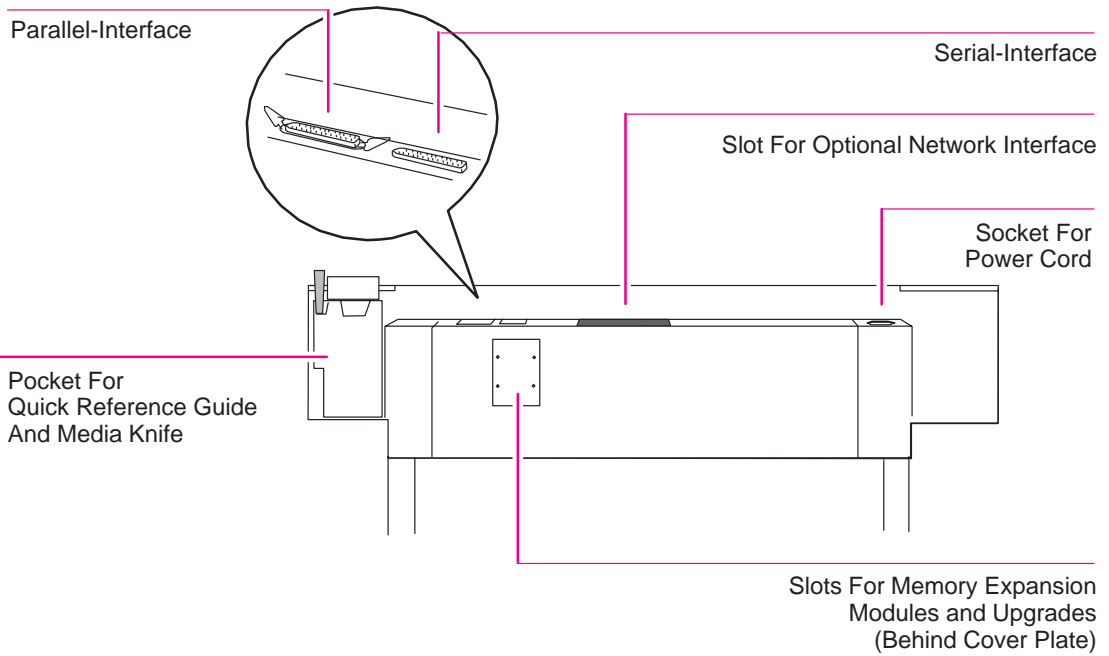

Fast Track 1-2

Set Up Checklist 1-4

Task 1: Check That You Have All the Items Required 1-5

Task 2: Install Memory Expansion Modules (*Optional*) 1-6

Task 3: Switch On and
Change the Language From English (*Optional*) 1-9

Task 4: Load Media 1-11

Task 5: Load the Print Cartridge(s) 1-20

Task 6: Print a Demonstration Plot (*Optional*) 1-24

Task 7: Connect the Plotter to Your Computer 1-27

Task 8: Configure the Interface (*Serial interface users only*) 1-29

Task 9: Set Up Your Software 1-35

Task 10: Print a Test Plot 1-39

Extra Tips For UNIX Users 1-40

Setting Up Your Plotter

Installation, Connection,
and Configuration

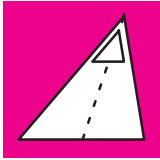

Fast Track

If You Meet All the Following Requirements:

- You want English as the language of the front-panel display and of the plotter's internal plots.
- You are experienced at installing printers or plotters.
- You don't want to add extra memory.

700

For the HP DesignJet 700:

- You are going to use roll media.

750C Plus

For the HP DesignJet 750C Plus:

- You are going to use roll media and print in color.
- You know whether to connect the plotter directly to your computer or to a network and whether to use the parallel or serial interface, and you already have the right cable.
- (Serial interface users) Your computer's RS-232-C settings are 9600 baud, no parity, 8 data bits and 1 stop bit.

... Just Do the Following Six Steps and Skip the Rest of This Chapter.

- 1** Connect the power cord and switch on.
- 2** Load the roll of media supplied, following the instructions on the label inside the plotter's roll cover. Watch the front-panel display for further instructions.
- 3** Press **Access Cartridge(s)** and open the plotter window.

700

For the HP DesignJet 700:

Load the black print-cartridge into the carriage on the left side of the plotter. Don't forget to remove the tape from the cartridge.

750C Plus

For the HP DesignJet 750C Plus:

Load the four color print-cartridges into the carriage on the left side of the plotter. Don't forget to remove the tape from the cartridges.

Continued...

- 4** Close the plotter's window and let the plotter run its automatic cartridge-alignment procedure.
- 5** Switch off the plotter and your computer, connect the interface cable, and then switch them on again.
- 6** Choose your driver disk(s), read the instructions on the label, and follow any printed instructions accompanying the disks. For AutoCAD or Microsoft Windows applications, the driver is shipped with the plotter. For other applications, see page 1-38 for advice, and, if necessary, contact your software vendor.



Set Up Checklist

You should already have unpacked and assembled the plotter, following the Assembly Instructions in the box. Now you can set up the plotter, using the checklist below as you complete each task explained in this chapter.

Task	Done? (✓)
1 Check that you have all the items required.	
2 Install memory expansion modules (<i>Optional</i>).	
3 Switch on and change the language from English (<i>Optional</i>).	
4 Load media.	
5 Load the print-cartridge(s).	
6 Print the demonstration plot (<i>Optional</i>).	
7 Connect the plotter to your computer.	
8 Configure the interface (<i>Serial interface users only</i>).	
9 Set up your software.	
10 Print a test plot.	

Task 1: Check That You Have All the Items Required

Supplied

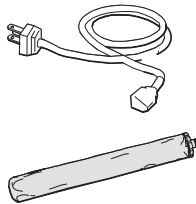

- You need the following items, which were supplied with the plotter.

- **Power cord**

The power cord supplied with your plotter should meet the plug requirements for your area. However, different power cords (international options) are available. If necessary, contact your dealer or HP Sales and Support Office.

- **A roll of HP Opaque Bond Paper** (for the HP DesignJet 700)

- **A roll of HP Coated Paper** (for the HP DesignJet 750C Plus)

- **Print cartridge(s):**

For the HP DesignJet 700:

- Two black

For the HP DesignJet 750C Plus:

- One yellow
- One cyan
- One magenta
- Two black

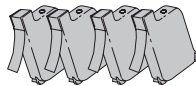

750C Plus

- Inspect the plotter itself and the above accessories. If you received any item in a damaged condition, notify the dealer or HP Sales and Support Office where you purchased the plotter, and file a claim with the carrier.

Not supplied



- You will also need the following items, which were not supplied with the plotter.

- **Interface cable**

For details of suitable cables, see page 11-8.

Optional

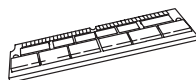

- If you have purchased extra memory, you will need your

- **Memory expansion module**

For details of the memory expansion modules available, see page 11-14.

Task 2: Install Memory Expansion Modules (Optional)

700

Your plotter comes with 5.5 MB of standard memory.

750C Plus

Your plotter comes with 11 MB of standard memory.

You can expand this by adding *one or two* memory expansion modules, in any combination. Supported sizes are 4 MB, 8 MB, 16 MB and 32 MB. So the maximum standard memory for your plotter is:

700

$5.5 + 32 + 32 = 69.5$ MB

750C Plus

$11 + 32 + 32 = 75$ MB

For HP part numbers, see page 11-14.

- 1 Make sure that the plotter is switched OFF and that neither the power cord nor an interface cable is connected.

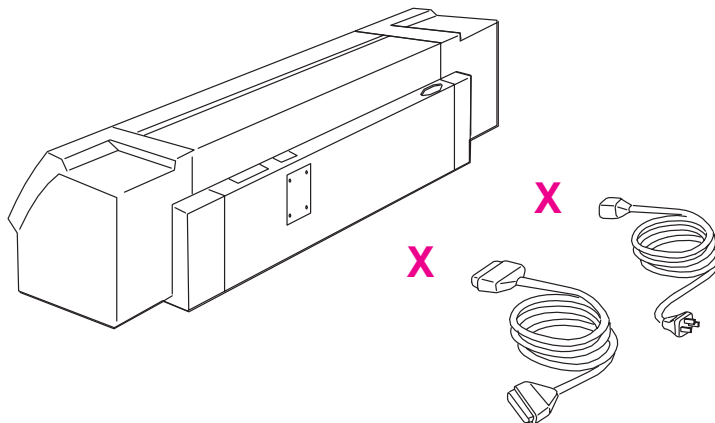

1847

Task 2: (Optional) Install Memory Expansion Modules

- 2** Using a flat-blade screwdriver, unscrew the cover plate at the back of the plotter, and remove it. Unscrew only the four screws on the cover plate.

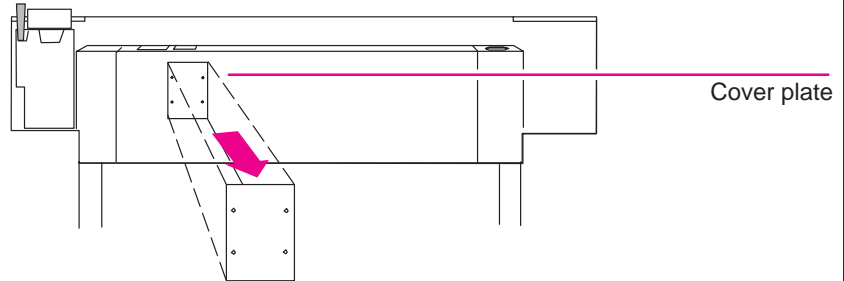

The two slots on the *right* are for memory expansion modules. Use slot 3 first, and then slot 4.

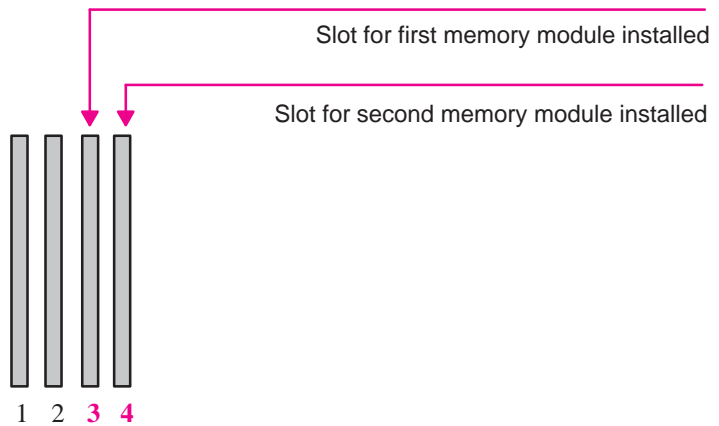

If your plotter has only one memory module, it must be in slot number 3.

1845a

Task 2: (Optional) Install Memory Expansion Module

CAUTION

Before handling a memory module, either put on a grounding wrist strap and attach the end to the metal chassis of the plotter, or touch the outer metal surface of the plotter with your hand. Otherwise, static electricity from your body could damage the memory module.

3 Take the memory module out of its bag, holding the module only by the edges.

- 4
- a Hold the module by its edges with the nonmetallic edge toward you and the small notch at the bottom.
 - b With the nonmetallic edge angled to the right, firmly push the module into the slot. Gradually straighten the angle and push it in until it clicks into place.

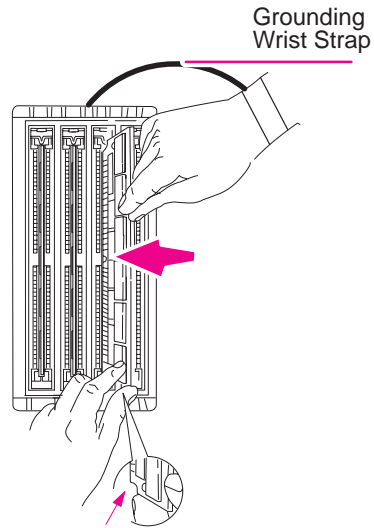

1846

5 Using a flat-blade screwdriver, replace the cover plate and its four screws.

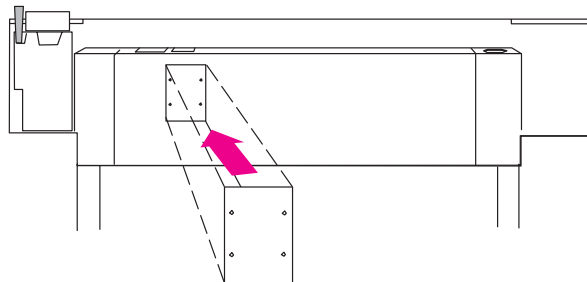

1845b

Task 3: Switch On and Change the Language From English (Optional)

The plotter's front-panel menus and all the plotter's sample plots are available in the following languages¹: English, French, German, Italian, Japanese, Portuguese, and Spanish. By default, the language is English.

WARNING

Be sure that the power cord supplied with your plotter matches your ac power connection requirements. Use only three-wire (earth-grounded) power cords with this plotter.

- 1 Make sure that the power switch on the front of the plotter is OFF.

- 2 Plug the power cord into the socket at the back of the plotter, and then into your power outlet.

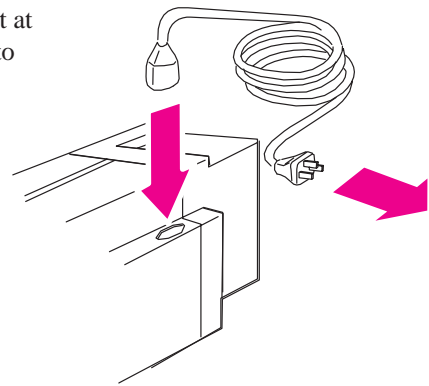

1848

If English OK
or if you have
already
changed the
language

- 3 Switch on the plotter by pushing the power switch. Then go to Step 4.

on

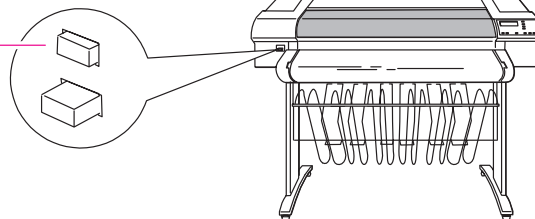

If there is no sound, nor any light on the front panel, you have a power problem.

1843

¹ The physical front-panel overlay is also available in Chinese, Korean and Taiwanese.

Setup Task 3: Switch On and (Optional) Change the language From English

If English not OK 4
or if you want
to change the
language

Hold down the **Enter** key on the front panel and then switch on the plotter by pushing the power switch.

1 Press and hold

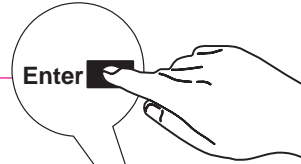

2 Switch on

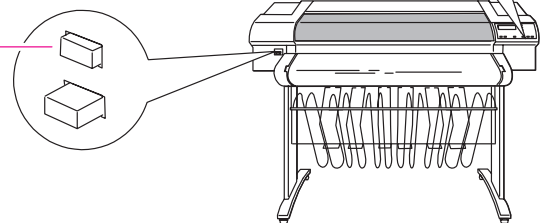

Release the **Enter** key when "STATUS / Initializing" appears on the front-panel screen. If there is no sound, nor any light on the front panel, you have a power problem.

1843a

5 When the word "English" appears on the front-panel screen, press the ↑ or ↓ key until your language appears. Then press **Enter**.

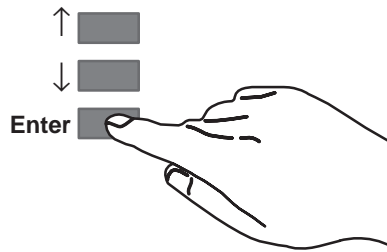
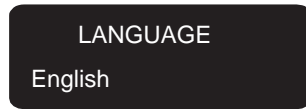

0014

Task 4: Load Media

For advice on the availability and use of different media types, see the section starting on page 3-2.

IMPORTANT

Because the next task is to load the cartridge(s) and carry out the automatic cartridge alignment procedure, you *must* load *opaque* media at this stage – for example, opaque bond (plotter paper) for the DesignJet 700 or coated paper for the DesignJet 750C Plus, as this necessary for the alignment procedure. A roll of suitable HP Media is supplied with your plotter.

To load roll media, start with step 1 below.

To load sheet media, go to page 1-18.

To Load a Roll

- 1 Make sure the plotter wheels are locked (the brake levers pressed down) to prevent the plotter from moving.
- 2 Open the roll cover and remove the empty spindle by pulling firmly on each end. The two ends are different: end A has a media stop and end B a smaller end cap, as shown on the next page.

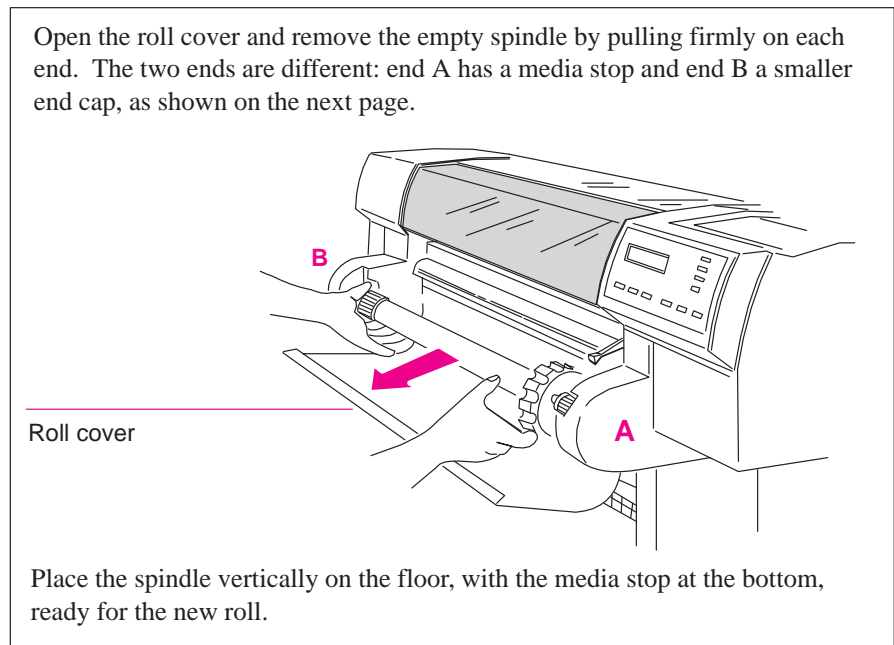

1865

Task 4: Load Media

- 3** Remove the new roll from its wrapping. Remove the end cap from the top of the spindle, and slide the new roll onto the spindle. The leading edge of the media *must* wind clockwise.

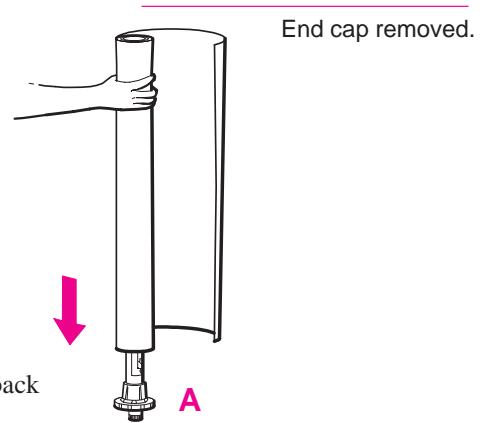

- 4** Push the end cap back in, making sure that the tabs are flush against the ends of the roll. Push it far enough to be firm, but do not use excessive force as this may break the tabs.

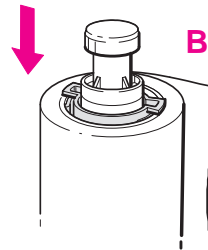

- 5** Insert the spindle so that the large media stop (A) is to the right and the small end cap (B) to the left. Push in firmly on both ends. Be sure the media remains flush against the media stop.

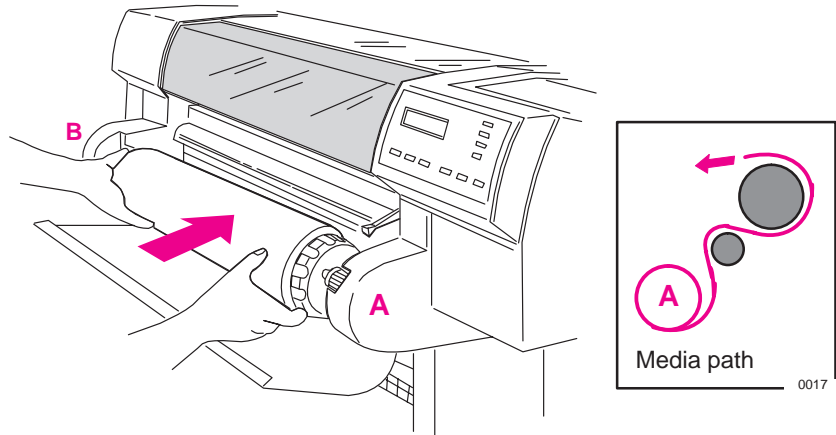

The relationship of the media to the roller must be as shown in the diagram above.

- 6** Check the leading edge as it unwinds from the spool. If it is uneven, trim it as explained in step 7. Otherwise go to step 8.

Task 4: Load Media

WARNING

The media cutting knife used in the next step is sharp. Make sure the plotter's wheels are locked. Keep fingers clear of the cutting path. Keep media cutting knife away from children.

7

Trim the leading edge of the media roll:

- a Pull the media over the top of the machine and lay it over the cutting track.
- b Use the media cutting knife in the pocket located at the back of the plotter to cut off the first few inches of the media.
- c Retract the blade and return the media cutting knife to its pocket.

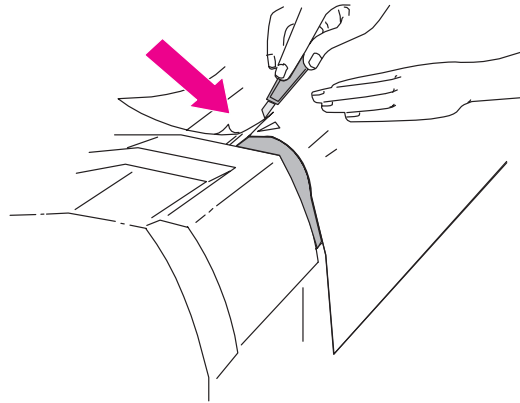

1838

- 8**
- a** Pull the media towards you and, holding it from the sides, align its right edge with the perforated line on the entry platen.
 - b** Insert the leading edge into the plotter, until the page buckles slightly.
 - c** Let go of the media when the plotter begins to pull it in.

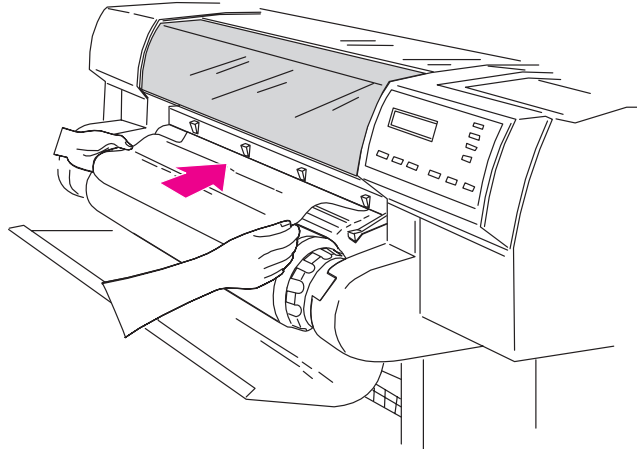

1839

- 9** Press the ↓ key next to the front-panel display to indicate you are loading a roll.

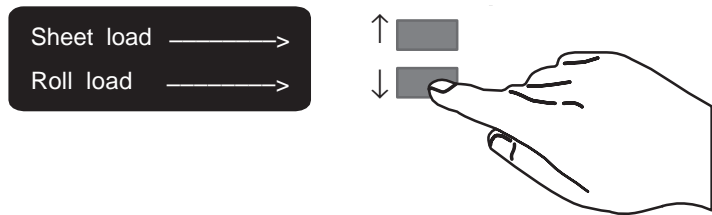

0014

Task 4: Load Media

- 10 Press the ↑ or ↓ key until the display shows the type of media you are loading and then press the **Enter** key.

700

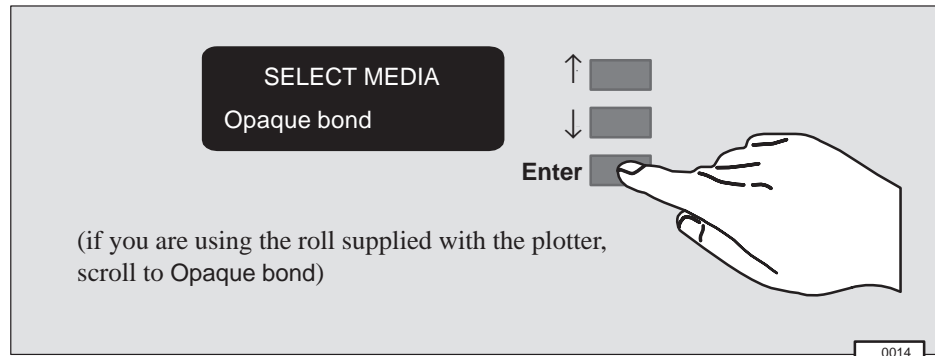

750C Plus

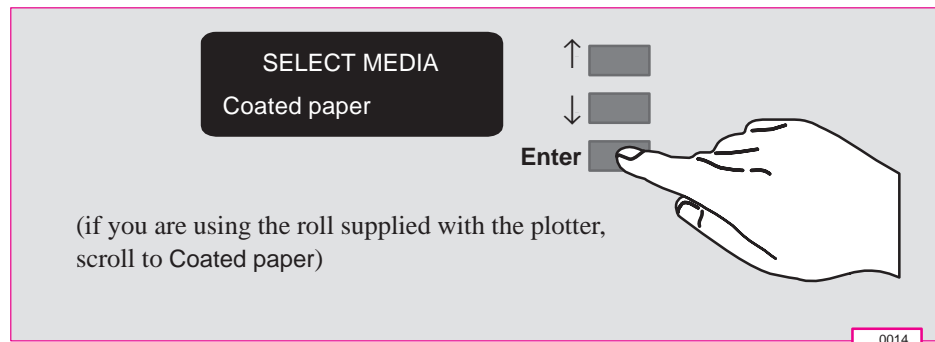

- 11 a** When the front panel instructs you, lift the media lever.
- b** Take hold of the edges of the media now extending from the exit slot and pull the media toward you until taut. Then align the left and right edges of the media so that they are flush with the edges of the roll.

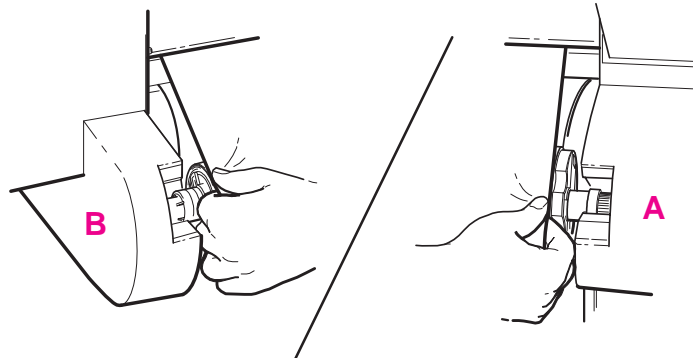

- c** When the front panel instructs you, lower the media lever.

0018

- 12 a** When the plotter instructs you to close the roll cover, rewind the media stop in the direction shown by the large arrow below, to take up any slack in the roll. Make sure that the leading edge of the media is outside the roll cover, and then close the cover.

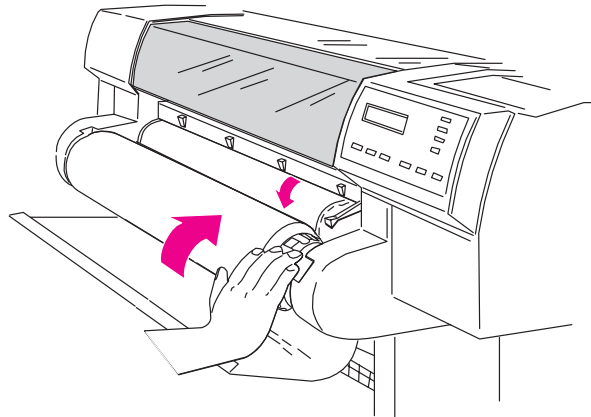

- b** Press the ↓ key to continue. The plotter automatically trims off the first few inches of media.
- c** The roll media is now loaded and ready for plotting.

1840

Task 4: Load Media

To Load a Sheet

You can load a sheet in either portrait or landscape orientation. (Your choice of orientation is significant when sending a plot from your software, but for the moment it doesn't matter.)

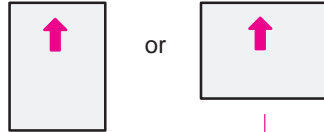

Printing will be on the underside. So, if loading Coated paper, load with the coated side down. For advice on other media types, see page 3-18.

1 Make sure the media lever is down and the roll cover is closed.

- 2**
- a** Holding the media from the sides, align the right edge with the perforated line on the entry platen.
 - b** Insert the media until it buckles slightly, that is, push all the way to the media stops. Let go of the media when the plotter begins to pull it in.

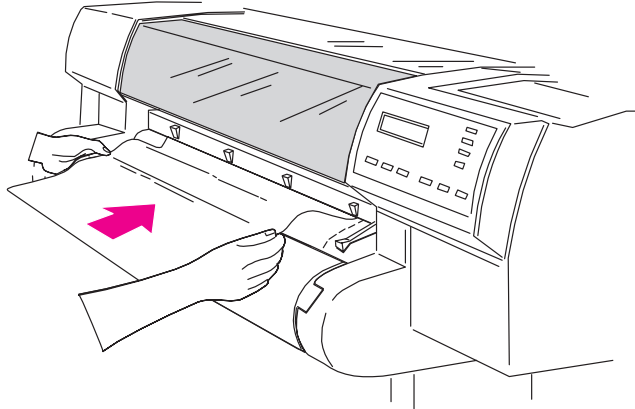

1841

- 3 Press the ↑ key next to the front-panel display to indicate you are loading a sheet.

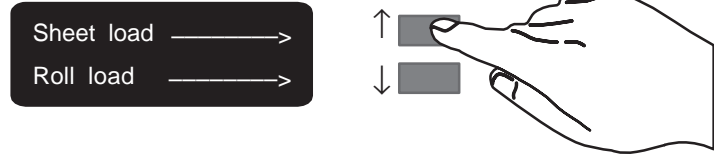

0014

- 4 Press the ↑ or ↓ key until the display shows the type of media you are loading (if you are using regular plotter paper, scroll to Opaque bond; if coated paper, scroll to Coated paper), and then press the **Enter** key.

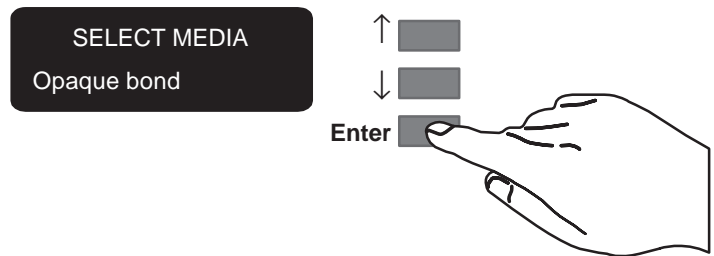

0014

- 5 The plotter moves the sheet in and out to check its size and alignment, and then advances it to the start of the page. When sheet loading is complete, STATUS / Ready is displayed.

If you have persistent difficulty loading media, this may indicate poorly cut media – see page 3-21 for advice.

Task 5: Load the Print Cartridge(s)

Task 5: Load the Print Cartridge(s)

Cartridge types

IMPORTANT Your plotter is designed to operate only with the cartridges whose part numbers are listed on page 11-15, and samples of which are supplied with the plotter.

700

- The HP DesignJet 700 is supplied with two black cartridges (one is a spare cartridge).

750C Plus

- The HP DesignJet 750C Plus is supplied with five cartridges:
 - yellow
 - cyan
 - magenta
 - black (plus one spare black cartridge)

For the 750C Plus, each stall in the carriage has a dot indicating the color of the cartridge that should be installed. You *must* put the correct cartridge in the correct stall otherwise not only will your colors be wrong, but also print quality may be impaired. The sequence of the colors is, from left to right, yellow, cyan, magenta and black.

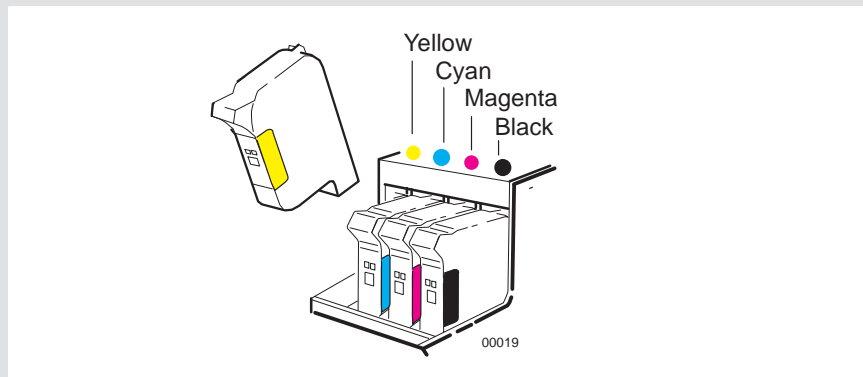

For users with color-vision deficiencies. You can identify the colors of the cartridges by the part numbers on the boxes – see page 11-15.

Note. Except on glossy media types, the plotter will operate successfully in monochrome with just the black cartridge loaded, but these instructions assume that you are loading *all four* cartridges.

WARNING

Do not touch the stainless steel strip that runs the length of the plotter behind the cartridge carriage; its edge is very sharp. Keep hair, jewelry, clothing, and foreign objects away from the plotter mechanisms.

- 1
 - a Press the **Access Cartridge(s)** key and wait for the cartridge carriage to come to a complete stop next to the front panel.
 - b When the carriage stops, open the window.

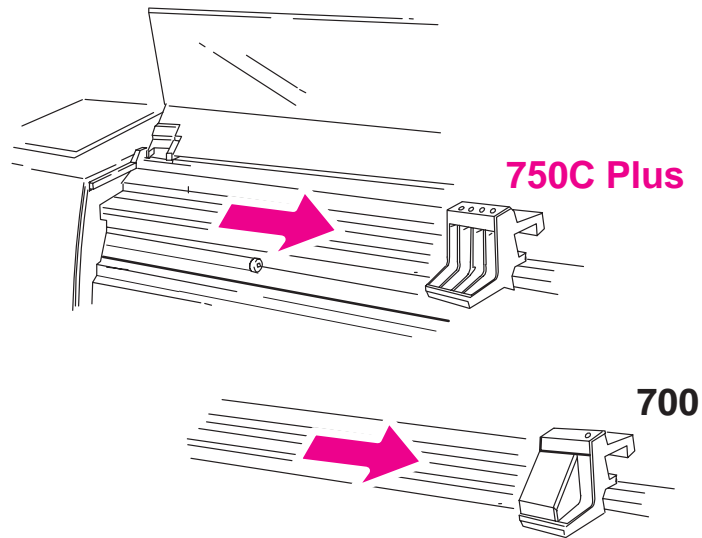

1849

CAUTION

It is essential to load the cartridge(s) *with the plotter switched ON*, otherwise you will get poor print quality, and the reliability of your cartridge(s) will be impaired.

WARNING

Keep new and used print cartridge(s) out of the reach of children.

Task 5: Load the Print Cartridge(s)

2 For each cartridge in the set:

- a** Take the cartridge out of its box.
- b** Remove the colored protective tape and tab from the cartridge's nozzles.

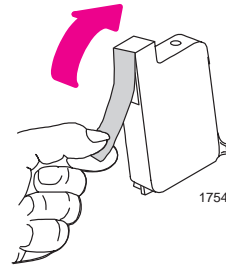

For the 750C Plus, match the color of the cartridge's label with the color of the dot above the stall.

750C Plus

- c** Make sure that the plotter is still switched ON (Never install cartridges with the plotter switched OFF).
- d** Insert the cartridge in the stall. Press down lightly and push the cartridge away from you until it snaps into place. If the front-panel display says Reseat cartridge(s), then remove the cartridge and insert it again. Do so until the message disappears.

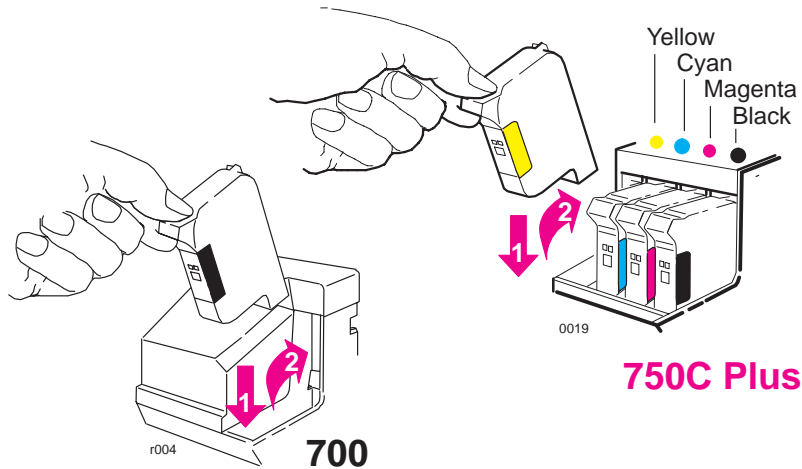

- 3 When the cartridges are successfully installed, the plotter automatically runs the cartridge alignment procedure. When the front-panel displays STATUS / Ready, the procedure is complete. You can throw away the small print produced during the cartridge alignment procedure.

To make your cartridges last as long as possible, you should not remove them once they are installed, except to replace them.

CAUTION

Now that the cartridge(s) are loaded, *never* turn the plotter upside down, or ink will spill.

Task 6: Print a Demonstration Plot (Optional)

Before you connect your plotter to a computer, it is a good idea to print one of the internal sample plots. This ensures that the plotter itself is operating properly.

- 1** If media is not already loaded, load a roll or a sheet, as explained earlier in task 4. For advice on the availability and use of different media types, see the section starting on page 3-2.

2

On the front-panel display, go to Demos, as shown below.

STATUS
Ready

Press **Enter**

SHORT MENU
Queueing & Nesting →

Press ↓

SHORT MENU
Demos →

Press **Enter**

DEMOS
Palette
Press **Enter** to choose this or ↓ to get to the next option

DEMOS
Samples

Press **Enter** to choose this or ↓ to get to the next option

DEMOS
Menu

Press **Enter**

750C Plus

750C Plus

Palette prints the **Palette Demo**, which is explained on page 5-4.

Samples accesses a list of sample demonstration plots stored in the plotter's firmware. If only one is available, it starts processing as soon as you press **Enter**.

Menu prints a menu tree of the entire front-panel menu structure.

Task 6: (Optional) Print a Demonstration Plot

3 The **Receiving** light flashes while the plot is being processed, and then the plotter starts printing. After it has finished:

- On roll media, the plotter waits for the ink to dry, if necessary, and drops the plot into the media bin.
- On sheet media, wait until the ink is dry, if necessary (see the front-panel display for an ink-drying message), and then gently pull the sheet out from the plotter. On HP Coated Paper you don't need to wait at all.

4 Examine the plot, with the following questions particularly in mind:

- Are the lines clean and complete?
- Are the area fills smooth?
- Are the black and white areas correctly defined?
- Is the color of good quality?

700

750C Plus

Unless you changed it, the print-quality setting on the front panel was Best. If you have any concerns about the print quality of the sample plot, use the troubleshooting advice starting on page 9-16.

Task 7: Connect the Plotter to Your Computer

For UNIX systems, see also the tips starting on page 1-40.

If You Are Connecting the Plotter Directly to a Network

You can connect your plotter directly to a Local Area Network using an optional network interface card such as the **HP JetDirect Print Server**. Depending on your needs, you may want to use the network interface *instead of*, or *in addition to*, the parallel and serial interfaces.

The slot for a network interface card is situated at the back of the plotter, alongside the parallel and serial ports. Using a flat-head screwdriver, unscrew only the two screws on its cover plate.

Slot for Network Interface Card

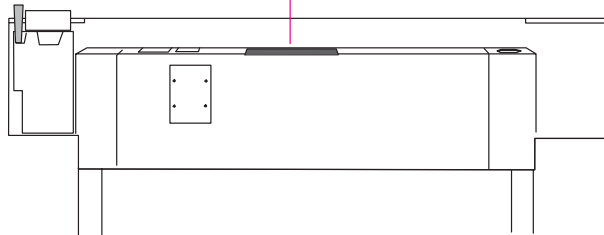

For installation and configuration of the HP JetDirect Print Server, see the documentation supplied with that product.

1845c

Task 7: Connect the Plotter to Your Computer

If You Are Connecting the Plotter Directly to Your Computer

- 1 Decide whether to use the parallel or serial interface.

If your computer and your application software support it, use the parallel interface, as it is faster. You can connect both the parallel and the serial interface simultaneously if you wish: the plotter uses the interface that first receives data.

- 2 Choose an interface cable.

A list of recommended HP cables for various computers starts on page 11-8.

IMPORTANT

To achieve the best performance from your plotter, we recommend you only use genuine *Hewlett-Packard* interface cables, whose reliability and performance have been thoroughly tested to give trouble-free performance.

- 3 Switch OFF the plotter and then the computer.

- 4 Connect one end of the cable to the appropriate port on the back of the plotter.

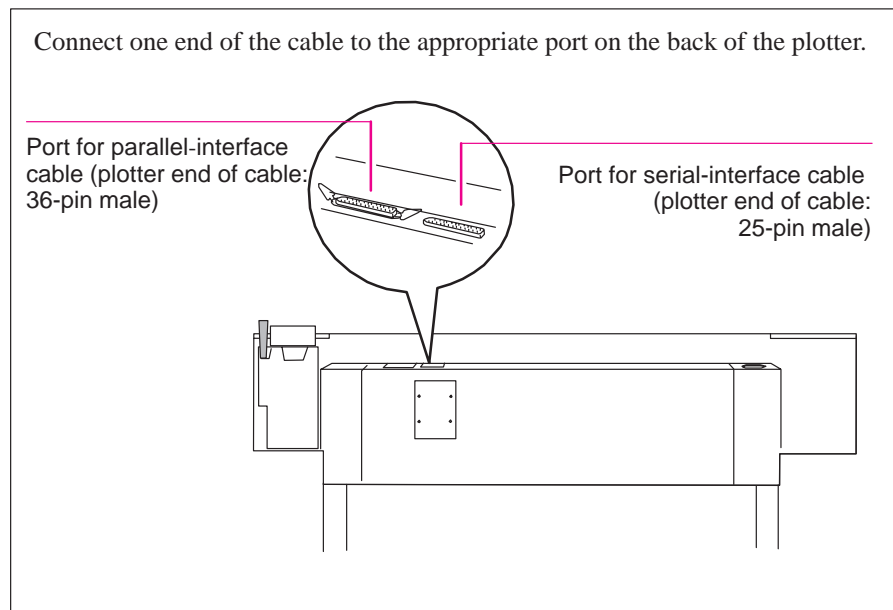

- 5 Connect the other end of the cable to your computer. For help on choosing the correct port on the computer, refer to your computer documentation.

- 6 Switch ON the computer and then the plotter.

Task 8: Configure the Interface (*Serial Interface Users Only*)

The following table shows the settings available for the plotter's serial interface parameters, the factory defaults and the most likely requirements for different computers.

Serial (RS-232-C) Settings				
Parameter	Available settings	Likely requirement for ...		
		PC	Macintosh	Unix
Baud rate	1200 2400 4800 <i>9600</i> 19200 38400	<i>9600</i>	(2)	<i>9600</i>
Parity ⁽¹⁾	<i>None</i> Even Odd	<i>None</i>	(2)	<i>None</i>
<p><i>Italics = factory default</i></p> <p>(1) Parity of None = 8 data bits, 1 stop bit Parity of Even or Odd = 7 data bits, 1 stop bit</p> <p>(2) Consult your software documentation.</p>				

The settings on the plotter must match those of the computer and software sending the data. Use their documentation to find the requirements. If in doubt, try with the above suggestions. If the plotter's defaults already match the requirements, then you can skip the rest of this task.

Task 8: (Serial Interface Users Only) Configure the Interface

To Change the Plotter's Serial Interface Settings

Through the front-panel display, you can create and save two sets of configurations for the serial interface, called Configurations A and B. By default they are set to the factory defaults shown in the table on page 1-29. The factory default configuration is always available as well, giving you up to three stored configurations to choose from.

The instructions that follow explain how to specify and apply Configuration A. Configuration B can be specified in the same way. To restore the factory default configuration see page 7-6

Task 8: (Serial Interface Users Only) Configure the Interface

- 1** On the front-panel display, change the Menu mode from Short to Full.

STATUS
Ready

Press **Enter**

SHORT MENU
Queueing & Nesting →

Press ↓

SHORT MENU
Demos →

Press ↓

UTILITIES
Menu mode=Short →

Press **Enter**

MENU MODE
Short*

Press ↓

MENU MODE
Full

Press **Enter**

UTILITIES
Menu mode=Full →

Press **Previous**

FULL MENUS
Utilities →

If FULL MENUS is displayed instead of SHORT MENU, you can skip this step and go to step 2.

Task 8: (Serial Interface Users Only) Configure the Interface

2

Get to the routine for defining a new serial configuration.

FULL MENU

Utilities →

Press ↓

FULL MENU

I/O setup →

Press **Enter**

I/O SETUP

Modular →

Press ↓

I/O SETUP

RS-232-C →

Press **Enter**

RS-232-C

Config=Factory →

Press ↓

RS-232-C SETUP

Define config

Press **Enter**

DEFINE CONFIG

Config A →

Press **Enter**

CONFIG A

Baudrate=9600

Task 8: (Serial Interface Users Only) Configure the Interface

- 3 Configure the serial interface to match your software configuration.

CONFIG A
Baudrate=9600 →

Press **Enter**

BAUDRATE
9600*

Press ↑

BAUDRATE
19200

Press **Enter**

CONFIG A
Baudrate=19200 →

Press ↓

CONFIG A
parity=None(0) →

Press **Enter**

PARITY
none(0)*

Press ↓

PARITY
Even

Press **Enter**

CONFIG A
Parity=Even →

Press **Previous** until you return to ...

This example changes the configuration to 19200 Baud and Even parity.

RS-232-C
Config=Factory →

Task 8: (Serial Interface Users Only) Configure the Interface

4 Switch to the new configuration.

RS-232-C
Config=Factory →

Press **Enter**

CONFIG
Factory*

Press ↓

CONFIG
Config A

Press **Enter**

RS-232-C
Config=A →

Press **Previous** until you return to ...

STATUS
Ready

Task 9: Set Up Your Software

This section gives a **simple overview** of the software-configuration tasks you need to perform and is designed for those users unfamiliar with this type of task. It also points to documents containing detailed, application-specific advice.

More experienced users may prefer to go straight to those documents.

For UNIX systems, see also the tips starting on page 1-40.

Basic Terminology

Application software	Application software means the software from which you intend to send plots to your plotter – for example, a CAD system, a graphics package, a desktop publishing system etc.
Drivers	<p>Your application software needs to know to which type of plotter it is sending information. This knowledge, and other configuration information, is held in a “driver.” The driver is a piece of software that handles communications between your application software and your plotter.</p> <p>To make sure that your plotter prints exactly what you expect – in terms of size, position, orientation and quality – use the correct driver for the combination of your application software and your plotter.</p>

Typical Checklist of Tasks to Set Up Your Software

- 1** Identify which driver you need.

Some are supplied with this plotter, as listed in the table on page 1-37. Others are supplied with your application software.

- 2** If necessary, install the driver on your computer, see the table on page 1-37.

- 3** Add this plotter to the device list in the software.

This list may be accessed, for example, through CONFIG / Add a Plotter (in AutoCAD), Printer setup (in Microsoft Windows applications) or Printer type (in Macintosh applications). In most cases, you don't need to add the plotter for each individual software application, but, for example, just once for all Microsoft Windows applications.

- 4** Configure the driver.

This usually involves a series of dialog boxes where you can specify such items as default media type, print quality etc.

IMPORTANT

In most cases these settings will override any settings you make on the front panel of the plotter.

Software and Accessories Supplied with this Plotter, or Available as an Option

Use the information in the table below to decide if you need to install and set up any of the software supplied with this plotter. If you don't know whether your application sends PostScript files to the plotter (and therefore whether the plotter may require the PostScript Upgrade Kit), consult your application software and its documentation.

Item	For use on	Supplied or optional	Installation
Drivers for AutoCAD	PC	Supplied	Install the software on your computer.
Driver for Microsoft Windows 95 and 3.1 Applications ¹	PC	Supplied	Install the software on your computer.
PostScript Upgrade Kit	PC Macintosh	Optional	Install the firmware in your plotter. Install the software on your computer.
HP JetDirect Print Server	PC Macintosh Unix	Optional	Install the hardware in your plotter. Install the software on your computer.
¹ These items are updated from time to time. For details of which software versions are supported, see the documentation included with them.			

Task 9: Set Up Your Software**Other Applications**

If you are going to use applications other than AutoCAD or Microsoft Windows applications, first check any Software Application Notes supplied with this plotter, to see if the application is covered there. If not, here is some general advice:

The device list in your software may not be up to date with the latest plotters available. If the HP DesignJet 700 or HP DesignJet 750C Plus is not quoted by name in your application's device list, select an alternative plotter as follows:

Preference	Device	Comments
1	HP DesignJet 750C or HP DesignJet 755CM	
2	HP DesignJet 350C or HP DesignJet 330	
3	HP DesignJet 250C or HP DesignJet 230	
4	HP DesignJet 220	
5	HP DesignJet 650C	With a preference for C2858B/C2859B rather than C2958A/C2859A
6	HP DesignJet 200	
7	HP DesignJet 600 or HP DesignJet	
8	HP-GL/2 Device	or a similar option including a reference to HP-GL/2
9	HP 7600	
10	HP 7595B DraftMaster SX or HP 7596B DraftMaster RX or HP 7599A DraftMaster MX or HP 7595C DraftMaster SX Plus or HP 7596C DraftMaster RX Plus or HP 7599B DraftMaster MX Plus	
11	HP 7586B	If you choose these devices you may not be able to use your plotter's parallel connection – depending on the application software.
12	HP 7580 or HP 7585	
The devices in the gray boxes support only HP-GL. The others support HP-GL/2 and HP-GL.		

Task 10: Print a Test Plot

The sample plots explained in task 6 simply verify the operation of the plotter itself. Having connected the plotter to your computer and configured the drivers or other software for your requirements, you should now be in a position to send a test plot using one of your own files.

Among the points you should be looking out for are:

- Did the **Receiving** light on the front panel come on?
- Do you see any error message on the front-panel display?
- Does the image appear in the size, orientation and position on the sheet that you expected?
- Is any of the image clipped?
- Are the lines of the correct width?
- Are the colors an exact representation of what you expected?

750C Plus

If you find any problem at all, start by consulting chapter 9 of this manual, “Troubleshooting.” There you will find advice on many different types of problems, from obtaining no plot at all, to tracking down the reason for a specific print-quality issue. In case you do not solve your problem with the information supplied there, chapter 9 also contains advice on where else to turn for help.

Extra Tips for UNIX Users

Which Interface?

You can connect the plotter to your workstation in one of two ways:

- Via the UNIX print-spooling system, using any of the interfaces: network, parallel or serial
- Directly using the serial interface

Recommendations

The *print-spooling system* is recommended, so that printing takes place in the background while you continue using your application. A *Print Server* is also recommended, as it will give you not only more flexibility in locating the plotter, but also the possibility of network integration and centralized plotter configurations using BOOTP (Bootstrap Protocol) and TFTP (Trivial File Transfer Protocol).

If you choose the *parallel interface*, you may need a parallel interface card for your workstation. Contact your workstation supplier for details.

Print Spooler Configuration Examples

Example 1: Configuring the SunOS 4.1.3 Print Spooler for Sun SPARCstations (parallel interface)

In order to perform the following steps you must be a superuser.

- 1 Create a directory for print spooling. All application users need read and write permission for this directory. For example, from the command line of a shell, type

```
mkdir /usr/spool/cad
chmod 777 /usr/spool/cad
```
- 2 Edit the `/etc/printcap` file to set up the plotter configuration. You must assign a name to each printer or plotter managed by the print spooler. Refer to the example below if you need help completing this step.

Add these lines to your `/etc/printcap` file if:

- your plotter is named `djet`,
- the device name of your parallel port is `/dev/bpp0`, and
- your spool directory is called `/usr/spool/cad`.

Entry for an HP plotter on a parallel port
`djet:\`

```
:mx#0:sf:sh:\
:lp=/dev/bpp0:\
:sd=/usr/spool/cad:\
:lf=/usr/adm/lpd-errs:
```

Example 2: Configuring the SunOS 4.1.3 Print Spooler for Sun SPARCstations (serial interface)

In order to perform the following steps you must be a superuser.

- 1 Create a directory for print spooling. All application users need read and write permission for this directory. For example, from the command line of a shell, type

```
mkdir /usr/spool/cad
chmod 777 /usr/spool/cad
```

- 2 Edit the `/etc/printcap` file to set up the plotter configuration. You must assign a name to each printer or plotter managed by the print spooler. Refer to the example below if you need help completing this step.

- 3 Add these lines to your `/etc/printcap` file if:

- your plotter is named `djet`, and
- your plotter is connected to the device named `/dev/ttya` (usually the first serial port on the workstation), and
- the spooling directory you created in step 1 is called `/usr/spool/cad`.

```
# Entry for an HP plotter on a serial port
```

```
djet:\
```

```
    :lp=/dev/ttya:sd=/usr/spool/cad:br#9600:\
```

```
    :lf=/usr/adm/lpd-errs:\
```

```
    :sf:sh:mx#0:xc#0177777:xs#040040:fc#050:\
```

```
    :ms=-evenp:
```

- 4 Make sure the plotter's baud rate is 9600 and parity is even.

Example 3: Configuring the SunOS 4.1.3 print spooler for Sun SPARCstations (HP JetDirect Print Server)

See the *Configuration Guide* shipped with the HP JetDirect Print Server.

Example 4: Configuring the Solaris 2.x Print Spooler for Sun SPARCstations

In order to perform the following steps you must be a superuser or belong to the special sysadmin (GID=14) group. If you are using the NIS+ name service, you may need NIS+ permission to modify the printer table. Refer to your Sun documentation for details.

- 1 Create a directory for print spooling. All application users need read and write permission for this directory, so you must be a superuser to perform this step. For example, from the command line of a shell, type:

```
mkdir /usr/spool/cad
chmod 777 /usr/spool/cad
```

- 2 Start the Administration Tool utility (from OpenWindows™).
 % /bin/admintool
- 3 Load the Printer Manager window, and, from the Add Printer edit menu, select Add Local Printer.
- 4 In the Add Local Printer dialog box:

Item	Select
Printer Name:	For example, HP DesignJet 700 or HP DesignJet 750C Plus, depending on the plotter you have purchased
Printer Type:	Other, and set it to Unknown
File Contents:	Any
Banner:	Not required

For full details on how to use the Printer Manager option of admintool, consult your Sun documentation.

- 5 Exit admintool.
- 6 For serial connections:
 - a Make sure the plotter's baud rate is 9600 and parity is even.
 - b From the command line of a shell, as superuser, enter the following:

```
lpadmin -p pname -o "stty='9600 evenp -cstopb ixon ixoff"
```

where *pname* is the same as Printer Name in step 4. It is assumed that /usr/sbin is in the superuser's path.

The Front Panel 2-2

 The Display Section 2-3

Printing the Menu Plot 2-5

 Description of the Menu Plot 2-5

Entering the Menu System 2-6

Navigating the Menu System 2-7

 Menu Graphics Used in This Manual 2-9

Other Types of Screen 2-10

Examples 2-11

 Example 1: Changing Margins 2-11

 Example 2: Changing the Drying Time 2-12

Learning How To Use the Front Panel Display

Tutorial

The Front Panel

The Front Panel

The front panel of the HP DesignJet 700 and 750C Plus plotters is shown below:

700

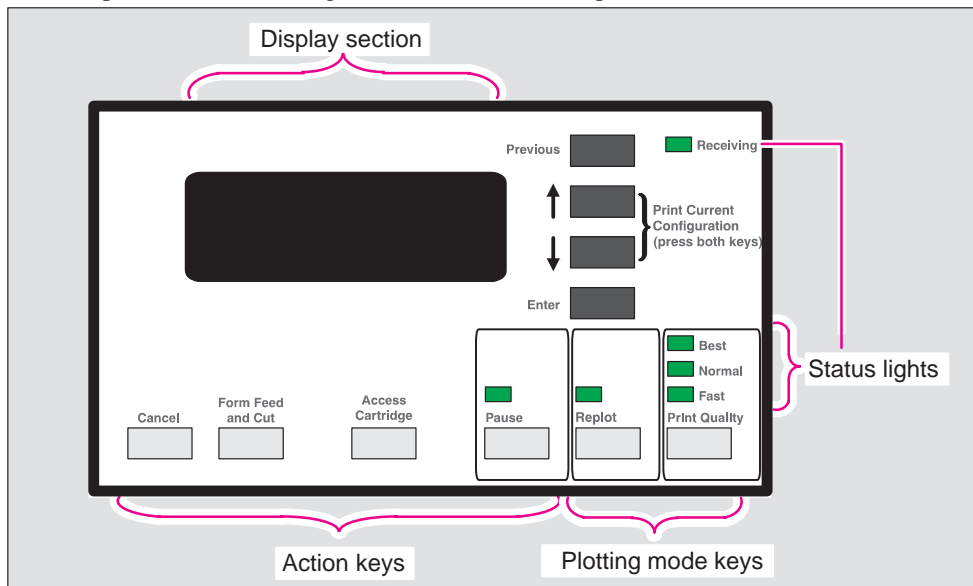

750C Plus

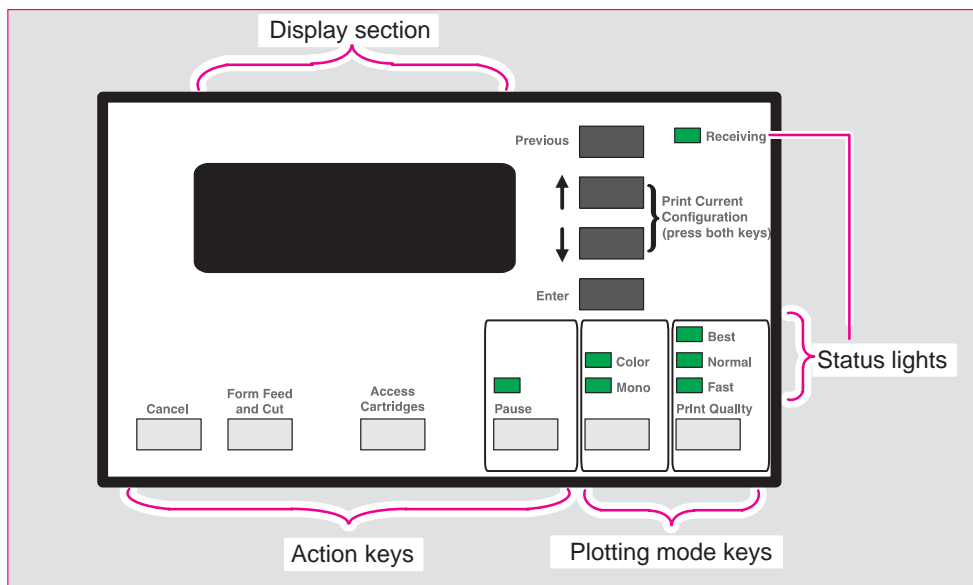

The purpose of this tutorial is to explain the use of the display section. The other sections and their use are described later in this manual.

The display section is used primarily for setting the plotter's configuration, so, before the tutorial, print the *current* configuration. You can then return to this afterwards.

- 1 Make sure that media is loaded. See page 3-10 for loading information.
- 2 Print the **Current Configuration** plot, by pressing the ↑ and ↓ keys simultaneously.

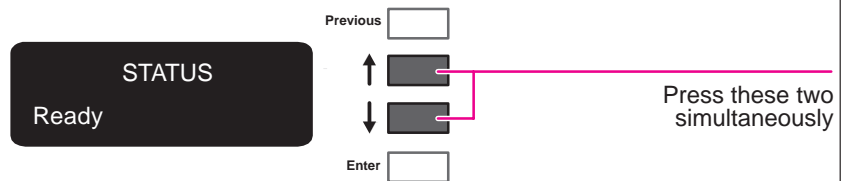

Keep the plot for later reference.

The Display Section

The display section of the front panel consists of the display itself and the four display keys to its right (**Previous**, ↑, ↓ and **Enter**).

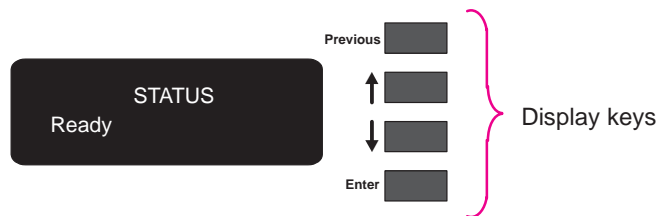

The Front Panel

The display can show two lines of text and is used for displaying:

- Menus, for example



In this case, you can use the display keys to navigate the menu system and select menu options.

- Messages, for example

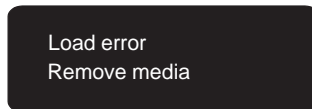

These messages may concern machine status, actions required or errors.

In this case, you can use the display keys to respond to messages. See chapter 10, "Front panel messages" for more information.

Printing the Menu Plot

You can see the complete menu structure available on the plotter by printing the Front Panel Menu plot. To help you understand the menu structure and how to navigate it, print it now

- 1 Check that media is loaded. See page 3-10 for loading information.
- 2 Select the Menu option from the DEMO PLOTS menu, as described in *chapter 1, task 6*. The Front-Panel Menu plot will be printed.

Description of the Menu Plot

Look at the Front-Panel Menu plot . It shows the full menu structure. Here is a sample section of it (concerned with pen settings):

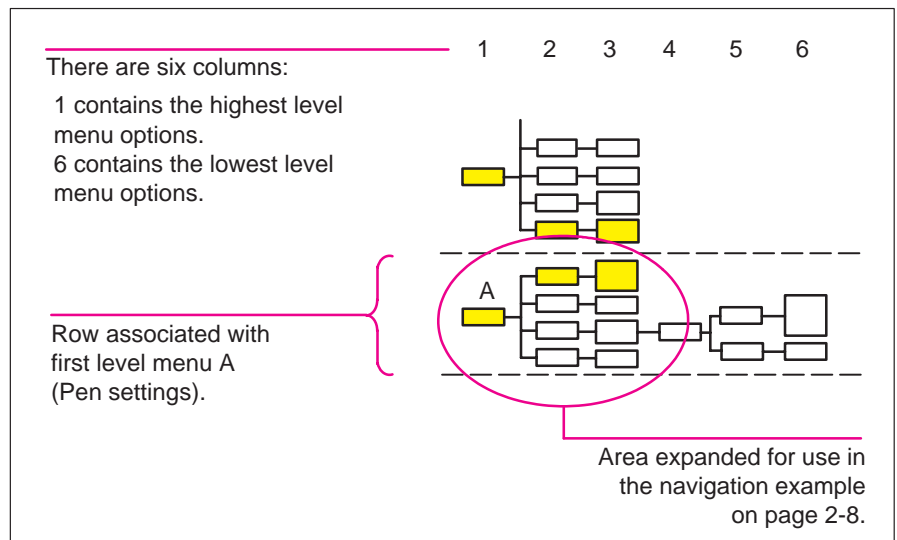

Entering the Menu System

With a STATUS screen displayed, for instance:

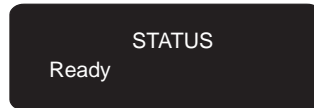

press the Enter key.

Either the SHORT MENU screen:



Only menu shaded yellow in Front Panel Menu plot accessible (Shaded gray if printing in black only).

or the FULL MENU screen:

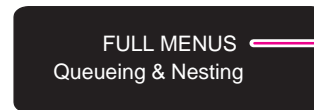

All menus accessible.

is displayed, with the Queueing & Nesting option shown.¹

Change to full menu mode, if necessary. See page 1-31.

You are now in the first level menu, shown in the first column of the Front Panel Menu plot.

¹ You may not be able to access the menu system *immediately*, if the current task overrides it. If this happens, wait until the task is completed and try again.

Navigating the Menu System

Once in the first-level menu, you navigate the system using the display keys.

Press **Previous** to display the previous menu level, without changing any menu selections (equivalent to moving left [\leftarrow]¹ one column in the Front-Panel Menu plot).

Previous



Press \uparrow to scroll up, or \downarrow to scroll down through the options in a menu (equivalent to moving up [\uparrow] or down [\downarrow] a column in the Front-Panel Menu plot).



The option list is continuous, allowing you to move from the bottom to the top by pressing \downarrow or from the top to the bottom by pressing \uparrow .

Enter



Press **Enter** to:

- a** select an option and move to the next menu level, when in the menu system (equivalent to moving one column to the right [\rightarrow] in the Front-Panel Menu plot).
- b** add to the configuration, your displayed choice from the options available in the lowest level menu [\checkmark].

¹ The colored arrows $\uparrow\downarrow\leftarrow\rightarrow\checkmark$, shown in square brackets above, are used to represent pressing the relevant keys once, in the following navigation example.

Navigating the Menu System

Use this example to practice navigating the menu system. It assumes that you have entered the menu system from the STATUS screen and wish to change the Merge setting in Pen settings. The colored arrows on the excerpt of the Front-Panel Menus plot below correspond to the numbered instructions.

- 1 Press the ↓ key five times to display the Pen settings option.
- 2 Press the **Enter** key to select the option and move to the Pen settings second-level menu. The Palette option is displayed.
- 3 Press the ↓ key once to display the Merge option.
- 4 Press the **Enter** key to select the option and move to the Merge third-level menu. The option currently selected is displayed with a *.
- 5 Change the displayed option by pressing the ↓ or the ↑ key.
- 6 Press the **Enter** key to set Merge equal to the new displayed value. You will be returned to the Merge second-level menu.
- 7 To exit the menu system, press the **Previous** key twice.

If you now re-enter the menu system and repeat steps 1 to 4, you will see the option that you selected displayed with a *.

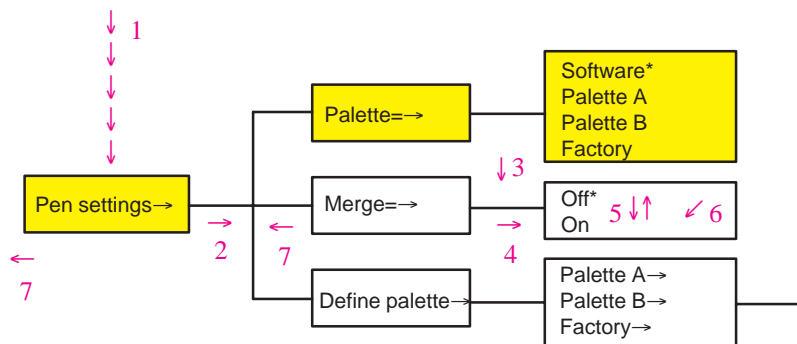

Note: A → character in a menu option box indicates that another level of menu is available.

Menu Graphics Used in this Manual

At the end of this chapter, there are some examples of navigating the menu system, showing all the menu displays available. In the rest of this manual, when you need to use the menu system, a simple menu graphic will appear in the left margin giving a concise explanation of how to navigate to the exact place.

The graphics look similar to this, but further levels may be shown:

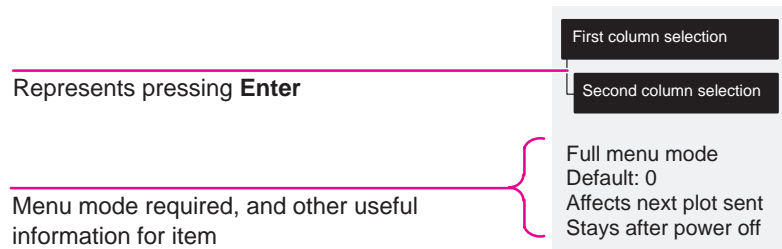

Other Types of Screens

Other screen, such as those displayed for selecting media type during media loading:

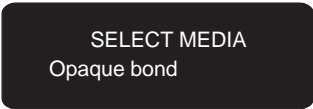

SELECT MEDIA
Opaque bond

or for changing the language:

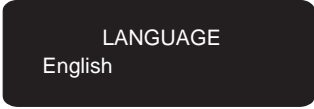

LANGUAGE
English

are in fact further examples of selection menus which are not part of the main menu system. These behave in the same way as other menus, in that you can scroll through the options using the ↓ and ↑ keys and select a displayed option using the **Enter** key.

Examples

Example 1: Changing Margins

In the section of this manual that describes how to adjust the page margins, the icon on the left is shown, indicating that you should go to the MARGINS menu as follows.

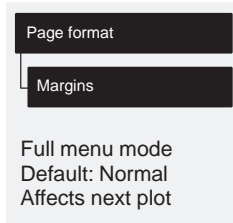

With the STATUS screen displayed:

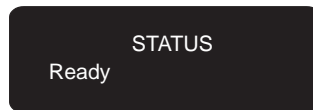

- 1 Enter the menu system by pressing the **Enter** key.

Either the SHORT MENU screen or the FULL MENU screen is displayed with the Queueing & Nesting option. If necessary, see page 1-31 and change to full menu mode.

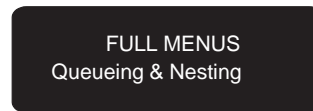

- 2 Press the **↑** key once, or the **↓** key 6 times, to display the required option.



- 3 Press the **Enter** key.



Continued...

Examples

4 Press the ↓ key twice, or the ↑ key twice, to display the required option.



5 Press the **Enter** key to display the MARGINS menu.

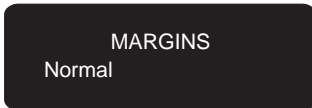

6 Use the ↑ and ↓ keys to display the available options and, when the one required is displayed, press the **Enter** key to select it as the value for Margins.

Example 2: Changing the Drying Time

The section on adjusting the drying time, to suit different environmental conditions, contains the icon shown on the left, indicating that you should go to the DRYING TIME menu. This example assumes that the display is in full menu mode following example 1, but can be used in short menu mode.

Device setup

Drying time

Both menu modes
Default: Normal

With the STATUS screen displayed

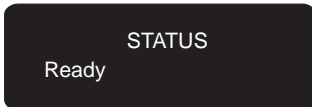

1 Enter the menu system by pressing the **Enter** key.

The FULL MENUS screen is displayed with the Queueing & Nesting option.

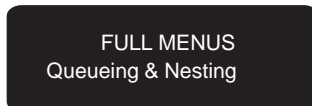

Continued...

- 2 Press the ↑ key 3 times, or the ↓ key 4 times, to display the required option.

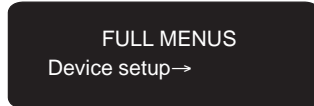

FULL MENU
Device setup→

- 3 Press the **Enter** key. (If the display is in short menu mode, you will notice that the screen shown after instruction 4 below is displayed at this point, so go to instruction 5.)

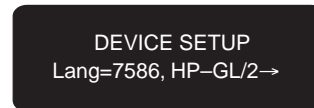

DEVICE SETUP
Lang=7586, HP-GL/2→

- 4 Press the ↑ key once, or the ↓ key 4 times, to display the required option.

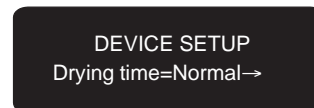

DEVICE SETUP
Drying time=Normal→

- 5 Press the **Enter** key to display the DRYING TIME menu.

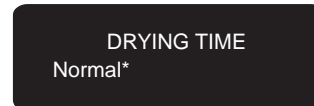

DRYING TIME
Normal*

- 6 Use the ↑ and ↓ keys to display the available options and, when the one required is displayed, press the **Enter** key to select it as the value for Drying time.

Choosing Media 3-2

Caring For Your Media 3-9

Loading Media 3-10

Unloading Media 3-22

Replacing Cartridge(s) 3-26

Working With Media and Cartridge(s)



Choosing Media

Your plotter supports many types of paper and other media types. Choosing the best media type for your requirements is the first (and most important) step in ensuring good print quality. It is recommended you only use genuine Hewlett-Packard media, whose reliability and performance have been developed and thoroughly tested to give trouble-free performance and optimal print quality.

For details of Hewlett-Packard media, see page 3-3 and the HP DesignJet Papers and Films catalog supplied with the plotter.

Five Important Points about Media Types

- When selecting different **opaque paper types**, be aware that you will use significantly less ink printing on coated types than on normal opaque bond.
- Most media types are supported, However the quality of some plots may not be as good if you do not use HP media. For media details, see the table on page 3-5.
- Whenever you load a roll or a sheet, the plotter's front-panel display prompts you to specify which **media type** you are loading. It is *absolutely essential* for good print quality to specify this correctly. The table on page 3-3 gives you all the information you need. If media is already loaded and you are unsure which media type was specified, go to Utilities / Statistics in the front panel, as explained on page 7-2.
- You should also be aware of which **print quality** setting (best, normal or fast) you are using. You can set this either from your software or from the plotter's front panel (the software driver setting will override any print quality setting made on the front panel). The combination of media type and print quality settings automatically tells the plotter how to place the ink on the media – for example, in terms of ink density and number of passes of the cartridge(s). For more details, see the tables on page(s) 3-6 and 3-7. There are print quality improvements which can be made using **Sharp lines** on the front panel menu or in the Windows, this is described on page 5-14.
- Included with this plotter is a **HP DesignJet Papers and Films catalog** which gives ordering details for Hewlett-Packard media supplies. To get the latest version of this document, contact your local HP Sales and Support office.

Supported Media Types

Media Type on the Front-Panel Display	Also Known As	Commercial Name of HP Media ¹
Opaque bond	Plotter paper	HP Opaque Bond
Translucent bond		HP Translucent Bond
Natural tracing paper	Natural tracing paper Tracing paper Extra translucent bond	HP Natural Tracing Paper
Vellum		HP Vellum
Coated paper	Special paper Special inkjet paper Color inkjet paper Matte paper Presentation	HP Coated Paper
		Note: HP Special Inkjet Paper is <i>not</i> supported on the HP DesignJet 700 plotter. 700
Heavy coated paper	Heavyweight coated paper Heavyweight special paper Heavyweight inkjet paper Heavyweight color inkjet paper Heavyweight matte paper	HP Coated Heavyweight Paper
		Note: HP Heavyweight Special Inkjet Paper is <i>not</i> supported on the HP DesignJet 700 plotter. 700
Matte film	Matte polyester Poly matte film Mylar	HP Matte Film
Clear film	Translucent film Clear polyester	HP Clear Film
High-gloss photo 750C Plus	High-gloss photo paper High-gloss paper	HP High-Gloss Photo Paper
Semi-gloss photo 750C Plus	Semi-gloss photo paper Semi-gloss paper	HP Semi-Gloss Photo Paper
High-gloss film 750C Plus	High-gloss white film	HP High-Gloss White Film
¹ From time to time, new media types may become available. For up-to-date information, please contact your HP dealer or local HP Sales and Support Office.		

Choosing Media**Physical Characteristics of Media Types**

Media Type on the Front-panel Display	Physical Characteristics		
	Opacity	Matte or Glossy	Special coated side for plotting?
Opaque bond	Opaque	Matte	No
Translucent bond	Semi-opaque	Matte	No
Natural tracing paper	Semi-opaque	Matte	No
Vellum	Semi-opaque	Matte	No
Coated paper	Opaque	Matte	Yes ¹
Heavy coated paper	Opaque	Matte	Yes
Matte film	Semi-opaque	Matte	Yes
Clear film	Clear	–	Yes
High-gloss photo	Opaque	Glossy	Yes
Semi-gloss photo	Opaque	Glossy	Yes
High-gloss film	Opaque	Glossy	Yes
¹ When loading coated paper into the plotter, ensure the coated side is facing downwards.			

750C Plus

750C Plus

Cost and Color Support of Media Types

Media Type on the Front-panel Display	Cost (Relative to Each Other)	Recommended for Color?
Opaque bond	Low	CAD drawings only ¹
Translucent bond	Low	No
Natural tracing paper	Moderate	CAD drawings only ¹ HP media only
Vellum	Moderate	
Coated paper	Low / moderate	Yes
Heavy coated paper	Moderate	Yes
Matte film	High	Yes
Clear film	High	Yes
High-gloss photo	High	Yes
Semi-gloss photo	High	Yes
High-gloss film	High	Yes

¹ The limitations using non-coated media for color depends on:

- the amount of filled area in your drawing (the more there is, the less likely that the print quality on opaque bond will be satisfactory),
- the quality of the media.

Choosing Media**Combinations of Media Type and Print Quality**

The table below shows that some combinations of media type and print quality are not recommended.

700**750C Plus****750C Plus****750C Plus****750C Plus**

Media Type on the Front Panel Display	Print Quality (Set Either on the Front Panel or In the Software)		
	Fast	Normal	Best
Opaque bond	OK	OK	OK
Translucent bond	OK	OK	OK
Translucent bond	OK in monochrome only	OK in monochrome only	OK in monochrome only
Natural tracing paper	OK	OK	OK
Vellum	OK	OK	OK
Coated paper	OK	OK	OK
Heavy coated paper	OK	OK	OK
Matte film	OK	OK	OK
Clear film	OK	OK	OK
High-gloss photo	Not recommended	OK	OK
Semi-gloss photo	Not recommended	OK	OK
High-gloss film	Not recommended	OK	OK

IMPORTANT

If you are using an add-on a third-party Raster Image Processor (RIP), in order to create additional print modes on your plotter, then the above table may not apply. In this case, consult your RIP vendor for advice on the best settings for your requirements. A clue as to whether you are using a RIP or not is the message on the plotter's front panel while it is printing. If the message "STATUS / Printing (special)" appears, then you *are* using a RIP. If the message "STATUS / Printing" appears, then you are probably not using a RIP.

Typical Media Type Choices by Application

Application	Use	Typical Choice of Media ²	Probable Choice of Print Quality ³
CAD¹ 700	Drafts	Opaque bond Translucent bond Natural tracing paper Vellum	Fast or Normal Fast or Normal Fast or Normal Fast or Normal
	Final versions	Opaque bond Matte film Clear film	Normal or Best Normal or Best Normal or Best
	Archives	Vellum Matte film Clear film	Best Best Best
	Diazo reproductions	Translucent bond Natural tracing paper Vellum Matte film	Normal or Best Normal or Best Normal or Best Normal or Best
¹ CAD = Computer-Aided Design		² Using the generic media types on the front-panel display ³ Set either on the front panel or in the software	

Choosing Media

Application	Use	Typical Choice of Media ²	Probable Choice of Print Quality ³
CAD¹ monochrome	Drafts	Opaque bond Translucent bond Natural tracing paper Vellum	Fast or Normal Fast or Normal Fast or Normal Fast or Normal
	Final versions	Opaque bond Matte film Clear film	Normal or Best Normal or Best Normal or Best
	Archives	Vellum Matte film Clear film	Best Best Best
	Diazo reproductions	Translucent bond Natural tracing paper Vellum Matte film	Normal or Best Normal or Best Normal or Best Normal or Best
750C Plus	Drafts	Opaque bond Natural tracing paper Vellum Coated paper	Fast or Normal Fast or Normal Fast or Normal Fast or Normal
	Final versions	Coated paper Heavy coated paper (for durability) Matte film Clear film	Normal or Best Normal or Best Normal or Best Fast or Normal
	Archives	Matte film Clear film	Best Normal
	Overlays	Clear film	Fast or Normal
CAD¹ and GIS¹ color	Matte	Opaque bond (for drafts) Coated paper Heavy coated paper (for durability)	Fast, Normal or Best Fast, Normal or Best Normal or Best
	Gloss	High-gloss photo Semi-gloss photo High-gloss film	Normal or Best Normal or Best Normal or Best
	Clear film	Clear film	Best
Imaging and graphics package(s) color	Matte	Opaque bond (for drafts) Coated paper Heavy coated paper (for durability)	Fast, Normal or Best Fast, Normal or Best Normal or Best
	Gloss	High-gloss photo Semi-gloss photo High-gloss film	Normal or Best Normal or Best Normal or Best
	Clear film	Clear film	Best
¹ CAD = Computer-Aided Design GIS = Geographical Information or Mapping Systems		² Using the generic media types on the front-panel display ³ Set either on the front panel or in the software	

Caring For Your Media

- Handle *film and glossy media* by the edge(s) or wear cotton gloves. Skin oils can interact with ink and cause your plot to smear.
- Make sure the media bin is installed between the plotter's legs. When the plotter finishes each plot on roll media, it automatically cuts the plot and drops it into the bin. Note that mixing plot sizes can cause shorter plots to curl and shuffle in the bin.
- Colors may eventually fade or change when exposed to office light or sunlight over a period of time. Therefore:
 - avoid exposing your plots longer than necessary to direct sunlight.
 - ideally, when not using your plots, store them away from any light, for example, in a drawer.

750C Plus



Loading Media

To Change a Roll

1 Make sure the plotter wheels are locked (the brake lever pressed down) to prevent the plotter from moving.

2 *If the old roll is not used up, then to remove the media from the media path:*

a Raise the media lever to release the media.

b Open the roll cover and turn the media stop to wind the media out of the plotter and onto the roll.

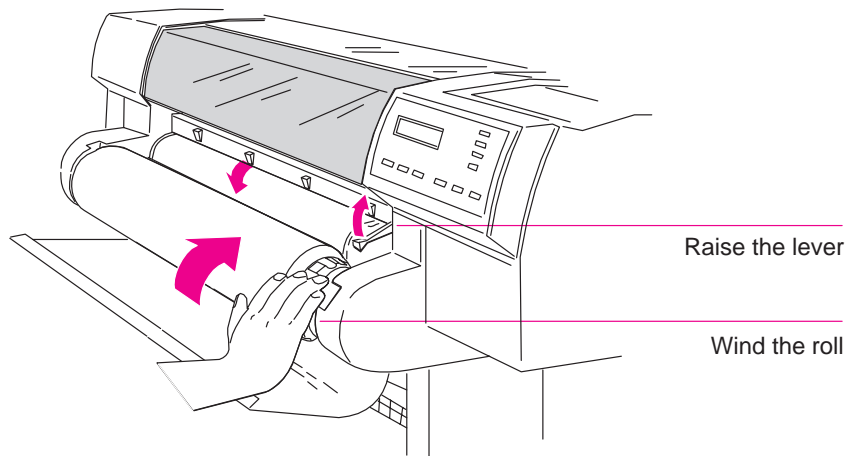

c Lower the media lever.

1840a

- 3 Remove the **old roll** of media by pulling firmly on each end of the spindle.

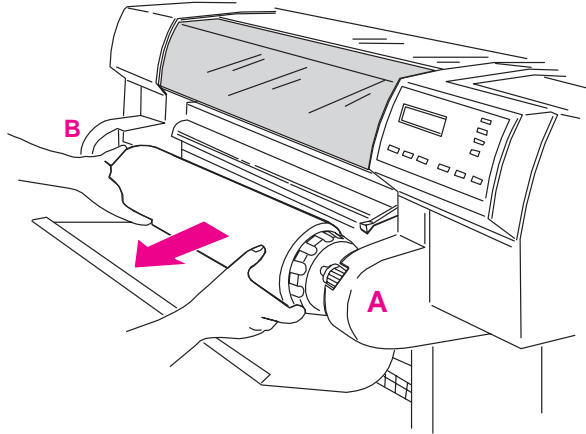

1837a

- 4
- a Rest the old roll upright on the floor so that the media stop (A) is on top.
 - b Pull out the media stop and the spindle and set it aside.

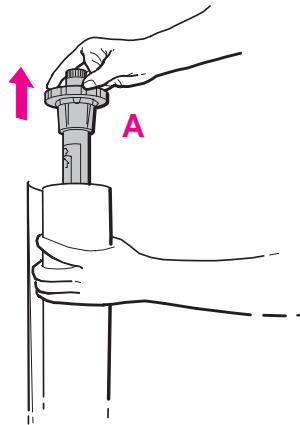

0021

Loading Media

- 5 From the other end of the old media roll, pull out the endcap (B).

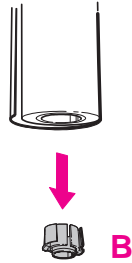

0022

- 6 *If you are not immediately loading another roll of media into the plotter, replace the endcap on the spindle and place the spindle back in the plotter. You can skip the rest of these steps.*

- 7
- a Remove the **new roll** from its wrapping.
 - b Turn the spindle upside down, that is, with the media stop at the bottom (and the end cap still removed)
 - c Place the new roll on the spindle, so that the leading edge winds *clockwise*.

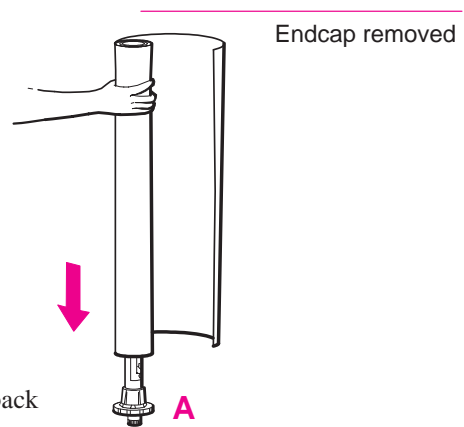

If the media stop falls off, push it back in until it snaps into position.

0015

- 8** Push the endcap back in, making sure that the tabs are flush against the ends of the roll. Push it far enough to be firm, but do not use excessive force as this may result in broken tabs.

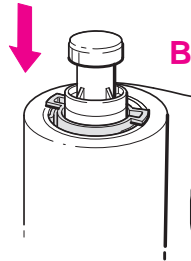

0016

- 9** Insert the spindle so that the media stop (A) is to the right and the endcap (B) to the left. Push in firmly on both ends. Make sure the media remains flush against the media stop.

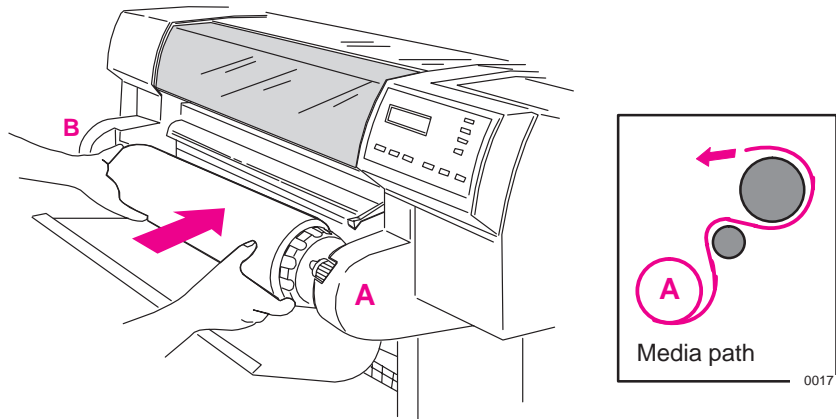

The media should wind up from behind the roll.

1837

- 10** Check the leading edge as it unwinds from the spool. If it is uneven, trim it as explained in step 11. Otherwise go to step 12.

Loading Media

WARNING

The media cutting knife used in the next step is sharp. Make sure the plotter's wheels are locked. Keep fingers clear of the cutting path. Keep media cutting knife away from children.

- 11** To trim the leading edge of the media roll:
- a** Pull the media over the top of the plotter and lay it over the cutting track.
 - b** Use the media cutting knife in the pocket located at the back of the plotter to cut off the first few inches of the media.
 - c** Retract the blade and return the media cutting knife to its pocket.

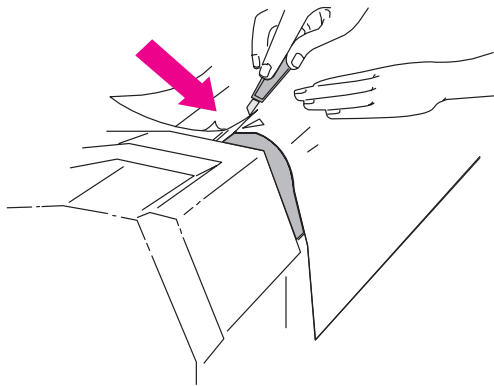

1838

- 12**
- a** Pull the media up and, holding it from the sides, align its right edge with the perforated line on the entry platen.
 - b** Insert the leading edge into the plotter, until the page buckles slightly.
 - c** Release the media when the plotter begins to pull it in.

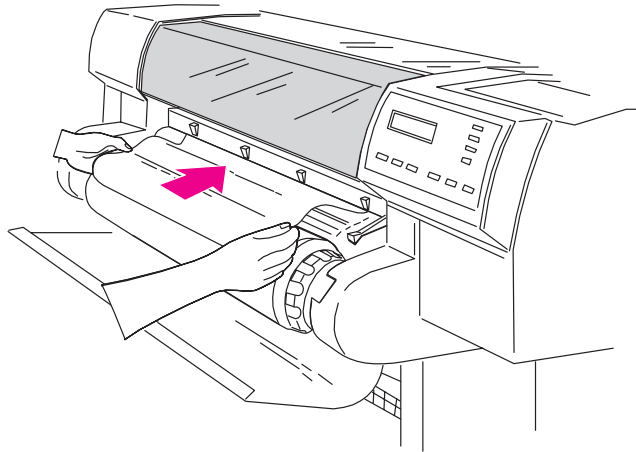

1839

- 13** Press the ↓ key next to the front-panel display to indicate you are loading roll media.

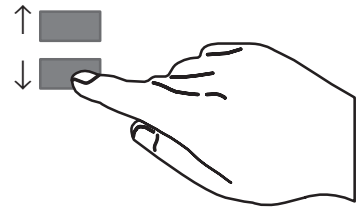
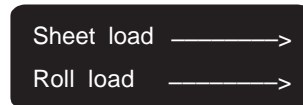

0014

Loading Media

- 14 Use the ↑ and ↓ keys until the display shows the type of media you are loading¹, and then press the **Enter** key.

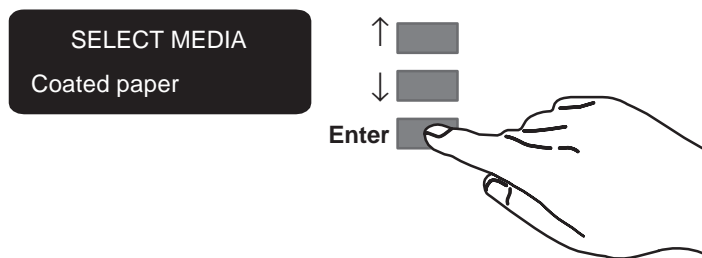

If you are using software that offers a “*special print mode*” for this plotter, then simply press **Enter** on the first media type displayed (whatever it is), as in this case it is the software that controls the print mode, not the plotter. For more details on special print modes, see page 3-6.

0014

- 15
- a When the front panel instructs you, lift the media lever.
 - b Take hold of the edge(s) of the media, now extending from the exit slot, and pull the media toward you until taut. Then align the left and right edge(s) of the media, so that they are flush with the edge(s) of the roll.

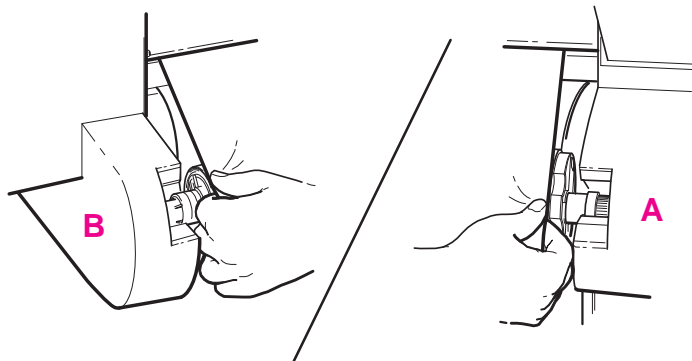

- c When the front panel instructs you, lower the media lever.

0018

¹ For advice on media types, see page 3-2.

- 16 a** When the plotter instructs you to close the roll cover, rewind the media stop in the direction shown by the large arrow below, to take up any slack in the roll. Make sure the leading edge of the media is outside the roll cover, and then close the cover.

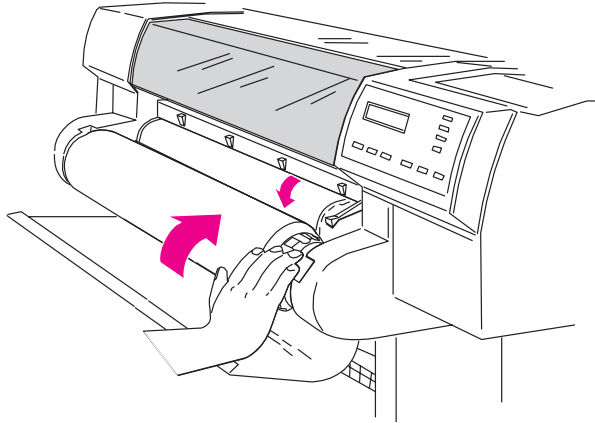

- b** Press ↓ to continue. The plotter trims off the first few inches of media.

1840

Loading Media**To Load a Sheet**

Which way round?

You can load a sheet in either portrait or landscape orientation. Unless using the Rotate option (see page 4-7), load the sheet in the same orientation as you have specified in your software.

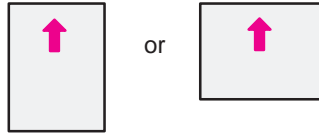

Which way up?

As you load the sheet, it is the *under side* on which the plotter will print. With most media types, the two sides are different and so it is important to load the sheet correctly. Refer to the table below.

Media Type	Media-Loading Tips
Opaque bond Translucent bond Natural tracing paper Vellum	Both sides are the same. If the sheet is curled, load with the curve (hollow) side towards you.
Coated paper Heavy coated paper	Load with the coated side down. On HP Coated Paper and Heavyweight Coated Paper, look for the small notch in the corner: <ul style="list-style-type: none"> • When loading in a portrait orientation, make sure the notch is on the right side of the leading edge. • When loading in a landscape orientation, make sure the notch is on the left side of the leading edge.
Matte film	Load with the matte side down.
Clear film	Load with the rougher side down.
High-gloss photo paper Semi-gloss photo paper High-gloss film	Load with the glossy side down.

750C Plus

- 1 If you need to, unload any roll media, see page 3-10.
- 2 Make sure the media lever is down and the roll cover is closed.

- 3
 - a Holding the media from the sides, align the right edge with the perforated line on the entry platen.
 - b Insert the media until it buckles slightly. That is, *push all the way to the media stops*. Let go of the media when the plotter begins to pull it in.

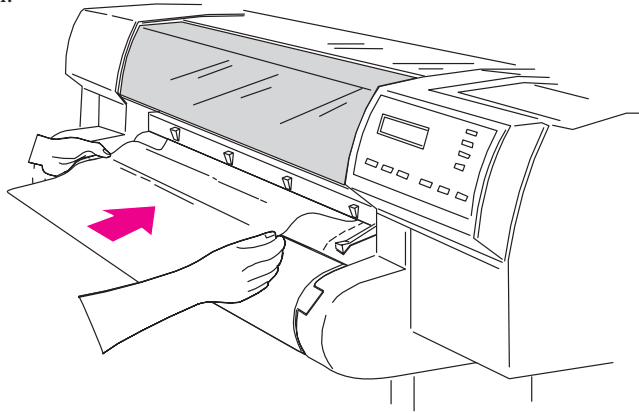

1841

- 4 Press ↑ next to the front-panel display to indicate you are loading a sheet.

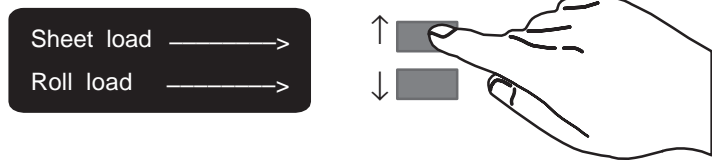

0014

Loading Media

- 5 Scroll until the display shows the type of media you are loading*, and then press the **Enter** key.

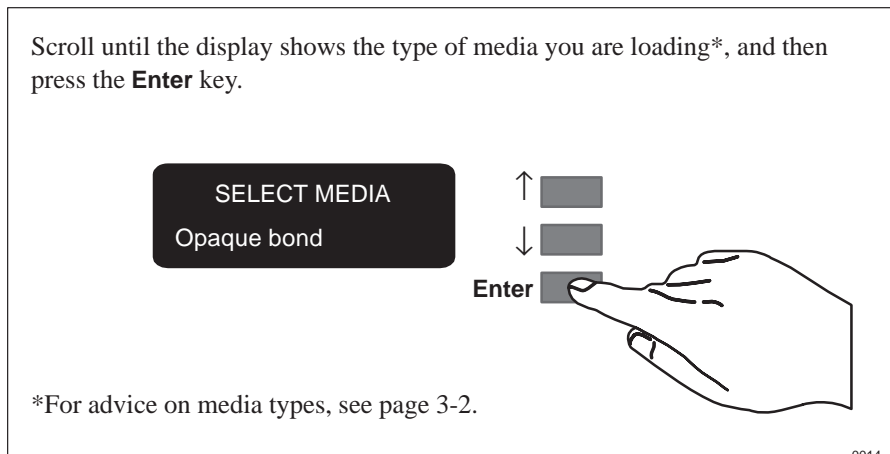

- 6 The plotter moves the sheet in and out to check its size and alignment, then advances it to the start of the page. When sheet loading is complete, the "STATUS / Ready" message is displayed.

Compensating for Badly Cut Media

You can only use this feature when sheet media is selected on the front panel.

If the media is persistently difficult to load, it could be an indication that it has been badly cut. That is, it has been cut unevenly with the media width on the leading edge different to the width of the trailing edge. A front-panel option called **Skew tolerance** helps you compensate for the shape of some poorly cut media. When you properly load the leading edge of badly cut media along the perforated line on the platen, you may notice the trailing edge is displaced from the line by a small distance and the plotter will not accept the media. The plotter can accept poorly cut media that is displaced 1.0 cm or less from the perforated line.

Media that is cut properly should not need the help of the skew tolerance feature. In fact, *using this feature for properly cut media increases the risk of skewing your plot on the page.*

To Adjust Skew Tolerance

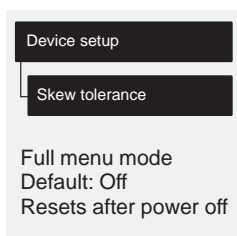

Skew Tolerance In Front Panel	Maximum Acceptable Skew of Loaded Sheet
Off	0.4 cm
On	1.0 cm

Unloading Media**Unloading Media****Drying Time**

On some media types the ink needs to dry before the plot is unloaded. For roll media the plotter automatically allows the appropriate drying time before cutting the plot and dropping it into the media bin. For sheet media you should wait for the times shown in the table below before unloading the plot.

Typical Drying Times (minutes)		
Media Type on the Front Panel Display	Print Quality	
	Fast	Normal or Best
Opaque bond	0.5	1.0
Translucent bond	0.5	1.0
Natural Tracing paper	0.5	1.0
Vellum	1.0	2.0
Coated paper	0	0.25
Coated heavy paper	0	0.25
Matte film	Not recommended	2.0
Clear film		2.0
High-gloss photo	Not recommended	4.0
Semi-gloss photo		4.0
High-gloss film		4.0

750C Plus

In the table above you will see that some media types can be unloaded immediately.

To Adjust Drying Time

You can make a global adjustment to the plotter's automatic drying times through the front-panel menus.

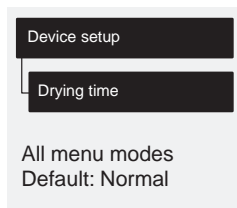

Drying Time Selected in Front Panel	Result
None*	The plotter cuts plot without delay.
Less	Adjusted for the driest expected environmental conditions.
Normal	As described in the table on page 3-22
More	Adjusted for the most humid expected environmental conditions.
* Not recommended if you are using roll media and leaving the plotter unattended, as the ink may smear when the plots are dropped into the media bin.	

If you are operating your plotter in an extremely dry environment, select Less in the front panel menu. In an extremely humid environment, select More. For environmental specifications, see page 11-4.

IMPORTANT

Adjusting drying times purely to speed up the plotter is not recommended as the quality of your plot can be impaired.

Unloading Media

To Unload a Sheet After Plotting

- 1 Wait until the appropriate drying time has passed (see table on previous page – *no* drying time is necessary for some media types).
- 2 Gently pull the sheet out from the plotter.

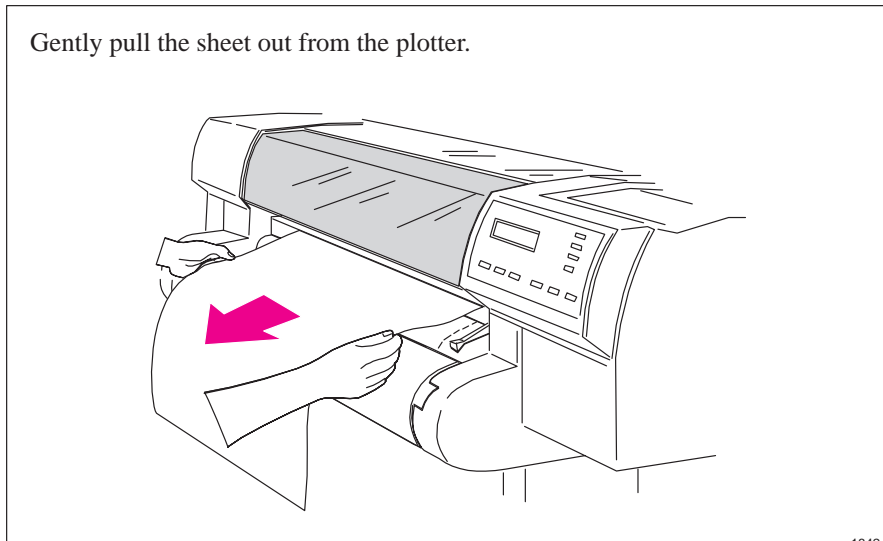

1842

To Remove an Unused Sheet

Either ...

- 1 Press **Form Feed and Cut**.
- 2 When the plotter has finished feeding it out, pull out the sheet.

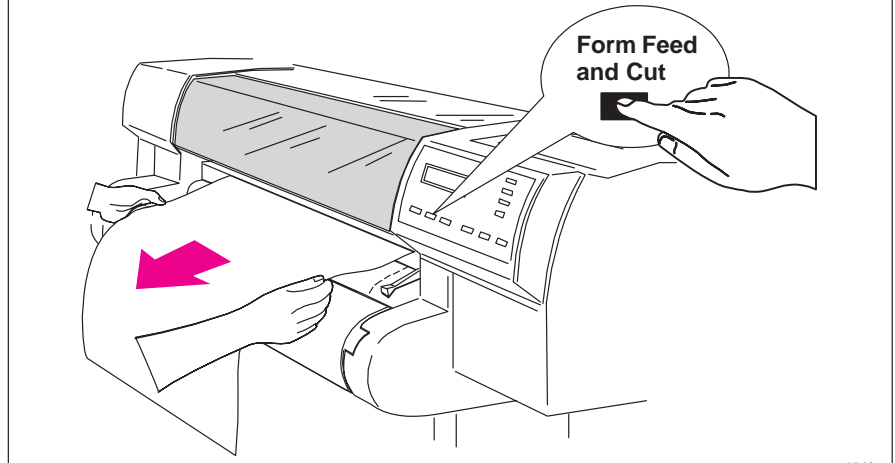

1842a

or ...

- 1 Lift the media lever.
- 2 Pull out the sheet.
- 3 Lower the media lever.

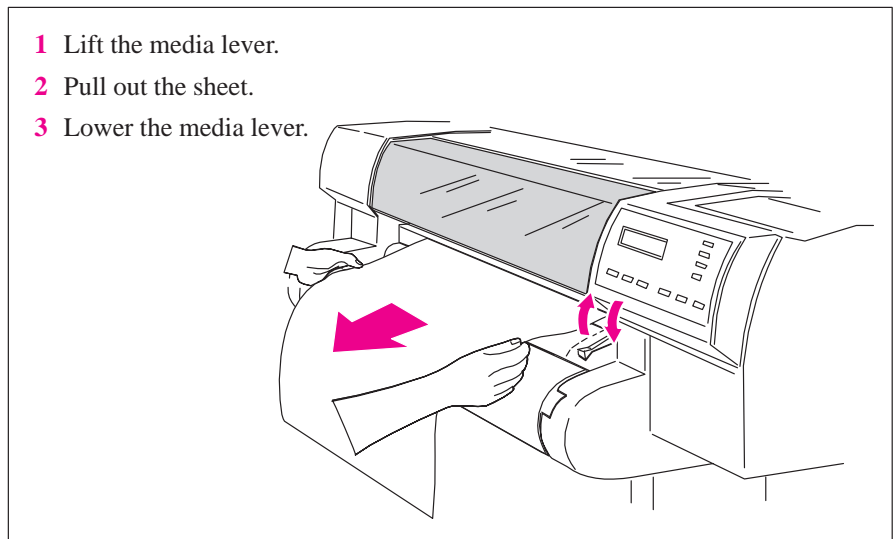

1842b

Replacing Cartridge(s)

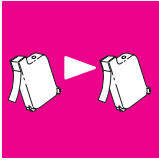

700

750C Plus

Replacing Cartridge(s)

When to Replace Cartridge(s)

Note that your HP DesignJet 700 contains only one black cartridge.

Note that your HP DesignJet 750C Plus has three color and one black cartridge(s).

Replace the cartridge(s) in the following three circumstances.

- 1 *When the plotter prompts you to replace one or more cartridge(s) (by displaying Service cartridge(s) on the front panel).*

The plotter automatically checks before and after every plot that the cartridge(s) are seated correctly and that the nozzles are working, this is called automatic checking. You can switch off the automatic checking using the front panel menus.

Note that automatic checking does *not* check the ink levels.

- 2 *When either poor print quality or the ink-level indicator on the cartridge indicates that the cartridge is out of ink.*

Device setup

Cartridge check

Full menu mode
Default: On

To check a cartridge's ink level:



Green = full



A considerable portion of ink has been used. Cartridge is close to empty.*



Black = empty

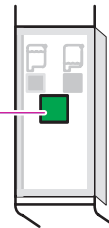

* It is recommended to have a replacement cartridge ready by this time.

Note: The ink-level indicator is *not* an exact gauge of the specific quantity of ink available over the life of the cartridge.

0002

- 3 *When you are troubleshooting print quality problems. See chapter 9, page 9-16.*

Before Replacing Cartridge(s)

Four important points:

700

- 1 Your plotter is designed to operate *only* with the black cartridge whose specific part number is listed on page 11-15.

750C Plus

Your plotter is designed to operate *only* with the four cartridge types whose specific part numbers are listed on page 11-15. Except on glossy media types, the plotter will operate successfully in monochrome with just the black cartridge loaded, although the Best print quality may not be as good as if all cartridges were loaded. Otherwise, all four *must* be loaded.

- 2 Every time you replace, or even adjust, a cartridge, the plotter afterwards runs an automatic alignment procedure, for which it needs an opaque media type, for example opaque bond (regular plotter paper) or coated paper. *So make sure that either a roll or a sheet of the appropriate media is loaded before you replace a cartridge.* If the automatic cartridge alignment procedure is not run on a suitable media type, print quality will be affected.
- 3 Once the cartridge(s) have been installed they should not be removed, except to replace them. This will ensure the best lifetime for your cartridge(s).
- 4 Make sure you are aware of the general warning and cautions below.

WARNING

Don't touch the stainless steel strip that runs the length of the plotter behind the cartridge carriage; its edge is very sharp. Keep hair, jewelry, clothing, and foreign objects away from the plotter mechanisms. Keep new and used print cartridge(s) out of the reach of children.

CAUTION

Only touch the plastic parts of the cartridge. Do not touch, wipe, or attempt to clean the cartridge nozzles or contacts as they can become clogged or scratched and are easily damaged.

CAUTION

Each time you access the cartridge(s) to load or reseal them, the nozzles are exposed to air. If the nozzles are exposed to air (except during plotting) for more than a few minutes at a time, they are susceptible to clogging and drying.

CAUTION

750C Plus

With the HP DesignJet 750C Plus plotter, it is absolutely essential to load the cartridge(s) in the correct stalls, or your colors will be wrong and print quality may be impacted.

Replacing Cartridge(s)

To Replace a Cartridge

If you are responding to a Service cartridge(s) request, go straight to step 4.

- 1 Start with the plotter switched ON.
- 2 Make sure the front-panel display reads STATUS / Ready (not STATUS / Ready for media).

- 3
 - a Press the **Access Cartridge(s) key** and wait for the cartridge carriage to come to a complete stop next to the front panel.

700

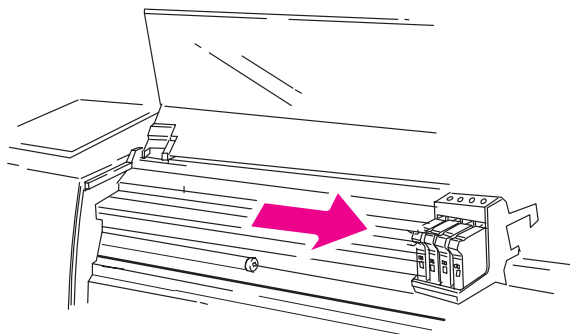
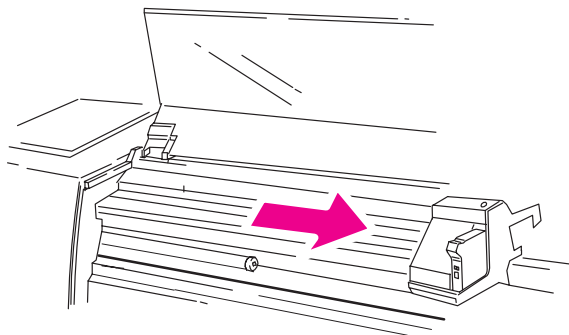

750C Plus

Continued...

1849a

- 4
- a When the carriage stops, open the window.
 - b Press down lightly on the cartridge you are replacing and pull it toward you. Remove the cartridge from its stall and discard it.

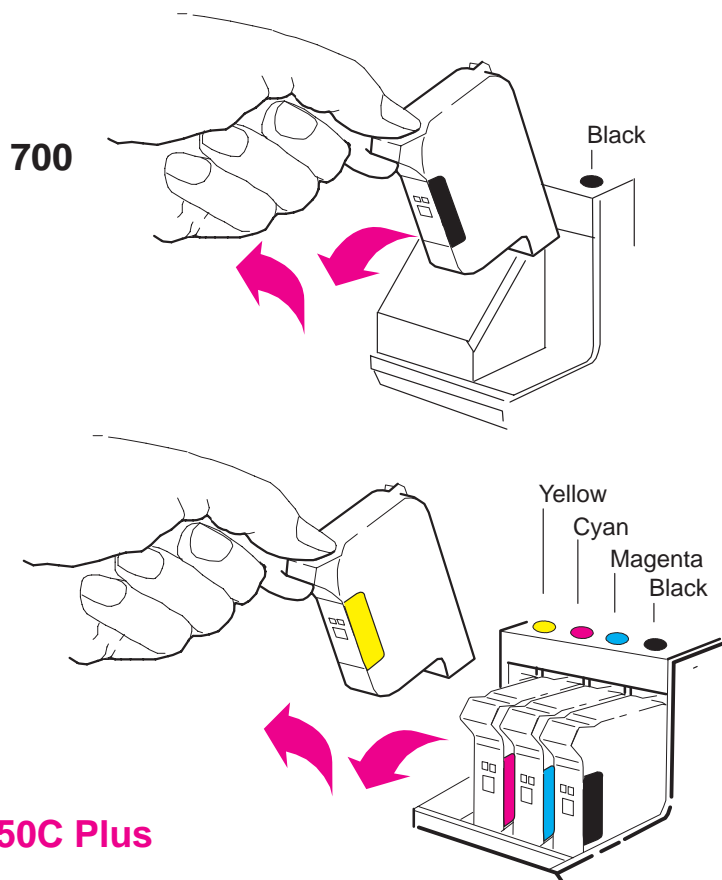

Notice that each stall in the carriage has a dot indicating the color: when loading the new cartridge you *must* put the correct cartridge in the correct stall.

For users with color-vision deficiencies: You can identify the colors of the cartridges by the part numbers on the boxes – see page 11-15. The sequence of the stalls is, from left to right, yellow, cyan, magenta and black.

Continued...

0019

Replacing Cartridge(s)

1754

5 For each cartridge in the set that needs to be replaced:

- a** Take the new cartridge out of its box.
- b** Remove the colored protective tape and tab from the cartridge's nozzles.

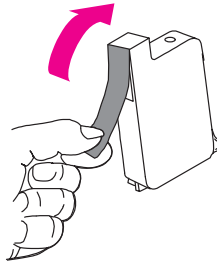
**750C Plus**

For the HP DesignJet 750C Plus, match the color of the cartridge's label with the color of the dot above the stall.

- c** Insert the cartridge in the correct stall. Press down lightly and push the cartridge away from you until it snaps into place.

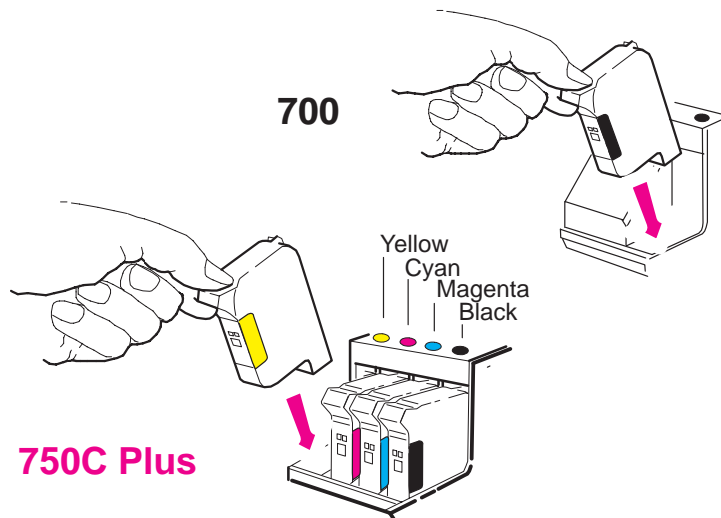

If the front-panel display says Reseat cartridge(s), then remove the cartridge indicated in the display and insert it again. Do so until the message disappears.

0019

6 When you have finished installing the cartridge(s), the plotter runs the automatic alignment procedure. When the front panel displays STATUS / Ready, the procedure is complete. You can throw away the small print produced during the alignment procedure.

Page Size 4-2

Adjusting the Margins (Roll Media Only) 4-6

Rotating a Plot 4-7

Plotting a Mirror Image 4-10

Controlling the Page Format

Page Size, Margins and Other Controls

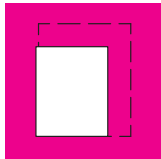

Terminology

Page Size

This chapter explains how to make sure that the plotter prints your plot in the page size you want.

Media

Page size

Margin

Plotting area

Inked area

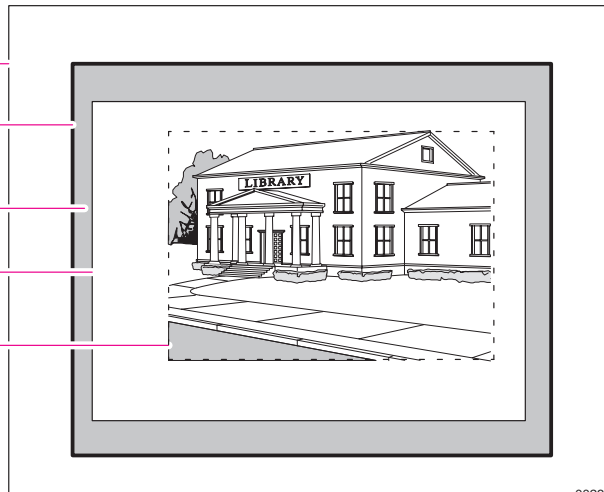

0023

Page size

This can be specified from the front panel or in the software, where it may be called “Page Size”, “Media Size”, “Paper Size” etc., and where the options include, for example, ISO A3, ANSI Letter, Architectural E and Custom. If the drivers setting is “default”, the front panel setting is used. Any other software setting overrides the front panel setting, unless the latter is Inked area and you are sending a PostScript file: in this case the front panel setting takes precedence.

When using the AutoCAD driver the “User Size” is the plotting area.

Margins

These are specific to the plotter and are normally 17 mm on the leading and trailing edges and 5 mm on the sides. The 17 mm can be adjusted for roll media, as explained on page 11-3.

Plotting area

This is the page size minus the margins. For a table showing the plotting areas for standard media sizes, see page 11-6.

Inked area

This is the smallest rectangle that contains the entire drawing, while maintaining its relative dimensions.

To save wasting media you can plot a page size equal to the inked area plus the margins. This setting may be available in your driver, it can also be selected by changing the front panel menu to “Inked area”.

Do You Need to Adjust the Page Size in the Front Panel?

Depending on the driver you are using, you may not need to change the page size in the front panel. The default setting of the plotter looks to your software for the page size settings: if it is there, the plotter uses it.

However, some of the circumstances in which you may want to change the default setting are:

- If you want to print the inked area only, but the driver you are using does not specify “Inked area”.

In this case, set Page format / Size to Inked area.

Note: If you can select Inked area from your driver, any selection you have made in the front panel menu will be overridden by the settings in the driver.

- When the plots you are creating need to be of a specific standard (for example, ISO or ANSI), but the actual size within that standard is not important. For example, your page size may need to conform to a standard ISO page size, but it does not matter whether the final page size is ISO A4 or ISO A3.

In this case, set Page format / Size to ISO > Best... or ANSI > Best ... etc. The plotter uses the smallest standard size into which the inked area will fit.

To Adjust the Page Size from the Front Panel

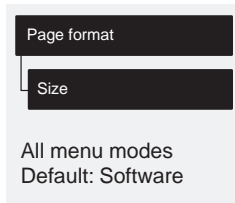

Size In Front Panel		Comments
Software		The plotter looks to the plot you have sent for a page size instruction. If it is present the plotter uses this. If not, the plotted page size is the inked area plus margins.
Inked area		The plotted page size is the inked area plus margins. For a definition of “inked area”, see page 4-2.
ISO	Best ISO A	“Best ...” options The plotter chooses the smallest page size (from the A-series: A4, A3 etc.) that will hold the inked area of the plot. For example, if the inked area of the plot is between A3 and A4, the plotter chooses A3 as the page size. Discrete options ISO A0/1/2/3/4 ANSI E/D/C/B/A JIS B1/2/3/4 ARCH E1/E/D/C/B/A Over A1/2
	ISO A0/1/2/3/4	
ANSI	Best ANSI	
	ANSI E/D/C/B/A	
JIS	Best JIS B	
	JIS B1/2/3/4	
ARCH	Best ARCH	
	ARCH E1/E/D/C/B/A	
Oversize	(No “Best” option)	The plotted page size is exactly the size you specify. The largest discrete page size you can specify depends whether your plotter is an E-size or D-size model.
	Over A1/2	

If you need to adjust the page size from the front panel, do so *before sending the plot file from your computer*, as the plotter determines the size of a plot at the time it is received from your application.

Page Size and Clipped Plots

If you specify in your software a page size that is larger than the media size loaded in the plotter, the plotter will still print what it can, but may clip your plot.

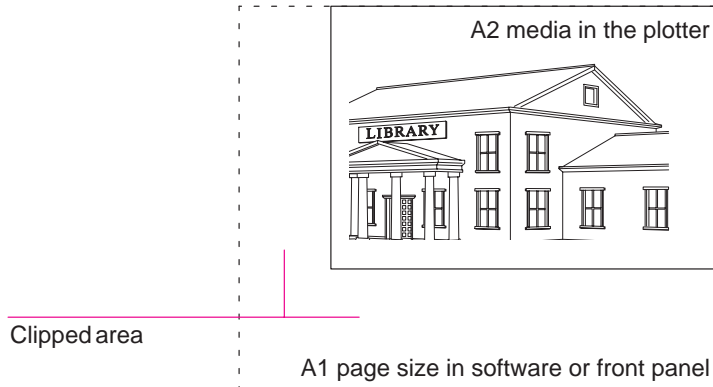

Page Size and Nesting (Roll Media Only)

Nesting means placing two or more plots side-by-side on a roll to save media. There are certain cases when your plots will not be nested, for a complete explanation of nesting see page 6-10.

If you have queuing and nesting switched on, the plotter will use the page size to determine which plots are nested and whether the plots can be automatically rotated when nesting.

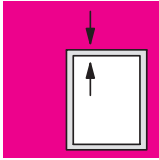

Adjusting the Margins (Roll Media Only)

Besides nesting and setting the page size, you can also change the margin settings and expand the plotting area of the page, therefore reducing the amount of media waste. The two side margins are 5.0 mm. The automatic setting of the plotter's margins is 17 mm on the leading and trailing edges of the media. By reducing the margins to 10 mm on the leading and trailing edges of the media, you can use 14 mm more plotting area along that axis. The adjustment is available in the front panel.

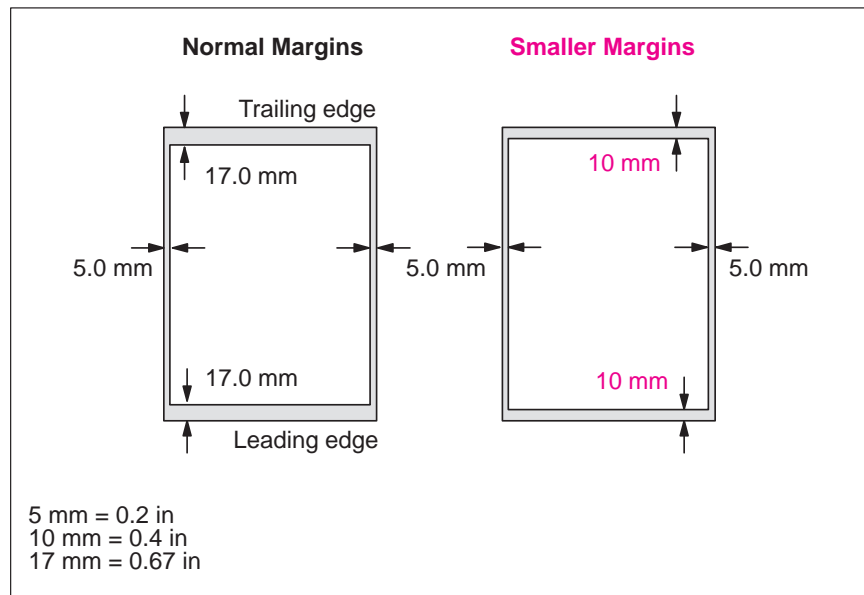
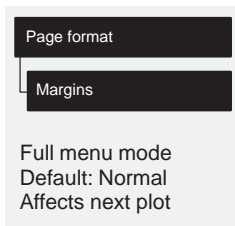

Margins and Automatic Cutting

IMPORTANT

When **Margins** is set to **Smaller**, the plotter waits for the plot to dry and the next plot to begin plotting before cutting the plot from the roll. If you press **Form Feed and Cut**, the plotter immediately cuts off the current plot. When the next plot begins, the plotter cuts again to give this plot the narrow margin.

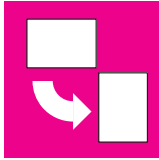

Rotating a Plot

Rotating a Drawing from the Front Panel

Your Drawing can only be rotated from the Page format / Rotate option in the front panel if:

- Queueing and Nesting are off (see page 6-10), and
- the file contains no raster data.

If you are using the Microsoft Windows driver supplied with this plotter, your files *do* contain raster data and therefore you *cannot* use this Rotate option. The normal line drawings of most CAD software do *not* contain raster data, and can use this Rotate option.

To Rotate a Plot from the Front Panel

Except in the circumstances stated above, you can rotate a plot from the plotter's front panel, without changing the drawing in your software. The options are 90, 180 or 270 degrees relative to the drawing's orientation in your software. The rotation is *counterclockwise*, as shown below.

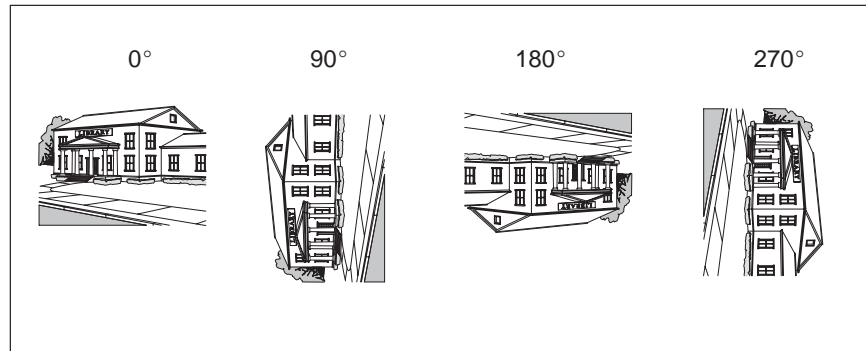
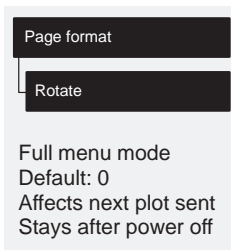

Rotating a plot

Exactly What Is Rotated?

With **roll media**, both the drawing and the page orientation are rotated.

0° 90° 180° 270°

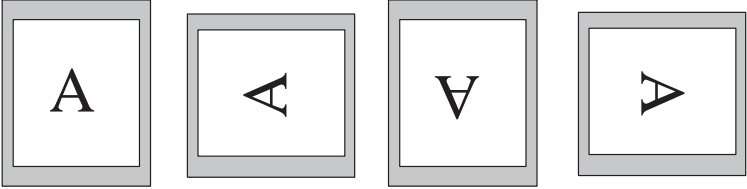

Notice that the narrow margins are always at the side, regardless of the orientation.

0025

With **sheet media**, the drawing is rotated, but the page orientation specified in your software is retained. (You should always load sheet media in the same orientation as you have specified in the software.)

0° 90° 180° 270°

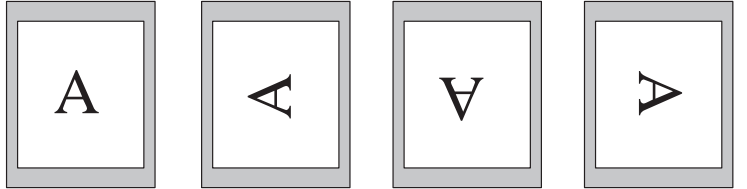

0026

The Rotate Feature and Clipped Plots

With either roll or sheet media, if you rotate to landscape a plot whose original orientation was portrait, it is possible that the media is not wide enough for the drawing, and so it may be clipped. For example, rotating by 90° a portrait D/A1-size plot on D/A1-size media will probably result in a clipped plot.

How Does Rotate Interact with Your Software?

The plotter *adds* the rotation setting to any rotation angle you specify in your software. For example:

- For software applications which, like the plotter, rotate *counter-clockwise* (for example, CorelDRAW!) the result is the *sum*. For example, if your software has specified a rotation of 180 degrees, and you set **Rotate** in the front panel to 90, your plot's final rotation will be 270 degrees.
- For software applications which rotate *clockwise* (for example, AutoCAD) the result is the *difference*. For example, if your software has specified a rotation of 90 degrees, and you set **Rotate** in the front panel to 90, there will be no rotation.

For further information on the Rotate feature see page 9-21 in the Troubleshooting chapter which details some of the most common problems.

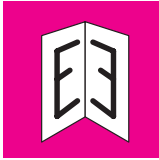

Plotting a Mirror Image

You can plot a mirror image of the plot from the plotter's front panel, without changing the drawing in your software.

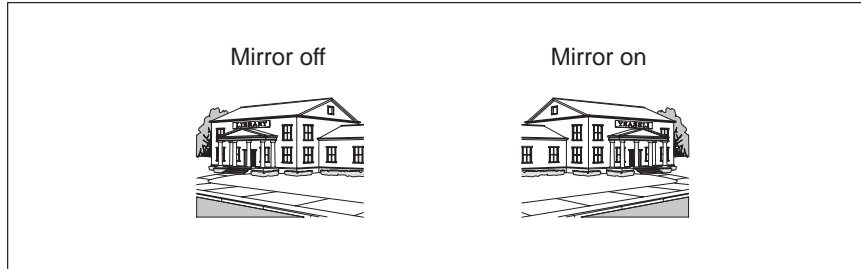
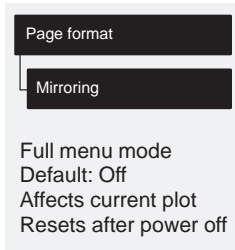

Do not change the setting during a plot, as the change becomes effective immediately; if you change the setting in the middle of the current plot, the remaining data is plotted in the mirrored orientation.

Ways to Control the Plot's Appearance 5-2

Changing Pen Widths and Colors Using the Plotter's Internal
Palettes 5-3

Changing the Treatment of Overlapping Lines
(Merge Features) 5-7

Changing the Overall Lightness/Darkness of a Plot 5-8

Printing Color Drawings in Monochrome 5-9

Choosing an Appropriate Print Quality 5-11

Controlling a Plot's Overall Appearance

Ways to Control the Plots' Appearance

Note. The “pens” discussed throughout this chapter are the “conceptual” pens in a software palette, rather than the plotter’s physical print cartridges.

This chapter discusses the ways you can control the overall appearance of your plots from the front panel in terms of:

- pen width

700

- pen shade

750C Plus

- pen color

- the treatment of overlapping lines
- overall lightness/darkness

750C Plus

- rendering color drawings in monochrome
- overall print quality and resolution.

Some of these front-panel items take effect only on the next file you send from your computer, that is, they do not affect any pages already in the plotter’s queue. If this is the case, it is stated in the relevant part of this chapter.

Some of the controls are available using the front-panel menus (pen width, overlapping lines and lightness). Print quality is controlled from the front-panel keys. This chapter explains them in the sequence of the list at the top of this page.

750C Plus

For the HP DesignJet 750C Plus the pen color can be controlled using the front-panel menus. Color/monochrome plot option is available using the front-panel keys.

Why Change the Appearance of the Plot Using the Front Panel Rather Than from Your Software?

By default, the plotter looks to your software to provide information on all the above attributes. However, you may want to experiment with various effects, or try a temporary change, without the need to change your drawing or your driver settings.



Changing Pen Widths and Colors Using the Plotter's Internal Palettes

The plotter has three pen palettes. The factory palette cannot be changed. You can, however, change the line width and color settings for each pen in the remaining two palettes (called *palette A* and *palette B*). Initially, all three palettes are identical. Each palette has 16 pens¹ which can include pens of different widths and for the:

700

- HP DesignJet 700 any of the plotter's 11 pen shades.

750C Plus

- HP DesignJet 750C Plus, any combination of the plotter's internal 256 colors

To See the Current Palette Settings

1 Make sure either a roll or a sheet of media is loaded.

750C Plus

2 Make sure that the front panel Color/Mono switch is set to **Color**.

3 Print the **Current Configuration Plot**, by pressing the ↑ and ↓ keys simultaneously..

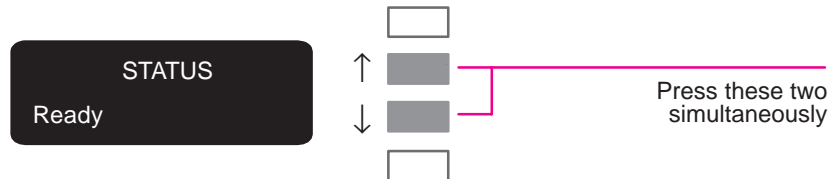

0014

Notice on the Current Configuration Plot that the 16 pens are numbered 0 through 15.

750C Plus

The 256 colors are numbered 0 through 255. These colors are specified in the Palette Plot, as explained on page 5-4.

¹ We are discussing “conceptual” pens here.

750C Plus

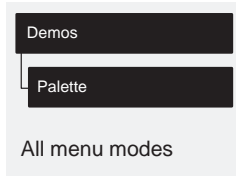

To See the Colors Available for a Palette

- 1 Make sure that the front-panel Color/Mono switch is set to **Color**.
- 2 To print the Palette Demo, go to the Demos menu and choose Palette.

In the **Palette Demo**, you will see 256 squares, numbered 0 through 255, each showing one of the 256 colors available for selection in the plotter's internal palettes. The example below is color 6 (magenta), which happens to be assigned to pen 6 in the factory's default palette.

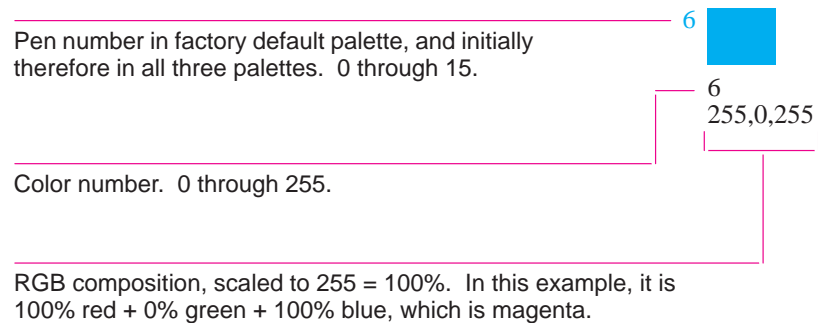

Notice that RGB and CMYK, – plus white – are assigned by default to pens 0 through 7, and that eight grayscales are included in the 256 colors.

The 256 colors shown in the Palette Demo are not the only colors you can print with your plotter! Using your software, you can create many more colors and, as long as you are using the correct driver, the plotter will reproduce these colors by an appropriate mix of inks from its CMYK cartridges. The Palette Demo merely shows the 256 colors available for use in the plotter's internal palettes, should you choose to use them.

To Change the Palette Settings

Pen settings

Define palette

Full menu mode
Defaults:
Palette: Factory
Width: 0.35 mm
Color: (see
Palette Plot)

700

750C Plus

There are three palettes: Factory, Palette A and Palette B. You cannot change the Factory palette, but you can define Palettes A and B to be whatever you choose.

Item	Available Options
Palettes	Factory, A, B.
Pens	0 through 15.
Widths (mm)	0.13, 0.18, 0.25, 0.35, 0.50, 0.65, 0.70, 0.80, 0.90, 1.00, 1.40, 2.00, 3.00, 5.00, 8.00, 12.00. Note that 0.13 mm is a one-pixel line width and renders some colors as a dot pattern.
Shades	0%, 10%, 20%, 30%, 40%, 50%, 60%, 70%, 80%, 90%, 100%
Colors	0 through 255. As specified on the Palette Plot.

The steps below explain how to define Palette A.

- 1 In the front-panel display, go to the Define Palette routine and choose Palette A.
- 2 Scroll to the pen number you want to change and press **Enter**.
- 3 The current width assigned to this pen is displayed, for example Width=0.35mm. If you want to change it, press **Enter**, scroll to the width you want and then press **Enter** again.

If you wish to change the color for the pen scroll to Color.

750C Plus

- 4 The current color assigned to the pen is displayed, for example Color=110. If you want to change it, press **Enter**, scroll to the color you want and then press **Enter** again.
- 5 When both width and color are correct, press **Previous**.
- 6 Scroll to the next pen number you want to change, press **Enter** and do steps 3 through 5 again.
- 7 When all pen definitions are correct, press **Previous** until you have exited the menus.

IMPORTANT. The palette you have just defined will take effect only when you select it to be the current palette, as explained next.

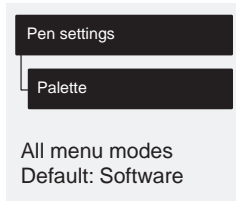
To Change the Selection of the Current Palette

Palette	Comments
Software	The plotter looks to your software for pen settings and ignores all three internal palettes.
Palette A	The plotter assigns the attributes defined in Palette A to the pens defined in your software as 0 through 15.
Palette B	The plotter assigns the attributes defined in Palette B to the pens defined in your software as 0 through 15.
Factory	The plotter assigns the attributes defined in the Factory Palette to the pens defined in your software as 0 through 15.

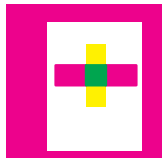

Changing the Treatment of Overlapping Lines (Merge Feature)

There are two alternative settings for controlling overlapping lines. The feature is called **Merge**.

You can set this feature from your software in some applications, for example in AutoCAD.

Pen settings

Merge

Full menu mode
Default: Off

700

Merge off.

A subsequent line hides a previous line where they overlap.



Merge on.

Overlapping lines and area fills are merged.



750C Plus

Merge off.

A subsequent line hides a previous line where they overlap.

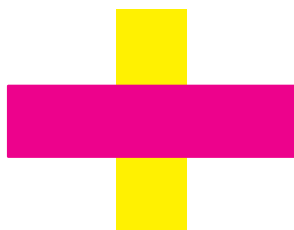

Merge on.

Overlapping lines and area fills are merged.

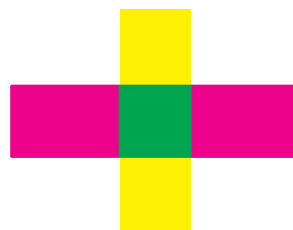

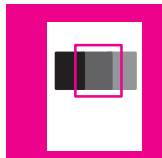

Changing the Overall Lightness/Darkness of a Plot

You can change the overall lightness/darkness of a plot by adjusting the amount of ink used in your plots.

The feature is called **Lightness** and affects both grayscales and colors.

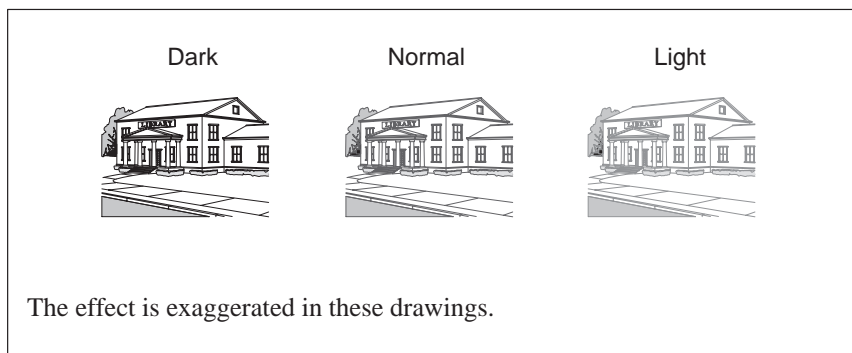
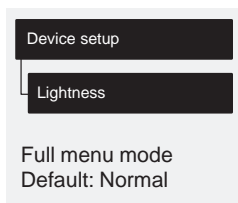

As this is a simple way to change the appearance of your plot, you can achieve better results if you use your software for different effects. However, some examples of situations where you may find the feature useful are:

- Where a tracing paper produces better print quality when the plotter uses a smaller volume of ink.
- Where a small variation in the amount of ink used produces a significant change in the apparent darkness or color saturation of an image.
- Where you want to reduce the drying time required: for example, for glossy media in extremely humid conditions. (If you need to make a global change to drying times for extreme environmental conditions, refer to page 3-23.)

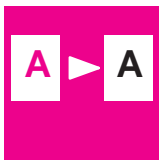

750C Plus

Printing Color Drawings in Monochrome

Examples of why you may want to print a color drawing in monochrome are:

- Because you want a draft where color is not important, for example to check that the plot is not going to be clipped.
- Because you want a version for photocopying in black and white.

Three important points:

- The monochrome plot will render colors as *grayscale*s rather than all as black. If you want all colors to be printed as *black*, then you should set all your colors to black in your software. This is most easily achieved in CAD software by using a pen number that is 100% black. Alternatively, you could make one of the plotter's internal palettes (A or B) all black, and then select this as the current palette (see earlier in this chapter for an explanation of palettes).
- With monochrome plotting, you have the option to choose between true 300 and true 600 dpi resolution (see page 5-11). This option does not apply to glossy media types, on which the resolution is always true 300 dpi.
- You cannot change the color/monochrome setting for plots already in the plotter's queue.

Affects next plot sent

750C Plus

To Switch between Color and Monochrome

- 1 Use the front-panel key shown below to toggle between color and monochrome.

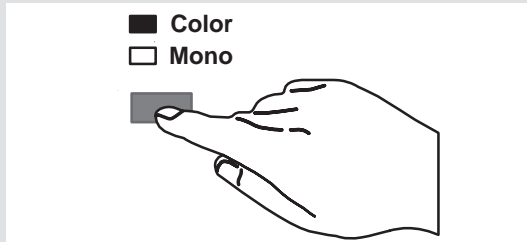

If you are using one of the software drivers supplied with the plotter, you can also make this setting (or an equivalent) within the driver. In this case, the driver setting will override the front-panel setting. The front-panel setting will, however, remain available as the default value, and the front-panel light displayed will not change.

If you use the supplied AutoCAD driver, you can force a color plot to monochrome by additionally setting the current palette to something other than Software (see page 5-6).

0027

- 2 Send the plot from your computer.

The setting also impacts the plotter's internal sample plots.

Affects next plot sent



Choosing an Appropriate Print Quality

You can set the overall print quality from the front panel. The main effects of your print quality setting are shown in the table below.

Print Quality Setting	Fast	Normal	Best
Speed			
Ink Used			

General tips

By choosing Fast, you will get draft-quality output in the shortest time. By choosing Normal, and a suitable media type, you will get high-quality output in a reasonable time. By choosing Best, you will get the highest possible quality for the media type, but the printing time will be longer.

However, your plotter's output speed, quality and particularly its resolution, also varies according to:

750C Plus

- Whether Sharp lines is set to Auto, On or Off (see page 5-14) on the front panel or in your software.
- The specification option when you loaded the media (see page 3-3).

Choosing an Appropriate Print Quality

The resolution at which your plot will be printed is summarized in the table below.

Print Quality Setting	Resolution in dpi		
	DesignJet 750C Plus		DesignJet 700
	Monochrome	Color	Monochrome
Fast	300 x 300	300 x 300	300 x 300
Normal	600 x 600 ¹	300 x 300	600 x 600 ¹
Best	600 x 600 ¹	600 x 600 ²	600 x 600 ¹

¹ Or 300 x 300, depending on your driver resolution setting or the software application you have used.

² Addressable dpi with Sharp lines set to Auto or On, using opaque bond, coated paper and matte film only. This resolution depends on the type of image created in your software application.

Recommended combinations of print quality and media type are given in the table on page 3-6.

To get the very best print quality for images and drawings from graphics packages (other than CAD drawings or other line drawings):

- When loading the paper, specify “Heavy coated paper” on the front panel, rather than “Coated paper”.
- Set Print Quality to “Best”.

Affects next plot sent.
Software setting
takes priority.

To Change the Print Quality

- 1 Use the front-panel **Print Quality** key to toggle between the three print quality settings.

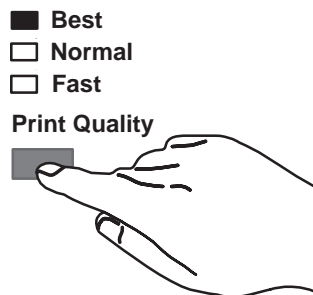

If you are using one of the software drivers supplied with the plotter, you can also make this setting (or an equivalent) within the driver. In this case, the driver setting will override the front-panel setting. The front-panel setting will, however, remain available as the default value, and the front-panel light displayed will not change.

0027

- 2 Send the plot from your computer.

The setting also impacts the plotter's internal sample plots.

You cannot change the print quality setting for plots already in the plotter's queue.

Device setup

Sharp lines

Full menu mode
Default: Auto**750C Plus****Improving Line Quality and Graphics Detail**

The Sharp lines option refines the print quality of line drawings by *smoothing* the fine gradations along the angles and curves of the printed image. This enhancement produces:

- Crisper lines.
- Finer detail.
- Line drawings with a 'sharp' appearance.

Only plots that have color content are affected by the Sharp lines option to produce addressable 600 dpi resolution. Monochrome images are not affected by the Sharp lines option as these are produced in true 300 or 600 dpi resolution, depending on the print quality that you have selected.

The Sharp lines option has three settings, Auto, Off and On, and can be set either through the front-panel menu or HP supported Windows drivers. The factory default setting is Auto.

With Sharp lines set to Auto you will always get best quality color plots, except when you send the following files:

- Mixed lines and scanned color images.
- Mixed lines and color photographs.
- CorelDRAW! (with color images).

For these files it is recommended that the Sharp lines default setting is changed, depending on your preference for image or line quality:

- Select On if you have a file which contains line and color images and you want the lines to be plotted in Best quality, even if there is possible degradation to the quality of the color image.
- Select Off if you have a file which contains line and color images and you want to optimize the quality of the color images.
- Select Off if the plot is a complex vector file, such as a CorelDRAW! The plot quality will be optimized for these circumstances.
- Select Off if the output speed of the plotter is more important than Best quality.

750C Plus

Important

For further information on Sharp lines see Troubleshooting, page 9-15.

With the Sharp lines set to Auto or On in the front-panel menu, the plotter may not always produce an addressable 600 dpi plot. This may be because:

- You have not selected Best on the front-panel **Print Quality** key, refer to page 5-13.
 - You are using media other than Coated paper, Opaque bond or Matte film.
 - Your application-software driver is overriding the front-panel selection.
 - You are plotting a color raster image or a line drawing combined with a color raster image.
-

Managing Plots Being Printed or Drying 6-2
Managing Plots Not Yet Printed (The Queue) 6-4
To Replot an Image Using the Plotter's Memory 6-9
Avoiding Media Waste by Nesting Pages (Roll Media Only) . 6-10

Managing Your Plots

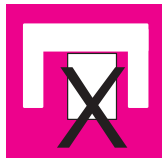

Managing Plots Currently Being Printed or Drying

To Cancel a Plot

Press **Cancel** on the front panel.

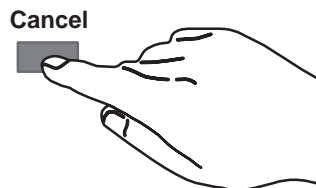

The plotter advances the media as though the plot were finished.

0027

If queuing is on and there are no more plots in the queue, the cancelled plot is placed in the queue and you can replot it as explained on page 6-8. If, in addition to cancelling the plot, you want to delete it from the queue, see page 6-7.

To Cut a Plot Before Drying Is Complete (Roll Media Only)

Press **Form Feed and Cut** on the front panel.

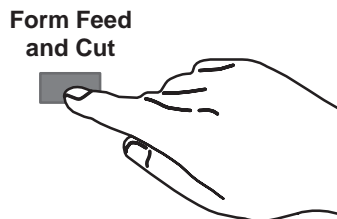

The plotter ignores the drying time and immediately drops the page into the media bin.

0027

To Pause while Printing a Series of Plots

You can pause between two plots already sent from your computer, for example to change the media type or replace the cartridges.

- 1 Press **Pause** on the front panel.

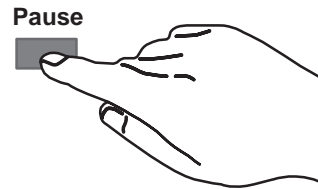

The plotter finishes the current plot and pauses (indicated by the **Pause** light being on) until you press **Pause** again.

While the plotter is paused, you can use the front-panel as normal, for example to change a front-panel menu setting or to load and specify a new media type.

0027

- 2 To resume printing, press **Pause** again.

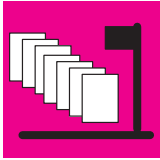

Managing Plots Not Yet Printed (The Queue)

The normal sequence of events is:

- 1 You send a plot from your computer (or choose one of the internal sample plots from the Demos menu).
- 2 The plotter's Receiving light flashes while it receives and processes the data.
- 3 The plotter starts printing or, if queueing is on, places it in the queue until its turn comes round.

To Start Printing a Plot That is Waiting for a Timeout

If all is in order (media loaded, cartridges loaded, no file error), there are still two reasons why a plot you have sent from your computer may not start printing when expected:

- The plot file may lack a proper file terminator and the plotter is therefore waiting for the specified I/O timeout period before assuming it is complete. See page 7-9.
- Nesting may be on and the plotter is waiting for the specified Nest wait timeout period before calculating the appropriate nests. See page 6-12.

In either case, if you want to override the timeout period and start printing

Press **Form Feed and Cut** on the front panel.

**Form Feed
and Cut**

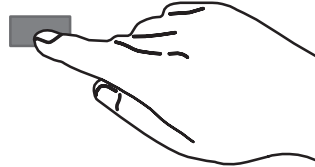

0027

What is the Queue?

Your plotter can store plots in a queue at the same time as plotting the current file. It stores them by *page*, though if you send only single-page files, you can regard these as plots. The size of the queue is limited by the number of pages (maximum 32) and the total memory occupied by the queue;

700
750C Plus

- maximum standard memory 7 MB through 71 MB

- maximum standard memory 11 MB through 75 MB

depending on which memory expansion modules you have installed. Remember that file size and memory usage are not the same thing, as explained on page 7-10. However, it is clear that the larger your files are, the fewer you can store in the queue.

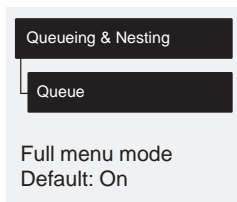

With queueing turned ON

- You can send one or more plots to the plotter without waiting for the current page to finish.
- You can manipulate the pages in the queue, for example prioritizing them and replotting them.
- You can use nesting, the plotter's media-saving feature (see page 6-10).

With queueing turned OFF

- The plotter will not accept a file sent from the computer until the current page has finished plotting and the plotter is ready.
- You cannot use nesting (see page 6-10).

If you turn queueing off while pages are still in the queue, they will be plotted and – if nesting is on – nested, until the queue is empty.

Managing Plots Not Yet Printed (The Queue)

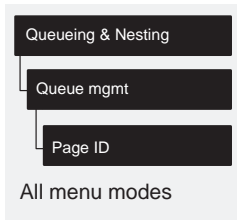

To Identify a Page in the Queue

In Queueing & Nesting, you can scroll through the pages in the queue.

Each has an identifier, comprising:

<position in queue> : <plot name>

Position in queue

The page currently being plotted is in position 0. The next page to be plotted is in position 1, the one after in position 2, etc. The previous page plotted is position -1, the one before that in position -2, etc.

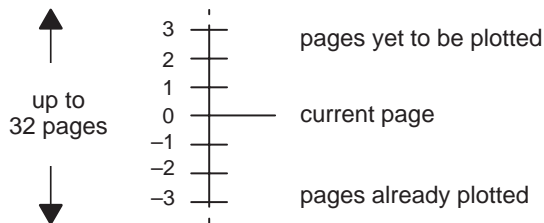

Plot name

Some applications let you give your plot a descriptive name which it then conveys to the plotter – for example “Building 2 Exterior”. *If your software supports this feature*, this plot name is applied to each page and displayed after its queue position:



If your software does not support this feature, your plotter will assign names to the pages in its queue. The plotter-assigned name indicates how many thousands of vectors make up the page:



Note that this is not an indication of the amount of memory the page requires. For that, see page 6-7.

To See the Size of a Page in the Queue

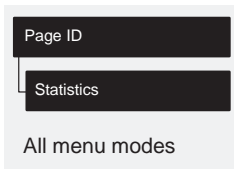

Statistic	Comments
Width	The shorter side of the page, in millimeters.
Length	The longer side of the page, in millimeters.

To Prioritize a Page in the Queue

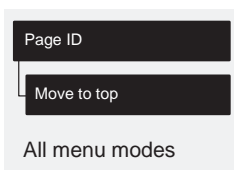

To make any page in the queue the next one to be plotted, select it and choose Move to top.

If nesting is turned on (see page 6-10), the prioritized page may still be nested with others. If you really want this page to be printed next *and on its own* on the roll, then first turn nesting off and then use Move to top to move it to the top of the queue.

To Delete a Page from the Queue

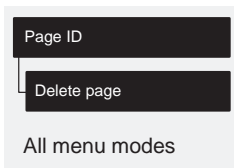

Under normal circumstances, there is no need to delete a page from the queue after plotting it, as it will just “fall off the end” of the queue as more files are sent. However, if you have sent a file in error and want to avoid any chance of it being replotted, you can simply delete it, by selecting it and choosing Delete page.

To remove a page that has not yet been plotted, simply identify it by its position in the queue (see page 6-6) and delete it, by choosing Delete page.

If the page is currently being plotted (its queue position is 0), and you want both to cancel the page *and* to delete it, first press **Cancel** and then delete it from the queue.

To Make Copies of a Page in the Queue

Has The Page Already Been Printed?	Do You Want One Copy Or Several?	What To Do
Yes	One	Use Move to top (see page 6-7).
	Several	Use Copies (see below) and then use Move to top (see page 6-7).
No	One	Use Copies (see below).
	Several	

In all cases, the page must be still in the queue.

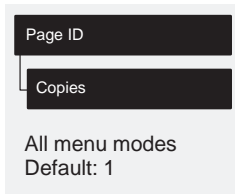

Having selected the page and chosen Copies, use the scrolling keys to specify the number of copies required, and press **Enter**. The number you enter is the actual number of pages to be printed; for example, choosing 2 for a page not yet plotted means you will get the one original and one copy. The maximum is 99.

The setting you specify in this option overrides any value set by your software.

Note that, if Rotate (see page 4-7) was on when you sent the plot, every copy will be rotated too.

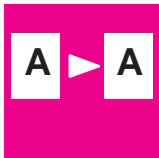

700

Replot an Image Using the Plotter's Memory

If you have sent an image from your computer, the plotter will retain this image in its memory until another image is sent from your computer. The current image can be plotted again using **Replot** on the front panel.

- 1 Press **Replot** on the front panel.

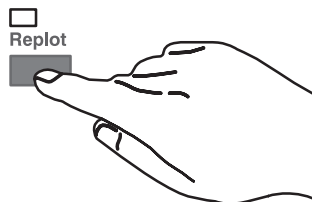

The Replot light flashes briefly while the plotter prints the current image again.

Replot does not work if:

- another file has already been sent to the plotter (including internal sample plots, for example the Setup Sheet)
- you have switched the plotter off and on again since first sending the plot
- some files that contain Raster data may not replot because the entire file may not still be held in the plotters memory.

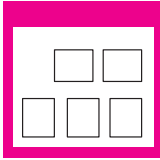

Avoiding Media Waste by Nesting Pages (Roll Media Only)

What is Nesting?

Nesting means placing pages side-by-side on the media (rather than one after the other), to avoid wasting media.

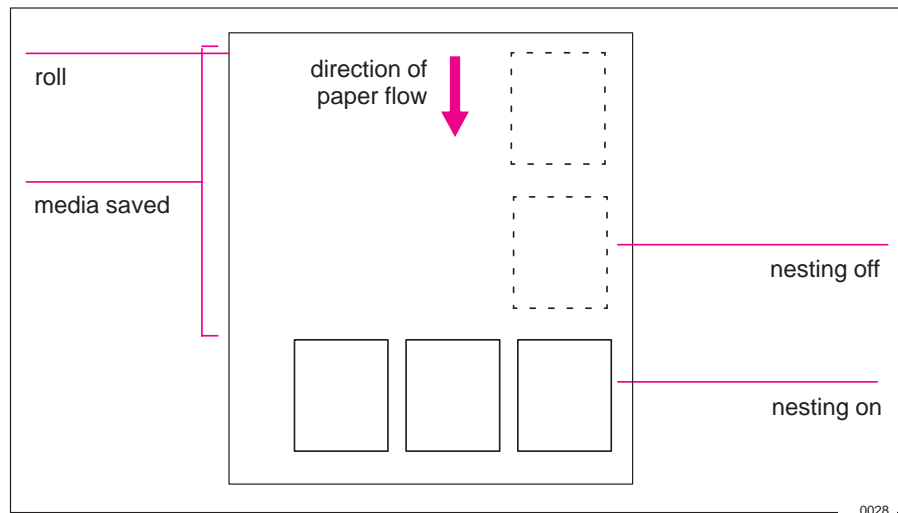

0028

The plotter may automatically rotate a page in nesting (see page 6-11). It may do this even with a single page.

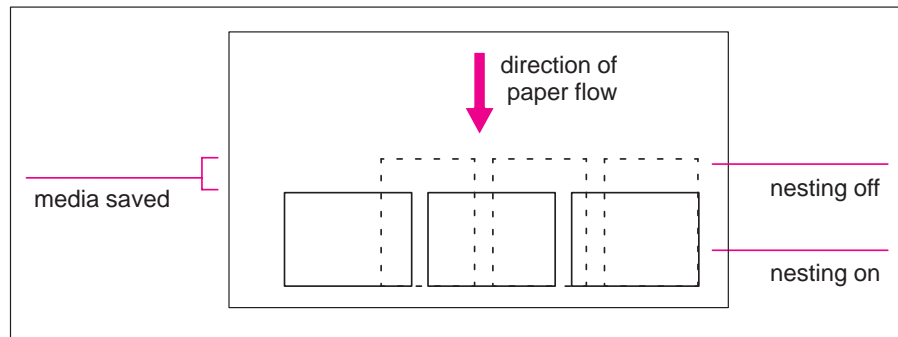

0029

When Does the Plotter Try to Nest Pages?

When all the following are true:

- The plotter is loaded with roll media rather than sheet media.
- In the front-panel menus, Queue is ON (the default). See page 6-5.
- In the front-panel menus, Nest is ON (that is, set to either Optimal or In order). See page 6-12.

Which Pages Qualify for Nesting?

In order to be in the same nest, the individual pages must be compatible on both the following criteria:

- **Color or monochrome**

Either all are color or all are monochrome. Remember that monochrome may include a color plot rendered in grayscales by use of the front-panel Color/Mono key – see page 5-9.

- **Print resolution**

Either all are 300 dpi or all are 600 dpi – see page 5-11.

Which Pages May be Rotated?

Apart from obvious physical limitations on the roll, any page containing raster data will *not* be rotated.

If you are using the Microsoft Windows driver supplied with this plotter, your files *do* contain raster data and therefore the pages will *not* be rotated in nesting. The normal line drawings of most CAD software do *not* contain raster data, and therefore *may* be rotated in nesting.

750C Plus

To Turn Nesting On or Off and Choose the Nesting Method

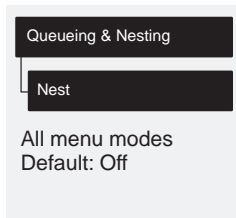

Nest Setting Selected	Plotter's Response
Off	The plotter will not nest pages.
Optimal	<p><i>Choose this if you want to use the least amount of media.</i></p> <p>The plotter will search all through the queue for suitable pages. It will nest the pages according to an algorithm that, for most combinations of page sizes, saves the most media. The resulting nesting pattern may still vary, depending on the size of the first page.</p>
In order	<p><i>Choose this if the speed with which you receive your plots is most important.</i></p> <p>The plotter will try to nest pages in their queue sequence. If it comes across an incompatible page, it will stop searching and print any nest it has already created.</p>

What Happens to Nesting if you Turn Queueing Off?

Turning queueing off does not turn nesting off for pages already in the queue. The plotter prints all the pages in the queue before accepting any more files. As soon as you turn queueing off, the nesting setting also changes to *off*. When queueing is turned on again, the plotter restores nesting to its previous setting.

How Long Does the Plotter Wait for Another File?

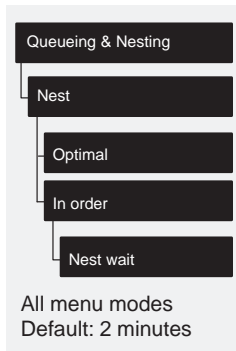

So that the plotter can make the best nest possible, it waits after a file has been received to check if a subsequent page will nest with it or with pages already in the queue. This waiting period is the *nest wait* time. The factory default nest wait time is two minutes. This means that the plotter waits for up to two minutes after the last file is received before plotting the final nest. You can change this waiting time using the front panel menu (as shown opposite). The available range is 1 minute through to 99 minutes.

Getting the Best from Nesting (Nesting and Margins)

What the plotter may do

In order to “squeeze in” one more page, the plotter may reduce the right margin of the right-most page by up to 3 mm (0.08 in). This is done only if:

- your Page format / Size is set either to a Best option or to a discrete standard size, and if
- the roll of media loaded is slightly narrower than a standard size.

What you can do

You can reduce the side margins too, for every page, as explained on page 4-6. In order to give the plotter the best chance of nesting the most pages, we recommend that you set Page format / Margins to Smaller.

Nesting and the Rotate Feature

Since nesting may automatically rotate pages, the front panel’s Page format / Rotate setting is ignored as long as nesting is on.

To See the Current Overall Configuration of the Plotter	7-2
To See the Current Configuration of the Front-Panel Settings .	7-3
To Change the Front-Panel Settings	7-4
Recalibrating the Plotter for Accuracy	7-5
Changing the Graphics Language Setting for a Different Application	7-7
Changing the Serial Interface Settings	7-9
Changing the I/O Timeout Setting	7-9
To Upgrade Your Plotter with More Memory	7-10
To Upgrade Your Plotter with the Postscript Option	7-11
To Upgrade Your Plotter with a Network Interface	7-12

Reconfiguring Your Plotter

Reconfiguration, Recalibration and Upgrades

To See the Current Overall Configuration of the Plotter

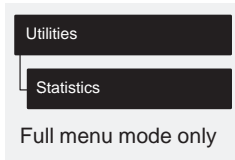

Item	Comments
Max X Max Y	<p>These two figures, in millimeters, give the size of the current plotting area, that is, the area in which the plotter will print the next plot unless it is changed. Normally each plot file received sets these dimensions with its Page Size command. You can impact it by:</p> <ul style="list-style-type: none"> • the current front-panel setting for Page format / Size. • the media size currently loaded. <p>Remember:</p> <ul style="list-style-type: none"> • Plotting area = page size minus margins. • X represents the vertical (paper path) axis. • Y represents the horizontal (carriage path) axis.
Code rev	This is the revision number of the plotter's internal code.
RAM present	<p>This is the size, in megabytes, of the plotter's main standard memory, plus the amount of memory reserved for printing.</p> <ul style="list-style-type: none"> • This does not correspond directly to the size of your files on the computer, as explained on page 7-10. • This is the total RAM, not the RAM currently free.
Media	<p>This is the media type which the plotter thinks is currently loaded (or was last loaded), on the basis of what you specified when you loaded it. For an explanation of media types, see page 3-3.</p> <p>In this display, the following abbreviations are used:</p> <ul style="list-style-type: none"> • Translucent = Translucent bond. • High-gl photo = High-gloss photo paper. • Semi-gl photo = Semi-gloss photo paper. • High-gl film = High-gloss film. • Nat. tracing = Natural tracing paper.
ROM SIMM	This tells you if an optional ROM SIMM is installed in the plotter, for example PostScript.

750C Plus

To See the Current Configuration of the Front-Panel Settings

1 Make sure either a roll or a sheet of media is loaded.

2 Print the **Current Configuration Plot**, by pressing the up-arrow and down-arrow keys simultaneously.

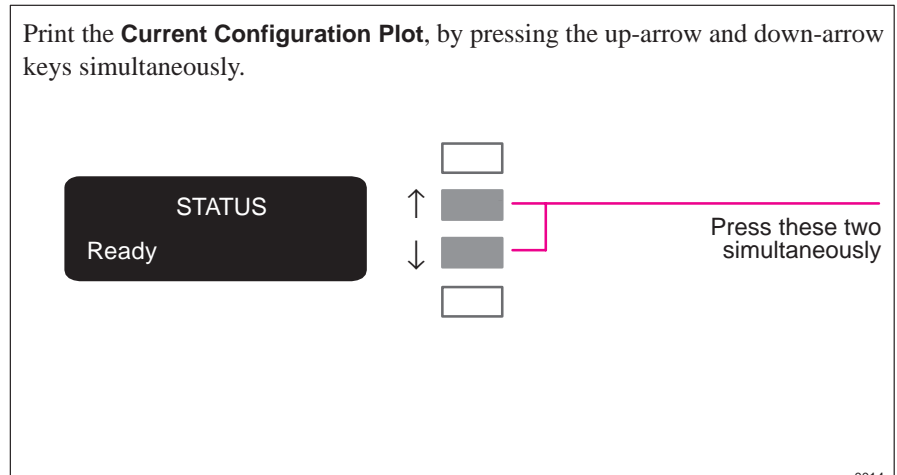

0014

The **Current Configuration Plot** lists, in an easy-to-read format, all the items available in the front-panel menus, together with their current settings (in red italics, for the HP DesignJet 750C Plus). Note that some of the items do not appear in the front-panel display unless you have set Utilities / Menu mode to Full (the default is Short, so that they *do not* appear). See the legend at the bottom of the plot for details.

NOTE. Do not confuse the **Current Configuration Plot** with the **Service Configuration Plot**, which you can print by selecting Utilities / Service config. Apart from its use in calibrating the plotter, as explained on page 7-5, the **Service Configuration Plot** is likely to be needed only by a service engineer.

To Change the Front-Panel Settings

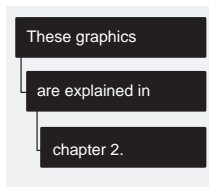

Chapter 2 of this manual explains how to use the front-panel display, including how to change any of the settings. It also explains the small menu graphics that appear in the left margins of this manual whenever a particular menu item is explained.

The meanings of all the items in the front-panel menus are explained at the relevant point in this manual. Refer to the index at the back of the manual for the item you want to change.

Recalibrating the Plotter for Accuracy

When to Recalibrate the Plotter

Your plotter was calibrated at the factory using HP Matte Film, with a thickness of 0.12 mm (0.0048 in);

- at 23°C (73°F),
- with 50-60% relative humidity.

It will operate with greatest accuracy in similar environmental conditions. If you are operating under significantly different conditions, you should recalibrate the plotter as explained here. The plotter's environmental specifications are given on page 11-4. Also, if you are using a non-standard media type, you should first recalibrate the plotter for that media type. For supported media types, see page 3-3. You may also need to recalibrate the plotter if you have banding problems, see page 9-20.

A Quick Guide to Whether Recalibration is Necessary

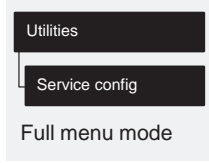

- 1 Make sure E/A0-size or D/A1-size media is loaded.
- 2 Print the **Service Configuration** plot, by choosing the option shown in the menu graphic on the left.

- 3 Near the top of this plot are a pair of Xs. With a ruler measure the distance between them. It should be 500 mm. If significantly different you will need to recalibrate the plotter as described on the following page



Recalibrating the Plotter for Accuracy

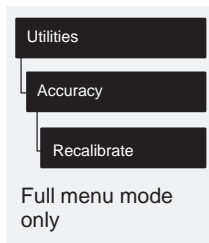

- To Recalibrate the Plotter**
- 1 Choose your media type (*sheet or roll*). If recalibrating for a non-standard media type, use that type. Otherwise, HP Matte Film will give greatest accuracy.
 - 2 Choose your media size. Sheet media must be either E/A0 or D/A1.
 - 3 Go to Recalibrate in the front-panel menus, as shown above left.
 - 4 Choose Create pattern. The message *Calibrating* is displayed. If sheet media is loaded, this will be ejected. If roll media is loaded, you are asked to remove it.
 - 5 When prompted, load your media, using the normal procedure. If using sheet media, load it in *portrait* orientation, unless you chose D/A1-size media for an E/A0-size plotter, in which case load it in *landscape* orientation.
 - 6 When the calibration plot is finished, remove it.
 - 7 Unload any unplotted media.

- 8 Rotate the calibration plot 90° counterclockwise and reload it *printed side down*, so that the black arrows go into the plotter first. NOTE: Even if you selected roll media in step 5, this time you must select *sheet media*.

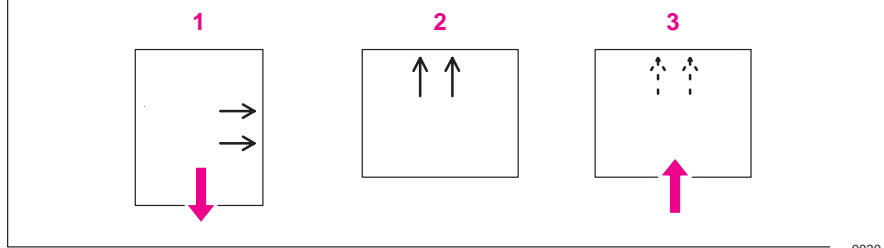

- 9 Go to Recalibrate again and, this time, choose Measure pattern.
- 10 When the plotter has finished measuring and has ejected the sheet, STATUS/Ready is displayed. The recalibration routine is finished.

To Restore the Factory's Calibration

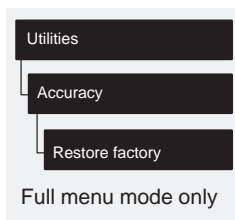

From the Accuracy menu, choose Restore factory. That's all.

Changing the Graphics Language Setting for a Different Application

Your software application communicates with the plotter by a graphics language. The plotter supports HP industry standard CAD language

- HP-GL/2 (7856)
- HP-GL (7586B)
- HP RTL

The plotter's default setting is designed to work successfully with most applications, and is called 7586, HP-GL/2. However, it's possible that with some older or less common applications, you may need to change this setting to HP-GL/2, as explained in the table below.

To Change the Graphics Language Setting

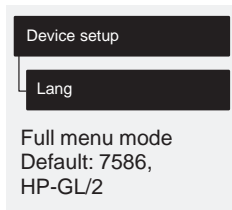

Graphics Language	Comments
7586, HP-GL/2	This should work successfully for most software applications. With this graphics language setting another parameter is available: Terminator. Try changing this setting from Normal (the default) to Special: <ul style="list-style-type: none"> • if you are using an obsolete HP 7586 (pen plotter) driver, and your plots are incomplete.
HP-GL/2	Try this setting: <ul style="list-style-type: none"> • if you have experienced plot position problems. • if you have experienced timing problems. However, if you choose this setting, you don't have access to the Terminator option.

Graphics Language and Networks

Note for system administrator. If you are using the plotter with a network spooler, consider modifying the spooler to automatically insert the PJI language-switching commands at the beginning and end of each file. This allows the plotter to switch automatically into the correct graphics language for your current plot and returns the plotter to the front panel graphics language setting for subsequent plots. For PJI reference information, see page 11-13.

Changing the Interface Settings

Network	With a network interface (such as HP JetDirect Print Server), refer to your network interface documentation for advice on any front-panel configuration.
Parallel	With a parallel interface, no front-panel configuration is necessary.
Serial	With a serial interface, you should have configured it when installing the plotter, as explained on page 1-29. However, you may need to reconfigure it: <ul style="list-style-type: none"> • When you connect a new computer to the plotter. • When you output to the plotter from a new application. • If you experience problems with distorted or unintelligible plots.

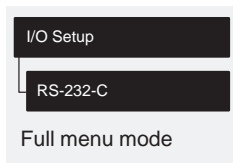

To Change the Serial Interface Settings

This task is explained in detail on page 1-29, including a note of the defaults and likely requirements.

To Change the I/O Timeout Setting

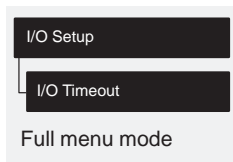

Some software may not write a proper file terminator at the end of the file. In this case, the plotter will not know that the file is complete and will wait for more data until the end of the “I/O Timeout” period. By default, this period is 30 minutes, but you can change it in the menu (indicated on the left) to as little as 30 seconds.

To Upgrade Your Plotter with More Memory

700

Your plotter comes with 7 MB of standard memory (4 MB of main memory and 3 MB of printing memory). You can expand this up to a maximum of 71 MB of standard memory by adding *one or two* memory expansion modules.

750C Plus

Your plotter comes with 11 MB of standard memory (8 MB of main memory and 3 MB of printing memory). You can expand this up to a maximum of 75 MB of standard memory by adding *one or two* memory expansion modules.

For HP part numbers, see page 11-14.

For installation details, see the task starting on page 1-6.

File Size and Memory Usage

There is no direct relationship between file size on your computer and memory used in the plotter to print that file. In fact, because of file compression (and general complexity) it is often impossible to estimate how much memory will be used. In general, thicker lines (≥ 0.5 mm), complex objects (such as polylines) and fills will all use significantly more memory.

This also means that size of the largest file you can store in the plotter's queue is not the same thing as the amount of memory installed in your plotter.

To Upgrade Your Plotter with the Postscript Option

To use your plotter with Macintosh applications that output files in the Adobe PostScript® language, you need to order the PostScript Upgrade Kit. For the HP part number, see page 11-14. Such applications include, for example:

- Adobe Illustrator
- Adobe Photoshop
- Aldus Freehand
- Aldus PageMaker
- QuarkXpress.

Many Microsoft Windows applications (for example CorelDRAW!), can also output PostScript files, but in most cases all you need is the Microsoft Windows driver supplied with your plotter.

As well as a PostScript driver for your software, the PostScript Upgrade Kit includes a ROM SIMM, which you install in the back of your plotter.

The upgrade kit comes with its own detailed installation instructions. When removing the cover plate, as instructed, use a flat-head screwdriver and remove only the four screws on the cover plate.

Note that you must install the PostScript ROM SIMM in the second slot from the left.

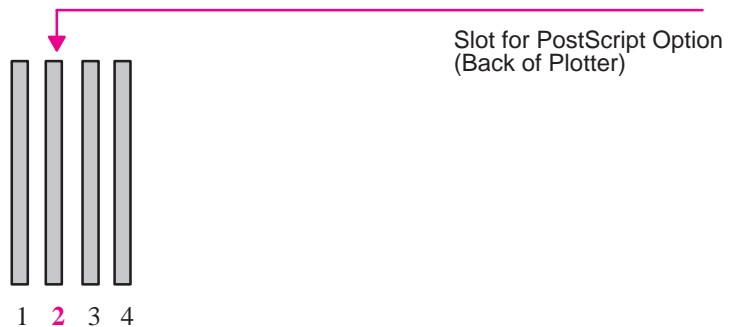

To Upgrade Your Plotter with a Network Interface

You can connect your plotter directly to a LAN using an optional network interface card such as the **HP JetDirect Print Server**. Depending on your needs, you may want to use the network interface *instead of or in addition to* the parallel and serial interfaces.

The slot for a network interface card is situated at the back of the plotter, alongside the parallel and serial ports. Using a flat-head screwdriver, unscrew only the two screws on the cover plate.

Slot for network interface card

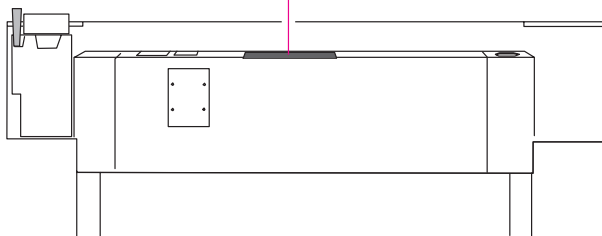

For installation and configuration of the HP JetDirect Print Server, see the documentation supplied with that product.

1845d

HP JetDirect Print Server

For part numbers of the HP JetDirect Print Server, see page 11-15. This interface supports most common network environments and the specification of this product is updated regularly. For details of the latest version available, please contact your HP dealer or HP Sales and Support office.

Replacing the Print Cartridge(s) 8-2
Cleaning the Plotter 8-2
“Normal” Plotter Use 8-3

Maintaining Your Plotter

Cleaning and Service

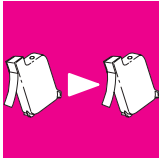

Replacing the Print Cartridge(s)

Replaceable print cartridge(s) have been used in your plotter, greatly reducing its user maintenance requirements, as these are the components that experience the greatest wear and tear.

750C Plus

Under normal use, you will probably find that you have to replace the black cartridge more often than the color cartridges.

For instructions on when and how to replace cartridge(s), see the section starting on page 3-26.



Cleaning the Plotter

Cleaning is limited to the outside of the machine. Use a damp sponge or a soft cloth and household cleaner.

WARNING

To avoid an electric shock, make sure that the plotter is switched OFF and unplugged before you clean it. Do not let water get inside the plotter.

CAUTION

Do not use abrasive cleaners on the plotter.

Any maintenance or repairs beyond this should be done by a qualified service technician.

“Normal” Plotter Use

“Normal” plotter use means less than

- 20 pages per day (if medium-density E/A0 CAD plots), or
- 12 pages per day (if medium-density E/A0 image prints).

If your drawings are smaller than E/A0, the number of pages per day can be higher.

If you use the plotter less than this, it is unlikely you will need to get it serviced. If you use the plotter more than this, it is possible that, after a period of time, it will need to be serviced. The plotter itself keeps an internal count of total pages printed and total passes of the cartridge carriage. If the front panel periodically displays

STATUS

Maintenance advised

this means that your use of the plotter has exceeded one of the following warranty limits:

- either 20,000 pages printed
- or 4,500,000 passes of the cartridge carriage.

Contact your local HP dealer or HP service engineer to arrange a service. After the service the message will disappear. If you choose not to have the service, you may continue to use the plotter as normal, but may encounter a number of operational or print-quality problems.

You can check your current count of pages printed and passes of cartridge carriage by printing the **Service Configuration Plot**.

To Print the Service Configuration Plot

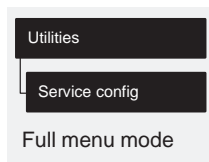

- 1 Make sure media is loaded.
- 2 In the front-panel menus choose the option shown on the left.

Using the Documentation to Help Solve Problems 9-2

Locating the Source of Problem 9-3

Solving Media-Handling Problems 9-4

Solving Print Cartridge Problems 9-7

Clearing a Media Jam 9-8

Solving Communication Problems 9-9

Solving Problems with Plot Position or Content 9-10

Solving Print Quality Problems 9-16

Solving Front-Panel Problems 9-21

Solving Miscellaneous Problems 9-23

Getting Help 9-25

Troubleshooting

Using the Documentation to Help Solve Problems

- If you are looking for the meaning of an error message, see chapter 10.
- If you know the problem is related to a certain task, first check the relevant section in this manual, for the step-by-step procedures. Use this manual's index to find the section. For example, if you are having difficulty with your page format, refer to chapter 4, titled: Controlling the Page Format.
- If the problem persists, refer to the appropriate section in *this* chapter. The sections are
 - Solving media-handling problems
 - Clearing a media jam
 - Solving problems with plot position or content
 - Solving print quality problems
 - Solving miscellaneous problems.
- If the problem could be related to your software driver, and you are using an HP driver, refer to the drivers' troubleshooting documentation and the 'On-Line-Help' in your application software.
- If the problem has no obvious cause, read "Locating the source of the problem" on the next page.
- **If you still cannot solve the problem, refer to "Getting help" on page 9-25.**

Locating the Source of the Problem

- 1 Look at the front-panel display for any error message. For an explanation, see chapter 10.
- 2 Test the plotter.
 - Switch the plotter off. Ensure that the power cord is firmly inserted in the plotter and plugged in to an outlet that you know works.
 - Switch the plotter on. Print a sample plot (see page 1-24). If the plotter plots this correctly, the problem is probably not with the plotter.
- 3 Test your computer hardware and interface.
 - Ensure that you have the correct interface cable between the computer and the plotter and that it is firmly connected to the correct ports (see the sections starting on page 1-27).
 - Check that your plotter's graphics language setting (in Device setup / Lang) matches the requirements of your software.
 - **Serial interface users only.** Check that your plotter's serial interface settings (in I/O Setup / RS-232-C) match the requirements of your computer hardware and application software. See page 1-29 for details. Also, if you have changed your interface, switch the plotter off and then on again before trying to plot.

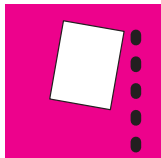

Solving Media-Handling Problems

If the Front Panel Keeps Indicating that Media Is Misaligned or Incorrectly Positioned.

Roll media:

Have you:

- Loaded the roll the wrong way. The media should load over the roll toward you.
- Loaded the media at an angle. The right-hand edge must be *parallel* to the perforated line on the plotter.

Sheet media

Have you:

- Loaded the media at the wrong side of the entry slot. It must be loaded with the right-hand edge against the perforated line on the plotter.
- Loaded the media at an angle. The right-hand edge must be *parallel* to the perforated line on the plotter.
- Pushed or held the media back as it is loading. You must hold the media only by the edges and immediately release it when the plotter is loading.
- It is also possible that the media itself is crumpled or warped or has irregular edges.
- If you are using hand-cut media, perhaps the edges do not form a right-angle or they are rough. It is not recommended to use media that you have cut yourself; use only purchased sheet media.
- If you cannot make your media's leading edge straight, you can turn on the skew tolerance feature (Device setup / Skew tolerance). See page 3-21, but remember that this feature can skew your plot on the page.

If Media Crumples When You Load it

- Clear any obstructions in the media path.
- Be sure the leading edge is straight and free of tears. Cut a straight edge with the knife if necessary.
- If your media is curled, and if both sides are the same, load it with the curved (hollow) side towards you (Certain media types – for example coated paper – have a plotting side and a non-plotting side and these must be loaded plotting side down.)
- When loading media, hold each edge and push the media into the plotter *evenly* against the stops until a slight buckle develops evenly across the media. Let go as soon as it starts to feed into the plotter.
- If you have just moved the plotter or your media from an environment with a different humidity level, let the media stabilize for at least 15 minutes before loading it.
- **Roll media only.** Open the roll cover and raise the lever. Unload the leading edge of the roll. Push the media all the way to the right so that it is flush against the media stop on the roll core. Then reload the media.

If Plots Do Not Feed Out Properly From the Plotter

- Make sure the roll cover is completely closed before you plot.

If The Automatic Cutter Does Not Cut Immediately When a Plot Has Finished

- Check the Page format / Margins setting. When this is set to Smaller, the plotter waits until the next plot begins plotting so it can create a 10 mm margin between both plots or nesting sets.
- Press the **Form Feed and Cut** key if you need to cut the media before the ink-drying time has passed or before the next plot begins plotting. Use caution to avoid smearing the ink.
- Check the ink-drying time and change if necessary (Device setup / Drying time).

If the Automatic Cutter Does Not Work

- The automatic cutter is activated only when roll media is loaded.
- Your software application may have disabled the automatic cutter. Refer to your software documentation or contact your software vendor for more information.

If Plots Fall on the Floor After Being Cut

- Do not let more than twenty plots accumulate in the bin.
- Make sure you have loaded roll media properly. If loaded incorrectly, the natural curl of the media may cause it to miss the bin and fall to the floor.

If a Sheet Is Ejected When You Switch On the Plotter

- The plotter is undertaking an automatic calibration check. Simply wait for the STATUS / Ready message and then reload the sheet.

If Plots Do Not Stack Properly in the Bin

- You may be too close to the end of the roll. The natural curl near the end of the roll can cause stacking problems. Load a new roll or remove plots manually as they are completed.
- If plotted media is sagging or wrinkling between the bin wires after it is cut and fed out, try placing a sheet of scrap paper in the bin shelf that is at least the size of the plot.
- If you are mixing plots or nesting sets of several different sizes, you are more likely to have stacking problems because of the different sizes of media in the bin.



Solving Print-Cartridge Problems

If the Access Cartridge(s) Key Does Not Work

- Make sure the window is closed before you press **Access Cartridge(s)**.

If the Plotter Runs the Cartridge-Alignment Routine Unexpectedly

- The plotter runs the automatic cartridge alignment procedure every time you load, replace or even reseal a cartridge, whether it is a new cartridge or not. Do not remove the cartridge(s) unnecessarily.
- You can stop the alignment by pressing **Cancel**, but the plotter will restart the alignment procedure the next time you switch it on.

If Brand New Cartridge(s) Have Problems

- Check the cartridge(s) to be sure you have removed the protective nozzle tape.
- Try reseating the cartridge(s).

Don't forget that, after you remove or reseal a cartridge, the plotter will run its automatic cartridge alignment procedure – see page 3-27.

For troubleshooting other problems with the print cartridge(s), see the section starting on page 9-16.

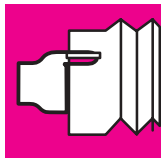

Clearing a Media Jam

- 1 Switch OFF the plotter, open the window and raise the media lever.

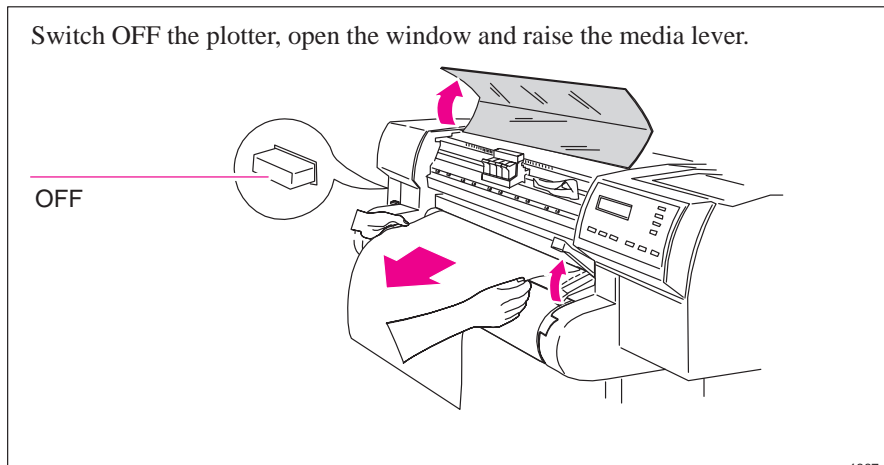

WARNING

Don't touch the stainless steel strip that runs the length of the plotter behind the cartridge carriage; its edge is very sharp. Keep hair, jewelry, clothing, and foreign objects away from the plotter mechanisms.

When moving the cartridge carriage, touch only the black plastic parts.

- 2 Carefully move the cartridge carriage out of the way – if possible all the way to the enclosed area on the left or the right. Which way you are able to move it depends on where the media is jammed. If the plotter was in the process of cutting media at the time of the jam, the cutter carriage will be attached to the cartridge carriage and will move with it.
- 3 Carefully remove any of the jammed media which you can easily lift *up and out from the top of the plotter*.
- 4 Carefully pull the rest of the roll or sheet *down and out of the media entry slot*.
- 5 Lower the window and the lever and switch on the plotter. Press the **Form Feed and Cut** key to eject any pieces of media that are still in the media path.
- 6 Reload the media as normal – see page 3-10. Remember that, if it's a roll, you may need to trim the edge.

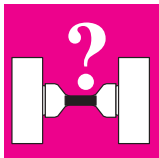

Solving Communication Problems

If There is a Problem Communicating between Your Computer and the Plotter

Some symptoms of a communication problem are:

- The front-panel **Receiving** light does not come on.
- The front-panel display does not show STATUS / Receiving.
- Your computer displays an error message when you are trying to print.
- Your computer or plotter “hangs” (stays idle) while communication is taking place.
- Your plotted output shows random or inexplicable errors (misplaced lines, partial drawings etc.).

Items to start checking are:

- Have you selected the correct interface port in your software?
- Does the plotter work correctly when receiving files from other software?
- If the plotter is connected to a network, try using it when connected directly to your computer.
- If your plotter is connected to your computer via any other intermediate devices, such as switch boxes, buffer boxes, cable adapters, cable converters etc., try using it when connected directly to your computer.
- Try another interface cable. For details of supported cables, see page 11-8.

Solving Problems with Plot Position or Content

If you don't find the solution to the problem here, other sources of help are:

- The documentation supplied with the driver that you are using to manage the output from your software application to the plotter. For example, the online and printed documentation included in the following two drivers supplied with your plotter:
 - HP plotter drivers for AutoCAD
 - HP plotter driver for Microsoft Windows applications
- The documentation supplied with your application software, for example the *AutoCAD Reference Manual*.



If the Plot Is Completely Blank

- Check the print cartridge(s) to be sure you have removed the protective nozzle tape from all of them. Do not forget that, after you remove or reseal a cartridge, the plotter will run its automatic cartridge alignment procedure – see page 3-27.
- Cartridge(s) may be out of ink. For an explanation of how to check if a cartridge is out of ink, see page 3-26.



If the Output Contains Only a Partial Plot

- Did you press **Form Feed and Cut** before all the data was received by the plotter? If so, you have ended the data transmission and will have to print the plot again. (You normally don't need to press **Form Feed and Cut** to unload the plot.)
- The I/O Setup / I/O Timeout setting may be too short. Increase the setting and plot again. See page 7-9.
- The file may be too big for the plotter's memory. For information on memory expansion modules, see page 11-14.
- There may be a communications problem between your computer and the plotter. Make sure interface cable is connected properly.
- Check to make sure that your software settings are correct for your current plot size (e.g., long-axis plots).
- If you are using network software, make sure it has not timed out.

See also under "If the plot is clipped" on page 9-12.



If the Plot Is Clipped

This normally indicates a discrepancy between the actual plotting area on the loaded media and the plotting area as understood by your software. For general advice on plotting areas and page size, see chapter 4.

- Check the actual plotting area for the media size you have loaded. Plotting area = media size minus margins. For media size and margins, see page 11-2. For actual plotting areas, see page 11-6.
- Check what your software understands to be the plotting area (which it may call “printable area” or “imageable area”). For example, AutoCAD assumes standard plotting areas that are larger than those used in this plotter.
- Check that the orientation of the media is the same as that assumed by your software. The front-panel Page format / Rotate option changes the orientation of a drawing and, on roll media, the orientation of the page. It is possible that a rotated plot on roll media may be slightly clipped in order to retain the correct page size, as explained on page 4-8.
- You may have asked to rotate the plot from portrait to landscape on media that is not wide enough, for example a D/A1-size plot rotated on a D/A1-size roll.
- If necessary, change the plotting area in your software. For example, in AutoCAD, specify User Sizes (see AutoCAD documentation).
- The file may be too big for the plotter’s memory. This is the case if the front panel displays “Out of memory – data was lost”. For information on memory expansion modules, see page 11-14.



If a Long-Axis Plot Is Clipped

- Does your software support long-axis plots?
- Have you specified an appropriate media size in your software?
- Make sure that the plotter’s Page format / Size is set to Inked area.

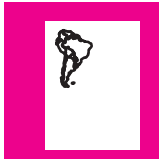

If the Entire Plot Is in One Quadrant of the Correct Plotting Area

- Is the page size configured in the software too small?
- Are you sure that your software does not believe the drawing to be in one quadrant of the page?

Otherwise, this indicates an incompatibility between the software and the plotter:

- Is your software configured for this plotter? For general advice, see page 1-35. For advice specific to your software, see either the documentation supplied with the driver or any Software Application Notes supplied with your plotter.
- If you still have not found the solution, try changing the plotter's **Graphics Language** setting on the front panel (Device setup / Lang).



If the Plot Is Unexpectedly Rotated

- Check the front-panel Page format / Rotate setting. See page 4-7.
- If Queueing and Nesting are both ON, plots may be automatically rotated to save media. See page 6-11.



If the Plot Is a Mirror Image of Your Drawing

- Check the front-panel Page format / Mirror setting.



If the Plot Is Inaccurate

- If you notice problems with accuracy, print the **Service Config** plot, as explained on page 7-5, to see if the plotter needs to be recalibrated.



If the Plot Is Distorted or Unintelligible

- The interface cable between your computer and the plotter could be faulty. Try another cable to see if the problem is corrected.
- If you are using a serial interface between the plotter and your computer, make sure the plotter's serial interface settings match the settings and requirements of your software and hardware. See page 1-29.



If One Plot Overlays Another Plot on the Same Sheet

- The I/O Setup / I/O Timeout setting may be too long. Decrease the setting and plot again. See page 7-9.
- If Device setup / Lang is set to 7586,HP-GL/2 (the default), try changing the Terminator setting and send the files again.



If Pen Settings Seem To Have No Effect

- Either you have changed them in Pen settings / Define palette but forgotten to select that palette in Pen settings / Palette,
- or you expected the software-driven pen settings but the front panel Pen settings / Palette is not set to Software.

See page 5-6.

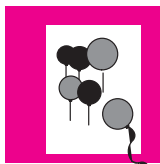

750C Plus

If the Plotter Produces a Black and White Plot When You Expected a Color Plot

- Check the front panel **Color/Mono** setting, and the equivalent setting in your software.

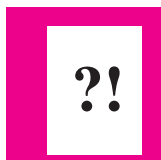

If the Plotter Has Printed a Different Plot Than the One You Were Expecting

One possibility is that you have accidentally initiated one of the plotter's internal plots:

- **The Cartridge Alignment Plot.** (A small pattern of lines without text.) This is printed automatically every time you replace, or reseal a cartridge.
- **The Current Configuration Plot.** (A graphic and text plot with the current configuration details) This is plotted by simultaneously pressing the two arrow keys on the front-panel.
- **The Sample Plot.** (A graphic plot with product information) This is plotted from the front-panel menu Demos / Samples.
- **The Front-Panel Menu Plot.** (A text plot showing the complete menu structure) This is plotted from the front-panel menu Demos / Menu.
- **The Service Configuration Plot.** (A text plot with service information) This is plotted from the front-panel menu Utilities / Service Config.
- **The Palette Demo Plot.** (A plot with 256 colored squares) This is plotted from the front-panel menu Demos / Palette.

750C Plus



If the Quality Of A Color Plot Is Not as Good as You Were Expecting

- Select Best on the front-panel **Print Quality** key and plot again.
- Did you specify the correct media type when loading? The highest line quality is only produced using Opaque Bond, Coated Paper or Matte Film. For details of media types, see page 3-3. To find out the plotters' current media type setting, see page 7-2.
- Your application-software driver may be overriding the Sharp lines selection on the front-panel menu.
- Are you plotting something other than a line drawing, for example a CorelDRAW! file? If so, you may want to experiment to improve the output quality by setting Sharp lines to Off on the front-panel menu, and plot again.
- Are you plotting a CAD drawing with small raster images? Try setting Sharp lines to On, and plot again.
- When loading the paper, specify "Heavy coated paper" on the front panel, rather than "Coated paper".

750C Plus

Solving Print-Quality Problems

To achieve the best performance from your plotter, we recommend you only use genuine HP accessories and supplies, whose reliability and performance have been thoroughly tested to give trouble-free performance and best-quality plots. For details of HP media, see page 3-3 and the Supplies Source catalog supplied with the plotter.

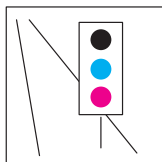

750C Plus

If the Color Is Not as Expected

The means of accurately managing the colors printed by your plotter vary with the software application and driver being used. Refer to the following documentation:

- The *Software Application Note* for your application, in the specific package shipped with this plotter.
- Online documentation in the Microsoft Windows driver shipped with your plotter, particularly in the Color Options dialog box.

Additionally, remember that your plotter may be configured to use one of its internal pen palettes instead of your software's palette (which is the default). See the section starting on page 5-3.

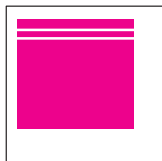

If There Are White Streaks in Solid Fill Areas

This may mean that a cartridge nozzle is blocked. Unless you have switched cartridge check off (see page 3-26), the plotter normally detects this problem and tries to clear the nozzle automatically. However, some nozzles may still remain blocked, and in this case, the plotter will display **Service cartridge(s)** on the front panel. This means you should replace the problem cartridge, as explained from page 3-26. If you are unsure which cartridge has the problem, refer to the next page.

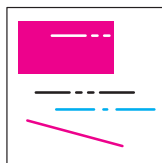

750C Plus

If There are Other Gaps in Solid Areas or in Lines

- 1 One or more of your cartridges may be out of ink. For an explanation of how to check, see page 3-26.
- 2 If the ink levels are OK, try to assess which cartridge has the problem. Look at your plot; if the problem occurs only in one of the following colors – yellow, cyan, magenta, red, green, blue or black – then you can eliminate one or more of the cartridges. Remember that the plotter’s cartridges are yellow, cyan, magenta and black, and that “pure” red, green and blue are made up as follows:

$$\text{red} = \text{yellow} + \text{magenta}$$

$$\text{green} = \text{cyan} + \text{yellow}$$

$$\text{blue} = \text{magenta} + \text{cyan}$$

- 3 If you know which cartridge has the problem, then try reseating it to ensure good electrical connections. While it is out of the carriage, check the print nozzles to make sure the protective tape has been removed. Don’t forget that, after you remove or reseal a cartridge, the plotter will run its automatic cartridge alignment procedure – see page 3-27.
- 4 If you don’t know which cartridge has the problem, then print the **Service Configuration Plot**, by choosing Utilities / Service Config on the front panel. This plot contains a pattern for each of the four cartridge colors (yellow, cyan, magenta and black) which you can examine for gaps or streaks. If you can identify a problem cartridge, try the checks described in 3 above.
- 5 If the problems persist, try running the recalibration routine. See page 7-5.
- 6 If the problems still persist, replace the cartridge(s). See page 3-26.

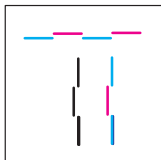

If There are Jagged Vertical or Horizontal Lines

- Did you specify the right media type when loading the media? For details of front-panel media types, see page 3-3. To find out the plotter’s current type of media setting, see page 7-2.
- Force the automatic cartridge alignment procedure by reseating a print cartridge.
- If the problem persists, replace the print cartridge(s). See page 3-26.

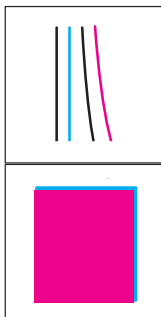

If There are Slightly Warped Lines

- The media itself may be warped. This can happen if it has been used or stored in an extreme environment. For all environmental specifications, see page 11-4.

If There are Color “Shadows”

750C Plus

Force the automatic cartridge alignment procedure by reseating any one of the print cartridges.

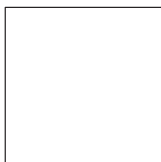

If One or More Cartridges are not Printing at All

- Look to see if the cartridge is out of ink. See 3-26.
- If it is still not printing, remove the faulty cartridge(s) and check the print nozzles to make sure the protective tape has been removed. Do not forget that, after you remove or reseat a cartridge, the plotter will run its automatic cartridge alignment procedure – see page 3-27.

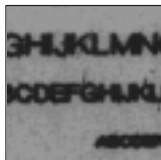

If There are Blurred Lines (Ink “Bleeds” from Lines)

- Perhaps you are not using HP media. For details of HP media, see page 3-3 and the Supplies Source catalog supplied with the plotter.
- The plotter may be operating in an area where the temperature and humidity are too high. For environmental specifications, see page 11-4. To allow for extremely dry or humid environments within the specification, see page 3-22.
- Did you adjust the drying time in the front-panel menu purely to speed up the plotters output? For details of drying time adjustments see page 3-23.



If There are Blotchy Areas (Uneven Fill Density)

- Perhaps you are not using HP media. For details of HP media, see page 3-3 and the Supplies Source catalog supplied with the plotter.
- Did you specify the right media type when loading the media? For details of front-panel media types, see page 3-3. To find out the plotter’s current type of media setting, see page 7-2.
- Note that some media types are not recommended for color plots with large area fills. See page 3-5.



If the Plot Is Too Dark or the Color Too Saturated

- You can make a global adjustment to the amount of black ink used (which affects most colors too) by adjusting the Lightness setting. See page 5-8.



If There Is Pronounced Banding in Area Fills

Some banding is normal, especially in dark or dense area fills. If the banding is unacceptable, try the following:

- Make sure you are using HP media.
- Try changing the Print Quality setting.
- If the banding is in a black or gray area, then try reducing the percentage of black in grayscales, either in your software or in the plotter's palette. For details of how to do this using the plotter's palette, see page 5-3.
- Force the automatic cartridge alignment procedure by reseating a print cartridge.
- Try accuracy calibration.
- Adjust the drying time, see page 3-22.
- If the problem persists, replace the print cartridge(s). See page 3-26.



If Ink Smears After You Remove a Plot

- Use HP media for best quality.
- This can be caused by extreme environmental conditions. For environmental specifications, see page 11-4.
- *With roll media*, the plotter automatically allows a suitable ink-drying time before cutting the roll and dropping the plot in the media bin. To allow for extremely dry or humid environments within the specification, see page 3-22.
- *With sheet media*, **you** need to allow for ink-drying time before removing the sheet. For recommended ink-drying times, see page 3-22. For example, with a best-quality monochrome plot on opaque bond, you should wait about 90 seconds before unloading the sheet.
- Handle media by the edges. If possible, wear gloves when you handle film. Skin oils can interact with ink and cause it to smear.



Solving Front-Panel Problems

If the Access Cartridge(s) Key Does Not Work

- Make sure the plotters' window is closed before you press **Access Cartridge(s)**.

If None of the Front-Panel Keys Work

- Turn the plotter off and then on again. If the problem persists, have your plotter serviced.

If Page Format/Rotate Does Not Work

- Your plot file may be too big for the plotter's buffer, and you may need to consider obtaining a memory expansion module. For information on memory expansion modules, see page 11-14.
- The plotter cannot rotate raster images. If your plots contain raster data (typically, images with heavy area fill and shading that you have scanned into your software) you will not be able to rotate the plot.
- The plotter cannot rotate any file sent using the Microsoft Windows driver supplied with the plotter, as they contain raster images.

If a Display Message Will Not Clear

- Look up the message in chapter 10. The message description may help you understand and resolve the problem.
- If looking up the message did not help, press **Enter**. If that does not work, turn the power off, then on again. If the message still displays, have the plotter serviced. If the message says "System Error" and has an alphanumeric code, refer to the next explanation.

If a “System Error” Message Is Displayed

- Press **Enter**. If the message does not clear, turn the plotter off, then on again to try to clear the system error. If media appears to be jammed, clear it. If the message is still displayed, record the alphanumeric code and have the plotter serviced. Report the code to the service technician; knowing the code number will help the technician resolve the problem.

If an “Out Of Memory/Data Was Lost” Message Is Displayed

- The current plot is too large for the plotter’s buffer. To print this plot you will have to install additional memory. For information on memory expansion modules and memory usage, see page 7-10.



Solving Miscellaneous Problems

If the Plotter Does not Plot

- You may have a power problem. If there is no activity at all from the plotter, and no lights on the front panel, check that the power cable is connected correctly and that there is power available at the socket.
- You may have a problem with your application driver. Is your software configured for this plotter? For general advice, see page 1-35. For advice specific to your software, see either the documentation supplied with the driver or a relevant Software Application Note supplied with your plotter.
- The file may be too big for the plotter's memory.
 - Look on your computer screen for any error message: some drivers, for example the Microsoft Windows driver supplied with your plotter, allow you to choose a different printing mode and try to send the file again.
 - If no other printing mode is available, or if your file still does not print, you may need to consider obtaining a memory expansion module. For information on memory expansion modules, see page 11-14.
- If you continue to have problems, see “Getting help” on page 9-25.

If the Plotter Seems Too Slow

- Did you specify **Best Print Quality** on the front panel? **Best** quality plots are produced more slowly. See page 5-11.
- Did you specify the right media type when loading the media? For details of front-panel media types, see page 3-3. To find out the plotter's current type of media setting, see page 7-2.
- If you are using the Microsoft Windows driver shipped with the plotter, check the settings in the “Print Setup / Options” dialog box, where some of the settings impact printing speed. If in doubt, use the on-screen help system.
- Is Sharp lines set to Auto on the front panel or in your driver? If so, setting it to Off will speed up your plotter but may reduce the quality of your plot. See page 5-14

750C Plus

If the Plotter Waits Too Long to Plot a Nest

- Change the Nest wait setting. See page 6-12.

If the Plotter Performs the Cartridge Alignment Routine Unexpectedly

- This is a normal plotter operation. The plotter will align the cartridge(s) every time you replace, or even reseal, a cartridge, whether or not it is new.

If the Bail (Black Metal Bar) Does Not Lower All the Way

- If the the bail (the black metal bar just inside the plotter's window) will not lower all the way, check for obstructions underneath it.
- Make sure the cutting carriage is pushed all the way to the right.



Getting Help

Hewlett-Packard has support services available to help you in case you have a problem with your plotter.

For a list of the support services available, refer to the *Hewlett-Packard Support Services* booklet shipped with this plotter.

What to Do *Before* You Call

- 1 Review the troubleshooting suggestions:
 - in this chapter,
 - in the relevant driver documentation supplied with this plotter (for users of AutoCAD and Microsoft Windows applications),
 - in any relevant Software Application Note supplied with this plotter.
- 2 Plot the sample plot as explained on page 1-24. If the sample plot works and does not display the problems you have found with your own plots, then the problem is probably not with your plotter.
- 3 If the problem appears to be related to your software application, first contact your software vendor.
- 4 If you still have difficulty, refer to the HP Support Services booklet shipped with this plotter. This document contains a comprehensive list of various support services available to help solve plotter problems.
- 5 If you do call one of the *Hewlett-Packard* offices, please have the following information available to help us answer your questions more quickly:
 - The plotter you are using.
 - The computer you are using.
 - Any special equipment or software you are using (for example, spoolers, networks, switch-boxes, modems, or special software drivers).
 - The cable you are using (by part number) and where you purchased it.
 - The type of interface used on your plotter (RS-232-C, parallel, or modular).
 - The software name and version you are currently using.



If a Repair Is Needed

Contact the *Hewlett-Packard* dealer or HP Sales and Support Office nearest to you for complete service information.



Front-Panel Messages

Front-Panel Messages

This is a list of all possible messages in the front-panel display. If you need to do something, it is shown in *italics* in the **Explanation and Action** column.

The messages are listed in alphabetical order.

Message	Explanation and Action
Alignment error Continue →	The alignment procedure has failed. <i>Check that an opaque media is loaded. Press ↓ to continue and force the automatic alignment procedure again by reseating any of the print cartridges. Do not lift the window while cartridge alignment is being performed.</i>
Calibrate error Continue →	The calibration plot was loaded incorrectly and it could not be measured. <i>Press ↓ to continue, then reload the plot for measurement. Follow front panel instructions.</i>
Calibration done Continue →	Accuracy calibration is complete. <i>Press ↓ to continue.</i>
Close roll cover Continue →	<i>Rewind the media to take up any slack in the roll, close the roll cover, then press ↓ to continue.</i>
Create pattern → Measure pattern →	<i>Press ↑ to create the pattern for automatic calibration. Press ↓ to start the automatic calibration.</i>
Edge not found Reload media	The plotter could not find edge of media during loading procedure. <i>Check the leading edge of the media for unevenness or tears; cut a straight edge, if necessary, and reload. Be sure to position the right edge along the perforated line on the entry platen when loading.</i>
Lift lever	<i>Lift the lever at the right of the plotter.</i>
Load arrow edge print side down	<i>Remove calibration plot, turn it so that the edge with arrows printed on it is print side down, then load that edge into the plotter.</i>
Load cancelled Remove media	You pressed the Cancel button while media loading was in progress. <i>Remove media.</i>
Load error Remove media	You inserted media with the media lever raised. <i>Lower the lever and reload the media.</i>
Load media to align cartridges	<i>Load media to proceed with cartridge alignment.</i>
Lower lever after aligning	<i>When you have finished aligning the roll media as instructed, lower the lever at the right of the plotter.</i>

Message	Explanation and Action
Lower lever to continue	You lifted the media lever while the processor was busy. <i>Lower the lever to continue.</i>
Lower window to continue	You opened the window while the processor was busy. <i>Close the window to continue.</i>
Media too small	The media you loaded for accuracy calibration or cartridge alignment is too small. <i>Reload appropriate media.</i> See page 7-5.
Mispositioned Reload roll	The roll is mispositioned. <i>Reload media.</i>
Mispositioned Reload sheet	The sheet is mispositioned. <i>Remove it and reload it with the right edge no more than 0.2 inches (0.5 cm) from either side of the perforated line on the entry platen.</i>
MIO data error	The modular interface is incorrectly configured. <i>Press Enter to clear the message from the front panel display. Recheck the MIO configuration settings.</i>
MIO error Communication Break	The flow of data from the computer to the plotter was prematurely stopped (e.g., by turning off the computer before all data is sent). <i>Press Enter to clear the message from the front panel display.</i>
Open window to access cartridge(s)	<i>Lift the window to access the cartridge(s).</i>
Out of memory Data was lost	The current plot is too large for the plotter's buffer. <i>Install additional memory to plot this drawing.</i>
Pull ↓ / Align ↔ edges to roll	<i>Grasp the left and right free edges of the roll media and pull toward you until the media is taut. At the same time, align the left and right edges of the media so that they are flush with the left and right edges of the roll.</i>
Remove media	The ink is dry. <i>Remove the calibration plot the plotter just produced. Press ↓ to continue with accuracy calibration.</i>
Remove media Lower lever	You have attempted to load media while the lever at the right of the plotter was raised. <i>Remove the media, lower the lever, and reload media with the lever down.</i>
Replace cartridge(s) 	The cartridge indicated has a clogged nozzle. <i>Replace it to continue.</i>
Reseat cartridge(s) 	The cartridge indicated is badly seated. <i>Reseat it to continue.</i>
Roll misaligned Reload roll	Roll media is misaligned (skewed). <i>Reload media.</i>
RS-232 error Baud, parity	The RS-232-C interface is configured incorrectly. <i>Press Enter to clear the message from the front panel display. Check the baud rate and parity settings in the front panel, in the hardware configuration, and in your software to be sure they are all compatible.</i>

Message	Explanation and Action
Service cartridge(s) Continue →	Cartridge Check is on and an error has been detected. <i>Press ↑ if you want to service the cartridge(s) (replace or reseal). Press ↓ if you want to continue without servicing the cartridge(s).</i>
Sheet load →	<i>Press ↑ to load sheet media.</i>
Roll load →	<i>Press ↓ to load roll media.</i>
Sheet misaligned Reload sheet	Sheet media is misaligned (skewed). <i>Remove it and reload it so that the left and right edges being loaded into the plotter are square.</i> The leading edge must also be straight.
Sheet / Roll? Reload media	Either: You have chosen Sheet mode while loading roll media. <i>Reload media.</i> Or: You have loaded a sheet more than 51 inches (130 cm) long. <i>Trim sheet and reload.</i>
STATUS Accessing cartridge(s)	You have pressed the Access cartridge(s) button. The cartridge carriage is moving to the service cartridge(s) position so you can access it.
STATUS Aligning cartridge(s)	The plotter is aligning the cartridge(s).
STATUS Cancelling	You have pressed the Cancel button and the plotter is in the process of cancelling the procedure. <i>Continue when this message is no longer displayed.</i>
STATUS Checking media	The plotter is checking to see if media is properly positioned with respect to the perforated line of the entry platen.
STATUS Calibrating	The plotter is performing calibration.
STATUS Ink drying (xx m xx s)	The ink on your plot is drying. <i>Wait before removing the plot. If you remove it before the indicated time has passed, avoid smearing the ink.</i>
STATUS Loading roll	The plotter is loading roll media.
STATUS Loading sheet	The plotter is loading sheet media.
STATUS Maintenance advised	You are using the plotter more intensively than the recommended duty cycle and should <i>contact your local HP dealer or HP service engineer to arrange a service.</i> For the duty cycle specification, see page 11-4. If you choose to not to call for service, you may continue to use the plotter as normal, but may encounter operational or print-quality problems.
STATUS Measuring	The plotter is measuring the calibration plot you just loaded.

Message	Explanation and Action
STATUS Returning cartridge(s)	The cartridge carriage is returning to its station at the left of the plotter.
STATUS Roll feed edge trim	The plotter is trimming the edge of roll media.
STATUS Initializing	The plotter is doing an internal check during power-up.
STATUS Out of media	The plotter has received a file, is ready to print, but has no media loaded.
STATUS Printing	The plotter is printing.
STATUS Printing (Special)	The plotter is printing with a special print mode controlled by your software rather than by the plotter.
STATUS Ready for media	The plotter is ready for you to load media.
STATUS Ready	The plotter is ready to print.
STATUS Receiving	The plotter is receiving or has received plot data.
STATUS Testing cartridge(s)	The plotter is testing the cartridge(s) for problems, i.e., clogged cartridge or bad electrical connection (improper seating).
Switch power off Check cartridge path	<i>Turn off the plotter.</i> The cartridge carriage cannot move. The plotter may be jammed with media. <i>Check the media path and clear it if necessary. Then turn on the plotter.</i>
Switch power off Check paper path	<i>Turn off the plotter.</i> The drive roller cannot move or the roll feed spindle cannot freely rotate. The plotter may be jammed with media. <i>Check the media path and clear it if necessary. Then turn on the plotter.</i>
System error XXXXXX	An internal error has occurred and a system error number is displayed. <i>Press Enter; this may clear the error and allow you to continue. If you cannot continue, turn off the plotter, then turn it on again. If you still see the system error message, record the system error number and have the plotter serviced. For support details, see page 9-25.</i>
Wrong cartridge type	You have loaded one or more incompatible cartridges. <i>Replace the cartridges with those appropriate for this plotter.</i>

Plotter Specifications	11-2
Interface Specifications	11-7
Interface Cables	11-8
Regulatory Notices	11-10
Ordering Accessories	11-13



Reference

Plotter Specifications



Plotter Specifications

C4705A and C4708A = D/A1-size plotter.

C4706A and C4709A = E/A0-size plotter.

Functional Specifications				
Cartridges 700 750C Plus	HP DesignJet 700, one black. For part number, see page 11-15.			
	HP DesignJet 750C Plus. yellow, cyan, magenta and black. For part numbers, see page 11-15.			
Media sizes E/A0-size plotter D/A1-size plotter	<i>Width (carriage axis)</i>		<i>Length (paper axis)</i>	
	<i>Minimum</i>	<i>Maximum</i>	<i>Minimum</i>	<i>Maximum</i>
	190 mm (7.5 in)	917 mm (36.1 in)	210 mm (8.3 in)	Maximum length of long axis plot on roll media: 15.2 m (50 ft) 1.32 m (52 in) sheet media
		625 mm (24.6 in)		
Media types See also Supplies Source catalog and (in Europe and USA) Media Reference Guide For alternative names, HP commercial names and physical characteristics of these media types, see chapter 3.	<i>Monochrome</i>		<i>Color</i>	
	Opaque bond Translucent bond Natural tracing paper Vellum Coated paper Matte film Clear film Heavy coated paper		Opaque bond (CAD drawings only) Natural tracing paper ¹ Vellum ¹ Coated paper Matte film Clear film Heavy coated paper	
750C Plus	High-gloss photo paper ²		High-gloss photo paper	
	Semi-gloss photo paper ²		Semi-gloss photo paper	
	High-gloss film ²		High-gloss film	
¹ CAD drawings only and HP media only. ² Monochrome drawings can be plotted on glossy media providing the color cartridges are loaded. Note. From time to time, new media types may become available. For up-to-date information, please contact your HP dealer or local HP Sales and Support Office.				

Functional Specifications			
Margins For plotting area (media size minus margins), see page 11-6	Leading edge:	<i>Normal</i>	<i>Smaller (roll media only)</i>
		17 mm (0.67 in)	10 mm (0.39 in)
	Trailing edge:	17 mm (0.67 in)	10 mm (0.39 in)
		Sides:	5 mm (0.2 in)
All measurements ± 2 mm (0.08 in).			
Resolution 700 750C Plus	<i>Print Quality</i>		<i>Resolution</i>
	Fast print quality:		300 x 300 dpi.
	Normal print quality:		600 x 600 dpi.
	Best print quality:		600 x 600 dpi.
	<i>Color/Mono set to: Mono</i>		<i>Color/Mono set to: Color</i>
	Fast print quality:	300 x 300 dpi.	Fast print quality: 300 x 300 dpi.
	Normal print quality:	600 x 600 dpi. ¹	Normal print quality: 300 x 300 dpi.
	Best print quality:	600 x 600 dpi. ¹	Best print quality: 600 x 600 dpi. ²
Accuracy (Maximum accumulated error)	± 0.38 mm (0.015 in) or $\pm 0.2\%$ of the specified vector length, whichever is greater, at 23°C (73°F), 50–60% relative humidity, on HP Matte Film.		
Programming languages supported	HP-GL (7586B), HP-GL/2, HP RTL, P.JL		
¹ Except for glossy media types, on which the resolution is always 300 dpi. ² Addressable dpi (depending on the type of image your application software has created). Only on coated paper, matte film and opaque bond media.			

Physical Specifications				
	<i>Weight</i> (packed)	<i>Length</i> (unpacked)	<i>Depth</i> (unpacked)	<i>Height</i> (unpacked)
With stand				
E/A0-size plotter	60 kg (132 lb)	1370 mm (54.0 in)	675 mm (26.6 in)	1200 mm (47.3 in)
D/A1-size plotter	49 kg (108 lb)	1072 mm (42.2 in)	675 mm (26.6 in)	1200 mm (47.3 in)
Without stand				
E/A0-size plotter	42 kg (93 lb)			
D/A1-size plotter	32 kg (71 lb)			

Plotter Specifications

Environmental Specifications		
Operational	Mechanical and electrical:	0 to 55°C (32 to 131°F) @ 5-95% relative humidity
	With cartridges and media:	15 to 35°C (59 to 95°F) @ 20-80% relative humidity
	For optimal print quality and media handling:	15 to 30°C (59 to 86°F) @ 20-80% relative humidity
Storage	Plotter and media:	-40 to 70°C (-40 to 158°F) @ 20-80% relative humidity
	Cartridges:	-40 to 60°C (-40 to 140°F) @ 20-90% relative humidity

Power Specifications	
Source	100–240V ac \pm 10%. Autoranging.
Frequency	50–60 Hz
Consumption	140 W max. (2.0 A max.)
Energy Star rating (USA)	Maximum power in idle state: 45 watts

Acoustic Specifications		
Operating sound pressure	42 dB(A)	(From a one-meter bystander position and with Print Quality set to Best .)
Idle sound pressure	<20 dB(A)	

Duty Cycle		
Recommended maximum number of plots per day	Medium density E/A0 CAD plots:	20
	Medium density E/A0 image plots:	12

Plotter Specifications

Plotting Area (= Media Size Minus Margins).					
	Media size (and orientation of media)	Plotting area (width x height) by orientation of drawing			
		inches		millimeters	
		landscape	portrait	landscape	portrait
ANSI media	A (portrait)	9.66 x 8.1	8.1 x 9.66	245 x 205	205 x 245
	A (landscape)	10.6 x 7.16	7.16 x 10.6	269 x 182	182 x 269
	B (portrait)	15.7 x 10.6	10.6 x 15.7	397 x 269	269 x 397
	B (landscape)	16.6 x 9.66	9.66 x 16.6	421 x 245	245 x 421
	C (portrait)	20.7 x 16.6	16.6 x 20.7	524 x 421	421 x 524
	C (landscape)	20.6 x 15.7	15.7 x 20.6	549 x 398	398 x 549
	D (portrait)	32.7 x 21.6	21.6 x 32.7	829 x 548	548 x 829
	D (landscape)	33.6 x 20.7	20.7 x 33.6	854 x 525	525 x 854
	E (portrait)	42.7 x 33.6	33.6 x 42.7	1084 x 854	854 x 1084
Architectural media	A (portrait)	10.7 x 8.60	8.6 x 10.7	271 x 219	219 x 271
	A (landscape)	11.6 x 7.66	7.66 x 11.6	295 x 195	195 x 295
	B (portrait)	16.7 x 11.6	11.6 x 16.7	423 x 295	295 x 423
	B (landscape)	17.6 x 10.7	10.7 x 17.6	447 x 271	271 x 447
	C (portrait)	22.7 x 17.6	17.6 x 22.7	576 x 447	447 x 576
	C (landscape)	23.6 x 16.7	16.7 x 23.6	600 x 423	423 x 600
	D (portrait)	34.7 x 23.6	23.6 x 34.7	880 x 600	600 x 880
	D (landscape)	35.6 x 22.7	22.7 x 35.6	904 x 576	576 x 904
	E1 (portrait)	40.7 x 29.6	29.6 x 40.7	1033 x 752	752 x 1033
	E (portrait)	46.7 x 35.6	35.6 x 46.7	1185 x 904	904 x 1185
ISO media	A4 (portrait)	10.3 x 7.87	7.87 x 10.3	263 x 200	200 x 263
	A4 (landscape)	11.3 x 6.93	6.93 x 11.3	287 x 176	176 x 287
	A3 (portrait)	15.2 x 11.3	11.3 x 15.2	386 x 287	287 x 386
	A3 (landscape)	16.1 x 10.3	10.3 x 16.1	410 x 263	263 x 410
	A2 (portrait)	22.0 x 16.1	16.1 x 22.0	560 x 410	410 x 560
	A2 (landscape)	23.0 x 15.2	15.2 x 23.0	584 x 386	386 x 584
	A1 (portrait)	31.8 x 23.0	23.0 x 31.8	807 x 584	584 x 807
	A1 (landscape)	32.7 x 22.0	22.0 x 32.7	831 x 560	560 x 831
	A0 (portrait)	45.5 x 32.7	32.7 x 45.5	1155 x 831	831 x 1155

For margins, see page 11-3. This table is calculated with normal margins.



Interface Specifications

Below are the parallel and serial interface specifications.

<p>Parallel (Bi-Tronics/Centronics) Interface</p> <p>The connector on the plotter is 36-pin female.</p> <p>Most existing parallel cables support Bi-Tronics communication, but for use with this plotter, the cable <i>must</i> meet the specification in this table.</p>	Pin	Wire/Signal Name	Source
	1	$\overline{\text{Strobe}}$	computer
	2 ... 9	D0 ... D7 (data lines)	both
	10	$\overline{\text{Ack}}$	plotter
	11	Busy	plotter
	12	PError	plotter
	13	Select (SelectOut)	plotter
	14	$\overline{\text{AutoFd}}$	computer
	16	GND	
	19 ... 30	GND	
	31	$\overline{\text{Init}}$	computer
	32	$\overline{\text{Fault}}$	plotter
36	$\overline{\text{SelectIn}}$	computer	
<p>Serial (RS-232-C) Interface</p> <p>The connector on the plotter is 25-pin female.</p> <p>The plotter is configured as DTE (data terminal equipment).</p> <p>Data is transmitted on Pin 2 and received on Pin 3.</p>	Pin	Wire/Signal Name	Source
	1	Protective Ground	
	2	Transmitted Data	DTE
	3	Received Data	DCE
	4	Request to Send	DTE
	6	Data Set Ready	DCE
	7	Signal Ground	
	20	Data Terminal Ready	DTE

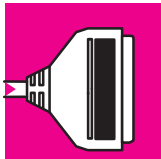

Interface Cables

Cables for PCs			
Interface type Computer	HP part number	Cable length	Connector type at computer end of cable
<i>Parallel (Bi-Tronics/Centronics) Interface</i> All	C2951A	3.0 m (9.8 ft)	25-pin male
	C2950A	2.1 m (6.9 ft)	25-pin male
<i>Serial (RS-232-C) Interface</i> HP Vectra or HP 24541A/B serial-interface card (9-pin connector) IBM AT and compatibles using 9-pin serial connectors	24542G	3.0 m (9.8 ft)	9-pin female
HP Vectra PC with HP 24541A/B dual serial-interface card using the 25-pin connector	13242G	5.0 m (16.4 ft)	25-pin male
IBM PC, PC/XT, PC/AT, PS/1, PS/2 and compatibles	C2913A	1.2 m (3.9 ft)	25-pin female
	17255D	1.2 m (3.9 ft)	25-pin female

Cables for Macintoshes			
Interface type Computer	HP part number	Cable length	Connector type at computer end of cable
<i>Serial (RS-232-C) Interface</i> Apple Macintosh Plus, SE, II Series, Classic, LC family, Quadra family, PowerBook, PowerMac	17302A	1.5 m (4.9 ft)	8-pin male mini-DIN

Cables for Unix systems			
Interface type Computer	HP part number	Cable length	Connector type at computer end of cable
<i>Parallel (Bi-Tronics/Centronics) Interface</i> All	C2951A	3.0 m (9.8 ft)	25-pin male
	C2950A	2.1 m (6.9 ft)	25-pin male
<i>Serial (RS-232-C) Interface</i> HP 9000 workstations using 9-pin connectors.	24542G	3.0 m (9.8 ft)	9-pin female
HP Apollo workstation using an SPE (Serial/Parallel Expansion) option and supplied adapter cable	13242G	5.0 m (16.4 ft)	25-pin male
Sun workstation Note: You may need a Sun serial adapter cable to convert the DIN connector found on certain Sun SPARC stations to the 25-pin connector on the HP cable. Contact your Sun dealer for part numbers.	13242G	5.0 m (16.4 ft)	25-pin male

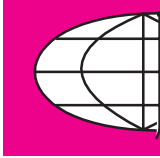

Regulatory Notices

To Obtain a Material Safety Data Sheet (MSDS)

You can obtain current Material Safety Data Sheets for the print cartridges used in the plotter (HP Part numbers 51644C [cyan], 51644M [magenta], 51644Y [yellow] and 51645A [black]) by mailing a request to this address:

Hewlett-Packard Customer Information Center, 19310 Pruneridge Avenue,
Dept. MSDS, Cupertino, CA 95014, U.S.A.

Electromagnetic Compatibility (EMC)

FCC Statement
(U.S.A.)

The U.S. Federal Communications Commission (in 47 cfr 15.105) has specified that the following notice be brought to the attention of users of this product.

This equipment has been tested and found to comply with the limits for a Class B digital device, pursuant to part 15 of the FCC Rules. These limits are designed to provide reasonable protection against harmful interference in a residential installation. This equipment generates, uses and can radiate radio frequency energy and, if not installed and used in accordance with the instructions, may cause harmful interference to radio communications. However, there is no guarantee that interference will not occur in a particular installation. If this equipment does cause harmful interference to radio or television reception, which can be determined by turning the equipment off and on, the user is encouraged to try and correct the interferences by one or more of the following measures:

- Reorient the receiving antenna
- Increase the separation between the equipment and the receiver
- Connect the equipment into an outlet on a circuit different from that to which the receiver is connected
- Consult the dealer or an experienced radio/TV technician for help

The user may find useful the following booklet prepared by the FCC: “How to Identify and Resolve Radio-TV Interference Problems”. This booklet is available from the US Government Printing Office, Washington, DC 20402, Stock No. 004-000-00345-4.

CAUTION

Pursuant to Part 15.21 of the FCC Rules, any changes or modifications to this equipment not expressly approved by the Hewlett-Packard Company, may cause harmful interference and void the FCC authorization to operate this equipment.

DOC statement (Canada)	Le présent appareil numérique n'émet pas de bruits radioélectriques dépassant les limites applicables aux appareils numériques de la classe B prescrites dans le Règlement sur le Brouillage Radioélectrique édicté par le ministère des Communications du Canada.
	This digital apparatus does not exceed the Class B limits for radio noise emissions from digital apparatus set out in the Radio Interference Regulations of the Canadian Department of Communications.
VCCI-2 (Japan)	この装置は、情報処理装置等電波障害自主規制協議会（VCCI）の基準に基づく第二種情報技術装置です。この装置は、家庭環境で使用することを目的としていますが、この装置がラジオやテレビジョン受信機に近接して使用されると、受信障害を引き起こすことがあります。 取り扱い説明書に従って正しい取り扱いをして下さい。
Korean EMI statement	이 기기는 업무용으로 전자파장애검정을 받은 기기이오니 판매자 또는 사용자는 이점을 주의하시기 바라며, 만약 잘못 구입하였을 때에는 구입한 곳에서 비업무용으로 교환하시기 바랍니다.
Geräuschemission (Germany)	LpA < 70 dB am Arbeitsplatz im Normalbetrieb nach DIN 45635 T. 19
Telecommunications Statement	
Tele- communications General Approval (UK)	The HP DesignJet 700 and the HP DesignJet 750C Plus plotters, models C4705A, C4706A, C4708A and C4709A are approved under Approval Number NS/G/1234/5/100003 for indirect connection to public telecommunication systems within the United Kingdom.

DECLARATION OF CONFORMITY

according to ISO/IEC Guide 22 and EN 45014

Manufacturer's Name: Hewlett-Packard Española S.A.
Manufacturer's Address: Hewlett-Packard Española S.A.
 BARCELONA DIVISION
 Avda. Graells, 501
 08190 Sant Cugat del Vallès
 Barcelona, Spain

declares that the product
Product Name: InkJet Plotter
Model Numbers: HP C4705A, HP C4706A, C4708A, C4709A
Product Accessory: HP JetDirect network interface card ⁽²⁾

conforms to the following Product Specifications:

Safety: IEC 950: 1991 + A1, A2 / EN 60950 (1992) + A1, A2
 CSA C22.2 No. 950 (1993)
 UL 1950 (1993)
 EMKO-TSE(74)DK207/94
 NOM-019-SCFI-1993

EMC: CISPR 22: 1993 / EN 55022 (1994): Class B⁽¹⁾
 EN 50082-1 (1992)
 IEC 801-2: 1991 / prEN 55024-2 (1992): 4KV CD
 8KV AD
 IEC 801-3: 1984 / prEN 55024-3 (1991): 3 V/m
 IEC 801-4: 1988 / prEN 55024-4 (1992): 1KV Power Lines
 0.5KV Signal Lines
 FCC Part 15 – Class B / DOC-B / VCCI-2 / RRL-A

Supplementary Information:

The product herewith complies with the requirements of the Low Voltage Directive 73/23/EEC and the EMC Directive 89/336/EEC, and carries the CE marking accordingly.

⁽¹⁾ The product was tested with a Hewlett-Packard system, consisting of: a Vectra 486/33M personal computer, VGA monitor, keyboard, mouse, and a Printer DeskJet 550C as the second peripheral.

⁽²⁾ Product options with interface cards exhibit Class A operation.

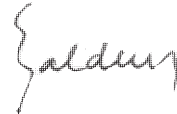

Jordi Balderas,
 Quality Engineering Manager

Sant Cugat del Vallès (Barcelona), September 1st, 1996

European Contact: Your local Hewlett-Packard Sales and Service Office or Hewlett-Packard GmbH, Department ZQ/Standards Europe, Herrenberger Strasse 130, D-71034 Boeblingen, Germany (fax: (+49) 7031 143143).



Ordering Accessories

HP Part Number

Cables

See page 11-8

Documentation

User's Guide and Quick Reference Guide	Chinese	C4705-60030
	English	C4705-60021
	French	C4705-60025
	German	C4705-60024
	Italian	C4705-60027
	Japanese	C4705-60028
	Korean	C4705-60022
	Portuguese	C4705-60029
	Spanish	C4705-60026
Taiwanese	C4705-60023	
Software Application Notes	English	C4705-90006
Hewlett-Packard Support Services	Multi	(1)
HP-GL/2 and RTL Programmer's Reference Guide	English	5959-9733 ⁽²⁾
The Product Comparison Guide for HP-GL/2 and HP RTL Peripherals	English	5959-9734 ⁽²⁾
PJL Technical Reference Manual	English	5961-0938

¹ This item is updated regularly. For details of the latest version available, please contact your HP dealer or sales representative.

² See note on page 11-16.

Ordering Accessories

To achieve the best performance from your plotter, we recommend you only use genuine *Hewlett-Packard* accessories and supplies, whose reliability and performance have been thoroughly tested to give trouble-free performance. For Example:

- HP drivers are developed to support all the latest features and to optimize print quality and your plotters performance.
- HP memory expansion modules are thoroughly tested to give you maximum performance.
- HP ink cartridges and media supplies are developed for optimal print quality.

Drivers

HP Part Number

Latest versions of the following were shipped with this plotter:

HP plotter drivers for AutoCAD for DOS and AutoCAD for Windows	(1)
--	-----

HP plotter driver for Microsoft Windows	(1)
---	-----

Available as options are:

PostScript Upgrade Kit (ROM SIMM and driver)	C4707A
---	--------

Media Supplies

Supplies Source Catalog (The latest edition was shipped with this plotter)	(1)
---	-----

Media Reference Guide (The latest edition was shipped with this plotter in Europe and USA only.)	(1)
---	-----

Memory Expansion Modules

All SIMMs on the right are 72-pin, 36-bit.	4 MB	C3132A
4/8 MB: 80 nanoseconds.	8 MB	C3133A
16/32 MB: 70 nanoseconds	16 MB	D2297A or C3146A

For up-to-date details of any memory expansion modules other than those listed here, contact your local authorized HP dealer.	32 MB	D3578A
---	-------	--------

¹ This item is updated regularly. For details of the latest version available, please contact your HP dealer or sales representative, or, for drivers, use one of the support resources for your area listed in the *Hewlett-Packard Support Services Booklet* shipped with your plotter.

**HP Part
Number**

Network Interface

Hewlett-Packard supply a variety of internal or external, single or multi port Network Interfaces which are constantly being upgraded. Contact your Dealer or Hewlett-Packard support services for current HP part numbers suitable for your application.

Print Cartridges

Although other cartridges may appear to fit in the stalls, use only these part numbers.

Yellow	51644Y
Cyan	51644C
Magenta	51644M
Black	51645A

Spindle Assembly

E/A0-size	C3173A
D/A1-size	C3172A

HP-GL/2 and HP RTL Programming Information

The *HP-GL/2 and HP RTL Reference Guide* provides complete explanations and examples of the HP-GL/2 and HP RTL graphic and interface instructions. If you are writing an HP-GL/2 or RTL driver for your plotter, you will find this guide an invaluable source of general instruction information. It is published by Addison-Wesley Publishing Company and you can order it through most book stores (ISBN 0-201-63325-6).

For specific parameter information, refer to *The Product Comparison Guide for HP-GL/2 and HP RTL Peripherals*, which you can order through your HP Sales office.

How to Order Supplies and Accessories

You can order supplies and accessories in any of the following ways:

- Call your local authorized HP dealer.
- Contact your local HP Sales and Support office.
- Refer to the *Hewlett-Packard Support Services booklet* that was supplied with your plotter. In the United States, the Direct Ordering number is (800) 538 8787.



Glossary

ac Alternating current.

addressable dpi A resolution higher than nominal value of the cartridges, giving a finer grid on which the plotter can selectively position dots and improve print quality.

ANSI size An American standard paper size; e.g. D, E, etc.

application The software you use.

bail The black metal bar inside the plotter, which holds the media in place.

baud rate The data transmission rate in a serial interface between a computer and a device, in bits per second.

Bi-tronics A standard for the parallel interface between computer and device, compatible with Centronics.

CAD Computer-aided design.

cartridge Print cartridge, containing ink.

Centronics A standard for the parallel interface between computer and device. Compatible with Bi-tronics.

clear film See-through, polyester media type.

clipping Losing part of a drawing at the edges.

CMYK Cyan, magenta, yellow and black. The colors of the plotter's four inks, and also a standard color model.

coated paper Good quality paper coated on one side for inkjet printing.

dc Direct current.

default A value or condition that is assumed if no other value or condition is specified.

device An external item connected to the computer: printer, plotter, tape drive etc. Your HP DesignJet is a device.

dpi Dots per inch, a measure of print resolution.

driver The software that controls the communication between a computer and a device.

front panel The control panel on the front of the plotter.

front-panel menus The options in the front-panel display.

GIS Geographical information system (mapping software).

graphics language A programming language telling a print device how to output graphic data.

grayscale Shades of gray to represent colors.

high-gloss film A glossy, opaque, polyester media type.

-
- high-gloss photo** A glossy, opaque photographic paper.
- HP-GL** One of Hewlett-Packard's standard graphics languages for plotters and printers. Produces vector data. Forerunner to HP-GL/2.
- HP-GL/2** One of Hewlett-Packard's standard graphics languages for plotters and printers. Produces vector data. Newer than HP-GL.
- I/O** Input/output. The transmission of data between a computer and a device.
- inked area** The smallest rectangle that contains all the content of the drawing, while maintaining the drawings relative dimensions.
- ISO size** An international standard paper size; e.g. A1, A2, etc.
- JIS size** A Japanese standard paper size.
- LAN** Local area network.
- long-axis plotting** Plotting a page whose X-axis (the axis vertical to the plotter as you look at it from the front) is longer than a standard page size.
- margin** The space around the page added by the plotter to separate one page from another and to avoid printing right to the edge of the media.
- matte** Not glossy.
- matte film** Opaque, polyester media type (not glossy).
- media** The material, usually paper, onto which the plotter prints.
- media bin** The media catcher situated below the plotter.
- MIO** Modular input/output. Refers to the plotter's network interface.
- nesting** Placing two or more plots side-by-side on the media to avoid waste.
- opaque bond** A matte paper media.
- palette** A set of logical pens defined by color and width.
- PJL** Printer job language. A programming language that controls jobs going to a printer or plotter.
- PML** Printer management language.
- parallel interface** A type of interface between computer and device. Generally faster than a serial interface.
- pen** Even though the plotter has no physical pens, the lines it draws match the attributes of a pen.
- platen** The exterior part of the plotter on which the media rests before going into the media-entry slot.
- plotting area** Page size minus margins.
-

Glossary

PostScript A standard page markup language, commonly used by graphics and desktop publishing software applications.

queueing Placing each page of each file received by the device in chronological order of receipt (unless changed by prioritizing), before and after printing.

parity An error-checking method in a serial interface between a computer and a device.

raster A method for defining an image, in terms of dots rather than lines. Raster data typically needs more memory than vector data.

RGB Red, green and blue. A standard color model.

RS-232-C A serial interface standard.

RTL One of Hewlett-Packard's standard graphics languages for plotters and printers. Produces raster data.

ROM SIMM A physical module containing read-only data, to provide plotter upgrades. They are installed in the back of the plotter.

semi-gloss photo A semi glossy, opaque photographic paper.

serial interface A type of interface between computer and device. Generally slower than a parallel interface.

spindle The rod which holds the roll of media.

tracing paper A semi-opaque matte paper type.

translucent bond A semi-opaque matte paper type.

vector A line. A method for defining an image, in terms of lines rather than dots. Vector data typically needs less memory than raster data.

vellum Cotton-fiber-based, semi-opaque matte media type.

X-axis The vertical axis, as you look at the plotter from the front.

Y-axis The horizontal axis, as you look at the plotter from the front.

Index

A

Access Cartridge(s) key, 1-21, 3-28
 problems, 9-7
accessories, 1-5–1-6
 list, 11-13
 ordering, 11-16
accuracy, specification, 11-3
acoustic specifications, 11-4
action keys, 2-2
addressable 600 dpi, Sharp lines, 5-15
addressable dpi, 5-14
Apollo, cables to connect, 11-9
Apple, cables to connect, 11-8
archiving plots, 3-9
area fill problems, 9-19
AutoCAD, drivers, 11-14
automatic cutter, problems with,
 9-5–9-6

B

banding problems, 9-20
Bi-Tronics interface, 11-7
black cartridge only, operating with,
 1-20
blank plot, 9-10
bleeding lines, 9-19
blurred lines, 9-19
BOOTP, 1-40
buttons. *See* keys

C

cables
 ordering, 11-8–11-9
 power, 1-5
 problems, 9-9
 supplied/not supplied, 1-5
calibration. *See* recalibration
Cancel key, 6-2
cancelling a plot, 6-2
cartridge alignment procedure, 3-30
Cartridge check, 3-26
cartridge stalls, 1-20–1-21, 3-29–3-31
cartridges
 before replacing, 3-27
 black only, 1-20
 colors, 1-5, 1-20–1-21, 3-29–3-31

 environmental specifications, 11-4
 ink level, 3-26
 loading, 1-20–1-23
 ordering, 11-15
 part numbers, 11-15
 problems, 9-18
 problems with, 9-7
 removing tab, 1-22, 3-30
 replacing, 3-26–3-31
 supplied, 1-5
choosing media, 3-2–3-7
cleaning the plotter, 8-2
clearing the media path, 3-25
clipped plot, 9-12
clipping
 and page size, 4-5
 and Rotate, 4-8
CMYK, 5-4
color plotting, media type for, 11-2,
 11-3
color problems, 9-16–9-21
color-vision deficiencies, advice for
 users with, 1-20, 3-29
Color/Mono key, 5-10
color/monochrome switching, 5-10
colors
 CMYK, 5-4
 RGB, 5-4
communications, problems, 9-9
compensating for poorly cut media,
 3-21
components of plotter, xvii–xix
computer, connection to, 1-27–1-30
configuration
 changing, 1-30–1-34
 current front–panel, 7-3
 current overall, 7-2
 plot, current, 2-3
 setting parameter values, 2-8
connector
 parallel, 1-28
 serial, 1-28
Copies, 6-8
CorelDRAW!, 5-15, 9-15
Create pattern, 7-6
curl, on media, 9-5
Current Configuration Plot, 5-3, 7-3

current configuration plot, 2-3
cutting
 and margins, 4-6
 immediately after plotting, 6-2
 problems with, 9-5–9-6

D

darkness of plot, adjusting, 5-8
Declaration of Conformity (EC),
 11-12
default page margins, 4-6
Define palette, 5-5
Delete page, 6-7
demonstration plot, 1-24–1-26
Demos, 1-25
device lists, 1-38
dimensions of plotter, 11-3
display, front panel, 2-3
display keys, 2-3, 2-7
documentation, 11-13, 11-16
 map, D-1
down arrow key, 2-7
drivers, 1-35, 1-37, 11-14
drying time, 3-22–3-23
 adjusting, 3-23

E

electrical specifications, 11-4
electrostatic precautions, 1-8
EMC (electromagnetic compatibility),
 11-5, 11-10
Enter key, 2-7

F

file size and memory usage, 6-6
filled area problems, 9-19
film, 11-2, 11-3
firmware, supplied, 1-37
Form Feed and Cut key, 3-25, 6-2,
 6-4
 to clear the media path, 9-8
front panel, 2-2
 action keys, 2-2
 display section, 2-3
 messages, 10-2–10-6
 plotting mode keys, 2-2

Index

problems with, 9-21–9-22
status lights, 2-2
Front Panel Menus plot, printing, 2-5

G

gaps in lines, 9-16, 9-17
gaps in solid fill areas, 9-16
getting help, 9-25
graphics languages, 11-3
and networks, 7-8
changing, 7-7

H

heavyweight media, 11-2, 11-3
help, 9-25–9-27
HP DesignJets, other, 1-38
HP JetDirect, 1-27
HP JetDirect Print Server, 7-12
HP RTL, 7-7
documentation, 11-13, 11-16
HP Special Inkjet paper, 11-2, 11-3
HP-GL (7586B), 7-7
HP-GL/2, 7-7
documentation, 11-13, 11-16
humidity, 11-4

I

I/O Setup, 7-9
I/O timeout, changing, 7-9
ink problems, 9-16–9-21
installation. *See* setting up
interface
parallel specifications, 11-7
problems, 9-9
serial, 9-3
serial specifications, 11-7
specifications, 11-7–11-8
with application software, 9-3

J

jagged lines, 9-18
jammed media, 9-8–9-9

K

keys

Access Cartridge(s), 1-21, 3-28
action, 2-2
Cancel, 6-2
Color/Mono, 5-10
display, 2-3, 2-7
down arrow, 2-7
Enter, 2-7
Form Feed and Cut, 3-25, 6-2, 6-4
Pause, 6-3
plotting mode, 2-2
Previous, 2-7
Print Quality, 5-13
Replot, 6-9
up arrow, 2-7

L

LAN, 1-27
Lang, 7-7
languages (graphics), 11-3
and networks, 7-8
changing, 7-7
documentation, 11-16
languages (human)
changing, 1-9
manuals available in, 11-13
lever, for media jam, 9-8–9-9
light, effect of, 3-9
Lightness (of plot), adjusting, 5-8
line quality problems, 9-16–9-21
loading media
roll, 3-10–3-17
sheet, 3-18–3-21
Local Area Network, 1-27
logical pens, settings, 5-2–5-5
long-axis plots, 9-12

M

Macintosh, cables to connect, 11-8
Maintenance advised, 8-3
managing plots
before printing, 6-4
during printing or drying, 6-2
manuals, 11-13, 11-16, D-1
margins, 4-6, 11-3
and cutting, 4-6
and nesting, 6-13

margins (plotting areas), 11-6
maximum media sizes, 11-2
Measure pattern, 7-6
media
adjusting drying time, 3-23
and print quality, 3-6
care of, 3-9
cost and color support, 3-5
curled, 9-5
drying time, 3-22
environmental specifications, 11-4
guidelines for loading, 3-9
handling, 3-9
handling problems, 9-4
important points, 3-2
leading edge, 9-5
loading problems, 9-4
loading roll, 3-10–3-17
loading sheet, 3-18–3-21
physical characteristics, 3-4
poorly cut, 3-21
roll. *See* roll media
selecting, 3-2–3-7, 3-15–3-16,
3-19–3-20
sheet orientation, 3-18
sizes and plotting areas, 11-6
sizes supported, 11-2
skew tolerance, 3-21
supplies, 11-14
trimming roll, 3-14
type for application, 3-7
types supported, 3-3, 11-2
unloading, 3-22–3-25
media bin, 3-9
stacking problems, 9-6
Media bypass. *See* skew tolerance
media jam, 9-8–9-9
Media Reference Guide, 11-14
media types supported, 11-3
memory, xvi, 11-14
expansion modules, 11-14
replot function, 6-9
memory expansion modules, 1-5
installing, 1-6–1-9
memory usage and file size, 6-6
menu graphics, 2-9
Menu mode, changing, 1-31

-
- menu plot, printing, 2-5
 - menu system
 - entering, 2-6
 - navigating, 2-7–2-9
 - navigation examples, 2-11–2-13
 - printing, 2-5
 - Merge, 5-7
 - messages, front panel, 10-2–10-6
 - Microsoft Windows, driver, 11-14
 - minimum media sizes, 11-2
 - Mirroring an image, 4-10
 - monochrome, printing color in, 5-9
 - Monochrome plotting, media types for, 11-3
 - monochrome/color switching, 5-10
 - Move to top, 6-7
 - MSDS (Material Safety Data Sheet), 11-10

 - N**
 - Nest, 6-12
 - Nest wait, 6-12
 - nesting
 - algorithms, 6-12
 - and margins, 6-13
 - and page size, 6-13
 - and Rotate, 6-13
 - interaction with queue, 6-12
 - optimizing, 6-13
 - order, 6-12
 - overview, 6-10
 - requirements, 6-11
 - sets, 6-12
 - network
 - connections, 1-27
 - interface, ordering, 11-15
 - no plot?, 9-23
 - Normal usage, 8-3
 - nozzle blockages, 9-16

 - O**
 - options
 - See also* accessories
 - memory, 1-5
 - ordering accessories, 11-13
 - orientation
 - roll media, 4-8
 - sheet media, 4-8
 - overlapping lines, treatment of, 5-7
 - overlay of one plot on another, 9-14

 - P**
 - page
 - copying in a queue, 6-8
 - deleting from a queue, 6-7
 - identifying in a queue, 6-6
 - prioritizing in a queue, 6-7
 - Page format, Rotate. *See* solving problems
 - Page ID, 6-6
 - page information, 6-7
 - page margins, 4-6
 - page size, 4-2–4-5
 - adjusting, 4-3–4-4
 - and clipping, 4-5
 - and nesting, 4-5, 6-13
 - Palette, 5-4, 5-5, 5-6
 - palette
 - changing current selection, 5-6
 - changing settings, 5-5
 - palette plot, 5-4, 5-5
 - paper, clearing jammed. *See* media
 - parameter values, setting, 2-8
 - part numbers, 11-13
 - Pause key, 6-3
 - pausing between plots, 6-3
 - PCs, cables to connect, 11-8
 - pen, settings, seem to have no effect, 9-14
 - pens, limiting exposure, 3-27
 - pens (logical)
 - colors, 5-4
 - current palette settings, 5-3
 - settings, 5-2–5-5
 - pens (physical). *See* cartridges
 - physical specifications, 11-3
 - pin-outs, 11-7–11-10
 - PJL, 7-8
 - PJL documentation, 11-13
 - plot
 - blank, 9-10
 - cancelling, 6-2
 - clipped, 9-12
 - content problems, 9-10–9-16
 - distorted, 9-14
 - management before printing, 6-4
 - management during printing, 6-2
 - position problems, 9-10–9-16
 - unexpected, 9-15
 - plot appearance, controlling, 5-2
 - plot color, quality (DesignJet 750C Plus), 9-15
 - plotter
 - components, xvii–xix
 - views of, xvii–xix
 - plotting area, 11-6
 - plotting mode keys, 2-2
 - polyester film, 11-2, 11-3
 - ports
 - on computer, 1-28
 - on plotter, 1-28
 - PostScript option, 7-11
 - power
 - cord, 1-5, 1-9
 - socket, 1-9
 - supply, 1-9
 - switch, 1-10
 - power specifications, 11-4
 - Previous key, 2-7
 - print cartridges. *See* cartridges
 - Print quality, Sharp lines, 5-14
 - print quality
 - changing, 5-13
 - choosing, 5-11
 - Print Quality key, 5-13
 - print quality problems, 9-16–9-21
 - print spooler, UNIX, 1-40
 - problem-solving. *See* troubleshooting
 - programming documentation, 11-16
 - programming languages, 11-3

 - Q**
 - quality problems, 9-16–9-21
 - Queue, 6-5
 - copy page in, 6-8
 - deleting a page from, 6-7
 - identifying a page in, 6-6
 - management, 6-5
-

Index

page information, 6-7
prioritizing a page, 6-7
queue, interaction with nesting, 6-12
queueing, 6-5

R

Recalibrate, 7-6
recalibration
 for accuracy, 7-5–7-7
 restoring factory settings, 7-6
Receiving light, 1-26
regulations
 Declaration of Conformity (EC),
 11-12
 EMC, 11-5
 notices, 11-10–11-13
 safety, 11-5
regulatory notices, 11-10–11-13
replacing cartridges, 3-26
Replot, 6-9
Restore factory, 7-6
RGB, 5-4
roll media
 handling, 3-9
 loading, 3-10–3-17
 stacking problems, 9-6
 trimming, 3-14
Rotate
 and clipping, 4-8
 and nesting, 6-13
 interaction with software, 4-9
 problems with, 9-21
Rotating a plot, 4-7–4-9
RS-232-C specifications, 11-7
RS-232-C, 7-9
RTL documentation, 11-13, 11-16

S

safety, MSDS, 11-10
safety specifications, 11-5
Samples, 1-25
selecting media, 3-15–3-16,
 3-19–3-20
serial interface
 changing settings, 7-9
 configuring, 1-29–1-34

Service config, 7-5, 8-4
 plot, 8-4
setting up
 checklist, 1-4
 fast track (quick setup), 1-2
 full instructions, 1-4–1-44
 items required, 1-5
shading, monochrome, 5-5
shadows of color, 9-18
Sharp lines, 5-14
 troubleshooting, 9-15
 with CorelDRAW!, 5-15, 9-15
sheet media
 loading, 3-18–3-21
 orientation, 3-18
sheet sizes supported, 11-2
side-by-side plots. *See* nesting
signal specifications, 11-7
Size, 4-4
size, plotter, 11-3
sizes of media supported, 11-2
skew tolerance, 3-21
slow plotting, 9-23
smears, 9-20
software
 setting up, 1-35–1-38
 supplied, 1-37
Software Application Notes, 11-13
sound levels, 11-4
special inkjet paper, 11-2, 11-3
specifications, 11-2–11-7
 acoustic, 11-4
 electromagnetic, 11-5
 EMC, 11-5
 environmental, 11-4
 functional, 11-2
 interface, 11-7–11-8
 physical, 11-3
 power, 11-4
 safety, 11-5
speed problems, 9-23
Statistics, 6-7, 7-2
status lights, 2-2
storing plots, 3-9
Sun, cables to connect, 11-9
supplies. *See* accessories
Supplies Source Catalog, 11-14

support, 9-25–9-27
support services, 11-13

T

temperature, 11-4
test plot, 1-39
testing the plotter, 9-3
TFTP, 1-40
timeout, overriding, 6-4
translucent, 11-2, 11-3
trimming roll media, 3-14
troubleshooting, 9-1
 automatic cutter, 9-5–9-6
 lightfastness, 3-9
 media bin, 9-6
 media handling, 9-4
 media jam, 9-8–9-9
 media loading, 9-4
 miscellaneous problems, 9-23–9-25
 plot content, 9-10–9-16
 plot position, 9-10–9-16
 print quality problems, 9-16–9-21
 procedure, 9-2–9-3
 Rotate, 9-21
 stacking media in bin, 9-6

U

UNIX systems, cables to connect, 11-9
UNIX tips, 1-40
unloading media, 3-22–3-25
unused sheet, removing, 3-25
up arrow key, 2-7
Upgrade, PostScript, 7-11
upgrade, with a network interface, 7-12

V

vellum, 11-2, 11-3

W

warped lines, 9-18
weights, 11-3
Windows applications, driver, 11-14
workstation, cables to connect, 11-9

Warranty Statement

Warranty Limitations

**After the Warranty
Period**

About This Edition

4
5

**Obtaining Service During
Warranty Period**

Exclusions

0
4
0
35

4
35

For support details, see the section “Getting help” in chapter 9.

**HP Customer
Support
in the
USA**

**Phone
(208) 323 2551**

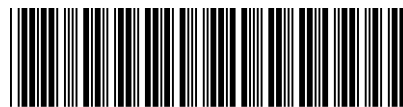

C4705-60021

Customer re-order number: C4705-60021

Manual Part Number: C4705-90031

Edition 1, September 1996

English

Printed in U.S.A.

This manual has been printed on chlorine-free bleached paper