

HP Designjet 70/110plus  
Printer series

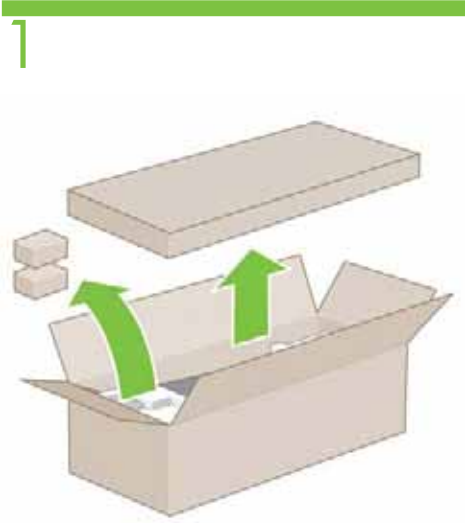

06655-90026



Remove all loose items from the top of the box.  
取下包裝箱上面所有鬆動的物件。



Roll the box on to its side.  
將包裝箱翻轉到側邊。

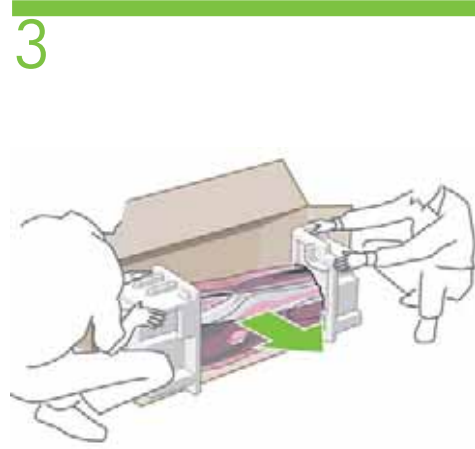

Remove the printer from the box.  
從包裝箱中取出印表機。

**A**



4

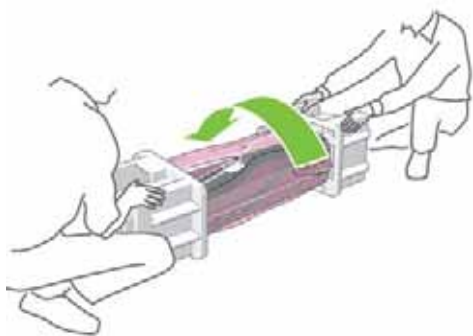

Roll the printer into an up right position.  
將印表機翻轉為立姿。

5

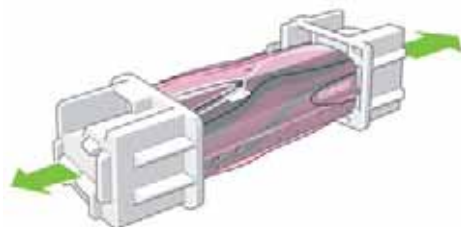

Remove both end caps.  
取出兩邊的端塞。

6

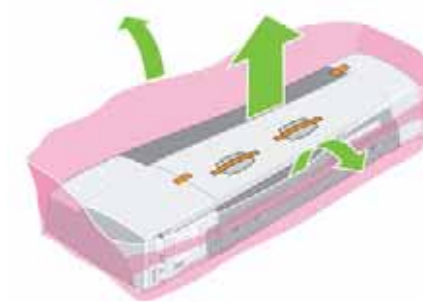

Remove the printer from the plastic bag.  
從塑膠袋中取出印表機。

7

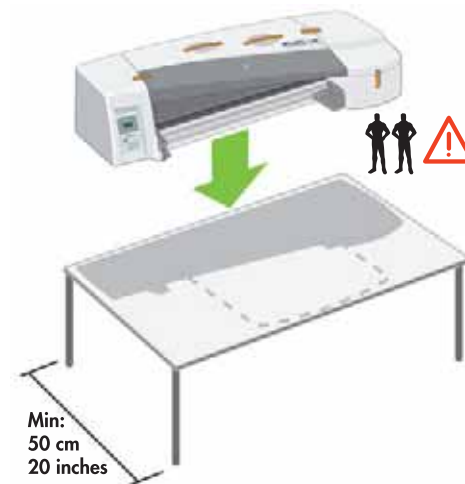

Place the printer on stable surface, respecting  
the dimensions indicated in the diagram above.  
將印表機放在平穩的表面，請注意上圖指示的  
尺寸。

**B**

8



Remove tapes and desiccant bags.  
 撕掉膠帶，拿出乾燥劑。

9



Remove tape.  
 撕掉膠帶。

10

HP Designjet 100plus/110plus/  
 110plus nr only



Open central flap.  
 打開中央折翼。

11

HP Designjet 100plus/  
 110plus/110plus nr only

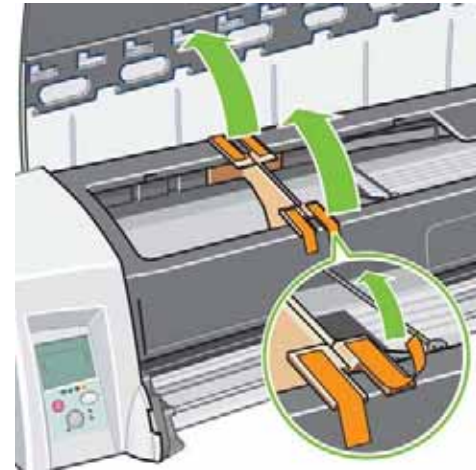

Remove tapes.  
 撕掉膠帶。

C



12

HP Designjet 100plus/  
110plus/110plus nr only

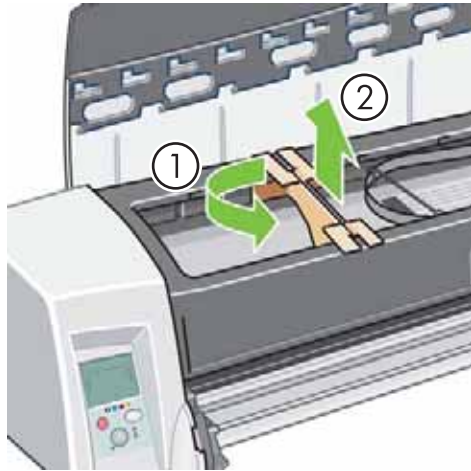

1. Rotate the packaging, then
2. lift it out of the printer.

1. 翻轉包裝材料，然後
2. 從印表機中取出。

13

HP Designjet 100plus/  
110plus/110plus nr only

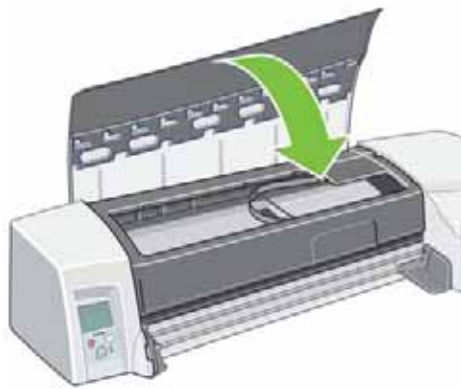

1. Close central flap.
- 合上中央折翼。

14

HP Designjet 110plus nr only

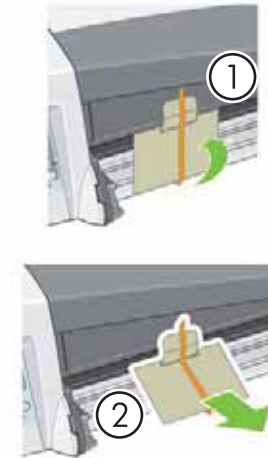

1. Starting at the bottom, remove the tape, then
2. remove the packaging from the printer.

1. 從底部開始撕掉膠帶，然後
2. 從印表機中取出包裝材料。

15



1. Fan the paper to help avoid multi-pick problems.
- 翻動紙張，以避免拾取多張紙的問題。

D

16

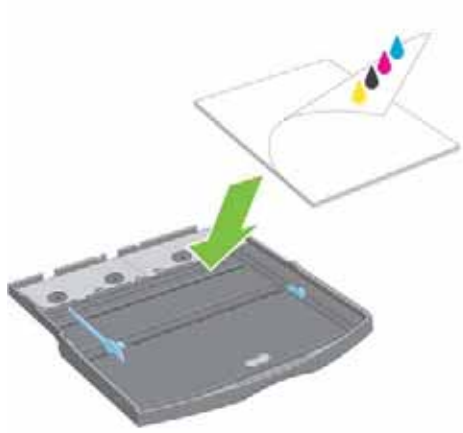

Place the sheets of paper into the corner of the input tray, print side facing down.  
將紙張放在靠進紙匣角落的位置，且列印面向下。

17

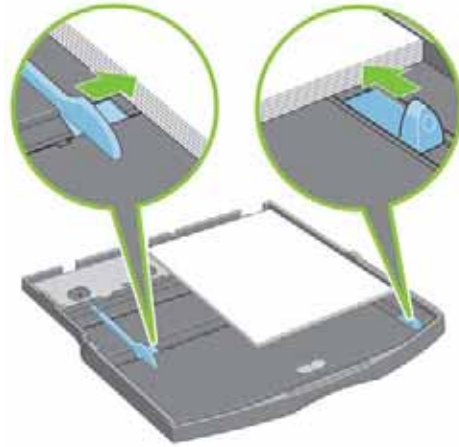

Slide the tabs so that they fit snugly against the paper.  
滑動槽片，使其剛好緊靠紙張。

18

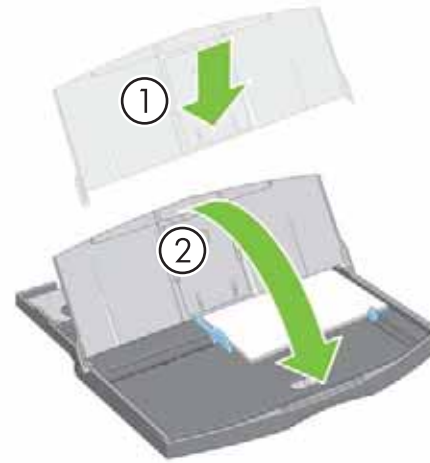

Locate the dust cover and insert it into the input tray from above and lower it down.  
找出防塵蓋，將其從上插入進紙匣，然後蓋上。

19



Open central flap.  
打開中央折翼。

E



20

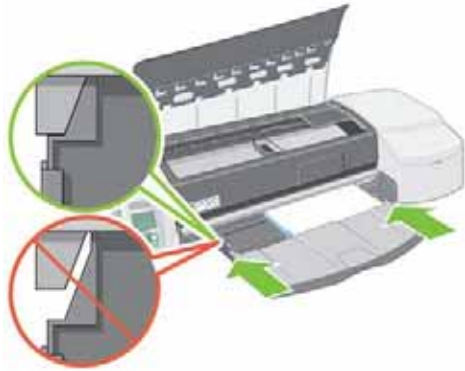

Insert the input tray into the printer by pushing on both sides. Do not leave a gap between the tray and the printer.

推動進紙匣兩側，將進紙匣插入印表機。紙匣與印表機之間不要留間隙。

21

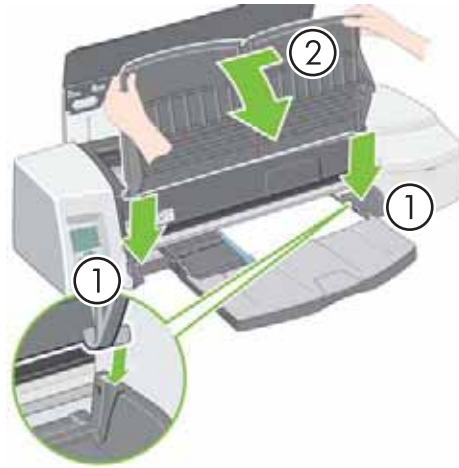

1. Lower the output tray into the printer vertically until it clicks into place and then 2. lower it onto the input tray, sliding the tray slightly to the left may help.

1. 將出紙盤垂直放入印表機，直至卡入定位，然後 2. 往下放至進紙匣上，將紙盤稍微滑向左側可能會較容易。

22



Close central flap.

合上中央折翼。

23



Open the hinged flaps at the right of the printer.

打開印表機右側的鉸接折翼。

24

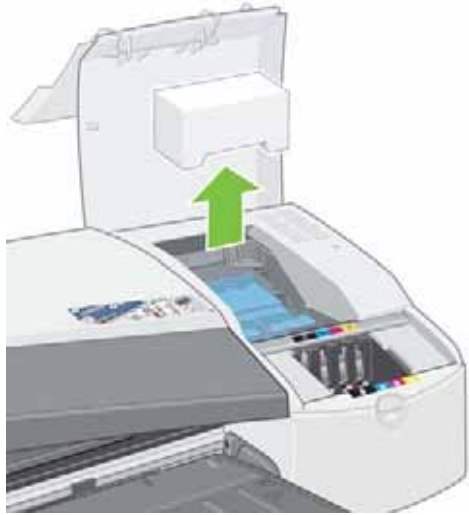

Remove the foam packaging.  
去除泡沫塑料包裝材料。

25



Close the hinged flaps at the right of the printer.  
合上印表機右側的鉸接折翼。

26

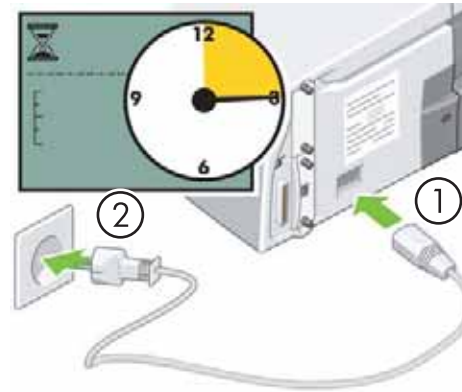

1. Insert the power cable into the printer and then,  
2. into the power socket then, 3. wait 15 seconds.

1. 將電源線插入印表機，然後  
2. 插入電源插座，3. 等待 15 秒鐘。

27



Press the power key to switch the printer on.  
按下電源鍵以開啟印表機電源。

G



28

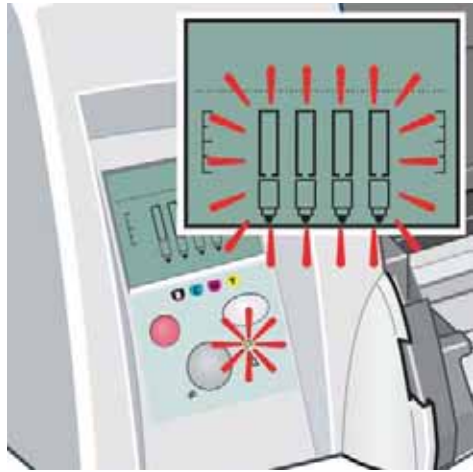

The front panel and yellow light will start to flash.  
前控制面板與黃色指示燈會開始閃爍。

29



Open the first hinged flap at the right of the printer.  
打開印表機右側的第一個鉸接折翼。

30

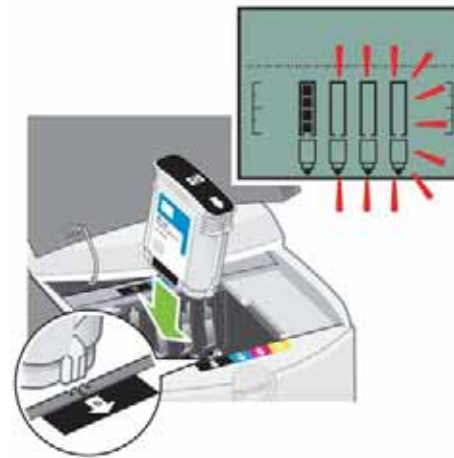

Match the color of the cartridge to the slot in the printer. As the ink cartridges are inserted the front panel will change.

墨水匣色彩與印表機中的插槽色彩應一致。墨水匣插入時，前控制面板會有變更。

31

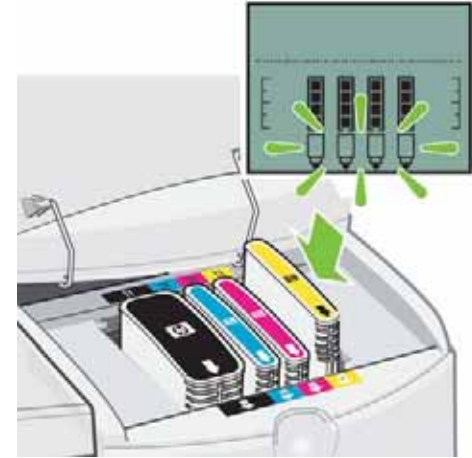

When the last ink cartridge is inserted only the printhead icons should be flashing.

插入最後一個墨水匣後，應僅剩印字頭圖示會閃爍。

H



32



Open the second hinged flap at the right of the printer.

打開印表機右側的第二個鉸接折翼。

33



Wait a 3 seconds before opening the printhead cover A.

等待 3 秒鐘，然後打開印字頭護蓋 A。

34

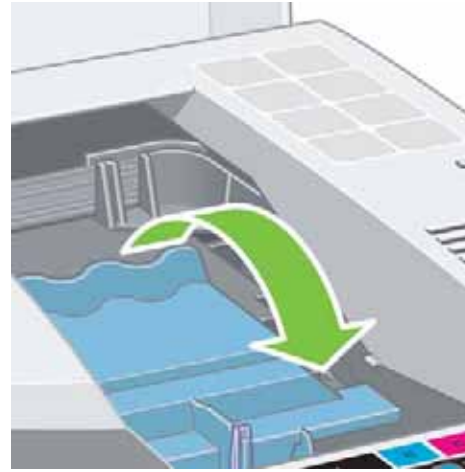

Pull the printhead cover up and towards the front.

向前拉起印字頭護蓋。

35

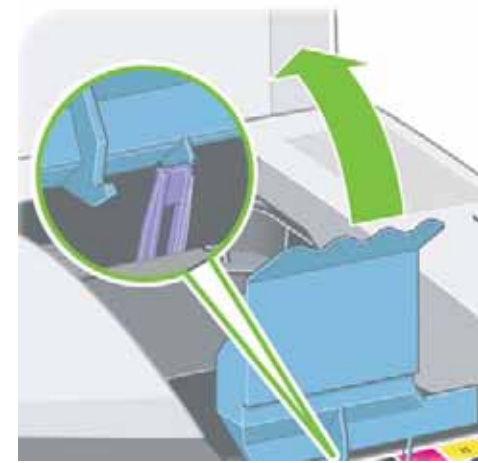

The hook at the front should unclatch itself. Lift the printhead cover back.

前端的鈎扣應會自動鬆開。向後提起印字頭護蓋。



36

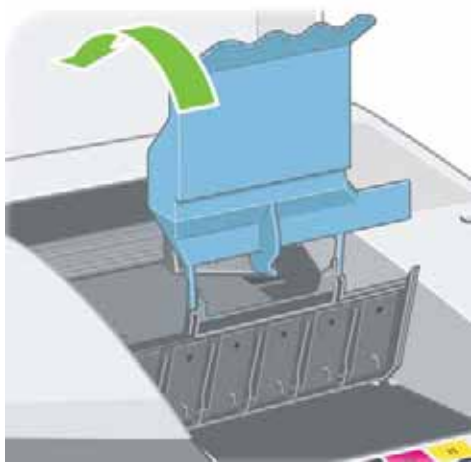

Lift the whole printhead cover back so that the printhead slots are exposed.

向後提起整個印字頭護蓋，使印字頭插槽露出。

37



Unpack the printheads and remove the protective tapes.

拆開印字頭包裝，並撕掉保護膠帶。

38

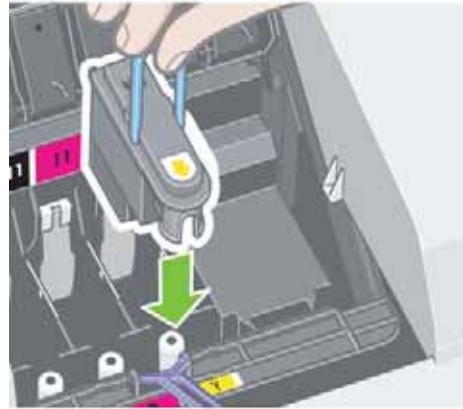

Match the color of the printhead to the slot in the printer.

印字頭色彩與印表機中的插槽色彩應一致。

39



Press the printheads firmly into their slots so they click into place.

將印字頭平穩地按入插槽，直至卡入定位。

J

40

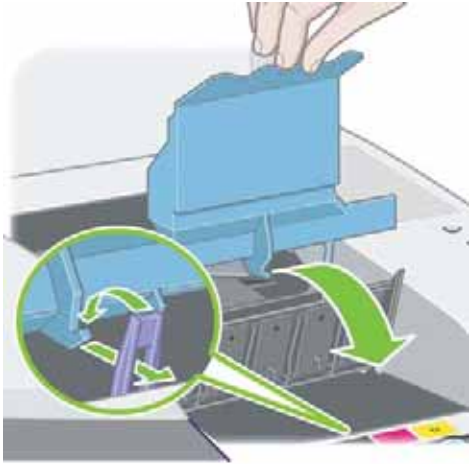

Pull the whole printhead cover forwards.  
向前拉動整個印字頭護蓋。

41

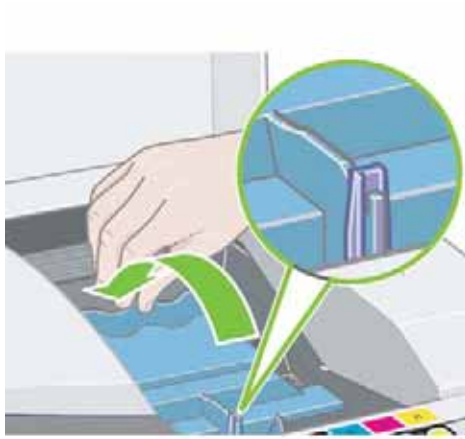

Return the printhead cover to its original position  
ensuring that the hook and the latch engage.  
將印字頭護蓋裝回原位，並確定鉤扣與門鎖啮合。

42



Lower the two hinged flaps until flap 2 clicks into  
place.  
放下兩個鉸接折翼，直至折翼 2 卡入定位。

43

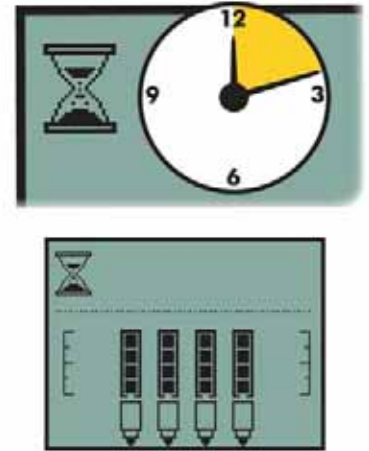

Wait approximately 12 minutes until the sand  
clock icon disappears.  
等待大約 12 分鐘，直至沙漏圖示消失。

K





When the sand clock icon disappears the printer will automatically perform a printhead alignment and a sheet 1. will be ejected.

沙漏圖示消失後，印表機會自動執行印字頭校正，紙張 1. 會退出。

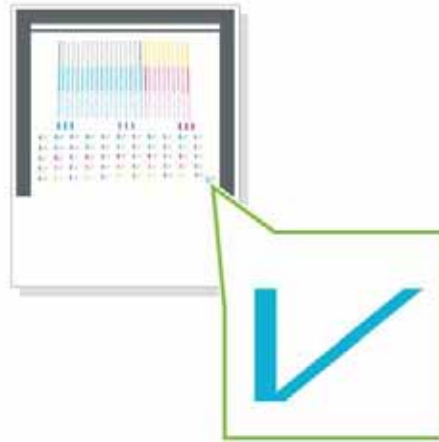

The printhead alignment sheet should look like this.

印字頭校正頁應如圖所示。



If you need help with this installation process refer to the Driver and Documentation CD that came with your printer.

如果安裝過程中需要協助，請參閱印表機隨附的驅動程式與說明文件 CD。



For HP Designjet 110plus nr go to automatic roll feed assembly on page M.

對於 HP Designjet 110plus nr，請移至第 M 頁的自動捲筒進紙器組件。



Otherwise go to software installation page R for Macintosh or page S for Windows.

否則，請移至軟體安裝 (Macintosh 為第 R 頁，Windows 為第 S 頁)。

HP Designjet 110plus nr  
Automatic roll feed assembly.  
自動捲筒進紙器組件。



Press the power key to switch the printer off.  
按下電源鍵以關閉印表機電源。



1. Remove the power cable from the power socket  
and then, 2. from the printer.  
1. 從電源插座拔下電源線，然後  
2. 從印表機中拔下電源線。

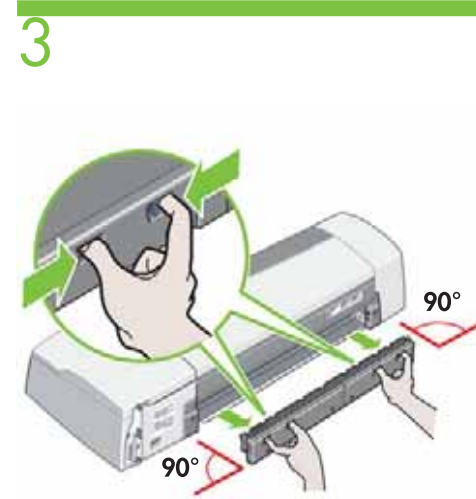

Remove the rear path by pressing the buttons  
as shown, and carefully pulling it straight out.  
如圖所示，按下背面送紙通道兩側的按鈕，  
小心地將其平直拉出。

M



4

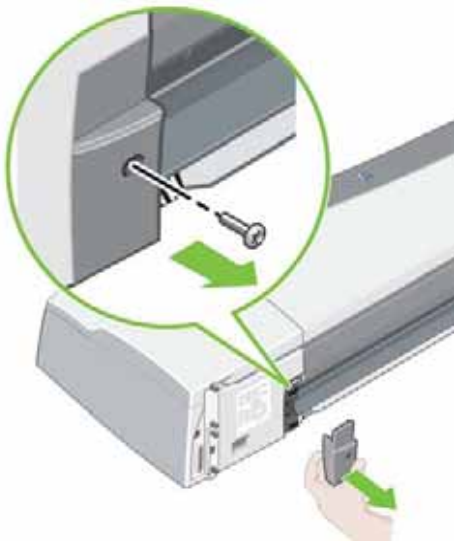

Remove the left plastic insert by extracting the screw as shown.

如圖所示，取出螺絲，卸下左塑膠插件。

5

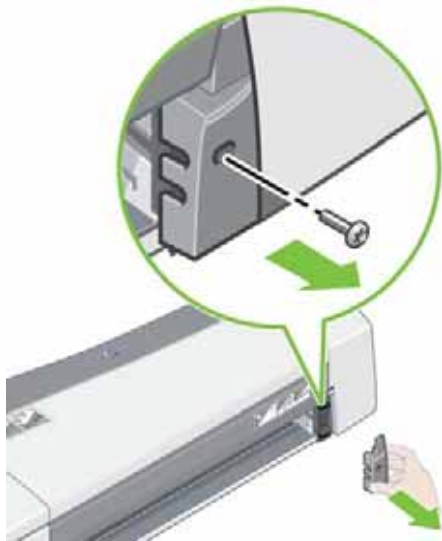

Remove the right plastic insert by extracting the screw as shown.

如圖所示，取出螺絲，卸下右塑膠插件。

6

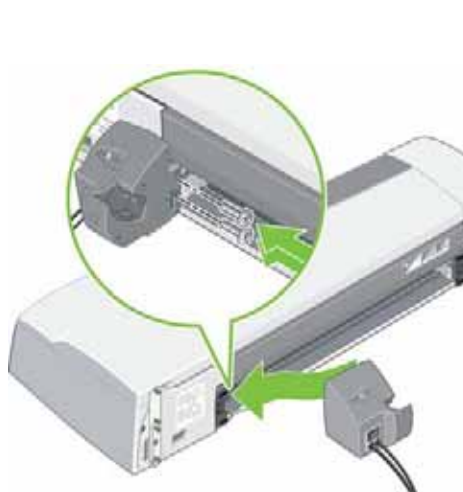

Install the left roll feed assembly, by aligning it with the guides and sliding it into position then using two screws to hold it in place.

將左捲筒進紙器組件與導板對齊並滑入定位，然後使用兩顆螺絲將其固定，以安裝左捲筒進紙器組件。

7

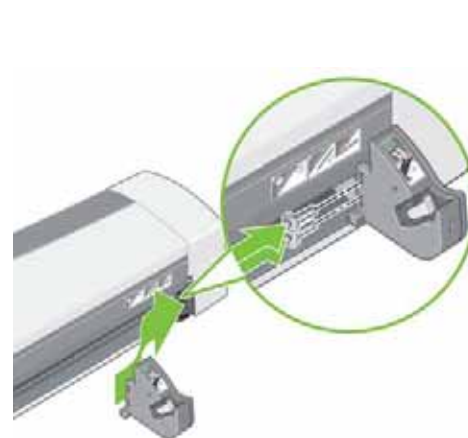

Install the right roll feed assembly, by aligning it with the guides and sliding it into position then using two screws to hold it in place. You may have a screw left over after assembly has been completed.

將右捲筒進紙器組件與導板對齊並滑入定位，然後使用兩顆螺絲將其固定，以安裝左捲筒進紙器組件。安成組裝後，您可能會剩餘一顆螺絲。

N

8

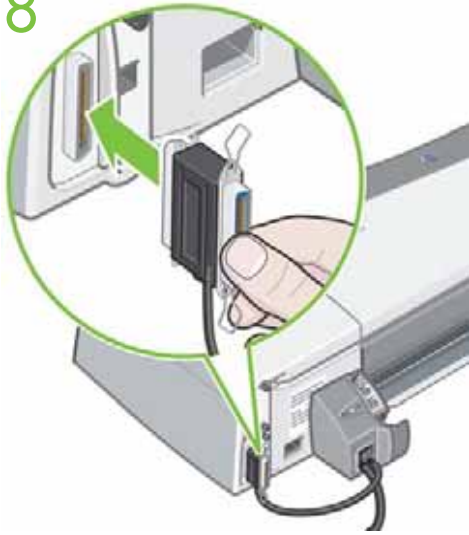

Connect the communication cable from the left roll feed to the printer's parallel (Centronics) port.

將左捲筒進紙器的通訊纜線連接至印表機的平行 (Centronics) 埠。

9

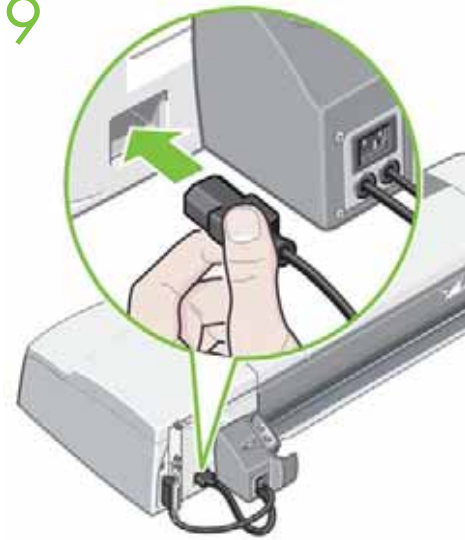

Connect the black power cable from the left roll feed to the printer's power socket.

將左捲筒進紙器的黑色電源線連接至印表機的電源插孔。

10

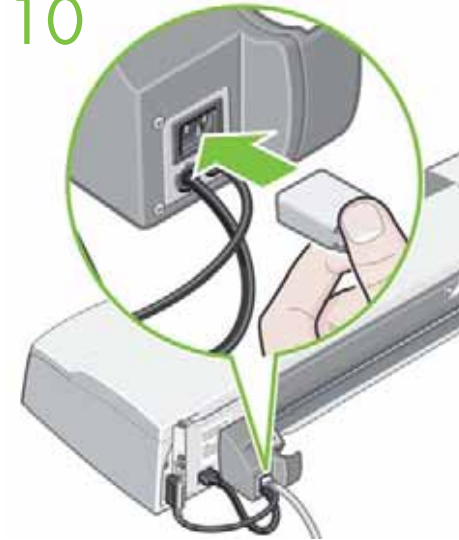

Connect the power cord to the power socket of the left roll feed.

將電源線連接至左捲筒進紙器的電源插孔。

11

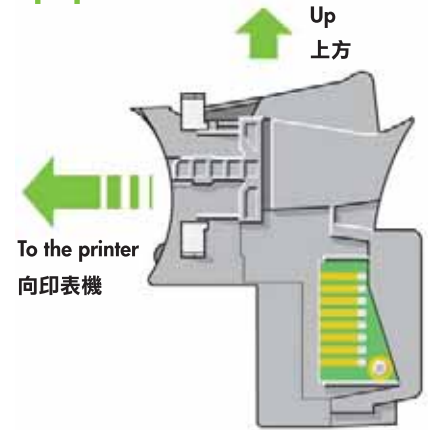

Make sure the rear path is the right way up.  
確定背面送紙通道正面向上。



12

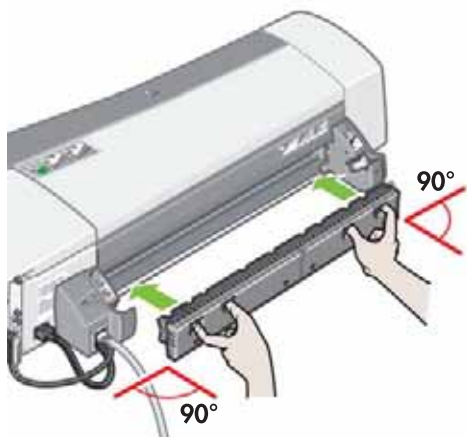

Insert the rear path until it clicks into place by pressing the buttons as shown, and carefully pushing it straight in.

如圖所示，按下背面送紙通道兩側的按鈕，小心地將其平直推入，以插入背面送紙通道並直至卡入定位。

13

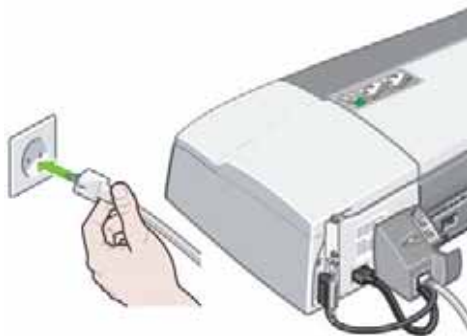

Insert the power cable into the power socket.  
將電源線插入電源插座。

14



Press the power key to switch on the printer.  
When there is power, the LED on the left roll feed assembly will come on.

按下電源鍵以開啟印表機電源。通電後，左捲筒進紙器組件上的 LED 將亮起。

15

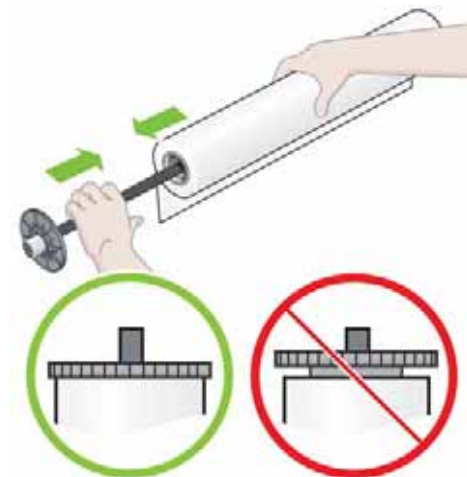

Insert the spindle into the roll taking care that the leading edge of the roll is on the correct side of the spindle. Ensure the roll is correctly seated as shown above.

將捲軸插入捲筒，並確定捲筒紙前緣在捲軸正確的一側上。確定捲筒已正確定位，如上圖所示。

P



16

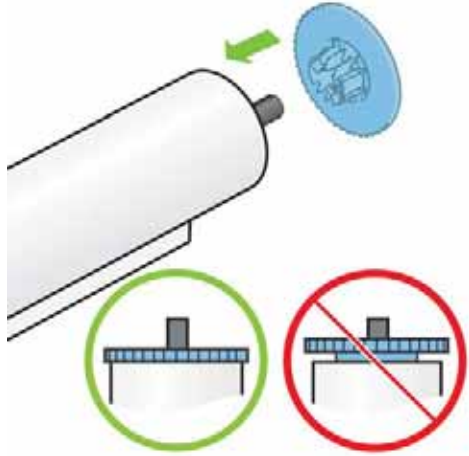

Insert the blue removable stop onto the spindle.  
Ensure it is correctly seated as shown above.

將藍色移動式止動器插到捲軸上。確定已正確  
定位，如上圖所示。

17

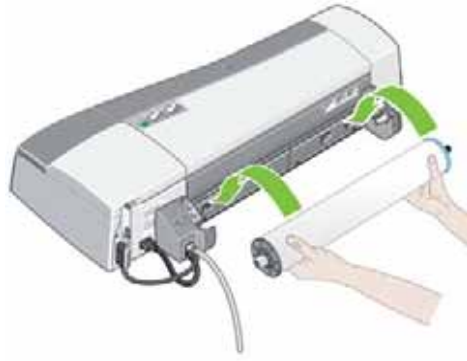

Insert the spindle into its retaining slots with the  
blue removable stop on the right and the black  
stop on the left.

將捲軸插入固定槽，使藍色移動式止動器位於  
右側，黑色止動器位於左側。



Go to software installation page R for Macintosh  
or page S for Windows.

請移至軟體安裝 (Macintosh 為第 R 頁，  
Windows 為第 S 頁)。

Q



## HP Designjet 70/110plus Printer series



### Setting up and connecting your printer MAC OS



©2005 Hewlett-Packard Company. All rights reserved.  
Inkjet Commercial Division Avenida Graells, 501 08174 Sant Cugat del Valles Barcelona Spain

## 1 Driver installation Mac OS X

1. Connect the cable from your computer or network to the printer.
2. Insert the *HP Designjet Driver and Documentation* CD into your CD drive, open the CD icon on your screen, and look for the 'Mac OS X HP Designjet Installer' icon.
3. Double-click the appropriate icon for your operating system to launch the installer, and then follow the on-screen instructions.  
**Note:** We recommend that you select 'Easy Install' to install all elements.
4. Follow the on-screen instructions that take you through the driver installation until you see the HP Printer setup assistant.
5. If you are connecting your printer directly to your computer with a USB cable, see 'USB connection' for Mac OS X.  
If you are connecting your printer to a network, see 'Network connection' for Mac OS X.

## 2 USB connection Mac OS X

1. Click 'Quit' to close the driver installer and remove the CD from the drive.
2. When your printer is connected to your computer by a USB cable, and the printer is turned on, a printer icon will automatically be added to your list of printers in the Print Center or Printer Setup Utility.

## 2 Network connection Mac OS X – Rendezvous

1. Make sure that the printer is on and connected to a working Ethernet network, and that all computers in the network are on and connected (including hubs and routers).
2. Print your HP Designjet printer information pages by pressing the OK key (upper right key on the front panel) four times while holding down the Power key, then releasing the Power key. Note the mDNS Service Name of your printer, in the TCP/IP section on the first page. Also check the version number of your Jetdirect firmware: this should be at least x.25.00 (where x can be anything), otherwise Rendezvous will not work.
3. In the HP Printer setup assistant, click 'Continue'.
4. In the list of printers that appears, select the entry that uses the connection type 'Rendezvous'.
  - a. If your printer appears in the list, click 'Continue' and go to step 5.
  - b. If your printer does not appear in the list, go to step 7.
5. The following screen displays information about your printer's installation, where the name of the printer can be modified. Make your changes if necessary and click 'Continue'.
6. Your printer is now connected. Select 'Create new queue' to connect another printer to the network, or 'Quit' to close the application.
7. Select 'My printer is not on the list' and click 'Continue'.
8. Select the 'Rendezvous' connection type.
9. Follow the on-screen instructions that help you connecting your printer to the network, and select 'Quit' to close the assistant window. Your printer is now available on the network.

R

## 1 Driver installation Mac OS 9

1. Connect the cable from your computer or network to the printer.
2. Insert the *HP Designjet Driver and Documentation* CD into your CD drive, open the CD icon on your screen, and look for the 'Mac OS 9 HP Designjet Installer' icon.
3. Double-click the appropriate icon for your operating system to launch the installer, and then follow the on-screen instructions.  
**Note:** We recommend that you select 'Easy Install' to install all elements.
4. When the installation has finished, remove the CD from the CD drive.
5. If you are connecting your printer directly to your computer with a USB cable, see 'USB connection' for Mac OS 9.  
If you are connecting your printer to a network, see 'Network connection' for Mac OS 9.

## 2 USB connection Mac OS 9

1. Ensure that the printer is connected to your computer by a USB cable, and that the printer is turned on.
2. Select 'Chooser' from the Apple menu.
3. Click the HP Inkjet icon in the Chooser.
4. From the 'Select an HP Inkjet Printer' panel, select your HP Designjet printer.
5. Click the Setup button in the Chooser to set up the printer, and specify whether it has a Roll Feeder installed.
6. Confirm your configuration by clicking the 'OK' button.
7. Close the Chooser. A new printer icon will appear on your desktop.

## 2 Network connection Mac OS 9 – Appletalk

1. Make sure that the printer is on and connected to a working Ethernet network, and that all computers in the network are on and connected (including hubs and routers).
2. Print your HP Designjet printer information pages by pressing the OK key (upper right key on the front panel) four times while holding down the Power key, then releasing the Power key. Note the Appletalk name and zone of your printer.
3. Make sure that the AppleTalk protocol is Active.
4. Select 'Chooser' from the Apple menu.
5. Click the HP Inkjet icon in the Chooser.
6. If the message "Do you wish to also scan for TCP/IP network printers?" appears, click 'No'.
7. If you use Appletalk zones, select the AppleTalk zone where your printer is located from the Appletalk Zones list.
8. Select your printer from the 'Select an HP Inkjet Printer' list. If you do not know the name of your printer, check the Appletalk name on the printer's information page. You should select a printer that has the Appletalk icon next to its name.
9. Click the 'Setup' button in the Chooser to set up the printer, and specify whether it has a Roll Feeder installed.
10. Confirm your configuration by clicking the 'OK' button.
11. Close the Chooser. A new printer icon will appear on your desktop.

For other network configurations or further details,  
please refer to the Driver and Documentation CD.

## HP Designjet 70/110plus Printer series



### Setting up and connecting your printer Windows



©2005 Hewlett-Packard Company. All rights reserved.  
Inkjet Commercial Division Avenida Graells, 501 08174 Sant Cugat del Valles Barcelona Spain

## 1 Network connection Windows

The network connection is the best way to share your printer with your team.

The HP Designjet 70 and 110plus can be connected to a network using HP Jetdirect print servers, which are available as optional accessories. The HP Designjet 110plus nr is supplied with a Jetdirect print server already installed.

1. Make sure that the printer and the computer are both connected to the network.
2. Go to the printer's front panel and hold down the Power key while pressing the OK key four times.
3. The printer will print some pages of information about itself. Make a note of the printer's IP address, shown in the TCP/IP section on the first page.
4. Insert the *HP Designjet Driver and Documentation* CD into your CD drive. If the CD does not autorun, run the SETUP.EXE program in the root folder of the CD.
5. Follow the instructions on your screen to set up the printer.
6. When asked how the printer is connected, choose 'Connected via the network'.
7. When asked what network setup you require, choose 'Basic network setup'.
8. Select your printer from the list. If you have more than one HP Designjet printer, use the IP address that you noted earlier to confirm that you have selected the correct printer.
9. The network settings of the selected printer are displayed. Check that they are correct, then click 'Next' to continue.
10. Select your printer model and click 'Next' to continue.
11. Click 'Next' until you have completed the installation of the printer driver.

## 2 USB connection Windows

USB is the preferred solution for a direct computer-to-printer connection.

1. **Do not connect the computer to the printer yet.** You must first install the printer driver software on the computer, as follows.
2. Insert the *HP Designjet Driver and Documentation* CD into your CD drive. If the CD does not autorun, run the SETUP.EXE program in the root folder of the CD.
3. Follow the instructions on your screen to set up the printer.
4. When asked how the printer is connected, choose 'Connected directly to this computer'.
5. Choose USB and click 'Next'.
6. Choose your printer model and click 'Next'.
7. When prompted to do so, connect your computer to the printer, using a USB cable. Ensure that the printer is switched on. When the printer software has detected the printer, the installation process will be completed automatically.

## 2 Parallel connection Windows 98 First Edition

Use the parallel port only if your system does not support USB. A parallel connection is slower than USB and restricts the functionality available: in particular, not all functions of HP Designjet System Maintenance will be available.

1. Turn off both printer and computer before connecting them via the parallel port, to avoid damaging your equipment.
2. Connect the parallel cable from your computer to the printer.
3. Turn on the computer and the printer.
4. Insert the *HP Designjet Driver and Documentation* CD into your CD drive. If the CD does not autorun, run the SETUP.EXE program in the root folder of the CD.
5. Follow the instructions on your screen to set up the printer.
6. When asked how the printer is connected, choose 'Connected directly to this computer'.
7. Choose 'Parallel cable' and your parallel port number and click 'Next' to continue.
8. Choose your printer model and click 'Next' to proceed with the driver installation.

S

For other network configurations or further details,  
please refer to the Driver and Documentation CD.

# HP Designjet 70/110plus 印表機系列



## 安裝與連接印表機 MAC OS



©2005 Hewlett-Packard Company 所有權利均予保留  
Inkjet Commercial Division Avenida Graells, 501 08174 Sant Cugat del Valles Barcelona Spain

## 1 驅動程式安裝 Mac OS 9

1. 連接電腦或網路與印表機之間的纜線。
2. 將 HP Designjet 驅動程式與說明文件 CD 放入 CD 光碟機，開啟螢幕上的 CD 圖示，然後尋找「Mac OS 9 HP Designjet 安裝程式」圖示。
3. 連按兩下適用作業系統的圖示以啟動安裝程式，然後按照螢幕上的說明進行。  
**註：** 建議您選擇「簡易安裝」安裝所有元件。
4. 安裝結束後，從 CD 光碟機中取出 CD。
5. 如果您使用 USB 纜線將印表機直接連接至電腦，請參閱用於 Mac OS 9 的「USB 連線」。  
如果您將印表機連線至網路，請參閱用於 Mac OS 9 的「網路連線」。

本文件包含的資訊如有變更，恕不另行通知。本產品與服務所附的明示保固聲明是 HP 對其產品與服務的唯一保固內容。  
本文件中的任何內容均不應誤認為是附加的保固。HP 對於本文件中的技術、編輯錯誤或遺漏概不負責。

## 1 驅動程式安裝 Mac OS X

1. 連接電腦或網路與印表機之間的纜線。
2. 將 HP Designjet 驅動程式與說明文件 CD 放入 CD 光碟機，開啟螢幕上的 CD 圖示，然後尋找「Mac OS X HP Designjet 安裝程式」圖示。
3. 連按兩下適用作業系統的圖示以啟動安裝程式，然後按照螢幕上的說明進行。  
**註：** 建議您選擇「簡易安裝」安裝所有元件。
4. 按照螢幕上的說明進行，以引導您完成驅動程式安裝，直至看到 HP 印表機安裝小幫手。
5. 如果您使用 USB 纜線將印表機直接連接至電腦，請參閱用於 Mac OS X 的「USB 連線」。  
如果您將印表機連線至網路，請參閱用於 Mac OS X 的「網路連線」。

## 2 USB 連線 Mac OS 9

1. 確定已使用 USB 纜線將印表機連接至電腦，且已開啟印表機電源。
2. 從「蘋果」清單中選擇「選擇週邊」。
3. 在「選擇週邊」中按一下 HP Inkjet 圖示。
4. 在「選擇 HP 噴墨印表機」面板中選擇 HP Designjet 印表機。
5. 按一下「選擇週邊」中的「設定」按鈕以設定印表機，然後指定是否已安裝捲筒進紙器。
6. 按一下「確定」按鈕以確認設定。
7. 關閉「選擇週邊」。新的印表機圖示將出現在桌面上。

## 2 USB 連線 Mac OS X

1. 按一下「結束」以關閉驅動程式安裝程式，然後從光碟機中取出 CD。
2. 使用 USB 纜線將印表機連接至電腦，並開啟印表機電源後，印表機圖示將自動新增至「列印中心」或「印表機安裝公用程式」中的印表機清單。

## 2 網路連線 Mac OS 9 – Appletalk

1. 確定印表機的電源開啟並連接至正常工作的乙太網路，且網路中的所有電腦均已開啟並連線（包括集線器與路由器）。
2. 按住「確定」鍵的同時按四下「電源」鍵（前控制面板右上方按鈕），然後鬆開「電源」鍵以列印 HP Designjet 印表機資訊頁。注意印表機的 AppleTalk 名稱與區域。
3. 請確定 AppleTalk 通訊協定處於連接狀態。
4. 從「蘋果」清單中選擇「選擇週邊」。
5. 在「選擇週邊」中按一下 HP Inkjet 圖示。
6. 如果出現「是否也要掃描 TCP/IP 網路印表機？」訊息，請按一下「否」。
7. 如果您使用 Appletalk 區域，在「AppleTalk 區域」列表中，選擇印表機所在的 Appletalk 區域。
8. 從「選擇 HP Inkjet 印表機」列表中選擇印表機。如果您不知道印表機的名稱，請在印表機資訊頁中查看 AppleTalk 名稱。您應該選擇其名稱旁邊有 AppleTalk 圖示的印表機。
9. 按一下「選擇週邊」中的「設定」按鈕以設定印表機，然後指定是否已安裝捲筒進紙器。
10. 按一下「確定」按鈕以確認設定。
11. 關閉「選擇週邊」。新的印表機圖示將出現在桌面上。

## 2 網路連線 Mac OS X – Rendezvous

1. 確定印表機的電源開啟並連接至正常工作的乙太網路，且網路中的所有電腦均已開啟並連線（包括集線器與路由器）。
2. 按住「電源」鍵的同時按四下「確定」鍵（前控制面板右上方），然後鬆開電源鍵以列印 HP Designjet 印表機資訊頁。在首頁的 TCP/IP 部份記下印表機的 mDNS 服務名稱。此外，還要檢查 Jetdirect 韌體的版本編號：至少應該為 x.25.00（此處 x 可以是任何數字），否則 Rendezvous 將不起作用。
3. 在 HP 印表機安裝小幫手中，按一下「繼續」。
4. 在顯示的印表機清單中，選擇使用「Rendezvous」連線類型的項目。
  - a. 如果您的印表機出現在清單中，請按一下「繼續」，然後移至步驟 5。
  - b. 如果您的印表機未出現在清單中，請移至步驟 7。
5. 下列畫面顯示有關印表機安裝的資訊，其中印表機的名稱可以修改。如有必要，請進行變更，然後按一下「繼續」。
6. 印表機即已連接。選擇「建立新佇列」將其他印表機連線至網路，或選擇「結束」關閉應用程式。
7. 選擇「我的印表機不在清單中」，然後按一下「繼續」。
8. 選擇「Rendezvous」連線類型。
9. 按照螢幕上的說明進行，以協助您將印表機連線至網路，然後選擇「結束」以關閉小幫手視窗。您的印表機目前即可在網路上使用。

對於其他網路設定或更詳細的資料，請參閱驅動程式與說明文件 CD。

R

## HP Designjet 70/110plus 印表機系列



### 安裝與連接印表機 Windows



©2005 Hewlett-Packard Company 所有權利均予保留  
Inkjet Commercial Division Avenida Graells, 501 08174 Sant Cugat del Valles Barcelona Spain

## 1 網路連線 Windows

網路連線是與團隊共享印表機的最佳方式。

HP Designjet 70 與 110plus 可以使用選購附件 HP Jetdirect 列印伺服器連線至網路。HP Designjet 110plus nr 出廠時已安裝 Jetdirect 列印伺服器。

1. 確定印表機與電腦皆已連接至網路。
2. 移至印表機前控制面板，然後在按住電源鍵的同時按四下「確定」鍵。
3. 印表機會列印有關其本身的部分資訊頁。請記下印表機的 IP 位址，如第一頁上的 TCP/IP 部分所示。
4. 將 HP Designjet 驅動程式與說明文件 CD 放入 CD 光碟機。如果 CD 沒有自動執行，請執行 CD 根資料夾下的 SETUP.EXE 程式。
5. 按照螢幕上的說明設定印表機。
6. 系統詢問印表機的連接方式時，請選擇「透過網路連接」。
7. 系統詢問需要何種網路設定時，請選擇「基礎網路設定」。
8. 從清單中選擇印表機。如果您有多台 HP Designjet 印表機，請使用之前記下的 IP 位址以確認選擇了正確的印表機。
9. 系統將會顯示所選定印表機的網路設定。檢查設定是否正確，然後按一下「下一步」以繼續。
10. 選擇您的印表機機型，然後按一下「下一步」以繼續。
11. 按一下「下一步」直到完成印表機驅動程式的安裝。

## 2 USB 連線 Windows

USB 是直接連接電腦與印表機的首選解決方案。

1. **請選不要將電腦連接至印表機。**您必須先在電腦上安裝印表機驅動程式軟體，如下所示。
2. 將 HP Designjet 驅動程式與說明文件 CD 放入 CD 光碟機。如果 CD 沒有自動執行，請執行 CD 根資料夾下的 SETUP.EXE 程式。
3. 按照螢幕上的說明設定印表機。
4. 系統詢問印表機的連接方式時，選擇「直接連接至此電腦」。
5. 選擇 USB，然後按一下「下一步」。
6. 選擇您的印表機型號，然後按一下「下一步」。
7. 在系統提示時，使用 USB 纜線將電腦連接至印表機。確定印表機的電源已開啟。當印表機軟體偵測到印表機，安裝程序將自動完成。

## 2 平行連線 Windows 98 第一版

僅在系統不支援 USB 時使用平行埠。平行連線的速度比 USB 慢，並限制某些功能的使用 (特別是 HP Designjet 系統維護中的有些功能將無法使用)。

1. 透過平行埠連線之前，請先關閉印表機與電腦的電源以避免損壞設備。
2. 使用平行纜線將電腦連接至印表機。
3. 開啟電腦與印表機的電源。
4. 將 HP Designjet 驅動程式與說明文件 CD 放入 CD 光碟機。如果 CD 沒有自動執行，請執行 CD 根資料夾下的 SETUP.EXE 程式。
5. 按照螢幕上的說明設定印表機。
6. 系統詢問印表機的連接方式時，選擇「直接連接至此電腦」。
7. 選擇「平行纜線」與您的平行埠號碼，然後按一下「下一步」以繼續。
8. 選擇您的印表機機型，然後按一下「下一步」以繼續安裝印表機驅動程式。

S

對於其他網路設定或更詳細的資料，請參閱驅動程式與說明文件 CD。