

HP Photosmart R827 Digital Camera

English



Legal and notice information

© Copyright 2006 Hewlett-Packard Development Company, L.P.

The information contained herein is subject to change without notice. The only warranties for HP products and services are set forth in the express warranty statements accompanying such products and services. Nothing herein should be construed as constituting an additional warranty. HP shall not be liable for technical or editorial errors or omissions contained herein.

Windows® is a U.S. registered trademark of Microsoft Corporation.



SD Logo is a trademark of its proprietor.



Disposal of waste equipment by users in private households in the European Union

This symbol on the product or on its packaging indicates that this product must not be disposed of with your other household waste. Instead, it is your responsibility to dispose of your waste equipment by handing it over to a designated collection point for the recycling of waste electrical and electronic equipment. The separate collection and recycling of your waste equipment at the time of disposal will help to conserve natural resources and ensure that it is recycled in a manner that protects human health and the environment. For more information about where you can drop off your waste equipment for recycling, please contact your local city office, your household waste disposal service or the shop where you purchased the product.

For future reference, enter the following information:

- Model Number (camera front): _____
- Serial Number (camera bottom): _____
- Purchase date: _____

Contents

1	Getting started	4
	Accessing the electronic User Guide	4
	Camera top and back	6
	Camera front, side, and bottom	8
	Camera dock insert	8
2	Setting up your camera	9
	Install the battery	9
	Charge the battery	9
	Turn on the camera	10
	Choose the language	10
	Set the region	10
	Set the date and time	10
	Install and format an optional memory card	11
	Install the software	12
3	Taking pictures and recording video clips	14
	Take a still picture	14
	Record a video clip	14
4	Reviewing and deleting images and video clips	16
	Review images and video clips	16
	Delete an image	16
5	Transferring and printing images	17
	Transfer images	17
	Print images from the camera	17
6	Camera quick reference	19

1 Getting started

This printed Quick Start Guide provides the information you need to get started using the essential features of your camera. For detailed information about camera features, see the electronic User Guide.

Quick Start Guide	Electronic User Guide
<p>This printed guide will help you to:</p> <ul style="list-style-type: none">• Start using your camera quickly• Install the HP Photosmart software• Become familiar with your camera's basic features	<p>The electronic User Guide includes:</p> <ul style="list-style-type: none">• Descriptions of all the camera features• A description of icons on the Image Display• Battery information, including:<ul style="list-style-type: none">– Extending battery life– A description of the power indicator icons• Troubleshooting• Getting assistance from HP• Camera specifications

Accessing the electronic User Guide



The electronic User Guide is on the HP Photosmart Software CD.

To view the User Guide:

1. Insert the HP Photosmart Software CD into the CD drive of your computer.
2. **On Windows:** Click **View User Guide** on the main page of the installation screen.
On Macintosh: Open the **readme** file in the **docs** folder on the CD.

The electronic User Guide is also copied to your computer when you install the HP Photosmart Software. To view the User Guide after it has been installed on your computer:

- **On Windows:** Open the **HP Solution Center** and click on **Help and Support**.
- **On Macintosh:** Open the **HP Device Manager** and select **Camera User Guide** from the **Information and Settings** pop-up menu.







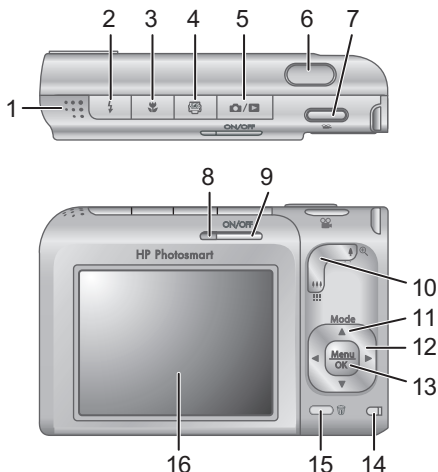

Getting assistance

- For tips and tools to help you use your camera more effectively, visit **www.hp.com/photosmart** (English only) or **www.hp.com**.
- For product assistance, diagnostics, and driver downloads 24x7, visit **www.hp.com/support**.
- For help with the HP Photosmart Software, see the software's online help.

Camera top and back



1	Speaker.
2	Flash button—Settings are Auto, Flash On, Flash Off.
3	Focus button—Settings are Normal, Macro, Auto Macro, Infinity.
4	Photosmart Express button—Options are Print, Share, Buy Prints, Favorites, Help.
5	Live View/Playback button—Switches between Live View and Playback (see <i>Live View and Playback</i> on page 19).
6	Shutter button.
7	Video button.
8	Power light.

9	ON/OFF button.
10	Zoom lever (Digital and Optical)—In Live View , press  to zoom in or press  to zoom out. In Playback , press  to magnify the selected image or press  to view thumbnails of your images.
11	Mode button—Press  to access the Shooting Mode menu while in Live View . Shooting Mode options are Auto Mode, Landscape, Portrait, Steady Photo, Panorama Right, Panorama Left, Theatre, Action, Night Portrait, Night Scenery, Beach, Snow, Sunset, Document.
12	 and  buttons—Scroll through menus and images.
13	 button—Displays camera menus, selects options, and confirms actions.
14	Battery Charging light.
15	 Delete button—Accesses the Delete function while in Playback .
16	Image Display.

Camera front, side, and bottom

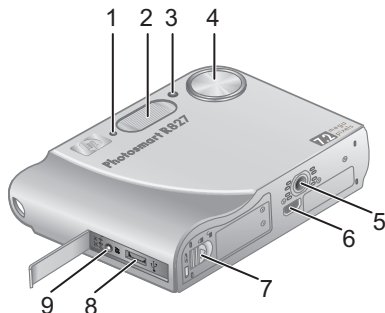

1	Microphone.
2	Flash.
3	Self-Timer/Focus Assist light.
4	Lens.
5	Tripod mount.
6	Dock connector.
7	Battery/Memory card door.
8	USB connector.
9	Power adapter connector.

Camera dock insert

If you purchase an optional HP Photosmart camera dock, it will come with multiple clear inserts. When setting up the dock for use with this camera, use the dock insert with the round blue tag. See the dock User Guide for instructions.

2 Setting up your camera

Install the battery

1. Open the Battery/Memory card door by sliding the door latch as indicated on the Battery/Memory card door.
2. Insert the battery in the larger slot, pushing the battery in until the latch catches.
3. Close the Battery/Memory card door.

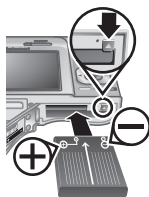

Note Turn the camera off before removing the battery. Fully charge the battery before using it the first time.

Charge the battery

You can charge the battery in the camera, using the AC adapter.

1. Plug the small end of the power cord into the AC power adapter, and the large end into an electrical outlet.
2. Attach the thin cord from the AC power adapter to the camera as shown.

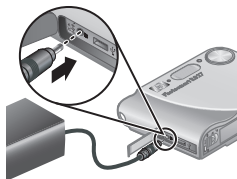

The camera's blinking Battery Charging light indicates that the battery is charging; the battery is fully charged when the light stays on solid (approximately 2–3 hours).

Turn on the camera

To turn on the camera, press the ON/OFF button.

Choose the language

Use ▲▼◀▶ to choose the language that you want, then press $\frac{\text{Menu}}{\text{OK}}$.

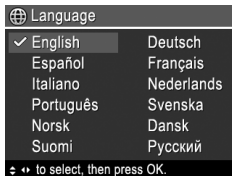

Set the region

Along with the **Language** setting, the **Region** setting determines the default date format and the format of the video signal for displaying camera images on a television.

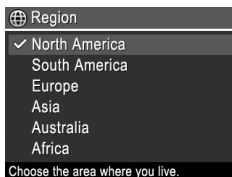

Use ▲▼ to choose the region you want, then press $\frac{\text{Menu}}{\text{OK}}$.

Set the date and time

Accurately setting the date and time will help you locate images once you have uploaded them to your computer,

and will ensure that images are accurately marked if you use the date and time imprint feature.

1. Use ▲▼ to adjust the highlighted value.
2. Use ◀▶ to move to the other selections and repeat Step 1 until the date and time are set correctly.
3. Press $\frac{\text{Menu}}{\text{OK}}$ when the date, time, and format settings are correct, then press $\frac{\text{Menu}}{\text{OK}}$ again to confirm.

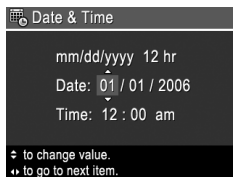

Install and format an optional memory card





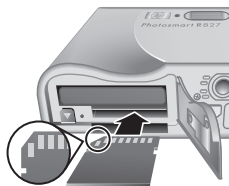



This camera supports standard and high speed, HP-branded Secure Digital (SD) memory cards, 8MB to 2GB.

1. Turn off the camera and open the Battery/Memory card door.
2. Insert the optional memory card in the smaller slot as shown. Make sure the memory card snaps into place.
3. Close the Battery/Memory card door and turn on the camera.



Always format new memory cards before first use. Formatting removes all images from the memory card,

so make sure to upload existing images before formatting.

1. With the camera turned on, press  /  until you are in **Playback**.
2. Press  to display the **Delete** sub-menu.
3. Use   to select **Format Card**, then press .
4. Use   to select **Yes**, then press  to format the card.

Once you install a memory card, all new images and video clips are stored on the card, rather than in internal memory.

To use internal memory and view images stored there, remove the memory card.

Install the software

The HP Photosmart Software provides features for transferring images and video clips to your computer, as well as features for modifying stored images (remove red eyes, rotate, crop, resize, adjust image quality, add colors and special effects, and more).

If you have trouble installing or using the HP Photosmart Software, see the HP Customer Care website for more information: www.hp.com/support.

Windows

Depending on your operating system, either you have the option to install HP Photosmart Premier or HP Photosmart Essential, or HP Photosmart Essential installs automatically. HP Photosmart Premier includes additional functionality over the Essential version. See

chapter 1 in the electronic User Guide for a list of differences.

1. Close all programs and temporarily disable any virus protection software.
2. Insert the HP Photosmart Software CD into the CD drive and follow the on-screen instructions. If the installation window does not appear, click **Start**, click **Run**, type **D:\Setup.exe**, where **D** is the letter of your CD drive, then click **OK**.
3. When the software has finished installing, re-enable virus protection software.

Macintosh



To install the HP Photosmart Mac software, your Macintosh computer must meet the system requirements as stated on the camera packaging.

1. Insert the HP Photosmart Software CD into the CD drive.
2. Double-click the CD icon on the computer desktop.
3. Double-click the installer icon, then follow the on-screen instructions.

3 Taking pictures and recording video clips



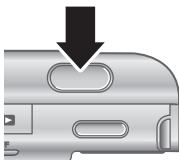

Live View allows you to frame pictures and video clips in the Image Display.

Take a still picture

1. Press  /  until  appears briefly in the upper right corner of the Image Display. This indicates you are in **Live View**.
2. Frame the subject for your picture.
3. Press the **Shutter** button halfway down to measure and lock the focus and exposure. The focus brackets in the Image Display turn solid green when focus is locked.
4. Press the **Shutter** button all the way down to take the picture.
5. To add an audio clip of up to 60 seconds, continue holding the **Shutter** button down, then release it when done.



Record a video clip

1. Press  /  until  appears briefly in the upper right corner of the Image Display. This indicates you are in **Live View**.
2. Frame the subject.
3. Press and release the **Video**  button.

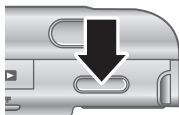





4. To stop recording video, press and release the **Video**  button again.

4 Reviewing and deleting images and video clips











Review images and video clips

You can review and delete images and video clips in **Playback**.

1. Press  /  until  appears in the briefly upper right corner of the Image Display. This indicates you are in **Playback**.
2. Use   to scroll through your images and video clips (video clips play automatically).

Delete an image

You can delete individual images during **Playback**:

1. Press  /  until  appears in the briefly upper right corner of the Image Display. This indicates you are in **Playback**.
2. Use   to select an image or video clip.
3. Press  to display the **Delete** sub-menu.
4. Use   to select **This Image**, then press  .

5 Transferring and printing images

Transfer images

If you have installed the HP Photosmart Software, use this method to transfer images and video clips to your computer. If you have not installed the HP Photosmart Software, see the electronic User Guide for an alternate method.

Tip You can also perform this task using an optional HP Photosmart camera dock (see the dock User Guide).

1. Turn off the camera, then connect it to the computer using the USB cable that came with your camera.
2. Turn on the camera and follow the instructions on the computer screen to transfer the images. For more information, see the Help feature in the HP Photosmart Software.

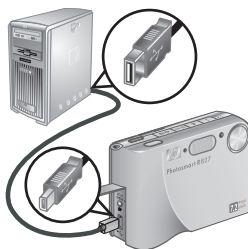

Print images from the camera

You can connect the camera to any PictBridge-certified printer to print still images and frames saved from a video clip.



1. Check that the printer is turned on, there is paper in the printer, and there are no printer error messages.

2. Connect the camera and printer using the USB cable that came with your camera.
3. Turn on the camera.
4. When the camera is connected to the printer, the **Print Setup Menu** displays on the camera. To change the settings, use ▲▼ on the camera to select a menu option, then use ◀▶ on the camera to change the setting.

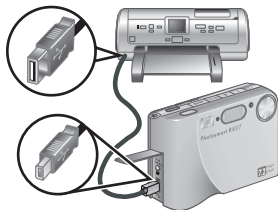

5. Press $\frac{\text{Menu}}{\text{OK}}$ to begin printing.

6 Camera quick reference

Use this chapter as a quick reference to camera features. To learn more about these camera features, refer to the electronic User Guide.

Live View and Playback

- **Live View** allows you to frame pictures and video clips in the Image Display. To activate **Live View**, press / until appears briefly in the upper right corner of the Image Display.
- **Playback** allows you review and delete images and video clips. To activate **Playback**, press / until appears briefly in the upper right corner of the Image Display.

Menus



When you press ^{Menu} / _{OK} from either **Playback** or **Live View**, you access the tabbed camera menu, as shown in the example screen.





Use to move to the desired menu. Within a menu, use to move to specific selections.

To exit the menu, press / at any time.







Menus and options are:

Menu	Options
<p> Capture allows you to adjust camera settings that affect the characteristics of future images and video clips you capture with your camera.</p>	<ul style="list-style-type: none"> • Shooting Mode (Auto Mode, Landscape, Portrait, Steady Photo, Panorama Right, Panorama Left, Theatre, Action, Night Portrait, Night Scenery, Beach, Snow, Sunset, Document) • Self-Timer • Red-Eye Removal • Exposure Compensation • Adaptive Lighting • Bracketing • Image Quality • Video Quality • Burst • White Balance • Auto Focus Area • AE Metering • ISO Speed • Saturation • Sharpness • Contrast • Date & Time Imprint
<p> Playback allows you to review and manipulate images you have stored in the camera.</p>	<ul style="list-style-type: none"> • Image Advice • Image Info • View Slideshow • Stitch Panorama • Record Audio • Move Images to Card

Menu	Options
 Design Gallery allows you to enhance the images you have captured.	<ul style="list-style-type: none">• Apply Artistic Effects• Modify Color• Add Borders• Remove Red Eyes• Rotate• Crop
 Setup allows you to change the camera's behavior.	<ul style="list-style-type: none">• Display Brightness• Sounds Volume• Focus Assist Light• Display Timeout• Instant Review• Digital Zoom• Date & Time• USB Configuration• TV Configuration• Language• Reset Settings
 Help provides descriptions of camera features and picture-taking tips.	<ul style="list-style-type: none">• Top Ten Tips• Camera Accessories• Camera Buttons• Using Shooting Modes• Using Design Gallery• Using Photosmart Express• Printing Images• Recording Audio Clips• Recording Video Clips• Reviewing Images and Videos• Extracting Prints from Video• Deleting Images

Menu	Options
	<ul style="list-style-type: none"> • Transferring Images • Managing Batteries • Getting Assistance • Camera Shortcuts • About...

When you press  while in **Live View** or **Playback**, you see the **Photosmart Express** menu.

Menu	Options
 Photosmart Express allows you to select photos or groups of photos (Favorites) to print, to buy online, or to share with friends and relatives.	<ul style="list-style-type: none"> •  Print •  Share •  Buy Prints •  Favorites •  Help

Appareil photo numérique HP Photosmart R827

Français



Informations légales et remarques

© Copyright 2006 Hewlett-Packard Development Company, L.P.

Les informations contenues dans le présent document sont sujettes à modification sans préavis. Les seules garanties pour les produits et services HP sont énoncées dans les déclarations de garantie expresse accompagnant lesdits produits et services. Aucun élément du présent document ne saurait être interprété comme constituant une garantie supplémentaire. HP ne saurait être tenu pour responsable d'éventuelles erreurs ou omissions techniques ou rédactionnelles contenues dans le présent document.

Windows® est une marque déposée de Microsoft Corporation aux Etats-Unis.



est une marque commerciale de son propriétaire.



Mise au rebut des équipements usagés par les particuliers résidant au sein de l'Union européenne

Figurant sur le produit ou sur son emballage, ce symbole indique que vous ne devez pas jeter le produit avec vos déchets ménagers. Il vous incombe de déposer votre équipement usagé dans un centre de récupération des déchets spécialisé dans le recyclage des appareils électriques et électroniques. Le tri et le recyclage sélectifs de vos déchets contribuent à préserver les ressources naturelles et sont effectués de telle sorte que ni la santé de l'homme, ni l'environnement ne soient affectés. Pour plus d'informations sur les sites où vous pouvez déposer vos équipements usagés à des fins de recyclage, renseignez-vous auprès du service concerné à la mairie de votre lieu de résidence, du service de voirie ou du magasin où vous avez acheté votre produit.

Veillez noter les informations suivantes pour référence ultérieure :

- Numéro de modèle (en façade de l'appareil) : _____
- Numéro de série (sous l'appareil) : _____
- Date d'achat : _____

Sommaire

1	Prise en main	4
	Accéder au Guide de l'utilisateur au format électronique	5
	Dessus et arrière de l'appareil photo	6
	Façade, côté et dessous de l'appareil photo	8
	Kit d'adaptation de la station d'accueil	9
2	Préparation de votre appareil photo	10
	Installation de la batterie	10
	Chargement de la batterie	10
	Mise en marche de l'appareil photo	11
	Choix de la langue	11
	Sélection de la région	11
	Réglage de la date et de l'heure	11
	Insertion et formatage d'une carte mémoire (en option)	12
	Installation du logiciel	13
3	Prises de vue et enregistrement de clips vidéo	16
	Prise d'une photo	16
	Enregistrement d'un clip vidéo	17
4	Revisualisation et suppression des images et des clips vidéo	18
	Revisualisation des images et des clips vidéo	18
	Suppression d'une image	18
5	Transfert et impression d'images	20
	Transfert d'images	20
	Impression d'images à partir de l'appareil photo	21
6	Référence rapide de l'appareil photo	22

1 Prise en main

Ce guide imprimé de prise en main rapide fournit les informations nécessaires à l'utilisation des principales fonctionnalités de votre appareil photo. Pour obtenir des informations détaillées sur l'ensemble de ses fonctionnalités, consultez le Guide de l'utilisateur au format électronique.

Guide de prise en main rapide	Guide de l'utilisateur au format électronique
<p>Ce guide imprimé vous permettra :</p> <ul style="list-style-type: none">• D'utiliser votre appareil photo rapidement• D'installer le logiciel HP Photosmart• De vous familiariser avec les fonctions de base de l'appareil photo	<p>Le Guide de l'utilisateur au format électronique comprend :</p> <ul style="list-style-type: none">• Des descriptions de l'ensemble des fonctionnalités de l'appareil photo• Une description des icônes qui apparaissent à l'écran• Des informations relatives à la batterie, notamment :<ul style="list-style-type: none">– L'extension de son autonomie– Une description des icônes d'indication de charge• Résolution des problèmes• Obtenir une assistance auprès de HP

- Caractéristiques de l'appareil photo

Accéder au Guide de l'utilisateur au format électronique



Le Guide de l'utilisateur au format électronique se trouve sur le CD HP Photosmart Software.

Pour consulter le Guide de l'utilisateur :

1. Insérez le CD HP Photosmart Software dans le lecteur de CD-ROM de votre ordinateur.
2. **Sous Windows** : cliquez sur **Afficher le Guide de l'utilisateur** dans la page principale de l'écran d'installation.
Sous Macintosh : ouvrez le fichier **readme** du dossier **docs** du CD.

Le Guide de l'utilisateur au format électronique est également copié sur votre ordinateur lorsque vous installez le logiciel HP Photosmart. Pour vous assurer que le guide a bien été installé sur votre ordinateur :

- **Sous Windows** : lancez le **Centre de solutions HP** et cliquez sur **Aide et support**.
- **Macintosh** : ouvrez le **Gestionnaire de périphériques HP** et sélectionnez **Guide de l'utilisateur** dans le menu contextuel **Informations et réglages**.







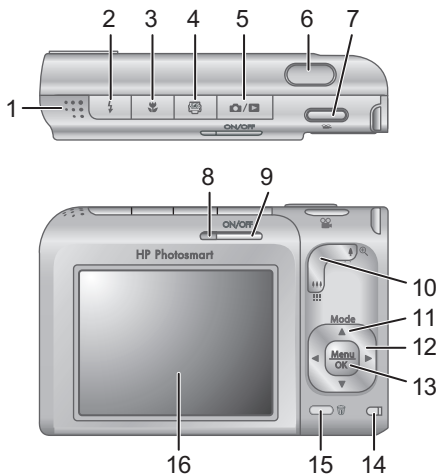





Obtenir une assistance

- Pour bénéficier de conseils et d'outils pour une utilisation plus efficace de votre appareil photo, consultez le site Web www.hp.com/photosmart (en anglais uniquement) ou www.hp.com.
- Pour obtenir une assistance produit, des tests de diagnostic et des pilotes à télécharger 24 heures sur 24 et 7 jours sur 7, consultez le site Web www.hp.com/support.
- Si besoin, reportez-vous à l'aide en ligne du logiciel HP Photosmart.

Dessus et arrière de l'appareil photo



1	Haut-parleur.
2	 Bouton Flash — Les paramètres sont Auto, Flash activé, Flash désactivé.

3	 Bouton Mise au point — Les paramètres sont Normal, Macro, Macro auto, Infini.
4	 Bouton Photosmart Express — Les options sont Imprimer, Partager, Tirages, Favoris, Aide.
5	 Bouton Prévisualisation/Lecture — Permet de basculer entre les modes Prévisualisation et Lecture (voir <i>Prévisualisation et Lecture</i> , page 22).
6	Déclencheur.
7	 Bouton Vidéo.
8	Voyant d'alimentation.
9	Bouton ON/OFF.
10	Bouton de zoom (numérique et optique) — En mode Prévisualisation , appuyez sur  pour effectuer un zoom avant ou sur  pour effectuer un zoom arrière. En mode Lecture , appuyez sur  pour agrandir l'image sélectionnée ou sur  pour afficher des vues miniatures de vos images.
11	Bouton Mode — Appuyez sur  pour accéder au menu Mode de prise de vue lorsque vous êtes en mode Prévisualisation . Les options du Mode de prise de vue sont Mode auto, Paysage, Portrait, Anti-flou, Panorama à droite, Panorama à gauche, Théâtre, Action, Portrait nuit, Paysage nuit, Plage, Neige, Coucher de soleil et Document.
12	Boutons  et  — Permettent de parcourir les menus et les images.
13	Bouton  — Permet d'afficher les menus de l'appareil photo, de sélectionner les options et de confirmer les actions.
14	Voyant de charge de la batterie.

15	 Bouton Supprimer — Permet d'accéder à la fonction Supprimer lorsque vous êtes en mode Lecture .
16	Ecran.

Façade, côté et dessous de l'appareil photo

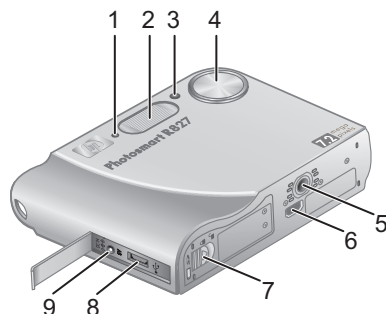

1	Microphone.
2	Flash.
3	Voyant du retardateur/de la mise au point.
4	Objectif.
5	Filetage pour trépied.
6	Connecteur de station d'accueil.
7	Volet du compartiment de la carte mémoire/batterie.
8	Connecteur USB.
9	Connecteur pour adaptateur secteur.

Kit d'adaptation de la station d'accueil

Lorsque vous achetez une station d'accueil HP Photosmart (en option), elle vous est fournie avec plusieurs kits d'adaptation transparents. Pour utiliser la station d'accueil avec cet appareil photo, mettez en place le kit d'adaptation comportant une pastille bleue. Reportez-vous au Guide de l'utilisateur de la station d'accueil pour obtenir des instructions.

2 Préparation de votre appareil photo

Installation de la batterie

1. Ouvrez le volet du compartiment de la batterie/carte mémoire en faisant glisser le loquet, comme indiqué sur le volet du compartiment.
2. Insérez la batterie dans le logement le plus large, puis enfoncez-la jusqu'à enclenchement du loquet.
3. Refermez le volet du compartiment de la batterie/ carte mémoire.

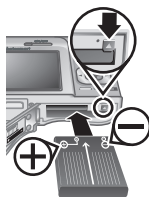

Remarque Eteignez l'appareil photo avant de retirer la batterie. Avant la première utilisation de la batterie, chargez-la complètement.

Chargement de la batterie

Vous pouvez charger la batterie directement dans l'appareil photo, en utilisant l'adaptateur secteur.

1. Branchez la petite extrémité du cordon d'alimentation dans l'adaptateur secteur et la plus grande dans une prise électrique.

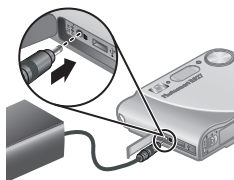

2. Reliez le cordon fin de l'adaptateur secteur et l'appareil photo comme indiqué.

Lorsque le voyant de charge de la batterie clignote, la batterie est en cours de charge. Lorsque ce voyant cesse de clignoter (au bout de 2 à 3 heures), la batterie est entièrement chargée.

Mise en marche de l'appareil photo

Pour mettre en marche votre appareil photo, appuyez sur le bouton ON/OFF.

Choix de la langue

Utilisez ▲▼ ◀▶ pour sélectionner la langue de votre choix, puis appuyez sur $\frac{\text{Menu}}{\text{OK}}$.

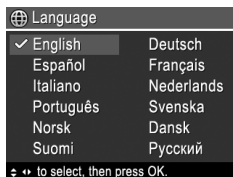

Sélection de la région

Les paramètres **Langue** et **Région** déterminent le format par défaut de la date et du signal vidéo pour l'affichage des images de l'appareil photo sur un téléviseur.



Utilisez ▲▼ pour sélectionner la région de votre choix, puis appuyez sur $\frac{\text{Menu}}{\text{OK}}$.

Réglage de la date et de l'heure

Un réglage précis de la date et de l'heure vous permettra de retrouver plus facilement vos photos une fois celles-

ci chargées sur votre ordinateur et de les marquer précisément si vous utilisez la fonction d'incrustation de la date et de l'heure.

1. Utilisez ▲▼ pour régler la valeur en surbrillance.
2. Utilisez ◀▶ pour passer aux autres choix et réitérez l'étape 1 jusqu'à ce que la date et l'heure soient correctement réglées.
3. Appuyez sur $\frac{\text{Menu}}{\text{OK}}$ lorsque les paramètres de date, d'heure et de format sont corrects, puis appuyez de nouveau sur $\frac{\text{Menu}}{\text{OK}}$ pour confirmation.



Insertion et formatage d'une carte mémoire (en option)





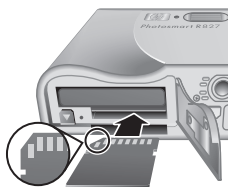



Cet appareil photo prend en charge les cartes mémoire SD (Secure Digital) de marque HP, de 8 Mo à 2 Go (standard et haute vitesse).

1. Eteignez l'appareil photo et ouvrez le volet du compartiment de la batterie/carte mémoire.
2. Insérez la carte mémoire (en option) dans le logement le plus petit, comme illustré. Assurez-vous que la carte mémoire est bien en place.
3. Fermez le volet du compartiment de la batterie/carte mémoire et allumez l'appareil photo.



Formatez toujours les cartes mémoire avant leur première utilisation. Le formatage entraînant la

suppression de toutes les images stockées sur la carte mémoire, veillez à les transférer sur votre ordinateur avant de procéder au formatage.

1. Lorsque l'appareil est allumé, appuyez sur  /  jusqu'à ce que vous passiez en mode **Lecture**.
2. Appuyez sur  pour afficher le sous-menu **Supprimer**.
3. Utilisez   pour sélectionner **Formater la carte**, puis appuyez sur .
4. Utilisez   pour sélectionner **Oui**, puis appuyez sur  pour formater la carte.

Une fois la carte mémoire installée, toutes les nouvelles images et tous les nouveaux clips vidéo ne sont plus stockés dans la mémoire interne mais sur cette carte.

Pour utiliser la mémoire interne et visualiser les images qu'elle contient, retirez la carte mémoire.

Installation du logiciel

Le logiciel HP Photosmart vous permet de transférer des images et des clips vidéo vers votre ordinateur et de modifier des images stockées (suppression des yeux rouges, rotation, recadrage, redimensionnement, amélioration de la qualité d'image, ajout de couleurs et d'effets spéciaux, etc.).

Si vous rencontrez des difficultés pour installer le logiciel HP Photosmart, consultez le site Web du centre d'assistance clientèle HP pour plus d'informations : www.hp.com/support.

Windows

L'installation du logiciel dépend de votre système d'exploitation : soit vous pouvez installer au choix HP Photosmart Premier ou HP Photosmart Essential, soit HP Photosmart Essential est automatiquement installé. HP Photosmart Premier inclut des fonctionnalités supplémentaires par rapport à la version Essential. Pour obtenir une liste des différences, reportez-vous au Chapitre 1 de la version électronique du Guide de l'utilisateur.

1. Fermez tous les programmes et désactivez temporairement tout logiciel antivirus.
2. Insérez le CD HP Photosmart Software dans le lecteur de CD-ROM et suivez les instructions à l'écran. Si la fenêtre d'installation ne s'affiche pas, cliquez sur **Démarrer**, puis sur **Exécuter** et saisissez **D:\Setup.exe** (où **D** correspond à la lettre désignant le lecteur de CD-ROM). Cliquez ensuite sur **OK**.
3. Une fois le logiciel installé, réactivez le logiciel antivirus.

Macintosh

Pour installer le programme HP Photosmart Mac, votre Macintosh doit répondre aux critères de configuration requis, comme indiqué sur l'emballage de votre appareil photo.

1. Insérez le CD HP Photosmart Software dans le lecteur de CD-ROM de votre ordinateur.
2. Cliquez deux fois sur l'icône du CD-ROM située sur le bureau.



3. Cliquez deux fois sur l'icône d'installation et suivez les instructions qui s'affichent à l'écran.

Français

3 Prises de vue et enregistrement de clips vidéo

Le mode **Prévisualisation** vous permet de cadrer vos images et vos clips vidéo dans l'écran.

Prise d'une photo

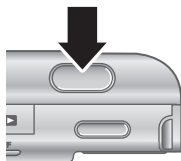

1. Appuyez sur  /  jusqu'à ce que  apparaisse brièvement dans l'angle supérieur droit de l'écran. Cela indique que vous



êtes en mode **Prévisualisation**.

2. Cadrez le sujet de votre photo.
3. Enfoncez le **déclencheur** à mi-course pour mesurer la mise au point et l'exposition. Les parenthèses de mise au point à l'écran apparaissent en vert lorsque la mise au point est verrouillée.
4. Enfoncez entièrement le **déclencheur** pour prendre la photo.
5. Pour ajouter un commentaire audio de 60 secondes maximum, maintenez le **déclencheur** enfoncé, puis relâchez-le lorsque l'enregistrement est terminé.

Enregistrement d'un clip vidéo

1. Appuyez sur  /  jusqu'à ce que  apparaisse brièvement dans l'angle supérieur droit de l'écran. Cela indique que vous êtes en mode

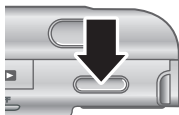





Prévisualisation.

2. Cadrez le sujet.
3. Appuyez sur le bouton **Vidéo**  et relâchez-le.
4. Pour arrêter l'enregistrement de la vidéo, appuyez à nouveau sur le bouton **Vidéo**  et relâchez-le.

4 Revisualisation et suppression des images et des clips vidéo





Revisualisation des images et des clips vidéo

Vous pouvez revoir et supprimer les images et les clips vidéo en mode **Lecture**.

1. Appuyez sur  /  jusqu'à ce que  apparaisse brièvement dans l'angle supérieur droit de l'écran. Cela indique que vous êtes en mode **Lecture**.
2. Utilisez les boutons   pour parcourir vos images et vos clips vidéo (la lecture de ces derniers se lance automatiquement).

Suppression d'une image

Vous pouvez supprimer les images une à une lorsque vous êtes en mode **Lecture** :

1. Appuyez sur  /  jusqu'à ce que  apparaisse brièvement dans l'angle supérieur droit de l'écran. Cela indique que vous êtes en mode **Lecture**.
2. Utilisez  pour sélectionner une image ou un clip vidéo.
3. Appuyez sur  pour afficher le sous-menu **Supprimer**.

4. Utilisez ▲▼ pour sélectionner **Cette image**, puis appuyez sur $\frac{\text{Menu}}{\text{OK}}$.

Français

Revisualisation et suppression des images et des clips vidéo

5 Transfert et impression d'images

Transfert d'images

Si vous avez installé le logiciel HP Photosmart, procédez comme suit pour transférer les images et les clips vidéo sur votre ordinateur. Dans le cas contraire, consultez le Guide de l'utilisateur au format électronique pour obtenir une autre méthode.

Conseil Vous pouvez également effectuer cette tâche à l'aide d'une station d'accueil HP Photosmart (en option) (voir le Guide de l'utilisateur de la station d'accueil).

1. Eteignez l'appareil photo, puis connectez-le à l'ordinateur à l'aide du câble USB fourni avec l'appareil.
2. Allumez l'appareil photo et suivez les instructions qui apparaissent à l'écran de l'ordinateur pour transférer les images. Pour plus d'informations, consultez l'Aide du logiciel HP Photosmart.



Impression d'images à partir de l'appareil photo

Vous pouvez connecter l'appareil photo à n'importe quelle imprimante compatible PictBridge pour imprimer des photos et des images provenant d'un clip vidéo.





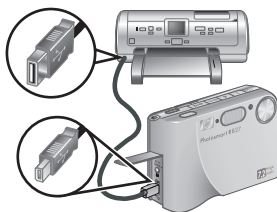



1. Vérifiez que l'imprimante est sous tension, qu'elle contient du papier et qu'elle n'affiche aucun message d'erreur.
2. Connectez l'appareil photo à l'imprimante à l'aide du câble USB fourni avec l'appareil.
3. Allumez l'appareil photo.
4. Lorsque l'appareil photo est connecté à l'imprimante, le menu **Config. d'impression** s'affiche sur l'appareil photo. Pour modifier les paramètres, utilisez ▲▼ sur l'appareil photo pour sélectionner une option de menu, puis ◀▶ pour modifier le paramètre.
5. Appuyez sur $\frac{\text{Menu}}{\text{OK}}$ pour lancer l'impression.



6 Référence rapide de l'appareil photo

Utilisez ce chapitre comme référence rapide sur les fonctionnalités de l'appareil photo. Pour plus d'informations sur les fonctionnalités de cet appareil photo, consultez le Guide de l'utilisateur au format électronique.





Prévisualisation et Lecture



- Le mode **Prévisualisation** vous permet de cadrer vos images et vos clips vidéo dans l'écran. Pour activer le mode **Prévisualisation**, appuyez sur  /  jusqu'à ce que l'icône  apparaisse brièvement dans l'angle supérieur droit de l'écran.
- La fonction **Lecture** permet de revoir et de supprimer les images et les clips vidéo. Pour activer la fonction **Lecture**, appuyez sur le bouton  /  jusqu'à ce que l'icône  apparaisse brièvement dans le coin supérieur droit de l'écran.

Menus



En appuyant sur  ^{Menu} / _{OK} à partir du mode **Lecture** ou du mode **Prévisualisation**, vous accédez aux onglets de menu de l'appareil photo, comme illustré dans cet exemple.





Utilisez   pour atteindre le menu souhaité. Dans le menu, utilisez  /  pour passer d'une sélection à une autre.

Pour quitter le menu, appuyez sur  / .







Les menus et options sont les suivants :

Menu	Options
<p> Capture vous permet de régler différents paramètres de l'appareil photo qui influent sur la qualité des images que vous capturez et des clips vidéo que vous enregistrez avec l'appareil photo.</p>	<ul style="list-style-type: none">● Mode de prise de vue (Mode auto, Paysage, Portrait, Anti-flou, Panorama à droite, Panorama à gauche, Théâtre, Action, Portrait nuit, Paysage nuit, Plage, Neige, Coucher de soleil et Document)● Retardateur● Suppression yeux rouges● Compens. exposition● Eclairage adaptatif● Bracketing● Qualité d'image● Qualité vidéo● Rafale● Balance des blancs● Zone de mise au point auto● Mesure AE● Sensibilité ISO● Saturation● Piqué● Contraste● Inclure date/heure
<p> Lecture vous permet de contrôler et de manipuler les images que vous avez stockées dans l'appareil photo.</p>	<ul style="list-style-type: none">● Conseils image● Propriétés de l'image● Voir diaporama● Juxtapos. pr créer panorama

Menu	Options
	<ul style="list-style-type: none"> ● Commentaire audio ● Dépl. images sur carte
<p> Galerie créative vous permet d'améliorer les images que vous avez capturées.</p>	<ul style="list-style-type: none"> ● Appliquer effets artistiques ● Modifier couleur ● Ajout bordures ● Correction yeux rouges ● Rotation ● Recadrer
<p> Configuration vous permet de modifier le comportement de l'appareil photo.</p>	<ul style="list-style-type: none"> ● Luminosité écran ● Volume sonore ● Voy. mise au pt ● Délai d'extinction de l'écran ● Revisualisation instantanée ● Zoom numérique ● Date et heure ● Configuration USB ● Configuration TV ● Langue ● Réinitialiser paramètres
<p>? Aide comporte des descriptions des fonctionnalités de l'appareil photo et propose des conseils pour prendre vos photos.</p>	<ul style="list-style-type: none"> ● 10 conseils ● Accessoires de l'appareil ● Boutons de l'appareil ● Modes de prise de vue ● Utilisation de la Galerie créative ● Utilisation de Photosmart Express ● Impression d'images ● Enreg. comment. audio

Menu	Options
	<ul style="list-style-type: none">• Enreg. de clips vidéo• Visual. images et vidéos• Extraction images de clips vidéo• Suppression d'images• Transfert d'images• Gestion des batteries• Obtenir de l'assistance• Raccourcis de l'appareil photo• A propos de...

En appuyant sur  à partir du mode **Prévisualisation** ou du mode **Lecture**, vous affichez le menu **Photosmart Express**.

Menu	Options
 Photosmart Express vous permet de sélectionner des photos ou des groupes de photos (Favoris) pour les imprimer, les partager avec des amis ou des proches, ou commander des tirages en ligne.	<ul style="list-style-type: none">•  Imprimer•  Partager•  Tirages•  Favoris•  Aide

Français

Fotocamera digitale HP Photosmart R827

Italiano



Note legali

© Copyright 2006 Hewlett-Packard Development Company, LP
Le informazioni contenute in questo documento sono soggette a modifica senza preavviso. Le uniche garanzie per i prodotti e i servizi HP sono definite nelle dichiarazioni di garanzia esplicita che accompagnano tali prodotti e servizi. Nulla di quanto dichiarato nel presente documento costituisce una garanzia aggiuntiva. HP non sarà ritenuta responsabile di eventuali omissioni o errori tecnici o editoriali qui contenuti.

Windows® è un marchio registrato di Microsoft Corporation negli Stati Uniti.



Il logo SD è un marchio del rispettivo titolare.



Smaltimento di apparecchiature dismesse da parte dei cittadini dell'Unione Europea

La presenza di questo simbolo sul prodotto o sulla sua confezione sta ad indicare che il prodotto non può essere smaltito tra i rifiuti generici. È responsabilità di ogni singolo cittadino smaltire il prodotto consegnandolo al centro di raccolta autorizzato più vicino a scopo di riciclo. La raccolta differenziata di apparecchiature elettriche ed elettroniche dismesse e il loro smaltimento a scopo di riciclo costituiscono una efficace misura di salvaguardia della salute e dell'ambiente. Per ulteriori informazioni sullo smaltimento/riciclo di tali apparecchiature, rivolgersi al proprio rivenditore o all'ente locale preposto.

Per riferimento in futuro, inserire le seguenti informazioni:

- Numero del modello (sul lato anteriore della fotocamera):

- Numero di serie (sul lato inferiore della fotocamera):

- Data di acquisto: _____

Sommario

1	Informazioni preliminari	4
	Accesso alla Guida d'uso online	5
	Parte superiore e posteriore della fotocamera	6
	Vista anteriore, laterale e inferiore della fotocamera	8
	Inserito dell'alloggiamento per la fotocamera	8
2	Configurazione della fotocamera	10
	Installazione della batteria	10
	Carica della batteria	10
	Accensione della fotocamera	11
	Scelta della lingua	11
	Impostazione della regione	11
	Impostazione della data e dell'ora	11
	Installazione e formattazione di una scheda di memoria opzionale	12
	Installazione del software	13
3	Foto e videoclip	15
	Scatto delle foto	15
	Registrazione di videoclip	15
4	Visione e cancellazione di immagini e videoclip	17
	Visione di immagini e videoclip	17
	Cancellazione di un'immagine	17
5	Trasferimento e stampa delle immagini	18
	Trasferimento delle immagini	18
	Stampa delle immagini della fotocamera	19
6	Riferimento rapido per la fotocamera	20

1 Informazioni preliminari

Questa guida rapida fornisce le informazioni per poter iniziare ad utilizzare le funzioni di base della fotocamera. Per informazioni dettagliate sulle funzioni della fotocamera, consultare la Guida d'uso online.

Questa guida rapida	Guida d'uso online
<p data-bbox="197 496 472 519">Questa guida consente di:</p> <ul data-bbox="197 536 487 705" style="list-style-type: none"><li data-bbox="197 536 487 586">• Iniziare subito ad utilizzare la fotocamera<li data-bbox="197 594 487 644">• Installare il software HP Photosmart<li data-bbox="197 651 487 705">• Uso delle funzioni base della fotocamera	<p data-bbox="508 496 741 546">La Guida d'uso online contiene:</p> <ul data-bbox="508 564 819 1148" style="list-style-type: none"><li data-bbox="508 564 819 644">• Una descrizione di tutte le funzioni della fotocamera<li data-bbox="508 651 819 731">• Una descrizione delle icone visualizzate sul display LCD<li data-bbox="508 738 819 968">• Informazioni sulla batteria, tra cui:<ul data-bbox="560 805 819 968" style="list-style-type: none"><li data-bbox="560 805 819 856">– Ottimizzazione della durata della batteria<li data-bbox="560 863 819 968">– Una descrizione delle icone relative all'indicatore di alimentazione<li data-bbox="508 975 819 999">• Soluzione dei problemi<li data-bbox="508 1006 819 1086">• Informazioni per richiedere l'assistenza HP<li data-bbox="508 1093 819 1148">• Specifiche della fotocamera

Accesso alla Guida d'uso online



La Guida d'uso online è disponibile sul CD del software HP Photosmart (HP Photosmart Software CD).

Per visualizzare la Guida d'uso:

1. Inserire il CD del software HP Photosmart nell'unità CD del computer.
2. **In Windows:** Fare clic su **Visualizza la Guida d'uso** nella pagina principale della schermata di installazione.
In Macintosh: Aprire il file **readme** nella cartella **docs** del CD.

La Guida d'uso online viene inoltre copiata sul computer quando si installa il software HP Photosmart. Per visualizzare la Guida d'uso dopo che è stata installata sul computer:

- **In Windows:** Aprire **Centro soluzioni HP** e fare clic su **Guida in linea**.
- **In Macintosh:** Aprire **HP Device Manager** e selezionare **Guida d'uso** dal menu a comparsa **Informazioni e impostazioni**.





Assistenza e supporto



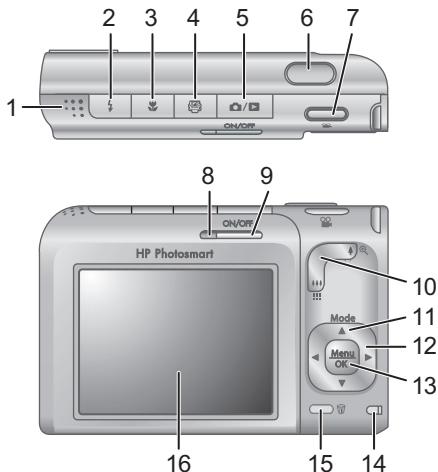







- Per suggerimenti e strumenti che permettano di ottimizzare l'utilizzo della fotocamera, visitare il sito Web all'indirizzo **www.hp.com/photosmart** (solo inglese) oppure **www.hp.com**.
- Per richiedere assistenza per il prodotto, scaricare i driver o eseguire programmi di diagnostica 24 ore al giorno, 7 giorni alla settimana, visitare il sito Web all'indirizzo **www.hp.com/support**.

- Per le istruzioni sull'uso del software HP Photosmart, vedere la relativa Guida online.

Parte superiore e posteriore della fotocamera



1	Altoparlante.
2	 Pulsante flash : Le impostazioni sono Auto, Flash On, Flash Off.
3	 Pulsante messa a fuoco : Le impostazioni sono Normale, Macro, Auto Macro, Infinito.
4	 Pulsante Photosmart Express : Le opzioni disponibili sono Stampa, Condividi, Acquisto stampe online, Preferiti, ?.
5	 Pulsante vista al vivo/riproduzione : Consente di passare dalla modalità Vista dal vivo alla modalità

	Riproduzione (vedere <i>Vista dal vivo e Riproduzione</i> a pagina 20).
6	Pulsante otturatore .
7	 Pulsante video .
8	Spia di accensione.
9	Pulsante ON/OFF.
10	Leva zoom (digitale e ottico): Nella vista dal vivo , premere  per aumentare l'ingrandimento oppure  per diminuirlo. Nella modalità Riproduzione , premere  per ingrandire l'immagine selezionata oppure  per visualizzare delle anteprime delle immagini.
11	Pulsante modalità di scatto : Premere  per accedere al menu delle modalità di scatto quando è attivata la vista dal vivo . Le impostazioni della modalità di scatto sono Automatica, Panorama, Ritratto, Scatto stabile, Panoramica verso destra, Panoramica verso sinistra, Teatro, Azione, Ritratto notturno, Scenario notturno, Spiaggia, Neve, Tramonto, Documento.
12	  e  : Consentono di scorrere i menu e le immagini.
13	Pulsante  : Consente di visualizzare i menu della fotocamera, selezionare le opzioni e confermare le azioni.
14	Spia di ricarica della batteria.
15	 Pulsante eliminazione : Consente di accedere alla funzione Elimina quando è attiva la modalità Riproduzione .
16	Display LCD.

Vista anteriore, laterale e inferiore della fotocamera

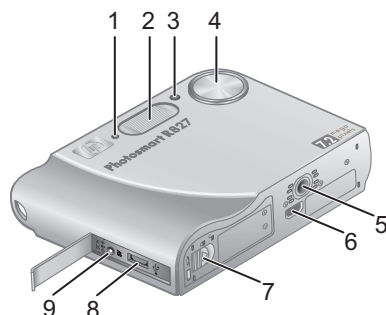

1	Microfono.
2	Flash.
3	Spia Autoscatto/Supporto messa a fuoco.
4	Obiettivo.
5	Attacco treppiede.
6	Connettore alloggiamento.
7	Sportello vano batteria/scheda di memoria.
8	Connettore USB.
9	Connettore dell'adattatore di alimentazione.

Inserto dell'alloggiamento per la fotocamera

L'alloggiamento opzionale HP Photosmart viene fornito con più inserti. Quando si prepara l'alloggiamento perché possa essere utilizzato con questa fotocamera, utilizzare l'inserto contrassegnato da un'etichetta

circolare blu. Vedere la guida d'uso dell'alloggiamento per le istruzioni.

Italiano

2 Configurazione della fotocamera

Installazione della batteria

1. Aprire lo sportello del vano batteria/scheda di memoria facendo scorrere il fermo come indicato sullo sportello.
2. Inserire la batteria nel vano più grande e spingerla fino a quando non si blocca in posizione.
3. Chiudere lo sportello del vano batteria/scheda di memoria.

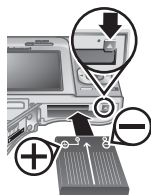

Nota Spegnerne la fotocamera prima di rimuovere la batteria. Caricare completamente la batteria prima di utilizzarla per la prima volta.

Carica della batteria

È possibile caricare la batteria mentre è nella fotocamera usando l'adattatore CA.

1. Collegare l'estremità piccola del cavo di alimentazione all'adattatore CA e l'estremità grande ad una presa di corrente.
2. Collegare il cavo sottile dell'adattatore CA alla fotocamera, come illustrato nella figura.

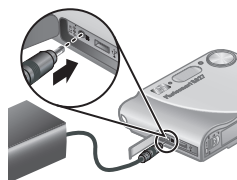

La spia di ricarica della batteria presente sulla fotocamera inizia a lampeggiare, ad indicare che la

batteria si sta caricando; quando la spia smette di lampeggiare e resta accesa con luce fissa significa che la batteria è completamente carica (l'operazione di ricarica dura circa 2–3 ore).

Accensione della fotocamera

Per accendere la fotocamera, premere il pulsante ON/OFF.

Scelta della lingua

Usare ▲▼◀▶ per evidenziare la lingua desiderata e quindi premere

Menu
OK .

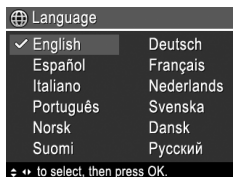

Impostazione della regione

Insieme all'impostazione della **Lingua**, quella della **Regione** determina il formato predefinito per la data e per il segnale video usato per visualizzare le immagini della fotocamera su un televisore.



Usare ▲▼ per evidenziare la regione desiderata e quindi premere Menu OK .

Impostazione della data e dell'ora

Impostando con precisione la data e l'ora risulterà più semplice identificare le foto dopo che sono state caricate sul computer e, se si usa la funzione di inserimento di

data e ora, le foto verranno contrassegnate correttamente.

1. Usare ▲▼ per regolare il valore evidenziato.
2. Usare ◀▶ per passare alle altre selezioni e ripetere il passo 1 finché la data e l'ora non sono impostate correttamente.
3. Premere $\frac{\text{Menu}}{\text{OK}}$ quando le impostazioni di data, ora e formato sono corrette e quindi premere nuovamente $\frac{\text{Menu}}{\text{OK}}$ per confermare.

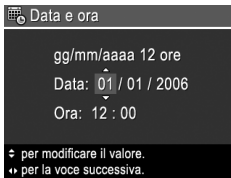

Installazione e formattazione di una scheda di memoria opzionale





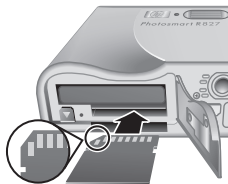





Questa fotocamera supporta schede di memoria HP Secure Digital (SD), sia standard che ad alta velocità, da 8 MB a 2 GB.

1. Spegnerla fotocamera e aprire lo sportello del vano batteria/scheda di memoria.
2. Inserire la scheda di memoria opzionale nell'alloggiamento più piccolo, come mostrato nella figura. Accertarsi che la scheda di memoria scatti in posizione.
3. Chiudere lo sportello del vano batteria/scheda di memoria ed accendere la fotocamera.



Formattare sempre le schede di memoria prima di utilizzarle per la prima volta. La formattazione rimuove

dalla scheda tutte le immagini, pertanto è importante trasferire le immagini presenti sulla scheda prima di formattarla.

1. Quando la fotocamera è accesa, premere  /  fino a quando non viene attivata la modalità **Riproduzione**.
2. Premere  per visualizzare il sottomenu **Elimina**.
3. Usare   per selezionare **Formatta scheda** e poi premere  .
4. Usare   per selezionare **Si**, quindi premere   per formattare la scheda.

Quando si installa una scheda di memoria nella fotocamera, tutte le nuove immagini e i videoclip vengono memorizzati sulla scheda e non nella memoria interna.

Per utilizzare la memoria interna e visualizzare le immagini in essa memorizzate, è necessario prima rimuovere la scheda di memoria.

Installazione del software

Il software HP Photosmart dispone di specifiche funzioni per trasferire sul computer immagini e videoclip e per modificare le immagini memorizzate (ad esempio, è possibile rimuovere gli occhi rossi, ruotare, ritagliare, ridimensionare le foto, modificarne la qualità, aggiungere colori ed effetti speciali, ecc.).

Se durante l'installazione o l'uso del software HP Photosmart si verificano dei problemi, visitare il sito Web per l'assistenza clienti HP per richiedere maggiori informazioni: **www.hp.com/support**.

Windows

A seconda del sistema operativo utilizzato, sarà possibile scegliere se installare HP Photosmart Premier o HP Photosmart Essential oppure HP Photosmart Essential verrà installato automaticamente.

HP Photosmart Premier include un numero di funzioni superiore rispetto alla versione Essential. Vedere il Capitolo 1 nella Guida d'uso online per un elenco delle differenze tra le due versioni.

1. Chiudere tutti i programmi e disattivare temporaneamente eventuali software antivirus.
2. Inserire il CD del software HP Photosmart nell'unità CD e seguire le istruzioni visualizzate. Se non viene visualizzata la finestra di installazione, fare clic su **Start, Esegui**, digitare **D:\Setup.exe** (dove **D** è la lettera che corrisponde all'unità CD) e quindi fare clic su **OK**.
3. Terminata l'installazione del software, riattivare il software antivirus.

Macintosh



Per installare il software HP Photosmart Mac, è necessario che il computer Macintosh soddisfi i requisiti di sistema indicati sulla confezione della fotocamera.

1. Inserire il CD del software HP Photosmart nell'unità CD.
2. Fare doppio clic sull'icona del CD sulla scrivania.
3. Fare doppio clic sull'icona del programma di installazione e seguire le istruzioni visualizzate.

3 Foto e videoclip



La modalità **Vista dal vivo** consente di inquadrare le foto e i videoclip sul display LCD.

Scatto delle foto

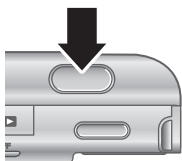

1. Premere  /  fino a quando nell'angolo superiore destro del display LCD non appare . Ciò indica che è attiva la modalità **Vista dal vivo**.
2. Inquadrare il soggetto della foto.
3. Premere a metà il pulsante **otturatore** per misurare e bloccare la messa a fuoco e l'esposizione. Il quadro di messa a fuoco sul display LCD si accende con luce verde fissa quando la messa a fuoco è bloccata.
4. Premere fino in fondo il pulsante **otturatore** per scattare la foto.
5. Per aggiungere un clip audio della durata massima di 60 secondi, continuare a tenere premuto il pulsante **otturatore** e rilasciarlo una volta terminata la registrazione.

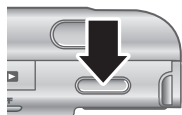

Registrazione di videoclip

1. Premere  /  fino a quando nell'angolo superiore destro del display LCD non appare . Ciò indica che è attiva la modalità **Vista dal vivo**.
2. Inquadrare il soggetto.







3. Premere e rilasciare il pulsante **video** .
4. Per interrompere la registrazione, premere e rilasciare di nuovo il pulsante **video** .

4 Visione e cancellazione di immagini e videoclip











Visione di immagini e videoclip

In modalità **Riproduzione** è possibile rivedere e cancellare foto e videoclip.

1. Premere  /  fino a quando nell'angolo superiore destro del display LCD non appare . Ciò indica che è attiva la modalità **Riproduzione**.
2. Usare   per scorrere foto e videoclip (la riproduzione dei videoclip parte automaticamente).

Cancellazione di un'immagine

Quando è attiva la modalità **Riproduzione** si possono eliminare singole immagini:

1. Premere  /  fino a quando nell'angolo superiore destro del display LCD non appare . Ciò indica che è attiva la modalità **Riproduzione**.
2. Usare   per selezionare un'immagine o un videoclip.
3. Premere  per visualizzare il sottomenu **Elimina**.
4. Usare   per selezionare **Corrente**, quindi premere  .

5 Trasferimento e stampa delle immagini

Trasferimento delle immagini

Se è stato installato il software HP Photosmart, utilizzarlo per trasferire immagini e videoclip sul computer. Se non è stato installato il software HP Photosmart, consultare la Guida d'uso online per un metodo alternativo.

Suggerimento È possibile eseguire questa operazione anche utilizzando un alloggiamento opzionale HP Photosmart (vedere la guida d'uso dell'alloggiamento).

1. Spegnere la fotocamera e poi collegarla al computer usando il cavo USB fornito con la fotocamera.
2. Accendere la fotocamera e seguire le istruzioni visualizzate sullo schermo del computer per trasferire le immagini. Per ulteriori informazioni, consultare la guida online del software HP Photosmart.

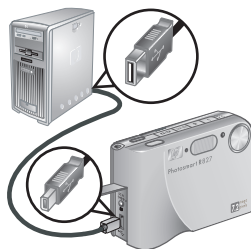

Stampa delle immagini della fotocamera

È possibile collegare la fotocamera ad una qualsiasi stampante compatibile PictBridge per stampare foto e inquadrature estratte dai videoclip.





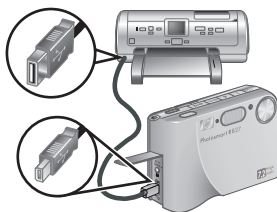



1. Verificare che la stampante sia accesa, che la carta sia caricata e che non siano visualizzati messaggi di errore relativi alla stampante.
2. Collegare la fotocamera e la stampante usando il cavo USB fornito con la fotocamera.
3. Accendere la fotocamera.
4. Dopo che la fotocamera è stata collegata alla stampante, sulla fotocamera viene visualizzato il menu **Imposta stampante**. Per modificare le impostazioni, usare ▲▼ sulla fotocamera per selezionare un'opzione e, quindi, usare ◀▶ per modificarne l'impostazione.
5. Premere $\frac{\text{Menu}}{\text{OK}}$ per iniziare a stampare.



6 Riferimento rapido per la fotocamera

Usare questo capitolo come riferimento rapido alle funzioni della fotocamera. Per maggiori informazioni sulle funzioni della fotocamera, consultare la Guida d'uso online.

Vista dal vivo e Riproduzione





- La modalità **Vista dal vivo** consente di inquadrare le foto e i videoclip nel display LCD. Per attivare la **vista dal vivo**, premere  /  fino a quando nell'angolo superiore destro del display LCD non appare .
- La modalità **Riproduzione** consente di rivedere e cancellare immagini e videoclip. Per attivare la **riproduzione**, premere  /  fino a quando nell'angolo superiore destro del display LCD non appare .



Menu

Quando si preme  mentre è attiva la modalità



Riproduzione o **Vista dal vivo**, si accede ai menu della fotocamera, come mostrato nella schermata di esempio.





Usare   per spostarsi sul menu desiderato. All'interno di un menu, usare   per spostarsi sulle opzioni desiderate.

Per chiudere il menu, premere in un qualsiasi momento  / .







I menu e le opzioni sono:

Menu	Opzioni
<p> Cattura consente di regolare le impostazioni della fotocamera che incidono sulle caratteristiche di immagini e videoclip che si cattureranno con la fotocamera.</p>	<ul style="list-style-type: none">● Modalità di scatto (Automatica, Panorama, Ritratto, Scatto stabile, Panoramica verso destra, Panoramica verso sinistra, Teatro, Azione, Ritratto notturno, Scenario notturno, Spiaggia, Neve, Tramonto, Documento)● Autoscatto● Eliminazione occhi rossi● Compensazione esposizione● Illuminazione adattativa● Esposizione a forcella● Qualità img.● Qualità video● Scatto continuo● Bilanciam. bianco● Area messa a fuoco autom.● Esposizione AE● Velocità ISO● Saturazione● Nitidezza● Contrasto● Inserimento di data e ora
<p> Riproduzione consente di rivedere e manipolare le immagini salvate nella fotocamera.</p>	<ul style="list-style-type: none">● Suggestimenti● Info immagine● Visualizza presentazione● Cuci panoramica

Menu	Opzioni
	<ul style="list-style-type: none"> ● Registra audio ● Sposta imm. su scheda...
<p> Galleria effetti consente di migliorare le immagini catturate.</p>	<ul style="list-style-type: none"> ● Applica effetti artistici ● Modifica colore ● Aggiungi contorni ● Elimina occhi rossi ● Ruota ● Ritaglia
<p> Configura consente di modificare le impostazioni della fotocamera.</p>	<ul style="list-style-type: none"> ● Lumin. display ● Volume suoni ● Luce supp. fuoco ● Timeout display ● Revisione ● Zoom digitale ● Data e ora ● Configurazione USB ● Configurazione TV ● Lingua ● Ripristina impostazioni...
<p>? ? descrive le funzioni della fotocamera e fornisce dei suggerimenti per migliorare gli scatti.</p>	<ul style="list-style-type: none"> ● 10 utili suggerimenti ● Accessori ● Pulsanti fotocamera ● Uso delle modalità di scatto ● Utilizzo della galleria degli effetti ● Uso di Photosmart Express ● Stampa immagini ● Registrazione clip audio ● Registrazione videoclip

Menu	Opzioni
	<ul style="list-style-type: none"> • Revisione immagini e video • Estrazione stampe da video • Cancellazione immagini • Trasferimento immagini • Manutenzione batterie • Assistenza • Accesso rapido • Info su...

Quando si preme  mentre è attiva la modalità **Vista dal vivo** o **Riproduzione**, viene visualizzato il menu **Photosmart Express**.

Menu	Opzioni
 Photosmart Express consente di selezionare foto o gruppi di foto (preferite) da stampare, acquistare online o condividere con amici e parenti.	<ul style="list-style-type: none"> •  Stampa •  Condividi •  Acquisto stampe online •  Preferiti •  Guida

Italiano

HP Photosmart R827 Digitalkamera

Deutsch



Rechtliche Hinweise

© Copyright 2006 Hewlett-Packard Development Company, L.P.

Die Informationen in diesem Dokument können ohne vorherige Ankündigung geändert werden. Für HP Produkte und Dienste gelten nur die Gewährleistungen, die in den ausdrücklichen Gewährleistungserklärungen des jeweiligen Produkts bzw. Dienstes aufgeführt sind. Dieses Dokument gibt keine weiteren Gewährleistungen. HP haftet nicht für technische oder redaktionelle Fehler oder Auslassungen in diesem Dokument. Windows® ist eine in den USA eingetragene Marke der Microsoft Corporation.

Das  SD-Logo ist eine Marke des entsprechenden Eigentümers.



Entsorgung von Altgeräten durch Benutzer in Privathaushalten in der EU

 Dieses Symbol auf dem Produkt oder auf der Verpackung weist darauf hin, dass das Produkt nicht als Hausmüll entsorgt werden darf. Sie sind stattdessen dafür verantwortlich, Altgeräte bei der zuständigen Sammelstelle zum Recycling von Elektrogeräten und Elektronikzubehör abzugeben. Mülltrennung und das Recycling von Altgeräten schonen die natürlichen Ressourcen und stellen sicher, dass die Geräte in einer Art und Weise wiederverwertet werden, die die Gesundheit von Menschen und die Umwelt schützt. Weitere Informationen zu den Sammelstellen für Ihre Altgeräte zum Recycling erhalten Sie bei der zuständigen Stelle der Stadtverwaltung, beim Entsorgungsunternehmen für Ihren Hausmüll oder in dem Geschäft, in dem das Produkt gekauft wurde.

Notieren Sie für zukünftige Nachfragen die folgenden Daten:

- Modellnummer (Vorderseite der Kamera): _____
- Seriennummer (Unterseite der Kamera): _____
- Kaufdatum: _____

Inhalt

1	Erste Schritte	4
	Zugreifen auf das elektronische Benutzerhandbuch	5
	Ober- und Rückseite der Kamera	6
	Vorderseite, Seite und Unterseite der Kamera	8
	Dockingeinsatz für die Kamera	8
2	Einrichten Ihrer Kamera	10
	Einsetzen der Batterie	10
	Aufladen der Batterie	10
	Einschalten der Kamera	11
	Auswählen der Sprache	11
	Einstellen der Region	11
	Einstellen von Datum und Uhrzeit	12
	Einsetzen und Formatieren einer optionalen Speicherkarte	13
	Installieren der Software	14
3	Aufnahmen von Bildern und Videoclips	16
	Aufnahmen eines Einzelbilds	16
	Aufnahmen eines Videoclips	17
4	Betrachten und Löschen von Bildern und Videoclips	18
	Betrachten von Bildern und Videoclips	18
	Löschen eines Bilds	18
5	Übertragen und Drucken von Bildern	20
	Übertragen von Bildern	20
	Drucken von Bildern von der Kamera aus	21
6	Kurzreferenz für Kamerafunktionen	22

1 Erste Schritte

Diese gedruckte Kurzeinführung enthält alle notwendigen Informationen zur erstmaligen Verwendung der grundlegenden Funktionen der Kamera. Im elektronischen Benutzerhandbuch finden Sie detaillierte Informationen zu den Funktionen der Kamera.

Kurzeinführung	Elektronisches Benutzerhandbuch
<p>Dieses gedruckte Handbuch behandelt folgende Themen:</p> <ul style="list-style-type: none">• Schnelle Inbetriebnahme der Kamera• Installation der HP Photosmart-Software• Vorstellung der grundlegenden Kamerafunktionen	<p>Das elektronische Benutzerhandbuch behandelt folgende Themen:</p> <ul style="list-style-type: none">• Beschreibungen aller Kamerafunktionen• Beschreibung der Symbole auf der Bildanzeige• Informationen zu Batterien/Akkus, einschließlich:<ul style="list-style-type: none">– Verlängerung der Batterielebensdauer– Beschreibung der Stromversorgungssymbole• Fehlerbehebung• Unterstützung durch HP• Technische Daten der Kamera

Zugreifen auf das elektronische Benutzerhandbuch



Das elektronische Benutzerhandbuch befindet sich auf der HP Photosmart Software CD.

So zeigen Sie das Benutzerhandbuch an:

1. Legen Sie die HP Photosmart Software CD in das CD-Laufwerk Ihres Computers ein.
2. **Unter Windows:** Klicken Sie auf der Hauptseite der Installationsanzeige auf **Benutzerhandbuch anzeigen**.
Unter Macintosh: Öffnen Sie auf der CD im Ordner **docs** die **Readme**-Datei.

Das elektronische Benutzerhandbuch wird auf Ihren Computer kopiert, wenn Sie die HP Photosmart-Software installieren. Gehen Sie wie folgt vor, um sich das Benutzerhandbuch nach dessen Installation auf dem Computer anzeigen zu lassen:

- **Unter Windows:** Öffnen Sie das **HP Solution Center**, und klicken Sie auf **Hilfe und Support**.
- **Unter Macintosh:** Öffnen Sie den **HP Device Manager** (HP Geräte-Manager), und wählen Sie **Kamera-Benutzerhandbuch** im Popup-Menü **Information and Settings** (Informationen und Einstellungen) aus.

Unterstützung







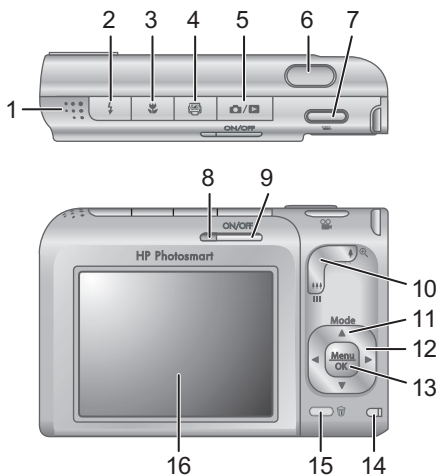



- Tipps und Tools zur effizienten Nutzung der Kamera finden Sie unter **www.hp.com/photosmart** (nur in englischer Sprache) oder **www.hp.com**.

- Weitere Unterstützung zum Produkt, Diagnosefunktionen und Treiber-Downloads erhalten Sie rund um die Uhr (24x7) unter **www.hp.com/support**.
- Weitere Informationen zur HP Photosmart-Software finden Sie in der Onlinehilfe für die Software.

Ober- und Rückseite der Kamera



1	Lautsprecher.
2	Blitz (Taste) – Die möglichen Einstellungen sind "Autom.", "Blitz Ein" und "Blitz Aus".
3	Fokus (Taste) – Die möglichen Einstellungen sind "Normaler Fokus", "Makro", "Autom. Makro" und "Unendlich".

4	 Photosmart Express (Taste) – Die verfügbaren Optionen sind: Drucken, Share, Abzüge kaufen, Favoriten und Hilfe.
5	 Vorschau/Wiedergabe (Taste) – Dient zum Wechseln zwischen Vorschau und Wiedergabe (siehe „ <i>Vorschau und Wiedergabe</i> “ auf Seite 22).
6	Auslöser.
7	 Video (Taste).
8	Netzkontrollleuchte.
9	ON/OFF (Ein-/Aus-Taste).
10	Zoom -Hebel (digital und optisch) – Drücken Sie im Modus Vorschau auf das Symbol  , um einzuzoomen, oder auf das Symbol  , um auszuzoomen. Drücken Sie im Modus Wiedergabe auf das Symbol  , um das ausgewählte Bild zu vergrößern, oder auf das Symbol  , um Miniaturansichten Ihrer Bilder anzuzeigen.
11	Mode (Modus, Taste) – Drücken Sie das Symbol  , um im Modus Vorschau auf das Menü Aufnahmemodus zuzugreifen. Das Menü Aufnahmemodus umfasst folgende Optionen: Autom., Landschaft, Portrait, Stabile Aufnahme, Panorama Rechts, Panorama Links, Theater, Action, Nachtportrait, Nachtszene, Strand, Schnee, Sonnenuntergang, Dokument.
12	  (Tasten) – Dienen zum Blättern durch Menüs und Bilder.
13	 (Menü/OK, Taste) – Dient zum Anzeigen von Kameramenüs, Auswählen von Optionen und Bestätigen von Aktionen.
14	Ladekontrollleuchte.

15	 Löschen (Taste) – Dient zum Zugreifen auf die Funktion Löschen im Modus Wiedergabe .
16	Bildanzeige.

Vorderseite, Seite und Unterseite der Kamera

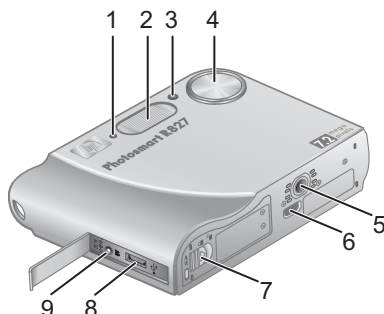

1	Mikrofon
2	Blitz
3	Selbstausröser/Fokus-Hilfslicht
4	Objektiv
5	Stativhalterung
6	Dockinganschluss
7	Klappe des Batterie-/Speicherartenfachs
8	USB-Anschluss
9	Netzteilananschluss

Dockingeinsatz für die Kamera

Wenn Sie eine optionale HP Photosmart Kamera-Dockingstation erwerben, wird diese mit mehreren

leeren Einsätzen geliefert. Verwenden Sie zum Einrichten der optionalen Dockingstation für diese Kamera den Dockingeinsatz mit dem runden blauen Etikett. Die zugehörigen Anweisungen finden Sie im Benutzerhandbuch für die Dockingstation.

2 Einrichten Ihrer Kamera

Einsetzen der Batterie

1. Öffnen Sie die Klappe des Batterie-/Speicherkartenfachs, indem Sie die Verriegelung wie auf der Klappe dargestellt verschieben.
2. Setzen Sie die Batterie in das größere Fach ein, und schieben Sie diese hinein, bis die Verriegelung greift.
3. Schließen Sie die Klappe des Batterie-/Speicherkartenfachs.



Hinweis Schalten Sie die Kamera aus, bevor Sie die Batterie herausnehmen. Laden Sie die Batterie vollständig auf, bevor Sie diese zum ersten Mal verwenden.

Aufladen der Batterie

Über das Netzteil können Sie eine in die Kamera eingesezte Batterie aufladen.

1. Schließen Sie das schmale Ende des Netzkabels an das Netzteil und das andere Ende an eine Netzsteckdose an.

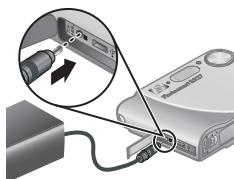

2. Schließen Sie das dünne Kabel des Netzteils an die Kamera an (siehe Abb.).

Während des Ladevorgangs blinkt die Ladekontrollleuchte der Kamera. Die Batterie ist vollständig aufgeladen, wenn die Kontrollleuchte permanent leuchtet (nach ungefähr 2 bis 3 Stunden).

Einschalten der Kamera

Drücken Sie zum Einschalten der Kamera die Taste ON/OFF (Ein/Aus).

Auswählen der Sprache

Mit den Tasten ▲▼
◀▶ wählen Sie die gewünschte Sprache aus. Drücken Sie anschließend die Taste $\frac{\text{Menu}}{\text{OK}}$.

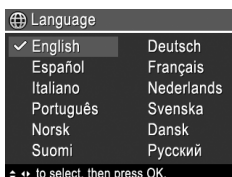

Einstellen der Region

Die Einstellung für die **Sprache** legt zusammen mit der Einstellung für die **Region** die Standardwerte für das Datumsformat und das Format von Videosignalen fest, die beim Anzeigen von Kamerabildern auf einem Fernsehgerät verwendet werden.



Mit den Tasten ▲▼ wählen Sie die gewünschte Region aus. Drücken Sie danach die Taste $\frac{\text{Menu}}{\text{OK}}$.

Einstellen von Datum und Uhrzeit

Wenn Sie das Datum und die Uhrzeit korrekt einstellen, können Sie die Bilder später schneller finden, nachdem diese auf den Computer übertragen wurden. Außerdem stellen Sie dadurch sicher, dass die Bilder korrekt markiert werden, wenn Sie die Funktion für einen Datums- und Uhrzeitstempel nutzen.

1. Mit den Tasten ▲▼ passen Sie den jeweils hervorgehobenen Wert an.
2. Mit den Tasten ◀▶ wechseln Sie zu den anderen Auswahlmöglichkeiten. Wiederholen Sie danach Schritt 1, bis das Datum und die Uhrzeit korrekt eingestellt sind.
3. Drücken Sie die Taste $\frac{\text{Menu}}{\text{OK}}$, sobald das Datum, die Uhrzeit und die Formateinstellungen korrekt sind. Drücken Sie danach erneut die Taste $\frac{\text{Menu}}{\text{OK}}$, um die Einstellungen zu bestätigen.

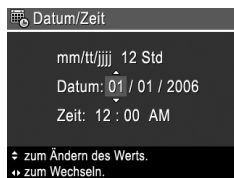





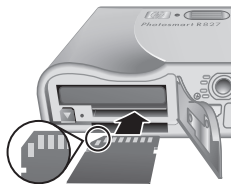

Einsetzen und Formatieren einer optionalen Speicherkarte

Diese Kamera unterstützt Secure Digital (SD) Speicherkarten der Marke HP (Standard und High Speed) mit 8 MB bis zu 2 GB.

1. Schalten Sie die Kamera aus, und öffnen Sie die Klappe des Batterie-/Speicherkartenfachs.
2. Setzen Sie die optionale Speicherkarte in das kleinere Fach ein (siehe Abbildung). Stellen Sie sicher, dass die Speicherkarte einrastet.
3. Schließen Sie die Klappe des Batterie-/Speicherkartenfachs, und schalten Sie die Kamera ein.



Sie müssen neue Speicherkarten immer formatieren, bevor Sie diese zum ersten Mal verwenden. Durch die Formatierung werden alle Bilder von der Speicherkarte gelöscht. Stellen Sie sicher, dass Sie alle vorhandenen Bilder vor der Formatierung hochladen bzw. übertragen.

1. Drücken Sie bei eingeschalteter Kamera die Taste  / , bis sich die Kamera im Modus **Wiedergabe** befindet.
2. Drücken Sie die Taste , um das Untermenü **Löschen** aufzurufen.
3. Wählen Sie mit Hilfe der Tasten   die Option **Speicherk. formatieren** aus. Drücken Sie danach die Taste  .

4. Wählen Sie mit den Tasten ▲▼ die Option **Ja** aus. Drücken Sie danach die Taste ^{Menu}_{OK}, um die Speicherkarte zu formatieren.

Wenn eine Speicherkarte eingesetzt ist, werden alle neuen Bilder und Videoclips nicht mehr im internen Speicher, sondern auf der Speicherkarte gespeichert.

Nehmen Sie die Speicherkarte heraus, um den internen Speicher zu verwenden und alle dort gespeicherten Bilder anzuzeigen.

Installieren der Software

Die HP Photosmart-Software umfasst Funktionen zum Übertragen von Bildern und Videoclips auf Ihren Computer sowie zum Ändern gespeicherter Bilder (u. a. Entfernen roter Augen, Drehen, Zuschneiden, Ändern der Größe, Anpassen der Bildqualität sowie Hinzufügen von Farben und Spezialeffekten).

Sollten bei der Installation oder der Verwendung der HP Photosmart-Software Probleme auftreten, lesen Sie die Informationen auf der Website der HP Kundenunterstützung (HP Customer Care): **www.hp.com/support**.

Windows

Je nach Betriebssystem haben Sie die Möglichkeit, HP Photosmart Premier oder HP Photosmart Essential zu installieren, oder HP Photosmart Essential wird automatisch installiert. HP Photosmart Premier bietet im Vergleich zur Essential-Version zusätzliche Funktionen.

Eine Liste der Unterschiede finden Sie in Kapitel 1 des elektronischen Benutzerhandbuchs.

1. Schließen Sie alle Programme, und deaktivieren Sie vorübergehend sämtliche Virenschutzsoftware.
2. Legen Sie die HP Photosmart Software CD in das CD-Laufwerk ein, und befolgen Sie die angezeigten Anweisungen. Wenn das Installationsfenster nicht angezeigt wird, klicken Sie auf **Start** und **Ausführen**. Geben Sie dann **D:\Setup.exe** ein (wobei **D** für den Buchstaben Ihres CD-Laufwerks steht). Klicken Sie danach auf **OK**.
3. Nach erfolgreicher Installation der Software müssen Sie die Virenschutzsoftware wieder aktivieren.

Macintosh



Damit Sie die HP Photosmart Mac-Software installieren können, muss Ihr Macintosh-Computer die Mindestanforderungen erfüllen, die auf der Kameraverpackung angegeben sind.

1. Legen Sie die HP Photosmart Software CD in das CD-Laufwerk ein.
2. Doppelklicken Sie auf dem Desktop auf das CD-Symbol.
3. Doppelklicken Sie auf das Symbol des Installationsprogramms, und befolgen Sie die angezeigten Anweisungen.





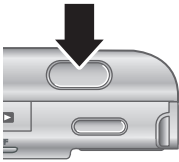

3 Aufnahmen von Bildern und Videoclips

Die **Vorschau** ermöglicht das Erfassen von Motiven für Bilder und Videoclips über die Bildanzeige.

Aufnahmen eines Einzelbilds

1. Drücken Sie die Taste  / , bis das Symbol  für kurze Zeit rechts oben in der Bildanzeige erscheint. Dadurch wird angezeigt, dass sich die Kamera im Modus **Vorschau** befindet. 
2. Erfassen Sie das Motiv für Ihr Bild.
3. Drücken Sie den **Auslöser** halb herunter, um Belichtung und Fokus zu sperren. Die Fokuskammern in der Bildanzeige werden grün angezeigt, sobald der Fokus gesperrt ist.
4. Drücken Sie den **Auslöser** ganz herunter, um das Bild aufzunehmen.
5. Wenn Sie einen Audioclip mit einer Länge von bis zu 60 Sekunden hinzufügen möchten, halten Sie den **Auslöser** weiterhin gedrückt. Lassen Sie ihn erst los, wenn die Aufnahme fertig gestellt ist.





Aufnehmen eines Videoclips

1. Drücken Sie die Taste  / , bis das Symbol  für kurze Zeit rechts oben in der Bildanzeige erscheint. Dadurch wird angezeigt, dass sich die Kamera im Modus **Vorschau** befindet.
- 
2. Erfassen Sie das Motiv.
 3. Drücken Sie die Taste **Video** , und lassen Sie diese wieder los.
 4. Drücken Sie die Taste **Video**  erneut, und lassen Sie diese wieder los, um die Videoaufnahme zu beenden.

4 Betrachten und Löschen von Bildern und Videoclips







Betrachten von Bildern und Videoclips

Im Modus **Wiedergabe** können Sie Bilder und Videoclips betrachten und löschen.

1. Drücken Sie die Taste  / , bis das Symbol  für kurze Zeit rechts oben in der Bildanzeige erscheint. Dadurch wird angezeigt, dass sich die Kamera im Modus **Wiedergabe** befindet.
2. Blättern Sie mit den Tasten   durch Ihre Bilder und Videoclips (Videoclips werden automatisch abgespielt).

Löschen eines Bilds

Im Modus **Wiedergabe** können Sie wie folgt Einzelbilder löschen:

1. Drücken Sie die Taste  / , bis das Symbol  für kurze Zeit rechts oben in der Bildanzeige erscheint. Dadurch wird angezeigt, dass sich die Kamera im Modus **Wiedergabe** befindet.
2. Wählen Sie mit den Tasten   ein Bild oder einen Videoclip aus.
3. Drücken Sie die Taste , um das Untermenü **Löschen** aufzurufen.

4. Wählen Sie mit den Tasten ▲▼ die Option **Dieses Bild** aus. Drücken Sie danach die Taste $\frac{\text{Menu}}{\text{OK}}$.

Deutsch

5 Übertragen und Drucken von Bildern

Übertragen von Bildern

Wenn die HP Photosmart-Software installiert ist, verwenden Sie die im Folgenden beschriebene Methode, um Bilder und Videoclips auf Ihren Computer zu übertragen. Wenn die HP Photosmart-Software nicht installiert ist, verwenden Sie eine Alternativmethode, die im elektronischen Benutzerhandbuch beschrieben ist.

Tipp Sie können diese Aufgabe auch mit einer optionalen HP Photosmart-Kamera-Dockingstation erledigen (siehe Benutzerhandbuch zur Dockingstation).

1. Schalten Sie die Kamera aus, und schließen Sie diese mit Hilfe des USB-Kabels, das mit der Kamera geliefert wurde, an den Computer an.
2. Schalten Sie die Kamera ein, und befolgen Sie die auf dem Computermonitor angezeigten

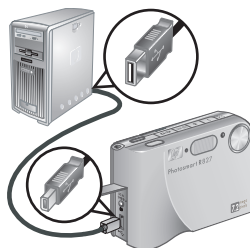

Anweisungen, um die Bilder zu übertragen. Weitere Informationen zu diesem Thema finden Sie in der Hilfefunktion der HP Photosmart-Software.

Drucken von Bildern von der Kamera aus

Sie können die Kamera mit einem beliebigen PictBridge-zertifizierten Drucker verbinden, um Einzelbilder und getrennt gespeicherte Bilder eines Videoclips zu drucken.





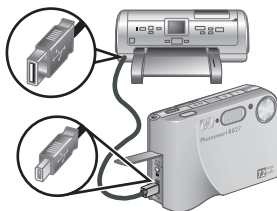



1. Vergewissern Sie sich, dass der Drucker eingeschaltet ist. Darüber hinaus muss Papier im Drucker eingelegt sein, und es dürfen keine Meldungen in Bezug auf Druckerfehler angezeigt werden.
2. Schließen Sie die Kamera mit Hilfe des USB-Kabels, das mit der Kamera geliefert wurde, an den Drucker an.
3. Schalten Sie die Kamera ein.
4. Ist die Kamera mit dem Drucker verbunden, erscheint auf der Bildanzeige der Kamera das Menü **Druckeinrichtung**. Wenn Sie die Einstellungen ändern möchten, wählen Sie mit den Tasten ▲▼ an der Kamera eine Menüoption aus. Ändern Sie dann die jeweilige Einstellung mit den Tasten ◀▶ an der Kamera.
5. Drücken Sie die Taste $\frac{\text{Menu}}{\text{OK}}$, um den Druckvorgang zu starten.



6 Kurzreferenz für Kamerafunktionen

Das folgende Kapitel dient als Kurzreferenz für die Kamerafunktionen. Weitere Informationen zu diesen Kamerafunktionen finden Sie im elektronischen Benutzerhandbuch.





Vorschau und Wiedergabe



- Die **Vorschau** ermöglicht das Erfassen von Motiven für Bilder und Videoclips über die Bildanzeige. Drücken Sie zum Aktivieren der **Vorschau** die Taste  / , bis das Symbol  für kurze Zeit rechts oben in der Bildanzeige erscheint.
- Im Modus **Wiedergabe** können Sie Bilder und Videoclips betrachten und löschen. Drücken Sie zum Aktivieren der **Wiedergabe** die Taste  / , bis das Symbol  für kurze Zeit rechts oben in der Bildanzeige erscheint.

Menüs



Wenn Sie die Taste ^{Menu}_{OK} im Modus **Wiedergabe** oder im Modus **Vorschau** drücken, werden die Kameramenüs in Form von Registerkarten (siehe Abbildung) aufgerufen.





Wechseln Sie mit den Tasten   zum gewünschten Menü. Innerhalb eines Menüs können Sie mit Hilfe der Tasten   spezifische Optionen auswählen.

Zum Beenden eines Menüs können Sie jederzeit die Taste  /  drücken.







Folgende Menüs und Optionen sind verfügbar:

Menü	Optionen
<p> Das Menü Aufnahme dient zum Anpassen der Kameraeinstellungen, die sich auf die Eigenschaften zukünftiger Bilder und Videoclips auswirken, die Sie mit der Kamera aufnehmen.</p>	<ul style="list-style-type: none">• Aufnahmemodus (Autom., Landschaft, Portrait, Stabile Aufnahme, Panorama Rechts, Panorama Links, Theater, Action, Nachtportrait, Nachtszene, Strand, Schnee, Sonnenuntergang, Dokument)• Selbstauslöser• Rote Augen entfernen• Belichtungs-kompensation• Adaptive Beleuchtung• Bereich• Bildqualität• Videoqualität• Burst• Weißabgleich• Autofokusbereich• AE-Belichtungsmessung• ISO-Empfindlichkeit• Sättigung• Schärfe• Kontrast• Datums-/Zeitstempel
<p> Das Menü Wiedergabe dient zum Betrachten und Bearbeiten von Bildern, die</p>	<ul style="list-style-type: none">• Bild-Tipp• Bild-Info• Diashow anzeigen

Menü	Optionen
auf der Kamera gespeichert sind.	<ul style="list-style-type: none"> ● Panorama zusammensetzen ● Audio aufnehmen ● Bilder auf Karte verschieben
 Das Menü Design-Galerie dient zum Optimieren aufgenommener Bilder.	<ul style="list-style-type: none"> ● Kunsteffekte anwenden ● Farbe ändern ● Ränder hinzufügen ● Rote Augen entfernen ● Drehen ● Zuschneiden
 Das Menü Einrichten dient zum Ändern der Funktionsweise der Kamera.	<ul style="list-style-type: none"> ● Anzeigehelligkeit ● Lautstärke ● Fokus-Hilfslicht ● Display-Timeout ● Direkte Wiedergabe ● Digital-Zoom ● Datum und Zeit ● USB-Konfiguration ● TV-Konfiguration ● Sprache ● Einstellungen zurücksetzen
 Die Hilfe enthält Beschreibungen der Kamerafunktionen sowie Tipps zum Aufnehmen von Bildern.	<ul style="list-style-type: none"> ● Top Ten-Tipps ● Kamerazubehör ● Kameratasten ● Aufnahmemodi verwenden ● Design-Galerie verwenden ● Photosmart Express verwenden

Menü	Optionen
	<ul style="list-style-type: none"> • Bilder drucken • Audioclips aufnehmen • Videoclips aufnehmen • Bilder und Video anzeigen • Bilder aus Video extrahieren • Bilder löschen • Bilder übertragen • Batterie-Management • Unterstützung • Kamera-Kurztasten • Info...

Wenn Sie die Taste  im Modus **Vorschau** oder **Wiedergabe** drücken, wird das Menü **Photosmart Express** angezeigt.

Menü	Optionen
 Mit Hilfe von Photosmart Express können Sie Fotos oder Gruppen von Fotos (Favoriten) auswählen, um diese zu drucken, für die gemeinsame Nutzung mit Freunden und Verwandten bereitzustellen oder Abzüge davon zu kaufen.	<ul style="list-style-type: none"> •  Drucken •  Share •  Abzüge kaufen •  Favoriten •  Hilfe

Deutsch

Cámara digital HP Photosmart R827

Español



Información legal y advertencias

© Copyright 2006 Hewlett-Packard Development Company, L.P.

La información que aparece en este documento está sujeta a cambios sin previo aviso. Las únicas garantías de los productos y servicios de HP se detallan en las declaraciones de garantía expresa que acompañan a dichos productos y servicios. Nada de lo que aquí se contenga se considerará como garantía adicional. HP no se hará responsable de los errores u omisiones técnicos o editoriales aquí contenidos.

Windows® es una marca registrada de Microsoft Corporation.



El logotipo SD es una marca comercial de su propietario.



Eliminación de desechos de equipamiento por parte de usuarios en domicilios particulares dentro de la Unión Europea:

Este símbolo en el producto o en su embalaje indica que no debe desecharlo con el resto de la basura de su domicilio. Bajo su responsabilidad, debería deshacerse de los desechos de equipamiento llevándolos a un punto de reciclaje de material eléctrico y equipos electrónicos. La recolección y reciclaje por separado de los desechos de equipamiento ayudará a conservar los recursos naturales y asegurará que se recicle de forma que proteja la salud y el medioambiente. Para más información acerca de dónde puede reciclar estos desechos, póngase en contacto con su ayuntamiento, con el servicio de eliminación de desechos o recogida de basuras, o con la tienda donde adquirió el producto.

Introduzca la siguiente información para referencias futuras:

- Cómo determinar el número de modelo de la cámara (parte frontal de la cámara): _____
- Número de serie (parte inferior de la cámara): _____
- Fecha de compra: _____

Contenido

1	Procedimientos iniciales	4
	Acceso a la Guía del usuario electrónica	5
	Cámara, parte superior y posterior	6
	Cámara, parte frontal, lateral e inferior	8
	Accesorio de la base para la cámara	8
2	Instalación de la cámara	10
	Instalación de la pila	10
	Carga de la pila	10
	Encendido de la cámara.	11
	Elección del idioma	11
	Selección de la región	11
	Ajuste de la fecha y la hora	11
	Instalación y formateo de una tarjeta de memoria opcional	12
	Instale el software	13
3	Toma de imágenes y grabación de videoclips	15
	Toma de una imagen fija	15
	Grabación de un videoclip	16
4	Revisión y eliminación de imágenes y videoclips	17
	Revisión de imágenes y videoclips	17
	Eliminación de una imagen	17
5	Transferencia e impresión de imágenes	19
	Transferencia de imágenes	19
	Impresión de imágenes desde la cámara	20
6	Referencia rápida de la cámara	21

1 Procedimientos iniciales

Esta Guía de comienzo rápido proporciona la información necesaria para empezar a utilizar las funciones básicas de su cámara. Si desea información detallada sobre las funciones de la cámara, consulte la Guía del usuario electrónica.

Guía de comienzo rápido	Guía del usuario electrónica
<p data-bbox="203 558 503 608">Esta guía impresa le ayudará a:</p> <ul data-bbox="203 622 477 793" style="list-style-type: none"><li data-bbox="203 622 477 672">• Empezar a utilizar la cámara rápidamente<li data-bbox="203 679 477 729">• Instalar el software HP Photosmart<li data-bbox="203 736 477 793">• Conocer las funciones básicas de su cámara	<p data-bbox="519 558 721 608">La Guía del usuario electrónica incluye:</p> <ul data-bbox="519 622 825 1178" style="list-style-type: none"><li data-bbox="519 622 825 708">• Descripciones de todas las funciones de la cámara<li data-bbox="519 715 825 801">• Una descripción de los iconos de la Pantalla de imagen<li data-bbox="519 808 825 1036">• Información sobre la pila, como:<ul data-bbox="560 865 825 1036" style="list-style-type: none"><li data-bbox="560 865 825 922">– Prolongación de la duración de la pila<li data-bbox="560 929 825 1036">– Una descripción de los iconos del indicador de alimentación<li data-bbox="519 1043 825 1072">• Resolución de problemas<li data-bbox="519 1079 825 1122">• Obtención de asistencia de HP<li data-bbox="519 1129 825 1178">• Especificaciones de la cámara

Acceso a la Guía del usuario electrónica



La Guía del usuario electrónica está en el disco HP Photosmart Software CD.

Para ver la Guía del usuario:

1. Introduzca el HP Photosmart Software CD en la unidad de CD-ROM del equipo.
2. **En Windows:** Haga clic en **Ver Guía del usuario** en la página principal de la pantalla de instalación.
En Macintosh: Abrir el archivo **Léame** en la carpeta **docs** del CD.

También se guarda en su equipo la Guía del usuario electrónica al instalar el software HP Photosmart. Para ver la Guía del usuario tras instalarla en el equipo.

- **En Windows:** Abra el **Centro de soluciones HP** y haga clic en **Ayuda y asistencia técnica**.
- **En Macintosh:** Abra el **Administrador de dispositivos HP** y seleccione **Guía del usuario de la cámara** del menú emergente **Información y configuración**.

Obtención de asistencia







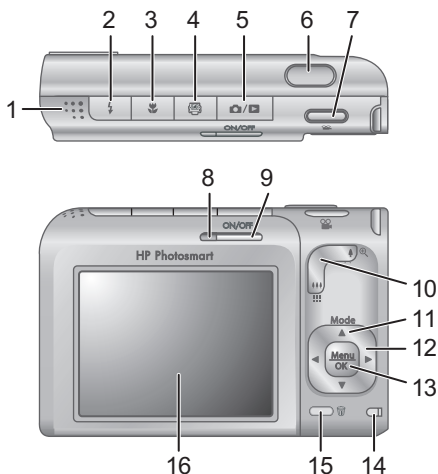



- Si desea sugerencias y herramientas que le ayuden a utilizar la cámara de manera más eficaz, visite **www.hp.com/photosmart** (sólo en inglés) o **www.hp.com**.
- Si desea obtener asistencia para productos, diagnósticos y descargas de controladores 24 horas al día, 7 días a la semana, visite **www.hp.com/support**.

- Para obtener ayuda del software HP Photosmart, consulte la ayuda en línea.

Cámara, parte superior y posterior



1	Altavoz.
2	Botón Flash : los ajustes son Automático, Flash encendido, Flash apagado.
3	Botón Enfoque : los ajustes son Normal, Macro, Macro automático e Infinito.
4	Botón Photosmart Express : las opciones son Imprimir, Compartir, Comprar copias, Favoritos, Ayuda.
5	Botón Vista en directo/Reproducción : Alterna entre Vista en directo y Reproducción (consulte <i>Vista en directo</i> y <i>Reproducción</i> en la página 21).
6	Botón del Disparador

7	 Botón Vídeo .
8	Indicador luminoso de alimentación
9	ON/OFF, botón.
10	Palanca de zoom (digital y óptico): En Vista en directo , presione  para acercar la imagen o presione  para alejar la imagen. En Reproducción , presione el  para ampliar la imagen seleccionada o presione el  para ver viñetas de sus imágenes.
11	Botón Modo : presione  para acceder al menú Modo de fotografía mientras está en Vista en directo . Las opciones de Modo de fotografía son Modo automático, Paisaje, Retrato, Foto estable, Panorama derecha, Panorama izquierda, Teatro, Acción, Retrato nocturno, Escena nocturna, Playa, Nieve, Puesta de sol, Documento.
12	  y  botones: para desplazarse por las viñetas.
13	 : muestra los menús de la cámara, selecciona opciones y confirma acciones.
14	Indicador luminoso de pila cargando.
15	 Botón Eliminar : accede a la función Eliminar desde el modo Reproducción .
16	Pantalla de imagen.

Cámara, parte frontal, lateral e inferior

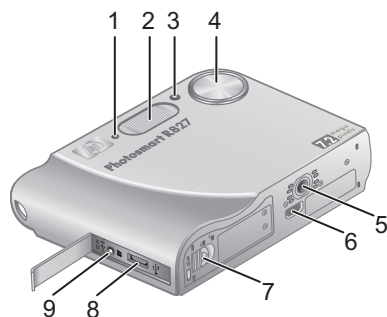

1	Micrófono.
2	Flash.
3	Indicador luminoso Temporizador automático/Ayuda enfoque.
4	Objetivo.
5	Soporte para trípode.
6	Conector de la base de acoplamiento.
7	Puerta de la pila/tarjeta de memoria.
8	Conector USB.
9	Conector del adaptador de alimentación.

Accesorio de la base para la cámara

Si adquiere una base de acoplamiento HP Photosmart opcional, vendrá suministrado con varios adaptadores transparentes. Al instalar la base de acoplamiento para utilizarla con esta cámara, utilice el adaptador de la base

con la etiqueta azul redonda. Para obtener más instrucciones, consulte la Guía del usuario de la base.

Español

2 Instalación de la cámara

Instalación de la pila

1. Abra la tapa de la pila y la tarjeta de memoria deslizando el cierre de la tapa tal y como se indica en la misma.
2. Inserte la pila en la ranura más grande, empujándola hasta que la traba quede enganchada.
3. Cierre la tapa de la pila/tarjeta de memoria.

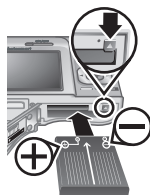

Nota Apague la cámara antes de retirar la pila. Cargue por completo la pila antes de utilizarla por primera vez.

Carga de la pila

Puede cargar la pila en la cámara con la base de adaptador de CA.

1. Conecte el extremo pequeño del cable de alimentación en el adaptador de CA, y el extremo grande a una toma eléctrica.
2. Conecte el cable fino del adaptador de CA de HP a la cámara tal y como se muestra a continuación.

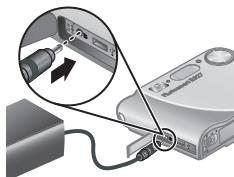

Si el indicador luminoso de carga de la pila parpadea, significa que la pila se está cargando; la pila está

totalmente cargada cuando el indicador permanece encendido fijamente (aproximadamente 2 y 3 horas).

Encendido de la cámara.

Para encender la cámara, presione el botón ON/OFF.

Elección del idioma

Utilice ▲▼ y ◀▶ para elegir el idioma que desea y presione

Menu
OK .

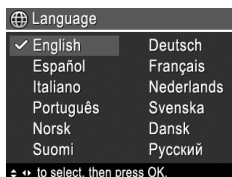

Selección de la región

Los ajustes de **Idioma** y **Región** determinan la configuración predeterminada de la fecha y la hora, y el formato de la señal de vídeo para visualizar las imágenes de la cámara en un televisor.



Utilice ▲▼ para elegir la región que desea y presione

Menu
OK .

Ajuste de la fecha y la hora

El ajuste preciso de la fecha y la hora le ayudará a localizar las imágenes una vez que las haya cargado en el equipo, y le garantizará que éstas queden marcadas

con precisión si utiliza la función para imprimir la fecha y la hora.

1. Utilice ▲▼ para ajustar el valor seleccionado.
2. Utilice ◀▶ para desplazarse a las otras selecciones y repita el Paso 1 hasta que la fecha y hora sean correctas.
3. Presione $\frac{\text{Menu}}{\text{OK}}$ cuando la fecha, hora y los ajustes de formato sean correctos y vuelva a presionar $\frac{\text{Menu}}{\text{OK}}$ para confirmarlo.

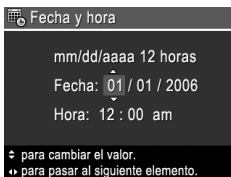

Instalación y formateo de una tarjeta de memoria opcional





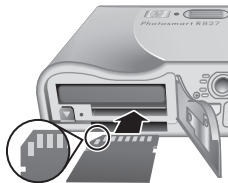



Esta cámara admite tarjetas de memoria de alta velocidad y estándar, Secure Digital (SD) de marca HP, de 8 MB a 2 GB.

1. Apague la cámara y abra la tapa de la pila/tarjeta de memoria.
2. Inserte la tarjeta de memoria opcional en la ranura más pequeña como se indica. Asegúrese de que encaja en su sitio.
3. Cierre la tapa y encienda la cámara.



Formatee siempre las nuevas tarjetas de memoria antes de utilizarlas por primera vez. Si formatea la tarjeta, se eliminarán todas las imágenes almacenadas en la

misma; así pues, asegúrese de cargar las imágenes existentes antes de formatear la tarjeta.

1. Con la cámara encendida, presione  /  hasta acceder al modo **Reproducción**.
2. Presione  para mostrar el submenú **Eliminar**.
3. Utilice   para seleccionar **Formatear tarjeta**, y presione .
4. Utilice   para seleccionar **Sí**, y presione  para formatear la tarjeta.

Una vez instalada una tarjeta de memoria, se guardarán todas las imágenes y los videoclips nuevos en esa tarjeta, en lugar de almacenarlos en la memoria interna.

Para utilizar la memoria interna de la cámara y ver las imágenes guardadas en ella, extraiga la tarjeta de memoria.

Instale el software

El software HP Photosmart proporciona funciones para transferir imágenes y videoclips a su equipo, además de funciones para modificar las imágenes almacenadas (eliminar ojos rojos, rotar, recortar, redimensionar, ajustar la calidad de imagen, agregar colores y efectos especiales y más).

Si tiene dificultades para instalar o utilizar el software HP Photosmart, encontrará más información en el sitio Web de Atención al cliente de HP:

www.hp.com/support.

Windows

Dependiendo del sistema operativo, podrá instalar HP Photosmart Premier o HP Photosmart Essential, o

HP Photosmart Essential se instalará automáticamente. HP Photosmart Premier incluye otras funciones adicionales que no ofrece la versión Essential. Consulte el capítulo 1 de la Guía del usuario para conocer las diferencias.

1. Cierre todos los programas y deshabilite temporalmente todo el software de protección contra virus.
2. Inserte HP Photosmart Software CD en la unidad de CD y siga las instrucciones en pantalla. Si no se abre la pantalla de instalación, en el menú **Inicio**, haga clic en **Ejecutar** y escriba **D:\Setup.exe**, donde **D** es la letra de la unidad de CD-ROM y, a continuación, haga clic en **Aceptar**.
3. Cuando se haya instalado el software, vuelva a habilitar el software de protección contra virus.

Macintosh



Para instalar el software de Mac de HP Photosmart, su equipo Macintosh debe cumplir los requisitos del sistema indicados en el embalaje de la cámara.

1. Inserte HP Photosmart Software CD en la unidad de CD.
2. Haga doble clic en el icono del CD en el escritorio del equipo.
3. Haga doble clic en el icono del instalador y, a continuación, siga las instrucciones mostradas en la pantalla.



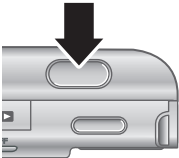

3 Toma de imágenes y grabación de videoclips

Vista en directo permite encuadrar imágenes y videoclips desde la Pantalla de imagen.

Toma de una imagen fija

1. Presione  /  hasta que aparezca  brevemente en la esquina superior derecha de la Pantalla de imagen. Esto indica que está en el modo **Vista en directo**.
- 
2. Encuadre el sujeto para su imagen.
 3. Presione el botón del **Disparador** hasta la mitad de su recorrido para medir y bloquear el enfoque y la exposición. Los delimitadores de enfoque de la Pantalla de imagen cambian a verde cuando el enfoque está bloqueado.
 4. Presione el botón del **Disparador** hasta el final para tomar la imagen.
 5. Para agregar un clip de audio de hasta 60 segundos, mantenga presionado el botón del **Disparador** y suéltelo cuando haya acabado.

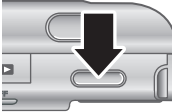



Grabación de un videoclip

1. Presione  /  hasta que aparezca  brevemente en la esquina superior derecha de la Pantalla de imagen. Esto indica que está en el modo **Vista en directo**.
- 
2. Encuadre el sujeto.
 3. Presione y libere el botón **Vídeo** .
 4. Para dejar de grabar vídeo, vuelva a presionar y liberar el botón **Vídeo** .

4 Revisión y eliminación de imágenes y videoclips







Revisión de imágenes y videoclips

Puede revisar y eliminar imágenes y videoclips en el modo **Reproducción**.

1. Presione  /  hasta que aparezca  brevemente en la esquina superior derecha de la Pantalla de imagen. Esto indica que está en el modo **Reproducción**.
2. Utilice   para desplazarse entre las imágenes o los videoclips (se reproducen los videoclips automáticamente).

Eliminación de una imagen

Puede eliminar imágenes individuales durante la **Reproducción**:

1. Presione  /  hasta que aparezca  brevemente en la esquina superior derecha de la Pantalla de imagen. Esto indica que está en el modo **Reproducción**.
2. Utilice el   para seleccionar una imagen o un videoclip.
3. Presione  para mostrar el submenú **Eliminar**.

- Utilice los ▲▼ para seleccionar **Esta imagen**, y presione el $\frac{\text{Menu}}{\text{OK}}$.

5 Transferencia e impresión de imágenes

Transferencia de imágenes

Si ha instalado el software HP Photosmart, utilice este método para transferir imágenes y videoclips a su equipo. Si no ha instalado el software HP Photosmart, consulte la Guía del usuario electrónica como alternativa.

Sugerencia También puede realizar este proceso utilizando una base de acoplamiento HP Photosmart opcional (consulte la Guía del usuario de la base de acoplamiento).

1. Apague la cámara y conéctela al equipo mediante el cable USB incluido con la cámara.
2. Encienda la cámara y siga las instrucciones en la pantalla del equipo para transferir las imágenes. Para obtener más información, consulte la Ayuda del software HP Photosmart.

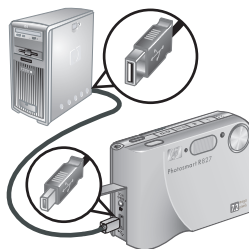

Impresión de imágenes desde la cámara

Puede conectar la cámara a cualquier impresora con certificado PictBridge para imprimir imágenes fijas y fotogramas guardados a partir de un videoclip.





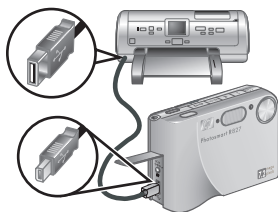

1. Compruebe que la impresora esté encendida, que hay papel y que no hay mensajes de error en la impresora.
2. Conecte la cámara a la impresora mediante el cable USB suministrado con la cámara.
3. Encienda la cámara.
4. Cuando la cámara está conectada a la impresora, aparece el menú **Configurar impresión** en la cámara. Para cambiar los ajustes, utilice los ▲▼ de la cámara para seleccionar una opción de menú y utilice ◀▶ de la cámara para cambiar el ajuste.
5. Presione $\frac{\text{Menu}}{\text{OK}}$ para iniciar la impresión.



6 Referencia rápida de la cámara

Utilice este capítulo como referencia rápida para las funciones de la cámara. Para obtener más información sobre estas funciones de la cámara, consulte la Guía del usuario electrónica.

Vista en directo y Reproducción



- **Vista en directo** permite encuadrar imágenes y videoclips desde la Pantalla de imagen. Para activar **Vista en directo**, presione  hasta que aparezca  brevemente en la esquina superior derecha de la Pantalla de imagen.
- El modo **Reproducción** le permite revisar y eliminar imágenes y videoclips. Para activar **Reproducción**, presione  hasta que aparezca  brevemente en la esquina superior derecha de la Pantalla de imagen.



Menús

Al presionar el botón  desde el modo

Reproducción o **Vista en directo**, accede a los menús de cámara divididos en fichas como se ve en la pantalla de ejemplo.







Utilice  para desplazarse al menú deseado. Dentro de un menú, utilice los  para desplazar las selecciones específicas.

Para salir del menú, presione el  /  en cualquier momento.







Los menús y las opciones son:

Menú	Opciones
<p> Captura permiten configurar diversos ajustes que afectan a las características de las imágenes y los videoclips que capture con la cámara.</p>	<ul style="list-style-type: none"> • Las opciones del Modo de fotografía (Modo automático, Paisaje, Retrato, Foto estable, Panorama hacia la derecha, Panorama hacia la izquierda, Teatro, Acción, Retrato nocturno, Escena nocturna, Playa, Nieve, Puesta de sol, Documento) • Temporizador automático • Elim. de ojos rojos • Compensación de exposición • Ilum. adaptable • Delimitación • Calidad imagen • Calidad de vídeo • Ráfaga • Equilibrio de blanco • Área de enfoque automático • Medición AE • Velocidad ISO • Saturación • Nitidez

Menú	Opciones
	<ul style="list-style-type: none"> ● Contraste ● Estampado de fecha y hora
<p> Reproducción permite revisar y manipular imágenes que haya guardado en la cámara.</p>	<ul style="list-style-type: none"> ● Consejos sobre la imagen ● Información de la imagen ● Ver presentación ● Solapar panorama ● Grabar audio ● Cómo transferir imágenes a una tarjeta
<p> Galería de diseño permite mejorar las imágenes que ha capturado.</p>	<ul style="list-style-type: none"> ● Aplicar efectos artísticos ● Modificar el color ● Agregar bordes ● Eliminación de ojos rojos ● Rotar ● Recortar
<p> Configuración permite cambiar el comportamiento de la cámara.</p>	<ul style="list-style-type: none"> ● Brillo de pantalla ● Volumen de sonidos ● Luz ayuda enfoque ● Mostrar tiempo de espera ● Revisión instantánea ● Zoom digital ● Fecha y hora ● Configuración USB ● Configuración TV ● Idioma ● Restablecer ajustes
<p> Ayuda proporciona descripciones de las funciones de la cámara y</p>	<ul style="list-style-type: none"> ● Diez mejores consejos ● Accesorios de la cámara ● Botones de la cámara

Menú	Opciones
sugerencias para tomar fotografías.	<ul style="list-style-type: none"> ● Uso de modos de fotografía ● Uso de la Galería de diseño ● Uso de Photosmart Express ● Impresión de imágenes ● Grabación de clips de audio ● Grabación de videoclips ● Revisión imágenes y vídeos ● Extracción de copias del vídeo ● Eliminación de imágenes ● Transferencia de imágenes ● Gestión de las pilas ● Cómo obtener asistencia ● Métodos abreviados cámara ● Acerca de...

Al presionar  desde **Vista en directo** o **Reproducción**, aparece el **menú Photosmart Express**.

Menú	Opciones
 Photosmart Express permite seleccionar fotografías o grupos de fotografías (Favoritos) para imprimir, comprar en línea o	<ul style="list-style-type: none"> ●  Imprimir ●  Compartir ●  Comprar copias ●  Favoritos ●  Ayuda

compartir con amigos y familiares.

Español

Español

HP Photosmart R827 Digitale camera

Nederlands



Wettelijke kennisgevingen

© Copyright 2006 Hewlett-Packard Development Company, L.P.

De informatie in dit document kan zonder voorafgaande kennisgeving worden gewijzigd. De enige garanties die gelden voor HP producten en diensten zijn de garanties die worden beschreven in de garantievoorwaarden behorende bij deze producten en diensten. Geen enkel onderdeel van dit document mag als extra garantie worden opgevat. HP aanvaardt geen aansprakelijkheid voor technische fouten of redactionele fouten, drukfouten of weglatingen in deze publicatie.

Windows® is een in de V.S. geregistreerd handelsmerk van of Microsoft Corporation.



Het SD-logo is een handelsmerk van de desbetreffende eigenaar.



Het weggooien van apparatuur door gebruikers in privéhuishoudens de Europese Unie

Dit symbool op het product of op de verpakking geeft aan dat dit product niet bij het gewone afval mag worden weggegooid. In plaats hiervan dient u afgedankte apparatuur in te leveren bij een recycling/inzamelingspunt voor elektrische en elektronische apparatuur. De aparte inzameling en recycling van afgedankte apparatuur zorgt ervoor dat de natuurlijke hulpbronnen behouden blijven en dat de apparatuur zonder nadelige invloed op de gezondheid en het milieu voor hergebruik kan worden verwerkt. Neem contact op met de gemeentelijke reinigingsdienst of met de winkel waar u het product hebt aangeschaft voor meer informatie over locaties waar u oude apparatuur kunt achterlaten voor recycling.

Voer de volgende gegevens in als geheugensteun:

- Modelnummer (vóór op de camera): _____
- Serienummer (onder op de camera): _____
- Datum van aanschaf: _____

Inhoudsopgave

1 Aan de slag	4
De elektronische gebruikershandleiding raadplegen	5
Bovenkant en achterkant van de camera	6
Voorkant, zijkant en onderkant van de camera	8
Dockinzetstuk van de camera	8
2 De camera instellen	10
De batterij plaatsen	10
De batterij opladen	10
De camera aanzetten	11
De taal kiezen	11
De regio instellen	11
Datum en tijd instellen	11
Een optionele geheugenkaart installeren en formatteren	12
De software installeren	13
3 Foto's maken en videoclips opnemen	15
Een foto nemen	15
Een videoclip opnemen	15
4 Foto's en videoclips bekijken en verwijderen	17
Foto's en videoclips bekijken	17
Een opname verwijderen	17
5 Opnames overbrengen en afdrukken	18
Opnames overbrengen	18
Opnames afdrukken vanaf de camera	19
6 Beknopt overzicht van de camera	20

1 Aan de slag

Deze gedrukte introductiegids bevat de informatie die u nodig hebt aan de slag te gaan met de voornaamste functies van uw camera. Zie de elektronische gebruikershandleiding voor gedetailleerde informatie over camerafuncties.

Introductiegids	Elektronische gebruikershandleiding
<p>Aan de hand van deze gedrukte gids kunt u:</p> <ul style="list-style-type: none">• Snel aan de slag gaan met uw camera• De HP Photosmart-software installeren• Vertrouwd raken met de belangrijkste functies van de camera	<p>De elektronische gebruikershandleiding bevat:</p> <ul style="list-style-type: none">• Beschrijvingen van alle camerafuncties• Een beschrijving van pictogrammen op het LCD-scherm• Batterijgegevens, waaronder:<ul style="list-style-type: none">– De werkingsduur van batterijen verlengen– Een beschrijving van de batterijstatus-indicators• Problemen oplossen• Hulp en ondersteuning van HP• Camerascificaties

De elektronische gebruikershandleiding raadplegen



U vindt de elektronische gebruikershandleiding op de HP Photosmart Software CD.

Zo kunt u de gebruikershandleiding bekijken:

1. Plaats de HP Photosmart Software CD in het cd-rom-station van uw computer.
2. **Windows:** Klik op **Gebruikershandleiding bekijken** op de hoofdpagina van het installatiescherm.
Macintosh: Open het bestand **readme** (leesmij) in de map **docs** op de cd.

De elektronische gebruikershandleiding wordt ook naar uw computer gekopieerd wanneer u de HP Photosmart-software installeert. Zo kunt u de gebruikershandleiding bekijken nadat deze op uw computer is geïnstalleerd:

- **Windows:** Open **HP Solution Center** en klik op **Help en ondersteuning**.
- **Macintosh:** Open **HP Apparaatbeheer** en selecteer **Gebruikershandleiding voor camera** in het pop-upmenu **Informatie en instellingen**.



Hulp en ondersteuning

- Bezoek de website **www.hp.com/photosmart** (alleen Engels) of **www.hp.com** voor tips en hulpmiddelen voor een effectiever gebruik van uw camera.

- U kunt te allen tijde terecht op www.hp.com/support voor productassistentie, diagnoseprogramma's en downloadbare stuurprogramma's.
- Raadpleeg de online help van de HP Photosmart-software voor hulp bij de software.

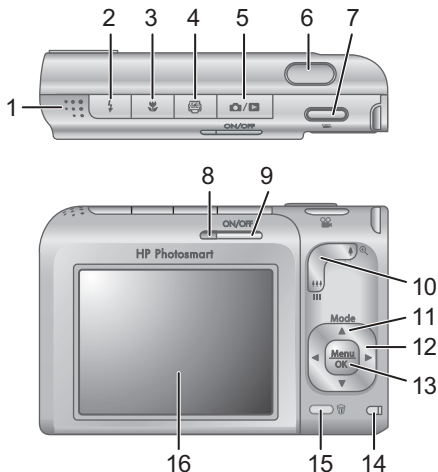
Bovenkant en achterkant van de camera



1	Luidspreker.
2	Knop  Flitser —Instellingen zijn Auto, Flitser Aan, Flitser Uit.
3	Knop  Focus —Instellingen zijn Normaal, Macro, Automacro, Oneindig.

4	Knop  Photosmart Express —Opties zijn Afdrukken, Delen, Afdrukken kopen, Favorieten, Help.
5	Knop  Liveweergave/Weergave —Voor schakelen tussen Liveweergave en Weergave (zie <i>Liveweergave en Weergave</i> op pagina 20).
6	Sluiterknop.
7	Knop  Video.
8	Aan/uit-lampje.
9	Knop ON/OFF.
10	Knop In/uitzoomen (digitaal en optisch)—In Liveweergave drukt u op  om in te zoomen of op  om uit te zoomen. In Weergave drukt u op  om de geselecteerde opname te vergroten of op  om de opnames op miniatuurformaat weer te geven.
11	Knop Mode —Druk op  om het menu Opnamemodus te openen wanneer Liveweergave actief is. Opties voor Opnamemodus zijn Modus Auto, Landschap, Portret, Scherpe foto, Panorama Rechts, Panorama Links, Theater, Actie, Nachtportret, Nachttafereel, Strand, Sneeuw, Zonsondergang, Document.
12	Knoppen  en  —Voor het bladeren door menu's en opnames.
13	Knop  —Voor het weergeven van cameramenu's, het selecteren van opties en het bevestigen van keuzen.
14	Batterijplaadindicator.
15	Knop  Verwijderen —Voor de functie Verwijderen in Weergave .
16	LCD-scherm.

Voorkant, zijkant en onderkant van de camera

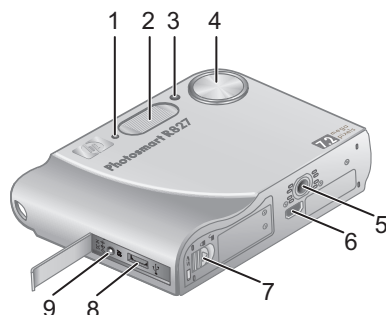

1	Microfoon.
2	Flitser.
3	Lampje van zelfontspanner/focushulp.
4	Lens.
5	Bevestigingspunt voor statief.
6	Aansluiting voor dock.
7	Klepje van vak voor batterij/geheugenkaart.
8	USB-aansluiting.
9	Aansluiting voor netadapter.

Dockinzetstuk van de camera

Als u een optioneel HP Photosmart cameradock aanschaft, wordt dit geleverd samen met enkele lichtgekleurde inzetstukken. Wanneer u het dock gereedmaakt voor gebruik met deze camera, kunt u het dockinzetstuk met het ronde blauwe merkteken

gebruiken. Zie de gebruikershandleiding van het dock voor instructies.

Nederlands

2 De camera instellen

De batterij plaatsen

1. Open het vak voor de batterij/ geheugenkaart door de vergrendeling ervan te verschuiven zoals op het klepje wordt aangegeven.
2. Plaats de batterij in de grootste sleuf en duw de batterij naar binnen totdat het ontgrendelingspalletje op zijn plaats klikt.
3. Sluit het vak voor de batterij/geheugenkaart.



Opmerking Zet de camera uit voordat u de batterij verwijdt. Laad de batterij volledig op voordat u deze voor het eerst gebruikt.

De batterij opladen

U kunt de batterij in de camera opladen met de netvoedingsadapter.

1. Steek de kleine stekker van het netsnoer in de netadapter en de grote stekker in een stopcontact.
2. Bevestig het dunne snoer van de netadapter aan de camera, zoals in de illustratie.

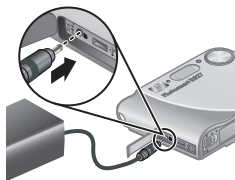

De batterijoplaadindicator van de camera knippert, hetgeen aangeeft dat de batterij wordt opgeladen. De

batterij is volledig opgeladen wanneer het lampje continu blijft branden (na 2 tot 3 uur).

De camera aanzetten

Zet de camera aan door op de knop ON/OFF te drukken.

De taal kiezen

Kies de gewenste taal met
▲▼ ◀▶ en druk op $\frac{\text{Menu}}{\text{OK}}$.

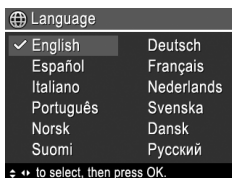

De regio instellen

Met de instellingen **Taal** en **Regio** bepaalt u de standaard datumnotatie en de indeling van het videosignaal voor het weergegeven van cameraopnames op een televisie.



Kies de gewenste regio met ▲▼ en druk op $\frac{\text{Menu}}{\text{OK}}$.

Datum en tijd instellen

Als u de juiste datum en tijd instelt, kunt u afbeeldingen die u naar de computer hebt geüpload gemakkelijker terugvinden. Bovendien wordt de juiste datum en tijd aan

afbeeldingen toegevoegd als u van deze functie gebruikmaakt.

1. Pas de gemarkeerde waarde aan met ▲▼.
2. Ga naar de andere selecties met ◀▶ en herhaal stap 1 totdat de datum en tijd correct zijn ingesteld.
3. Druk op $\frac{\text{Menu}}{\text{OK}}$ wanneer de instellingen voor datum, tijd en indeling correct zijn. Druk vervolgens nogmaals op $\frac{\text{Menu}}{\text{OK}}$ om de keuze te bevestigen.



Een optionele geheugenkaart installeren en formatteren





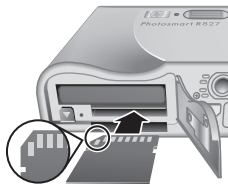

De camera ondersteunt SD-geheugenkaarten (Secure Digital) van HP, standaard en hoge snelheid, van 8 MB tot 2 GB.

1. Zet de camera uit en open het vak voor de batterij/geheugenkaart.
2. Plaats de optionele geheugenkaart in de kleinste sleuf zoals in de illustratie. Zorg ervoor dat de geheugenkaart vastklikt.
3. Sluit het vak voor de batterij/geheugenkaart en zet de camera aan.



Formateer nieuwe geheugenkaarten altijd alvorens deze voor het eerst te gebruiken. Bij formatteren worden alle opnames van de geheugenkaart verwijderd.

Daarom moet u de aanwezige opnames naar de computer uploaden voordat u formateert.

1. Zet de camera aan en druk op  /  totdat de modus **Weergave** actief is.
2. Druk op  om het submenu **Verwijderen** weer te geven.
3. Selecteer met   de optie **Kaart formatteren** en druk op $\frac{\text{Menu}}{\text{OK}}$.
4. Selecteer met   de optie **Ja** en druk op $\frac{\text{Menu}}{\text{OK}}$ om de kaart te formatteren.

Wanneer u een geheugenkaart hebt geïnstalleerd, worden alle nieuwe foto's en videoclips op de kaart opgeslagen in plaats van in het interne geheugen.

Als u het interne geheugen wilt gebruiken en opnames wilt weergeven die in het geheugen zijn opgeslagen, verwijdert u de geheugenkaart.

De software installeren

De HP Photosmart-software bevat functies voor het overbrengen van foto's en videoclips naar de computer en functies voor het wijzigen van opgeslagen opnames (onder meer rode ogen verwijderen, draaien, bijsnijden, formaat wijzigen, opnamekwaliteit wijzigen, en kleuren en speciale effecten toevoegen).

Als u bij het installeren of gebruiken van de HP Photosmart-software problemen ondervindt, kunt u voor meer informatie terecht op de website voor klantenondersteuning van HP: **www.hp.com/support**.

Windows

Afhankelijk van het besturingssysteem krijgt u ofwel de keuze tussen het installeren van HP Photosmart

Premier en HP Photosmart Essential ofwel wordt HP Photosmart Essential automatisch geïnstalleerd. HP Photosmart Premier heeft een uitgebreidere functionaliteit dan de Essential-versie. Zie hoofdstuk 1 in de elektronische gebruikershandleiding voor een overzicht van de verschillen.

1. Sluit alle programma's en schakel eventuele antivirussoftware tijdelijk uit.
2. Plaats de HP Photosmart Software CD in het cd-rom-station en volg de aanwijzingen op het scherm. Als het installatievenster niet verschijnt, doet u het volgende: klik op **Start** en op **Uitvoeren**, typ **D:\Setup.exe**, waarbij **D** staat voor de letter van het cd-rom-station, en klik op **OK**.
3. Wanneer de installatie van de software is voltooid, schakelt u de antivirussoftware weer in.

Macintosh



Als u de HP Photosmart Mac-software wilt installeren, moet uw Macintosh-computer voldoen aan de systeemvereisten die worden vermeld op de verpakking van de camera.

1. Plaats de HP Photosmart Software CD in het cd-rom-station.
2. Dubbelklik op het pictogram van het cd-rom-station op het bureaublad van de computer.
3. Dubbelklik op het pictogram van het installatieprogramma volg de aanwijzingen op het scherm.



3 Foto's maken en videoclips opnemen

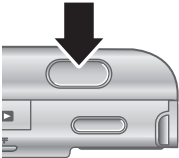

In de modus **Liveweergave** kunt u foto's en videoclips op het LCD-scherm inkaderen.

Een foto nemen

1. Druk op  /  totdat rechtsboven in de hoek van het LCD-scherm kort  wordt weergegeven. Dit geeft aan dat **Liveweergave** actief is.
- 
2. Kader het onderwerp voor de foto in.
 3. Druk de **sluiterknop** half in om de focus en belichting te meten en te vergrendelen. Het scherpstellingskader op het LCD-scherm wordt groen als de brandpuntafstand is vergrendeld.
 4. Druk de **sluiterknop** helemaal in om de foto te maken.
 5. Als u een audioclip (maximaal 60 seconden) wilt opnemen, houdt u de **sluiterknop** ingedrukt en laat u deze los om de opname te beëindigen.

Een videoclip opnemen

1. Druk op  /  totdat rechtsboven in de hoek van het LCD-scherm kort  wordt weergegeven. Dit geeft aan dat **Liveweergave** actief is.
- 
2. Kader het onderwerp in.





3. Druk de knop **Video**  in en laat deze los.
4. U stopt de opname van de video door de knop **Video**  nogmaals in te drukken en los te laten.

Nederlands

4 Foto's en videoclips bekijken en verwijderen











Foto's en videoclips bekijken

U kunt foto's en videoclips bekijken en verwijderen in de modus **Weergave**.

1. Druk op  /  totdat rechtsboven in de hoek van het LCD-scherm kort  wordt weergegeven. Dit geeft aan dat **Weergave** actief is.
2. Blader met   door uw foto's en videoclips (videoclips worden automatisch afgespeeld).

Een opname verwijderen

U kunt afzonderlijke opnames verwijderen in **Weergave**:

1. Druk op  /  totdat rechtsboven in de hoek van het LCD-scherm kort  wordt weergegeven. Dit geeft aan dat **Weergave** actief is.
2. Selecteer met   een foto of videoclip.
3. Druk op  om het submenu **Verwijderen** weer te geven.
4. Selecteer met   de optie **Deze opname** en druk op  .

5 Opnames overbrengen en afdrukken

Opnames overbrengen

Als u de HP Photosmart-software hebt geïnstalleerd, kunt met deze methode foto's en videoclipjes naar uw computer overbrengen. Als u de HP Photosmart-software niet hebt geïnstalleerd, kunt u in de elektronische gebruikershandleiding een andere methode vinden.

Tip U kunt deze taak ook uitvoeren met een optioneel HP Photosmart cameradock (zie de gebruikershandleiding van het dock).

1. Zet de camera uit en sluit de camera en de computer op elkaar aan met de bij de camera geleverde USB-kabel.
2. Zet de camera aan en volg de aanwijzingen op het computerscherm om de opnames over te brengen. Zie de Help-functie van de HP Photosmart-software voor meer informatie.

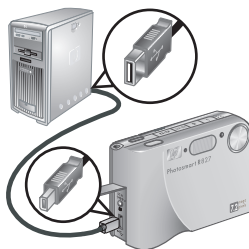

Opnames afdrukken vanaf de camera

U kunt de camera aansluiten op een willekeurige PictBridge-compatibele printer, waarmee u vervolgens foto's en frames uit een videoclip kunt afdrukken.





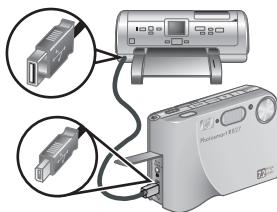



1. Controleer of de printer aan staat, of er papier in de printer is geplaatst en of er geen foutmelding op de printer wordt weergegeven.
2. Sluit de camera en de printer op elkaar aan met de bij de camera geleverde USB-kabel.
3. Zet de camera aan.
4. Wanneer de camera op de printer is aangesloten, wordt het menu **Afdrukinstellingen** op de camera weergegeven. Als u de instellingen wilt wijzigen, selecteert u op de camera een menuoptie met ▲▼ en wijzigt u vervolgens de instelling met ◀▶.
5. Druk op $\frac{\text{Menu}}{\text{OK}}$ om het afdrukken te starten.



6 Beknopt overzicht van de camera

In dit hoofdstuk kunt u in één oogopslag zien welke mogelijkheden u met de camera hebt. Meer informatie over deze functies vindt u in de elektronische gebruikershandleiding.





Liveweergave en Weergave



- In de modus **Liveweergave** kunt u foto's en videoclips op het LCD-scherm inkaderen. Als u **Liveweergave** wilt activeren, drukt u op  /  totdat in de hoek rechtsboven van het LCD-scherm kort  wordt weergegeven.
- In de modus **Weergave** kunt u foto's en videoclips bekijken en verwijderen. Als u **Weergave** wilt activeren, drukt u op  /  totdat in de hoek rechtsboven van het LCD-scherm kort  wordt weergegeven.

Menu's

Wanneer u op  drukt in **Weergave** of **Liveweergave**, opent u de cameramenu's die over verschillende tabbladen zijn verdeeld, zoals te zien in het voorbeeldscherm.





Met   gaat u naar het gewenste menu. In een menu kunt u met   naar een bepaalde optie gaan.

U kunt het menu op elk moment afsluiten door op  /  te drukken.







Menu's en bijbehorende opties:

Menu	Opties
<p>Met  Opname kunt u camera-instellingen wijzigen die van invloed zijn op de kenmerken van foto's en videoclips die u in het vervolg met de camera maakt.</p>	<ul style="list-style-type: none">• Opmemodus (Modus Auto, Landschap, Portret, Scherpe foto, Panorama Rechts, Panorama Links, Theater, Actie, Nachtportret, Nachtafereel, Strand, Sneeuw, Zonsondergang, Document)• Zelfontspanner• Rode-ogenverwijdering• Belichtingscompensatie• Adaptieve belichting• Bracketing• Fotokwaliteit• Videokwaliteit• Burst• Witbalans• Autofocusgebied• AE-meting• ISO-snelheid• Verzadiging• Scherpste• Contrast• Datum & tijd toevoegen
<p>Met  Weergave kunt u de foto's bekijken en wijzigen die u in de camera hebt opgeslagen.</p>	<ul style="list-style-type: none">• Fotoadvies• Fotogegevens• Diavoorstelling weergeven

Menu	Opties
	<ul style="list-style-type: none"> ● Panorama samenvoegen ● Geluid opnemen ● Opnames naar kaart
<p>Met  Ontwerpgalerie kunt u bewerkingen op uw opnames uitvoeren.</p>	<ul style="list-style-type: none"> ● Artistieke effecten toepassen ● Kleur wijzigen ● Randen toevoegen ● Rode ogen verwijderen ● Draaien ● Bijsnijden
<p>Met  Instellen kunt u de werking van de camera wijzigen.</p>	<ul style="list-style-type: none"> ● Schermhelderheid ● Geluidsvolume ● Focushulplampje ● Time-out scherm ● Meteen bekijken ● Digitaal zoomen ● Datum & tijd ● USB-configuratie ● Tv-configuratie ● Taal ● Beginwaarden herstellen
<p>Op ? Help vindt u beschrijvingen van functies en tips voor het gebruik van de camera.</p>	<ul style="list-style-type: none"> ● Toptien handigste tips ● Camera-accessoires ● Cameraknoppen ● Opnamemodi gebruiken ● Ontwerpgalerie gebruiken ● Photosmart Express gebruiken ● Foto's afdrukken ● Audioclips opnemen ● Videoclips opnemen

Menu	Opties
	<ul style="list-style-type: none"> • Foto's en video bekijken • Afdrukken uit video extraheren • Opnames verwijderen • Opnames overbrengen • Batterijbeheer • Hulp en ondersteuning • Camerasseltoetsen • Info...

Als u op  drukt in de modus **Liveweergave** of **Weergave**, ziet u het **Menu Photosmart Express**.

Menu	Opties
<p>Met  Photosmart Express kunt u foto's of groepen foto's (favorieten) selecteren om af te drukken, online te kopen of te delen met familie en vrienden.</p>	<ul style="list-style-type: none"> •  Afdrukken •  Delen •  Afdrukken kopen •  Favorieten •  Help

Nederlands

Câmera digital HP Photosmart R827

Português



Informações legais e avisos

© Copyright 2006 Hewlett-Packard Development Company, L.P.

As informações aqui contidas estão sujeitas a alterações sem aviso prévio. As únicas garantias para produtos e serviços da HP são as estabelecidas nas declarações de garantia expressa que acompanham tais produtos e serviços. Nenhuma informação aqui contida pode ser considerada como uma garantia adicional. A HP se isenta de responsabilidade por erros técnicos ou editoriais ou omissões aqui contidas.

Windows® é uma marca registrada da Microsoft Corporation nos Estados Unidos.



O logotipo SD é uma marca comercial de seu proprietário.



Descarte de equipamento residencial na União Européia

Este símbolo no produto ou na embalagem indica que ele não deve ser descartado juntamente com os demais lixos domésticos. É de sua responsabilidade o descarte do equipamento, levando-o a um local de coleta designado para a reciclagem de equipamentos elétricos e eletrônicos usados. A coleta e a reciclagem apropriadas de seu equipamento usado no momento do descarte ajudarão a conservar os recursos naturais e a garantir que a reciclagem se dará de maneira a proteger a saúde humana e o ambiente. Para mais informações sobre onde deixar seu equipamento para reciclagem, por favor, dirija-se à administração municipal, ao serviço de coleta de lixo ou à loja onde você adquiriu o produto.

Para referência futura, preencha as seguintes informações:

- Número do modelo (na frente da câmera): _____
- Número de série (na parte inferior da câmera): _____
- Data de aquisição: _____

Conteúdo

1	Primeiros passos	4
	Acessar a versão eletrônica do Guia do	
	Usuário	5
	Partes superior e traseira da câmera	6
	Partes frontal, lateral e inferior da câmera	8
	Suporte da estação de acoplamento da	
	câmera	8
2	Preparar a câmera	10
	Instalar a bateria	10
	Carregar a bateria	10
	Ligue a câmera	11
	Escolher o idioma	11
	Definir a região	11
	Configurar data e hora	11
	Instalar e formatar cartão de memória	
	opcional	12
	Instalar o software	13
3	Tirar fotos e gravar clipes de vídeo	15
	Tirar uma foto estática	15
	Gravar um clipe de vídeo	15
4	Rever e excluir imagens e clipes de vídeo	
	17
	Rever imagens e clipes de vídeo	17
	Excluir uma imagem	17
5	Transferir e imprimir imagens	18
	Transferir imagens	18
	Imprimir imagens diretamente da câmera	19
6	Referência rápida da câmera	20

1 Primeiros passos

Este Guia de Início Rápido fornece as informações de que você precisa para começar a usufruir dos principais recursos da câmera. Para obter informações detalhadas sobre os recursos da câmera, consulte a versão eletrônica do Guia do Usuário.

Guia de Início Rápido	Versão eletrônica do Guia do Usuário
<p>Este guia impresso irá ajudá-lo a:</p> <ul style="list-style-type: none">• Iniciar rapidamente o uso da câmera• Instalar o software HP Photosmart• Conhecer os recursos básicos da câmera	<p>O Guia do Usuário eletrônico inclui:</p> <ul style="list-style-type: none">• Descrições de todos os recursos da câmera• Uma descrição dos ícones do Visor de imagens• Informações sobre baterias, incluindo:<ul style="list-style-type: none">– Como prolongar a vida das baterias– Uma descrição dos ícones indicadores de alimentação• Solução de problemas• Com obter assistência da HP• Especificações da câmera

Acessar a versão eletrônica do Guia do Usuário



A versão eletrônica do Guia do Usuário está no HP Photosmart Software CD.

Para visualizar o Guia do Usuário:

1. Insira o HP Photosmart Software CD na unidade de CD do computador.
2. **Em ambiente Windows:** Clique em **Ver o Guia do Usuário** na página principal da tela de instalação.
No Macintosh: Abra o arquivo **leiam** na pasta **docs** no CD.

A versão eletrônica do Guia do Usuário também é copiada para o computador, ao se instalar o software HP Photosmart. Para visualizar o Guia do Usuário após ele ter sido instalado no computador:

- **Em ambiente Windows:** Abra a **Central de Soluções HP** e clique em **Ajuda e suporte**.
- **No Macintosh:** Abra o **Gerenciador de dispositivos HP** e selecione **Guia do Usuário da Câmera** no menu suspenso **Informações e configurações**.

Obter assistência







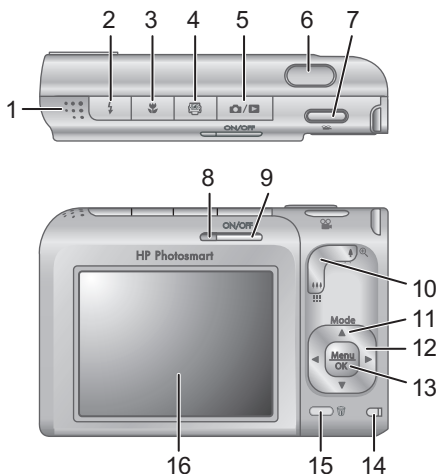





- Para obter dicas e ferramentas que o ajudem a utilizar a câmera de maneira mais eficiente, visite **www.hp.com/photosmart** (somente em inglês) ou **www.hp.com**.
- Para ajuda com seu produto, diagnósticos e download de drivers 24 horas por dia, visite **www.hp.com/support**.

- Para obter ajuda com o software HP Photosmart, veja a ajuda online do software.

Partes superior e traseira da câmera



1	Alto-falante
2	Botão Flash — As configurações são Automático, Flash ligado e Flash desligado.
3	Botão Foco — As configurações são Normal, Macro, Macro automático e Infinito.
4	Botão Photosmart Express — As opções são: Imprimir, Compartilhar, Comprar impr., Favoritos, Ajuda.
5	Botão Exibição ao vivo/Reproduzir — Muda entre Exibição ao vivo e Reproduzir (veja <i>Exibição ao vivo</i> e <i>Reproduzir</i> na página 20).
6	Botão Obturador .

7	 Botão Vídeo .
8	Luz de alimentação
9	Botão ON/OFF.
10	Controle do Zoom (Digital e Óptico) — Em Exibição ao vivo , pressione  para aumentar o zoom ou pressione  para diminuir o zoom. Em Reproduzir , pressione  para ampliar a imagem selecionada, ou pressione  para visualizar miniaturas de suas imagens.
11	Botão Mode (Modo) — Pressione  para acessar o menu Modo Fotografia enquanto estiver em Exibição ao vivo . As opções de Modo Fotografia são: Modo Automático, Paisagem, Retrato, Foto nítida, Panorama direita, Panorama esquerda, Teatro, Ação, Retrato noturno, Cena noturna, Praia, Neve, Pôr-do-sol, Documento.
12	  e   — Rolam por menus e imagens.
13	 — Exibe menus da câmera, seleciona opções e confirma ações.
14	Luz de carregamento das baterias
15	 Botão Excluir — Acessa a função Excluir estando em Reproduzir .
16	Visor de imagens

Partes frontal, lateral e inferior da câmera

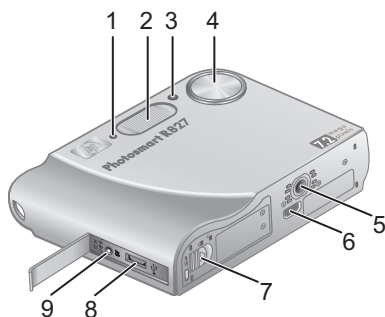

1	Microfone
2	Flash
3	Luz do Timer interno/Auxiliar de foco.
4	Lente
5	Encaixe para tripé
6	Conector da estação de acoplamento
7	Porta da bateria/cartão de memória
8	Conector USB
9	Conector do adaptador de alimentação

Suporte da estação de acoplamento da câmera

Se você comprar uma estação de acoplamento opcional HP Photosmart, ela virá com vários suportes transparentes. Ao instalar a estação de acoplamento para uso com esta câmera, use o suporte da estação de acoplamento com a etiqueta redonda azul. Consulte o

Guia do Usuário da estação de acoplamento para obter instruções.

Português

2 Preparar a câmera

Instalar a bateria

1. Abra a porta da bateria/cartão de memória, deslizando-a conforme indicado na porta.
2. Insira a bateria no slot maior, empurrando-a até que se encaixe.
3. Feche a porta da bateria/cartão de memória.



Nota Desligue a câmera antes de remover a bateria. Carregue completamente a bateria antes de utilizá-la pela primeira vez.

Carregar a bateria

Você pode carregar a bateria dentro da câmera, utilizando o adaptador AC.

1. Conecte a extremidade menor do cabo de alimentação ao adaptador de alimentação AC e a extremidade maior a uma tomada de parede.
2. Conecte o cabo fino do adaptador de alimentação AC à câmera, conforme a ilustração.

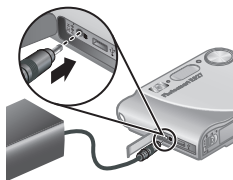

A luz piscante de carregamento de bateria da câmera indica que a bateria está sendo carregada; a bateria estará totalmente carregada quando a luz parar de piscar e ficar constantemente acesa (de duas a três horas).

Ligue a câmera

Para ligar a câmera, pressione o botão ON/OFF (liga/desliga).

Escolher o idioma

Use ▲▼◀▶ para escolher o idioma desejado e, a seguir, pressione $\frac{\text{Menu}}{\text{OK}}$.

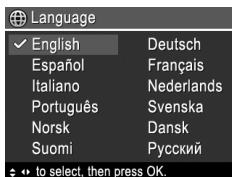

Definir a região

Juntamente com a configuração **Idioma**, a configuração **Região** determina o formato padrão de data e o formato de sinal de vídeo para exibir imagens da câmera em uma televisão.

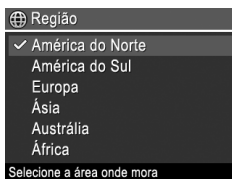

Use ▲▼ para escolher a região desejada; a seguir, pressione $\frac{\text{Menu}}{\text{OK}}$.

Configurar data e hora

A configuração correta da data e da hora irá ajudá-lo a localizar as imagens depois que elas forem transferidas para o computador, e irá assegurar que as imagens

sejam marcadas de maneira precisa se você usar o recurso de gravação de data e hora.

1. Use ▲▼ para ajustar o valor realçado.
2. Use ◀▶ para ir para outras seleções e repita a Etapa 1 até que a data e a hora estejam configuradas corretamente.
3. Pressione $\frac{\text{Menu}}{\text{OK}}$ quando as configurações de data, hora e formato estiverem corretas e pressione $\frac{\text{Menu}}{\text{OK}}$ novamente para confirmar.

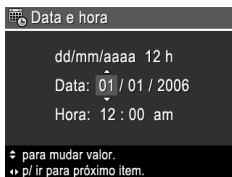

Instalar e formatar cartão de memória opcional





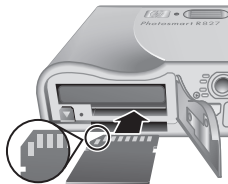



Essa câmera é compatível com cartões de memória padrão e de alta velocidade Secure Digital (SD) de 8 MB até 2 GB.

1. Desligue a câmera e abra a porta da bateria/cartão de memória.
2. Insira o cartão de memória opcional no slot menor, como demonstrado. Verifique se o cartão de memória está encaixado.
3. Feche a porta da bateria/cartão de memória e ligue a câmera.



Sempre formate os cartões de memória novos antes do primeiro uso. A formatação exclui todas as imagens do cartão de memória, portanto certifique-se de que as

imagens existentes sejam transferidas antes da formatação.

1. Com a câmera ligada, pressione  /  até entrar em **Reproduzir**.
2. Pressione  para exibir o submenu **Excluir**.
3. Use   para selecionar **Formatar cartão** e pressione .
4. Use   para selecionar **Sim** e pressione  para formatar o cartão.

Uma vez instalado um cartão de memória, todas as novas imagens e clipes de vídeo serão armazenados no cartão e não na memória interna.

Para utilizar a memória interna e visualizar imagens nela armazenadas, remova o cartão de memória.

Instalar o software

O software HP Photosmart oferece recursos para transferir imagens e clipes de vídeo para o computador, assim como para modificar imagens armazenadas (corrigir olhos vermelhos, girar, cortar, redimensionar, ajustar qualidade da imagem, adicionar cores e efeitos especiais, entre outros).

Se você tiver problemas para instalar ou usar o software HP Photosmart, consulte o site de Suporte ao Cliente HP para obter mais informações.

www.hp.com/support.

Windows

Dependendo do seu sistema operacional, você poderá escolher entre a instalação do HP Photosmart Premier e a do HP Photosmart Essencial, ou a instalação do

HP Photosmart Essential será automática. O HP Photosmart Premier inclui mais funcionalidades que a versão Essential. Veja a lista de diferenças na versão eletrônica do Guia do Usuário, capítulo 1.

1. Feche todos os programas e desabilite, temporariamente, qualquer software antivírus.
2. Insira o HP Photosmart Software CD na unidade de CD e siga as instruções da tela. Se a janela de instalação não for exibida, clique em **Iniciar**, a seguir, em **Executar**, digite **D:\Setup.exe**, em que **D** é a letra da unidade de CD, e clique em **OK**.
3. Quando a instalação do software for concluída, reabilite o software antivírus.

Macintosh



Para poder instalar o software HP Photosmart Mac, o Macintosh tem que atender os requisitos de sistema, conforme descrito na embalagem da câmera.

1. Insira o HP Photosmart Software CD na unidade de CD.
2. Na área de trabalho do computador, clique duas vezes no ícone do CD.
3. Clique duas vezes no ícone do instalador e siga as instruções da tela.

3 Tirar fotos e gravar clipes de vídeo



A **Exibição ao vivo** permite enquadrar fotos e clipes de vídeo no Visor de imagens.

Tirar uma foto estática

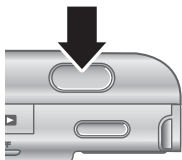

1. Pressione  /  até que  seja exibido no canto superior direito do Visor. Isso indica que a câmera está na **Exibição ao vivo**.
2. Enquadre o objeto/pessoa para sua foto.
3. Pressione o botão **Obturador** até a metade para medir e travar o foco e a exposição. Os colchetes do foco no Visor de imagens ficarão verdes quando o foco estiver travado.
4. Pressione o botão **Obturador** até o fim para tirar a foto.
5. Para adicionar um clipe de áudio de até 60 segundos, continue apertando o botão **Obturador** para baixo, soltando-o quando tiver concluído.

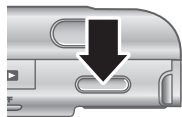

Gravar um clipe de vídeo

1. Pressione  /  até que  seja exibido no canto superior direito do Visor. Isso indica que a câmera está na **Exibição ao vivo**.
2. Enquadre o objeto/pessoa.







3. Pressione e solte o botão **Vídeo** .
4. Para interromper a gravação do vídeo, pressione e solte o botão **Vídeo**  novamente.

4 Rever e excluir imagens e clipes de vídeo









Rever imagens e clipes de vídeo

Você pode rever e excluir imagens e clipes de vídeo em **Reproduzir**.

1. Pressione  /  até que  seja exibido no canto superior direito do Visor de imagens. Isso indica que você está em **Reproduzir**.
2. Use   para percorrer as imagens e clipes de vídeo (os clipes de vídeo são exibidos automaticamente).

Excluir uma imagem

Você pode excluir imagens individuais enquanto estiver em **Reproduzir**:

1. Pressione  /  até que  seja exibido no canto superior direito do Visor de imagens. Isso indica que você está em **Reproduzir**.
2. Use   para selecionar uma imagem ou clipe de vídeo.
3. Pressione  para exibir o submenu **Excluir**.
4. Use   para selecionar **Esta Imagem** e pressione
 Menu
 OK .

5 Transferir e imprimir imagens

Transferir imagens

Se você tiver instalado o software HP Photosmart, use este método para transferir imagens e clipes de vídeo para o computador. Se você não tiver instalado o software HP Photosmart, consulte a versão eletrônica do Guia do Usuário, para um método alternativo.

Dica Também é possível realizar essa tarefa usando uma estação de acoplamento opcional HP Photosmart (veja o Guia do Usuário da estação de acoplamento).

1. Desligue a câmera e conecte-a ao computador, usando o cabo USB que a acompanha.
2. Ligue a câmera e siga as instruções da tela do computador para transferir as imagens.

Para obter mais informações, consulte o recurso Ajuda do software HP Photosmart.

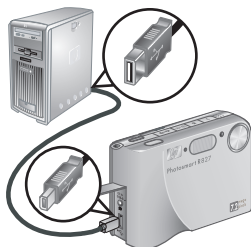

Imprimir imagens diretamente da câmera

Você pode conectar a câmera a qualquer impressora compatível com PictBridge para imprimir imagens estáticas e quadros salvos a partir de um clipe de vídeo.





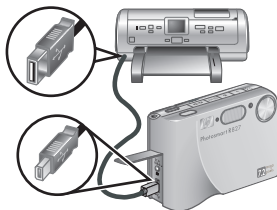



1. Verifique se a impressora está ligada, se há papel e se não há mensagens de erro da impressora.
2. Conecte a câmera e a impressora, utilizando o cabo USB que acompanha a câmera.
3. Ligue a câmera.
4. Quando a câmera estiver conectada à impressora, o **Menu Configurar impressão** será exibido na câmera. Para alterar as configurações, use ▲▼ na câmera para selecionar uma opção do menu e, a seguir, use os ◀▶ na câmera para alterar a configuração.
5. Pressione $\frac{\text{Menu}}{\text{OK}}$ para iniciar a impressão.



6 Referência rápida da câmera

Use este capítulo como uma referência rápida aos recursos da câmera. Para aprender mais sobre esses recursos da câmera, consulte o Guia do Usuário eletrônico.



Exibição ao vivo e Reproduzir



- A **Exibição ao vivo** permite enquadrar fotos e cliques de vídeo no Visor de imagens. Para ativar a **Exibição ao vivo**, pressione  /  até que  seja exibido no canto superior direito do Visor de imagens.
- **Reproduzir** permite rever e excluir imagens e cliques de vídeo. Para ativar **Reproduzir**, pressione  /  até que  seja exibido no canto superior direito do Visor de imagens.

Menus



Quando você pressiona o  em **Reproduzir** ou em **Exibição ao vivo**, você acessa os menus da câmera, como demonstrado na tela de exemplo.





Use  para ir até o menu desejado. Dentro de um menu, use  para ir até as seleções específicas.

Para sair do menu, pressione  /  a qualquer hora.







Os menus e as opções são:

Menu	Opções
<p> Capturar permite ajustar as configurações da câmera que afetam as características de futuras imagens e clipes de vídeo capturadas com a câmera.</p>	<ul style="list-style-type: none">• Modo Fotografia (Modo Automático, Paisagem, Retrato, Foto nítida, Panorama direita, Panorama esquerda, Teatro, Ação, Retrato noturno, Cena noturna, Praia, Neve, Pôr-do-sol, Documento)• Timer interno• Corrigir olhos vermelhos• Compensação da exposição• Iluminação adaptativa• Intervalo• Qualidade da imagem• Qualidade de vídeo• Disparo• Balanço de branco• Área de foco automático• Medição EA• Velocidade ISO• Saturação• Nitidez• Contraste• Gravação de data e hora
<p> Reproduzir permite rever e lidar com as imagens armazenadas na câmera.</p>	<ul style="list-style-type: none">• Análise da imagem• Informações sobre a imagem• Exibir apresentação de slides

Menu	Opções
	<ul style="list-style-type: none">● Montar panorama● Gravar áudio● Mover imagens p/ cartão
 Galeria de projetos permite aprimorar as imagens que você capturou.	<ul style="list-style-type: none">● Aplicar efeitos artísticos● Modificar cor● Adicionar bordas● Corrigir olhos vermelhos● Girar● Cortar
 Configuração permite alterar o comportamento da câmera.	<ul style="list-style-type: none">● Brilho do visor● Volume dos sons● Luz auxiliar de foco● Tempo de espera do visor● Revisão instantânea● Zoom digital● Data e hora● Configuração USB● Configuração de TV● Idioma● Restaurar configurações
 Ajuda oferece descrições de recursos da câmera e dicas de como tirar fotos.	<ul style="list-style-type: none">● Dez melhores dicas● Acessórios da câmera● Botões da câmera● Usar modos de fotografia● Usar a galeria de projetos● Usar o Photosmart Express● Imprimir imagens● Gravar clipes de áudio● Gravar clipes de vídeo● Rever imagens e vídeos

Menu	Opções
	<ul style="list-style-type: none"> • Extrair impressões do vídeo • Excluir imagens • Transferir imagens • Gerenciar baterias • Obter assistência • Atalhos da câmera • Sobre...

Ao se pressionar  em **Exibição ao vivo** ou em **Reproduzir**, vê-se o **menu Photosmart Express**.

Menu	Opções
 Photosmart Express permite selecionar fotos ou grupos de fotos (Favoritos) para imprimir, encomendar online ou compartilhar com amigos e parentes.	<ul style="list-style-type: none"> •  Imprimir •  Compartilhar •  Comprar impr. •  Favoritos •  Ajuda

Português



Favorites (מועדפים) ♥



באופן מקוון, או לשיתוף עם חברים





Help (עזרה) ?





וקרובים.

תפריט	אפשרויות
	<ul style="list-style-type: none"> • Printing Images (הדפסת תמונות) • Recording Audio • Clips (הקלטת קטעי שמע) • Recording Video • Clips (הקלטת קטעי וידאו) • Reviewing Images and Videos (הצגת תמונות וקטעי וידאו) • Extracting Prints from Video (חילוץ הדפסים מווידאו) • Deleting Images (מחיקת תמונות) • Transferring Images (העברת תמונות) • Managing Batteries (טיפול בסוללות) • Getting Assistance (קבלת סיוע) • Camera Shortcuts (קיצורי דרך במצלמה) • About... (אודות)

בעת לחיצה על  מ-Live View (תצוגה חיה) או **Playback Express** (הקרנה חוזרת), יופיע תפריט **Photosmart Express**.

תפריט	אפשרויות
Photosmart Express  מאפשר לבחור צילומים או קבוצות של צילומים (Favorites) להדפסה, לרכישה (מועדפים)	<ul style="list-style-type: none"> • Print  (הדפסה) • Share  (שיתוף) • Buy Prints  (רכישת הדפסים)

תפריט	אפשרויות
	<ul style="list-style-type: none"> ● Sounds Volume (עוצמת הקול של הצלילים) ● Focus Assist Light (נורית עזרה למיקוד) ● Display Timeout (פסק זמן לתצוגה) ● Instant Review (הצגה מיידית) ● Digital Zoom (זום דיגיטלי) ● Date & Time (תאריך ושעה) ● USB ● Configuration (תצורת USB) ● TV Configuration (תצורת טלוויזיה) ● Language (שפה) ● Reset Settings (איפוס הגדרות)
<ul style="list-style-type: none"> ● Top Ten Tips (עשר עצות מובילות) ● Camera Accessories (אביזרי המצלמה) ● Camera Buttons (לחצני המצלמה) ● Using Shooting Modes (שימוש במצבי צילום) ● Using Design Gallery (שימוש בגלריית העיצוב) ● Photosmart Express (שימוש ב-Photosmart Express) 	<ul style="list-style-type: none"> ● Help ? (עזרה) מספקת תיאור למאפייני המצלמה ועצות לצילום.

אפשרויות	תפריט
<ul style="list-style-type: none"> • ISO Speed (מהירות ISO) • Saturation (רוייה) • Sharpness (חדות) • Contrast (ניגודיות) • Date & Time • Imprint (הטבעת תאריך ושעה) 	
<ul style="list-style-type: none"> • Image Advice (עצת תמונה) • Image Info (פרטי תמונה) • View Slideshow (הצגת תצוגת שקופיות) • Stitch Panorama (חיבור פנורמה) • Record Audio (הקלטת שמע) • Move Images to Card (העברת תמונות לכרטיס) 	<p>Playback  (הקרנה חוזרת)</p> <p>מאפשר הצגה ותפעול של תמונות שאחסנת במצלמה.</p>
<ul style="list-style-type: none"> • Apply Artistic Effects (החלת אפקטים יצירתיים) • Modify Color (שינוי צבע) • Add Borders (הוספת גבולות) • Remove Red • Eyes (הסרת עיניים אדומות) • Rotate (סיבוב) • Crop (חיתוך) 	<p>Design Gallery  (גלריית עיצוב)</p> <p>מאפשרת שיפור של התמונות שנלכדו.</p>
<ul style="list-style-type: none"> • Display Brightness (בהירות התצוגה) 	<p>Setup  (הגדרות)</p> <p>מאפשר שינוי הגדרות המצלמה.</p>







תפריטים ואפשרויות:

אפשרויות	תפריט
<ul style="list-style-type: none"> • Shooting Mode (מצב צילום) Auto Mode (מצב אוטומטי), Landscape (נוף), Portrait (דיוקן), Steady Photo (צילום יציב), Panorama Right (פנורמה ימין), Panorama Left (פנורמה שמאל), Theatre (תיאטרון), Action (פעולה), Night Portrait (דיוקן בלילה), Night Scenery (תרחיש בלילה), Beach (חוף), Snow (שלג), Sunset (שקיעה), Document (מסמך) • Self-Timer (קוצב-זמן עצמי) • Red-Eye Removal (הסרת עיניים אדומות) • Exposure Compensation (פיצוי חשיפה) • Adaptive Lighting (תאורה מותאמת) • Bracketing (תחימה) • Image Quality (איכות תמונה) • Video Quality (איכות וידאו) • Burst (צילום מתפרץ) • White Balance (איזון לבן) • Auto Focus Area (מיקוד אוטומטי) • AE Metering (מדידת חשיפה אוטומטית) 	<ul style="list-style-type: none"> • Capture  (לכידה) מאפשר התאמת הגדרות המצלמה המשפיעות על מאפייני התמונות וקטעי הווידאו שאתה לוכד באמצעות המצלמה.

6 עיון מהיר במצלמה



היעזר בפרק זה לצורך עיון מהיר במאפייני המצלמה. לקבלת מידע נוסף אודות מאפייני המצלמה, עיין במדריך האלקטרוני למשתמש.



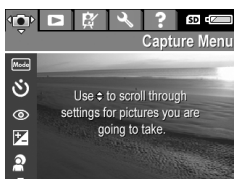

תצוגה חיה והקרנה חוזרת



- **Live View** (תצוגה חיה) מאפשרת לך לתחום תמונות וקטעי וידאו בתצוגת התמונות. להפעלת מצב **Live View** (תצוגה חיה), לחץ על  /  עד להופעת הסמל  למשך פרק זמן קצר בפינה הימנית העליונה בתצוגת התמונות.
- מצב **Playback** (הקרנה חוזרת) מאפשר הצגה ומחיקה של תמונות וקטעי וידאו. להפעלת **Playback** (הקרנה חוזרת), לחץ על  /  עד להופעת הסמל  למשך פרק זמן קצר בפינה הימנית העליונה בתצוגת התמונות.

תפריטים



בעת לחיצה על  (תפריט) /  אישור) מ-**Playback** (הקרנה חוזרת) או **Live View** (תצוגה חיה), אתה ניגש לתפריטי המצלמה בכרטיסים, כמוצג בדוגמה שבמסך.

השתמש ב-  כדי לעבור לתפריט הרצוי. בתפריט, השתמש ב-  כדי לעבור לבחירות מסוימות.

ליציאה מתפריט, לחץ על  /  בכל שלב.

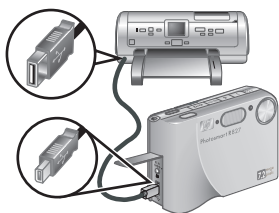

2. חבר את המצלמה ואת המדפסת בעזרת כבל ה-USB המצורף למצלמה.

3. הפעל את המצלמה.

4. כאשר המצלמה מחוברת למדפסת, יוצג במצלמה

Print Setup Menu

(תפריט הגדרת הדפסה). לשינוי ההגדרות, השתמש ב-

▲▼ במצלמה לבחירת אפשרות מהתפריט, לאחר מכן השתמש ב-◀▶ במצלמה לשינוי ההגדרות.

5. לחץ על $\frac{\text{Menu}}{\text{OK}}$ (תפריט/אישור) כדי להתחיל להדפיס.

5 העברה והדפסה של תמונות

העברת תמונות

אם התקנת את תוכנת HP Photosmart, היעזר בה לצורך העברת תמונות וקטעי וידאו למחשב. אם לא התקנת את תוכנת HP Photosmart, עיין במדריך האלקטרוני למשתמש למידע אודות שיטות העברה אחרות.

עצה כמו כן, באפשרותך לבצע משימה זו בעזרת תחנת עגינה אופציונלית HP Photosmart למצלמה (עיין במדריך למשתמש של תחנת העגינה).



1. כבה את המצלמה ולאחר מכן חבר אותה למחשב בעזרת כבל ה-USB המצורף למצלמה.
2. הפעל את המצלמה ופעל בהתאם להוראות שעל-גבי המסך להעברת התמונות. לקבלת מידע נוסף, עיין במאפיין Help (עזרה) בתוכנת HP Photosmart.

הדפסת תמונות מהמצלמה







באפשרותך לחבר את המצלמה לכל מדפסת מאושרת-PictBridge כדי להדפיס תמונות סטיל ותמונות שנשמרו מקטע וידאו.

1. ודא שהמדפסת מופעלת, שיש בה נייר ושלא מופיעות בה הודעות שגיאה.

4 הצגה ומחיקה של תמונות וקטעי וידאו











הצגת תמונות וקטעי וידאו

באפשרותך להציג ולמחוק תמונות וקטעי וידאו ב-**Playback** (הקרנה חוזרת).

1. לחץ על  /  עד להופעת  למשך פרק זמן קצר בפינה הימנית העליונה בתצוגת התמונות. סמל זה מציין כי הנך נמצא במצב **Playback** (הקרנה חוזרת).
2. השתמש ב-  כדי לגלול בין התמונות ובין קטעי הווידאו (קטעי הווידאו יוצגו באופן אוטומטי).

מחיקת תמונה

באפשרותך למחוק תמונות בודדות במהלך מצב **Playback** (הקרנה חוזרת):

1. לחץ על  /  עד להופעת  למשך פרק זמן קצר בפינה הימנית העליונה בתצוגת התמונות. סמל זה מציין כי הנך נמצא במצב **Playback** (הקרנה חוזרת).
2. השתמש ב-  לבחירת תמונה או קטע וידאו.
3. לחץ על  כדי להציג את תפריט המשנה **Delete** (מחיקה).
4. השתמש ב-  לבחירת האפשרות **This Image** (תמונה זו) ולאחר מכן לחץ על   (תפריט/אישור).

3 צילום תמונות והקלטת קטעי וידאו

Live View (תצוגה חיה) מאפשרת לך לתחום תמונות וקטעי וידאו בתצוגת התמונות.

צילום תמונת סטילס

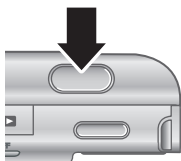

1. לחץ על / עד להופעת הסמל למשך פרק זמן קצר בפינה הימנית העליונה בתצוגת התמונות. סמל זה מציין כי הנך נמצא במצב **Live View** (תצוגה חיה). מסגר את נושא הצילום.
2. לחץ לחיצה חלקית על לחצן **התריס** כדי למדוד ולנעול את החשיפה והמיקוד. תוחמי המיקוד בתצוגת התמונות יופיעו בירוק רציף כאשר המיקוד ננעל.
3. לחץ לחיצה מלאה על לחצן **התריס** על מנת לצלם את התמונה.
4. להוספת קטע שמע באורך של עד 60 שניות, המשך ללחוץ על לחצן **התריס** ושחרר אותו לאחר שתסיים.

הקלטת קטע וידאו

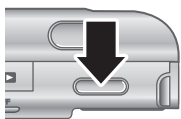

1. לחץ על / עד להופעת הסמל למשך פרק זמן קצר בפינה הימנית העליונה בתצוגת התמונות. סמל זה מציין כי הנך נמצא במצב **Live View** (תצוגה חיה). מסגר את נושא הצילום.
2. לחץ על הלחצן **וידאו** ושחרר אותו.
3. להפסקת הקלטת וידאו, לחץ שנית על הלחצן **וידאו** ושחרר אותו.

3. לחץ לחיצה כפולה על סמל ההתקנה ולאחר מכן פעל
בהתאם להוראות על-גבי המסך.

עברית

(הסרת עיניים אדומות, סיבוב, חיתוך, שינוי גודל, התאמת איכות תמונה, הוספת צבעים ואפקטים מיוחדים ועוד).

אם אתה נתקל בבעיה בעת התקנה או שימוש בתוכנת HP Photosmart, עיין באתר האינטרנט של שירות הלקוחות של HP לקבלת מידע נוסף, בכתובת: www.hp.com/support.

Windows

בהתאם למערכת ההפעלה שלך, באפשרותך לבחור להתקין את התוכנה HP Photosmart Premier או את התוכנה HP Photosmart Essential, או שתבצע התקנה אוטומטית של HP Photosmart Essential. גירסת HP Photosmart Premier כוללת פונקציונליות נוספת שאינה כלולה בגירסת Essential. לקבלת רשימה של ההבדלים, עיין בפרק 1 במדריך האלקטרוני למשתמש.

1. סגור את כל התוכניות והשבת באופן זמני תוכנות להגנה מפני וירוסים.
2. הכנס את תקליטור תוכנת HP Photosmart לכוון התקליטורים במחשב ופעל בהתאם להוראות על-גבי המסך. אם חלון ההתקנה לא מופיע, לחץ על **התחל** (Start), לחץ על **הפעלה** (Run), הקלד **D:\Setup.exe**, כאשר **D** היא אות כונן התקליטורים, ולאחר מכן לחץ על **אישור** (OK).
3. לאחר סיום התקנת התוכנה, הפעל מחדש את התוכנה להגנה מפני וירוסים.

Macintosh

על מנת להתקין את תוכנת HP Photosmart Mac, על מחשב ה-Macintosh שברשותך לעמוד בדרישות המערכת, המפורטות על-גבי אריזת המצלמה.

1. הכנס את תקליטור תוכנת HP Photosmart לכוון התקליטורים.
2. לחץ לחיצה כפולה על סמל התקליטור בשולחן העבודה.

התקנה ואתחול של כרטיס זיכרון אופציונלי

מצלמה זו תומכת בכרטיסי זיכרון (SD) Secure Digital סטנדרטיים ובעלי מהירות גבוהה מתוצרת HP, בנפח 8MB עד 2GB.

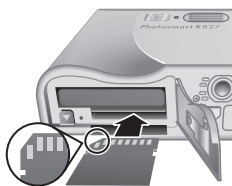

1. כבה את המצלמה ופתח את דלת הסוללה/כרטיס הזיכרון.
2. הכנס את כרטיס הזיכרון האופציונלי לחריץ הקטן כמוצג. ודא שכרטיס הזיכרון מתייב במקומו בנקישה.
3. סגור את דלת הסוללה/כרטיס הזיכרון והפעל את המצלמה.

אתחל תמיד את כרטיס הזיכרון החדש לפני השימוש הראשוני. האתחול מסיר את כל התמונות מכרטיס הזיכרון, לכן עליך להקפיד לטעון את התמונות הקיימות לפני ביצוע האתחול.

1. כאשר המצלמה מופעלת, לחץ על / עד שתגיע למצב **Playback** (הקרנה חוזרת).
2. לחץ על כדי להציג את תפריט המשנה **Delete** (מחיקה).
3. השתמש ב- לבחירת האפשרות **Format Card** (אתחול כרטיס) ולאחר מכן לחץ על **OK** (תפריט/אישור).
4. השתמש ב- לבחירת האפשרות **Yes** (כן) ולאחר מכן לחץ על **OK** (תפריט/אישור) לאתחול הכרטיס.

לאחר שתתקין כרטיס זיכרון, כל התמונות וקטעי הווידאו החדשים יאוחסנו בכרטיס במקום בזיכרון הפנימי.

על מנת להשתמש בזיכרון הפנימי ולהציג את התמונות המאוחסנות בו, הסר את כרטיס הזיכרון.

התקנת התוכנה

תוכנת HP Photosmart מספקת מאפיינים להעברת תמונות וקטעי וידאו למחשב, וכן מאפיינים לשיפור תמונות מאוחסנות

בחירת שפה

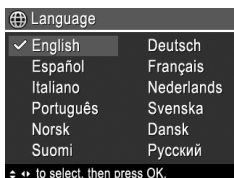

השתמש ב-▲▼▶◀ לבחירת השפה הרצויה, לאחר מכן לחץ על **Menu** (תפריט/אישור).

בחירת מדינה/אזור

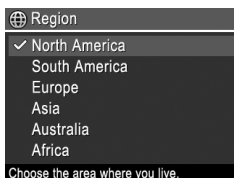

כמו ההגדרה **Language** (שפה), ההגדרה **Region** (מדינה/אזור) קובעת את ברירת המחדל עבור תבנית התאריך ואת שיטת השידור של אותות הווידאו והצגת תמונות מהמצלמה בטלוויזיה.

השתמש ב-▲▼▶◀ לבחירת המדינה/אזור הרצויים, לאחר מכן לחץ על **Menu** (תפריט/אישור).

הגדרת תאריך ושעה

הגדרת התאריך והשעה באופן מדויק תסייע לך לאתר תמונות לאחר העברתן למחשב, ותבטיח שהתמונות יסומנו באופן מדויק אם תעשה שימוש במאפיין הטבעת התאריך והשעה.

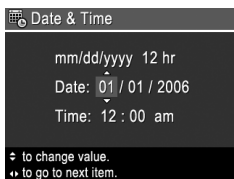

1. השתמש ב-▲▼ כדי לכוון את הערך המסומן.
2. השתמש ב-▶◀ כדי לעבור לאפשרויות האחרות וחזור על שלב 1 עד להגדרת התאריך והשעה כהלכה.
3. לחץ על **Menu** (תפריט/אישור) כאשר הגדרות התאריך, השעה והתבנית נכונות, לאחר מכן לחץ שנית על **Menu** (תפריט/אישור) לאישור.

2 הגדרת המצלמה

התקנת הסוללות

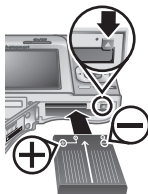

1. פתח את דלת הסוללה/כרטיס הזיכרון על-ידי הסטת תפס הדלת, כפי שמצוין על דלת הסוללה/כרטיס הזיכרון.
2. הכנס את הסוללה לחרוץ הרחב יותר, ודחוף אותה עד שהתפס יינעל.
3. סגור את דלת הסוללה/כרטיס זיכרון.

הערה כבה את המצלמה לפני שתסיר את הסוללה. טען את הסוללה במלואה לפני השימוש הראשוני.

טעינת הסוללה

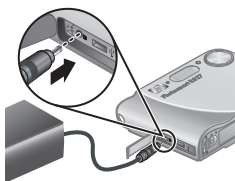

- באפשרותך לטעון את הסוללה במצלמה, בעזרת מתאם ה-AC.
1. חבר את הקצה הצר של כבל המתח למתאם מתח AC, ואת הקצה הרחב לשקע חשמל.
 2. חבר את הכבל הדק ממתאם המתח AC למצלמה כמוצג באיור.

כאשר נורית טעינת הסוללה במצלמה מהבהבת, היא מציינת שהסוללה נמצאת בטעינה; כאשר הסוללה דולקת באור רציף, הסוללה טעונה במלואה (כ-2 עד 3 שעות).

הפעלת המצלמה

להפעלת המצלמה, לחץ על לחצן ON/OFF (הפעלה/כיבוי).

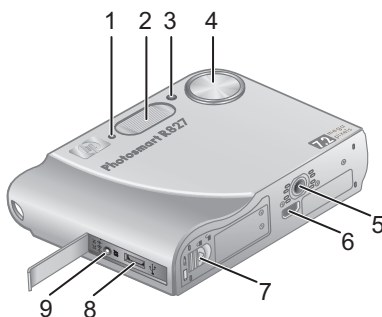

החלק הקדמי, הצד והחלק התחתון של המצלמה



1	מיקרופון.
2	הבזק.
3	נורית עזר לקוצב-זמן עצמי/מיקוד.
4	עדשה.
5	תושבת חצובה.
6	מחבר לתחנת עגינה.
7	דלת סוללה/כרטיס זיכרון.
8	מחבר USB.
9	מחבר מתאם מתח.

תושבת לתחנת עגינה למצלמה

בעת רכישת תחנת עגינה אופציונלית HP Photosmart, היא מצוידת בתושבות שקופות. בעת התקנת תחנת העגינה לשימוש עם המצלמה, השתמש בתושבת לתחנת העגינה בעלת התווית הכחולה העגולה. לקבלת הוראות, עיין במדריך למשתמש בתחנת העגינה.

8	נורית הפעלה.
9	לחצן ON/OFF (הפעלה/כיבוי).
10	מתג זום (דיגיטלי ואופטי) - ב- Live View (תצוגה חיה), לחץ על  (זום קרוב) כדי לקרוב או לחץ על    (זום רחוק) כדי להרחיק. ב- Playback (הקרנה חוזרת), לחץ על  כדי להגדיל את התמונה הנבחרת או לחץ על    כדי לראות את התמונות ממוזערות.
11	לחצן Mode (מצב)—לחץ על  כדי לגשת לתפריט Shooting Mode (מצב צילום) כשאתה נמצא במצב Live View (תצוגה חיה). אפשרויות Shooting Mode (מצב צילום) הן Auto Mode (מצב אוטומטי), Landscape (נוף), Portrait (דיוקן), Steady (צילום יציב), Panorama Right (פנורמה ימין), Panorama Left (פנורמה שמאל), Theatre (תיאטרון), Action (פעולה), Night Portrait (דיוקן בלילה), Night Scenery (תרחיש בלילה), Beach (חוף), Snow (שלג), Sunset (שקיעה), Document (מסמך).
12	לחצני  ולחצני  —לגלילה בתפריטים ובתמונות.
13	לחצן  (תפריט/אישור) - להצגת תפריטי המצלמה, בחירת אפשרויות ואישור פעולות.
14	נורית טעינת סוללה.
15	לחצן מחיקה —כדי לגשת לפונקציה Delete (מחיקה) במצב Playback (הקרנה חוזרת).
16	תצוגת תמונות.

חלקה העליון והאחורי של המצלמה

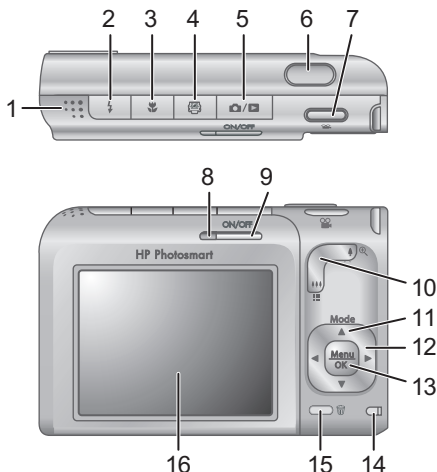

1	רמקול.
2	לחצן הבזק - ההגדרות הן Auto (אוטומטי), Flash On (הבזק פועל), Flash Off (הבזק כבוי).
3	לחצן מיקוד - ההגדרות הן Normal (רגיל), Macro (מאקרו), Auto Macro (מאקרו אוטומטי), Infinity (אינסוף).
4	לחצן Photosmart Express —האפשרויות הן Print (הדפסה), Share (שיתוף), Buy Prints (רכישת הדפסים), Favorites (מועדפים), Help (עזרה).
5	לחצן Live View/Playback (תצוגה חיה/הקרנה חוזרת)—למעבר בין Live View (תצוגה חיה) לבין Playback (הקרנה חוזרת) (ראה "תצוגה חיה והקרנה חוזרת" בעמוד 18).
6	לחצן תריס .
7	לחצן וידאו .

2. **במחשב Windows:** בדף הראשי במסך ההתקנה, לחץ על **View User Guide** (הצג את המדריך למשתמש).

במחשב Macintosh: פתח את קובץ **readme** בתיקייה **docs** שבתקליטור.

המדריך האלקטרוני למשתמש מועתק גם למחשב בעת התקנת התוכנה HP Photosmart. להצגת המדריך למשתמש לאחר שהותקן במחשב:

- **במחשב Windows:** פתח את **HP Solution Center** (מרבז הפתרונות של HP) ולחץ על **Help and Support** (עזרה ותמיכה).
- **במחשב Macintosh:** פתח את **HP Device Manager** ובחר **Camera User Guide** בתפריט המוקפץ **Information and Settings**.

קבלת סיוע

- לקבלת עצות וכלים שיעזרו לך להשתמש במצלמה ביעילות רבה יותר, בקר בכתובת **www.hp.com/photosmart** (באנגלית בלבד) או בכתובת **www.hp.com**.
- לקבלת סיוע, כלי אבחון והורדות מנהלי התקן עבור המוצר, 7 ימים בשבוע, 24 שעות ביממה, בקר בכתובת **www.hp.com/support**.
- לקבלת עזרה אודות התוכנה HP Photosmart Software, עיין בעזרה המקוונת של התוכנה.

1 תחילת הדרך

המדריך להפעלה מהירה המודפס מספק את המידע שלו אתה זקוק בתחילת הדרך לשימוש במאפיינים החיוניים של המצלמה. לקבלת מידע מפורט אודות מאפייני המצלמה, עיין במדריך האלקטרוני למשתמש.

מדריך אלקטרוני למשתמש	מדריך להפעלה מהירה
המדריך האלקטרוני למשתמש מכיל: <ul style="list-style-type: none">• תיאורים של כל מאפייני המצלמה• תיאור סמלים על-גבי תצוגת התמונות• מידע אודות סוללות, לרבות:<ul style="list-style-type: none">– הארכת חיי הסוללות– תיאור של סמלי מחווני ההספק• פתרון בעיות• קבלת סיוע מ-HP• מפרטי המצלמה	מדריך מודפס זה יסייע לך: <ul style="list-style-type: none">• להתחיל להשתמש במצלמה במהירות• להתקין את תוכנת HP Photosmart• להכיר את המאפיינים הבסיסיים של המצלמה שברשותך

גישה למדריך האלקטרוני למשתמש

המדריך האלקטרוני למשתמש נמצא בתקליטור התוכנה HP Photosmart



להצגת המדריך למשתמש:

1. הכנס את תקליטור תוכנת HP Photosmart לכונן התקליטורים במחשב.

תוכן עניינים

4.....	1 תחילת הדרך	1
4.....	גישה למדריך האלקטרוני למשתמש	
6.....	חלקה העליון והאחורי של המצלמה	
8.....	החלק הקדמי, הצד והחלק התחתון של המצלמה	
8.....	תושבת לתחנת עגינה למצלמה	
9.....	2 הגדרת המצלמה	2
9.....	התקנת הסוללות	
9.....	טעינת הסוללה	
9.....	הפעלת המצלמה	
10.....	בחירת שפה	
10.....	בחירת מדינה/אזור	
10.....	הגדרת תאריך ושעה	
11.....	התקנה ואתחול של כרטיס זיכרון אופציונלי	
11.....	התקנת התוכנה	
14.....	3 צילום תמונות והקלטת קטעי וידאו	3
14.....	צילום תמונת סטילס	
14.....	הקלטת קטע וידאו	
15.....	4 הצגה ומחיקה של תמונות וקטעי וידאו	4
15.....	הצגת תמונות וקטעי וידאו	
15.....	מחיקת תמונה	
16.....	5 העברה והדפסה של תמונות	5
16.....	העברת תמונות	
16.....	הדפסת תמונות מהמצלמה	
18.....	6 עיון מהיר במצלמה	6

מידע משפטי והודעות

Copyright 2006 Hewlett-Packard Development Company, ©
L.P.

המידע הכלול במסמך זה נתון לשינויים ללא הודעה מוקדמת. האחריות הבלעדית למוצרים ולשירותים של HP מפורטת בהצהרת האחריות המפורשת הנלווית לאותם מוצרים ושירותים. אין לפרש דבר מן האמור במסמך זה כהענקת אחריות נוספת. חברת HP לא תישא באחריות לשגיאות או השמטות מסיבות טכניות או בעקבות עריכה.

Windows® הוא סימן מסחרי רשום בארה"ב של Microsoft Corporation.

הסמל SD הוא סימן מסחרי של בעליו. 

השלכת פסולת ציוד על-ידי משתמשים במשקי בית פרטיים באיחוד האירופי



סמל זה, כאשר הוא מופיע על המוצר או על אריזתו, פירושו שאסור להשליך את המוצר יחד עם שאר האשפה הביתית. במקום זאת, מתפקידך להשליך את פריטי הציוד המשומש הזה על-ידי הפקדתם בנקודות איסוף מיוחדות לצורך מיחזור של פריטי ציוד חשמליים ואלקטרוניים משומשים. האיסוף בנפרד והמיחזור של פריטי ציוד משומשים בעת השלכתם, יסייעו בשמירה על משאבים טבעיים ויבטיחו מיחזור באופן שיש בו כדי להגן על הבריאות ועל הסביבה. לפרטים נוספים על נקודות איסוף לפריטי ציוד משומשים המיועדים למיחזור, פנה אל הרשות המקומית, אל שירות השלכת האשפה הביתית, או אל החנות שבה רכשת את המוצר.

לצורך פניות עתידיות, מלא את הפרטים הבאים:

- מספר דגם (בחלקה הקדמי של המצלמה): _____
- מספר סידורי (בחלקה התחתון של המצלמה): _____
- תאריך רכישה: _____

מצלמה דיגיטלית HP Photosmart R827

עברית

