

# HP Photosmart D5100 series

## User Guide

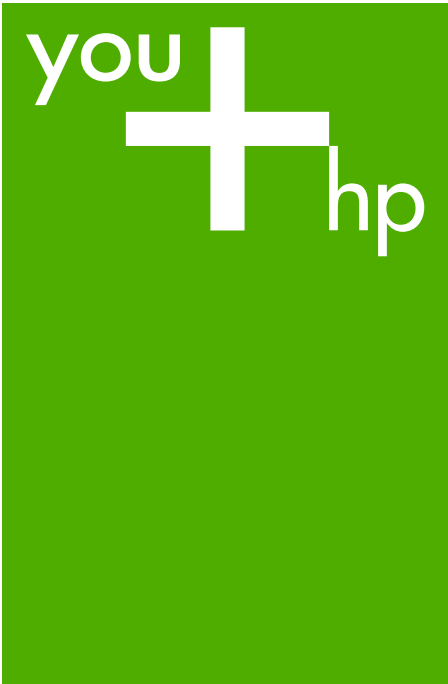



021 672 280	الجزائر
Argentina (Buenos Aires)	54-11-4708-1600
Argentina	0-800-555-5000
Australia	www.hp.com/support/australia
Österreich	www.hp.com/support
17212049	البحرين
België	www.hp.com/support
Belgique	www.hp.com/support
Brasil (Sao Paulo)	55-11-4004-7751
Brasil	0-800-709-7751
Canada (Mississauga Area)	(905) 206-4663
Canada	1-800-474-6836
Central America & The Caribbean	www.hp.com/support
Chile	800-360-999
中国	www.hp.com/support/china
Colombia (Bogotá)	571-606-9191
Colombia	01-8000-51-4746-8368
Costa Rica	0-800-011-1046
Česká republika	810 222 222
Danmark	www.hp.com/support
Ecuador (Andinatel)	1-999-119 800-711-2884
Ecuador (Pacifitel)	1-800-225-528 800-711-2884
(02) 6910602	مصر
El Salvador	800-6160
España	www.hp.com/support
France	www.hp.com/support
Deutschland	www.hp.com/support
Ελλάδα (από το εξωτερικό)	+ 30 210 6073603
Ελλάδα (εντός Ελλάδας)	801 11 75400
Ελλάδα (από Κύπρο)	800 9 2654
Guatemala	1-800-711-2884
香港特別行政區	www.hp.com/support/hongkong
Magyarország	06 40 200 629
India	www.hp.com/support/india
Indonesia	www.hp.com/support
+971 4 224 9189	العراق
+971 4 224 9189	الكويت
+971 4 224 9189	لبنان
+971 4 224 9189	قطر
+971 4 224 9189	اليمن
Ireland	www.hp.com/support
1-700-503-048	ישראל
Italia	www.hp.com/support
Jamaica	1-800-711-2884

日本	www.hp.com/support/Japan
0800 222 47	الأردن
한국	www.hp.com/support/korea
Luxembourg	www.hp.com/support
Malaysia	www.hp.com/support
Mauritius	(262) 262 210 404
México (Ciudad de México)	55-5258-9922
México	01-800-472-68368
081 005 010	المغرب
Nederland	www.hp.com/support
New Zealand	www.hp.com/support
Nigeria	1 3204 999
Norge	www.hp.com/support
24791773	عمان
Panamá	1-800-711-2884
Paraguay	009 800 54 1 0006
Perú	0-800-10111
Philippines	www.hp.com/support
Polska	22 5666 000
Portugal	www.hp.com/support
Puerto Rico	1-877-232-0589
República Dominicana	1-800-711-2884
Reunion	0820 890 323
România	0801 033 390
Россия (Москва)	095 777 3284
Россия (Санкт-Петербург)	812 332 4240
800 897 1415	السعودية
Singapore	www.hp.com/support/singapore
Slovensko	0850 111 256
South Africa (international)	+ 27 11 2589301
South Africa (RSA)	086 0001030
Rest of West Africa	+ 351 213 17 63 80
Suomi	www.hp.com/support
Sverige	www.hp.com/support
Switzerland	www.hp.com/support
臺灣	www.hp.com/support/taiwan
ไทย	www.hp.com/support
071 891 391	تونس
Trinidad & Tobago	1-800-711-2884
Türkiye	+90 212 444 71 71
Україна	(044) 230-51-06
600 54 47 47	الإمارات العربية المتحدة
United Kingdom	www.hp.com/support
United States	www.hp.com/support
Uruguay	0004-054-177
Venezuela (Caracas)	58-212-278-8666
Venezuela	0-800-474-68368
Việt Nam	www.hp.com/support

## Copyrights and trademarks

© 2006 Hewlett-Packard Development Company, L.P.

The information contained herein is subject to change without notice. Reproduction, adaptation, or translation without prior written permission is prohibited, except as allowed under the copyright laws.

## Hewlett-Packard Company notices

The information contained in this document is subject to change without notice.

All rights reserved. Reproduction, adaptation, or translation of this material is prohibited without prior written permission of Hewlett-Packard, except as allowed under copyright laws.

The only warranties for HP products and services are set forth in the express warranty statements accompanying such products and services. Nothing herein should be construed as constituting an additional warranty. HP shall not be liable for technical or editorial errors or omissions contained herein.

## Trademarks

HP, the HP logo, and Photosmart are property of Hewlett-Packard Development Company, L.P.

The Secure Digital logo is a trademark of the SD Association.

Microsoft and Windows are registered trademarks of Microsoft Corporation.

CompactFlash, CF, and the CF logo are trademarks of the CompactFlash Association (CFA).

Memory Stick, Memory Stick Duo, Memory Stick PRO, and Memory Stick PRO Duo are trademarks or registered trademarks of Sony Corporation.

MultiMediaCard is a trademark of Infineon Technologies AG of Germany, and is licensed to the MMCA (MultiMediaCard Association).

Microdrive is a trademark of Hitachi Global Storage Technologies.

xD-Picture Card is a trademark of Fuji Photo Film Co., Ltd., Toshiba Corporation, and Olympus Optical Co., Ltd.

Mac, the Mac logo, and Macintosh are registered trademarks of Apple Computer, Inc.

iPod is a trademark of Apple Computer, Inc.

Bluetooth is a trademark owned by its proprietor and used by Hewlett-Packard Company under license.

PictBridge and the PictBridge logo are trademarks of the Camera & Imaging Products Association (CIPA).

Other brands and their products are trademarks or registered trademarks of their respective holders.

## Regulatory model identification number

For regulatory identification purposes, your product is assigned a Regulatory Model Number. The Regulatory Model Number for your product is VCVRA-0606. This regulatory number should not be confused with the marketing name (HP Photosmart D5100 series, etc.) or product numbers (Q7090A, etc.).

## Energy consumption - Energy Star®

Hewlett-Packard Company is committed to providing quality products in an environmentally sound manner. For information about the HP's environmental product stewardship program see the onscreen help.

# Contents

<b>1</b>	<b>Welcome</b> .....	3
	Accessing the onscreen HP Photosmart Printer Help.....	3
	Printer parts.....	4
	Printer screen.....	6
<b>2</b>	<b>Get ready to print</b> .....	9
	Load paper.....	9
	Choose the right paper.....	9
	Print from the control panel or a computer.....	9
	Load the main tray.....	10
	Load the photo tray.....	11
	Using print cartridges.....	12
	Purchasing replacement print cartridges.....	12
	Print cartridge tips.....	12
	Inserting and replacing the print cartridges.....	13
	Aligning the print cartridges for maximum results.....	13
<b>3</b>	<b>Print without a computer</b> .....	15
	Getting connected.....	15
	Print from a memory card.....	15
	Insert a memory card.....	16
	Memory card types.....	16
	Supported file formats.....	17
	Change the default paper size.....	17
	Decide which photos to print.....	18
	Select a photo layout.....	18
	Select photos to print.....	19
	Print your photos.....	19
	Remove a memory card.....	20
	Printing photos from a digital camera.....	20
	Using a PictBridge camera.....	20
	Using a Bluetooth camera.....	21
	Print photos from other Bluetooth devices.....	21
	Make the Bluetooth connection.....	21
	Print photos from a Bluetooth device.....	21
	Print photos from an iPod.....	21
<b>4</b>	<b>Print from a computer</b> .....	23
	Use creative options in the printer software.....	23
	HP Photosmart Premier (Windows).....	23
	HP Photosmart Essential (Windows).....	23
	HP Photosmart Studio (Mac).....	24
	HP Photosmart Share.....	24
	View photos on your computer screen.....	24
	Save your photos to a computer.....	25
<b>5</b>	<b>Print on CDs and DVDs</b> .....	27
	Create and print CD/DVD labels.....	27
	HP Photosmart Premier.....	27

	HP Photosmart Studio .....	27
	Using HP Photosmart Premier.....	27
	Prepare your printer to print on CDs and DVDs.....	27
	Finish the print job.....	28
<b>6</b>	<b>Care and maintenance</b> .....	<b>31</b>
	Cleaning and maintaining the printer.....	31
	Cleaning the exterior of the printer.....	31
	Cleaning the print cartridges.....	31
	Manually cleaning the print cartridge contacts.....	31
	Updating the software.....	32
	Storing the printer and print cartridges.....	33
	Storing the printer.....	33
	Storing the print cartridges.....	33
	Maintaining the quality of photo paper.....	33
	Storing photo paper.....	34
	Handling photo paper.....	34
<b>7</b>	<b>Troubleshooting</b> .....	<b>35</b>
	Printer hardware problems.....	35
	Printing problems.....	36
	CD/DVD printing problems.....	40
	Bluetooth printing problems.....	41
	Printer screen status indicators.....	42
<b>8</b>	<b>HP Support</b> .....	<b>45</b>
	HP Support by phone.....	45
	Placing a call.....	46
	Return to HP repair service (North America only).....	46
	HP Quick Exchange Service (Japan only).....	46
	Additional warranty options.....	47
<b>9</b>	<b>Specifications</b> .....	<b>49</b>
	System specifications.....	49
	Printer specifications.....	50
<b>10</b>	<b>HP Warranty</b> .....	<b>53</b>
	<b>Index</b> .....	<b>55</b>

# 1 Welcome

Thank you for purchasing an HP Photosmart D5100 series printer! With your new photo printer you can print beautiful photos and save photos to your computer. You can also print images directly on CDs and DVDs using the HP Photosmart D5100 series printer.

This guide primarily explains how to print photos from memory cards, digital cameras, Bluetooth devices, and iPods. To learn how to print from your computer, install the HP Photosmart software and view the onscreen HP Photosmart Printer Help. For an overview of using a computer and the printer together, see [Printing from a computer](#). For information about installing the software, see the *Quick Start* booklet.

The printer comes with the following documentation:

- **Quick Start booklet** — The HP Photosmart D5100 series Quick Start booklet contains quick and easy instructions to help you set up the printer and print your first photo.
- **User Guide** — The HP Photosmart D5100 series User Guide is the book you are reading. This book describes the basic features of the printer, explains how to print on plain paper, photo paper, CDs, and DVDs. In addition, this book contains hardware troubleshooting information.
- **HP Photosmart Printer Help** — The onscreen HP Photosmart Printer Help describes how to use the printer with a computer and contains software troubleshooting information.

## Accessing the onscreen HP Photosmart Printer Help

After you have installed the HP Photosmart software on a computer, you can view the onscreen HP Photosmart Printer Help:

- **Windows PC:** From the **Start** menu, select **Programs** (in Windows XP, select **All Programs**) > **HP** > **Photosmart D5100 series** > **Photosmart Help**.
- **Macintosh:** From the Finder **Help** menu, select **Mac Help**. On the Help Viewer, select **Library** > **HP Photosmart Mac Help**.

# Printer parts

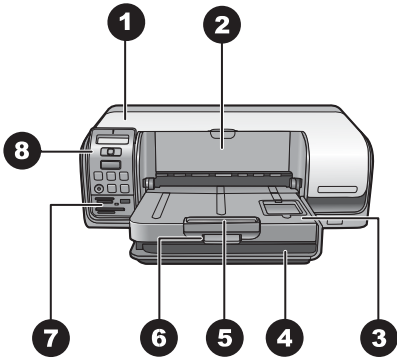

## Front View

1	<b>Main cover:</b> Lift this cover to change cartridges.
2	<b>CD/DVD tray:</b> Lower this tray to insert the CD/DVD holder to print on CDs and DVDs.
3	<b>Output tray:</b> Collect your printed papers and photos from this tray.
4	<b>Main tray:</b> Load paper here.
5	<b>Output tray extension:</b> Pull the extension to hold large output paper.
6	<b>Output tray latch:</b> Use this latch to firmly close the output tray.
7	<b>Memory card and PictBridge camera slots:</b> Insert memory cards and PictBridge cameras here.
8	<b>Control panel:</b> Control the print job from here.

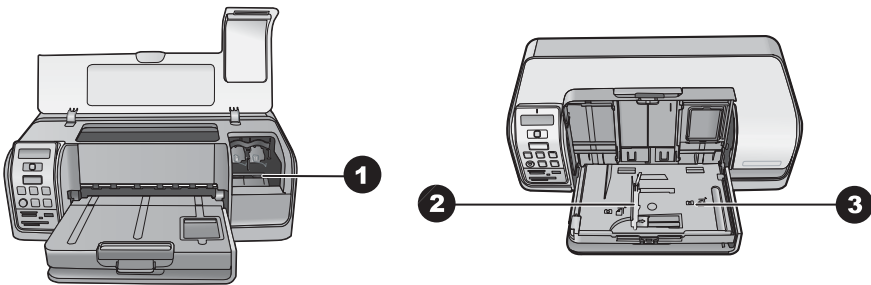

## Inside view

1	<b>Cartridge holder:</b> Load print cartridges here.
2	<b>Photo paper-width guide:</b> Adjust this guide for different paper widths.
3	<b>Photo tray:</b> Load photo paper or other supported small media here.

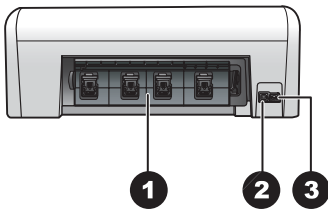

### Back of printer

1	<b>Rear access door:</b> Open this door to clear a paper jam.
2	<b>USB port:</b> Use this port to connect a computer to the printer.
3	<b>Power cord connection:</b> Use this port to connect the power cord included with the printer.

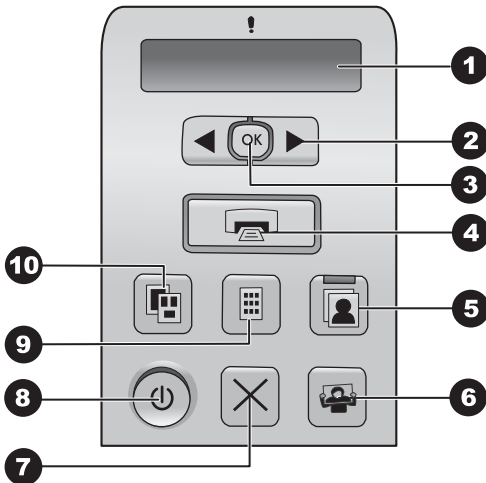

### Control panel

1	<b>Printer screen:</b> Displays photo index number, page layout information, and approximate ink levels.
2	<b>Select Photos ◀ and ▶:</b> Scrolls through photos on a memory card.
3	<b>OK:</b> Selects or deselects the displayed photo index number for printing.
4	<b>Print:</b> Prints selected photos from the inserted memory card.
5	<b>Photo Tray:</b> Selects the photo tray for the next standalone print job.
6	<b>Photosmart Express:</b> Opens the HP Photosmart Express software on a Windows computer and the HP Photosmart Studio software on a Mac.
7	<b>Cancel:</b> Cancels the current print job.
8	<b>On:</b> Turns the printer on or off.
9	<b>Photo Index:</b> Prints thumbnails of all the photos on a memory card.
10	<b>Layout:</b> Chooses the photo layout.



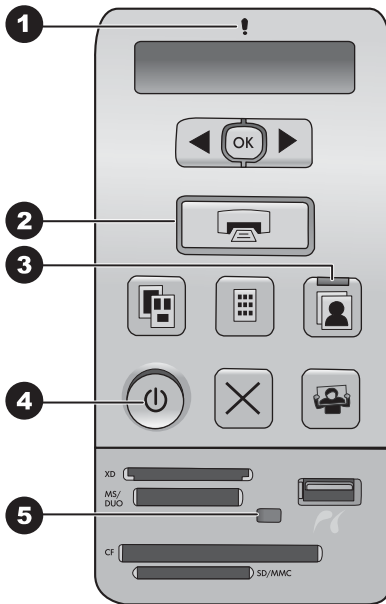

### Indicator lights

1	<b>Attention:</b> Flashing red if there is an error or if some user action is required.
2	<b>Print:</b> Solid green if the printer is ready to print, pulsing green if the printer is busy.
3	<b>Photo Tray:</b> Solid green to indicate that the next standalone print job will be carried out from the photo tray.
4	<b>Power:</b> Solid green if the printer is on, otherwise off.
5	<b>Memory card / PictBridge camera:</b> Solid green if the memory card or PictBridge camera is correctly inserted; flashing green if the printer is accessing a memory card or a PictBridge camera; and off if no memory card or PictBridge camera is inserted or more than one card is inserted.

## Printer screen

The printer screen of the HP Photosmart D5100 series printer displays the status of the printer and helps in the selection of images for printing. The printer screen consists of seven segment displays, a check mark icon, a page layout icon, two pen icons, and a paper icon as shown in the figure.

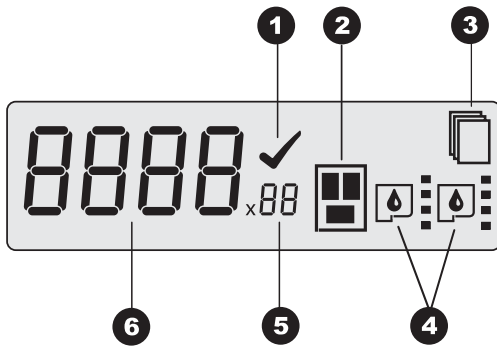

1	<b>Check mark icon:</b> Indicates that the photo has been selected for printing.
2	<b>Page layout icon:</b> Indicates the page layout selected.
3	<b>Paper icon:</b> Flashes when the printer is out of paper or there is a paper jam.
4	<b>Pen icons:</b> Represent the cartridges in each chute. The icons appear when the cartridges are installed. The bars next to each pen icon indicate the approximate ink levels in each cartridge.
5	<b>Copies icon:</b> Indicates the number of copies to be printed. No icon is present when only one copy is to be printed.
6	<b>Image number icon:</b> Indicates the number of the image on the memory card. It also indicates the presence of Digital Print Order Format (DPOF).



# 2 Get ready to print

This section includes the following topics:

- Loading paper
- Using print cartridges

## Load paper

For better quality, choose the right paper and load it correctly in the main tray or photo tray.



**Tip** Load only one type and size of paper at a time. Do not mix paper types or sizes in the main tray or the photo tray.

## Choose the right paper

For a list of available HP paper, or to purchase supplies, go to:

- [www.hpshopping.com](http://www.hpshopping.com) (U.S.)
- [www.hp.com/go/supplies](http://www.hp.com/go/supplies) (Europe)
- [www.hp.com/jp/supply\\_inkjet](http://www.hp.com/jp/supply_inkjet) (Japan)
- [www.hp.com/paper](http://www.hp.com/paper) (Asia/Pacific)

To get the best results from the printer, choose from these high-quality HP photo papers.

To print	Use this paper
High-quality, long-lasting prints and enlargements	HP Premium Plus photo paper (Also known as Colorfast photo paper in some countries/regions.)
Medium- to high-resolution images from scanners and digital cameras	HP Premium photo paper
Instant dry, water and fingerprint-resistant glossy photos	HP Advanced photo paper
Casual and business photos	HP Photo paper HP Everyday photo paper
Text documents, draft versions, test and alignment pages	HP Multipurpose paper

To keep your paper in good condition for printing:

- Store unused paper in its original packaging or in a plastic bag.
- Keep the paper flat in a cool, dry place. If the corners curl, place the paper in a plastic bag and gently bend it in the opposite direction until it lies flat.
- Hold photo paper by the edges to avoid smears.

## Print from the control panel or a computer

When printing from a computer, the printer supports paper sizes from 7.6 x 12.7 cm to 22 x 61 cm (3 x 5 inch to 8.5 x 14 inch). When printing from the control panel directly,

the paper sizes supported include A6, A4, 10 x 15 cm (4 x 6 inch) with or without a tab, 8.5 x 11 inch, Hagaki, and L-size.

## Load the main tray

The main tray supports the following media:

- Letter or A4 paper
- Transparencies
- 20 x 25 cm (8 x 10 inch) photo paper
- Envelopes 28.0 cm (11 inches) wide and greater
- 7.62 x 13 cm (3 x 5 inch) photo paper
- A6 paper
- L-size cards
- 13 x 18 cm (5 x 7 inch) photo paper
- 2L-size paper
- 10 x 20 cm (4 x 8 inch) photo cards
- B5 paper
- Envelopes smaller than 28.0 cm (11 inches) wide

Follow the steps to load your main tray:

1. Raise the photo tray.
2. Remove any paper that is loaded in the main tray.
3. Slide the paper-width guide to the left until it stops.

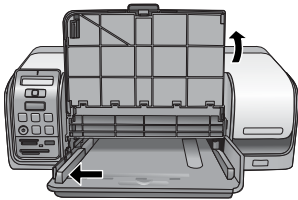

4. Load the paper in the main tray with the **side to be printed facing down**. Slide the paper in until it stops.  
Load envelopes with the flap on the left. Tuck the flaps inside the envelopes to avoid paper jams.



**Note** Align the paper to the right edge of the tray.

5. Slide the paper-width guide to fit close to the edges of the paper without bending the paper.

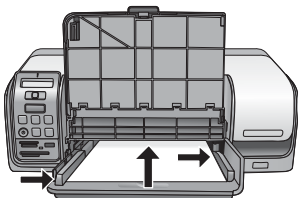

6. Lower the photo tray.

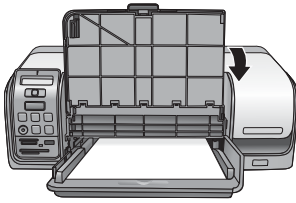

## Load the photo tray

The photo tray supports the following media:

- 10 x 15 cm (4 x 6 inch) photo paper (with or without tab)
- 13 x 18 cm (5 x 7 inch) photo paper
- Index cards
- Hagaki cards

Follow the steps to load the photo tray:

1. Press the output tray latch from below and lift upwards to separate the output tray from the photo tray.

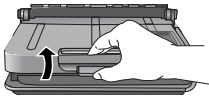

2. Raise the output tray.

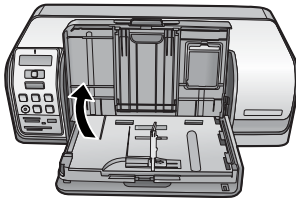

3. Remove any paper that is loaded in the photo tray.
4. Slide the paper-width guide to the left until it stops.
5. Load up to 20 sheets of photo paper into the photo tray with the **side to be printed facing down**. Slide the paper in until it stops.

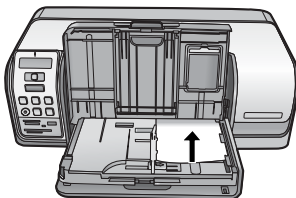

**Note** Align the paper to the right edge of the tray.

6. Slide the paper-width guide to fit close to the edges of the paper without bending the paper.

7. Lower the output tray to its original position. The output tray latch clicks when the output tray is lowered completely.
8. Press the Photo Tray button on the control panel.

## Using print cartridges

Your HP Photosmart D5100 series printer can print color and black-and-white photos. HP provides different types of print cartridges so you can choose the best cartridges for your project.

### Purchasing replacement print cartridges

When purchasing replacement cartridges, refer to the cartridge numbers that appear on the back cover of this guide. These cartridge numbers may vary by country/region. You can also find the cartridge numbers in the printer software.

#### To find the correct print cartridge numbers for Windows users

1. Right-click the HP Digital Imaging Monitor icon on the far right of the Windows® taskbar and select **Launch/Show HP Solution Center**.
2. Select **Settings**, and then select **Print Settings > Printer Toolbox**.
3. Select the **Estimated Ink Levels** tab, and then click **Print Cartridge Information**.

#### To find the correct print cartridge numbers for Mac users

1. Click **HP Photosmart Studio** in the Dock.
2. Click **Devices** in the Studio toolbar.
3. From the **Information and Settings** pop-up menu, choose **Maintain Printer** and then click **Launch Utility**.
4. In the **Configuration Settings** list, click **Supply Info**.

### Print cartridge tips

HP Vivera Inks deliver true-to-life photo quality and exceptional fade resistance resulting in vivid colors that last for generations! HP Vivera Inks are specially-formulated and scientifically tested for quality, purity, and fade resistance.

For best print quality, HP recommends that you install all retail print cartridges before the install-by date stamped on the box.

For optimal printing results, HP recommends using only genuine HP print cartridges. Genuine HP print cartridges are designed and tested with HP printers to help you easily produce great results, time after time.



**Note** HP cannot guarantee the quality or reliability of non-HP ink. Printer service or repairs required as a result of printer failure or damage attributable to the use of non-HP ink will not be covered under warranty.



**Caution** To prevent ink loss or spillage: leave the print cartridges installed while transporting the printer, and avoid leaving used print cartridge(s) out of the printer for extended lengths of time.

## Inserting and replacing the print cartridges

### To prepare the printer and cartridges

1. Make sure the power is on.
2. Raise the main cover of the printer.
3. Remove the pink tape from the cartridges.

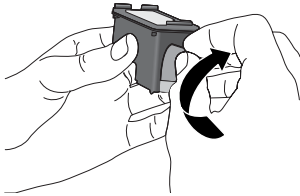

**Note** Do not touch the ink nozzles or the copper-colored contacts, and do not re-tape the cartridges.



### To insert the cartridges

1. If you are replacing an HP Black, HP Photo, or HP Gray Photo cartridge, push down and pull outward on the cartridge in the **right** stall to remove it.
2. Hold the new cartridge with the label on top. Slide the cartridge at a slight upward angle into the **right** stall so the copper-colored contacts go in first. Gently push the cartridge until it snaps into place.



**Caution** To avoid print carriage jams, make sure the print cartridge snaps securely into place as you insert it.

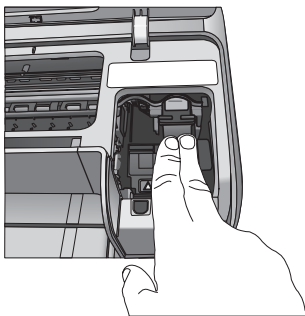

3. Repeat the previous steps to install the HP Tri-color cartridge in the **left** stall.
4. Lower the main cover.

### Aligning the print cartridges for maximum results

It is important to align the print cartridges whenever you install or replace a print cartridge. Aligning the print cartridges allows them to perform with maximum results in print speed



and quality. The HP Photosmart D5100 series printer automatically aligns the print cartridges every time you insert or replace a print cartridge.



**Note** When you insert or replace a print cartridge, the printer makes noise for a few seconds. This is normal. The printer is aligning the cartridges.

# 3 Print without a computer

The HP Photosmart D5100 series lets you print high-quality photos without even turning on a computer. After setting up the printer using the instructions in the HP Photosmart D5100 series Quick Start booklet, refer to these steps for start-to-finish printing.

Once you have set up the printer, you can print from any of the following:

- Memory card
- PictBridge-compatible digital camera
- Bluetooth device
- iPod (with photos stored in it)

## Getting connected

This printer offers several ways of connecting to computers or other devices. Each connection type lets you do different things.

Connection type and what you need	This lets you...
<b>Memory cards</b> A compatible digital camera memory card. Insert the memory card into the appropriate memory card slot on the front of the printer.	<ul style="list-style-type: none"><li>• Print directly from a memory card to the printer. See <a href="#">Print from a memory card</a>.</li><li>• Print a photo index of photos on a memory card directly from the printer control panel.</li></ul>
<b>PictBridge</b> A PictBridge-compatible digital camera and a USB cable. Connect the camera to the camera port on the <b>front</b> of the printer.	Print directly from a PictBridge-compatible digital camera to the printer. For more information, see <a href="#">Printing photos from a digital camera</a> and the camera documentation.
<b>Bluetooth</b> An optional HP Bluetooth wireless printer adapter. Connect the HP Bluetooth wireless printer adapter to the camera port on the front of the printer.	Print from any device with Bluetooth wireless technology to the printer.
<b>iPod</b> An iPod and the USB cable that came with it. Connect the iPod to the camera port on the front of the printer.	Print directly from an iPod (with photos stored in it) to the printer. For more information, see <a href="#">Print photos from an iPod</a> .

## Print from a memory card

You can print photos from a memory card by inserting the card into the printer and using the printer control panel to select and print photos. You can also print camera-selected

photos—photos you marked for printing using a digital camera—directly from a memory card.

Printing from a memory card is quick and easy, and does not drain the digital camera batteries. For more information on inserting memory cards, see [Insert a memory card](#).

## Insert a memory card

After you have taken pictures with a digital camera, you can remove the memory card from the camera and insert it into the printer to select and print your photos. The printer can read the following types of memory cards: CompactFlash, Memory Stick, Microdrive, MultiMediaCard, Secure Digital, and xD-Picture Card.

 **Caution** Using any other type of memory card may damage the memory card and the printer.

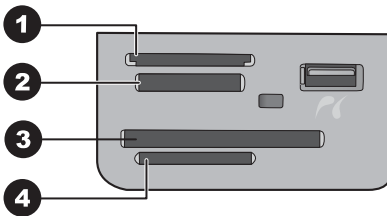

### Memory card slots

1	xD-Picture Card
2	Memory Stick
3	CompactFlash I and II, Microdrive
4	Secure Digital (SD), MultiMediaCard (MMC)

### Memory card types







Find your memory card in the following table and use the instructions to insert the card into the printer.

Guidelines:

- Insert only one memory card at a time.
- Gently push the memory card into the printer until it stops. The memory card slot allows for only a portion of the card to insert into the printer; do not try to force the memory card all the way into the printer.
- When the memory card is inserted correctly, the memory card light flashes and then remains solid green.

 **Caution 1** Inserting the memory card any other way may damage the card and the printer.

**Caution 2** Do not pull out a memory card while the memory card light is flashing green. For more information, see [Remove a memory card](#).

Memory card	How to insert the memory card
<b>CompactFlash</b> 	<ul style="list-style-type: none"> <li>• Front label faces up, and if the label has an arrow, the arrow points toward the printer</li> <li>• Edge with metal pinholes goes into the printer first</li> </ul>
<b>Memory Stick</b> 	<ul style="list-style-type: none"> <li>• Angled corner is on the left</li> <li>• Metal contacts face down</li> <li>• If you are using a Memory Stick Duo or Memory Stick PRO Duo card, attach the adapter that came with the card before you insert the card into the printer</li> </ul>
<b>Microdrive</b> 	<ul style="list-style-type: none"> <li>• Front label faces up, and if the label has an arrow, the arrow points toward the printer</li> <li>• Edge with metal pinholes goes into the printer first</li> </ul>
<b>MultiMediaCard</b> 	<ul style="list-style-type: none"> <li>• Angled corner is on the right</li> <li>• Metal contacts face down</li> </ul>
<b>Secure Digital</b> 	<ul style="list-style-type: none"> <li>• Angled corner is on the right</li> <li>• Metal contacts face down</li> </ul>
<b>xD-Picture Card</b> 	<ul style="list-style-type: none"> <li>• Curved side of card points toward you</li> <li>• Metal contacts face down</li> </ul>

### Supported file formats

The printer can recognize and print JPEG and uncompressed TIFF files directly from the memory card. If your digital camera saves photos in other file formats, save the files to your computer and print them using a software application. For more information, see the onscreen HP Photosmart Printer Help.

### Change the default paper size

Use the **Toolbox** to change the default paper sizes when printing directly from a memory card. The default small paper size for printing from the photo tray is 10 x 15 cm (4 x 6 inch), and the default large paper size for printing is 21.6 x 28.0 cm (8.5 x 11 inch).

### To change default paper sizes

1. Right-click the HP Digital Imaging Monitor icon on the far right of the Windows taskbar and select **Launch/Show HP Solution Center**.
2. Click **Settings** and select **Print Settings > Printer Toolbox**.
3. Click the **Configure Paper Size** tab.
4. Select the default paper sizes for small paper and large paper.

### Decide which photos to print

Decide which photos to print by first printing a photo index. A photo index shows thumbnail views and index numbers for all the photos on a memory card (2000 maximum). You will use the index numbers on the printout to indicate which photos you want to print.

### To print a photo index

1. Insert a memory card.
2. Make sure there are a few sheets of plain paper loaded in the main tray.
3. Press **Photo Index** on the control panel.

### Select a photo layout

Press **Layout** on the printer to select a layout for the photos you want to print. All photos selected from the printer control panel will print in this layout. The actual size of the prints will vary according to the size of paper you load in the printer, as shown in the following table. For a complete list of supported photo sizes, see [Printer specifications](#).

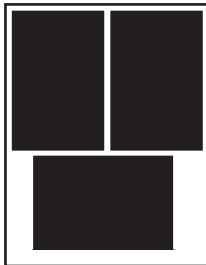
For this layout	Paper size	Photo size
<b>One photo per sheet</b> 	4 x 6 inch 10 x 15 cm 5 x 7 inch 8.5 x 11 inch A4 Hagaki L	4 x 6 inch 10 x 15 cm 5 x 7 inch 8.5 x 11 inch 21.0 x 29.7 cm 10.0 x 14.8 cm 9.0 x 12.7 cm
<b>Three photos per sheet</b> 	3.5 x 5 inch 4 x 6 inch 5 x 7 inch 8 x 10 inch 8.5 x 11 inch A6 A4 Hagaki L	1.5 x 2.25 inch 1.75 x 2.625 inch 2.25 x 3.375 inch 3.33 x 5 inch 4 x 6 inch 4.77 x 7.15 cm 10 x 15 cm 4.52 x 6.78 cm 3.96 x 5.94 cm

## Select photos to print

Using the photo index as a guide, you can select and print photos from the control panel.



**Note** Once your selected photos print, the printer automatically deselects them.

If you want to...	Do this
<b>Select one or more photos</b>	<ol style="list-style-type: none"><li>1. Make sure your memory card is inserted in the printer.  <b>Note</b> Instead of inserting a memory card, you can also select photos from an iPod that is connected to the front camera port. For more information, see <a href="#">Print photos from an iPod</a>.</li><li>2. Refer to the photo index you printed and decide which photo(s) to select for printing. Note their corresponding index numbers.</li><li>3. Press <b>Select Photos</b> ◀ or ▶ until the index number of the first photo you want to print appears on the printer screen.  <b>Tip</b> Press and hold the button to view the index numbers rapidly.</li><li>4. Press <b>OK</b> to select the photo for printing. A check mark appears next to the number on the printer screen to indicate your selection.</li><li>5. Repeat steps 2 through 4 until you have selected all the photos you want to print.  <b>Note</b> To deselect a photo, press <b>Cancel</b>. To print multiple copies of the same photo, press <b>OK</b> until the number of copies you want to print appears below the check mark.</li></ol>
<b>Select all photos on the memory card</b>	<ol style="list-style-type: none"><li>1. Make sure your memory card is inserted in the printer.</li><li>2. Press and hold <b>OK</b> for three seconds. The printer screen briefly displays twelve dashes, and then check marks appear next to each index number on the screen.</li></ol>
<b>Deselect the selected photos</b>	To deselect all selected photos, press and hold <b>OK</b> for three seconds.

## Print your photos

### To print photos from a memory card

1. Insert a memory card.
2. Load photo paper in the main tray or photo tray.



**Note** To print from the photo tray, press the Photo Tray button on the control panel. The printer selects the photo tray for the next standalone print job.

3. Select one or more photos. For information on selecting photos, see [Select photos to print](#).
4. Press **Print**.

Once the selected photos print, the printer automatically deselects them.



**Note** Some digital cameras have a menu feature that allows you to select photos on a memory card to be printed. The camera-selected photos are listed for printing in a temporary Digital Print Order Format (DPOF) file. The DPOF file is automatically deleted after the selected photos have printed.

If you have selected photos using the DPOF feature, **dPOF** appears on the printer screen when you insert the memory card. Press **Print** to print these camera-selected photos, or press **Cancel** to deselect them.

## Remove a memory card

Wait until the Memory Card light stops flashing and remains solid green, and then gently pull the memory card to remove it from the printer.



**Caution** If the Memory Card light is flashing green, the printer is accessing the memory card. Do not remove a memory card while it is being accessed because this may damage the printer or the memory card.

## Printing photos from a digital camera

You can print photos by connecting a PictBridge digital camera directly to the camera port of the printer with a USB cable. If you have a digital camera with Bluetooth wireless technology, you can insert the optional HP Bluetooth® wireless printer adapter in the printer and send photos to the printer wirelessly.

When you print from a digital camera, the printer uses the settings that you selected on the camera. For more information, see the documentation that came with the camera.

## Using a PictBridge camera

The HP Photosmart D5100 series printer prints from a PictBridge camera by directly connecting the camera to the front USB port of the printer.



**Note** Some PictBridge cameras might list the 5 x 7 inch paper size as 2L, 127 x 178 mm, or 13 x 18 cm.

### To connect a PictBridge-compatible camera to the printer

1. Set the camera to PictBridge mode, and then select the photos you want to print.
2. Load photo paper in the printer. For information, see [Load paper](#).
3. Connect the PictBridge-compatible digital camera to the camera port on the **front** of the printer using the USB cable that came with the camera. Once the printer recognizes the PictBridge-compatible camera, the selected photos print automatically.

## Using a Bluetooth camera

If you have a digital camera with Bluetooth wireless technology, you can purchase the optional HP Bluetooth wireless printer adapter and print from a camera using a Bluetooth wireless connection.

### To print photos from a Bluetooth camera

1. Load photo paper in the printer. For information, see [Load paper](#).
2. Insert the HP Bluetooth wireless printer adapter into the camera port on the **front** of the printer.  
The light on the adapter will flash when the adapter is ready to receive data.
3. Follow the instructions in the documentation that came with the digital camera to send photos to the printer.

## Print photos from other Bluetooth devices

You can also print from other devices with Bluetooth wireless technology, such as PDAs, notebook computers, and mobile phones. For more information, see [Getting connected](#), the onscreen HP Photosmart Printer Help, and the documentation that came with the Bluetooth device.

### Make the Bluetooth connection

To use Bluetooth connectivity, all devices must have the necessary hardware and software installed. In addition, an HP Bluetooth wireless printer adapter must be connected to the camera port on the front of the printer. The adapter is available separately. For more information, see the documentation that came with the adapter.

### Print photos from a Bluetooth device

The basic procedure for printing from any Bluetooth device is the same:

#### To print photos from a Bluetooth device

1. Have the device search for available Bluetooth printers.
2. Select the printer when it appears on the device.
3. Print.

Check the documentation that came with the device for detailed instructions.

## Print photos from an iPod

Before using the steps below to import photos to and print photos from your iPod, make sure your images and your iPod meet the following requirements:

- The images you copy to the iPod must be in JPEG format.
- Make sure the iPod is formatted for Windows (FAT 32 file structure).  
iPod defaults to the Windows file structure. To check if your iPod was formatted for Windows, go to **Settings > About** on your iPod. If it was formatted in Windows, it will display **Format Windows** at the bottom of the screen. If it was not formatted in Windows, you must connect the iPod to a Windows PC using the USB cable that came with the iPod and follow the onscreen instructions.





**Note** iPods that have only been connected to a Macintosh are not compatible with the printer; however, you can connect the iPod to a Windows PC to make it compatible. After connecting to a Windows PC, Macintosh users can still fully synchronize their iPods back to Macintosh and Mac iTunes and maintain printer support.

**To import photos to an iPod**

1. Copy photos from a memory card to your iPod using the Belkin Media Reader for iPod.
2. Verify that photos are on your iPod by selecting **Photo Import** on the iPod menu. Photos appear as **Rolls**.

**To print photos from an iPod**

1. Connect the iPod to the camera port on the **front** of the printer using the USB cable that came with the iPod.
2. Select the photo(s) you want to print and press **Print**. Once the selected photos print, the printer automatically deselects them. For more information on selecting and printing photos, see [Select photos to print](#).

If you are unable to print to the HP Photosmart using your iPod, please contact HP Customer Care. See [HP Support](#).

# 4 Print from a computer

To print from a computer, the printer software must be installed. During software installation, either HP Photosmart Premier (Windows Full-install users), HP Photosmart Essential (Windows Express-install users) or the HP Photosmart Studio (Mac) is installed on your computer, allowing you to organize, share, edit, and print photos.

For more information on installing the software, see the *Quick Start Guide*. Update the software regularly to ensure you have the latest features and improvements; for instructions, see [Updating the software](#).



**Note** Windows users: HP Photosmart Premier can only be used on computers with processors that have Intel® Pentium® III (or equivalent) and higher.

## Use creative options in the printer software

Read through these tips on how to open and use HP Photosmart Premier (Windows), HP Photosmart Essential (Windows), HP Photosmart Studio (Mac), and HP Photosmart Share.

### HP Photosmart Premier (Windows)

HP Photosmart Premier is an easy-to-use software program that gives you everything you need to have fun with your photos, in addition to basic photo editing and printing. This software also gives you access to HP Photosmart Share so that you can easily share your photos. HP Photosmart Premier is only available to Windows users.

#### Open HP Photosmart Premier (Windows users)

→ Double-click the **HP Photosmart Premier** icon on your desktop. If you need help, see the software help within HP Photosmart Premier.

Explore the many features of HP Photosmart Premier:

- **View** — View photos in multiple sizes and ways. Easily organize and manage your photos.
- **Edit** — Crop your photos and fix photos with red eye. Automatically adjust and enhance your photos in different sizes and in multiple layouts.
- **Print** — Print your photos in different sizes and in multiple layouts.
- **Share** — Send photos to family and friends without the bulky attachments using HP Photosmart Share, a better way to send e-mail.
- **Create** — Easily create album pages, cards, calendars, panoramic photos, CD labels, and more.
- **Back-up** — Make back-up copies of your photos to store and save.

### HP Photosmart Essential (Windows)

HP Photosmart Essential is an easy-to-use software program that gives you basic photo editing and printing capabilities. This software also gives you access to HP Photosmart Share so that you can easily share your photos. HP Photosmart Essential is only available for Windows users.

### Open HP Photosmart Essential (Windows users)

- Double-click the **HP Photosmart Essential** icon on your desktop. If you need help, see the software help within HP Photosmart Essential.

Explore the many features of HP Photosmart Essential:

- **View** — View photos in multiple sizes and ways. Easily organize and manage your photos.
- **Edit** — Crop your photos and fix photos with red eye. Automatically adjust and enhance your photos to make them perfect.
- **Print** — Print your photos in different sizes and in multiple layouts.
- **Share** — Send photos to family and friends without the bulky attachments with HP Photosmart Share, a better way to send e-mail.

### HP Photosmart Studio (Mac)

- Click the **HP Photosmart Studio** icon in the Dock.

Explore the many features of the HP Photosmart Mac software that is accessible from the HP Photosmart Studio:

- **Import** — Import photos or videos from an HP digital camera.
- **View and Manage** — View, organize, and manage your photos and videos.
- **Edit** — Adjust and enhance your images.
- **Slideshow** — Create an online slideshow of your photos.
- **Panorama** — Create a single panoramic image from several images.
- **Create** — Create album pages, cards, labels, posters, banners, and more.
- **Print** — Print your photos and frames from video in standard sizes or in index sheet format.
- **Share** — Send photos to family and friends without the bulky attachments.
- **Shop** — Order online prints and gifts.

### HP Photosmart Share

HP Photosmart Share allows you to send photos to family and friends without bulky e-mail attachments. The printer must be connected through a USB cable to a computer with Internet access and have all the HP software installed. For more information, see the HP Photosmart Premier, HP Photosmart Essential, or HP Photosmart Mac help.

#### Open HP Photosmart Share (Windows users)

- Click the **HP Photosmart Share** tab within HP Photosmart Premier or HP Photosmart Essential.

#### Open HP Photosmart Share (Mac users)

- In HP Photosmart Studio, select photos to share, and then click the **Share** button in the toolbar.

## View photos on your computer screen

When the printer is connected to a computer, you can insert a memory card in the printer and view the photos on your computer screen. When you insert the memory card, the HP Photosmart software gives you the option of viewing or saving the photos to the computer. For information about how to connect the printer to your computer, see the *Quick Start* booklet.

### **To view memory card photos onscreen**

1. Make sure that you have installed the software from the HP Photosmart D5100 series CD, and that the printer is connected to a computer at the USB port on the back of the printer.
2. Insert a memory card into the printer. The HP Photosmart software will give you the option of viewing or saving your photos.
3. Click **View** to open Photo Viewer and display the first image on the memory card.
4. On the printer control panel, press **Select Photos** ◀ and ▶ to scroll through the photos on the card.

## **Save your photos to a computer**

When you connect the printer to a computer, you can save your photos from a memory card to the computer.

### **To save your photos from a memory card to a computer**

1. Make sure that you have installed the software from the HP Photosmart D5100 series CD, and that the printer is connected to a computer at the USB port on the back of the printer.
2. Insert a memory card into the printer. The HP Photosmart software will give you the option of viewing or saving your photos.
3. Click **Save**.
4. Follow the onscreen instructions to save photos to the appropriate folder on your computer.



# 5 Print on CDs and DVDs

In addition to printing on paper, your HP Photosmart D5100 series printer also allows you to print on CDs and DVDs. You can design and create a custom label for your CD or DVD using the HP Photosmart Premier Software on a Windows computer or the HP Photosmart Studio on a Mac. You can then print the label on your printable CD or DVD media.



**Tip** It is recommended that you write your data to the CD or DVD before printing the label on it.

## Create and print CD/DVD labels

Read through these tips on how to open and use the HP Photosmart Premier Software and the HP Photosmart Studio.

### HP Photosmart Premier

HP Photosmart Premier is an easy-to-use software that provides you with all the tools you need to have fun with your photos. This software also helps you to design and create labels for your CDs and DVDs.

#### Opening HP Photosmart Premier

→ Double-click the **HP Photosmart Premier** icon on your desktop. If you need help, see the HP Photosmart Software Help.

### HP Photosmart Studio

HP Photosmart Studio is an easy-to-use software that provides you with all the tools you need to have fun with your photos on a Mac. This software also helps you to design and create labels for your CDs and DVDs.

#### Opening HP Photosmart Studio

→ In the Dock, click the HP Photosmart Studio icon.

### Using HP Photosmart Premier

After opening the software, you can design and create labels for your CDs and DVDs under the Create tab. After creating your label, click **Print** on the Create page to print the label on your media. If you need help, see the onscreen Help within the software.



**Tip** Before you click **Print** in the software, load the media in the CD/DVD tray. If you need help, see [Load the CD/DVD tray](#).

## Prepare your printer to print on CDs and DVDs

After creating your CD/DVD label, load the CD/DVD tray with a printable media.

 **Caution** Before you load the media on the CD/DVD tray, ensure that your printer has approximately 10 cm (4 inches) clearance behind it.

### Load the CD/DVD holder

→ Securely snap the media on the CD/DVD holder that came with your printer. Ensure that the printable surface is facing up.

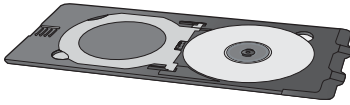

**Note** If you are using a smaller-sized media, flip over the CD/DVD holder ring as shown in figure 1.

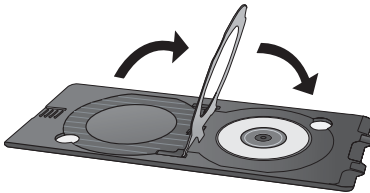

### Load the CD/DVD tray

1. Pull down the CD/DVD tray.

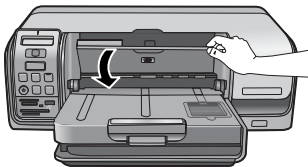

2. Insert the CD/DVD holder into the CD/DVD tray until the arrows on the tray line up to the arrows on the holder. The side marked with arrows goes into the CD/DVD tray.

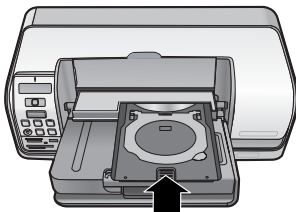

3. Click **Print** in the software.

The printer pulls the CD/DVD holder while printing on the media. The CD/DVD holder might protrude about 7.5 cm (3 inches) at the back of the printer.

## Finish the print job

After successfully printing on the media, follow the steps below.

### Remove the CD/DVD holder

1. Carefully remove the CD/DVD holder from the CD/DVD tray.
2. Close the CD/DVD tray.



**Note** Other printing jobs are implemented only after the CD/DVD tray is closed.

3. Remove the media from the CD/DVD holder.



**Tip** Allow sufficient time for the printed surface to dry before removing the media from the CD/DVD holder.



**Caution** Do not touch the printed surface while removing the media from the CD/DVD holder.





# 6 Care and maintenance

The HP Photosmart D5100 series printer requires very little maintenance. Follow the guidelines in this chapter to extend the life span of the printer and printing supplies, and to ensure that the photos you print are always of the highest quality.

## Cleaning and maintaining the printer

Keep the printer and print cartridges clean and well-maintained using the simple procedures in this section.

### Cleaning the exterior of the printer

#### To clean the exterior of the printer

1. Turn off the printer, and then disconnect the power cord from the back of the printer.
2. Wipe the outside of the printer with a soft cloth that has been lightly moistened with water.
3. Raise the main cover and wipe the area around the print cartridges with a soft cloth that has been lightly moistened with water.



**Caution** Do not use any type of cleaning solution. Household cleaners and detergents may damage the printer finish. Do not clean the interior of the printer. Keep all fluids away from the interior. Do not lubricate the metal rod on which the print cartridge cradle slides. Noise is normal when the cradle moves back and forth.

### Cleaning the print cartridges

If you notice white lines or single-color streaks on the photos you print, the print cartridges might need to be cleaned. You can run an automatic cartridge cleaning procedure using the software that came with the printer. For more information, see the HP Photosmart Printer Help.

If you complete all three levels of the automatic cartridge cleaning procedure and still see white streaks or missing colors on the test page, you may need to manually clean the print cartridge contacts. For more information, see [Manually cleaning the print cartridge contacts](#).



**Note** If the cartridge or printer has been recently dropped, you may also see white streaks or missing colors in your prints. This problem is temporary and clears up within 24 hours.

### Manually cleaning the print cartridge contacts

If the printer is used in a dusty environment, debris may accumulate on the print cartridge contacts and cause printing problems.

### To clean the print cartridge contacts

1. Gather the following items to clean the contacts:
  - Distilled water (tap water may contain contaminants that can damage the print cartridge)
  - Cotton swabs or other soft, lint-free material that will not stick to the print cartridge
2. Open the main cover of the printer.
3. Remove the print cartridge and place it on a piece of paper with the ink nozzle plate facing up. Be careful not to touch the copper-colored contacts or the ink nozzle plate with your fingers.



**Caution** Do not leave the print cartridge outside the printer for more than 30 minutes. Ink nozzles exposed to the air longer than this may dry out and cause printing problems.

4. Lightly moisten a cotton swab with distilled water and squeeze any excess water from the swab.
5. Gently wipe the copper-colored contacts with the cotton swab.



**Caution** Do not touch the ink nozzle plate. Touching the ink nozzle plate will result in clogs, ink failure, and bad electrical connections.

6. Repeat steps 4 and 5 until no ink residue or dust appears on a clean swab.
7. Insert the print cartridges in the printer, and then close the main cover.
8. The printer automatically aligns the print cartridges. The printer makes noise while aligning the printer. This is normal.

## Updating the software

Download the latest printer software update periodically to ensure you have the latest features and improvements. To download printer software updates, visit [www.hp.com/support](http://www.hp.com/support) or use **HP Software Update**. Make sure the computer is connected to the Internet before performing software updates.



**Note** In some countries/regions, you can contact HP directly to order HP Photosmart Premier software updates on CD.

### Downloading the software (Windows users)

1. From the Windows **Start** menu, select **Programs** (in Windows XP, select **All Programs**) > **HP** > **HP Software Update**. The **HP Software Update** window opens.
2. Click **Next**. HP Software Update searches the HP website for printer software updates. If the computer does not have the most recent version of the printer software installed, a software update appears in the **HP Software Update** window. If the computer has the most recent version of the printer software installed, **No new updates are available** appears in the **HP Software Update** window.
3. If a software update is available, click the check box next to the software update to select it.
4. Click **Next**.
5. Follow the onscreen instructions to complete the installation.

## Downloading the software (Mac)



**Note** Make sure you are connected to the Internet before you use HP Photosmart Updater.

1. From the Finder, choose **Go > Applications**.
2. Choose **Hewlett-Packard > Photosmart > HP Photosmart Updater**.
3. Follow the onscreen instructions to check for software updates.  
If you are behind a firewall, you need to enter the proxy server information in the updater.

## Storing the printer and print cartridges

Protect the printer and print cartridges by storing them properly when you are not using them.

### Storing the printer

You can store the printer by following these steps:

1. Turn off the printer.
2. Remove all paper from the paper trays.
3. If the output tray extension is pulled out, push it in.
4. Close the CD/DVD tray.

The printer is designed to withstand long or short periods of inactivity.

- Store the printer indoors out of direct sunlight in a place without temperature extremes.
- If the printer and print cartridges have not been used for one month or more, use the software that came with the printer to run the automatic cartridge cleaning procedure before printing. For more information, see the HP Photosmart Printer Help.

### Storing the print cartridges

When you store the printer, always leave the active print cartridges inside the printer. The printer stores the print cartridges in a protective cap during the power-down cycle.



**Caution** Make sure the printer completes its power-down cycle before you unplug the power cord. This allows the printer to store the print cartridges properly.

Follow these tips to help maintain HP print cartridges and ensure consistent print quality:

- Keep all unused print cartridges in their original sealed packages until they are needed. Store print cartridges at room temperature (15–35 degrees C or 59–95 degrees F).
- Do not remove the plastic tape covering the ink nozzles until you are ready to install the print cartridge in the printer. If the plastic tape has been removed from the print cartridge, do not attempt to reattach it. Reattaching the tape damages the print cartridge.

## Maintaining the quality of photo paper

For best results with photo paper, follow the guidelines in this section.

### **Storing photo paper**

- Store the photo paper in its original packaging or in a resealable plastic bag.
- Store the packaged photo paper on a flat, cool, and dry surface.
- Return unused photo paper to its original packaging or in a resealable plastic bag. Paper left in the printer or exposed to the environment may curl or yellow.

### **Handling photo paper**

- Always hold photo paper by the edges to avoid fingerprints.
- If the photo paper has curled edges, place it in its plastic storage bag and gently bend it in the opposite direction of the curl until the paper lies flat.

# 7 Troubleshooting

The HP Photosmart D5100 series printer is designed to be reliable and easy to use. This chapter answers frequently asked questions about using the printer. It contains information about the following topics:

- [Printer hardware problems](#)
- [Printing problems](#)
- [CD/DVD printing problems](#)
- [Bluetooth printing problems](#)
- [Printer screen status indicators](#)

For troubleshooting information about software installation, see the *Quick Start* booklet that came with the printer. For troubleshooting information about using the printer software and printing from a computer, see the HP Photosmart Printer Help. For information about viewing the Printer Help, see [Welcome](#).

## Printer hardware problems

Before contacting HP Customer Care, read this section for troubleshooting tips or go to the online support services at [www.hp.com/support](http://www.hp.com/support).



**Note** When connecting the printer to a computer, HP recommends using a USB cable of less than 10 feet (3 meters) in length to minimize injected noise due to potential high electromagnetic fields.

### The Print light is pulsing green, but the printer is not printing.

**Solution** The printer is busy processing information. Wait for it to finish.

---

### The Attention light is flashing red.

**Solution** The printer requires attention. Try the following:

- If the printer is connected to a computer, check the computer screen for instructions.
- If you are printing a CD label on a CD/DVD, insert the CD/DVD holder in the CD/DVD tray now.
- If you have a digital camera connected to the printer, check the camera screen for instructions.
- If the printer is not connected to a computer, check for the following problems:
  - Main cover open
  - Out of paper
  - Paper jam
  - Print carriage jammed or stuck
  - Print cartridge missing or inserted incorrectly
  - Print cartridge tape not removed

- Incorrect print cartridge installed
  - Packaging materials are not removed
  - If you are unable to solve the problem by using the instructions above, turn off the printer and unplug the printer power cord. Wait 10 seconds, and then plug it in again. Turn on the printer.
- 

**The printer does not find and display the index numbers from my memory card.**

**Solution**

Try the following:

- Remove and reinsert the memory card.
  - Turn off the printer, and then unplug the power cord. Wait about 10 seconds, and then plug it in again. Turn on the printer.
  - The memory card may contain file types the printer cannot read directly from the memory card.
    - Save the photos to a computer, and then print them from the computer. For more information, see the documentation that came with the camera and the onscreen HP Photosmart Printer Help.
    - The next time you take photos, set the digital camera to save them in a file format the printer can read directly from the memory card. For a list of supported file formats, see [Specifications](#). For instructions on setting the digital camera to save photos in specific file formats, see the documentation that came with the camera.
- 

**The printer is plugged in, but it will not turn on.**

**Solution**

- The printer may have drawn too much power. Unplug the printer power cord. Wait about 10 seconds, and then plug the power cord back in. Turn on the printer.
  - The printer may be plugged into a power strip that is turned off. Turn on the power strip, and then turn on the printer.
- 

**The printer makes noises when I turn it on, or starts making noises on its own after it has been sitting unused for a while.**

**Solution** The printer may make noises after long periods of inactivity (approximately 2 weeks), or when its power supply has been interrupted and then restored. This is normal operation—the printer is performing an automatic maintenance procedure to ensure that it produces the best quality output.

---

## Printing problems

Before contacting HP Customer Care, read this section for troubleshooting tips or go to the online support services at [www.hp.com/support](http://www.hp.com/support).

### **The printer does not print borderless photos.**

**Solution** Make sure you have selected an appropriate paper size. The printer cannot print borderless photos on all sizes of paper. For information about selecting the paper size for borderless photos, see [Select a photo layout](#).

---

### **Printing is very slow.**

**Solution** You could have one of the following problems.

- You may be printing a project containing a high-resolution graphic, a high-resolution photo, or a PDF. Large, complex projects containing graphics or photos print slower than text documents.
  - The printer may be in Ink-backup Printing Mode. The printer enters this mode when one of the print cartridges has been removed. Replace the missing print cartridge.
- 

### **Photo paper does not feed into or come out of the printer correctly.**

**Solution** You may have one of these problems.

- If you are using the photo tray for printing, there may be paper loaded in the main tray. Remove any paper from the main tray before using the photo tray for printing.
  - Ensure that the CD/DVD tray is closed. The printer does not load paper until the CD/DVD tray is closed.
  - The printer may be in an extremely high- or low- humidity environment. Load one sheet of photo paper at a time.
  - The photo paper may be curled. If the photo paper is curled, place the paper in a plastic bag and gently bend it the opposite direction of the curl until the paper lies flat. If the problem persists, use photo paper that is not curled.
  - There may be too much paper loaded in the main tray. Remove some paper from the main tray and try printing again. For paper loading instructions, see [Load paper](#).
  - The paper may be too thin or too thick. Use HP paper for best results. For more information, see [Choose the right paper](#).
  - Two or more pieces of paper may be stuck together. Remove the paper from the tray and shuffle the paper so it does not stick together. Reload the paper into the tray and try printing again.
- 

### **Printed pages are dropping off of the output tray.**

**Solution** Pages can drop off of the output tray when they are printed. To prevent this, always extend the output tray extension when you print.

---

### **The printout is rippled or curled**

**Solution** The project you are printing uses a larger amount of ink than normal. Print the project from a computer, and use the printer software to lower the ink saturation level. See the onscreen HP Photosmart Printer Help for more information.

---



### The document printed at an angle or is off-center.

#### Solution

- The paper-width guide may not be set properly. Make sure that the paper-width guide is close to the edge of the paper without bending it.
  - The paper may not be loaded correctly. Make sure the paper is correctly oriented in the main tray. For paper loading instructions, see [Load paper](#).
  - The photo paper may not be loaded correctly. Reload the photo paper, make sure that the photo paper is correctly oriented in the photo tray. For photo paper-loading instructions, see [Load paper](#).
- 

### Colors are not printing satisfactorily.

#### Solution

- You may not be using the best print cartridges for the project. To print text documents and graphics, use the HP Tri-color and HP Black print cartridges. To print color photos, use the HP Tri-color and HP Photo or HP Gray Photo cartridges. For more information, see [Inserting and replacing the print cartridges](#).
  - You may be printing in Ink-backup Printing Mode. The printer enters Ink-backup printing mode when one of the print cartridges is missing. Replace the missing cartridge.
  - A cartridge is out of ink. Replace it.
  - Some of the ink nozzles on a cartridge are clogged. Clean the cartridges. See [Cleaning the print cartridges](#).
  - You may not be using the best media for the project. For more information on papers, see [Choose the right paper](#).
- 

### No page came out of the printer.

#### Cause

- The paper trays may be empty. Load the paper tray. For information on loading paper, see [Load paper](#).
- There may be a paper jam.

#### Solution



**Caution** Do NOT remove jammed paper from the front of the printer. Doing so can cause irreversible damage to the printer.

#### To clear a paper jam

1. Turn off the printer, and then unplug the printer.
2. Remove the rear access door.

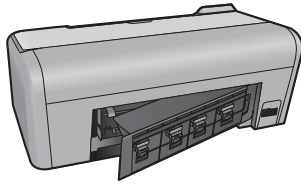

3. Gently remove the jammed paper from the printer.
4. Replace the rear access door.
5. Plug in the printer and turn it on.
6. When you have cleared the paper jam, print your document again.

If you experience paper jams when printing on photo paper, try the following:

- Insert the photo paper as far as it will go into the photo tray.
- Load one sheet of photo paper at a time.

---

### **A blank page came out of the printer.**

#### **Solution**

- Check the printer screen to see if crosses appear in the pen icons. If the crosses appear, the print cartridges are out of ink. If the pen icons have ink drops with only one ink level bar, the ink level may be too low to print. Replace the print cartridges that are out of ink. For more information about checking ink levels, see the HP Photosmart Printer Help.
- You may have begun printing and then cancelled the process. If you cancelled the process before printing started, the printer may have already loaded paper in preparation for printing. The next time you print, the printer will eject the blank page before starting the new printing project.

---

### **My photos do not print when I press the Print button.**

**Solution** You may not have selected your photos by pressing **OK**. For instructions on how to select your photos, see [Select photos to print](#).

---

### **The printer is displaying the out of ink indicator, but I don't know which cartridge to replace.**

**Solution** The two pen icons represent the print cartridges. Replace the cartridge based on the cross marks in the pen icons. For more information, see [Printer screen status indicators](#).

## Print quality is poor.

### Solution

- You may be printing in Ink-backup Printing Mode. The printer enters Ink-backup Printing Mode when one of the print cartridges is missing. Replace the missing print cartridge with a new one.
  - One of the print cartridges may be running out of ink. Check the printer screen to see if crosses appear in the pen icons. Low ink level is indicated by a single ink level bar. If a print cartridge is running low on ink, replace it. For more information, see [Inserting and replacing the print cartridges](#).
  - Use photo paper designed for the printer. For best results, use HP paper.
  - You may be printing on the wrong side of the paper. Make sure the paper is loaded with the side to be printed facing down.
  - You may have selected a low-resolution setting on the digital camera. Reduce the size of the image and try printing again. For better results in the future, set the digital camera to a higher photo resolution.
  - There may be a problem with a print cartridge. Try the following:
    - Remove and then reinsert the print cartridges.
    - Run an automatic print cartridge cleaning procedure from the HP Photosmart **Toolbox**. For more information, see the HP Photosmart Printer Help.
    - If this does not solve the problem, try cleaning the copper-colored contacts on the print cartridges. For more information, see [Manually cleaning the print cartridge contacts](#).
    - If these solutions do not work, replace the print cartridge(s).
- 

## Printed photos are not fitting to the paper as desired.

### Solution

- You may have loaded the photo paper incorrectly. Load the photo paper with the side to be printed facing down.
  - The photo paper may not have fed into the printer correctly. Try the following:
    - If you have a paper jam, see [To clear a paper jam](#).
    - Load one sheet of photo paper at a time.
  - You may have selected the wrong layout. For information, see [Select a photo layout](#).
  - See the HP Photosmart online printer help for information on how to optimize photo quality.
- 

## CD/DVD printing problems

Before contacting HP Customer Care, read this section, or go to the online support services at [www.hp.com/support](http://www.hp.com/support).

**The Attention indicator light flashes red after I give a print command from the software.**

**Solution** This is normal. The printer is waiting for you to insert the CD/DVD holder in the CD/DVD tray. For information on loading the CD/DVD tray, see [Loading the CD/DVD tray](#).

---

**The CD/DVD holder is not loaded completely.**

**Solution**

- Push the CD/DVD holder slowly into the CD/DVD tray.
  - If the problem persists, stick a double stick tape on the underside of the holder, across the center hole of the holder.
- 

**The label does not print on the CD/DVD. The CD/DVD holder almost completely ejects out of the rear of the printer.**

**Solution**

Physically remove the holder and close the CD/DVD tray. Pull out the power cord. Plug the power cord after a few seconds. Insert the CD/DVD holder into the CD/DVD tray to resume printing. For information on loading the CD/DVD tray, see [Loading the CD/DVD tray](#).

---

**The CD/DVD holder extends from the rear of the printer.**

**Solution** This is normal. The CD/DVD holder extends to about 7.5 cms (3 inches) from the rear of the printer.

---

## Bluetooth printing problems

Before contacting HP Customer Care, read this section, or go to the online support services at [www.hp.com/support](http://www.hp.com/support). Be sure to also read the documentation that came with your HP Bluetooth wireless printer adapter and your Bluetooth device.

**My Bluetooth device cannot find the printer.**

**Solution**

- Make sure the Bluetooth device is plugged into the camera port on the front of the printer. The light on the adapter flashes when the adapter is ready to receive data.
  - You may be too far from the printer. Move the Bluetooth device closer to the printer. The maximum recommended distance between the Bluetooth device and the printer is 10 meters (30 feet).
  - Make sure that your Bluetooth device is compatible with the printer. For more information, see [Specifications](#).
-

**No page came out of the printer.**

**Solution** The printer may not recognize the type of file sent by the device with Bluetooth wireless technology. For a list of the file formats that the printer supports, see [Printer specifications](#).

**Print quality is poor.**



**Solution** The photo you printed may be low resolution. For better results, set the digital camera to a higher resolution. Photos taken with VGA-resolution cameras, such as those found in wireless phones, may not have high enough resolution to produce a high-quality print.

## Printer screen status indicators

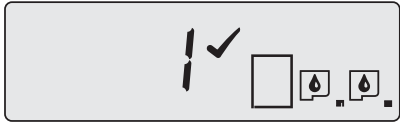
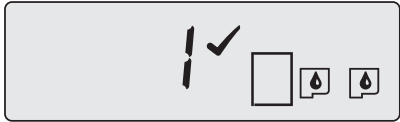
The printer screen has two status indicators: one for print cartridge status, and another for paper status.

This indicator...	Has this meaning...
	<p>When the ink drop and a single ink level bar is present, the ink in the cartridges is low. You will need to replace the print cartridges.</p> <p>When the ink in the left cartridge is low, only the left ink level bar reduces to one. Replace the left print cartridge.</p> <p>When the ink in the right cartridge is low, only the right ink level bar reduces to one. Replace the right print cartridge.</p>
	<p>When the pen icons flash, it indicates an error in the print cartridge. When both the pen icons flash, there is an error in both the print cartridges. Replace the print cartridges to resume printing.</p> <p>When only the left pen icon flashes, there is an error in the left print cartridge. Replace the left print cartridge.</p> <p>When only the right pen icon flashes, there is an error in the right print cartridge. Replace the right print cartridge.</p> <p>When purchasing replacement cartridges, refer to the cartridge numbers that appear</p>

(continued)

This indicator...	Has this meaning...
	on the back cover of this guide. For more information, see <a href="#">Inserting and replacing the print cartridges</a>
	When the paper icon begins to flash, either there is a paper jam or the printer is out of paper. For more information on clearing a paper jam, see <a href="#">clearing a paper jam</a> . For information on loading paper, see <a href="#">Load paper</a> .



# 8 HP Support



**Note** The name of HP support services may vary by country/region.

If you have a problem, follow these steps:

1. Check the documentation that came with the printer.
  - **Quick Start Guide:** The *HP Photosmart D5100 series Quick Start Guide* explains how to set up the printer and print your first photo.
  - **User Guide:** The *User Guide* is the book you are reading. This book describes the basic features of the printer, explains how to use the printer without connecting a computer, and contains hardware troubleshooting information.
  - **HP Photosmart help:** The onscreen HP Photosmart help describes how to use the printer with a computer and contains software troubleshooting information. See [Accessing the onscreen HP Photosmart Printer Help](#).
2. If you are unable to solve the problem using the information in the documentation, visit [www.hp.com/support](http://www.hp.com/support) to do the following:
  - Access online support pages
  - Send HP an e-mail message for answers to your questions
  - Connect with an HP technician by using online chat
  - Check for software updatesSupport options and availability vary by product, country/region, and language.
3. **For Europe only:** Contact your local point of purchase. If the printer has a hardware failure, you will be asked to bring the printer to where you purchased it. Service is free during the printer limited warranty period. After the warranty period, you will be quoted a service charge.
4. If you are unable to solve the problem using the onscreen Help or HP web sites, call HP Support using the number for your country/region. For a list of country/region phone numbers, see [HP Support by phone](#).

## HP Support by phone

While the printer is under warranty, you can obtain free phone support. For more information, see the warranty included in the box, or go to [www.hp.com/support](http://www.hp.com/support) to check the duration of your free support.

After the free phone support period, you can obtain help from HP at an additional cost. Contact your HP dealer or call the support phone number for your country/region for support options.

To receive HP support by phone, call the appropriate support phone number for your location. Standard phone company charges apply.

**North America:** Call 1-800-474-6836 (1-800-HP-invent). U.S. phone support is available in both English and Spanish languages 24 hours a day, 7 days a week (days and hours of support may change without notice). This service is free during the warranty period. A fee may apply outside the warranty period.

**Western Europe:** Customers in Austria, Belgium, Denmark, Spain, France, Germany, Ireland, Italy, Netherlands, Norway, Portugal, Finland, Sweden, Switzerland, and the United Kingdom should go to [www.hp.com/support](http://www.hp.com/support) to access phone support numbers in their country/region.



**Other countries/regions:** See the list of support telephone numbers inside the front cover of this guide.

## Placing a call

Call HP Support while you are near the computer and printer. Be prepared to provide the following information:

- Printer model number (located on the front of the printer)
- Printer serial number (located on the bottom of the printer)
- Computer operating system
- Version of printer software:
  - **Windows PC:** To see the printer software version, right-click the HP Digital Imaging Monitor icon in the Windows taskbar and select **About**.
  - **Macintosh:** To see the printer software version, use the **Print** dialog box.
- Messages displayed on the printer screen or on the computer monitor
- Answers to the following questions:
  - Has the situation you are calling about happened before? Can you recreate the situation?
  - Did you install any new hardware or software on the computer around the time that the situation occurred?

## Return to HP repair service (North America only)

HP will arrange to have your product picked up and delivered to an HP Central Repair Center. We pay for the round-trip shipping and handling. This service is free for the duration of the hardware warranty period.

## HP Quick Exchange Service (Japan only)

製品に問題がある場合は以下に記載されている電話番号に連絡してください。製品が故障している、または欠陥があると判断された場合、HP Quick Exchange Serviceがこの製品を正常品と交換し、故障した製品を回収します。保証期間中は、修理代と配送料は無料です。また、お住まいの地域にも依りますが、プリンタを次の日までに交換することも可能です。

電話番号：05 70-00051 1（自動応答）

:03-3335-9800（自動応答システムが使用できない場合）

サポート時間：平日の午前 9:00 から午後 5:00 まで

土日の午前 10:00 から午後 5:00 まで。

祝祭日および1月1日から 3日は除きます。

### サービスの条件

- サポートの提供は、カスタマケアセンターを通してのみ行われます。
- カスタマケアセンターがプリンタの不具合と判断した場合に、サービスを受けることができます。  
**ご注意：**ユーザの扱いが不適切であったために故障した場合は、保証期間中であっても修理は有料となります。詳細については保証書を参照してください。

### その他の制限

- 運送の時間はお住まいの地域によって異なります。詳しくは、カスタマケアターに連絡してご確認ください。
- 出荷配送は、当社指定の配送業者が行います。  
**ご注意：** デバイスはインクカートリッジを取り外さないで返還してください。
- 配送は交通事情などの諸事情によって、遅れる場合があります。
- このサービスは、将来予告なしに変更することがあります。

## Additional warranty options

Extended service plans are available for the printer at additional costs. Go to [www.hp.com/support](http://www.hp.com/support), select your country/region and language, then explore the services and warranty area for information about the extended service plans.



# 9 Specifications

This section lists the minimum system requirements for installing the printer software, and provides selected printer specifications.

For a complete list of printer specifications and system requirements, see the onscreen HP Photosmart Printer Help. For more information, see [Welcome](#).

## System specifications

Component	Windows PC minimum	Macintosh minimum
<b>Operating system</b>	Microsoft® Windows 98, 2000 Professional, Me, XP Home, and XP Professional	Mac OS X 10.2 and greater
<b>Processor</b>	Intel® Pentium® II (or equivalent) or higher	G3 or greater
<b>RAM</b>	128 MB recommended	128 MB
<b>Free disk space</b>	500 MB	150 MB
<b>Video display</b>	800 x 600, 16-bit or higher	800 x 600, 16-bit or higher
<b>CD-ROM drive</b>	4x	4x
<b>Connectivity</b>	<b>USB 2.0 full-speed:</b> Microsoft Windows 98, 2000 Professional, Me, XP Home, and XP Professional <b>PictBridge:</b> using front camera port <b>Bluetooth:</b> using optional HP Bluetooth wireless printer adapter	<b>USB 2.0 full-speed:</b> Mac OS X 10.2 and greater <b>PictBridge:</b> using front camera port
<b>Browser</b>	Microsoft Internet Explorer 5.5 or later	—

## Printer specifications

Category	Specifications
<b>Media specifications</b>	Recommended maximum length: 35.6 cm (14 inch) Recommended maximum thickness: 292 µm (11.5 mil)
<b>Media sizes</b>	Photo paper, 10 x 15 cm (4 x 6 inch) Photo paper with tab, 10 x 15 cm with 1.25 cm tab (4 x 6 inch with 0.5 inch tab) Photo paper, 13 x 18 cm (5 x 7 inch) Photo paper, 10 x 30 cm (4 x 12 inch) panorama Photo cards, 10 x 20 cm (4 x 8 inch) Index cards, 10 x 15 cm (4 x 6 inch) Hagaki cards, 10.0 x 14.8 cm (3.9 x 5.8 inch) A6 cards, 10.5 x 14.8 cm (4.1 x 5.8 inch) L-size cards, 9.0 x 12.7 cm (3.5 x 5 inch) L-size cards with tab, 9.0 x 12.7 cm with 1.25 cm tab (3.5 x 5 inch with 0.5 inch tab)
<b>Media sizes supported</b>	<b>Supported sizes when printing from a computer</b> 7.6 x 12.7 cm to 22 x 61 cm (3 x 5 inch to 8.5 x 24 inch) <b>Supported sizes when printing from the control panel</b> Metric: A6, A4, 10 x 15 cm (with and without tab); Imperial: 3.5 x 5 inch, 4 x 6 inch (with and without tab), 4 x 12 inch, 5 x 7 inch, 8 x 10 inch, 8.5 x 11 inch; Other: Hagaki and L-size
<b>Media types supported</b>	Paper (plain, inkjet, photo, and panoramic photo) Envelopes Transparencies Labels Cards (index, greeting, Hagaki, A6, L-size) Iron-on transfers Avery C6611 and C6612 photo sticker paper: 10 x 15 cm (4 x 6 inch), 16 rectangular or oval stickers per page Printable CDs, 120 mm and 80 mm Printable DVDs, 120 mm and 80 mm
<b>Image file formats</b>	JPEG Baseline TIFF 24-bit RGB uncompressed interleaved TIFF 24-bit YCbCr uncompressed interleaved TIFF 24-bit RGB packbits interleaved TIFF 8-bit gray uncompressed/packbits TIFF 8-bit palette color uncompressed/packbits TIFF 1-bit uncompressed/packbits/1D Huffman
<b>Memory cards</b>	CompactFlash Type I and II

(continued)

<b>Category</b>	<b>Specifications</b>
	Microdrive MultiMediaCard Secure Digital Memory Sticks xD-Picture Card
<b>Memory card-supported file formats</b>	<b>Printing</b> JPEG Uncompressed TIFF <b>Saving</b> All file formats
<b>Paper tray – media sizes supported</b>	<b>Main tray</b> 7.6 x 12.7 cm to 21.6 x 35.6 cm (3 x 5 inch to 8.5 x 14 inch) <b>Photo tray</b> 10 x 15 cm (4 x 6 inch), 10 x 15 cm (4 x 6 inch) with tab, index cards, and Hagaki <b>Output tray</b> All supported sizes
<b>Paper tray capacity</b>	<b>Main tray</b> 125 sheets of plain paper 15 envelopes 20–40 cards (depending on thickness) 20 sheets of labels 25 transparencies, iron-on transfers, or photo paper <b>Photo tray</b> 25 sheets of photo paper <b>Output tray</b> 50 sheets of plain paper 10 cards or envelopes 25 sheets of labels or iron-on transfers
<b>Power consumption</b>	Power off: 2.13 W AC Printing: 6.604 W AC Idle: 2.28 W AC
<b>Power requirements</b>	<b>Input frequency:</b> 50/60 Hz, (+/- 3Hz) <b>Input voltage:</b> 100 to 240, Vac (+/- 10%)
<b>Environmental specifications</b>	<b>Recommended temperature range:</b> 15–30° C (59–86° F) <b>Maximum temperature range:</b> 10–35° C (50–95° F) <b>Storage temperature range:</b> -30–65° C (-22–149° F) <b>Recommended humidity range:</b> 20–80% RH <b>Maximum humidity range:</b> 15–80% RH

(continued)

Category	Specifications
<b>Print cartridges</b>	1 HP Black 1 HP Tri-color 1 HP Photo 1 HP Gray Photo  <b>Note</b> The cartridge numbers you can use with this printer appear on the back cover of this guide.
<b>Print speed (maximum)</b>	<b>Black printouts:</b> 23 pages per minute <b>Color printouts:</b> 21 pages per minute <b>Photos:</b> 27 seconds for each 10 x 15 cm (4 x 6 inch) photo
<b>Connectivity</b>	<b>USB 2.0 full-speed:</b> Microsoft Windows 98, 2000 Professional, Me, XP Home, and XP Professional; Mac OS X 10.2 and greater) <b>PictBridge:</b> Microsoft Windows 98, 2000 Professional, Me, XP Home, and XP Professional; Mac OS X 10.2 and greater <b>Bluetooth:</b> Microsoft Windows XP Home and XP Professional
<b>USB support</b>	Microsoft Windows 98, 2000 Professional, Me, XP Home, and XP Professional Mac OS X 10.2 and greater A Universal Serial Bus (USB) 2.0 full-speed compliant cable 3 meters (10 feet) or less in length

# 10 HP Warranty

HP product	Duration of limited warranty
Software Media	90 days
Printer	1 year
Print or Ink cartridges	Until the HP ink is depleted or the "end of warranty" date printed on the cartridge has been reached, whichever occurs first. This warranty does not cover HP ink products that have been refilled, remanufactured, refurbished, misused, or tampered with.
Accessories	1 year unless otherwise stated

## A. Extent of limited warranty

- Hewlett-Packard (HP) warrants to the end-user customer that the HP products specified above will be free from defects in materials and workmanship for the duration specified above, which duration begins on the date of purchase by the customer.
- For software products, HP's limited warranty applies only to a failure to execute programming instructions, HP does not warrant that the operation of any product will be interrupted or error free.
- HP's limited warranty covers only those defects that arise as a result of normal use of the product, and does not cover any other problems, including those that arise as a result of:
  - Improper maintenance or modification;
  - Software, media, parts, or supplies not provided or supported by HP;
  - Operation outside the product's specifications;
  - Unauthorized modification or misuse.
- For HP printer products, the use of a non-HP cartridge or a refilled cartridge does not affect either the warranty to the customer or any HP support contract with the customer. However, if printer failure or damage is attributable to the use of a non-HP or refilled cartridge or an expired ink cartridge, HP will charge its standard time and materials charges to service the printer for the particular failure or damage.
- If HP receives, during the applicable warranty period, notice of a defect in any product which is covered by HP's warranty, HP shall either repair or replace the product, at HP's option.
- If HP is unable to repair or replace, as applicable, a defective product which is covered by HP's warranty, HP shall, within a reasonable time after being notified of the defect, refund the purchase price for the product.
- HP shall have no obligation to repair, replace, or refund until the customer returns the defective product to HP.
- Any replacement product may be either new or like-new, provided that it has functionality at least equal to that of the product being replaced.
- HP products may contain remanufactured parts, components, or materials equivalent to new in performance.
- HP's Limited Warranty Statement is valid in any country where the covered HP product is distributed by HP, Contracts for additional warranty services, such as on-site service, may be available from any authorized HP service facility in countries where the product is distributed by HP or by an authorized importer.

## B. Limitations of warranty

TO THE EXTENT ALLOWED BY LOCAL LAW, NEITHER HP NOR ITS THIRD PARTY SUPPLIERS MAKES ANY OTHER WARRANTY OR CONDITION OF ANY KIND, WHETHER EXPRESS OR IMPLIED WARRANTIES OR CONDITIONS OF MERCHANTABILITY, SATISFACTORY QUALITY, AND FITNESS FOR A PARTICULAR PURPOSE.

## C. Limitations of liability

- To the extent allowed by local law, the remedies provided in this Warranty Statement are the customer's sole and exclusive remedies.
- TO THE EXTENT ALLOWED BY LOCAL LAW, EXCEPT FOR THE OBLIGATIONS SPECIFICALLY SET FORTH IN THIS WARRANTY STATEMENT, IN NO EVENT SHALL HP OR ITS THIRD PARTY SUPPLIERS BE LIABLE FOR DIRECT, INDIRECT, SPECIAL, INCIDENTAL, OR CONSEQUENTIAL DAMAGES, WHETHER BASED ON CONTRACT, TORT, OR ANY OTHER LEGAL THEORY AND WHETHER ADVISED OF THE POSSIBILITY OF SUCH DAMAGES.

## D. Local law

- This Warranty Statement gives the customer specific legal rights. The customer may also have other rights which vary from state to state in the United States, from province to province in Canada, and from country to country elsewhere in the world.
- To the extent that this Warranty Statement is inconsistent with local law, this Warranty Statement shall be deemed modified to be consistent with such local law. Under such local law, certain disclaimers and limitations of this Warranty Statement may not apply to the customer. For example, some states in the United States, as well as some governments outside the United States (including provinces in Canada), may:
  - Preclude the disclaimers and limitations in this Warranty Statement from limiting the statutory rights of a consumer (e.g., the United Kingdom);
  - Otherwise restrict the ability of a manufacturer to enforce such disclaimers or limitations; or
  - Grant the customer additional warranty rights, specify the duration of implied warranties which the manufacturer cannot disclaim, or allow limitations on the duration of implied warranties.
- THE TERMS IN THIS WARRANTY STATEMENT, EXCEPT TO THE EXTENT LAWFULLY PERMITTED, DO NOT EXCLUDE, RESTRICT, OR MODIFY, AND ARE IN ADDITION TO, THE MANDATORY STATUTORY RIGHTS APPLICABLE TO THE SALE OF THE HP PRODUCTS TO SUCH CUSTOMERS.

### HP Limited Warranty

Dear Customer,

You will find below the name and address of the HP entity responsible for the performance of the HP Limited Warranty in your country.

**You may have additional statutory rights against the seller based on your purchase agreement. Those rights are not in any way affected by this HP Limited Warranty.**

**Ireland:** Hewlett-Packard Ireland Ltd, 30 Herbert Street IRL-Dublin 2

**United Kingdom:** Hewlett-Packard Ltd, Cain Road, Bracknell, GB-Berks RG12 1HN





# Index

- B**
  - Bluetooth
    - connecting to printer 15
    - troubleshooting 41
  - borderless photos
    - selecting layout 18
- C**
  - camera-selected photos 19
  - cameras
    - Bluetooth 20
    - connecting to printer 15
    - PictBridge 20
    - port 4
    - printing from 20
  - care and maintenance 31
  - cartridges. *See* print cartridges
  - cleaning
    - print cartridge contacts 31
    - print cartridges 31
    - printer 31
  - computer
    - printing from 23
    - printing without 15
    - saving photos to 25
    - system specifications 49
- D**
  - digital cameras. *See* cameras
  - documentation, printer 3
  - DPOF files 19
- E**
  - energy consumption 4
  - Energy Star 4
- F**
  - file formats, supported 17
- H**
  - help. *See* troubleshooting
  - Hewlett-Packard Company
    - notices 4
  - HP Photosmart Essential 23
  - HP Photosmart Premier 23
  - HP Photosmart Share 24
  - HP Photosmart Studio (Mac only) 24
  - HP Solution Center 12
  - HP Support 45
- I**
  - ink cartridges. *See* print cartridges
  - inserting
    - memory cards 16
    - print cartridges 13
  - iPod 15
- J**
  - JPEG file format 17
- L**
  - layout, selecting 18
- M**
  - Macintosh
    - HP Photosmart Mac software 24
  - memory cards
    - inserting 16
    - printing photo index 18
    - removing 20
    - supported file formats 17
- P**
  - paper
    - buying and choosing 9
    - maintaining 9, 33
    - sizes 50
    - status indicator 42
    - trays 4
    - troubleshooting 37
  - photos
    - do not print 39
    - index 18
    - numbers do not appear 36
    - printing 19
    - saving to computer 25
    - selecting for print 19
    - selecting layout 18
    - supported file formats 17
  - PictBridge cameras
    - camera port 20
    - print cartridges
      - cleaning 31
      - cleaning contacts 31
      - inserting 13
      - out of ink 39
      - replacing 13
      - status indicator 42
      - storing 33
  - printer
    - care and maintenance 31
    - cleaning 31
    - connecting 15
    - documentation 3
    - parts 4
    - power problems 36
    - specifications 50
    - status indicators 42
    - storing 33
  - printer help
    - accessing 3
  - printer screen 6
  - printer software
    - updating 32
  - printer software, updating 23
  - printing
    - from a computer 23
    - from BlueTooth device 15
    - from cameras 20
    - from memory cards 15, 19
    - from PictBridge camera 15
    - photo index 18
    - selecting layout 18
    - without computer 15
- Q**
  - quality
    - photo paper 33
    - troubleshooting 40
- R**
  - regulatory notices
    - regulatory model
      - identification number 4
  - removing memory cards 20
  - replacing print cartridges 13

## **S**

- saving photos to computer 25
- specifications 49
- storing
  - photo paper 33
  - print cartridges 33
  - printer 33
- system specifications 49

## **T**

- TIFF file format 17
- trays, paper 4
- troubleshooting
  - Bluetooth 41
  - CD 40
  - DVD 40
  - flashing lights 35
  - HP Support 45
  - low ink 39
  - paper problems 37
  - photo index numbers do not appear 36
  - power problems 36
  - print quality 40
  - printer noises 36
  - pulsing lights 35

## **U**

- USB
  - port 4
  - specifications 49