



User Guide

HP USB Barcode Scanner for Point of Sale System

Document Part Number:419218-002

August 2006

Print this document before setting up the HP USB Barcode Scanner. The document provides the programming bar codes necessary for selecting features for the scanner.

© Copyright 2006 Hewlett-Packard Development Company, L.P.
The information contained herein is subject to change without notice.

The only warranties for HP products and services are set forth in the express warranty statements accompanying such products and services. Nothing herein should be construed as constituting an additional warranty. HP shall not be liable for technical or editorial errors or omissions contained herein.

This document contains proprietary information that is protected by copyright. No part of this document may be photocopied, reproduced, or translated to another language without the prior written consent of Hewlett-Packard Company.



WARNING: Text set off in this manner indicates that failure to follow directions could result in bodily harm or loss of life.



CAUTION: Text set off in this manner indicates that failure to follow directions could result in damage to equipment or loss of information.

User Guide

HP USB Barcode Scanner

First Edition (August 2006)

Document Part Number: 419218-002

Contents

1 Product Features

Identifying Barcode Scanner Components. 1–2

2 Safety and Maintenance Guidelines

Important Safety Information. 2–1

Maintenance Guidelines. 2–3

3 Setting Up the Scanner

Connecting the USB Interface Cable. 3–1

 Removing the USB Interface Cable 3–2

Assembling the Stand. 3–2

Mounting the Stand 3–3

 Screw Mount 3–3

 Tape Mount 3–4

Setting Up the USB Interface. 3–4

USB Default Parameters 3–5

Parameters Descriptions. 3–6

 USB Country Keyboard Types (Country Codes) 3–6

 USB Caps Lock Override 3–11

 USB Ignore Unknown Characters. 3–12

 Emulate Keypad 3–13

 USB Keyboard FN 1 Substitution. 3–13

 Function Key Mapping 3–14

 Simulated Caps Lock. 3–14

 Convert Case 3–15

 USB ASCII Character Set 3–16

4 Operating the Scanner

Defining Beeper Sequences	4-1
Defining LED Indicators	4-3
Scanning in Hand-Held Mode	4-4
Aiming the Scanner	4-5
Scanning in Hands-Free Mode.	4-6

5 Programming User Preferences

Scanning Sequence Examples	5-1
Errors While Scanning	5-2
User Preferences Default Parameters.	5-2
User Preferences.	5-3
Set Default Parameter	5-3
Beeper Tone.	5-4
Beeper Volume	5-5
Power Mode.	5-6
Laser On Time.	5-7
Beep After Good Decode	5-8

A Troubleshooting

Solving Common Problems	A-1
Using the Worldwide Web.	A-2
Preparing to Call Technical Support	A-2

B Technical Specifications

Decode Zone	B-3
Disposal of Waste Equipment by Users in Private Household in the European Union	B-4

Product Features

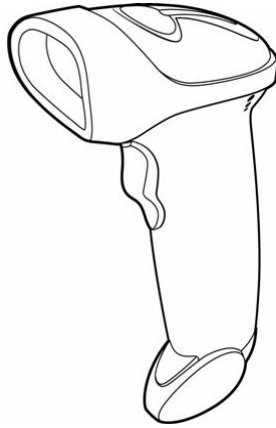

The HP USB Barcode Scanner is designed to work with point of sale system hardware and program applications. The barcode scanner features:

- Hand-held or hands-free scanning operation.
- Stand assembly kit for hands free operation.
- USB connection that autodetects a USB host and defaults to the HID keyboard interface type.
- USB cable assembly provided.
- Supports international keyboards for Microsoft Windows environment: North America, German, French, Spanish, Italian, Swedish, Brazilian Portuguese and Japanese.

- Software and regulatory notices for this product are available on the *Point of Sale System Software and Documentation CD*.

Identifying Barcode Scanner Components

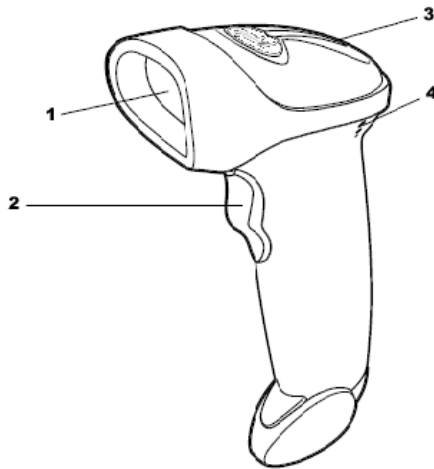

-
- | | |
|---|--|
| 1 | Scan Window - scans bar code symbols with laser light and produces a digitized pattern that corresponds to the bars and spaces of the symbols. |
|---|--|
-
- | | |
|---|---|
| 2 | Scan Trigger - press to scan bar codes. |
|---|---|
-
- | | |
|---|--|
| 3 | LED - light indicator that communicates successful decoding, data transmission error or malfunction. |
|---|--|
-
- | | |
|---|--|
| 4 | Beeper - emits different beeper sequences and patterns that are defined by you while programming the scanner and during normal scanning. |
|---|--|
-

Safety and Maintenance Guidelines

Important Safety Information

Follow the recommendations below to avoid potential risk of ergonomic injury when using the HP USB Barcode Scanner.



WARNING: To reduce the risk of serious injury, read the *Safety and Comfort Guide*. It describes proper workstation, setup, posture, and health habits for users, and provides important electrical and mechanical safety information. This guide is located on the Web at <http://www.hp.com/ergo> and/or on the documentation CD if one is included with the product.

1. Use the optimum arm position.



2. Avoid extreme wrist angles.

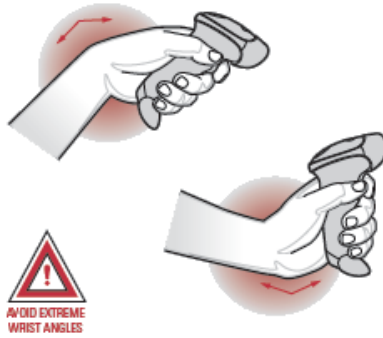

3. Avoid Bending.



4. Avoid reaching.



Maintenance Guidelines

Cleaning the scan window is the only maintenance required. A dirty window may affect scanning accuracy.

- Do not allow any abrasive material to touch the window.
- Remove any dirt particles with a damp cloth.
- Wipe the window using a tissue moistened with mild detergent and water.
- Do not spray water or other cleaning liquids directly into the window.

3

Setting Up the Scanner

The scanner attaches directly to a USB port on the POS computer and is powered by the computer. No additional power supply is required.

Connecting the USB Interface Cable

1. Plug the USB interface cable ❶ into the cable interface port ❷ on the bottom of the scanner.

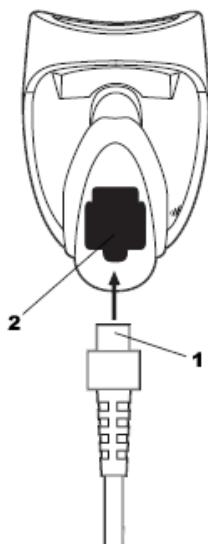

2. Gently tug the cable to ensure the connector is properly secured.
3. Connect the other end of the interface cable into a USB port on the POS computer.

Removing the USB Interface Cable

1. Unplug the installed cable's modular connector by depressing the connector clip with the tip of a screwdriver.

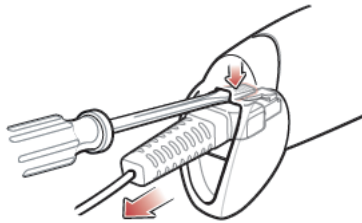

2. Carefully slide out the cable.

Assembling the Stand

The stand allows hands-free scanning when attached to the scanner.

1. Unscrew the wingnut from the bottom of the neckpiece scanner cup.
2. Fit the bottom of the neck piece ❶ into the opening on the top of the stand base ❷.
3. Tighten the wingnut ❸ underneath the base to secure the cup and neck piece to the base.



Before tightening the wingnut under the base, ensure that the flat areas on the flexible neck fit securely in the grooves in the base.

4. Bend the neck to the desired position for scanning.

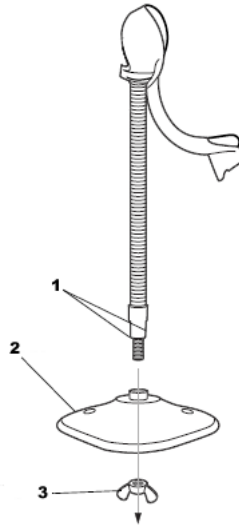

Mounting the Stand

You can attach the base of the scanner's stand to a flat surface using two screws or double-side tape (not provided).

Screw Mount

1. Position the assembled base on a flat surface.
2. Screw one #10 wood screw (not provided) into each screw-mount hole **1** until the base of the stand is secure.

Tape Mount

1. Peel the paper liner off one side of each piece of tape (not provided) ② and place the sticky surface over each of the three rectangular tape holders.
2. Peel the paper liner off the exposed sides of each piece of tape and press the stand on a flat surface until it is secure.

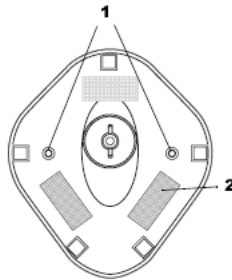

Setting Up the USB Interface

To set up the scanner for USB:

1. Turn on the POS computer.
2. Using the barcode scanner, scan the HID Keyboard Emulation barcode below.



***HID Keyboard Emulation**

3. On first installation when using Windows, the software prompts you to select or install the “Human Interface Device” driver. To install the “Human Interface Device” driver

provided by Windows, click “Next” through all the choices and click “Finished” on the last choice. The scanner powers up during this installation.

4. If you are not using a North American keyboard, scan the appropriate country bar code in **USB Country Keyboard Types (Country Codes)** in this chapter.

USB Default Parameters

The following table lists the defaults for USB host parameters. If you want to change any option, scan the appropriate bar codes provided in the “Parameters Descriptions” section of this chapter.

USB Host Default Parameters	Default
USB Device Type	HID Keyboard Emulation
USB Country Keyboard Types (country codes)	North American
USB Keystroke Delay	No Delay
USB CAPS Lock Override	Disable
USB Ignore Unknown Characters	Enable
Emulate Keypad	Disable
USB FN1 Substitution	Disable
Function Key Mapping	Disable
Simulated Caps Lock	Disable
Convert Case	None

Parameters Descriptions

USB Country Keyboard Types (Country Codes)

Scan the bar code corresponding to your country keyboard type. This setting applies only to the USB HID (Human Interface Devices) Keyboard Emulation device.



When changing country selection, the scanner automatically restarts. The scanner issues the standard startup beep sequences.



Throughout the programming bar code menus, default values are indicated with an asterisks (*).



***North American Standard USB Keyboard**

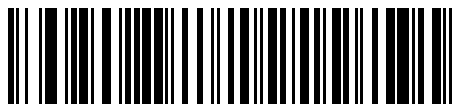

German Windows

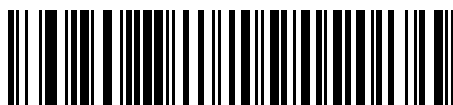

French Windows



French Canadian Windows 95/98



French Canadian Windows 2000/XP



Spanish Windows



Italian Windows



Swedish Windows



UK English Windows



Japanese Windows (ASCII)



Portuguese-Brazilian Windows

USB Keystroke Delay

This parameter sets the delay, in milliseconds, between emulated keystrokes. Scan a barcode below to increase the delay when hosts require a slower transmission of data.



* No Delay



Medium Delay (20 msec)

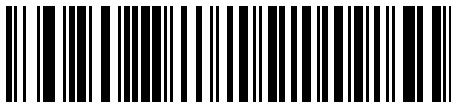

Long Delay (40 msec)

USB Caps Lock Override

When enabled, the case of the data is preserved regardless of the state of the Caps Lock key. This setting is always enabled for the “Japanese, Windows (ASCII)” keyboard type and can not be disabled.

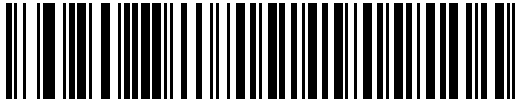

**Override Caps Lock Key
(Enable)**



***Do Not Override Caps Lock Key
(Disable)**

USB Ignore Unknown Characters

Unknown characters are characters the host does not recognize. When “Send Bar Codes With Unknown Characters” is selected, all bar code data is sent except for unknown characters, and no error beeps sound. When “Do Not Send Bar Codes With Unknown Characters” is selected, bar codes containing at least one unknown character are not sent to the host, and an error beep sounds.

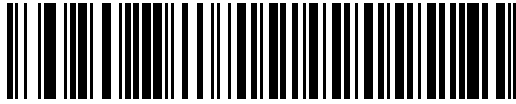

***Send Bar Codes with Unknown Characters
(Transmit)**

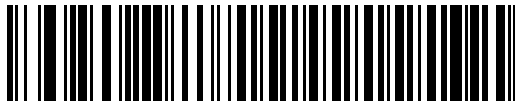

**Do Not Send Bar Codes with Unknown Characters
(Disable)**

Emulate Keypad

When enabled, all characters are sent as ASCII sequences over the numeric keypad. For example ASCII A would be sent as “ALT make” 0 6 5 “ALT Break”.



***Disable Keypad Emulation**

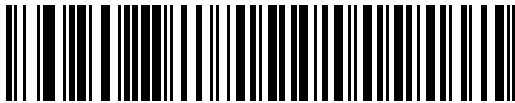

Enable Keypad Emulation

USB Keyboard FN 1 Substitution

When enabled, this allows replacement of any FN 1 characters in an EAN 128 bar code with a Key Category and value chosen by the user (see FN 1 Substitution Values in chapter 3 of the *Programming Reference Guide* to set the Key Category and Key Value).

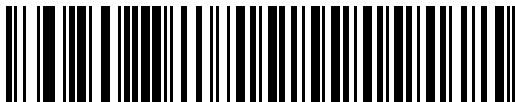

Enable

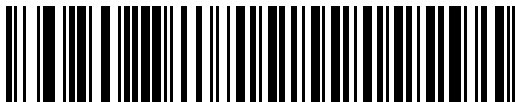

***Disable**

Function Key Mapping

ASCII values under 32 are normally sent as a control-key sequences (see the USB ASCII Character Set table in this chapter). When this parameter is enabled, the keys in bold in the USB ASCII Character Set table are sent in place of the standard key mapping. Table entries that do not have a bold entry remain the same whether or not this parameter is enabled.

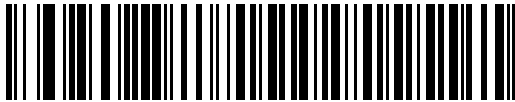

***Disable Function Key Mapping**

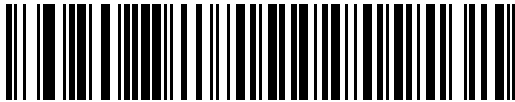

Enable Function Key Mapping

Simulated Caps Lock

When enabled, the scanner will invert upper and lower case characters on the scanner barcode as if the Caps Lock state is enabled on the keyboard. This inversion is done regardless of the current state of the keyboard's Caps Lock state.

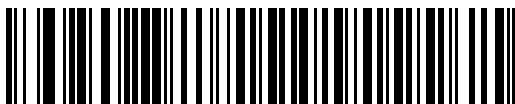

Disable Simulated Caps Lock



Enable Simulated Caps Lock

Convert Case

When enabled, the scanner will convert all bar code data to the selected case.

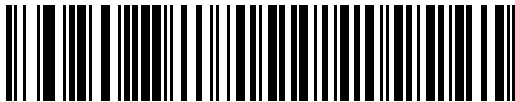

***No Case Conversion**

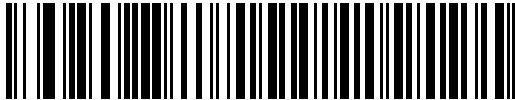

Convert All to Upper Case

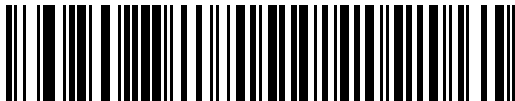

Convert All to Lower Case

USB ASCII Character Set

This table provides ASCII character conversions for standard data transmission code.

Prefix/Suffix Value	Full ASCII Code 39 Encode Char.	Keystroke
1000	%U	CTRL 2
1001	\$A	CTRL A
1002	\$B	CTRL B
1003	\$C	CTRL C
1004	\$D	CTRL D
1005	\$E	CTRL E
1006	\$F	CTRL F
1007	\$G	CTRL G
1008	\$H	CTRL H/ BACKSPACE ¹
1009	\$I	CTRL I/ HORIZONTAL TAB ¹
1010	\$J	CTRL J
1011	\$K	CTRL K
1012	\$L	CTRL L
1013	\$M	CTRL M/ ENTER ¹
1014	\$N	CTRL N
1015	\$O	CTRL O

Prefix/Suffix Value	Full ASCII Code 39 Encode Char.	Keystroke
1016	\$P	CTRL P
1017	\$Q	CTRL Q
1018	\$R	CTRL R
1019	\$S	CTRL S
1020	\$T	CTRL T
1021	\$U	CTRL U
1022	\$V	CTRL V
1023	\$W	CTRL W
1024	\$X	CTRL X
1025	\$Y	CTRL Y
1026	\$Z	CTRL Z
1027	%A	CTRL [/ ESC ¹
1028	%B	CTRL \
1029	%C	CTRL]
1030	%D	CTRL 6
1031	%E	CTRL -
1032	Space	Space
1033	/A	!
1034	/B	"
1035	/C	#

Prefix/Suffix Value	Full ASCII Code 39 Encode Char.	Keystroke
1036	/D	\$
1036	/D	\$
1037	/E	%
1038	/F	&
1039	/G	'
1040	/H	(
1041	/I)
1042	/J	*
1043	/K	+
1044	/L	'
1045	-	-
1046	.	.
1047	/O	/
1048	0	0
1049	1	1
1050	2	2
1051	3	3
1052	4	4
1053	5	5
1054	6	6

Prefix/Suffix Value	Full ASCII Code 39 Encode Char.	Keystroke
1055	7	7
1058	/Z	:
1059	%F	;
1060	%G	<
1061	%H	=
1062	%I	>
1063	%J	?
1064	%V	@
1065	A	A
1066	B	B
1067	C	C
1068	D	D
1069	E	E
1070	F	F
1071	G	G
1072	H	H
1073	I	I
1074	J	J
1075	K	K
1076	L	L

Prefix/Suffix Value	Full ASCII Code 39 Encode Char.	Keystroke
1077	M	M
1078	N	N
1079	O	O
1080	P	P
1081	Q	Q
1082	R	R
1083	S	S
1084	T	T
1085	U	U
1086	V	V
1087	W	W
1088	X	X
1089	Y	Y
1090	Z	Z
1091	%K	[
1092	%L	\
1093	%M]
1094	%N	^
1095	%O	_
1096	%W	'

Prefix/Suffix Value	Full ASCII Code 39 Encode Char.	Keystroke
1097	+A	a
1098	+B	b
1099	+C	c
1100	+D	d
1101	+E	e
1102	+F	f
1103	+G	g
1104	+H	h
1105	+I	i
1106	+J	j
1107	+K	k
1108	+L	l
1109	+M	m
1110	+N	n
1111	+O	o
1112	+P	p
1113	+Q	q
1114	+R	r
1115	+S	s
1116	+Y	t

Prefix/Suffix Value	Full ASCII Code 39 Encode Char.	Keystroke
1117	+U	u
1118	+V	v
1119	+W	w
1120	+X	x
1121	+Y	y
1122	+Z	z
1123	%P	{
1124	%Q	
1125	%R	}
1126	%S	~

¹ The keystroke in bold is sent only if the “Function Key Mapping” is enabled. Otherwise, the unbolden keystroke is sent.

ALT Keys	Keystroke
2064	ALT 2
2065	ALT A
2066	ALT B
2067	ALT C
2068	ALT D
2069	ALT E
2070	ALT F

2071	ALT G
2072	ALT H
2073	ALT I
2074	ALT J
2075	ALT K
2076	ALT L
2077	ALT M
2078	ALT N
2079	ALT O
2080	ALT P
2081	ALT Q
2082	ALT R
2083	ALT S
2084	ALT T
2085	ALT U
2086	ALT V
2087	ALT W
2088	ALT X
2089	ALT Y
2090	ALT Z

GUI Shift Keys

Windows-based systems have a GUI key to the left of the left ALT key and to the right of the right ALT key.

Other Value	Keystroke
3000	Right Control Key
3048	GUI 0
3049	GUI 1
3050	GUI 2
3051	GUI 3
3052	GUI 4
3053	GUI 5
3054	GUI 6
3055	GUI 7
3056	GUI 8
3057	GUI 9
3065	GUI A
3066	GUI B
3067	GUI C
3068	GUI D
3069	GUI E
3070	GUI F
3071	GUI G

3072	GUI H
3073	GUI I
3074	GUI J
3075	GUI K
3076	GUI L
3077	GUI M
3078	GUI N
3079	GUI O
3080	GUI P
3081	GUI Q
3082	GUI R
3083	GUI S
3084	GUI T
3085	GUI U
3086	GUI V
3087	GUI W
3088	GUI X
3089	GUI Y
3090	GUI Z
<hr/>	
F1 Keys	Keystroke
5001	F1

5002	F2
5003	F3
5004	F4
5005	F5
5006	F6
5007	F7
5008	F8
5009	F9
5010	F10
5011	F11
5012	F12
5013	F13
5014	F14
5015	F15
5016	F16
5017	F17
5018	F18
5019	F19
5020	F20
5021	F21
5022	F22

5023	F23
------	-----

5024	F24
------	-----

Keypad	Keystroke
---------------	------------------

6042	*
------	---

6043	+
------	---

6044	undefined
------	-----------

6045	-
------	---

6046	.
------	---

6047	/
------	---

6048	0
------	---

6049	1
------	---

6050	2
------	---

6051	3
------	---

6052	4
------	---

6053	5
------	---

6054	6
------	---

6055	7
------	---

6056	8
------	---

6057	9
------	---

6058	Enter
------	-------

6059	Num Lock
------	----------

Extended Keypad	Keystroke
7001	Break
7002	Delete
7003	PgUp
7004	End
7005	Pg Dn
7006	Pause
7007	Scroll Lock
7008	Backspace
7009	Tab
7010	Print Screen
7011	Insert
7012	Home
7013	Enter
7014	Escape
7015	Up Arrow
7016	Down Arrow
7017	Left Arrow
7018	Right Arrow

Operating the Scanner

This chapter covers techniques, tips and instructions involved in scanning bar codes and defining beeper and LED indicators.

Before using the scanner, you will need to install and program your scanner.

- For instructions on installing the scanner, refer to Chapter 3, “Setting Up the Scanner.”
- To configure or program your scanner, refer to Chapter 5, “Programming User Preferences.”
- To program different or additional bar code features, refer to the *Programming Reference Guide*, included on the *Point of Sale System Software and Documentation* CD. This guide provides the programming bar codes necessary for selecting non-default features, customizing data, and other programming selections for your scanner.

Defining Beeper Sequences

The scanner communicates with the user by emitting different beeper sequences and patterns. Refer to the “Standard Beeper Definitions” table in the chapter to define beep sequences that occur during both normal scanning and while programming the scanner.

Standard Beeper Definitions

Beeper Sequence	Indication
Low/medium/high beep	Power Up.
Short high beep	A bar code symbol was decoded (if decode beeper is enabled).
4 long low beeps	A transmission error was detected in a scanned symbol. The data is ignored. This occurs if a unit is not properly configured. Check beeper sequence option setting.
5 low beeps	Conversion or format error.
Lo/hi/lo beep	ADF transmit error.
Parameter Menu Scanning	
Short high beep	Correct entry scanned or correct menu sequence performed.
Lo/hi beep	Input error, incorrect bar code or "Cancel" scanned, wrong entry, incorrect bar code programming sequence; remain in program mode.
Hi/lo beep	Keyboard parameter selected. Enter value using bar code keypad.
Hi/lo/hi/lo beep	Successful program exit with change in the parameter setting.
Low/hi/low/hi beep	Out of host parameter storage space. Scan <i>Set Default Parameter</i> in this chapter.

Standard Beeper Definitions

Beeper Sequence	Indication
Code 39 Buffering	
Hi/lo beep	New Code 39 data was entered into the buffer.
3 Beeps - long high beep	Code 39 buffer is full.
Lo/hi/lo beep	The Code 39 buffer was erased or there was an attempt to clear or transmit an empty buffer.
Lo/hi beep	A successful transmission of buffered data.
4 short high beeps	Scanner has not completed initialization. Wait several seconds and scan again.
Scanner gives a power-up beep after scanning a USB Device Type	Communication with the bus must be established before the scanner can operate at the highest power level.
The power-up beep occurs more than once	The USB bus may put the scanner in a state where power to the scanner is cycled on and off more than once. This is normal and usually happens when the PC cold boots.

Defining LED Indicators

In addition to beeper sequences, the scanner communicates using a two-color LED display. Refer to the “Standard LED Definitions” table in this chapter to define the LED colors that display during scanning.

Standard LED Definitions

LED	Indication
Off	No power is applied to the scanner, or the scanner is on and ready to scan.
Green	A bar code was successfully decoded.
Red	A data transmission error or scanner malfunction occurred.

Scanning in Hand-Held Mode

1. Ensure all connections are secure.
2. Aim the scanner at the bar code. Press the trigger.

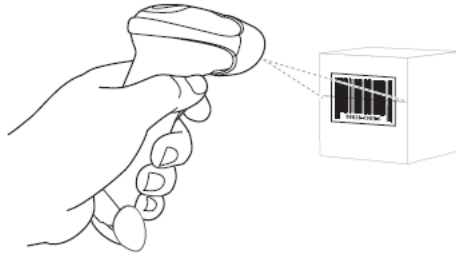

3. Ensure the scan line crosses every bar and space of the symbol.

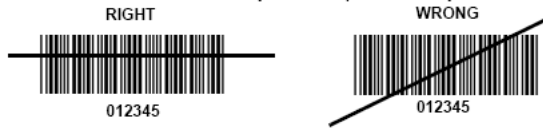

4. Upon successful decode, the scanner beeps and the LED turns green.

Aiming the Scanner

Do not hold the scanner directly over the bar code. Laser light reflecting directly back into the scanner from the bar code is known as specular reflection. This specular reflection can make decoding difficult. You can tilt the scanner up to 55° forward or back and achieve a successful decode. Simple practice quickly shows what tolerances to work within.

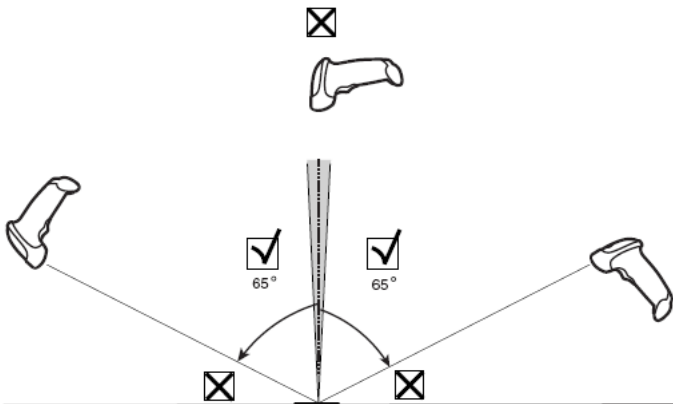

Scanning in Hands-Free Mode

When the scanner is seated in the stand's "cup," the scanner's built-in sensor places the scanner in hands-free mode. When the scanner is removed from the stand it operates in its normal hand-held mode.

1. Ensure all cable connections are secure.
2. Insert the scanner in the stand by placing the front of the scanner into the stand's "cup."

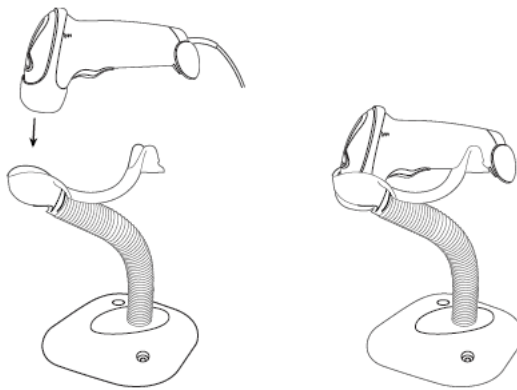

3. To scan a bar code, place the bar code up to the scanner and ensure the scan line crosses every bar and space of the symbol.
4. Upon successful decode, the scanner beeps and the LED turns green.

Programming User Preferences

You have the option to program the scanner to perform various functions, or activate different features. This chapter describes each user preference feature and provides the programming bar codes necessary for selecting these features for your scanner.

The scanner is shipped with the settings listed in the “User Preferences Default” table in this chapter (also see the section “USB Default Parameters” in chapter 3 of this guide). If the default values suit your requirements, programming may not be necessary.

Features values are set by scanning single bar codes or short bar code sequences. The settings are stored in non-volatile memory and are preserved even when the scanner is powered down.

To return all features to their default values, all you need to do is scan the **Set All Defaults** bar code.



Throughout the programming bar code menus, default values are indicated with asterisks (*).

Scanning Sequence Examples

In most cases you need only scan one bar code to set a specific parameter value. For example, if you want to set the beeper tone to high, simply scan the **High Frequency** (beeper tone) bar code listed under Beeper Tone. The scanner issues a fast warble beep and the LED turns green, signifying a successful parameter entry. Other parameters, such as specifying **Serial Response Time-Out**

or setting **Data Transmission Formats**, require that you scan several bar codes. Refer to “Laser On Time” in this chapter and “Scan Data Transmission Format” in the *Programming Reference Guide* on the software and documentation CD for descriptions of this procedure.

Errors While Scanning

Unless otherwise specified, if you make an error during a scanning sequence, just re-scan the correct parameter.

User Preferences Default Parameters

The following table lists the defaults for user preferences parameters. If you want to change any option, scan the appropriate bar code(s) provided in the “User Preferences” section of this chapter.

User Preferences Default

Parameter	Default
Set Default Parameter	All Defaults
Beeper Tone	Medium
Beeper Volume	High
Power Mode	Continuous On
Laser On Time	3.0 Sec.
Beep After Good Decode	Enable

User Preferences

Set Default Parameter

Scanning this bar code returns all parameters to the default values listed in Chapter 5, “Standard Default Parameters” of the *Programming Reference Guide* on the software and documentation CD.



Set All Defaults

Beeper Tone

To select a decode beep frequency (tone), scan the Low Frequency, Medium Frequency, or High Frequency bar code.

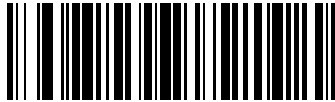

Low Frequency



***Medium Frequency
(Optimum Settings)**



High Frequency

Beeper Volume

To select a beeper volume, scan the Low Volume, Medium Volume, or High Volume bar code.



Low Volume



Medium Volume



*** High Volume**

Power Mode

This parameter determines whether or not power remains on after a decode attempt. When in reduced power mode, the scanner enters into a low power consumption mode to preserve battery life after each decode attempt. When in continuous power mode, power remains on after each decode attempt.



***Continuous On**



Reduced Power Mode

Laser On Time

This parameter sets the maximum time that decode processing continues during a scan attempt. It is programmable in 0.1 second increments from 0.5 to 9.9 seconds. The default **Laser On Time** is 3.0 seconds.

To set a Laser On Time, scan the bar code below. Next, scan two numeric bar codes in Chapter 8, “Numeric Bar Codes,” of the *Programming Reference Guide*, that correspond to the desired on time. Single digit numbers must have a leading zero. For example, to set an On Time of 0.5 seconds, scan the bar code below, then scan the “0” and “5” bar codes. If you make an error, or wish to change your selection, scan Cancel.



Laser On Time

Beep After Good Decode

Scan a bar code below to select whether or not the scanner beeps after a good decode. If **Do Not Beep After Good Decode** is selected, the beeper still operates during parameter menu scanning and indicates error conditions.

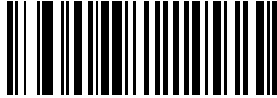

***Beep After Good Decode
(Enable)**



**Do Not Beep After Good Decode
(Disable)**

Troubleshooting

Solving Common Problems

The following table lists possible problems, the possible cause of each problem, and the recommended solutions.

Problem	Possible Cause	Solution
Nothing happens when you follow the operating instructions, or the scanner displays erratic behavior (laser does not come on, scanner emits frequent beeps).	No power to the scanner.	Check the system power.
	Interface/power cables are loose.	Check for loose cable connections.
Laser comes on, but barcode symbol does not decode.	Scanner is not programmed for the correct bar code type.	Be sure the scanner is programmed to read the type of bar code you are scanning.
	Bar code symbol is unreadable.	Check the symbol to make sure it is not defaced. Try scanning test symbols of the same bar code type.
	Distance between scanner and bar code is incorrect.	Move the scanner closer to or further from the bar code.

Problem	Possible Cause	Solution
Symbol is decoded, but not transmitted to the host.	Scanner is not programmed for the correct host type.	Scan the appropriate host type bar code.
Scanned data is incorrectly displayed on the host.	Scanner is not programmed to work with the host. Check scanner host type parameters or editing options.	<p>Be sure the USB host is selected.</p> <p>Ensure that the POS system is programmed for the correct keyboard type and language, and the Caps Lock key is in the correct state.</p> <p>Be sure editing options found in the <i>Programming Reference Guide on the Point of Sale System Software and Documentation CD</i> (e.g., ADF, UPCE to UPC-A Conversion) are properly programmed.</p>

Using the Worldwide Web

For the online access to technical support information, self-solve tools, online assistance, community forums or IT experts, broad multivendor knowledge base, monitoring and diagnostic tools, go to <http://www.hp.com/support>.

Preparing to Call Technical Support

If you can not solve a problem using the troubleshooting tips in this section, you may need to call technical support. Refer to the *Support Telephone Numbers* guide on the *Point of Sale System Software and Documentation CD*. Have the following information available when you call:

- Barcode Scanner model number
- Serial number for the scanner

- Purchase date on invoice
- Condition under which the problem occurred
- Error messages received
- Hardware configuration
- Hardware and software you are using

Technical Specifications

HP USB Barcode Scanner

Power Requirements	Decoded: 5 VDC +/- 10% @ approximately 200mA (nominal)
Stand-By Current	500mA (max)
Power Source	Depending on USB host: Hosted powered converts a 9 Volt battery to a 5 Volt battery
Decode Capability	Decoded: UPC/EAN, UPC/EAN with supplementals, UCC/EAN, JAN 8 & 13, 128, Code 39, Code 39 Full ASCII, Code 39 Trioptic, Codabar (NW7), Interleaved 2 of 5, Discrete 2 of 5, Code 128, Code 93, MSI, Code 11, UCC/EAN RSS, Code 32, Coupon Code, Bookland EAN, 1ATA, and RSS.
Beeper Operation	User-selectable: Enable, Disable
Beeper Volume	User-selectable: three levels
Beeper Tone	User-selectable: three tones
Scan Repetition Rate	100 +/- 5 scans/seconds
Yaw Tolerance	+/- 10° from nominal

HP USB Barcode Scanner

Pitch Tolerance	+/- 65 ⁰ from nominal
Roll Tolerance	+/- 60 ⁰ from nominal
Print Contrast Minimum	25% minimum reflectance differential, measure at 650 nm.
Ambient Light Immunity	
• Indoor	450 ft. candles (4,842 Lux)
• Outdoor	10,000 ft. candles (107, 600 Lux)
Durability	5 ft. (1.5 m) drops to concrete
Operating Temperature	32 ⁰ to 120 ⁰ F (0 ⁰ to 50 ⁰ C)
Storage Temperature	-40 ⁰ to 140 ⁰ F (-40 ⁰ to 60 ⁰ C)
Humidity	5% to 95% (non-condensing)
Weight (without cable)	5.15 oz. (146 g)
Dimensions:	
Weight	6.0 in (15.2 cm)
Width	2.5 in (6.3 cm)
Depth	3.34 in (8.4 cm)
Laser	650 nm laser diode
Laser Classifications	IEC 825-1 Class 2
ESD	15kV area discharge 8 kV contact discharge
Minimum Element Width	5 mil (0.127 mm)
Interfaces Supported	Decoded: USB
Electrical Safety	Certified Pending to UL1950, CSA C22.2 No. 950 EN60950/IC950

Decode Zone

Note: Typical performance at 73° F (23° C) on high quality symbols in normal room light.

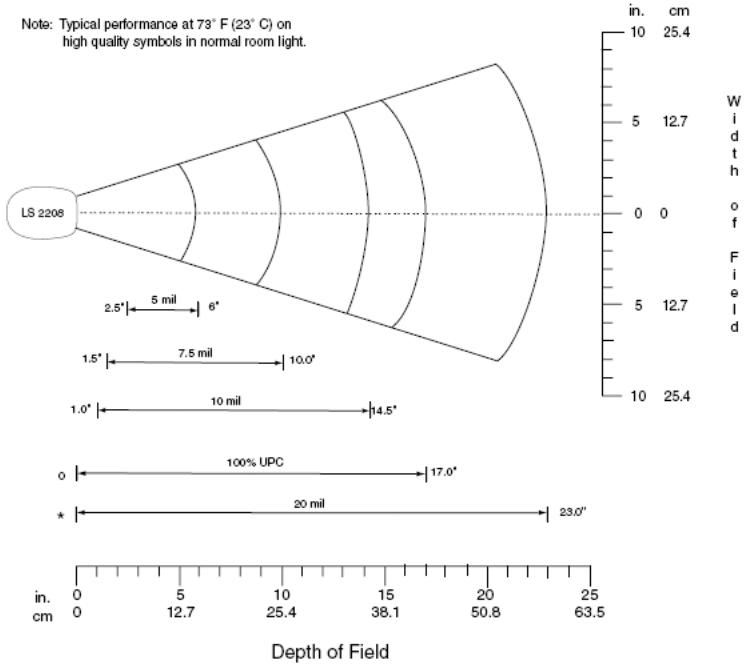

*Minimum distance determined by symbol length and scan angle

Disposal of Waste Equipment by Users in Private Household in the European Union



This symbol on the product or on its packaging indicates that this product must not be disposed of with your other household waste. Instead, it is your responsibility to dispose of your waste equipment by handing it over to a designated collection point for the recycling of waste electrical and electronic equipment. The separate collection and recycling of your waste equipment at the time of disposal will help to conserve natural resources and ensure that it is recycled in a manner that protects human health and the environment. For more information about where you can drop off your waste equipment for recycling, please contact your local city office, your household waste disposal service or the shop where you purchased the product.