

# HP Photosmart M425/M525 Digital Camera

English



## Legal and notice information

© Copyright 2006 Hewlett-Packard Development Company, L.P.

The information contained herein is subject to change without notice. The only warranties for HP products and services are set forth in the express warranty statements accompanying such products and services. Nothing herein should be construed as constituting an additional warranty. HP shall not be liable for technical or editorial errors or omissions contained herein.

Windows® is a U.S. registered trademark of Microsoft Corporation.



SD Logo is a trademark of its proprietor.

## Disposal of waste equipment by users in private households in the European Union



This symbol on the product or on its packaging indicates that this product must not be disposed of with your other household waste. Instead, it is your responsibility to dispose of your waste equipment by handing it over to a designated collection point for the recycling of waste electrical and electronic equipment. The separate collection and recycling of your waste equipment at the time of disposal will help to conserve natural resources and ensure that it is recycled in a manner that protects human health and the environment. For more information about where you can drop off your waste equipment for recycling, please contact your local city office, your household waste disposal service or the shop where you purchased the product.

**For future reference, please enter the following information:**

Model Number (on the front of the camera)	
Serial Number (10-digit number on the bottom of the camera)	
Date the camera was purchased	

English

# Contents

<b>1</b>	<b>Getting started</b> .....	5
	Viewing the electronic User Guide.....	6
	Camera top and back .....	7
	Camera front, side, and bottom.....	9
	Camera dock insert.....	9
<b>2</b>	<b>Setting up your camera</b> .....	10
	Install the batteries.....	10
	Turn on the camera.....	11
	Choose the language.....	11
	Set the region.....	11
	Set the date and time.....	11
	Install and format an optional memory card.....	12
	Install the software.....	12
<b>3</b>	<b>Taking pictures and recording video clips</b> .....	14
	Take a still picture.....	14
	Record a video clip.....	14
<b>4</b>	<b>Reviewing and deleting images and video clips</b> .....	16
	Review images and video clips.....	16
	Delete an image.....	16
<b>5</b>	<b>Transferring and printing images</b> .....	17
	Transfer images.....	17
	Print images from the camera.....	17
<b>6</b>	<b>Camera quick reference</b> .....	19

# 1 Getting started

This printed Quick Start Guide provides the information you need to get started using the essential features of your camera. For detailed information about camera features, see the electronic User Guide.

Quick Start Guide	Electronic User Guide
<p>This printed guide will help you to:</p> <ul style="list-style-type: none"><li>• Start using your camera quickly</li><li>• Install the HP Photosmart Software</li><li>• Introduce you to your camera's features</li></ul>	<p>The electronic User Guide includes:</p> <ul style="list-style-type: none"><li>• Descriptions of all the camera features</li><li>• A description of icons on the Image Display</li><li>• Using the camera without installing HP Photosmart Software</li><li>• Battery information, including:<ul style="list-style-type: none"><li>– Extending battery life</li><li>– The different battery types</li><li>– A description of the power indicator icons</li></ul></li><li>• Getting assistance from HP</li><li>• Troubleshooting</li><li>• Camera specifications</li></ul>

## Viewing the electronic User Guide



The electronic User Guide is on the HP Photosmart Software CD.

To view the User Guide:

1. Insert the HP Photosmart Software CD into the CD drive of your computer.
2. **On Windows:** Click **View User Guide** on the main page of the installation screen.  
**On Macintosh:** Open the **readme** file in the **docs** folder on the CD.

The electronic User Guide is also copied to your computer when you install the HP Photosmart Software. To view the User Guide after it has been installed on your computer:





- **On Windows:** Open the **HP Solution Center** and click on **Help and Support**.
- **On Macintosh:** Open the **HP Device Manager** and select **User Guide** from the **Information and Setting** pop-up menu.



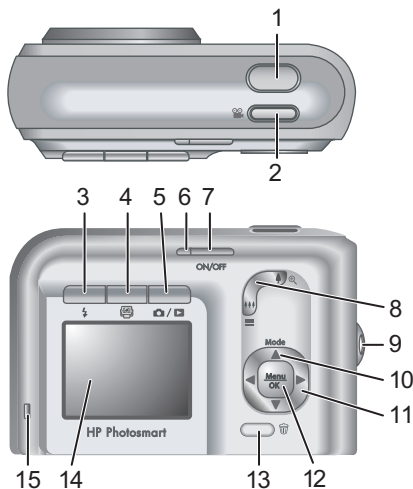





### Getting assistance

- For tips and tools to help you use your camera more effectively, visit **[www.hp.com/photosmart](http://www.hp.com/photosmart)** (English only) or **[www.hp.com](http://www.hp.com)**.
- For product assistance, diagnostics, and driver downloads 24x7, visit **[www.hp.com/support](http://www.hp.com/support)**.
- For help with the HP Photosmart Software, see the Help feature in the HP Photosmart Software.

## Camera top and back



1	<b>Shutter</b> button.
2	 <b>Video</b> button.
3	 <b>Flash</b> button—Settings are Auto, Red-Eye, Flash On, Flash Off.
4	 <b>Photosmart Express</b> button—Options are Print, Buy Prints Online, Share Setup.
5	 <b>Live View/Playback</b> button—Switches between <b>Live View</b> and <b>Playback</b> (see <i>Live View and Playback</i> on page 19).
6	Power light.
7	ON/OFF button.

8	<b>Zoom</b> lever (Digital and Optical)—In <b>Live View</b> , press  to zoom in or press  to zoom out. In <b>Playback</b> , press  to magnify the selected image or press  to view thumbnails of your images.
9	Wrist strap mount.
10	<b>Mode</b> button—Press  to access the <b>Shooting Mode</b> menu while in <b>Live View</b> . Options are Auto Mode, Self-Timer, Fast Shot, Landscape, Portrait, Action, Night Portrait, Beach and Snow, Sunset, Burst, Macro.
11	 and  buttons—Scrolls through menus and images.
12	 button—Displays camera menus, selects options, and confirms actions.
13	 <b>Delete</b> button—Accesses the <b>Delete</b> function while in <b>Playback</b> .
14	Image Display.
15	Battery Charging light.



## Camera front, side, and bottom

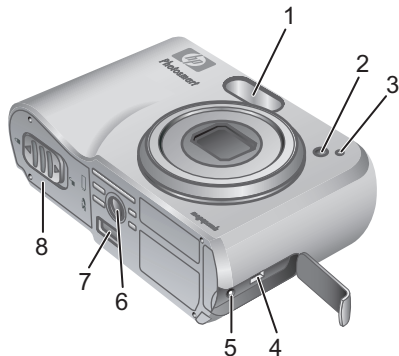

1	Flash.
2	Self-Timer light.
3	Microphone.
4	USB connector.
5	Power adapter connector.
6	Tripod mount.
7	Dock connector.
8	Battery/Memory card door.

## Camera dock insert

If you purchase an optional HP Photosmart camera dock, it will come with multiple clear inserts. When setting up the dock for use with this camera, use the dock insert with the square green tag. See the dock User Guide for instructions.

## 2 Setting up your camera

### Install the batteries

1. Open the Battery/Memory card door by sliding the door latch as indicated on the Battery/Memory card door.
2. Insert the batteries.
3. Close the Battery/Memory card door.



**Note** Turn the camera off before removing the batteries. If using rechargeable NiMH batteries, fully charge the batteries before using them the first time.



Camera usage and battery type will affect battery life. Alkaline batteries provide far less battery life than either Photo Lithium or NiMH batteries. For complete information, see Appendix A in the electronic User Guide.

#### Number of shots

Battery type	Minimum	Maximum	Average	CIPA
Alkaline	77	180	120	80
NiMH	215	380	290	205
Photo Lithium	365	600	485	423

The CIPA number is obtained using the standards established by the Camera and Imaging Products Association.

## Turn on the camera

To turn on the camera, press the ON/OFF button.

## Choose the language

Use ▲▼◀▶ to choose the language you want, then press  $\frac{\text{Menu}}{\text{OK}}$ .

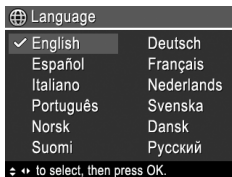

## Set the region

Along with the **Language** setting, the **Region** setting determines the default date format and the format of the video signal for displaying camera images on a television.



Use ▲▼ to choose the region you want, then press  $\frac{\text{Menu}}{\text{OK}}$ .

## Set the date and time

- Use ▲▼ to adjust the highlighted value.
- Use ◀▶ to move to the other selections and repeat Step 1 until the date and time are set correctly.
- Press  $\frac{\text{Menu}}{\text{OK}}$  when the date, time, and format settings are correct, then press  $\frac{\text{Menu}}{\text{OK}}$  again to confirm.

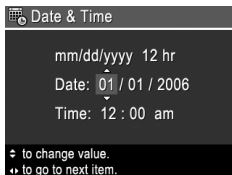

## Install and format an optional memory card

1. Turn off the camera and open the Battery/Memory card door.
2. Insert the optional memory card in the smaller slot as shown. Make sure the memory card snaps into place.
3. Close the Battery/Memory card door and turn on the camera.

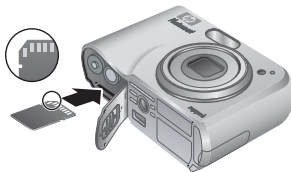

Always format memory cards before first use.

1. With the camera turned on, press / until appears briefly in the upper right corner of the Image display. This indicates you are in **Playback**.
2. Press .
3. Use to select **Format Card** from the **Delete** sub-menu, then press .
4. Use to select **Yes**, then press to format the card.

Once you install a memory card, all new images and video clips are stored on the card, rather than in internal memory.

To use internal memory and view images stored there, remove the memory card.

## Install the software

The HP Photosmart Software provides features for transferring images and video clips to your computer, as well as features for modifying stored images (remove red eyes, rotate, crop, resize, adjust image quality, add colors and special effects, and more).

If you have trouble installing or using the HP Photosmart Software, see the HP Customer Care website for more information: [www.hp.com/support](http://www.hp.com/support).

### Windows

If your Windows computer does not meet the system requirements as stated on your camera packaging, HP Photosmart Essential is installed instead of the full HP Photosmart Premier version.

1. Close all programs and temporarily disable any virus protection software.
2. Insert the HP Photosmart Software CD into the CD drive and follow the on-screen instructions. If the installation window does not appear, click **Start**, click **Run**, type **D:\Setup.exe**, where **D** is the letter of your CD drive, then click **OK**.
3. When the software has finished installing, re-enable virus protection software.



### Macintosh

1. Insert the HP Photosmart Software CD into the CD drive.
2. Double-click the CD icon on the computer desktop.
3. Double-click the installer icon, then follow the on-screen instructions.

## 3 Taking pictures and recording video clips



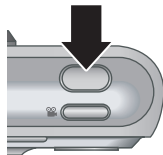

**Live View** allows you to frame pictures and video clips in the Image Display.

### Take a still picture

1. Press  /  until  appears briefly in the upper right corner of the Image Display. This indicates you are in **Live View**.
2. Frame the subject for your picture.
3. Press the **Shutter** button halfway down to measure and lock the focus and exposure. The focus brackets in the Image Display turn solid green when focus is locked.
4. Press the **Shutter** button all the way down to take the picture.
5. To add an audio clip, continue holding the **Shutter** button down, then release it when done.



## Record a video clip



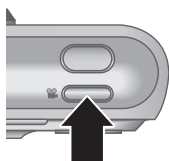

1. Press  /  until  appears briefly in the upper right corner of the Image Display. This indicates you are in **Live View**.
2. Frame the subject.
3. Press and release the **Video**  button.
4. To stop recording video, press and release the **Video**  button again.



## 4 Reviewing and deleting images and video clips











### Review images and video clips

You can review and manipulate images and video clips in **Playback**.

1. Press  /  until  appears briefly in the upper right corner of the Image Display. This indicates you are in **Playback**.
2. Use   to scroll through your images and video clips (video clips play automatically).

### Delete an image

You can delete individual images during **Playback**:

1. Press  /  until  appears briefly in the upper right corner of the Image Display. This indicates you are in **Playback**.
2. Use   to select an image or video clip.
3. Press .
4. Use   to select **This Image** from the **Delete** sub-menu, then press  .



# 5 Transferring and printing images

## Transfer images

If you have installed the HP Photosmart Software, use this method to transfer images and video clips to your computer. If you have not installed the HP Photosmart Software, see the electronic User Guide for an alternate method.

**Tip** You can also perform this task using an optional HP Photosmart camera dock (see the dock User Guide).

1. Connect the camera and computer using the USB cable that came with your camera.
2. Turn on the camera and follow the instructions on the computer screen to transfer the images.



For more information, see the Help feature in the HP Photosmart Software.

## Print images from the camera

You can connect the camera to any PictBridge-certified printer to print still images.



1. Check that the printer is turned on, there is paper in the printer, and there are no printer error messages.
2. Connect the camera and printer using the USB cable that came with your camera, then turn on the camera.
3. When the camera is connected to the printer, the **Print Setup Menu** displays on the camera. To change the settings, use ▲▼ on the camera to select a menu option, then use ◀▶ on the camera to change the setting.
4. Press  $\frac{\text{Menu}}{\text{OK}}$  to begin printing.

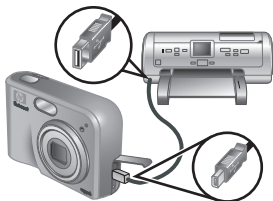

## 6 Camera quick reference

Use this chapter as a quick reference to camera features. To learn more about these camera features, refer to the electronic User Guide.

### Live View and Playback

- **Live View** allows you to frame pictures and video clips in the Image Display. To activate **Live View**, press / until appears briefly in the upper right corner of the Image Display.
- **Playback** allows you review and manipulate images and video clips. To activate **Playback**, press / until appears briefly in the upper right corner of the Image Display.

### Menus





When you press <sup>Menu</sup><sub>OK</sub> from either **Playback** or **Live View**, you access the tabbed camera menus, as shown in the example screen.



Use to move to the desired menu. Within a menu, use to move to specific selections.

To exit the menu, press / at any time.

Menus and options are:

Menu	Options
<p> <b>Capture</b> allows you to adjust camera settings that affect the characteristics of future images and video clips you capture with your camera.</p>	<ul style="list-style-type: none"> <li>• Shooting Modes (Auto Mode, Self-Timer, Fast Shot, Landscape, Portrait, Action, Night Portrait, Beach and Snow, Sunset, Burst, Macro).</li> <li>• Image Quality</li> <li>• Date &amp; Time Imprint</li> <li>• Exposure Compensation</li> <li>• White Balance</li> <li>• ISO Speed</li> </ul>
<p> <b>Design Gallery</b> allows you to enhance the images you have captured.</p>	<ul style="list-style-type: none"> <li>• Remove Red Eyes</li> <li>• Modify Color</li> <li>• Add Borders</li> <li>• Rotate</li> <li>• Record Audio</li> <li>• Move Images to Card</li> </ul>
<p> <b>Setup</b> allows you to change the camera's behavior.</p>	<ul style="list-style-type: none"> <li>• Display Brightness</li> <li>• Camera Sounds</li> <li>• Date &amp; Time</li> <li>• USB Configuration</li> <li>• TV Configuration</li> <li>• Language</li> </ul>
<p> <b>Help</b> provides descriptions of camera features and picture-taking tips.</p>	<ul style="list-style-type: none"> <li>• Top Ten Tips</li> <li>• Camera Accessories</li> <li>• Camera Buttons</li> <li>• Using Shooting Modes</li> <li>• Using Design Gallery</li> <li>• Sharing Images</li> <li>• Printing Images</li> </ul>

Menu	Options
	<ul style="list-style-type: none"><li>• Recording Audio Clips</li><li>• Recording Video Clips</li><li>• Reviewing Images and Videos</li><li>• Deleting Images</li><li>• Transferring Images</li><li>• Managing Batteries</li><li>• Getting Assistance</li><li>• Camera Shortcuts</li><li>• About...</li></ul>

When you press  from either **Live View** or **Playback**, you see the **Photosmart Express menu**.

Menu	Options
 <b>Photosmart Express</b> allows you to share your photos with friends and relatives.	<ul style="list-style-type: none"><li>• Print</li><li>• Buy Prints Online</li><li>• Share Setup</li></ul>

English

# Appareil photo numérique HP Photosmart M425/M525

Français



## Informations légales

© Copyright 2006 Hewlett-Packard Development Company, L.P.

Les informations contenues dans le présent document sont susceptibles d'être modifiées sans notification préalable. Les garanties applicables aux produits et services HP sont décrites dans les documents de garantie accompagnant ces produits et services. Aucun élément de ce document ne saurait être considéré comme une garantie supplémentaire. La société HP ne saurait être tenue pour responsable des erreurs ou omissions, techniques ou rédactionnelles, contenues dans ce document.

Windows® est une marque déposée de Microsoft Corporation aux États-Unis.



Le logo SD est une marque de son propriétaire.

## Mise au rebut du matériel usagé des particuliers au sein de l'Union européenne



La présence de ce symbole sur le produit ou sur son emballage indique qu'il ne doit pas être jeté avec les ordures ménagères. Il doit être déposé dans un point de collecte spécialisé dans le recyclage du matériel électrique et électronique. La collecte et le recyclage du matériel usagé par un réseau spécifique permettent de préserver les ressources naturelles et de protéger la santé des individus et l'environnement. Pour plus d'informations sur les points de collecte du matériel usagé et le recyclage, contactez votre mairie, votre service de ramassage des ordures ménagères ou votre distributeur.



**Notez les informations suivantes au cas où vous en auriez besoin ultérieurement :**

Numéro de modèle (figurant à l'avant de l'appareil)	
Numéro de série (numéro à 10 chiffres figurant sur le dessous de l'appareil)	
Date d'achat de l'appareil	

# Sommaire

<b>1</b>	<b>Mise en route</b> .....	5
	Consultation du Guide de l'utilisateur électronique.....	6
	Dessus et arrière de l'appareil photo.....	8
	Avant, côté et dessous de l'appareil photo.....	10
	Kit d'adaptation de la station d'accueil à l'appareil photo.....	10
<b>2</b>	<b>Installation de l'appareil photo</b> .....	12
	Installation des piles.....	12
	Mise sous tension de l'appareil photo.....	13
	Sélection de la langue.....	13
	Réglage de la région.....	13
	Réglage de la date et de l'heure.....	14
	Installation et formatage d'une carte mémoire en option.....	14
	Installation du logiciel.....	15
<b>3</b>	<b>Prise de photos et enregistrement de clips vidéo</b> .....	17
	Prise de photos.....	17
	Enregistrement de clips vidéo.....	18
<b>4</b>	<b>Visualisation et suppression d'images et de clips vidéo</b> .....	19
	Visualisation d'images et de clips vidéo.....	19
	Suppression d'une image.....	19
<b>5</b>	<b>Transfert et impression d'images</b> .....	21
	Transfert d'images.....	21
	Impression d'images à partir de l'appareil photo.....	22
<b>6</b>	<b>Aide-mémoire de l'appareil photo</b> .....	23

# 1 Mise en route

Ce Guide de démarrage rapide imprimé contient toutes les informations dont vous avez besoin pour être prêt à utiliser les fonctions essentielles de votre appareil photo. Pour plus d'informations sur les fonctions de cet appareil, reportez-vous au Guide de l'utilisateur électronique.

<b>Guide de démarrage rapide</b>	<b>Guide de l'utilisateur électronique</b>
Ce guide imprimé vous aidera à : <ul style="list-style-type: none"><li>• Être rapidement prêt à utiliser votre appareil photo</li><li>• Installer le logiciel HP Photosmart</li><li>• Connaître de façon générale les fonctions de votre appareil photo</li></ul>	Le Guide de l'utilisateur électronique comprend : <ul style="list-style-type: none"><li>• Une description de l'ensemble des fonctions de l'appareil photo</li><li>• Une description des icônes affichées sur l'écran</li><li>• La procédure d'utilisation de l'appareil photo sans installation préalable du logiciel HP Photosmart</li></ul>

- Des informations sur les piles, y compris :
  - L'extension de la durée de vie des piles
  - Les différents types de pile pris en charge
  - Une description des icônes d'indication de charge
- Des informations sur l'accès au support HP
- Des informations de dépannage
- Les spécifications de l'appareil photo

## Consultation du Guide de l'utilisateur électronique



Le Guide de l'utilisateur électronique est disponible sur le CD du logiciel HP Photosmart.

Pour consulter le Guide de l'utilisateur :

1. Insérez le CD du logiciel HP Photosmart dans le lecteur de CD de votre ordinateur.
2. **Windows** : cliquez sur **Consulter le Guide de l'utilisateur** sur la page principale de l'écran d'installation.  
**Macintosh** : ouvrez le fichier **readme** contenu dans le dossier **docs** du CD.

Le Guide de l'utilisateur électronique est également copié sur votre ordinateur lors de l'installation du logiciel HP Photosmart. Pour le consulter après son installation sur l'ordinateur :

- **Windows** : ouvrez le **Centre de solutions HP** et cliquez sur **Aide et support**.
- **Macintosh** : ouvrez le **Gestionnaire de périphériques HP** et sélectionnez **Guide de l'utilisateur** dans le menu contextuel **Informations et réglage**.





#### **Accès au support**

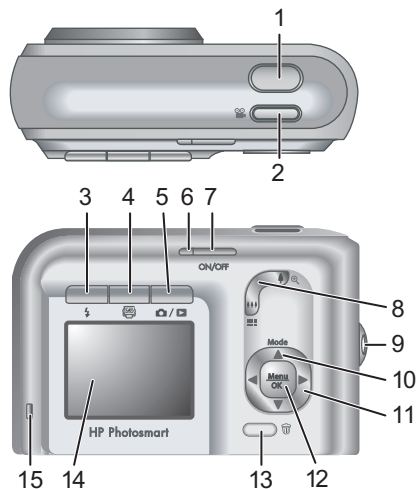









- Pour obtenir des conseils et des outils permettant d'optimiser l'utilisation de votre appareil photo, consultez le site **www.hp.com/photosmart** (en anglais uniquement) ou le site **www.hp.com**.
- Pour obtenir de l'aide sur un produit, établir un diagnostic et télécharger des pilotes 24h/24 7j/7, consultez le site **www.hp.com/support**.
- Pour obtenir de l'aide sur le logiciel HP Photosmart, utilisez la fonction correspondante du logiciel HP Photosmart.

## Dessus et arrière de l'appareil photo



Français

1	Bouton <b>Déclencheur</b> .
2	 Bouton <b>Vidéo</b> .
3	 Bouton <b>Flash</b> : les réglages possibles sont Flash auto, Anti-yeux rouges, Flash activé et Flash désactivé.
4	 Bouton <b>Photosmart Express</b> : les options possibles sont Imprimer, Commander des tirages en ligne et Config Partage.
5	 Bouton <b>Prévisualisation/Lecture</b> : bascule entre les modes <b>Prévisualisation</b> et <b>Lecture</b> (reportez-vous à la section <i>Prévisualisation et Lecture</i> , page 23).
6	Voyant d'alimentation.

7	Bouton ON/OFF.
8	Bouton <b>Zoom</b> (numérique et optique) : en mode <b>Prévisualisation</b> , appuyez respectivement sur  ou  pour faire un zoom avant ou un zoom arrière. En mode <b>Lecture</b> , appuyez sur le bouton  pour agrandir l'image sélectionnée ou sur le bouton  pour afficher des vues miniatures de vos images.
9	Attache-sangle.
10	Bouton <b>Mode</b> : appuyez sur la touche  pour accéder au menu <b>Mode de prise de vue</b> à partir du mode <b>Prévisualisation</b> . Les options possibles sont Mode Auto, Retardateur, Déclenchement rapide, Paysage, Portrait, Action, Portrait nuit, Plage/Neige, Coucher de soleil, Rafale et Macro.
11	Touches   et   : permettent de naviguer dans les menus et les images.
12	Bouton  : permet d'afficher les menus de l'appareil photo, de sélectionner les options et de valider les opérations.
13	 Bouton <b>Supprimer</b> : permet d'accéder à la fonction <b>Supprimer</b> à partir du mode <b>Lecture</b> .
14	Écran.
15	Voyant de chargement des piles.

## Avant, côté et dessous de l'appareil photo

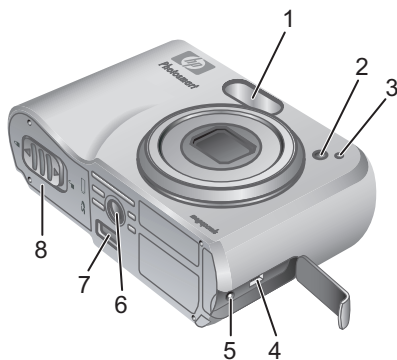

Français

1	Flash.
2	Voyant du retardateur.
3	Micro.
4	Connecteur USB.
5	Connecteur pour adaptateur secteur.
6	Filetage pour trépied.
7	Connecteur pour station d'accueil.
8	Volet du compartiment des piles/de la carte mémoire.



## **Kit d'adaptation de la station d'accueil à l'appareil photo**

Toute station d'accueil pour appareil photo HP Photosmart achetée en option est fournie avec plusieurs kits d'adaptation. Pour installer la station d'accueil sur cet appareil photo, utilisez le kit d'adaptation comportant l'étiquette verte carrée. Reportez-vous au Guide de l'utilisateur de la station d'accueil pour obtenir des instructions.

Français

## 2 Installation de l'appareil photo

### Installation des piles

1. Ouvrez le volet du compartiment des piles/de la carte mémoire en faisant glisser le loquet correspondant comme indiqué sur le volet.
2. Insérez les piles.
3. Refermez le volet du compartiment des piles/de la carte mémoire.



**Remarque** Mettez l'appareil photo hors tension avant d'enlever les piles. Si vous utilisez des piles rechargeables NiMH, chargez-les complètement avant de les utiliser pour la première fois.



La durée de vie des piles dépendra de l'utilisation de l'appareil photo et du type de pile utilisé. Les piles alcalines durent moins longtemps que les piles photo lithium ou NiMH. Pour plus d'informations, consultez l'Annexe A du Guide de l'utilisateur électronique.

#### Nombre de photos

Type de pile	Minimum	Maximum	Moyenne	CIPA
Alcaline	77	180	120	80

NiMH	<b>215</b>	<b>380</b>	<b>290</b>	<b>205</b>
Photo lithium	<b>365</b>	<b>600</b>	<b>485</b>	<b>423</b>

Les normes établies par la Camera and Imaging Products Association (CIPA) permettent d'établir le numéro CIPA.

## Mise sous tension de l'appareil photo

Pour mettre l'appareil photo sous tension, appuyez sur le bouton ON/OFF.

## Sélection de la langue

Utilisez les touches ▲▼ et ◀▶ pour sélectionner la langue, puis appuyez sur le bouton  $\frac{\text{Menu}}{\text{OK}}$ .

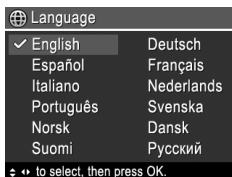

## Réglage de la région

Associé au paramètre **Langue**, le paramètre **Région** détermine le format de date par défaut et le format du signal vidéo pour l'affichage des images de l'appareil photo sur un téléviseur.

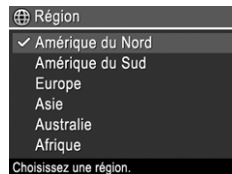

Utilisez les touches ▲▼ pour sélectionner la région, puis appuyez sur le bouton  $\frac{\text{Menu}}{\text{OK}}$ .

## Réglage de la date et de l'heure

1. Utilisez les touches ▲▼ pour régler la valeur sélectionnée.
2. Utilisez les touches ◀▶ pour passer aux autres sélections et répétez l'étape 1 jusqu'à ce que la date et l'heure soient correctes.
3. Appuyez sur le bouton  $\text{Menu}$ / $\text{OK}$  une fois que la date, l'heure et le format sont corrects, puis à nouveau sur le bouton  $\text{Menu}$ / $\text{OK}$  pour valider l'opération.

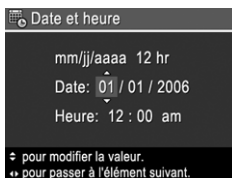





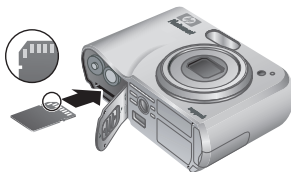





## Installation et formatage d'une carte mémoire en option

1. Mettez l'appareil photo hors tension et ouvrez le volet du compartiment des piles/de la carte mémoire.
2. Insérez la carte mémoire en option dans le logement le plus petit. Vérifiez que la carte mémoire est bien positionnée.
3. Fermez le volet du compartiment des piles/de la carte mémoire, puis mettez l'appareil photo sous tension.



Formatez toujours les cartes mémoire avant leur première utilisation.

1. Après avoir mis l'appareil photo hors tension, appuyez sur le bouton  /  jusqu'à ce que l'icône  apparaisse brièvement dans le coin supérieur droit de l'écran. Cela indique que vous êtes en mode **Lecture**.
2. Appuyez sur le bouton .
3. Utilisez les touches   pour sélectionner l'option **Formater la carte** du sous-menu **Supprimer**, puis appuyez sur le bouton .
4. Utilisez les touches   pour sélectionner **Oui**, puis appuyez sur le bouton .

Lorsque vous installez une carte mémoire, les photos et les clips vidéo sont enregistrés sur cette carte et non dans la mémoire interne.

Pour utiliser la mémoire interne et visionner les images qui y sont stockées, retirez la carte mémoire.

## Installation du logiciel

Le logiciel HP Photosmart permet de transférer vos photos et vos clips vidéo vers votre ordinateur, mais aussi de modifier les images stockées (élimination de l'effet yeux rouges, rotation, rognage, redimensionnement, réglage de la qualité, ajout de couleurs et d'effets spéciaux, etc.).

Si vous avez des difficultés à installer ou à utiliser le logiciel HP Photosmart, consultez le site Web du service client HP pour obtenir des informations complémentaires : **[www.hp.com/support](http://www.hp.com/support)**.

## Windows

Si votre ordinateur Windows ne répond pas aux critères de configuration requis, comme indiqué sur l'emballage de votre appareil photo, le programme installe HP Photosmart Essential au lieu de la version complète HP Photosmart Premier.

1. Fermez tous les programmes et désactivez temporairement tout programme de protection antivirus.
2. Insérez le CD du logiciel HP Photosmart dans votre lecteur de CD et suivez les instructions qui apparaissent à l'écran. Si la fenêtre d'installation n'apparaît pas, cliquez sur **Démarrer**, puis sur **Exécuter** et tapez **D:\Setup.exe** (où **D** correspond à la lettre désignant votre lecteur de CD). Cliquez ensuite sur **OK**.
3. Une fois le logiciel installé, réactivez votre protection antivirus.



## Macintosh

1. Insérez le CD du logiciel HP Photosmart dans votre lecteur de CD.
2. Double-cliquez sur l'icône du CD située sur le bureau.
3. Double-cliquez sur l'icône du programme d'installation et suivez les instructions qui s'affichent à l'écran.

# 3 Prise de photos et enregistrement de clips vidéo



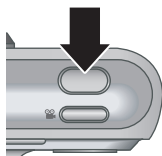

La fonction **Prévisualisation** permet de cadrer vos photos et vos clips vidéo à l'écran.

## Prise de photos

1. Appuyez sur le bouton  /  jusqu'à ce que l'icône  apparaisse brièvement dans le coin supérieur droit de l'écran. Cela indique que vous êtes en mode **Prévisualisation**.
2. Cadrez le sujet de votre photo.
3. Appuyez sur le bouton **Déclencheur** jusqu'à mi-course pour mesurer et verrouiller la mise au point et l'exposition. Les crochets de mise au point de l'écran deviennent verts en continu une fois la mise au point verrouillée.
4. Appuyez à fond sur le bouton **Déclencheur** pour prendre la photo.
5. Pour ajouter un commentaire audio, continuez à maintenir le bouton **Déclencheur** enfoncé, puis relâchez-le une fois que vous avez terminé.

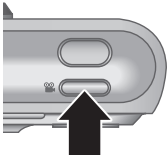

## Enregistrement de clips vidéo



1. Appuyez sur le bouton  /  jusqu'à ce que l'icône  apparaisse brièvement dans le coin supérieur droit de l'écran. Cela indique que vous êtes en mode **Prévisualisation**.
- 
2. Cadrez le sujet.
  3. Appuyez sur le bouton **Vidéo** , puis relâchez-le.
  4. Pour arrêter l'enregistrement vidéo, appuyez une nouvelle fois sur le bouton **Vidéo** , puis relâchez-le.



# 4 Visualisation et suppression d'images et de clips vidéo





## Visualisation d'images et de clips vidéo

Vous pouvez revoir et manipuler les images et les clips vidéo en mode **Lecture**.

1. Appuyez sur le bouton  /  jusqu'à ce que l'icône  apparaisse brièvement dans le coin supérieur droit de l'écran. Cela indique que vous êtes en mode **Lecture**.
2. Utilisez les touches ◀▶ pour parcourir vos images et clips vidéo (ceux-ci étant lus automatiquement).

## Suppression d'une image

Vous pouvez supprimer des images données en mode **Lecture** :

1. Appuyez sur le bouton  /  jusqu'à ce que l'icône  apparaisse brièvement dans le coin supérieur droit de l'écran. Cela indique que vous êtes en mode **Lecture**.
2. Utilisez les touches ◀▶ pour sélectionner une image ou un clip vidéo.
3. Appuyez sur le bouton .
4. Utilisez les touches ▲▼ pour sélectionner l'option **Cette image** du sous-menu **Supprimer**, puis appuyez sur le bouton .

# 5 Transfert et impression d'images

## Transfert d'images

Si vous avez installé le logiciel HP Photosmart, utilisez-le pour transférer vos images et vos clips vidéo vers votre ordinateur. Si ce n'est pas le cas, reportez-vous au Guide de l'utilisateur électronique pour choisir une autre méthode.

**Conseil** Vous pouvez également exécuter cette opération en utilisant une station d'accueil pour appareil photo HP Photosmart en option (reportez-vous au Guide de l'utilisateur de la station d'accueil).

1. Connectez l'appareil photo à l'ordinateur à l'aide du câble USB livré avec votre appareil photo.
2. Mettez l'appareil photo sous tension et suivez les instructions qui apparaissent à l'écran de votre ordinateur pour transférer les images. Pour plus d'informations, reportez-vous à l'aide du logiciel HP Photosmart.



## Impression d'images à partir de l'appareil photo

Vous pouvez connecter l'appareil photo à une imprimante compatible PictBridge pour imprimer des photos.





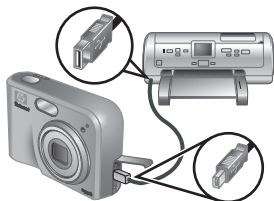



1. Vérifiez que l'imprimante est sous tension, qu'elle contient du papier et qu'aucun message d'erreur ne s'affiche.
2. Connectez l'appareil photo à l'imprimante à l'aide du câble USB livré avec votre appareil photo, puis mettez l'appareil photo sous tension.
3. Lorsque l'appareil photo est connecté à l'imprimante, le **Menu Config. d'impression** s'affiche sur l'appareil. Pour modifier les paramètres, utilisez les touches ▲▼ de l'appareil photo pour sélectionner une option de menu, puis les touches ◀▶ pour changer son paramètre.
4. Appuyez sur le bouton  pour commencer l'impression.



# 6 Aide-mémoire de l'appareil photo

Utilisez ce chapitre comme un aide-mémoire des fonctions de l'appareil photo. Pour en savoir plus sur ces fonctions, reportez-vous au Guide de l'utilisateur électronique.

## Prévisualisation et Lecture



- La fonction **Prévisualisation** permet de cadrer vos photos et vos clips vidéo à l'écran. Pour l'activer, appuyez sur le bouton  /  jusqu'à ce que l'icône  apparaisse brièvement dans le coin supérieur droit de l'écran.
- La fonction **Lecture** permet de revoir et de manipuler les images et les clips vidéo. Pour l'activer, appuyez sur le bouton  /  jusqu'à ce que l'icône  apparaisse brièvement dans le coin supérieur droit de l'écran.

## Menus



En appuyant sur le bouton  à partir du mode **Lecture** ou le mode **Prévisualisation**, vous avez accès aux menus sous forme d'onglet de l'appareil photo présentés dans l'exemple d'écran ci-contre.





Utilisez les touches ◀▶ pour sélectionner le menu de votre choix. Dans un menu, utilisez les touches ▲▼ pour sélectionner des paramètres spécifiques.

Pour quitter ce menu, appuyez sur le bouton  /  à tout moment.

Les menus et options disponibles sont les suivants :

Menu	Options
Le menu  <b>Capture</b> permet de régler les paramètres de l'appareil photo qui affectent les caractéristiques des futures photos et clips vidéo pris avec votre appareil photo.	<ul style="list-style-type: none"> <li>• Modes de prise de vue (Mode Auto, Retardateur, Déclenchement rapide, Paysage, Portrait, Action, Portrait nuit, Plage/ Neige, Coucher de soleil, Rafale et Macro).</li> <li>• Qualité d'image</li> <li>• Inclure date/heure</li> <li>• Compens. exposition</li> <li>• Balance des blancs</li> <li>• Sensibilité ISO</li> </ul>
Le menu  <b>Galerie créative</b> permet d'améliorer les images capturées.	<ul style="list-style-type: none"> <li>• Correction yeux rouges</li> <li>• Modifier couleur</li> <li>• Ajout bordures</li> <li>• Rotation</li> <li>• Commentaire audio</li> <li>• Dépl. images sur carte</li> </ul>

Menu	Options
Le menu  <b>Configuration</b> permet de modifier le comportement de l'appareil photo.	<ul style="list-style-type: none"> <li>● Luminosité écran</li> <li>● Sons de l'appareil</li> <li>● Date et heure</li> <li>● Configuration USB</li> <li>● Configuration TV</li> <li>● Langue</li> </ul>
Le menu  <b>Aide</b> décrit les fonctions de l'appareil photo et fournit des conseils sur la prise de photos.	<ul style="list-style-type: none"> <li>● 10 conseils</li> <li>● Accessoires de l'appareil</li> <li>● Boutons de l'appareil</li> <li>● Modes de prise de vue</li> <li>● Utilisation de la Galerie créative</li> <li>● Partage d'images</li> <li>● Impression d'images</li> <li>● Enreg. comment. audio</li> <li>● Enreg. de clips vidéo</li> <li>● Visual. images et vidéos</li> <li>● Suppression d'images</li> <li>● Transfert d'images</li> <li>● Gestion des batteries</li> <li>● Obtenir de l'assistance</li> <li>● Raccourcis de l'appareil</li> <li>● A propos de...</li> </ul>

Lorsque vous appuyez sur le bouton  à partir du mode **Prévisualisation** ou **Lecture**, le menu **Photosmart Express** s'affiche.

Menu	Options
Le menu  <b>Photosmart Express</b> permet de partager des photos avec vos amis et votre famille.	<ul style="list-style-type: none"><li data-bbox="522 315 656 337">• Imprimer</li><li data-bbox="522 344 812 394">• Commander des tirages en ligne</li><li data-bbox="522 401 718 422">• Config Partage</li></ul>



# Fotocamera digitale HP Photosmart M425/ M525

Italiano



## Informazioni legali e di avviso

© Copyright 2006 Hewlett-Packard Development Company, L.P.

Le informazioni contenute in questo documento sono soggette a modifica senza preavviso. Le uniche garanzie per i prodotti e i servizi HP sono definite nelle dichiarazioni di garanzia esplicita che accompagnano tali prodotti e servizi. Nulla di quanto dichiarato nel presente documento costituisce una garanzia aggiuntiva. HP non sarà ritenuta responsabile di eventuali omissioni o errori tecnici o editoriali qui contenuti.

Windows® è un marchio registrato di Microsoft Corporation negli Stati Uniti.



Il logo SD è un marchio del rispettivo titolare.

## Smaltimento di apparecchiature dismesse da parte di utenti in abitazioni private nell'Unione Europea.



Questo simbolo sul prodotto o sulla sua confezione segnala che questo prodotto non deve essere smaltito insieme agli altri rifiuti domestici. È responsabilità dell'utente smaltire le apparecchiature dismesse consegnandole al punto di raccolta designato per il riciclaggio dei rifiuti elettrici o elettronici. La raccolta differenziata e il riciclaggio degli apparecchi dismessi servirà a preservare le risorse naturali e a garantire che siano riciclati in modo da salvaguardare la salute delle persone e l'ambiente. Per ulteriori informazioni su dove depositare le apparecchiature per il riciclaggio, contattare gli enti della propria città, il proprio servizio di raccolta rifiuti urbani oppure il punto vendita presso il quale è stato acquistato il prodotto.

**Per riferimento futuro, inserire le seguenti informazioni:**

Numero del modello (situato nella parte anteriore della fotocamera)	
Numero di serie (numero di 10 cifre situato nella parte inferiore della fotocamera)	
Data in cui è stata acquistata la fotocamera	

# Sommario

<b>1</b>	<b>Informazioni preliminari</b> .....	5
	Visualizzazione della Guida d'uso elettronica.....	6
	Vista posteriore e dall'alto della fotocamera.....	7
	Viste anteriore, laterale e inferiore della fotocamera.....	9
	Inserto dell'alloggiamento della fotocamera.....	9
<b>2</b>	<b>Configurazione della fotocamera</b> .....	11
	Installazione delle batterie.....	11
	Accensione della fotocamera.....	12
	Scelta della lingua.....	12
	Configurazione della regione.....	12
	Configurazione della data e dell'ora.....	13
	Installazione e formattazione di una scheda di memoria opzionale.....	13
	Installazione del software.....	14
<b>3</b>	<b>Foto e videoclip</b> .....	16
	Scatto di una foto.....	16
	Registrazione di un videoclip.....	16
<b>4</b>	<b>Revisione ed eliminazione di immagini e videoclip</b> .....	18
	Revisione di immagini e videoclip.....	18
	Eliminazione di un'immagine.....	18
<b>5</b>	<b>Trasferimento e stampa di immagini</b> .....	19
	Trasferimento di immagini.....	19
	Stampa di immagini dalla fotocamera.....	20
<b>6</b>	<b>Riferimento rapido della fotocamera</b> .....	21

# 1 Informazioni preliminari

La copia cartacea di questa Guida rapida fornisce le informazioni necessarie per iniziare a utilizzare le funzioni essenziali della fotocamera. Per informazioni dettagliate sulle funzioni della fotocamera, vedere la Guida d'uso elettronica della fotocamera.

<b>Guida rapida</b>	<b>Guida d'uso elettronica</b>
<p>La copia cartacea di questa guida consente di:</p> <ul style="list-style-type: none"><li>● Iniziare a utilizzare rapidamente la fotocamera</li><li>● Installare il software HP Photosmart</li><li>● Iniziare a conoscere le funzioni della fotocamera</li></ul>	<p>La Guida d'uso elettronica comprende:</p> <ul style="list-style-type: none"><li>● Descrizioni di tutte le funzioni della fotocamera</li><li>● Descrizione delle icone sul display LCD</li><li>● Uso della fotocamera senza installare il software HP Photosmart</li><li>● Informazioni sulle batterie, tra cui:<ul style="list-style-type: none"><li>– Prolungamento della durata della batteria</li><li>– I diversi tipi di batterie</li><li>– Descrizione delle icone di indicazione dell'alimentazione</li></ul></li><li>● Assistenza da HP</li><li>● Risoluzione dei problemi</li><li>● Specifiche della fotocamera</li></ul>

## Visualizzazione della Guida d'uso elettronica



La Guida d'uso elettronica si trova sul CD del software HP Photosmart.

Per visualizzare la Guida d'uso:

1. Inserire il CD del software HP Photosmart nell'unità CD del computer.
2. **In Windows:** Fare clic su **View User Guide** (Visualizza la Guida d'uso) nella pagina principale della schermata di installazione.  
**In Macintosh:** Aprire il file **Readme** nella cartella **docs** del CD.

La Guida d'uso elettronica viene anche copiata sul computer quando si installa il software HP Photosmart. Per visualizzare la Guida d'uso dopo che è stata installata sul computer:

- **In Windows:** Aprire **Centro soluzioni HP** e fare clic su **Help and Support** (Guida e assistenza).
- **In Macintosh:** Aprire **HP Device Manager** (Gestione dispositivi HP) e selezionare **Guida d'uso** dal menu a comparsa **Information and Setting** (Informazioni e impostazioni).





### Assistenza



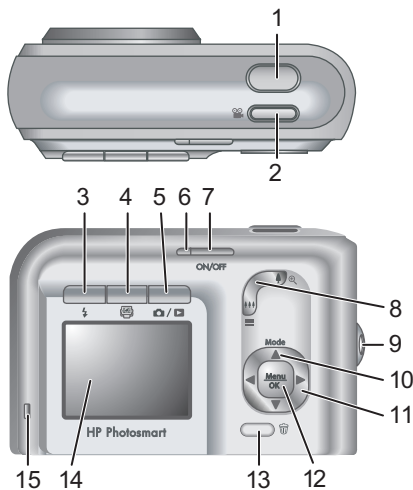









- Per suggerimenti e strumenti che aiutino a utilizzare la fotocamera in modo più efficiente, visitare il sito **[www.hp.com/photosmart](http://www.hp.com/photosmart)** (solo inglese) o **[www.hp.com](http://www.hp.com)**.
- Per assistenza per i prodotti, diagnostica e download di driver, disponibili 24 ore su 24, 7 giorni su 7, visitare il sito **[www.hp.com/support](http://www.hp.com/support)**.

- Per assistenza con il software HP Photosmart, vedere la funzione della guida nel software stesso.

## Vista posteriore e dall'alto della fotocamera



1	Pulsante <b>Otturatore</b> .
2	 Pulsante <b>Video</b> .
3	 Pulsante <b>Flash</b> : le impostazioni sono Auto Flash, Occhi rossi, Flash On, Flash Off.
4	 Pulsante <b>Photosmart Express</b> : le opzioni sono Stampa, Acquisto stampe online, Config. Condividi.
5	 Pulsante <b>Vista dal vivo/Riproduzione</b> : alterna <b>Vista dal vivo</b> e <b>Riproduzione</b> (vedere <i>Vista dal vivo</i> e <i>Riproduzione</i> a pagina 21).

6	Spia di accensione.
7	Pulsante ON/OFF.
8	Leva <b>Zoom</b> (digitale e ottico): in modalità <b>Vista dal vivo</b> , premere  per ingrandire o    per rimpicciolire. In modalità <b>Riproduzione</b> , premere il pulsante  per ingrandire l'immagine selezionata oppure premere il pulsante  per visualizzare le anteprime delle immagini.
9	Attacco della cinghietta da polso.
10	Pulsante <b>Modalità</b> : premere il pulsante  per accedere al menu <b>Mod. scatto</b> mentre si è in modalità <b>Vista dal vivo</b> . Le opzioni sono Mod. automatica, Autoscatto, Scatto veloce, Panorama, Ritratto, Azione, Ritratto notturno, Spiaggia e neve, Tramonto, Scatto continuo, Macro.
11	Pulsanti   e   : consentono di scorrere tra i menu e le immagini.
12	Pulsante  : consente di visualizzare i menu della fotocamera, selezionare le opzioni e confermare le azioni.
13	Pulsante  <b>Elimina</b> : consente di accedere alla funzione <b>Elimina</b> quando si è in modalità <b>Riproduzione</b> .
14	Display LCD.
15	Spia di ricarica delle batterie.



## Viste anteriore, laterale e inferiore della fotocamera

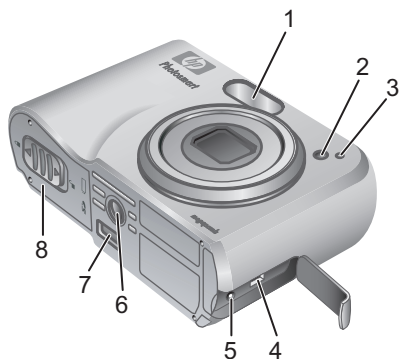

1	Flash.
2	Spia dell'autoscatto.
3	Microfono.
4	Connettore USB.
5	Connettore dell'adattatore di corrente.
6	Attacco treppiede.
7	Connettore alloggiamento.
8	Sportello del vano batteria/scheda di memoria.

## **Inserto dell'alloggiamento della fotocamera**

Se si acquista un alloggiamento opzionale della fotocamera HP Photosmart, saranno forniti anche più inserti trasparenti. Quando si configura l'alloggiamento per l'uso con questa fotocamera, utilizzare l'inserto dell'alloggiamento con la linguetta verde quadrata. Per istruzioni, vedere la Guida d'uso dell'alloggiamento.

## 2 Configurazione della fotocamera

### Installazione delle batterie

1. Aprire lo sportello del vano batteria/scheda di memoria facendo scorrere il fermo dello sportello, come indicato sullo sportello stesso.
2. Inserire le batterie.
3. Chiudere lo sportello del vano batteria/scheda di memoria.



**Nota** Spegnerne la fotocamera prima di rimuovere le batterie. Se si utilizzano batterie ricaricabili al nichel (NiMH), caricarle completamente prima di utilizzarle per la prima volta.



La durata delle batterie dipende dall'utilizzo della fotocamera e dal tipo di batterie.

Le batterie alcaline consentono una durata molto inferiore alle batterie fotografiche al litio o al nichel (NiMH). Per informazioni complete, vedere l'Appendice A della Guida d'uso elettronica.

#### Numero di scatti

Tipo di batterie	Minimo	Massimo	Media	CIPA
Alcaline	77	180	120	80

Nichel (NiMH)	215	380	290	205
Fotografiche al litio	365	600	485	423

Il numero CIPA si ottiene utilizzando gli standard definiti dalla Camera and Imaging Products Association.

## Accensione della fotocamera

Per accendere la fotocamera, premere il pulsante ON/OFF.

## Scelta della lingua

Per scegliere la lingua desiderata, utilizzare i pulsanti ▲▼◀▶, quindi premere il pulsante <sup>Menu</sup>OK.

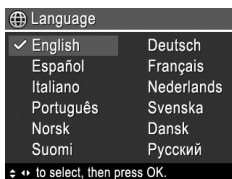

## Configurazione della regione

Insieme alla configurazione della **Lingua**, la configurazione della **Regione** determina il formato data predefinito e il formato del segnale video per la visualizzazione delle immagini della fotocamera su un televisore.



Per scegliere la regione desiderata, premere i pulsanti ▲▼, quindi premere il pulsante <sup>Menu</sup>OK.

## Configurazione della data e dell'ora

1. Per regolare il valore evidenziato, utilizzare i pulsanti ▲▼.
2. Per spostarsi sulle altre selezioni, utilizzare i pulsanti ◀▶ e ripetere il passaggio 1 fino a quando la data e l'ora configurate sono corrette.
3. Quando le impostazioni di data, ora e formato sono corrette, premere il pulsante  $\frac{\text{Menu}}{\text{OK}}$ , quindi premere nuovamente il pulsante  $\frac{\text{Menu}}{\text{OK}}$  per confermare.

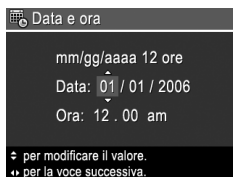





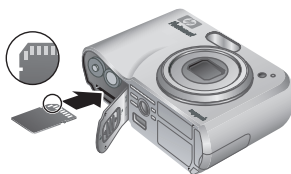





## Installazione e formattazione di una scheda di memoria opzionale

1. Spegnerla la fotocamera e aprire lo sportello del vano batteria/scheda di memoria.
2. Inserire la scheda di memoria opzionale nell'alloggiamento più piccolo, come indicato. Accertarsi che la scheda di memoria scatti in posizione.
3. Chiudere lo sportello del vano batteria/scheda di memoria e accendere la fotocamera.



Italiano

Formattare sempre le schede di memoria prima del primo utilizzo.

1. Con la fotocamera accesa, premere il pulsante  /  fino a quando il pulsante  viene visualizzato brevemente nell'angolo in alto a destra del display LDC. Ciò indica che è attiva la modalità **Riproduzione**.
2. Premere il pulsante .
3. Per selezionare **Formatta scheda** dal sottomenu **Elimina**, utilizzare i pulsanti  , quindi premere il pulsante .
4. Per selezionare **Sì**, utilizzare i pulsanti  , quindi premere il pulsante  per formattare la scheda.

Una volta installata una scheda di memoria, tutte le nuove immagini e i videoclip vengono memorizzati sulla scheda anziché nella memoria interna.

Per utilizzare la memoria interna e visualizzare le immagini ivi memorizzate, rimuovere la scheda di memoria.

## Installazione del software

Il software HP Photosmart fornisce le funzioni per trasferire immagini e videoclip nel computer, nonché le funzioni per modificare le immagini memorizzate (eliminare gli occhi rossi, ruotare, ritagliare, ridimensionare, regolare la qualità dell'immagine, aggiungere colori ed effetti speciali e altro ancora).

In caso di problemi durante l'installazione o l'uso del software HP Photosmart, visitare il sito Web per l'assistenza clienti HP per ottenere ulteriori informazioni: [www.hp.com/support](http://www.hp.com/support).

## Windows

Se il computer Windows non soddisfa i requisiti di sistema indicati sulla confezione della fotocamera, viene installato HP Photosmart Essential invece della versione completa HP Photosmart Premier.

1. Chiudere tutti i programmi e disattivare temporaneamente il software antivirus.
2. Inserire il CD del software HP Photosmart nell'unità CD e seguire le istruzioni visualizzate sullo schermo. Se non viene visualizzata la finestra di installazione, fare clic su **Start, Esegui**, digitare **D:\Setup.exe**, dove **D** è la lettera dell'unità CD, quindi fare clic su **OK**.
3. Al termine dell'installazione del software, riattivare il software antivirus.

## Macintosh

1. Inserire il CD del software HP Photosmart nell'unità CD.
2. Fare doppio clic sull'icona del CD sulla scrivania del computer.
3. Fare doppio clic sull'icona del programma di installazione, quindi seguire le istruzioni visualizzate sullo schermo.

## 3 Foto e videoclip

La modalità **Vista dal vivo** consente di inquadrare foto e videoclip nel display LCD.



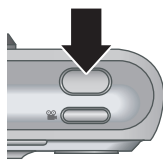

### Scatto di una foto

1. Premere il pulsante  /  fino a quando l'icona  viene visualizzata brevemente nell'angolo in alto a destra del display LCD. Ciò indica che è attiva la modalità **Vista dal vivo**.
2. Inquadrare il soggetto della foto.
3. Premere a metà il pulsante **Otturatore** per misurare e bloccare la messa a fuoco e l'esposizione. Il quadro di messa a fuoco sul display LCD diventa verde fisso quando la messa a fuoco è bloccata.
4. Per scattare la foto, premere completamente il pulsante **Otturatore**.
5. Per aggiungere l'audio, continuare a tenere premuto il pulsante **Otturatore**. Rilasciarlo al termine della registrazione.





## Registrazione di un videoclip



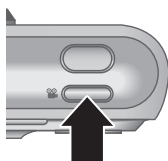

1. Premere il pulsante  /  fino a quando l'icona  viene visualizzata brevemente nell'angolo in alto a destra del display LCD. Ciò indica che è attiva la modalità **Vista dal vivo**.
2. Inquadrare il soggetto.
3. Premere e rilasciare il pulsante **Video** .
4. Per interrompere la registrazione del video, premere e rilasciare nuovamente il pulsante **Video** .



## 4 Revisione ed eliminazione di immagini e videoclip









### Revisione di immagini e videoclip

In modalità **Riproduzione** è possibile rivedere e modificare le immagini e i videoclip.

1. Premere il pulsante  /  fino a quando l'icona  viene visualizzata brevemente nell'angolo in alto a destra del display LCD. Ciò indica che è attiva la modalità **Riproduzione**.
2. Per scorrere tra le immagini e i videoclip, utilizzare i pulsanti   (i videoclip vengono riprodotti automaticamente).

### Eliminazione di un'immagine

In modalità **Riproduzione** è possibile eliminare singole immagini:

1. Premere il pulsante  /  fino a quando l'icona  viene visualizzata brevemente nell'angolo in alto a destra del display LCD. Ciò indica che è attiva la modalità **Riproduzione**.
2. Per selezionare un'immagine o un videoclip, utilizzare l'icona  .
3. Premere il pulsante .
4. Per selezionare **Corrente** dal sottomenu **Elimina**, utilizzare i pulsanti  , quindi premere il pulsante .

# 5 Trasferimento e stampa di immagini

## Trasferimento di immagini

Se si è installato il software HP Photosmart, utilizzare questo metodo per trasferire le immagini e i videoclip nel computer. Se non si è installato il software HP Photosmart, consultare la Guida d'uso elettronica per individuare un metodo alternativo.

**Suggerimento** Questa operazione può essere eseguita anche utilizzando un alloggiamento opzionale della fotocamera HP Photosmart (vedere la Guida d'uso dell'alloggiamento).

1. Collegare la fotocamera e il computer utilizzando il cavo USB in dotazione con la fotocamera.
2. Accendere la fotocamera e seguire le istruzioni visualizzate sullo schermo del computer per trasferire le immagini. Per ulteriori informazioni, vedere la funzione Guida nel software HP Photosmart.





## Stampa di immagini dalla fotocamera

Per stampare foto, è possibile collegare la fotocamera a qualsiasi stampante certificata PictBridge.

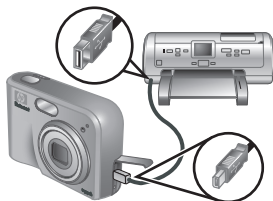

1. Controllare che la stampante sia accesa, che contenga carta e che non siano presenti messaggi di errore.
2. Collegare la fotocamera e la stampante utilizzando il cavo USB in dotazione con la fotocamera, quindi accendere la fotocamera.









3. Quando la fotocamera è collegata alla stampante, sulla fotocamera viene visualizzato il menu **Imposta stampante**. Per modificare le impostazioni, utilizzare i pulsanti ▲▼ della fotocamera per selezionare un'opzione di menu, quindi utilizzare i pulsanti ◀▶ della fotocamera per modificare l'impostazione.
4. Per iniziare a stampare, premere il pulsante .

# 6 Riferimento rapido della fotocamera

Questo capitolo fornisce un riferimento rapido per le funzioni della fotocamera. Per ulteriori informazioni su queste funzioni della fotocamera, consultare la Guida d'uso elettronica.

## Vista dal vivo e Riproduzione

- La modalità **Vista dal vivo** consente di inquadrare foto e videoclip nel display LCD. Per attivare la modalità **Vista dal vivo**, premere il pulsante  /  fino a quando l'icona  viene visualizzata brevemente nell'angolo in alto a destra del display LCD.
- La modalità **Riproduzione** consente di rivedere e modificare le immagini e i videoclip. Per attivare la modalità **Riproduzione**, premere il pulsante  /  fino a quando l'icona  viene visualizzata brevemente nell'angolo in alto a destra del display LCD.

## Menu



Quando si preme il pulsante

 dalla modalità



**Riproduzione** o **Vista dal vivo**, si accede ai menu a scheda della fotocamera, come illustrato nella schermata di esempio.



Per spostarsi al menu desiderato, utilizzare i pulsanti ◀▶. All'interno di un menu, utilizzare i pulsanti ▲▼ per spostarsi sulle voci desiderate.

Per uscire dal menu, premere il pulsante  /  in qualsiasi momento.

Menu e opzioni:

Menu	Opzioni
 <b>Cattura</b> consente di regolare le impostazioni della fotocamera che influiscono sulle caratteristiche delle immagini e dei videoclip che si acquisiranno in futuro con la fotocamera.	<ul style="list-style-type: none"><li>• Opzioni di scatto (Mod. automatica, Autoscatto, Scatto veloce, Panorama, Ritratto, Azione, Ritratto notturno, Spiaggia e neve, Tramonto, Scatto continuo, Macro).</li><li>• Qualità img.</li><li>• Inserimento di data e ora</li><li>• Compensazione esposizione</li><li>• Bilanciam. bianco</li><li>• Velocità ISO</li></ul>
 <b>Galleria effetti</b> consente di migliorare le immagini acquisite.	<ul style="list-style-type: none"><li>• Elimina occhi rossi</li><li>• Modifica colore</li><li>• Aggiungi contorni</li><li>• Ruota</li><li>• Registra audio</li><li>• Sposta imm. su scheda</li></ul>
 <b>Configura</b> consente di modificare il funzionamento della fotocamera.	<ul style="list-style-type: none"><li>• Lumin. display</li><li>• Suoni fotocamera</li><li>• Data e ora</li><li>• Configurazione USB</li><li>• Configurazione TV</li></ul>

Menu	Opzioni
	<ul style="list-style-type: none"> <li>• Lingua</li> </ul>
<p><b>?</b> ? fornisce le descrizioni delle funzioni della fotocamera e suggerimenti per scattare le foto.</p>	<ul style="list-style-type: none"> <li>• 10 utili suggerimenti</li> <li>• Accessori</li> <li>• Pulsanti fotocamera</li> <li>• Uso delle modalità di scatto</li> <li>• Utilizzo della galleria degli effetti</li> <li>• Condivisione immagini</li> <li>• Stampa immagini</li> <li>• Registrazione clip audio</li> <li>• Registrazione videoclip</li> <li>• Revisione immagini e video</li> <li>• Cancellazione immagini</li> <li>• Trasferimento immagini</li> <li>• Manutenzione batterie</li> <li>• Assistenza</li> <li>• Accesso rapido</li> <li>• Info su...</li> </ul>

Quando si preme il pulsante  dalla modalità **Vista dal vivo** o **Riproduzione**, viene visualizzato il menu **Photosmart Express**.

Menu	Opzioni
<p> <b>Photosmart Express</b> consente di condividere le foto con amici e parenti.</p>	<ul style="list-style-type: none"> <li>• Stampa</li> <li>• Acquisto stampe online</li> <li>• Config. Condividi</li> </ul>

Italiano



# HP Photosmart M425/M525 Digitalkamera

Deutsch



## Rechtliche Hinweise

© Copyright 2006 Hewlett-Packard Development Company, L.P.

Die Informationen in diesem Dokument können ohne vorherige Ankündigung geändert werden. Für HP Produkte und Dienste gelten nur die Gewährleistungen, die in den ausdrücklichen Gewährleistungserklärungen des jeweiligen Produkts bzw. Dienstes aufgeführt sind. Dieses Dokument gibt keine weiteren Gewährleistungen. HP haftet nicht für technische oder redaktionelle Fehler oder Auslassungen in diesem Dokument. Windows® ist eine in den USA eingetragene Marke der Microsoft Corporation.



Das SD-Logo ist eine Marke des entsprechenden Eigentümers.

## Entsorgung von Altgeräten durch Benutzer in privaten Haushalten der Europäischen Union



Dieses Symbol auf dem Gerät oder dessen Verpackung gibt an, dass das betreffende Gerät nicht mit dem Hausmüll entsorgt werden darf. Sie sind selbst für die Entsorgung Ihrer Altgeräte zuständig, d.h., Sie müssen diese bei den für das Recycling von Elektro- und Elektronik-Altgeräten zuständigen Sammelstellen abgeben. Durch die getrennte Sammlung und das Recycling Ihrer Altgeräte werden bei der Entsorgung natürliche Ressourcen geschont. Gleichzeitig wird dadurch eine die Gesundheit und die Umwelt schützende Verwertung sichergestellt. Weitere Informationen zu möglichen Sammelstellen für Ihre Altgeräte erhalten Sie bei der Stadtverwaltung, Ihrem Hausmüllentsorger oder in dem Geschäft, in dem Sie das Gerät erworben haben.

**Notieren Sie hier die wichtigsten Angaben zu Ihrer Kamera:**

Modellnummer (an der Vorderseite der Kamera)	
Seriennummer (10-stellige Nummer an der Unterseite der Kamera)	
Kaufdatum der Kamera	

# Inhalt

<b>1 Erste Schritte</b> .....	5
Anzeigen des elektronischen Benutzerhandbuchs.....	6
Ober- und Rückseite der Kamera .....	7
Vorderseite, Seite und Unterseite der Kamera.....	9
Docking-Einsatz für die Kamera.....	9
<b>2 Einrichten der Kamera</b> .....	11
Einsetzen der Batterien.....	11
Einschalten der Kamera.....	12
Auswählen der Sprache.....	12
Einstellen der Region.....	12
Einstellen von Datum und Uhrzeit.....	13
Einsetzen und Formatieren einer optionalen Speicherkarte.....	13
Installieren der Software.....	14
<b>3 Aufnehmen von Bildern und Videoclips</b> .....	16
Aufnehmen von Einzelbildern.....	16
Aufnehmen eines Videoclips.....	16
<b>4 Anzeigen und Löschen von Bildern und     Videoclips</b> .....	18
Anzeigen von Bildern und Videoclips.....	18
Löschen von Bildern.....	18
<b>5 Übertragen und Drucken von Bildern</b> .....	20
Übertragen von Bildern.....	20
Drucken von Bildern über die Kamera.....	21
<b>6 Kurzreferenz zur Kamera</b> .....	22

# 1 Erste Schritte

Diese gedruckte Kurzübersicht enthält die Informationen, die Sie für die ersten Schritte bei der Verwendung der Grundfunktionen Ihrer Kamera benötigen. Ausführliche Informationen zu den Kamerafunktionen finden Sie im elektronischen Benutzerhandbuch.

<b>Kurzübersicht</b>	<b>Elektronisches Benutzerhandbuch</b>
<p>Dieses gedruckte Handbuch enthält nützliche Informationen zu folgenden Themen:</p> <ul style="list-style-type: none"><li>• Schneller Einsatzbeginn der Kamera</li><li>• Installieren der HP Photosmart-Software</li><li>• Einführung in die Funktionen der Kamera</li></ul>	<p>Das elektronische Benutzerhandbuch enthält Informationen zu folgenden Themen:</p> <ul style="list-style-type: none"><li>• Beschreibungen aller Kamerafunktionen</li><li>• Beschreibung der Symbole in der Bildanzeige</li><li>• Verwenden der Kamera ohne Installation der HP Photosmart-Software</li><li>• Batterieinformationen, einschließlich:<ul style="list-style-type: none"><li>– Verlängern der Batterielebensdauer</li><li>– Verschiedene Batterietypen</li><li>– Beschreibung der Symbole für die Stromversorgungsanzeige</li></ul></li></ul>

- 
- Unterstützung durch HP
  - Fehlerbehebung
  - Kameraspezifikationen
- 

## Anzeigen des elektronischen Benutzerhandbuchs



Das elektronische Benutzerhandbuch befindet sich auf der CD mit der HP Photosmart-Software.

Anzeigen des Benutzerhandbuchs:

1. Legen Sie die CD mit der HP Photosmart-Software in das CD-Laufwerk Ihres Computers ein.
2. **Windows:** Klicken Sie auf der Hauptseite des Installationsbildschirms auf **Benutzerhandbuch anzeigen**.

**Macintosh:** Öffnen Sie auf der CD im Ordner **docs** die Datei **readme**.

Das elektronische Benutzerhandbuch wird bei der Installation der HP Photosmart-Software auf Ihren Computer kopiert. So zeigen Sie das Benutzerhandbuch nach der Installation auf Ihrem Computer an:

- **Windows:** Öffnen Sie **HP Solution Center**, und klicken Sie auf **Hilfe und Support**.
- **Macintosh:** Öffnen Sie den **HP Gerätemanager**, und wählen Sie im Popup-Menü **Benutzerhandbuch** die Option **Informationen und Einstellung** aus.







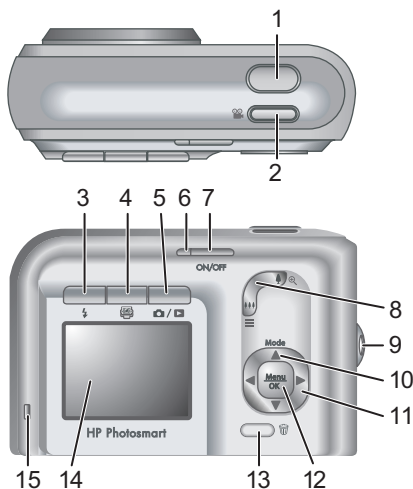







## Unterstützung

- Tipps und Tools zur effizienten Nutzung Ihrer Kamera finden Sie unter **www.hp.com/photosmart** (nur in englischer Sprache verfügbar) oder unter **www.hp.com**.
- Produktunterstützung, Diagnosen und Treiberdownloads finden Sie täglich 24 Stunden lang unter **www.hp.com/support**.
- Hilfe zur HP Photosmart-Software finden Sie in der Hilfefunktion der HP Photosmart-Software.

## Ober- und Rückseite der Kamera



1	Taste <b>Auslöser</b>
2	Taste <b>Video</b>

3	 Taste <b>Blitz</b> – Mögliche Einstellungen sind: Autom., Rote Augen, Blitz ein, Blitz aus.
4	 Taste <b>Photosmart Express</b> – Mögliche Optionen sind: Drucken, Abzüge online erwerben, „Share“ einrichten.
5	 Taste <b>Vorschau/Wiedergabe</b> – Wechselt zwischen <b>Vorschau</b> und <b>Wiedergabe</b> (siehe „ <i>Vorschau und Wiedergabe</i> “ auf Seite 22).
6	Betriebskontrollleuchte
7	Taste ON/OFF
8	<b>Zoom-Hebel</b> (digital und optisch) – Drücken Sie in der <b>Vorschau</b> die Taste  , um den Bildausschnitt zu vergrößern, oder drücken Sie die Taste  , um den Bildausschnitt zu verkleinern. Drücken Sie in der <b>Wiedergabe</b> die Taste  , um das ausgewählte Bild zu vergrößern, oder drücken Sie die Taste  , um Miniaturansichten der Bilder anzuzeigen.
9	Befestigung für Halteschlaufe
10	Taste <b>Modus</b> – Drücken Sie die Taste  , um auf das Menü <b>Aufnahmemodus</b> zuzugreifen, während Sie sich in der <b>Vorschau</b> befinden. Mögliche Optionen sind: Autom., Selbstauslöser, Schnappschuss, Landschaft, Portrait, Action, Nachtportrait, Strand und Schnee, Sonnenuntergang, Burst, Makro.
11	Tasten   und   – Dienen zum Blättern durch Menüs und Bilder.
12	Taste  – Zeigt Kameramenüs an, wählt Optionen aus und bestätigt Aktionen.
13	 Taste <b>Löschen</b> – Greift auf die Funktion <b>Löschen</b> zu, wenn Sie sich in der <b>Wiedergabe</b> befinden.



14	Bildanzeige
15	Kontrollleuchte für Batterieladezustand

## Vorderseite, Seite und Unterseite der Kamera

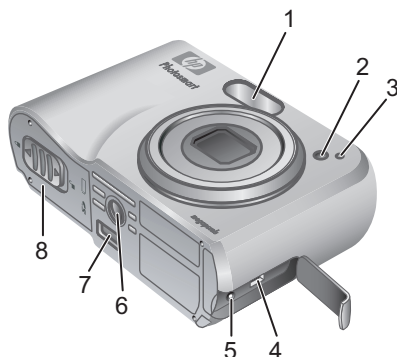

1	Blitz
2	Kontrollleuchte für Selbstauslöser
3	Mikrofon
4	USB-Anschluss
5	Anschluss für Netzteil
6	Stativhalterung
7	Anschluss für Dockingstation
8	Klappe des Batterie-/Speicherkartenfachs

## Docking-Einsatz für die Kamera

Wenn Sie eine optionale HP Photosmart-Kamera-Dockingstation erwerben, wird diese mit mehreren leeren Einsätzen geliefert. Wenn Sie die Dockingstation für diese Kamera einrichten, verwenden Sie den Docking-Einsatz mit der grünen quadratischen Kennzeichnung. Anweisungen finden Sie im Benutzerhandbuch für die Dockingstation.

## 2 Einrichten der Kamera

### Einsetzen der Batterien

1. Öffnen Sie die Klappe des Batterie-/Speicherkartenfachs, indem Sie die Verriegelung der Klappe wie abgebildet lösen.
2. Setzen Sie die Batterien ein.
3. Schließen Sie die Klappe des Batterie-/Speicherkartenfachs.



**Hinweis** Schalten Sie die Kamera aus, bevor Sie die Batterien entnehmen. Wenn Sie wiederaufladbare NiMH-Batterien verwenden, laden Sie die Batterien vor dem ersten Einsetzen vollständig auf.



Die Lebensdauer der Batterien ist vom Einsatz der Kamera und vom Batterietyp abhängig. Alkali-Batterien haben eine wesentlich kürzere Lebensdauer als Foto-Lithium- oder NiMH-Batterien. Ausführliche Informationen finden Sie in Anhang A des elektronischen Benutzerhandbuchs.

**Anzahl von Aufnahmen**

Batterie-typ	Mindest-anzahl	Höch-stanzahl	Durch-schnitt	CIPA
Alkali	77	180	120	80

NiMH	<b>215</b>	<b>380</b>	<b>290</b>	<b>205</b>
Foto-Lithium	<b>365</b>	<b>600</b>	<b>485</b>	<b>423</b>

Die Spalte „CIPA“ enthält die Anzahl von Aufnahmen, die mit Hilfe des von der Camera and Imaging Products Association entwickelten Standards ermittelt wurde.

## Einschalten der Kamera

Zum Einschalten der Kamera drücken Sie die Taste ON/OFF.

## Auswählen der Sprache

Stellen Sie mit den Tasten ▲▼ ◀▶ die gewünschte Sprache ein, und drücken Sie dann die Taste  $\frac{\text{Menu}}{\text{OK}}$ .

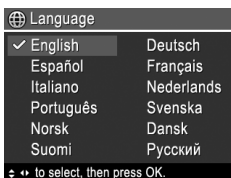

## Einstellen der Region

Zusammen mit der Einstellung **Sprache** bestimmt die Einstellung **Region** das Standarddatumsformat und das Format des Videosignals für das Anzeigen von Kamerabildern auf einem Fernsehgerät.



Stellen Sie mit den Tasten ▲▼ die gewünschte Region ein, und drücken Sie dann die Taste  $\frac{\text{Menu}}{\text{OK}}$ .

## Einstellen von Datum und Uhrzeit

1. Wählen Sie mit den Tasten ▲▼ den markierten Wert aus.
2. Wechseln Sie mit den Tasten ◀▶ zu den anderen Optionen, und wiederholen Sie Schritt 1, bis Datum und Uhrzeit richtig eingestellt sind.
3. Drücken Sie die Taste  $\text{Menu}$ / $\text{OK}$ , wenn die Einstellungen für Datum, Uhrzeit und Format richtig sind, und drücken Sie dann die Taste  $\text{Menu}$ / $\text{OK}$  zur Bestätigung erneut.

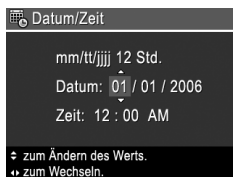





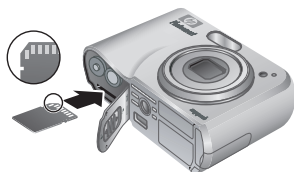





## Einsetzen und Formatieren einer optionalen Speicherkarte

1. Schalten Sie die Kamera aus, und öffnen Sie die Klappe des Batterie-/Speicherkartenfachs.
2. Setzen Sie die optionale Speicherkarte wie abgebildet in den kleineren Steckplatz ein. Achten Sie darauf, dass die Speicherkarte einrastet.
3. Schließen Sie die Klappe des Batterie-/Speicherkartenfachs, und schalten Sie die Kamera ein.



Formatieren Sie Speicherkarten stets vor dem ersten Einsatz.

1. Drücken Sie bei eingeschalteter Kamera die Taste  / , bis  kurz in der oberen rechten Ecke der Bildanzeige erscheint. Dadurch wird angezeigt, dass Sie sich in der **Wiedergabe** befinden.
2. Drücken Sie die Taste .
3. Wählen Sie mit den Tasten   im Untermenü **Löschen** die Option **Speicherformatieren** aus, und drücken Sie dann die Taste .
4. Wählen Sie mit den Tasten   die Option **Ja** aus, und drücken Sie dann die Taste , um die Karte zu formatieren.

Wenn Sie eine Speicherkarte einsetzen, werden sämtliche neuen Bilder und Videoclips nicht im internen Speicher, sondern auf der Karte gespeichert.

Wenn Sie den internen Speicher verwenden und die dort gespeicherten Bilder anzeigen möchten, müssen Sie die Speicherkarte entfernen.

## Installieren der Software

Die HP Photosmart-Software bietet Funktionen zum Übertragen von Bildern und Videoclips auf Ihren Computer sowie zum Bearbeiten gespeicherter Bilder (**Rote Augen entfernen, Drehen, Zuschneiden, Größe ändern** sowie Funktionen zum Anpassen der Bildqualität und Hinzufügen von Farben und Spezialeffekten usw.).

Bei Problemen mit der Installation oder Verwendung der HP Photosmart-Software finden Sie weitere Informationen auf der Website der HP Kundenunterstützung unter: [www.hp.com/support](http://www.hp.com/support).

## Windows

Wenn Ihr Windows-Computer die auf der Verpackung der Kamera angegebenen Systemvoraussetzungen nicht erfüllt, wird HP Photosmart Essential anstelle der Vollversion HP Photosmart Premier installiert.

1. Schließen Sie alle Programme, und deaktivieren Sie ggf. vorübergehend die Virenschutzsoftware.
2. Legen Sie die CD mit der HP Photosmart-Software in das CD-Laufwerk ein, und befolgen Sie die Anweisungen auf dem Bildschirm. Wenn der Installationsbildschirm nicht angezeigt wird, klicken Sie auf **Start** und dann auf **Ausführen**, geben Sie **D:\Setup.exe** ein (wobei **D** für den Buchstaben Ihres CD-Laufwerks steht), und klicken Sie dann auf **OK**.
3. Wenn die Installation der Software abgeschlossen ist, aktivieren Sie die Virenschutzsoftware wieder.



## Macintosh

1. Legen Sie die CD mit der HP Photosmart-Software in das CD-Laufwerk ein.
2. Doppelklicken Sie auf dem Schreibtisch auf das CD-Symbol.
3. Doppelklicken Sie auf das Installationssymbol, und befolgen Sie dann die Anweisungen auf dem Bildschirm.

# 3 Aufnahmen von Bildern und Videoclips



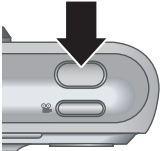

Die **Vorschau** ermöglicht das Erfassen von Motiven für Bilder und Videoclips in der Bildanzeige.

## Aufnahmen von Einzelbildern

1. Drücken Sie die Taste  / , bis das Symbol  kurz in der oberen rechten Ecke der Bildanzeige erscheint. Dadurch wird angezeigt, dass Sie sich in der **Vorschau** befinden. 
2. Erfassen Sie das Motiv für das Bild.
3. Drücken Sie den **Auslöser** halb herunter, um den Fokus und die Belichtungszeit zu ermitteln und zu sperren. Die Fokusklammern in der Bildanzeige leuchten durchgängig grün, wenn der Fokus gesperrt ist.
4. Drücken Sie den **Auslöser** ganz herunter, um das Bild aufzunehmen.
5. Zum Hinzufügen eines Audioclips halten Sie den **Auslöser** weiterhin gedrückt und lassen ihn los, wenn der Vorgang abgeschlossen ist.



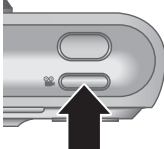



## Aufnehmen eines Videoclips

1. Drücken Sie die Taste  / , bis das Symbol  kurz in der oberen rechten Ecke der Bildanzeige erscheint. Dadurch wird angezeigt, dass Sie sich in der **Vorschau** befinden.
- 
2. Erfassen Sie das Motiv.
  3. Drücken Sie die Taste **Video** , und lassen Sie sie wieder los.
  4. Zum Beenden der Videoaufnahme drücken Sie erneut die Taste **Video** , und lassen Sie sie wieder los.

# 4 Anzeigen und Löschen von Bildern und Videoclips









## Anzeigen von Bildern und Videoclips

In der **Wiedergabe** können Sie Bilder und Videoclips anzeigen und bearbeiten.

1. Drücken Sie die Taste  / , bis das Symbol  kurz in der oberen rechten Ecke der Bildanzeige erscheint. Dadurch wird angezeigt, dass Sie sich in der **Wiedergabe** befinden.
2. Blättern Sie mit den Tasten   durch Ihre Bilder und Videoclips (Videoclips werden automatisch abgespielt).

## Löschen von Bildern

Während der **Wiedergabe** können Sie einzelne Bilder löschen:

1. Drücken Sie die Taste /, bis das Symbol  kurz in der oberen rechten Ecke der Bildanzeige erscheint. Dadurch wird angezeigt, dass Sie sich in der **Wiedergabe** befinden.
2. Wählen Sie mit den Tasten   ein Bild oder einen Videoclip aus.
3. Drücken Sie die Taste .
4. Wählen Sie mit den Tasten   im Untermenü **Löschen** die Option **Dieses Bild** aus, und drücken Sie dann die Taste  $\frac{\text{Menu}}{\text{OK}}$ .

# 5 Übertragen und Drucken von Bildern

## Übertragen von Bildern

Wenn Sie die HP Photosmart-Software installiert haben, übertragen Sie Bilder und Videoclips wie im Folgenden beschrieben auf Ihren Computer. Wenn Sie die HP Photosmart-Software nicht installiert haben, finden Sie im elektronischen Benutzerhandbuch eine weitere Möglichkeit zur Übertragung.

**Tipp** Sie können diese Aufgabe auch mit Hilfe einer optionalen HP Photosmart-Kamera-Dockingstation ausführen (Informationen hierzu finden Sie im Benutzerhandbuch zur Dockingstation).

1. Schließen Sie die Kamera über das im Lieferumfang der Kamera enthaltene USB-Kabel an den Computer an.
2. Schalten Sie die Kamera ein, und befolgen Sie zum Übertragen der Bilder die Anweisungen auf dem Computerbildschirm. Weitere Informationen finden Sie in der Hilfefunktion der HP Photosmart-Software.



## Drucken von Bildern über die Kamera

Sie können die Kamera zum Drucken von Einzelbildern an einen beliebigen PictBridge-kompatiblen Drucker anschließen.





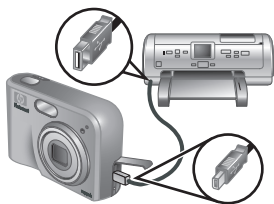



1. Überprüfen Sie, ob der Drucker eingeschaltet ist, ob Papier eingelegt wurde und keine Fehlermeldungen vorliegen.
2. Schließen Sie die Kamera über das im Lieferumfang der Kamera enthaltene USB-Kabel an den Drucker an, und schalten Sie die Kamera ein.
3. Wenn die Kamera mit dem Drucker verbunden ist, erscheint auf der Bildanzeige der Kamera das Menü **Druckeinrichtung**. Zum Ändern der Einstellungen wählen Sie mit den Tasten ▲▼ an der Kamera eine Menüoption aus. Ändern Sie die Einstellung dann mit den Tasten ◀▶ an der Kamera.
4. Drücken Sie die Taste  $\frac{\text{Menu}}{\text{OK}}$ , um den Druckvorgang zu starten.



# 6 Kurzreferenz zur Kamera

Verwenden Sie dieses Kapitel als Kurzreferenz für die Kamerafunktionen. Weitere Informationen zu den aufgeführten Kamerafunktionen finden Sie im elektronischen Benutzerhandbuch.

## Vorschau und Wiedergabe

- Die **Vorschau** ermöglicht das Erfassen von Motiven für Bilder und Videoclips in der Bildanzeige. Drücken Sie zum Aktivieren der **Vorschau** die Taste  / , bis das Symbol  kurz in der oberen rechten Ecke der Bildanzeige erscheint.
- In der **Wiedergabe** können Sie Bilder und Videoclips anzeigen und bearbeiten. Drücken Sie zum Aktivieren der **Wiedergabe** die Taste  / , bis das Symbol  kurz in der oberen rechten Ecke der Bildanzeige erscheint.

## Menüs



Wenn Sie in der **Wiedergabe** oder der **Vorschau** die Taste <sup>Menu</sup><sub>OK</sub> drücken, können Sie auf die als Registerkarten dargestellten Kameramenüs zugreifen, wie im Beispiel dargestellt.



Wechseln Sie mit den Tasten ◀▶ zum gewünschten Menü. Innerhalb eines Menüs können Sie mit den Tasten ▲▼ zur gewünschten Option wechseln.

Wenn Sie das Menü verlassen möchten, können Sie jederzeit die Taste  /  drücken.

Die folgenden Menüs und Optionen sind verfügbar:

Menü	Optionen
 <b>Aufnahme</b> – Hier können Sie Kameraeinstellungen vornehmen, die sich auf die Bilder und Videoclips auswirken, die Sie in Zukunft mit Ihrer Kamera aufnehmen.	<ul style="list-style-type: none"> <li>• Aufnahmemodi (Autom., Selbstausslöser, Schnappschuss, Landschaft, Portrait, Action, Nachtportrait, Strand und Schnee, Sonnenuntergang, Burst, Makro)</li> <li>• Bildqualität</li> <li>• Datums-/Zeitstempel</li> <li>• Belichtungskomp.</li> <li>• Weißabgleich</li> <li>• ISO-Empfindl.</li> </ul>
 <b>Design-Galerie</b> – Hier können Sie aufgenommene Bilder bearbeiten.	<ul style="list-style-type: none"> <li>• Rote Augen entfernen</li> <li>• Farbe ändern</li> <li>• Ränder hinzufügen</li> <li>• Drehen</li> <li>• Audio aufnehmen</li> <li>• Bilder a. Karte versch.</li> </ul>
 <b>Einrichten</b> – Hier können Sie Änderungen am Kameraverhalten einstellen.	<ul style="list-style-type: none"> <li>• Anzeigehelligkeit</li> <li>• Kameratöne</li> <li>• Datum und Zeit</li> <li>• USB-Konfiguration</li> <li>• TV-Konfiguration</li> </ul>

Menü	Optionen
	<ul style="list-style-type: none"> <li>• Sprache</li> </ul>
<p><b>? Hilfe</b> – Enthält Beschreibungen der Kamerafunktionen und Tipps zum Aufnehmen von Bildern.</p>	<ul style="list-style-type: none"> <li>• Top Ten-Tipps</li> <li>• Kamerazubehör</li> <li>• Kamertasten</li> <li>• Aufnahmemodi verwenden</li> <li>• Design-Galerie verwenden</li> <li>• Bilder weitergeben</li> <li>• Bilder drucken</li> <li>• Audioclips aufnehmen</li> <li>• Videoclips aufnehmen</li> <li>• Bilder und Videos anzeigen</li> <li>• Bilder löschen</li> <li>• Bilder übertragen</li> <li>• Batterie-Management</li> <li>• Unterstützung</li> <li>• Kamera-Kurztasten</li> <li>• Info</li> </ul>

Wenn Sie in der **Vorschau** oder der **Wiedergabe** die Taste  drücken, wird das Menü **Photosmart Express** angezeigt.

Menü	Optionen
<p> <b>Photosmart Express</b> – Ermöglicht das Weitergeben Ihrer Fotos an Freunde und Verwandte.</p>	<ul style="list-style-type: none"> <li>• Drucken</li> <li>• Abzüge online erwerben</li> <li>• „Share“ einrichten</li> </ul>



# Cámara digital HP Photosmart M425/ M525

Español



## Avisos legales

© Copyright 2006 Hewlett-Packard Development Company, L.P.

La información que aparece en este documento está sujeta a cambios sin previo aviso. Las únicas garantías de los productos y servicios de HP se detallan en las declaraciones de garantía expresa que acompañan a dichos productos y servicios. Nada de lo que contenga este documento se considerará como garantía adicional. HP no se hará responsable de los errores u omisiones técnicos o editoriales aquí contenidos.

Windows® es una marca registrada en EE.UU. de Microsoft Corporation.



El logotipo SD es una marca comercial de su propietario.

## Información sobre el reciclaje del equipo para particulares de la Unión Europea



Este símbolo colocado en el producto o en su envoltorio indica que no debe tirarse con los residuos domésticos.

Por el contrario, es responsabilidad del usuario depositar el equipo usado en un punto de recogida destinado al reciclaje de equipos eléctricos y electrónicos. La recogida selectiva del equipo usado y su reciclaje contribuirán a conservar los recursos naturales y a garantizar que se recicla protegiendo el entorno y la salud del ser humano. Para obtener más información acerca de los puntos de recogida para el reciclaje de equipos usados, póngase en contacto con el ayuntamiento de la zona, el servicio de recolección de basura o el establecimiento donde adquirió el producto.

**Para futuras consultas, introduzca la siguiente información:**

Número de modelo (en la parte frontal de la cámara)	
Número de serie (número de 10 dígitos situado en la parte inferior de la cámara)	
Fecha de adquisición de la cámara	

Español

# Contenido

<b>1</b>	<b>Introducción</b> .....	5
	Visualización de la Guía de usuario electrónica.....	6
	Parte superior y trasera de la cámara.....	7
	Partes frontal, lateral e inferior de la cámara.....	9
	Ranura de la base de acoplamiento de la cámara.....	9
<b>2</b>	<b>Configuración de la cámara</b> .....	11
	Colocación de las pilas.....	11
	Encendido de la cámara.....	12
	Selección del idioma.....	12
	Configuración de la región.....	12
	Ajuste de la fecha y la hora.....	13
	Instalación y formateo de una tarjeta de memoria opcional.....	13
	Instalación del software.....	14
<b>3</b>	<b>Captura de fotografías y grabación de videoclips</b> .....	16
	Captura de fotografías fijas.....	16
	Grabación de un videoclip.....	16
<b>4</b>	<b>Revisión y eliminación de imágenes y videoclips</b> .....	18
	Revisión de imágenes y videoclips.....	18
	Eliminación de una imagen.....	18
<b>5</b>	<b>Transferencia e impresión de imágenes</b> .....	20
	Transferencia de imágenes.....	20
	Impresión de imágenes desde la cámara.....	21
<b>6</b>	<b>Referencia rápida de la cámara</b> .....	22

# 1 Introducción

Esta guía impresa de inicio rápido ofrece la información necesaria para comenzar a utilizar las funciones básicas de la cámara. Para obtener información detallada sobre las funciones de la cámara, consulte la Guía de usuario electrónica.

Guía de inicio rápido	Guía de usuario electrónica
<p data-bbox="208 482 515 534">Esta guía impresa le ayudará a:</p> <ul data-bbox="208 554 515 719" style="list-style-type: none"><li data-bbox="208 554 515 605">● Comenzar a utilizar la cámara rápidamente.</li><li data-bbox="208 611 515 662">● Instalar el software HP Photosmart.</li><li data-bbox="208 668 515 719">● Conocer las funciones de la cámara.</li></ul>	<p data-bbox="526 482 829 534">La Guía de usuario electrónica incluye:</p> <ul data-bbox="526 554 829 1159" style="list-style-type: none"><li data-bbox="526 554 829 634">● Descripciones de todas las funciones de la cámara.</li><li data-bbox="526 639 829 719">● Una descripción de los iconos de la pantalla de imagen.</li><li data-bbox="526 725 829 805">● Uso de la cámara sin instalar el software HP Photosmart.</li><li data-bbox="526 811 829 1105">● Información sobre las pilas, además de:<ul data-bbox="573 876 829 1105" style="list-style-type: none"><li data-bbox="573 876 829 928">– Duración de las pilas ampliable.</li><li data-bbox="573 933 829 985">– Los diferentes tipos de pila.</li><li data-bbox="573 991 829 1105">– Una descripción de los iconos indicadores de encendido.</li></ul></li><li data-bbox="526 1110 829 1133">● Asistencia de HP.</li><li data-bbox="526 1139 829 1159">● Solución de problemas.</li></ul>

- Especificaciones de la cámara.

## Visualización de la Guía de usuario electrónica



La Guía de usuario electrónica se encuentra en el CD del software HP Photosmart.

Para acceder a la Guía de usuario:

1. Introduzca el CD del software HP Photosmart en la unidad de CD del equipo.
2. **En Windows:** haga clic en **View User Guide** (Ver guía de usuario) en la página principal de la pantalla de instalación.

**En Macintosh:** abra el archivo **readme** (léame) de la carpeta **docs** del CD.

La Guía de usuario electrónica también se copia en el equipo al instalar el software HP Photosmart. Para ver la Guía de usuario después de instalarla en el equipo:

- **En Windows:** abra el **Centro de soluciones HP** y haga clic en **Ayuda y soporte técnico**.
- **En Macintosh:** abra **HP Device Manager** (Gestor de dispositivos HP) y seleccione **User Guide** (Guía de usuario) en el menú emergente **Information and Setting** (Información y ajuste).



### Asistencia





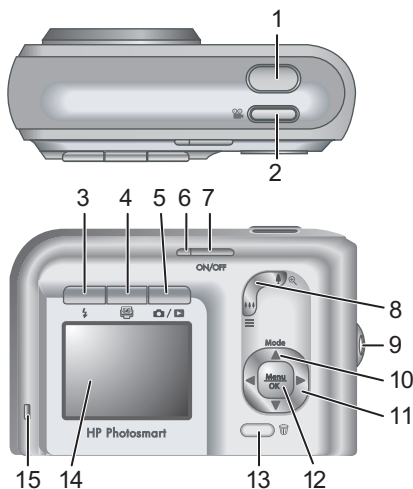









- Para disponer de sugerencias y herramientas que le ayuden a hacer un uso más efectivo de la cámara, visite la página Web **www.hp.com/photosmart** (sólo en inglés) o **www.hp.com**.

- Para obtener asistencia para el producto, diagnósticos y descargas de controladores en cualquier momento del día, los siete días de la semana, visite **www.hp.com/support**.
- Si necesita ayuda con el software HP Photosmart, consulte la función Ayuda del software HP Photosmart.

## Parte superior y trasera de la cámara



1	Botón del <b>Disparador</b> .
2	 Botón <b>Vídeo</b> .
3	 Botón <b>Flash</b> : los ajustes son Automático, Ojos rojos, Flash encendido y Flash apagado.

4	 Botón <b>Photosmart Express</b> : las opciones son Imprimir, Comprar copias en línea y Conf. Compartir.
5	 /  Botón <b>Vista en directo/Reproducción</b> : alterna entre <b>Vista en directo</b> y <b>Reproducción</b> (consulte el apartado <i>Vista en directo</i> y <i>Reproducción</i> en la página 22).
6	Indicador luminoso de Encendido.
7	Botón ON/OFF (Encendido/Apagado).
8	Palanca de <b>zoom</b> (digital y óptico): en <b>Vista en directo</b> , presione  para acercar el zoom o  para alejarlo. En <b>Reproducción</b> , presione  para ampliar la imagen seleccionada, o  para ver las viñetas de las imágenes.
9	Soporte para la correa de la muñeca.
10	Botón <b>Modo</b> : presione  para acceder al menú <b>Modo de fotografía</b> mientras se encuentra en <b>Vista en directo</b> . Las opciones son Modo automático, Temporizador automático, Disparo rápido, Paisaje, Retrato, Acción, Retrato nocturno, Playa y nieve, Puesta de sol, Ráfaga y Macro.
11	Botones   y   : desplazan al usuario por menús e imágenes.
12	Botón  <sup>Menu</sup> / <sub>OK</sub> : muestra los menús de la cámara, selecciona opciones y confirma acciones.
13	 Botón <b>Eliminar</b> : confiere acceso a la función <b>Eliminar</b> cuando se encuentra en la opción <b>Reproducción</b> .
14	Pantalla de imagen.
15	Indicador luminoso de carga de las pilas.



## Partes frontal, lateral e inferior de la cámara

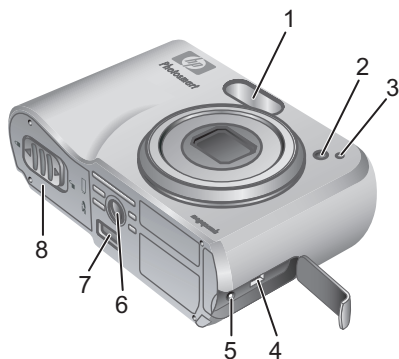

1	Flash.
2	Indicador luminoso de Temporizador automático.
3	Micrófono.
4	Conector USB.
5	Conector de adaptador de alimentación.
6	Soporte de trípode.
7	Conector de la base de acoplamiento.
8	Puerta de las pilas/tarjeta de memoria.

## Ranura de la base de acoplamiento de la cámara

Al adquirir una base de acoplamiento opcional de la cámara HP Photosmart, ésta viene provista de varias ranuras vacías. Cuando configure una base opcional para utilizarla con esta cámara, utilice la ranura de la base con la etiqueta verde cuadrada. Para obtener instrucciones, consulte el apartado de la base de acoplamiento de la Guía de usuario.

## 2 Configuración de la cámara

### Colocación de las pilas

1. Abra la puerta de las pilas o de la tarjeta de memoria; para ello, deslice la lengüeta correspondiente, como se indica en dicha puerta.
2. Inserte las pilas.
3. Cierre la puerta de las pilas o de la tarjeta de memoria.



**Nota** Apague la cámara antes de extraer las pilas. Si emplea pilas NiMH recargables, cárguelas por completo antes de utilizarlas por primera vez.



El uso de la cámara y el tipo de pila afectarán a la duración de las pilas. Las pilas alcalinas proporcionan menor duración que las pilas NiMH o de litio. Para disponer de una información más completa, consulte el Apéndice A de la Guía de usuario electrónica.

Número de disparos

Tipo de pila	Mínimo	Máximo	Promedio	CIPA
Alcalinas	77	180	120	80
NiMH	215	380	290	205
Foto Litio	365	600	485	423

El número de CIPA se obtiene mediante las normas establecidas por la asociación CIPA (del inglés, Camera and Imaging Products Association).

## Encendido de la cámara

Para encender la cámara, presione el botón ON/OFF (Encendido/Apagado).

## Selección del idioma

Utilice ▲▼◀▶ para seleccionar el idioma que desee y, a continuación, presione <sup>Menu</sup>OK.

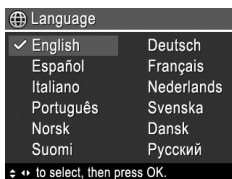

## Configuración de la región

Junto con el ajuste **Idioma**, el ajuste **Región** determina los valores predeterminados de los formatos de fecha y señal de vídeo que aparecerán al visualizar las imágenes de la cámara en un televisor.



Utilice ▲▼ para seleccionar la región que desee y, a continuación, presione <sup>Menu</sup>OK.

## Ajuste de la fecha y la hora

1. Utilice ▲▼ para ajustar el valor resaltado.
2. Utilice ◀▶ para pasar al resto de selecciones y repita el paso 1 hasta que la fecha y la hora queden establecidas correctamente.
3. Presione  $\frac{\text{Menu}}{\text{OK}}$  cuando los ajustes de fecha, hora y formato sean correctos; seguidamente, vuelva a presionar  $\frac{\text{Menu}}{\text{OK}}$  para confirmar.

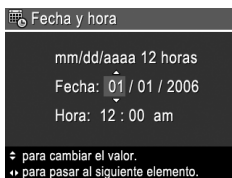





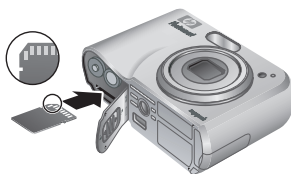







## Instalación y formateo de una tarjeta de memoria opcional

1. Apague la cámara y abra la puerta de las pilas o de la tarjeta de memoria.
2. Inserte la tarjeta de memoria opcional en la ranura más pequeña, como se muestra en la ilustración. Asegúrese de que encaja en su sitio.
3. Cierre la puerta de las pilas o de la tarjeta de memoria y encienda la cámara.



De formato a las tarjetas de memoria antes de utilizarlas por primera vez.

1. Con la cámara encendida, presione  /  hasta que  aparezca un instante en la esquina superior derecha de la Pantalla de imagen. Esto le indica que se encuentra en la opción **Reproducción**.
2. Presione .
3. Utilice   para seleccionar **Formatear tarjeta** en el submenú **Eliminar**. A continuación, presione  .
4. Utilice   para seleccionar **Si** y presione   para formatear la tarjeta.

Una vez que se ha colocado una tarjeta de memoria, todos los videoclips e imágenes nuevos se almacenarán en la tarjeta, en lugar de en la memoria interna.

Para utilizar la memoria interna y ver las imágenes almacenadas en ella, extraiga la tarjeta de memoria.

## Instalación del software

El software HP Photosmart ofrece funciones para transferir imágenes y videoclips al equipo, y también permite modificar las imágenes almacenadas (mediante la eliminación de ojos rojos, rotación, recorte, redimensiones, ajuste de la calidad de imagen, incorporación de colores y efectos especiales, etc.).

Si tiene dificultades para instalar o utilizar el software HP Photosmart, encontrará más información en el sitio Web de atención al cliente de HP: [www.hp.com/support](http://www.hp.com/support).

## Windows

Si el equipo Windows no cumple los requisitos del sistema establecidos en el envoltorio de la cámara, será HP Photosmart Essential el software que se instalará en el equipo, y no la versión completa de HP Photosmart Premier.

1. Cierre todos los programas y desactive temporalmente el software antivirus.
2. Inserte el CD del software HP Photosmart en la unidad de CD y siga las instrucciones que aparecen en pantalla. Si no se abre la ventana de instalación, haga clic en **Inicio, Ejecutar** y escriba **D:\Setup.exe**, donde **D** equivale a la letra de la unidad de CD. Por último, haga clic en **Aceptar**.
3. Una vez finalizada la instalación del software, vuelva a activar el software antivirus.

## Macintosh

1. Introduzca el CD del software HP Photosmart en la unidad de CD.
2. Haga doble clic en el icono del CD situado en el escritorio del equipo.
3. Haga doble clic en el icono del programa de instalación y, a continuación, siga las instrucciones que aparecen en pantalla.

### 3 Captura de fotografías y grabación de videoclips





La función **Vista en directo** le permite encuadrar fotografías y videoclips en la Pantalla de imagen.

#### Captura de fotografías fijas

1. Presione  /  hasta que  aparezca un instante en la esquina superior derecha de la Pantalla de imagen. Esto le indica que se encuentra en la opción **Vista en directo**.
- 
2. Encadre el sujeto de la fotografía.
  3. Presione el botón del **Disparador** hasta la mitad de su recorrido para medir y bloquear el enfoque y la exposición. Los delimitadores de enfoque de la Pantalla de imagen se iluminan en verde cuando se bloquea el enfoque.
  4. Presione el botón del **Disparador** hasta el fondo para tomar la fotografía.
  5. Para agregar un clip de audio, mantenga presionado el botón del **Disparador** y suéltelo cuando finalice.



## Grabación de un videoclip



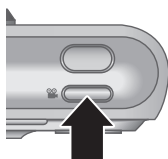

1. Presione  /  hasta que  aparezca un instante en la esquina superior derecha de la Pantalla de imagen. Esto le indica que se encuentra en la opción **Vista en directo**.
2. Encuadre el sujeto.
3. Presione un instante el botón **Vídeo** .
4. Para detener la grabación vuelva a presionar un instante el botón **Vídeo** .



## 4 Revisión y eliminación de imágenes y videoclips











### Revisión de imágenes y videoclips

La opción **Reproducción** le permite revisar y trabajar con imágenes y videoclips.

1. Presione  /  hasta que  aparezca un instante en la esquina superior derecha de la Pantalla de imagen. Esto le indica que se encuentra en la opción **Reproducción**.
2. Utilice   para desplazarse por las imágenes y los videoclips (los videoclips se reproducen de forma automática).

## Eliminación de una imagen

Es posible eliminar imágenes una por una mediante la opción **Reproducción**:

1. Presione  /  hasta que  aparezca un instante en la esquina superior derecha de la Pantalla de imagen. Esto le indica que se encuentra en la opción **Reproducción**.
2. Utilice   para seleccionar una imagen o un videoclip.
3. Presione .
4. Utilice   para seleccionar **Esta imagen** en el submenú **Eliminar** y presione  .

## 5 Transferencia e impresión de imágenes

### Transferencia de imágenes

Si tiene instalado el software HP Photosmart, siga este procedimiento para transferir imágenes y videoclips al equipo. Si no tiene instalado el software HP Photosmart, busque un procedimiento alternativo en la Guía de usuario electrónica.

**Sugerencia** También puede llevar a cabo esta tarea con una base de acoplamiento opcional de la cámara HP Photosmart (consulte la Guía de usuario de la base de acoplamiento).

1. Conecte la cámara al equipo con el cable USB que se incluye con el dispositivo.
2. Encienda la cámara y siga las instrucciones que aparecen en la pantalla del equipo para transferir las imágenes. Para obtener más información, consulte la función Ayuda del software HP Photosmart.



## Impresión de imágenes desde la cámara

Puede conectar la cámara a cualquier impresora con certificación PictBridge para imprimir imágenes fijas.



1. Compruebe que la impresora está encendida, que tiene papel y que no aparecen mensajes de error.

2. Conecte la cámara y la impresora al equipo con el cable USB que se incluye con la cámara, y enciéndala.

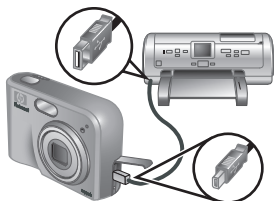







3. Cuando la cámara se conecta a la impresora, se abre el menú **Configurar impresión** en la cámara. Para cambiar la configuración, utilice los botones ▲▼ de la cámara para seleccionar una opción de menú, y ◀▶ para cambiar la configuración.
4. Presione  $\frac{\text{Menu}}{\text{OK}}$  para comenzar a imprimir.

## 6 Referencia rápida de la cámara

Utilice este capítulo como una referencia rápida a las funciones de la cámara. Para conocer a fondo estas funciones, consulte la Guía de usuario electrónica.

### Vista en directo y Reproducción



- La opción **Vista en directo** le permite encuadrar fotografías y videoclips en la Pantalla de imagen. Para activar la opción **Vista en directo**, presione  /  hasta que  aparezca un instante en la esquina superior derecha de la Pantalla de imagen.
- La opción **Reproducción** le permite revisar y trabajar con imágenes y videoclips. Para activar la opción **Reproducción**, presione  /  hasta que  aparezca un instante en la esquina superior derecha de la Pantalla de imagen.

### Menús





Cuando se presiona <sup>Menu</sup>OK en la opción **Reproducción** o **Vista en directo**, se obtiene acceso a los menús de la cámara, en forma de pestañas, como se muestra en la pantalla de ejemplo.



Utilice  $\leftarrow\rightarrow$  para desplazarse al menú que desee. Dentro de cada menú, emplee  $\blacktriangle\blacktriangledown$  para moverse a una selección específica.

Para salir del menú, presione  /  en cualquier momento.

Los menús y las opciones son:

Menú	Opciones
<p> <b>Captura</b> le permite ajustar la configuración de las características de las imágenes y videoclips que tomará en un futuro con la cámara.</p>	<ul style="list-style-type: none"> <li>• Modos de fotografía (Modo automático, Temporizador automático, Disparo rápido, Paisaje, Retrato, Acción, Retrato nocturno, Playa y nieve, Puesta de sol, Ráfaga y Macro).</li> <li>• Calidad imagen</li> <li>• Estampado de fecha y hora</li> <li>• Compensación de exposición</li> <li>• Equilibrio de blanco</li> <li>• Velocidad ISO</li> </ul>
<p> La opción <b>Galería de diseño</b> le permite mejorar las imágenes tomadas.</p>	<ul style="list-style-type: none"> <li>• Eliminar ojos rojos</li> <li>• Modificar el color</li> <li>• Agregar bordes</li> <li>• Rotar</li> <li>• Grabar audio</li> <li>• Mover imágenes a tarjeta</li> </ul>
<p> La ficha <b>Configurar</b> le permite cambiar el comportamiento de la cámara.</p>	<ul style="list-style-type: none"> <li>• Brillo de pantalla</li> <li>• Sonidos de cámara</li> <li>• Fecha y hora</li> <li>• Configuración USB</li> <li>• Configuración TV</li> <li>• Idioma</li> </ul>
<p> La ficha <b>Ayuda</b> le ofrece descripciones de las funciones de la cámara y</p>	<ul style="list-style-type: none"> <li>• Diez mejores sugerencias</li> <li>• Accesorios de la cámara</li> <li>• Botones de la cámara</li> </ul>

Menú	Opciones
sugerencias para tomar fotografías.	<ul style="list-style-type: none"> <li>● Uso de modos de fotografía</li> <li>● Uso de la Galería de diseño</li> <li>● Publicación de imágenes</li> <li>● Impresión de imágenes</li> <li>● Grabación de clips de audio</li> <li>● Grabación de videoclips</li> <li>● Revisión imágenes y vídeos</li> <li>● Eliminación de imágenes</li> <li>● Transferencia de imágenes</li> <li>● Gestión de las pilas</li> <li>● Obtención de asistencia</li> <li>● Métodos abreviados cámara</li> <li>● Acerca de...</li> </ul>

Quando presiona  en las opciones **Vista en directo** o **Reproducción**, se abre el menú **Photosmart Express**.

Menú	Opciones
 El botón <b>Photosmart Express</b> le permite compartir fotografías con familiares y amigos.	<ul style="list-style-type: none"> <li>● Imprimir</li> <li>● Comprar copias en línea</li> <li>● Conf. Compartir</li> </ul>



# HP Photosmart M425/M525 Digitale camera

Nederlands



## Kennisgevingen en handelsmerken

© Copyright 2006 Hewlett-Packard Development Company, L.P.

De informatie in dit document kan zonder voorafgaande kennisgeving worden gewijzigd. De enige garanties voor HP producten en services zijn vastgelegd in de garantieverklaringen bij de betreffende producten en services. Niets in dit document mag worden opgevat als een aanvullende garantiebepaling. HP is niet aansprakelijk voor hierin vervatte technische of redactionele fouten of weglatingen.

Windows® is een in de V.S. gedeponeerd handelsmerk van Microsoft Corporation.



SD Logo is een handelsmerk van de eigenaar.

## Hoe privé-huishoudens in de Europese Unie afgedankte apparatuur als afval dienen aan te bieden



Dit symbool op het product of de verpakking geeft aan dat dit product niet met het gewone afval mag worden weggegooid. In plaats hiervan dient u afgedankte apparatuur in te leveren bij een recycling/inzamelingspunt voor elektrische en elektronische apparatuur. De aparte inzameling en recycling van afgedankte apparatuur zorgt ervoor dat de natuurlijke hulpbronnen behouden blijven en dat de apparatuur zonder nadelige invloed op de gezondheid en het milieu voor hergebruik kan worden verwerkt. Voor meer informatie over het inleveren van apparatuur voor recyclingdoeleinden kunt u contact opnemen met uw gemeente, de uitvoerende dienst of de winkel waar u het product hebt gekocht.

**Voer de volgende informatie in voor later gebruik:**

Modelnummer (op de voorkant van de camera)	
Serienummer (nummer van 10 cijfers op de onderkant van de camera)	
Aankoopdatum van de camera	

Nederlands

# Inhoudsopgave

<b>1</b>	<b>Beginnen</b> .....	5
	De elektronische Gebruikershandleiding openen.....	6
	Bovenkant en achterkant van de camera.....	7
	Voorkant, zijkant en onderkant van de camera.....	9
	Inzetstuk cameradock.....	9
<b>2</b>	<b>De camera gereedmaken voor gebruik</b> .....	11
	De batterijen plaatsen.....	11
	De camera inschakelen.....	12
	De taal kiezen.....	12
	De regio instellen.....	12
	De datum en tijd instellen.....	13
	Een geheugenkaart plaatsen en formatteren (optioneel).....	13
	De software installeren.....	14
<b>3</b>	<b>Foto's maken en videoclips opnemen</b> .....	17
	Een foto nemen.....	17
	Een videoclip opnemen.....	17
<b>4</b>	<b>Foto's en videoclips bekijken en verwijderen</b> .....	19
	Foto's en videoclips bekijken.....	19
	Een opname verwijderen.....	19
<b>5</b>	<b>Opnames overbrengen en afdrukken</b> .....	20
	Opnames overbrengen.....	20
	Opnames vanaf de camera afdrukken.....	21
<b>6</b>	<b>Beknopt overzicht van camerafuncties</b> .....	22

# 1 Beginnen

Dit gedrukte Introductieboekje bevat de informatie die u nodig hebt om de basisfuncties van de camera te kunnen gebruiken. Raadpleeg de elektronische Gebruikershandleiding voor gedetailleerde informatie over de camerafuncties.

Introductieboekje	Elektronische Gebruikershandleiding
<p data-bbox="215 511 495 536">Deze gedrukte handleiding:</p> <ul data-bbox="215 551 510 803" style="list-style-type: none"><li data-bbox="215 551 510 629">• Helpt u snel met uw camera aan de slag te gaan</li><li data-bbox="215 636 510 715">• Bevat informatie over de installatie van de HP Photosmart software</li><li data-bbox="215 722 510 803">• Bevat een introductie tot de functies van de camera</li></ul>	<p data-bbox="533 511 767 562">De elektronische Gebruikershandleiding:</p> <ul data-bbox="533 576 832 1160" style="list-style-type: none"><li data-bbox="533 576 832 629">• Bevat een beschrijvingen van alle camerafuncties</li><li data-bbox="533 636 832 715">• Bevat een beschrijving van de pictogrammen op het LCD-scherm</li><li data-bbox="533 722 832 865">• Geeft een uitleg van het gebruik van de camera zonder de HP Photosmart software te installeren</li><li data-bbox="533 872 832 1160">• Bevat informatie over de batterijen, waaronder:<ul data-bbox="576 936 812 1160" style="list-style-type: none"><li data-bbox="576 936 812 1015">– Het verlengen van de levensduur van de batterijen</li><li data-bbox="576 1022 812 1075">– De verschillende typen batterijen</li><li data-bbox="576 1082 812 1160">– Een beschrijving van de voedingsindicatoren</li></ul></li></ul>

- Het krijgen van ondersteuning van HP
- Het oplossen van problemen
- Cameraspecificaties

## De elektronische Gebruikershandleiding openen



De elektronische Gebruikershandleiding bevindt zich op de cd met de HP Photosmart software.

U opent de Gebruikershandleiding als volgt:

1. Plaats de cd met de HP Photosmart software in het cd-station van uw computer.
2. **In Windows:** Klik op **Gebruikershandleiding weergeven** op de hoofdpagina van het installatiescherm.  
**Op de Macintosh:** Open het bestand **leesmij** in de map **docs** op de cd.

De elektronische Gebruikershandleiding wordt ook naar de computer gekopieerd wanneer u de HP Photosmart software installeert. U opent als volgt de Gebruikershandleiding die op de computer is geïnstalleerd:

- **In Windows:** Open het **HP Solution Center** en klik op **Hulp en ondersteuning**.
- **Op de Macintosh:** Open **HP Apparaatbeheer** en selecteer **Gebruikershandleiding** in het pop-upmenu **Informatie en instellingen**.

## Wanneer u hulp nodig hebt

- Op [www.hp.com/photosmart](http://www.hp.com/photosmart) (alleen in het Engels) of [www.hp.com](http://www.hp.com) vindt u tips en hulpmiddelen voor een effectiever gebruik van de camera.
- Voor hulp bij producten, diagnostische gegevens en het downloaden van drivers bezoekt u [www.hp.com/support](http://www.hp.com/support).
- Raadpleeg de Help bij de HP Photosmart software voor hulp bij het gebruik van deze software.

## Bovenkant en achterkant van de camera

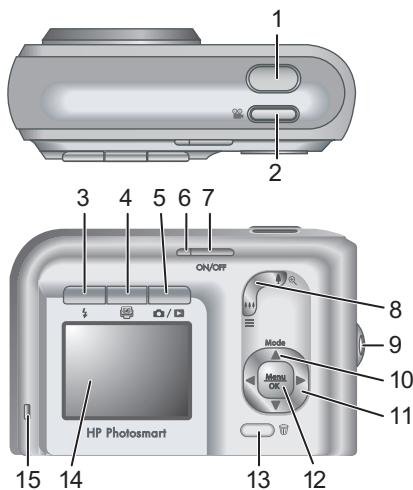

- |   |  |
|---|--|
| 1 | <b>Sluiter-knop.</b>   |
| 2 |  <b>Video-knop.</b> |

3	 <b>Flitser-knop</b> —Instellingen zijn Auto, Rode ogen, Flitser Aan, Flitser Uit.
4	 <b>Photosmart Express-knop</b> —Opties zijn Afdrukken, Afdrukken on line kopen, Delen instellen.
5	 <b>Liveweergave/Weergave-knop</b> —Schakelt tussen <b>Liveweergave</b> en <b>Weergave</b> (zie <i>Liveweergave en Weergave</i> op pagina 22).
6	Voedingslampje.
7	ON/OFF-knop.
8	<b>In-/uitzoomen-knop</b> (digitaal en optisch)—In <b>Liveweergave</b> drukt u op  om in te zoomen en  om uit te zoomen. In <b>Weergave</b> drukt u op  om de geselecteerde opname te vergroten of op  om miniaturen van uw foto's weer te geven.
9	Bevestigingsoog voor polsbandje.
10	<b>Modus-knop</b> —Druk op  om naar het menu <b>Opnamemodus</b> te gaan terwijl u zich in <b>Liveweergave</b> bevindt. Opties zijn Modus Auto, Zelfontspanner, Snel scherp, Landschap, Portret, Actie, Nachtportret, Strand & sneeuw, Zonsondergang, Burst, Macro.
11	  en   -knoppen—Hiermee loopt u door menu's en foto's.
12	 <b>Menu OK</b> -knop—Hiermee opent u cameramenu's, selecteert u opties en bevestigt u acties.
13	 <b>Verwijderen-knop</b> —Hiermee gaat u naar de functie <b>Verwijderen</b> terwijl u zich in <b>Weergave</b> bevindt.
14	LCD-scherm.
15	Lampje voor laden van batterijen.



## Voorkant, zijkant en onderkant van de camera

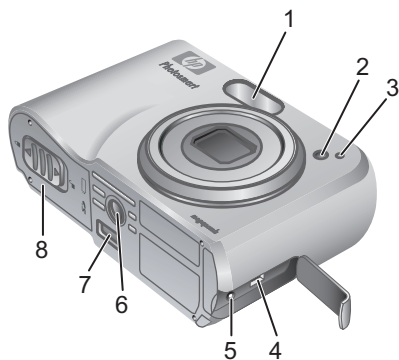

1	Flitser.
2	Lampje van de zelfontspanner.
3	Microfoon.
4	USB-aansluiting.
5	Aansluiting voor voedingsadapter.
6	Statiefbevestigingspunt.
7	Dockaansluiting.
8	Klepje van de batterij/geheugenkaartsleuf.

## Inzetstuk cameradock

Wanneer u een HP Photosmart cameradock aanschaft, wordt dit geleverd met meerdere doorzichtige inzetstukken. Wanneer u het dock gereedmaakt voor gebruik met deze camera, gebruikt u het inzetstuk met het vierkante groene lipje. Raadpleeg de Gebruikershandleiding bij het dock voor instructies.

## 2 De camera gereedmaken voor gebruik

### De batterijen plaatsen

1. Open het klepje van de batterij/geheugenkaartsleuf door het klepje te verschuiven, zoals op het klepje is aangegeven.
2. Plaats de batterijen.
3. Sluit het klepje van de batterij/geheugenkaartsleuf.



**Opmerking** Schakel de camera uit voordat u de batterijen verwijdert. Als u oplaadbare NiMH-batterijen gebruikt, laadt u deze volledig op voordat u ze voor de eerste keer gebruikt.



De levensduur is afhankelijk van het cameragebruik en type batterij. Alkaline-batterijen gaan veel minder lang mee dan Foto Lithium- of NiMH-batterijen Zie appendix A in de elektronische Gebruikershandleiding voor meer informatie.

#### Aantal opnames

Type batterij	Minimaal	Maximaal	Gemiddeld	CIPA
Alkaline	77	180	120	80

NiMH	<b>215</b>	<b>380</b>	<b>290</b>	<b>205</b>
Foto Lithium	<b>365</b>	<b>600</b>	<b>485</b>	<b>423</b>

Het CIPA-aantal is verkregen op basis van de normen die zijn vastgesteld door de "Camera and Imaging Products Association".

## De camera inschakelen

U zet de camera aan door op de knop ON/OFF te drukken.

## De taal kiezen

Gebruik de ▲▼◀▶ om de gewenste taal te kiezen en druk vervolgens op  $\frac{\text{Menu}}{\text{OK}}$ .

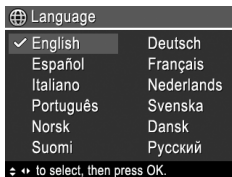

## De regio instellen

Met de instellingen voor **Taal** en **Regio** worden de standaardwaarden bepaald voor de datumnotatie en het type videosignaal voor het weergeven van camerabeelden op een televisie.



Gebruik de ▲▼ om de gewenste regio te kiezen en druk vervolgens op  $\frac{\text{Menu}}{\text{OK}}$ .

## De datum en tijd instellen

1. Gebruik ▲▼ om de markering te verplaatsen.
2. Gebruik ◀▶ om naar de andere keuzemogelijkheden te gaan en herhaal stap 1 tot u de datum en tijd correct hebt ingesteld.
3. Druk op  $\frac{\text{Menu}}{\text{OK}}$  wanneer u de instellingen voor datum, tijd en notatie hebt opgegeven en druk nogmaals op  $\frac{\text{Menu}}{\text{OK}}$  om dit te bevestigen.





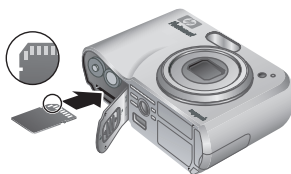

## Een geheugenkaart plaatsen en formatteren (optioneel)

1. Schakel de camera uit en open het klepje van de batterij/geheugenkaartsleuf.
2. Plaats de geheugenkaart in de kleinere sleuf, zoals afgebeeld. Zorg dat de geheugenkaart op zijn plaats klikt.
3. Sluit het klepje van de batterij/geheugenkaartsleuf en zet de camera aan.



U moet een geheugenkaart altijd formatteren voordat u deze voor de eerste keer gebruikt.

1. Zorg dat de camera aan staat en druk op  /  tot  kort in de rechter bovenhoek van het LCD-scherm verschijnt. Dit geeft aan dat **Weergave** actief is.
2. Druk op .
3. Gebruik   om **Kaart formatteren** te markeren in het submenu **Verwijderen** en druk vervolgens op  .
4. Gebruik   om **Ja** te selecteren en druk vervolgens op   om de kaart te formatteren.

Wanneer u een geheugenkaart hebt geplaatst, worden alle nieuwe foto's en videoclips op de kaart en niet in het interne geheugen opgeslagen.

Wanneer u het interne geheugen wilt gebruiken en de daarin opgeslagen opnames wilt bekijken, verwijdert u de geheugenkaart.

## De software installeren

De HP Photosmart software bevat functies voor het overbrengen van foto's en videoclips naar de computer, evenals functies voor het aanpassen van opgeslagen opnames (verwijderen van rode ogen, draaien, bijsnijden, aanpassen van de grootte en beeldkwaliteit, toevoegen van kleuren en speciale effecten, en meer).

Wanneer u problemen hebt bij het installeren of gebruiken van de HP Photosmart software, raadpleegt u website voor HP Klantenzorg: [www.hp.com/support](http://www.hp.com/support).

### Windows

Als uw Windows-computer niet voldoet aan de systeemvereisten, zoals vermeld op de verpakking van de camera, wordt HP Photosmart Essential geïnstalleerd, in plaats van de volledige versie HP Photosmart Premier.

1. Sluit alle programma's en schakel ook eventuele antivirussoftware tijdelijk uit.
2. Plaats de cd met de HP Photosmart software in het cd-station van de computer en volg de instructies op het scherm. Als het installatievenster niet verschijnt, klikt u op **Start, Uitvoeren** en typt u **D:\Setup.exe**, waarbij **D** staat voor de letter van uw cd-station. Klik vervolgens op **OK**.
3. Wanneer u klaar bent met het installeren van de software, schakelt u de virussoftware weer in.

## Macintosh

1. Plaats de cd met de HP Photosmart software in het cd-station.
2. Dubbelklik op het pictogram van het cd-station op het bureaublad van de computer.
3. Dubbelklik op het pictogram van het installatieprogramma en volg de instructies op het scherm.



# 3 Foto's maken en videoclips opnemen

U kunt in **Liveweergave** het onderwerp voor uw foto of videoclip bepalen.

## Een foto nemen

1. Druk op  /  tot  kort in de rechter bovenhoek van het LCD-scherm verschijnt. Dit geeft aan dat **Liveweergave** actief is.
2. Bepaal het onderwerp voor de foto.
3. Druk de knop **Sluiter** half in om de brandpuntsafstand en de benodigde belichtingstijd te vergrendelen. De focuskaders op het LCD-scherm worden groen wanneer de brandpuntsafstand is vergrendeld.
4. Druk de knop **Sluiter** helemaal in om de foto te nemen.
5. Wanneer u een audioclip wilt toevoegen, houdt u de knop **Sluiter** helemaal ingedrukt en laat u deze los wanneer u klaar bent.

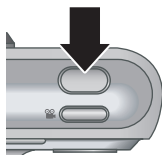

## Een videoclip opnemen



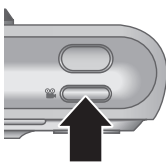

1. Druk op  /  tot  kort in de rechter bovenhoek van het LCD-scherm verschijnt. Dit geeft aan dat **Liveweergave** actief is.
2. Bepaal het onderwerp van de foto.
3. Druk op de knop **Video**  en laat deze weer los.
4. Als u de opname van een videoclip wilt stoppen, drukt u nogmaals op de knop **Video**  en laat u deze weer los.



# 4 Foto's en videoclips bekijken en verwijderen











## Foto's en videoclips bekijken

U kunt in **Weergave** foto's en videoclips bekijken en bewerken.

1. Druk op  /  tot  kort in de rechter bovenhoek van het LCD-scherm verschijnt. Dit geeft aan dat **Weergave** actief is.
2. Gebruik de   om door uw foto's en videoclips te lopen (videoclips worden automatisch afgespeeld).

## Een opname verwijderen

U kunt in **Weergave** afzonderlijke foto's verwijderen:

1. Druk op  /  tot  kort in de rechter bovenhoek van het LCD-scherm verschijnt. Dit geeft aan dat **Weergave** actief is.
2. Gebruik   om een foto of videoclip te selecteren.
3. Druk op .
4. Gebruik   om **Deze opname** te markeren in het submenu **Verwijderen** en druk vervolgens op  .

# 5 Opnames overbrengen en afdrukken

## Opnames overbrengen

Als u de HP Photosmart software hebt geïnstalleerd, gebruikt u deze methode om foto's en videoclips naar uw computer over te brengen. Als u de HP Photosmart software niet hebt geïnstalleerd, raadpleegt u de elektronische Gebruikershandleiding voor een alternatieve methode.

**Tip** U kunt deze taak ook uitvoeren met gebruikmaking van een HP Photosmart cameradock, die apart verkrijgbaar is (zie de Gebruikershandleiding bij het dock).

1. Sluit de camera op de computer aan met gebruikmaking van de USB-kabel die bij de camera is geleverd.
2. Zet de camera aan en volg de instructies op het computerscherm om de opnames over te brengen. Zie de Help bij de HP Photosmart software voor meer informatie.



## Opnames vanaf de camera afdrukken

U kunt vanaf uw camera foto's direct afdrukken op een met PictBridge compatibele printer.





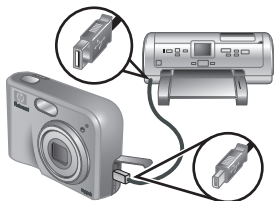



1. Controleer of de printer aan staat, papier bevat en of er geen foutberichten op de printer worden weergegeven.
2. Sluit de camera op de printer aan met gebruikmaking van de USB-kabel die bij de camera is geleverd. Zet vervolgens de camera aan.
3. Wanneer de camera op de printer is aangesloten, verschijnt het **menu Afdrukinstellingen** op de camera. U kunt de instellingen wijzigen door met de ▲▼ op de camera een menuoptie te selecteren en vervolgens met de ◀▶ de instellingen te wijzigen.
4. Druk op  $\frac{\text{Menu}}{\text{OK}}$  om het afdrukken te starten.



## 6 Beknopt overzicht van camerafuncties

Dit hoofdstuk bevat een beknopt overzicht van de camerafuncties. Raadpleeg de elektronische Gebruikershandleiding voor meer informatie over deze camerafuncties.





### Liveweergave en Weergave



- U kunt in **Liveweergave** het onderwerp voor uw foto of videoclip bepalen. U activeert **Liveweergave** door op  /  te drukken tot  kort in de rechter bovenhoek van het LCD-scherm verschijnt.
- U kunt in **Weergave** foto's en videoclips bekijken en bewerken. U activeert **Weergave** door op  /  te drukken tot  kort in de rechter bovenhoek van het LCD-scherm verschijnt.

### Menu's





Wanneer u op  Menu / OK drukt in **Weergave** of **Liveweergave** opent u de tabmenu's, zoals weergegeven in het voorbeeldscherm.



Gebruik   om naar het gewenste menu te gaan. In een menu loopt u met   naar een specifieke instelling.

U kunt het menu weer verlaten door op elk gewenst moment op  /  te drukken.

De menu's en opties zijn:

Menu	Opties
 <b>Opname</b> biedt u de mogelijkheid om de camera-instellingen aan te passen voor foto's en videoclips die u met de camera gaat maken.	<ul style="list-style-type: none"><li>• Opnamemodi (Modus Auto, Zelfontspanner, Snel scherp, Landschap, Portret, Actie, Nachtportret, Strand &amp; sneeuw, Zonsondergang, Burst, Macro).</li><li>• Fotokwaliteit</li><li>• Datum&amp;tijd toevoeg.</li><li>• Belichtingscompensatie</li><li>• Witbalans</li><li>• ISO-snelheid</li></ul>
 <b>Ontwerpgalerie</b> biedt u de mogelijkheid uw opnames te verbeteren.	<ul style="list-style-type: none"><li>• Rode ogen verwijderen</li><li>• Kleur wijzigen</li><li>• Randen toevoegen</li><li>• Draaien</li><li>• Geluid opnemen</li><li>• Opnames naar kaart</li></ul>
 <b>Instellen</b> biedt u de mogelijkheid om het gedrag van de camera aan te passen.	<ul style="list-style-type: none"><li>• Schermhelderheid</li><li>• Camerageluiden</li><li>• Datum &amp; tijd</li><li>• USB-configuratie</li><li>• Tv-configuratie</li><li>• Taal</li></ul>
 <b>Help</b> bevat beschrijvingen van de camerafuncties en tips voor het nemen van foto's.	<ul style="list-style-type: none"><li>• Toptien handigste tips</li><li>• Camera-accessoires</li><li>• Cameraknoppen</li><li>• Opnamemodi gebruiken</li><li>• Ontwerpgalerie gebruiken</li></ul>

Menu	Opties
	<ul style="list-style-type: none"><li>• Opnames delen</li><li>• Foto's afdrukken</li><li>• Audioclips opnemen</li><li>• Videoclips opnemen</li><li>• Foto's en video bekijken</li><li>• Opnames verwijderen</li><li>• Opnames overbrengen</li><li>• Batterijbeheer</li><li>• Hulp en ondersteuning</li><li>• Camerasneltoetsen</li><li>• Info...</li></ul>

Wanneer u op  in **Liveweergave** of **Weergave** drukt, verschijnt het **menu Photosmart Express**.

Menu	Opties
 <b>Photosmart Express</b> biedt u de mogelijkheid uw foto's met vrienden en familie te delen.	<ul style="list-style-type: none"><li>• Afdrukken</li><li>• Afdrukken on line kopen</li><li>• Delen instellen</li></ul>



# Câmera digital HP Photosmart M425 M525

Português



## Informações e avisos legais

© Copyright 2006 Hewlett-Packard Development Company, L.P.

As informações aqui contidas estão sujeitas a alterações sem aviso prévio. As únicas garantias para produtos e serviços HP são dispostas nas declarações de garantia expressa que acompanham cada produto e serviço. Nenhuma informação aqui contida pode ser interpretada como uma garantia adicional. A HP não será responsabilizada por erros técnicos ou editoriais, nem por omissões aqui contidas.

Windows® é uma marca registrada da Microsoft Corporation nos Estados Unidos.



O logotipo SD é uma marca comercial de seu proprietário.

## Equipamento gasto descartado por usuários domésticos na União Européia



Este símbolo no produto ou em sua embalagem indica que o mesmo não deve ser descartado na lixeira doméstica comum. Em vez disso, a sua responsabilidade ao descartar o equipamento gasto é levá-lo a pontos de coleta seletiva designados, visando a reciclagem de equipamentos elétricos e eletrônicos. A coleta seletiva e a reciclagem de equipamento gasto no momento do descarte ajudam a preservar os recursos naturais e a garantir que o equipamento seja reciclado de modo a proteger a saúde humana e o meio ambiente. Para obter mais informações sobre os locais onde você pode depositar seus equipamentos gastos para reciclagem, entre em contato com a prefeitura local, o serviço de coleta de lixo doméstico ou a loja onde você comprou o produto.

**Para referência futura, insira as seguintes informações:**

Número do modelo (na parte frontal da câmera)	
Número de série (número de 10 dígitos na parte inferior da câmera)	
Data de compra da câmera	

# Conteúdo

<b>1</b>	<b>Introdução</b> .....	5
	Exibir a versão eletrônica do Guia do Usuário.....	6
	Partes superior e traseira da câmera.....	7
	Partes frontal, lateral e inferior da câmera.....	9
	Acessório da estação de acoplamento da câmera.....	9
<b>2</b>	<b>Configurar a câmera</b> .....	11
	Instalar as baterias.....	11
	Ligar a câmera.....	12
	Escolher o idioma.....	12
	Definir a região.....	12
	Definir data e hora.....	12
	Instalar e formatar um cartão de memória opcional.....	13
	Instalar o software.....	14
<b>3</b>	<b>Fotografar e gravar clipes de vídeo</b> .....	16
	Capturar uma imagem estática.....	16
	Gravar um clipe de vídeo.....	16
<b>4</b>	<b>Examinar e excluir imagens e clipes de vídeo</b> .....	18
	Examinar imagens e clipes de vídeo.....	18
	Excluir uma imagem.....	18
<b>5</b>	<b>Transferir e imprimir imagens</b> .....	19
	Transferir imagens.....	19
	Imprimir imagens da câmera.....	19
<b>6</b>	<b>Consulta rápida da câmera</b> .....	21

# 1 Introdução

Este Guia de Início Rápido fornece as informações necessárias para começar a usar os recursos básicos da câmera. Para obter informações detalhadas sobre os recursos da câmera, consulte a versão eletrônica do Guia do Usuário.

<b>Guia de Início Rápido</b>	<b>Versão eletrônica do Guia do Usuário</b>
<p>Este guia impresso lhe ajudará a:</p> <ul style="list-style-type: none"><li>• Começar a usar sua câmera rapidamente</li><li>• Instalar o software HP Photosmart</li><li>• Apresentar os recursos da câmera</li></ul>	<p>A versão eletrônica do Guia do Usuário contém:</p> <ul style="list-style-type: none"><li>• Descrições de todos os recursos da câmera</li><li>• Descrições dos ícones do Visor de imagens.</li><li>• Como usar a câmera sem instalar o software HP Photosmart</li><li>• Informações sobre bateria, incluindo:<ul style="list-style-type: none"><li>– Como prolongar a vida útil da bateria</li><li>– Os diversos tipos de baterias</li><li>– Descrições dos ícones de indicação de energia</li></ul></li><li>• Como obter assistência da HP</li><li>• Solução de problemas</li><li>• Especificações da câmera</li></ul>

## Exibir a versão eletrônica do Guia do Usuário



A versão eletrônica do Guia do Usuário encontra-se no CD do software HP Photosmart.

Para exibir o Guia do Usuário:

1. Insira o CD do software HP Photosmart na unidade de CD do computador.
2. **No Windows:** Clique em **Exibir Guia do Usuário** na página principal da tela de instalação.  
**No Macintosh:** Abra o arquivo **readme** (leíame), que se encontra na pasta **docs** no CD.

A versão eletrônica do Guia do Usuário também é copiada para o seu computador durante a instalação do software HP Photosmart. Para exibir o Guia do Usuário após a sua instalação no computador:

- **No Windows:** Abra a **Central de Soluções HP** e clique em **Ajuda e suporte**.
- **No Macintosh:** Abra o **Gerenciador de dispositivos HP** e selecione **Guia do Usuário** no menu pop-up **Information and Setting** (Informações e configurações).

### Como obter assistência







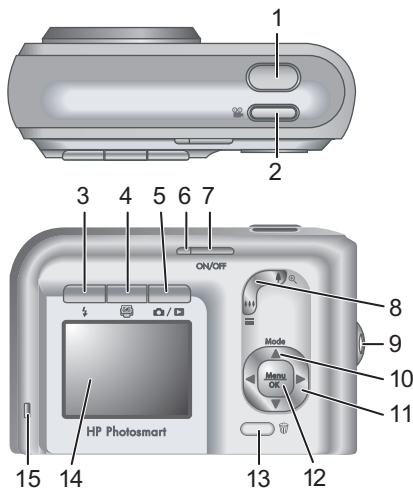

- Para obter dicas e ferramentas para auxiliar no uso mais eficiente da câmera, visite **[www.hp.com/photosmart](http://www.hp.com/photosmart)** (Somente em inglês) ou **[www.hp.com](http://www.hp.com)**.
- Para obter assistência, diagnósticos e download de drivers do produto 24 horas por dia, 7 dias por semana, visite **[www.hp.com/support](http://www.hp.com/support)**.

- Para obter ajuda sobre o software HP Photosmart, consulte o recurso de Ajuda no software HP Photosmart.

## Partes superior e traseira da câmera



1	Botão <b>Obturador</b> .
2	Botão <b>Vídeo</b> .
3	Botão <b>Flash</b> — As opções são Flash automático, Olho vermelho, Flash ligado e Flash desligado.
4	Botão <b>Photosmart Express</b> — As opções são Imprimir, Encomendar impressões online, Config. Compartilhar.
5	Botão <b>Exibição ao vivo/Reproduzir</b> — Alterna entre <b>Exibição ao vivo</b> e <b>Reproduzir</b> (consulte <i>Exibição ao vivo</i> e <i>Reproduzir</i> na página 21).

6	Luz de alimentação.
7	ON/OFF.
8	Acionador de <b>Zoom</b> (Digital e Óptico) — Em <b>Exibição ao vivo</b> , pressione  para ampliar ou pressione  para reduzir. No modo <b>Reproduzir</b> , pressione  para ampliar a imagem selecionada ou pressione  para exibir miniaturas das imagens.
9	Base da alça de pulso.
10	Botão <b>Modo</b> — Pressione  para acessar o menu <b>Modo Fotografia</b> durante a <b>Exibição ao vivo</b> . As opções são Modo automático, Timer interno, Foto rápida, Paisagem, Retrato, Ação, Retrato noturno, Praia e neve, Pôr-do-sol, Disparo e Macro.
11	 e  — Percorrem os menus e as imagens.
12	 — Exibe menus da câmera, seleciona opções e confirma ações.
13	 Botão <b>Excluir</b> — Acessa a função <b>Excluir</b> no modo <b>Reproduzir</b> .
14	Visor de imagens.
15	Luz de energia da bateria.



## Partes frontal, lateral e inferior da câmara

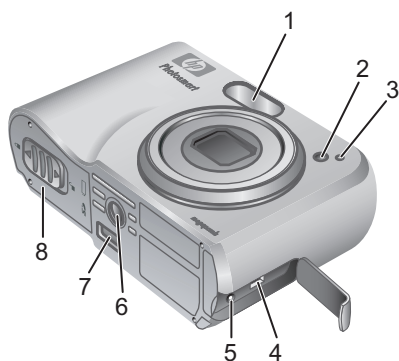

1	Flash.
2	Luz do timer interno.
3	Microfone.
4	Conector USB.
5	Conector do adaptador de energia.
6	Base do tripé.
7	Conector de estação.
8	Compartimento de bateria/cartão de memória.

## **Acessório da estação de acoplamento da câmera**

Se você adquirir uma estação opcional de acoplamento da câmera HP Photosmart, virá acompanhada de vários acessórios. Ao preparar a estação de acoplamento para uso com esta câmera, use o acessório da estação com a etiqueta quadrada verde. Consulte o Guia do Usuário da estação para obter instruções.

## 2 Configurar a câmera

### Instalar as baterias

1. Abra a porta do compartimento de bateria/cartão de memória deslizando a trava da porta conforme indicado na mesma.
2. Coloque as baterias.
3. Feche o compartimento de bateria/cartão de memória.



**Nota** Desligue a câmera antes de remover as baterias. Se estiver utilizando baterias recarregáveis NiMH, carregue-as completamente antes de utilizá-las pela primeira vez.



O uso da câmera e o tipo da bateria influenciam na duração das baterias. Baterias alcalinas têm duração menor do que baterias de lítio ou NiMH. Para obter informações completas, consulte o Apêndice A na versão eletrônica do Guia do Usuário.

**Número de fotos**

Tipo de bateria	Mínimo	Máximo	Médio	CIPA
Alcalina	77	180	120	80
NiMH	215	380	290	205
Lítio	365	600	485	423

O número CIPA é obtido por meio dos padrões estabelecidos pela Camera and Imaging Products Association.

## Ligar a câmera

Para ligar a câmera, pressione o botão ON/OFF.

## Escolher o idioma

Use os botões das setas ▲▼  
◀▶ para selecionar o idioma  
desejado e pressione  $\frac{\text{Menu}}{\text{OK}}$ .

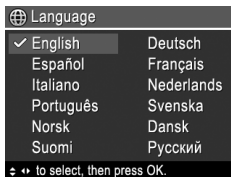

## Definir a região

Junto com a configuração do **Idioma**, a configuração de **Região** determina o formato padrão para data e o formato do sinal de vídeo para exibição das imagens da câmera em televisores.

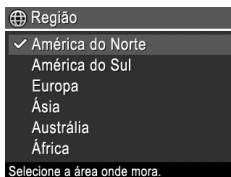

Use ▲▼ para escolher a região desejada e pressione  $\frac{\text{Menu}}{\text{OK}}$ .

## Definir data e hora

1. Use ▲▼ para ajustar o valor destacado.
2. Use ▶◀ para passar às outras seleções e repita a Etapa 1 até que a data e a hora tenham sido definidas corretamente.

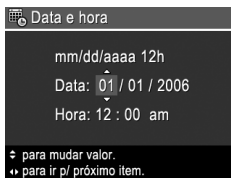

3. Pressione  $\frac{\text{Menu}}{\text{OK}}$  quando as informações de data, hora e formato estiverem corretas e pressione  $\frac{\text{Menu}}{\text{OK}}$  novamente para confirmar.

## Instalar e formatar um cartão de memória opcional

1. Desligue a câmera e abra o compartimento de bateria/cartão de memória.
2. Insira o cartão de memória opcional no slot menor, conforme mostrado. Verifique se o cartão de memória está fixo no lugar.
3. Feche o compartimento de bateria/cartão de memória e ligue a câmera.

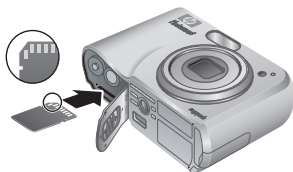

Sempre formate os cartões de memória antes de usar pela primeira vez.

1. Com a câmera ligada, pressione  $\text{📷} / \text{▶}$  até que  $\text{▶}$  seja exibido rapidamente no canto superior direito do Visor de imagens. Isso indica que você está no modo **Reproduzir**.
2. Pressione  $\text{🗑}$ .
3. Use  $\blacktriangle / \blacktriangledown$  para selecionar **Formatar cartão** no submenu **Excluir** e pressione  $\frac{\text{Menu}}{\text{OK}}$ .
4. Use  $\blacktriangle / \blacktriangledown$  para selecionar **Sim** e pressione  $\frac{\text{Menu}}{\text{OK}}$  para formatar o cartão.

Após instalar um cartão de memória, todas as novas imagens e clipes de vídeo ficarão armazenados no cartão, em vez da memória interna.

Para usar a memória interna e exibir imagens lá armazenadas, remova o cartão de memória.

## Instalar o software

O software HP Photosmart oferece recursos para transferir imagens e clipes de vídeo para o computador, bem como recursos para modificar imagens armazenadas (corrigir olhos vermelhos, girar, cortar, redimensionar, ajustar a qualidade da imagem, adicionar cores e efeitos especiais, entre outros).

Se você tiver dificuldade na instalação ou no uso do software HP Photosmart, consulte o site de Atendimento ao Cliente HP para obter mais informações:  
**[www.hp.com/support](http://www.hp.com/support)**.

### Windows:

Se o seu computador Windows não atender os requisitos de sistema indicados na embalagem da câmera, o HP Photosmart Essencial será instalado em vez da versão completa HP Photosmart Premier.

1. Feche todos os programas e desative temporariamente todos os programas antivírus.
2. Insira o CD do software HP Photosmart na unidade de CD e siga as instruções na tela. Se a tela de instalação não for exibida, clique em **Iniciar**, clique em **Executar**, digite **D:\Setup.exe**, onde **D** é a letra da sua unidade de CD, e clique em **OK**.
3. Quando a instalação do software for concluída, reative o programa antivírus.



## Macintosh

1. Insira o CD do software HP Photosmart na unidade de CD.
2. Na área de trabalho, clique duas vezes no ícone do CD.
3. Clique duas vezes no ícone do instalador e siga as instruções na tela.

# 3 Fotografar e gravar clipes de vídeo

A **Exibição ao vivo** permite enquadrar fotos e clipes de vídeo no Visor de imagens.



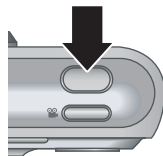

## Capturar uma imagem estática

1. Pressione  /  até que  seja exibido rapidamente no canto superior direito do Visor de imagens. Isso indica que você está no modo **Exibição ao vivo**.
2. Enquadre o objeto da foto no visor.
3. Pressione o botão **Obturador** até a metade para travar o foco e a exposição. Os colchetes do foco no Visor de imagens ficam de cor verde intenso quando o foco é travado.
4. Pressione o botão **Obturador** até o fim para tirar a foto.
5. Para adicionar um clipe de áudio, mantenha o botão **Obturador** pressionado e solte quando terminar.





## Gravar um clipe de vídeo



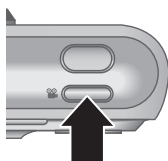

1. Pressione  /  até que  seja exibido rapidamente no canto superior direito do Visor de imagens. Isso indica que você está no modo **Exibição ao vivo**.
2. Enquadre o objeto da foto.
3. Pressione e solte o botão **Vídeo** .
4. Pressione e solte o botão **Vídeo**  novamente.



## 4 Examinar e excluir imagens e clipes de vídeo











### Examinar imagens e clipes de vídeo

É possível examinar e manipular imagens e clipes de vídeo em **Reproduzir**.

1. Pressione  /  até que  seja exibido rapidamente no canto superior direito do Visor de imagens. Isso indica que você está no modo **Reproduzir**.
2. Use   para percorrer as imagens e os clipes de vídeo (os clipes de vídeo são reproduzidos automaticamente).

### Excluir uma imagem

Você pode excluir imagens individualmente durante o modo **Reproduzir**:

1. Pressione  /  até que  seja exibido rapidamente no canto superior direito do Visor de imagens. Isso indica que você está no modo **Reproduzir**.
2. Use o   para selecionar uma imagem ou um clipe de vídeo.
3. Pressione .
4. Use   para selecionar **Esta imagem** no submenu **Excluir** e pressione  .

# 5 Transferir e imprimir imagens

## Transferir imagens

Se você tiver instalado o software HP Photosmart, use este método para transferir imagens e clipes de vídeo para o computador. Se você não tiver instalado o software HP Photosmart, consulte a versão eletrônica do Guia do Usuário para encontrar um método alternativo.

**Dica** Você pode também realizar essa tarefa usando uma estação opcional de acoplamento da câmera HP Photosmart (consulte o Guia do Usuário da estação).

1. Conecte a câmera e o computador com o cabo USB que acompanha a câmera.
2. Ligue a câmera e siga as instruções na tela do computador para transferir as imagens. Para obter mais informações, consulte o recurso de Ajuda no programa HP Photosmart.



## Imprimir imagens da câmera

Você pode conectar a câmera a qualquer impressora certificada pela PictBridge para imprimir imagens estáticas.



1. Verifique se a impressora está ligada, se há papel e se não há mensagens de erro na impressora.
2. Conecte a câmera e o computador com o cabo USB que acompanha a câmera.
3. Quando a câmera estiver conectada à impressora, o menu

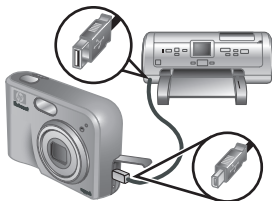

### **Configurar**







**impressão** será exibido na câmera. Para alterar as configurações, use ▲▼ na câmera para selecionar uma opção do menu, depois use ◀▶ na câmera para alterar a configuração.

4. Pressione  $\frac{\text{Menu}}{\text{OK}}$  para iniciar a impressão.

## 6 Consulta rápida da câmera

Use este capítulo como um guia de consulta rápida dos recursos da câmera. Para saber mais sobre os recursos da câmera, consulte a versão eletrônica do Guia do Usuário.



### Exibição ao vivo e Reproduzir



- A **Exibição ao vivo** permite enquadrar fotos e clipes de vídeo no Visor de imagens. Para ativar a **Exibição ao vivo**, pressione  /  até que  seja exibido rapidamente no canto superior direito do Visor de imagens.
- **Reproduzir** permite que você examine e manipule imagens estáticas e clipes de vídeo. Para ativar o modo **Reproduzir**, pressione  /  até que  seja exibido rapidamente no canto superior direito do Visor de imagens.

### Menus





Ao pressionar o  no modo **Reproduzir** ou **Exibição ao vivo**, você tem acesso aos menus com guias da câmera, como mostrado na tela de exemplo.



Use  para mover até o menu desejado. Dentro de um menu, use  para mover-se até opções específicas.

Para sair do menu, pressione  /  a qualquer momento.

Os menus e as opções são:

Menu	Opções
<p> <b>Capturar</b> permite ajustar as configurações da câmera que afetam as características das futuras imagens e clipes de vídeo que você capturar com a câmera.</p>	<ul style="list-style-type: none"> <li>• Modos de fotografia (Modo automático, Timer interno, Foto rápida, Paisagem, Retrato, Ação, Retrato noturno, Praia e neve, Pôr-do-sol, Disparo e Macro).</li> <li>• Qualidade da imagem</li> <li>• Gravação de data e hora</li> <li>• Compensação da exposição</li> <li>• Balanço de branco</li> <li>• Velocidade ISO</li> </ul>
<p> <b>Galeria de projetos</b> permite que você aprimore as imagens capturadas.</p>	<ul style="list-style-type: none"> <li>• Corrigir olhos vermelhos</li> <li>• Modificar cor</li> <li>• Adicionar bordas</li> <li>• Girar</li> <li>• Gravar áudio</li> <li>• Mover imagens para cartão</li> </ul>
<p> <b>Configuração</b> permite alterar o comportamento da câmera.</p>	<ul style="list-style-type: none"> <li>• Brilho do visor</li> <li>• Sons da câmera</li> <li>• Data e hora</li> <li>• Configuração USB</li> <li>• Configuração de TV</li> <li>• Idioma</li> </ul>
<p> <b>Ajuda</b> fornece descrições dos recursos da câmera e dicas de fotografia.</p>	<ul style="list-style-type: none"> <li>• As dez dicas principais</li> <li>• Acessórios da câmera</li> <li>• Botões da câmera</li> <li>• Usar os modos de fotografia</li> </ul>

Menu	Opções
	<ul style="list-style-type: none"> <li>• Usar a Galeria de projetos</li> <li>• Compartilhar imagens</li> <li>• Imprimir imagens</li> <li>• Gravar clipes de áudio</li> <li>• Gravar clipes de vídeo</li> <li>• Examinar imagens e vídeos</li> <li>• Excluir imagens</li> <li>• Transferir imagens</li> <li>• Gerenciar pilhas</li> <li>• Obter assistência</li> <li>• Atalhos da câmera</li> <li>• Sobre...</li> </ul>

Quando você pressionar  no modo **Exibição ao vivo** ou **Reproduzir**, será exibido o **menu Photosmart Express**.

Menu	Opções
 <b>Photosmart Express</b> permite compartilhar suas fotos com seus amigos e familiares.	<ul style="list-style-type: none"> <li>• Imprimir</li> <li>• Encomendar impressões on-line</li> <li>• Config. Compartilhar</li> </ul>

Português





התפריט	האפשרויות
	<ul style="list-style-type: none"> <li>• Transferring Images (העברת תמונות)</li> <li>• Managing Batteries (טיפול בסוללות)</li> <li>• Getting Assistance (קבלת סיוע)</li> <li>• Camera Shortcuts (קיצורי דרך של המצלמה)</li> <li>• About... (אודות...)</li> </ul>

לחיצה על לחצן  במצב **Live View** (תצוגה חיה) או במצב **Playback** (הקרנה חוזרת), תגרום להופעת **תפריט Photosmart Express**.

התפריט	האפשרויות
<p>תפריט <b>Photosmart Express</b>  יאפשר לך לחלוק את התצלומים שלך עם חברים וקרובים.</p>	<ul style="list-style-type: none"> <li>• Print (הדפסה)</li> <li>• Buy Prints Online (רכישת תדפיסים במקוון)</li> <li>• Share Setup (הגדרות שיתוף)</li> </ul>

התפריט	האפשרויות
תפריט  <b>Setup</b> (הגדרות) אפשר לך לשנות את התנהגות המצלמה.	<ul style="list-style-type: none"> <li>• Display Brightness (בהירות הצג)</li> <li>• Camera Sounds (צלילי מצלמה)</li> <li>• Date &amp; Time (תאריך ושעה)</li> <li>• USB Configuration (תצורת USB)</li> <li>• TV Configuration (תצורת טלוויזיה)</li> <li>• Language (שפה)</li> </ul>
תפריט <b>Help ?</b> (עזרה) מציע תיאור של מאפייני המצלמה ועצות לצילום.	<ul style="list-style-type: none"> <li>• Top Ten Tips (עשרת העצות החשובות)</li> <li>• Camera Accessories (אבזרי המצלמה)</li> <li>• Camera Buttons (לחצני המצלמה)</li> <li>• Using Shooting Modes (שימוש במצבי הצילום)</li> <li>• Using Design Gallery (שימוש בגלריית העיצוב)</li> <li>• Sharing Images (שיתוף תמונות)</li> <li>• Printing Images (הדפסת תמונות)</li> <li>• Recording Audio Clips (הקלטת קטעי שמע)</li> <li>• Recording Video Clips (הקלטת סרטוני וידאו)</li> <li>• Reviewing Images and Videos (סקירת תמונות וסרטוני וידאו)</li> <li>• Deleting Images (מחיקת תמונות)</li> </ul>

להלן רשימת התפריטים והאפשרויות:

האפשרויות	התפריט
<ul style="list-style-type: none"> <li>• Shooting Modes (מצבי צילום): Auto Mode, Self-Fast Shot, Timer, Portrait, Landscape, Night Portrait, Action, Beach and Snow, Macro, Burst, Sunset</li> <li>• (בהתאמה: מצב אוטומטי, קוצב זמן עצמי, צילום מהיר, נוף, דיוקן, תנועה, דיוקן לילי, חוף ושלג, שקיעה, רציף, מקארו).</li> <li>• Image Quality (איכות תמונה)</li> <li>• Date &amp; Time Imprint (הטבעת תאריך ושעה)</li> <li>• Exposure Compensation (פיצוי חשיפה)</li> <li>• White Balance (איזון לבן)</li> <li>• ISO Speed (מהירות ISO)</li> </ul>	<p>תפריט <b>Capture</b>  (צילום) מאפשר לך לקבוע את הגדרות המצלמה המשפיעות על מאפייני התמונות וסרטוני הווידאו הבאים שתצלם במצלמה שלך.</p>
<ul style="list-style-type: none"> <li>• Remove Red Eyes (הסרת עיניים אדומות)</li> <li>• Modify Color (שינוי צבע)</li> <li>• Add Borders (הוספת גבולות)</li> <li>• Rotate (סיבוב)</li> <li>• Record Audio (הקלטת קול)</li> <li>• Move Images to Card (העברת תמונות לכרטיס)</li> </ul>	<p><b>Design Gallery</b>  באמצעות (גלריית עיצוב) תוכל לשפר את התמונות שכבר צילמת.</p>

## 6 מדריך ההפעלה המהיר

היעזר בפרק זה כחומר עיון מהיר בנוגע למאפייני המצלמה. כדי ללמוד פרטים נוספים על המאפיינים הללו, עיין במדריך למשתמש במתכונתו האלקטרונית.





### מצבי Live View ו-Playback (תצוגה חיה והקרנה חוזרת)



- המאפיין **Live View** (תצוגה חיה) מאפשר לתחום תמונות וסרטוני וידאו בצג התמונות. כדי להפעיל את **Live View** (תצוגה חיה), לחץ על לחצן  /  (תצוגה חיה/הקרנה חוזרת) עד אשר הסמל  יופיע לרגע בפינה הימנית העליונה של צג התמונות.
- במצב **Playback** (הקרנה חוזרת), תוכל לסקור תמונות וסרטוני וידאו ולערוך בהם שינויים. כדי להפעיל את **Playback** (הקרנה חוזרת), לחץ על לחצן  /  (תצוגה חיה/הקרנה חוזרת) עד אשר הסמל  יופיע לרגע בפינה הימנית העליונה של צג התמונות.

### תפריטים



אם תלחץ על לחצן <sup>Menu</sup>OK ממצב **Playback** (הקרנה חוזרת) או **Live View** (תצוגה חיה), תקבל גישה לתפריטי המצלמה, הנראים בתמונת המסך הבאה.

השתמש בלחצנים   כדי להגיע לתפריט הרצוי. בתוך התפריט, השתמש בלחצנים   כדי לעבור לפריטים ספציפיים.

כדי לצאת מתפריט, לחץ בכל עת על לחצן  / .

## הדפסת תמונות מהמצלמה



באפשרותך לחבר את המצלמה ישירות לכל מדפסת התומכת ב- PictBridge לצורך הדפסת התמונות.

1. ודא שהמדפסת מופעלת וטעונה בנייר, וכי אין שום הודעת שגיאה של המדפסת.
2. חבר את המצלמה למדפסת בעזרת כבל ה-USB המצורף למצלמה, והפעל את המצלמה.
3. עם חיבור המצלמה למדפסת, יופיע במצלמה התפריט **Print Setup Menu** (הגדרות הדפסה).  
כדי לשנות הגדרות, השתמש בלחצנים ▲▼ במצלמה כדי לבחור פריט רצוי מתוך התפריט, ולאחר מכן השתמש בלחצנים ◀▶ כדי לשנות את ההגדרה כרצונך.
4. כדי להתחיל בהדפסה, לחץ על **Menu** / **OK**.

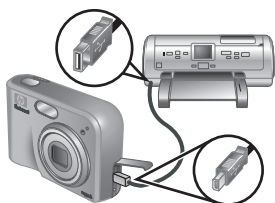

# 5 העברה והדפסה של תמונות

## העברת תמונות

אם התקנת את תוכנת HP Photosmart, השתמש בשיטה הבאה כדי להעביר תמונות וסרטוני וידאו מהמצלמה למחשב. אם לא התקנת את תוכנת HP Photosmart, עיין במדריך למשתמש במתכונתו האלקטרונית כדי ללמוד את השיטה החלופית.

**עצה** באפשרותך לבצע פעולה זו גם בעזרת תושבת עגינה אופציונלית HP Photosmart (עיין בסעיפים על התושבת במדריך למשתמש).







1. חבר את המצלמה למחשב בעזרת כבל ה-USB המצורף למצלמה.
2. כדי להעביר את התמונות, הפעל את המצלמה ופעל לפי ההוראות שיופיעו על מסך המחשב. לקבלת פרטים נוספים, עיין במאפיין העזרה בתוכנת HP Photosmart.

# 4 סקירה ומחיקה של תמונות וסרטוני וידאו











## סקירת תמונות וסרטוני וידאו

באפשרותך לסקור ולערוך שינויים בתמונות ובסרטוני וידאו במצב **Playback** (הקרנה חוזרת).

1. לחץ על לחץ על לחצן  /  (תצוגה חיה/הקרנה חוזרת) עד אשר הסמל  יופיע לרגע בפינה הימנית העליונה של צג התמונות. פירוש הדבר שעברת למצב **Playback** (הקרנה חוזרת).
2. השתמש בלחצנים   כדי לגלול תמונות וסרטוני וידאו (סרטוני וידאו יופעלו באופן אוטומטי).

## מחיקת תמונה

באפשרותך למחוק תמונות כרצונך במצב **Playback** (הקרנה חוזרת):

1. לחץ על לחצן  /  (תצוגה חיה/הקרנה חוזרת) עד אשר הסמל  יופיע לרגע בפינה הימנית העליונה של צג התמונות. פירוש הדבר שעברת למצב **Playback** (הקרנה חוזרת).
2. השתמש בלחצנים   כדי לבחור תמונה או סרטון וידאו.
3. לחץ על  (מחיקה).
4. השתמש בלחצנים   כדי לבחור את הפריט **This Image** (תמונה נוכחית) מתוך תפריט המשנה **Delete** (מחיקה), ולאחר מכן לחץ על   (תפריט/אישור).

# 3 צילום תמונות והקלטת סרטוני וידאו

המאפיין **Live View** (תצוגה חיה) מאפשר לתחום תמונות וסרטוני וידאו בצג התמונות.

## צילום תמונה

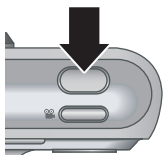

1. לחץ על לחצן / (תצוגה חיה) / הקרנה חוזרת) עד אשר הסמל יופיע לרגע בפינה הימנית העליונה של צג התמונות. פירוש הדבר שעברת למצב **Live View** (תצוגה חיה).
2. תחום את נושא התמונה שלך.
3. לחץ לחיצה חלקית על לחצן **התריס**, כדי למדוד ולנעול את החשיפה ואת המיקוד. תוחמי המיקוד בצג התמונות מופיעים בצבע ירוק יציב כאשר המיקוד ננעל.
4. לחץ לחיצה מלאה על לחצן **התריס** כדי לצלם את התמונה.
5. כדי להוסיף סרטון וידאו, המשך להחזיק את לחצן **התריס** לחוץ, ושחרר אותו כדי לסיים את הקלטה.

## הקלטת סרטון וידאו

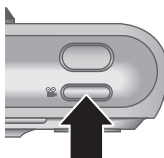

1. לחץ על לחצן / (תצוגה חיה) / הקרנה חוזרת) עד אשר הסמל יופיע לרגע בפינה הימנית העליונה של צג התמונות. פירוש הדבר שעברת למצב **Live View** (תצוגה חיה).
2. תחום את נושא התמונה שלך.
3. לחץ על לחצן **הווידאו** ושחרר אותו.
4. כדי לעצור את ההקלטה, לחץ פעם נוספת על לחצן **הווידאו** ושחרר אותו.



## התקנת התוכנה

תוכנת HP Photosmart כוללת מאפיינים להעברת תמונות וסרטוני וידאו אל המחשב, וכן מאפיינים לעריכת שינויים בתמונות מאוחסנות (הסרת עיניים אדומות, סיבוב, חיתוך, שינוי גודל, שינוי איכות התמונה, הוספת צבעים, אפקטים מיוחדים, ועוד).

אם אתה נתקל בבעיה בהתקנת התוכנה HP Photosmart או בשימוש בה, בקר באתר האינטרנט של שירות הלקוחות של HP לקבלת מידע נוסף: [www.hp.com/support](http://www.hp.com/support).



### Windows

אם המחשב ומערכת Windows שברשותך אינם עונים על דרישות המערכת כפי שפורטו על אריזת המצלמה, תותקן במחשב גרסת HP Photosmart Essential במקום הגרסה המלאה - HP Photosmart Premier.

1. סגור את כל התוכניות והשבת באופן זמני את כל תוכנות האנטי-וירוס המופעלות במחשב.
2. הכנס את תקליטור התוכנה HP Photosmart לכונן התקליטורים של המחשב, ופעל לפי ההוראות שעל המסך. אם חלון ההתקנה אינו מופיע, לחץ על **התחל**, לחץ על **הפעלה**, הקלד **D:\Setup.exe**, כאשר **D** הוא אות כונן התקליטורים, ולאחר מכן לחץ על **אישור**.
3. עם סיום התקנת התוכנה, הפעל מחדש את תוכנות האנטי-וירוס.

### Macintosh

1. הכנס את התקליטור עם תוכנת HP Photosmart לכונן התקליטורים של המחשב.
2. לחץ לחיצה כפולה על סמל התקליטור בשולחן העבודה.
3. לחץ לחיצה כפולה על סמל ההתקנה, ולאחר מכן פעל בהתאם להנחיות ההתקנה המוצגות על המסך.

3. אם הגעת להגדרת תאריך ושעה כרצונך, לחץ על  על (תפריט/אישור) ולאחר מכן אשר בלחיצה נוספת על  על (תפריט/אישור).

## התקנה והגדרה של כרטיס זיכרון אופציונלי

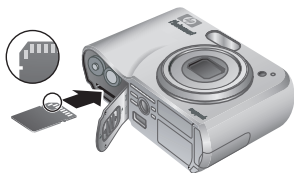

1. כבה את המצלמה ופתח את דלת הסוללות/כרטיס הזיכרון.
2. הכנס את כרטיס הזיכרון האופציונלי לחריץ הקטן יותר, כמו באיור. ודא שכרטיס הזיכרון נכנס למקומו בנקישה.
3. סגור את דלת הסוללות/כרטיס הזיכרון, והפעל את המצלמה.

הקפד תמיד לאתחל את כרטיסי הזיכרון לפני השימוש הראשון.

1. כאשר המצלמה מופעלת, לחץ על  /  (תצוגה חיה/הקרנה חוזרת) עד אשר הסמל  (הקרנה חוזרת) יופיע לרגע בפניה הימנית העליונה של צג התמונות. פירוש הדבר שעברת למצב **Playback** (הקרנה חוזרת).
2. לחץ על  (מחיקה).
3. השתמש בלחצנים   כדי לבחור את הפריט **Format Card** (אתחל כרטיס) מתוך תפריט המשנה **Delete** (מחיקה), ולאחר מכן לחץ על  על (תפריט/אישור).
4. השתמש בלחצנים   כדי לבחור באפשרות **Yes** (כן), ולאחר מכן לחץ על  על (תפריט/אישור) כדי לאתחל את הכרטיס.

לאחר שתתקין כרטיס זיכרון, כל התמונות החדשות וכל סרטוני הווידאו שלך יישמרו באותו כרטיס, ולא בזיכרון הפנימי של המצלמה.

כדי להשתמש בזיכרון הפנימי ולהציג תמונות שנשמרו בו, הוצא את כרטיס הזיכרון.

## הפעלת המצלמה

כדי להפעיל את המצלמה, לחץ על לחצן ON/OFF.

## בחירת השפה



השתמש בלחצנים ▲▼ ו-◀▶ כדי לבחור את השפה הרצויה, ולאחר מכן לחץ על <sup>Menu</sup>OK (תפריט/אישור).

## הגדרת האזור



ההגדרות **Language** (שפה) ו-**Region** (אזור) קובעות את ברירות המחדל לתבנית התאריך ואת תבנית אות הווידאו הדרושה להצגת תמונות המצלמה בטלוויזיה.

השתמש בלחצנים ▲▼ כדי לבחור את האזור הרצוי, ולאחר מכן לחץ על <sup>Menu</sup>OK (תפריט/אישור).

## קביעת התאריך והשעה



1. השתמש בלחצנים ▲▼ כדי לקבוע כרצונך את הערך המסומן.
2. השתמש בלחצנים ▶◀ כדי לעבור לפריטים אחרים, וחזור על שלב 1 עד שהתאריך והשעה ייקבעו לשביעות רצונך.

## 2 התקנת המצלמה

### התקנת הסוללות

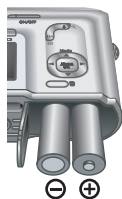

1. פתח את דלת הסוללות/כרטיס הזיכרון על ידי החלקת תפס הדלת, כפי שמצוין על הדלת.
2. הכנס את הסוללות למקומן.
3. סגור את הדלת של תא הסוללות/כרטיס זיכרון.

הערה כבה את המצלמה בטרם תוציא ממנה את הסוללות. אם אתה משתמש בסוללות NiMH נטענות, הקפד לטעון את הסוללות באופן מלא לפני השימוש הראשון.

מידת השימוש במצלמה וסוג הסוללות ישפיעו על אורך הפעולה של הסוללות. אורך החיים של סוללות אלקליות קצר בהרבה מזה של סוללות ליתיום או סוללות NiMH. לפרטים מלאים, עיין בנספח א' במדריך למשתמש במתכונתו האלקטרונית.



#### מספר תצלומים

סוג סוללה	מינימום	מקסימום	מוצע	CIPA
אלקלית	77	180	120	80
NiMH	215	380	290	205
Photo Lithium	365	600	485	423

נתוני CIPA התקבלו על פי התקנים שנקבעו על ידי איגוד CIPA (Camera and Imaging Products Association).



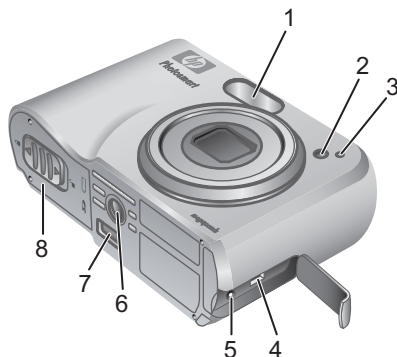





## תמונת חזית, צד ותחתית המצלמה



מבזק.	1
נורית קוצב זמן עצמי.	2
מיקרופון.	3
מחבר USB.	4
מחבר מתאם חשמל.	5
חיבור חצובה.	6
מחבר עגינה.	7
דלת סוללות/כרטיס זיכרון.	8

## הכנסת המצלמה לעגינה

אם רכשת תושבת HP Photosmart למצלמה, התושבת נמכרת עם מספר תושבות שקופות. כאשר אתה מתקין את התושבת כדי להציב בתוכה את המצלמה, השתמש בתושבת העגינה עם התגית הירוקה הרבועה. עיין במדריך למשתמש של התושבת לקבלת הוראות.

7	לחצן ON/OFF.
8	מתג <b>זום</b> (דיגיטלי ואופטי) - במצב <b>Live View</b> (תצוגה חיה), לחץ על  (התקרבות) כדי להגדיל תמונה, או על  (התרחקות) כדי להקטין את התמונה. במצב <b>Playback</b> (הקרנה חוזרת), לחץ על  (הגדלה) כדי להגדיל את התמונה הנבחרת או על  (תמונות ממוזערות) כדי לעבור לתצוגת תמונות ממוזערות.
9	חיבור עם רצועת יד.
10	לחצן <b>Mode</b> (מצב) - לחץ על  כדי לקבל גישה לתפריט <b>Shooting Mode</b> (מצב צילום) מתוך <b>Live View</b> (תצוגה חיה). האפשרויות הן <b>Fast Shot</b> , <b>Self-Timer</b> , <b>Auto Mode</b> , <b>Beach and Night Portrait</b> , <b>Action</b> , <b>Portrait</b> , <b>Landscape</b> , <b>Macro</b> , <b>Burst</b> , <b>Sunset</b> , <b>Snow</b> (בהתאמה: מצב אוטומטי, קוצב זמן עצמי, צילום מהיר, נוף, דיוקן, תנועה, דיוקן לילי, חוף ושלג, שקיעה, רציף, מקארו).
11	 וכן  - משמשים לגלילה בתוך תפריטים ותמונות.
12	 (תפריט/אישור) - משמש להצגת תפריטים, אפשרויות שנבחרו ואישור פעולות.
13	לחצן  <b>Delete</b> (מחיקה) - משמש גישה לפונקציית <b>Delete</b> (מחיקה) מתוך <b>Playback</b> (הקרנה חוזרת).
14	צג תמונות.
15	נורית טעינת הסוללה.

## המצלמה במבט מלמעלה ומאחור

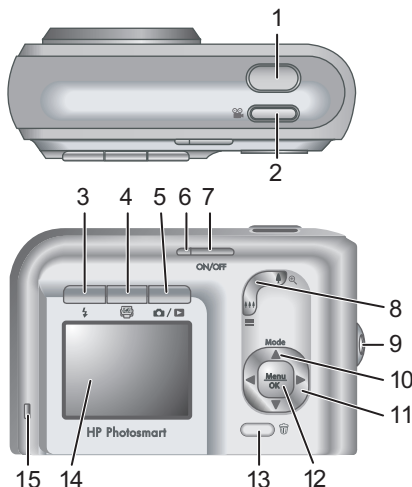

1	לחצן תריס.
2	לחצן וידאו.
3	לחצן ⚡ <b>מבזק</b> Flash button לחצן <b>מבזק</b> - המצבים האפשריים הם Flash Off, Flash On, Red-Eye, Auto (בהתאמה, אוטומטי, עיניים אדומות, מבזק מופעל, מבזק מושבת).
4	לחצן 🖨️ <b>Photosmart Express</b> - האפשרויות הן Buy, Print, Share Setup, Prints Online (בהתאמה, הדפסה, רכישת תדפיסים במקוון, הגדרת שיתוף).
5	לחצן 📷 / 📺 <b>Live View/Playback</b> (תצוגה חיה/הקרנה חוזרת) משמש למעבר בין מצב <b>Live View</b> (תצוגה חיה) לבין מצב <b>Playback</b> (הקרנה חוזרת) (ראה "מצבי Live View ו-Playback (תצוגה חיה והקרנה חוזרת)" בעמוד 17).
6	נורית הפעלה.

# הצגת המדריך למשתמש במתכונתו האלקטרונית

המדריך למשתמש במתכונתו האלקטרונית עומד  
לרשותך בתקליטור של תוכנת HP Photosmart.



כדי להציג את המדריך למשתמש:

1. הכנס את התקליטור עם תוכנת HP Photosmart לכוון התקליטורים של המחשב.
2. **במערכת Windows:** לחץ על **View User Guide** (הצג את המדריך למשתמש) בדף הראשי של מסך ההתקנה.  
**במערכת Macintosh:** פתח את קובץ ה- **readme docs** בתיקייה שבתקליטור.

המדריך למשתמש במתכונתו האלקטרונית יועתק למחשבך כאשר תתקין את תוכנת HP Photosmart. כדי להציג את המדריך למשתמש לאחר שהותקן במחשב:

- **במערכת Windows:** פתח את **HP Solution Center** ולחץ על **Help and Support** (עזרה ותמיכה).
- **במערכת Macintosh:** פתח את **HP Device Manager** ובחר את הפריט **User Guide** מתוך התפריט המוקפץ **Information and Setting**.

## קבלת סיוע

- לקבלת עצות וכלים שסייעו לך להשתמש במצלמה ביעילות רבה יותר, בקר בכתובת **www.hp.com/photosmart** (אנגלית בלבד) או בכתובת **www.hp.com**.
- לקבלת עזרה ואבחון עבור המוצר ומנהלי התקן להורדה (מסביב לשעון), בקר בכתובת **www.hp.com/support**.
- לקבלת עזרה בנושאים הקשורים לתוכנת HP Photosmart, עיין במאפיין העזרה בתוכנת HP Photosmart.



# 1 תחילת העבודה

'מדריך ההפעלה המהירה' בדפוס מכיל את המידע הדרוש לך כדי להתחיל בעבודה ולהשתמש במאפיינים החשובים ביותר במצלמה. לקבלת מידע מפורט על מאפייני המצלמה, עיין במדריך למשתמש במתכונתו האלקטרונית.

מדריך הפעלה מהירה	המדריך למשתמש במתכונת אלקטרונית
המדריך המודפס יסייע לך בדברים הבאים:	המדריך למשתמש במתכונתו האלקטרונית כולל:
<ul style="list-style-type: none"><li>• למידה מהירה של תפעול המצלמה</li><li>• התקנת תוכנת HP Photosmart</li><li>• היכרות עם מאפייני המצלמה</li></ul>	<ul style="list-style-type: none"><li>• תיאורים של כל מאפייני המצלמה</li><li>• תיאור של הסמלים בתצוגת התמונות</li><li>• הוראות כיצד להשתמש במצלמה מבלי להתקין את תוכנת HP Photosmart</li><li>• מידע על הסוללות, ובכלל זה:<ul style="list-style-type: none"><li>- הארכת חיי הסוללה</li><li>- סוגי הסוללות השונים</li><li>- תיאור הסמלים של מחוון החשמל</li></ul></li><li>• קבלת עזרה מ-HP</li><li>• פתרון בעיות</li><li>• מפרט המצלמה</li></ul>

# תוכן עניינים

4.....	<b>1 תחילת העבודה</b>	1
4.....	הצגת המדריך למשתמש במתכונתו האלקטרונית	
6.....	המצלמה במבט מלמעלה ומאחור	
8.....	תמונת חזית, צד ותחתית המצלמה	
8.....	הכנסת המצלמה לעגינה	
9.....	<b>2 התקנת המצלמה</b>	2
9.....	התקנת הסוללות	
10.....	הפעלת המצלמה	
10.....	בחירת השפה	
10.....	הגדרת האזור	
10.....	קביעת התאריך והשעה	
11.....	התקנה והגדרה של כרטיס זיכרון אופציונלי	
12.....	התקנת התוכנה	
13.....	<b>3 צילום תמונות והקלטת סרטוני וידאו</b>	3
13.....	צילום תמונה	
13.....	הקלטת סרטון וידאו	
14.....	<b>4 סקירה ומחיקה של תמונות וסרטוני וידאו</b>	4
14.....	סקירת תמונות וסרטוני וידאו	
14.....	מחיקת תמונה	
15.....	<b>5 העברה והדפסה של תמונות</b>	5
15.....	העברת תמונות	
15.....	הדפסת תמונות מהמצלמה	
17.....	<b>6 מדריך הפעלה המהיר</b>	6

## מידע משפטי והודעות

Copyright 2006 Hewlett-Packard Development Company, ©  
L.P.

המידע הכלול במסמך זה נתון לשינויים ללא הודעה מוקדמת. האחריות הבלעדית למוצרים ולשירותים של HP מפורטת בהצהרת האחריות המפורשת הנלווית לאותם מוצרים ושירותים. אין לפרש דבר מן האמור במסמך זה כהענקת אחריות נוספת. חברת HP לא תישא באחריות לשגיאות או השמטות מסיבות טכניות או בעקבות עריכה.

Windows® הוא סימן מסחר רשום בארה"ב של Microsoft Corporation.

SD הלוגו הוא סימן מסחר של בעליו.

## סילוק ציוד משומש על ידי משתמשים במשקי בית פרטיים באיחוד האירופי

סמל זה על מוצר או אריזת המוצר מציין כי אין לסלק מוצר זה יחד עם שאר הפסולת הביתית. תחת זאת, בעל המוצר נושא באחריות לסילוק הציוד המשומש שברשותו על ידי העברתו לנקודת איסוף רשמית לצורך מיחזור של ציוד חשמלי ואלקטרוני משומש. האיסוף והמיחזור בנפרד של ציוד משומש בעת הסילוק יסייעו לשמירה על משאבי הטבע ויבטיחו מיחזור בשיטה השומרת על בריאות האדם והסביבה. לפרטים נוספים על נקודות איסוף לציוד משומש לצורך מיחזור, פנה אל הגורם המתאים בעירייה, אל שירות איסוף האשפה הביתית או אל החנות שבה רכשת את המוצר.



## לעיון עתידי, הזן את הפרטים הבאים:

	מספר דגם (מופיע בחזית המצלמה)
	מספר סידורי (מספר בן 10 ספרות שמופיע בתחתית המצלמה)
	תאריך רכישת המצלמה

# מצלמה דיגיטלית HP Photosmart M425/M525

עברית

