

HP Digital Entertainment Center

(With HDTV ATSC Tuner)

Start Here



ENTERTAINMENT  
IS PERSONAL  
AGAIN.



# Features

## Easy to set up and fun to use

Enjoy more of your TV, movies, music, photos, and home videos in one place. A simple and delightful interface that puts you in control of your complete entertainment experience. Designed to integrate easily into your existing home entertainment components.

## Easily preserve and share memories

Capture, personalize, and create DVDs of your home movies and back up your photos, music, or favorite TV programs on DVD. Use the optional HP Personal Media Drive as an easy way to add more storage or archive your digital content.

## Watch what you want, when you want

Pause and replay Live Standard and High Definition over-the-air TV and record hundreds of hours of your favorite TV shows without a monthly fee, or enjoy DVD movies in high quality video and digital surround sound.

(Surround sound system is required, sold separately. Additional cables may be required, sold separately.)

## Explore a whole new world of on-demand entertainment

Explore the Internet for exciting content like on-demand movies and music through *Online Spotlight*, or instant message friends while watching your favorite TV shows.

(Separate service contracts and/or fees may be required.)

# Start Here Booklet

<b>Overview</b>	Page
Welcome .....	2
Placement and Ventilation Requirements .....	3
What's in the box .....	4
Installation overview .....	5
<b>Audio</b>	
Connecting to multi-channel AV receiver .....	6
<b>Video</b>	
Connecting to high-definition TVs or computer displays .....	8
Connecting to CRTs and Rear Projection Non-HD TVs .....	9
<b>TV Sources</b>	
About ATSC antennas .....	10
Connecting to UHF/VHF antenna, or analog cable .....	11
Connecting to cable box or digital satellite receiver — Step 1 .....	12
Cable box or digital satellite receiver — Step 2 .....	13
<b>Final Setup</b>	
Remote control, keyboard and FM radio .....	14
Connecting to Internet — Wired and wireless .....	15
AC power connection .....	16

# Welcome to the HP Digital Entertainment Center

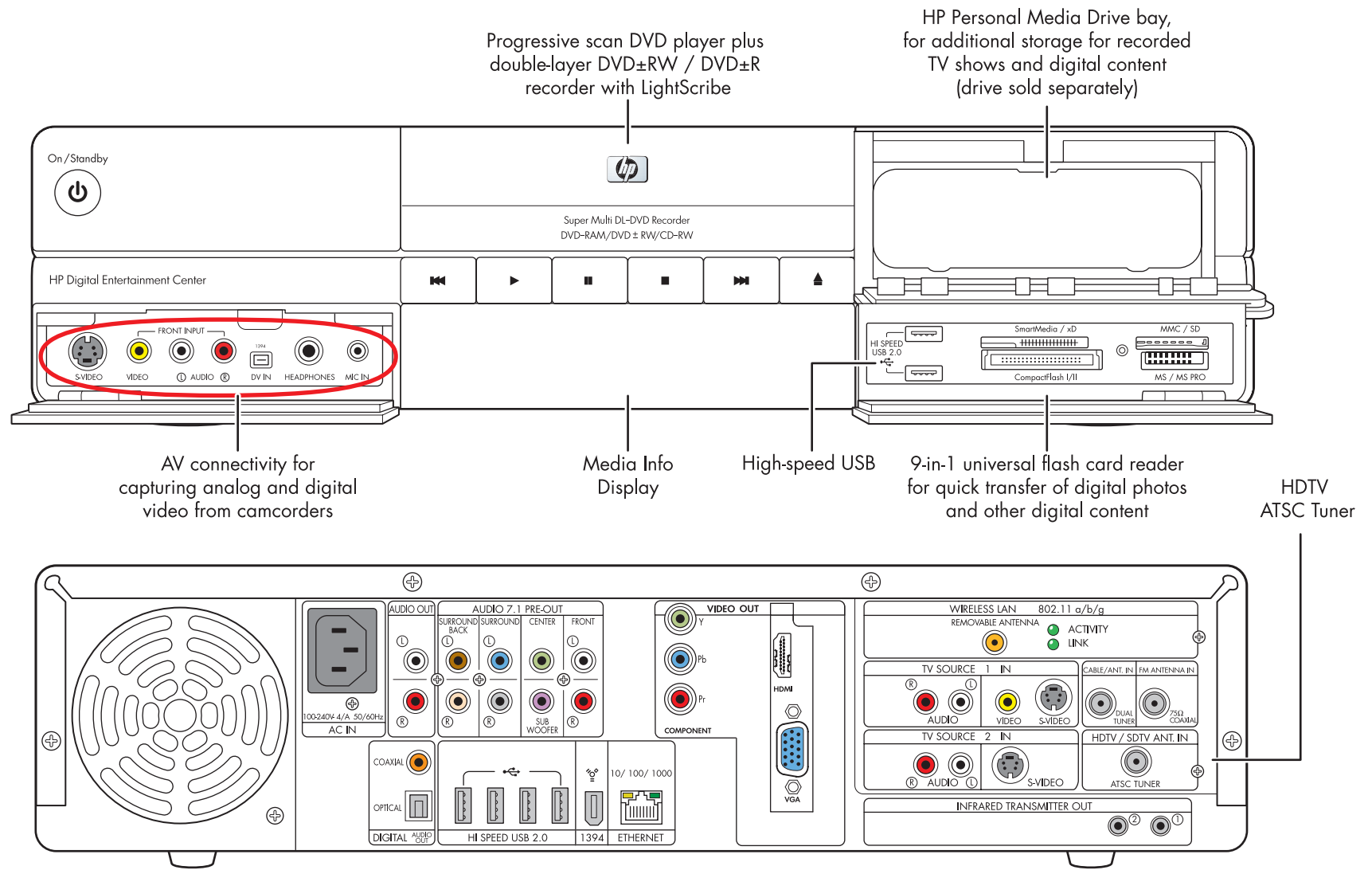

# Placement and Ventilation Requirements

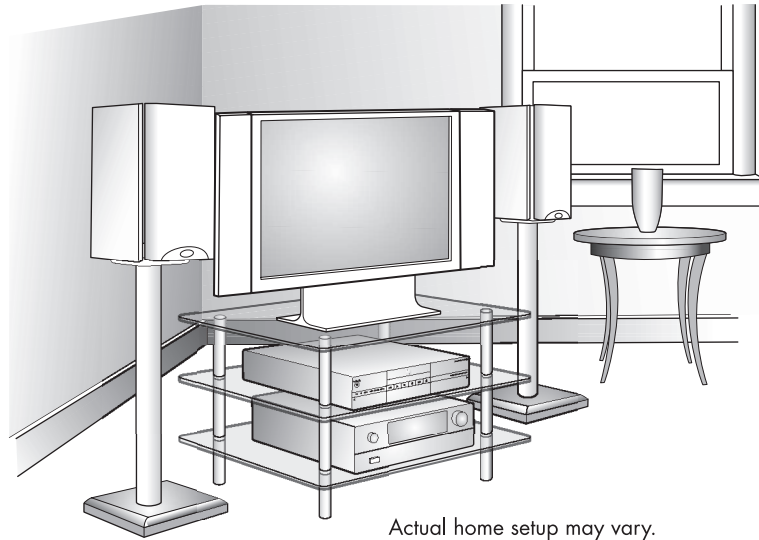

**IMPORTANT:** Use an open cabinet for best operation of the HP Digital Entertainment Center (DEC). Do not cover vents on top, back, or side of unit.



Backs of cabinets should be open for best operation; if there is a back to the cabinet, there must be a hole in the back of the cabinet with a minimum open area of 19"W x 6.5"H behind the DEC, so that air can circulate; see **Figure A**. The back of the DEC must be at least 4" from the wall, see **Figure B**.



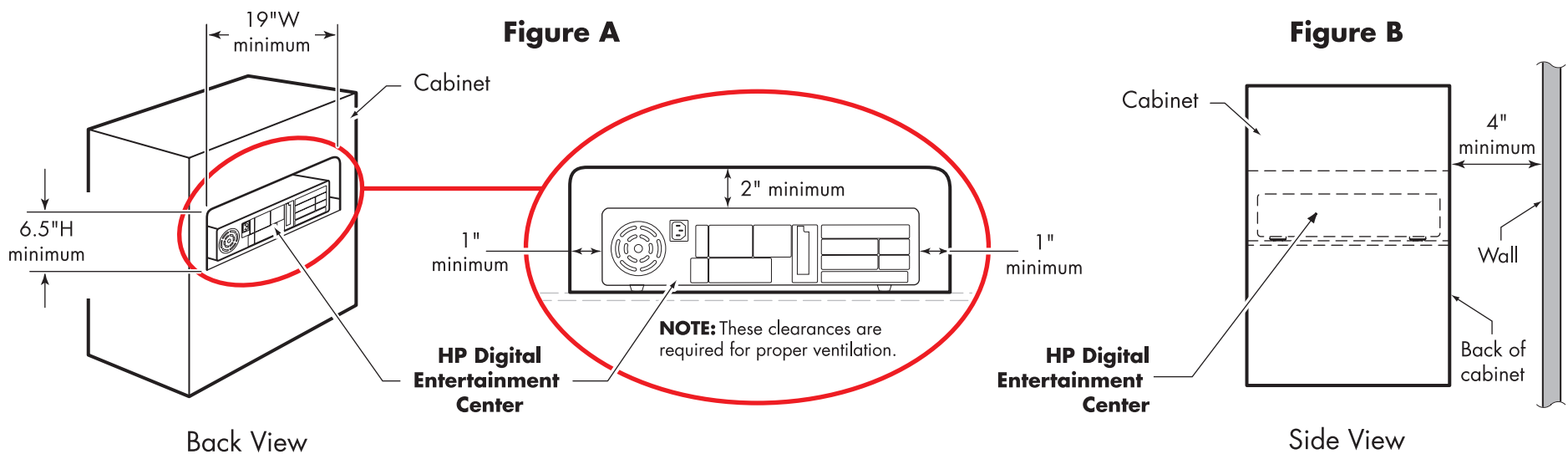

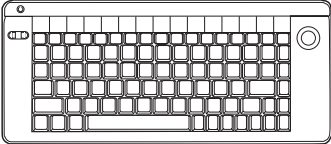
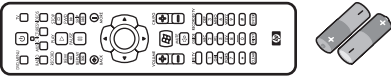

If you choose to use a cabinet with front doors, they must be left open during your use of the DEC.

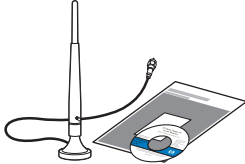
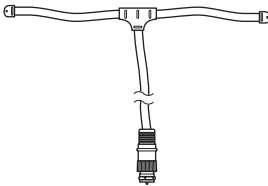
Failure to follow these ventilation requirements could result in the DEC malfunctioning.

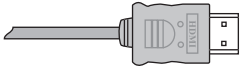

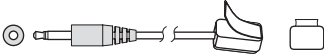
# What's in the box?

<p><b>HP Digital Entertainment Center</b></p>	
<p><b>RF wireless lap-size keyboard</b> (batteries preinstalled)</p>	
<p><b>IR remote control plus two AA batteries</b></p>	
<p><b>Documentation</b></p>	
<p><b>Wireless LAN antenna</b> (for extended range)</p>	
<p><b>FM antenna</b></p>	

Cables	Connector
<p><b>HDMI</b> (for video connection to high-definition displays)</p>	
<p><b>Coaxial digital audio</b> (for 5.1 digital audio)</p>	
<p><b>Infrared (IR) transmitter (2)</b></p>	
<p><b>AC power</b></p>	
<p><b>RCA stereo</b> (red, white) (for 2-channel audio)</p>	
<p><b>DVI-D to HDMI converter</b></p>	

# Installation Overview

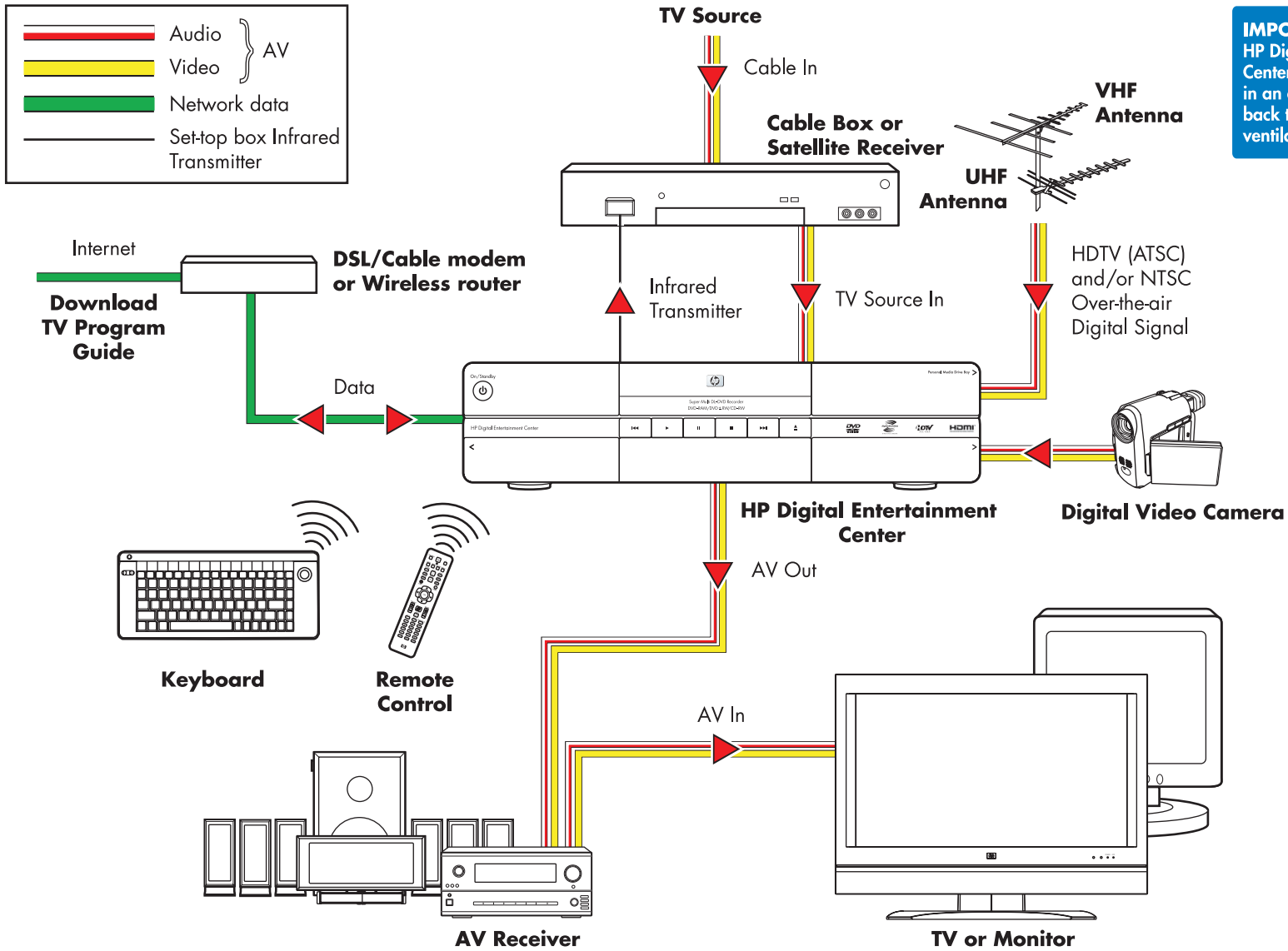

**IMPORTANT:** The HP Digital Entertainment Center must be installed in an area with an open back to ensure proper ventilation.

# Audio

Select only one Audio option, then proceed to Video

## Tips

- You may need to change the input selection on the front panel of your AV receiver or AV remote control in order to hear sound. See your AV receiver documentation.
- For the 5.1 or 7.1 options or speakers that use mini-jacks, you may need to purchase additional cables.
- You may not need to connect all plugs.
- Refer to the *User's Guide* for detailed instructions.

Configuration options

AV Receiver Rear Panel

### Recommended

#### 5.1 Channel AV Receiver

Digital connection

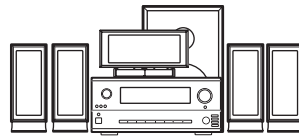

Digital Audio Input

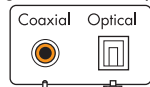

Connectors vary by AV receiver

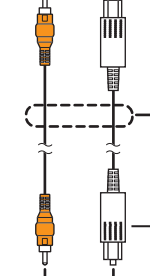

or

(sold separately)

Digital Audio Out

#### 7.1 Channel AV Receiver

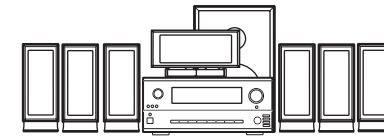

Audio Input

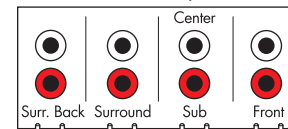

Connector colors may vary

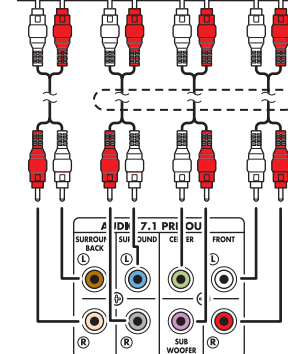

(sold separately)

Analog Audio Out (Multi-Channel)

or

or

HP Digital Entertainment Center Rear Panel

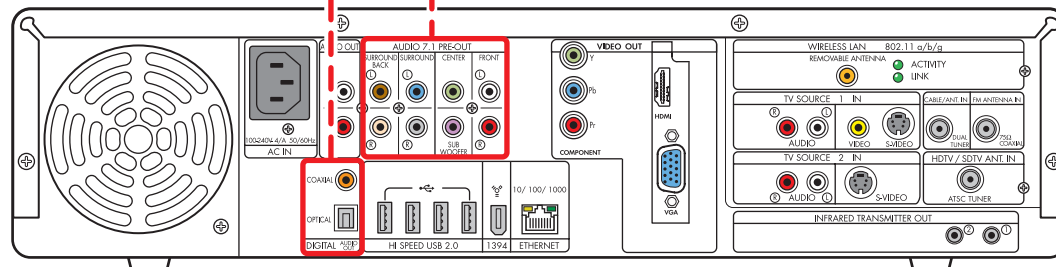



# Audio

Select only one Audio option, then proceed to Video

## 5.1 Channel AV Receiver

Analog connections

## 2-Channel Stereo Receiver or TV

Configuration Options

AV Receiver Rear Panel

HP Digital Entertainment Center Rear Panel

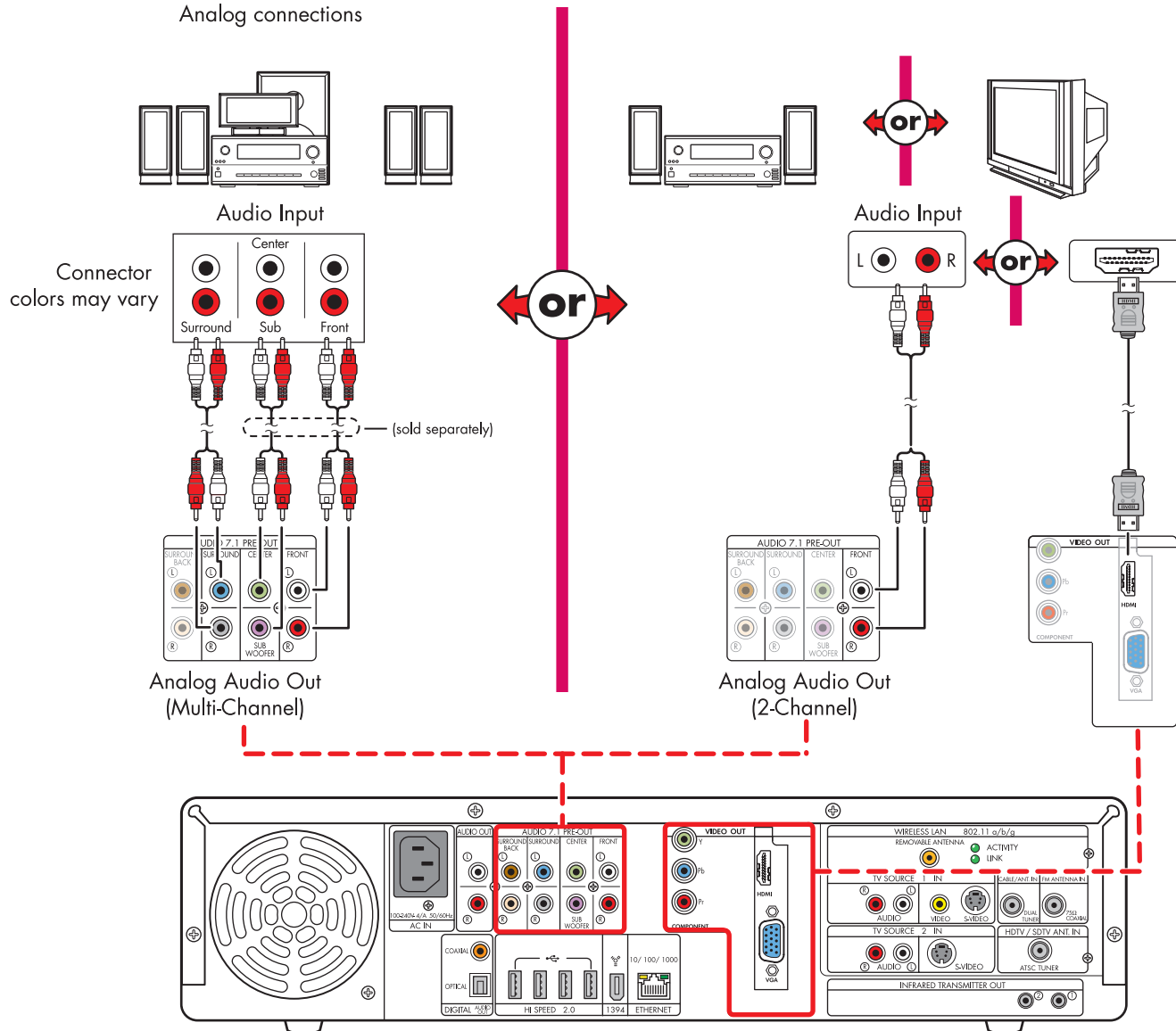

## Tips

- If you have a multi-channel sound system, and the broadcast is only 2-channel, you may not hear all the sound; you may need to change your audio settings to 2.0/2.1. Then change the settings back for multi-channel broadcasts. Refer to the *User's Guide* to configure audio settings.
- Both Media Center speaker settings and DVD audio settings must be changed for proper audio setup. Refer to the *User's Guide*.

# Video

## High-Definition TVs or Computer Displays

Select only one Video option, then proceed to TV Sources

\* Go to your model number page at <http://www.hp.com/support> for information on setting the resolution.

**NOTE:** To connect video equipment with DVI-D connectivity, use the provided DVI-D to HDMI adaptor.

TV Rear Panel

HP Digital Entertainment Center Rear Panel

### Recommended

#### HDMI\*

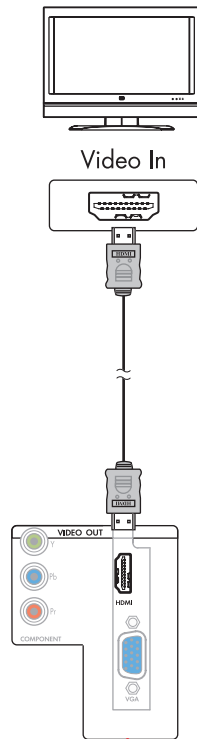

#### VGA (Computer Displays or Digital TVs)

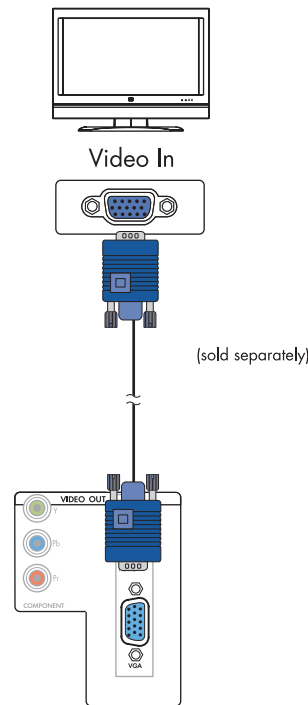

#### Progressive Scan (Component\*)

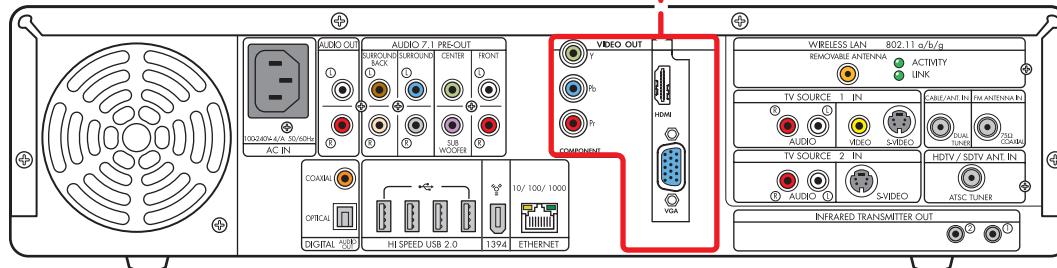
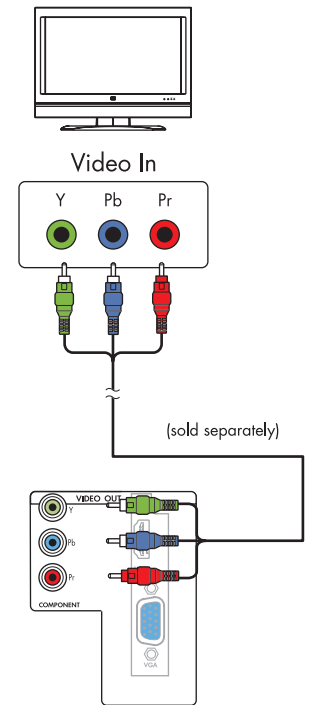

\* Not recommended for initial setup. Go to your model number page at <http://www.hp.com/support> for instructions on using component video.

# Video

## CRTs and Rear Projection Non-HD TVs

Select only one Video option, then proceed to TV Sources

### Interlaced Scan (Component\*)

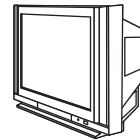

Video In

TV Rear Panel

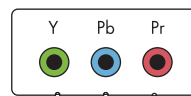

(sold separately)

HP Digital  
Entertainment  
Center Rear Panel

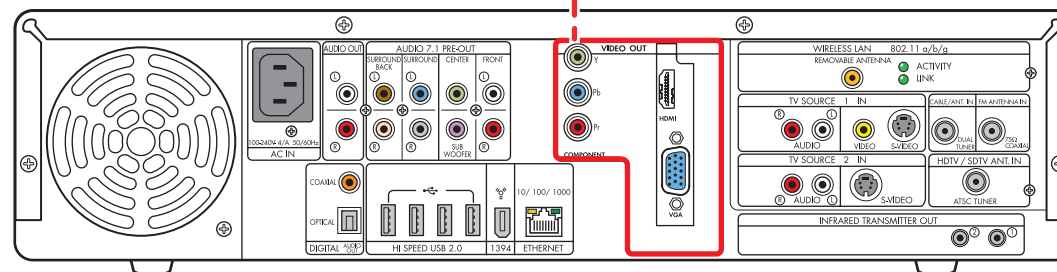
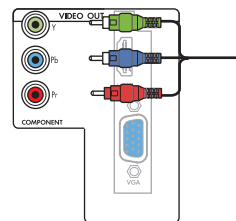

\* Not recommended for initial setup. Go to your model number page at <http://www.hp.com/support> for instructions on using component video.

# TV Sources

## About ATSC antennas

### About Connecting an ATSC Antenna

Over-the-air ATSC digital TV requires a UHF/VHF antenna (sold separately) to receive the digital signal. Your location must be within an ATSC DTV broadcast area.

See the following illustrations to install ATSC DTV.

Refer to <http://www.antennaweb.org> (subject to change without notice) for more information about:

- The channels available in your area. The channels may be color-coded by zone.
- Selecting the kind of antenna you need, depending on the channels you want to receive. Match your antenna to your zone.
- The direction to point your antenna.
- Positioning an HDTV antenna for best reception.

---

**NOTE:** You can also attach an internal or external roof VHF/UHF antenna to the HP Digital Entertainment Center to watch NTSC channels. See the following illustrations.

---

### Finding Your ATSC Channels

After you complete the Media Center and Digital TV setup wizards and then download your Television Program Guide, the Guide may display incorrect ATSC DTV channels. Some channels may have an incorrect channel number and other channels may not be displayed at all. These HDTV channels may be available in your area, but they may not be listed in the Media Center Television Program Guide.

A more complete ATSC DTV channel guide may be available from third party providers, such as Titan TV. See Online Spotlight for more information. See your other printed documentation for more information about setting up these channels.

# TV Sources

UHF/VHF Antenna, or Analog Cable  
Select only one TV source, then proceed to Final Setup

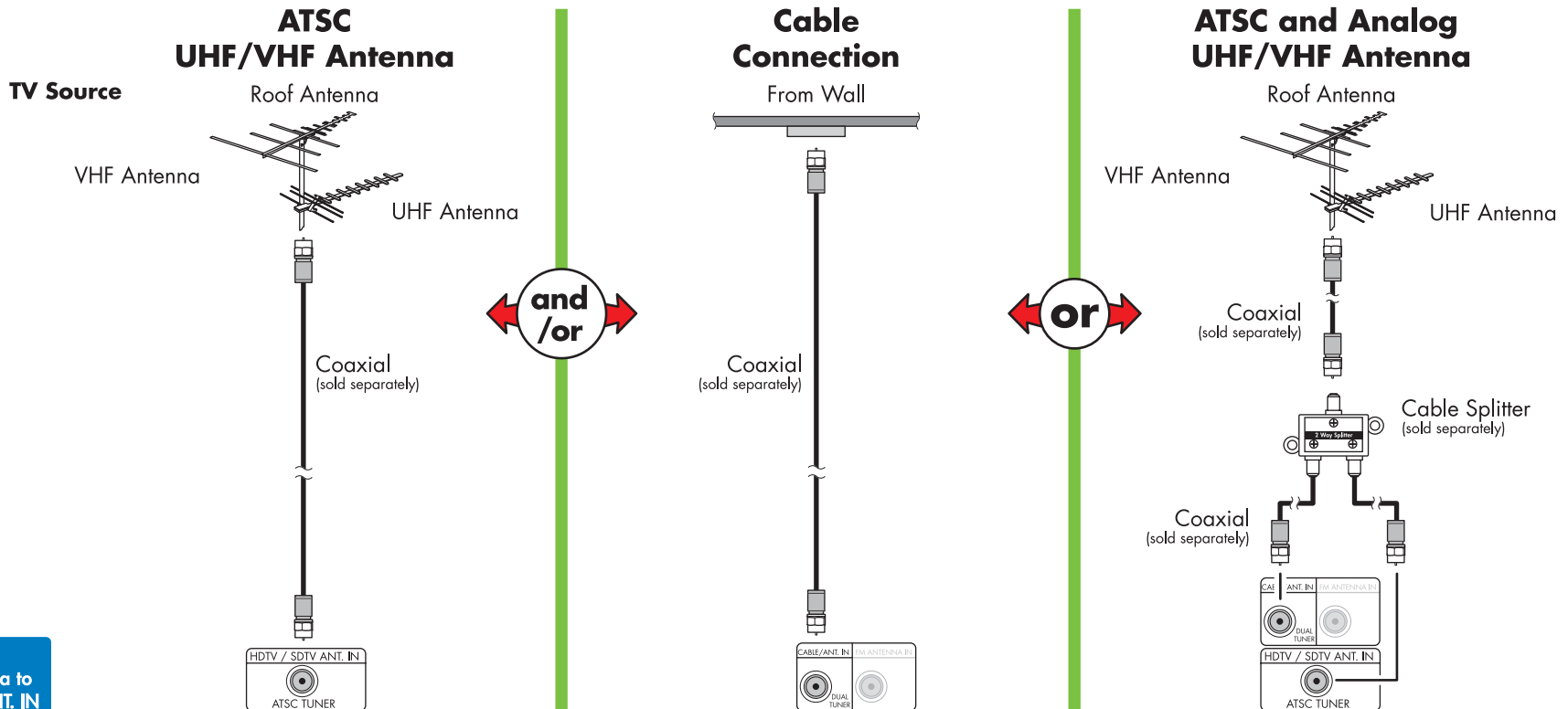

For HD Signal, connect antenna to HDTV/SDTV ANT. IN

HP Digital Entertainment Center Rear Panel

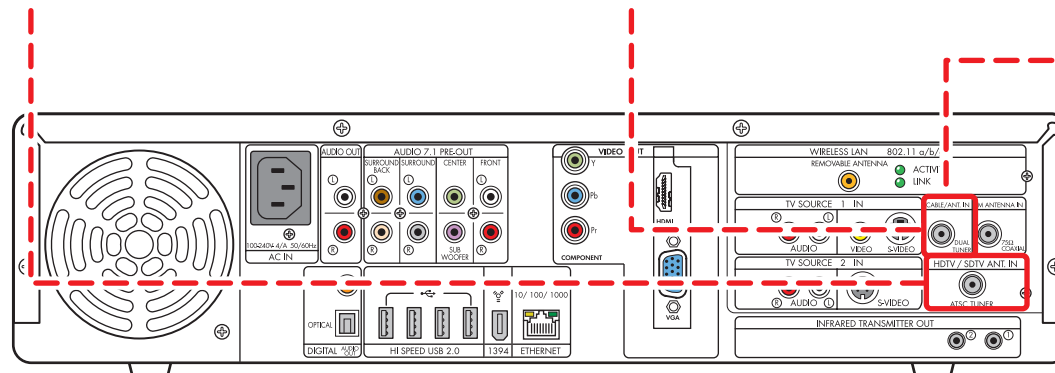

**NOTE:** CABLE/ANT. IN has an internal splitter to dual tuners.

TV Sources

# TV Sources

## Cable Box or Digital Satellite Receiver\*

Select only one TV source option, then proceed to Final Setup

### Step 1

#### Single Set-top Box\*

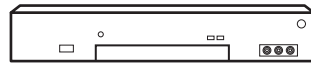

From first Cable Box or Satellite Receiver

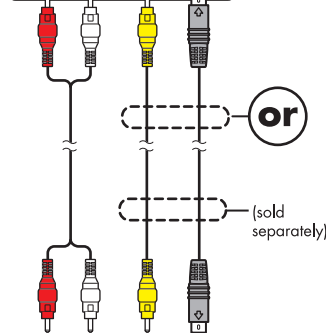
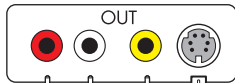

(sold separately)

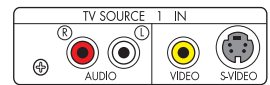

\* These boxes are provided by your local cable or satellite service provider. If neither set-top box supports S-video, the second box can be connected by using the front AV inputs or an adapter (not included).

You cannot view or record high-definition TV through a set-top box. You must use an antenna; see page 11.

#### (optional) Second Set-top Box\*

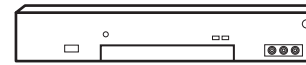

From second Cable Box or Satellite Receiver

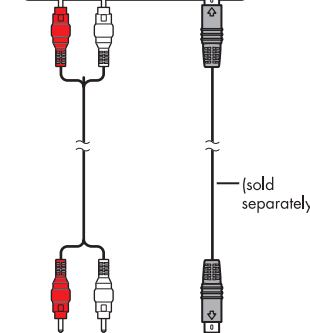
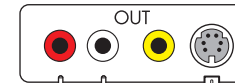

(sold separately)

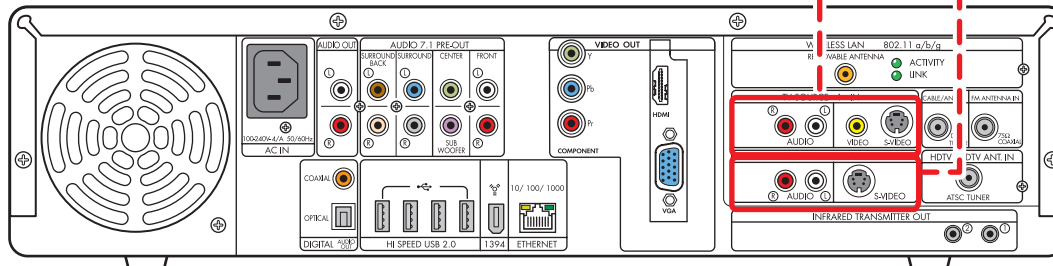

# TV Sources

## Cable Box or Digital Satellite Receiver\*

Select only one TV source option, then proceed to Final Setup

### Step 2

#### Source 1 Set-top box

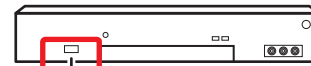

\* These boxes are provided by your local cable or satellite service provider.

It may be easier to find the IR window using a flashlight. See *User's Guide* for further instructions.

#### Source 2 Set-top box

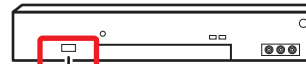

(optional)

Attach the IR transmitter from the rear of the HP Digital Entertainment Center to the front IR window of the Digital Cable Box or Digital Satellite Receiver.



**Cable Box or Satellite Receiver**

**HP Digital Entertainment Center Rear Panel**

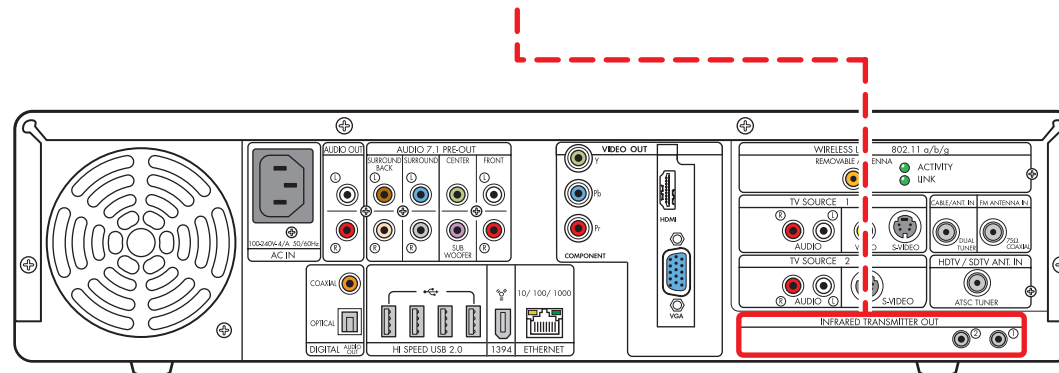

# Final Setup

## Remote control, keyboard, FM radio

### Remote Control

(Actual remote control may vary)

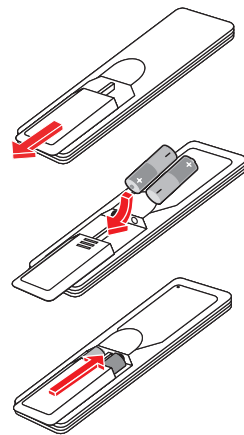
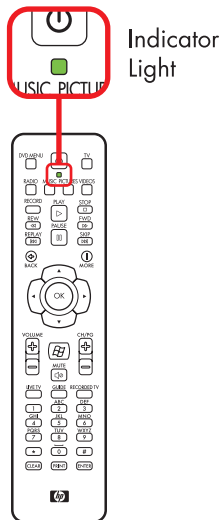

Install AA batteries in remote control.

Press any key to check if batteries are correctly installed. The indicator light should blink.

### Keyboard Setup

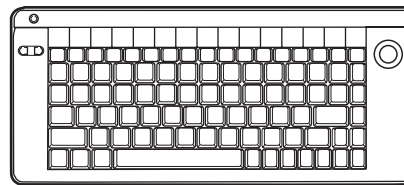

Pull tab to power keyboard

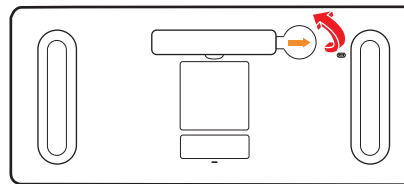

### FM Radio Setup

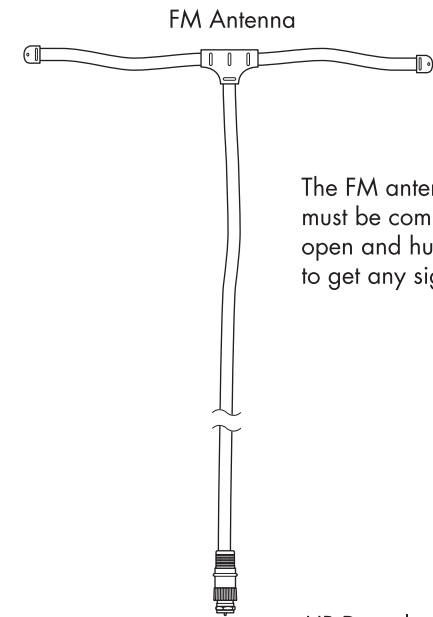

The FM antenna must be completely open and hung up to get any signal.



HP Digital Entertainment Center rear panel

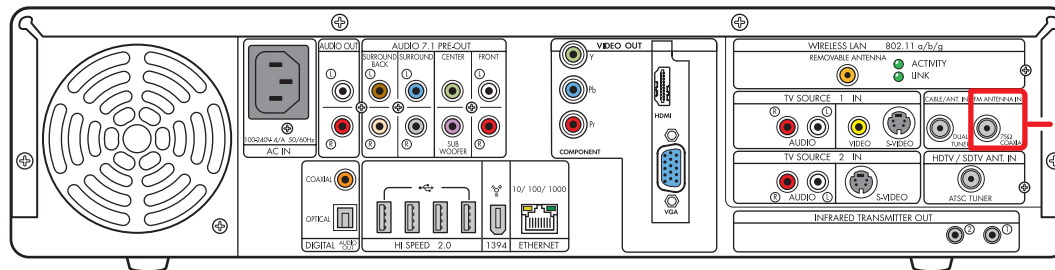



# Final Setup

## Internet connection

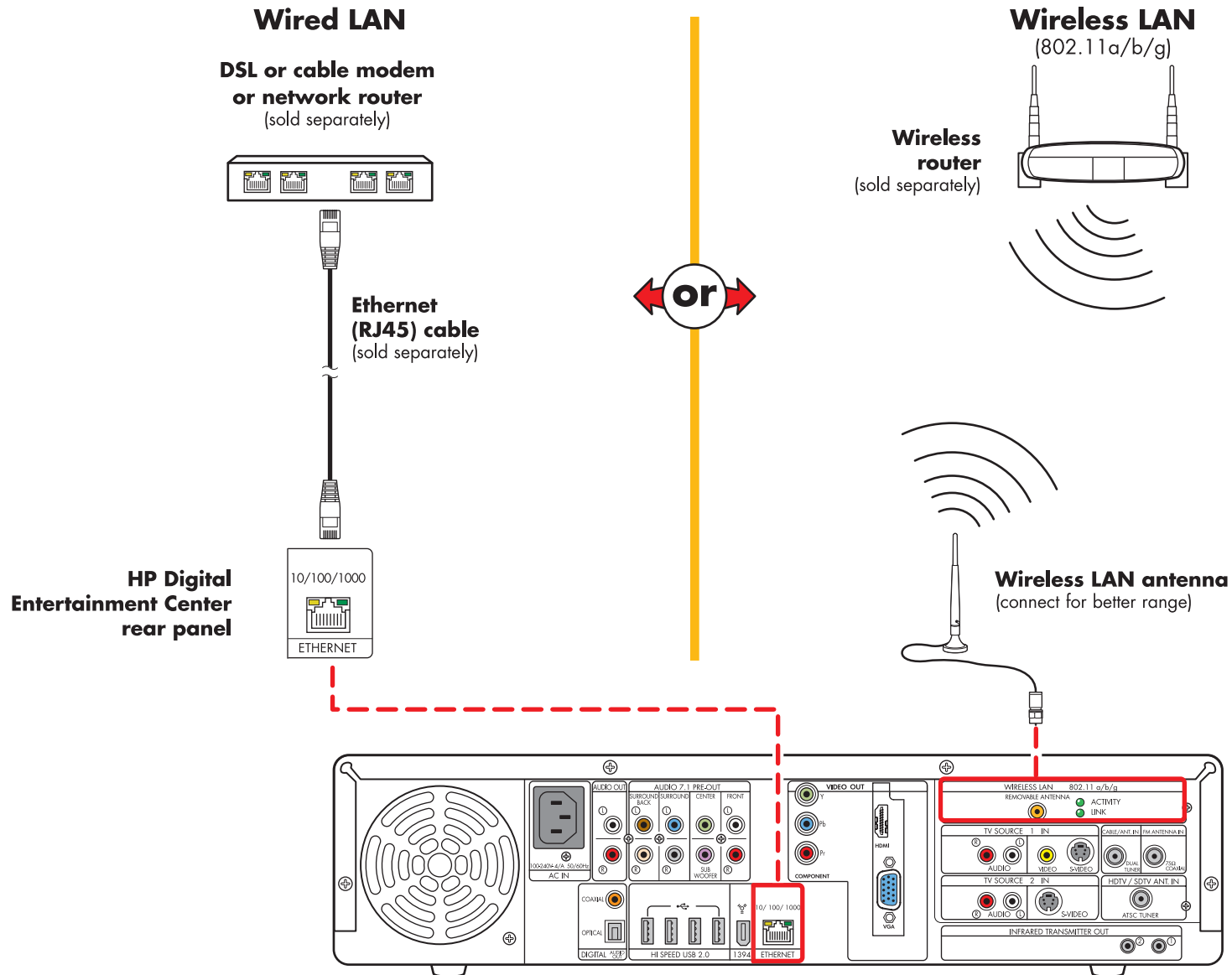

Refer to network setup wizard for configuring the HP Digital Entertainment Center in your home network.

# Final Setup

## AC power connection

### AC Wall Outlet

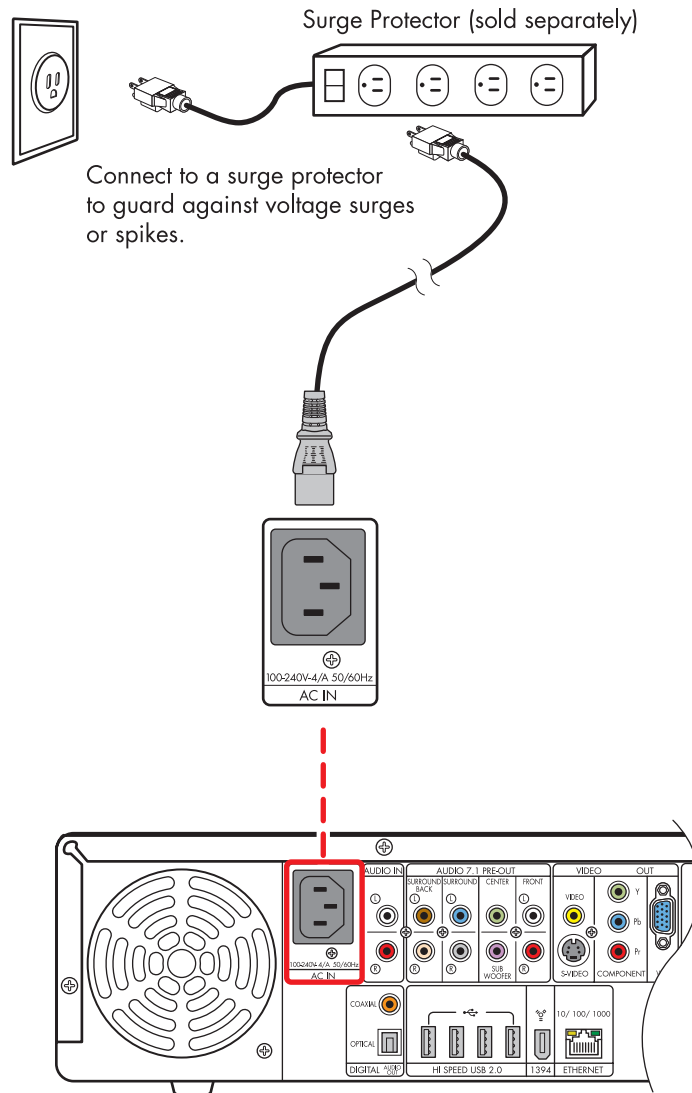

- Turn power on to all connected devices such as TV and audio equipment before powering on the HP Digital Entertainment Center.
- Set TV and AV receiver to proper inputs.
- Connect video cables **BEFORE** powering on the HP Digital Entertainment Center.

Your HP Digital Entertainment Center setup is now complete. Before powering on the unit, refer to the *TV/Display Setup Guide* for final configuration instructions.



Copyright © 2004–2006 Hewlett-Packard Development Company, L.P.  
The information contained herein is subject to change without notice.

Printed in  
[www.hp.com](http://www.hp.com)

