

HP Photosmart R725/R727 Digital Camera

English



Legal and notice information

© Copyright 2006 Hewlett-Packard Development Company, L.P.

The information contained herein is subject to change without notice. The only warranties for HP products and services are set forth in the express warranty statements accompanying such products and services. Nothing herein should be construed as constituting an additional warranty. HP shall not be liable for technical or editorial errors or omissions contained herein.

Windows® is a U.S. registered trademark of Microsoft Corporation.



SD Logo is a trademark of its proprietor.



Disposal of waste equipment by users in private households in the European Union

This symbol on the product or on its packaging indicates that this product must not be disposed of with your other household waste. Instead, it is your responsibility to dispose of your waste equipment by handing it over to a designated collection point for the recycling of waste electrical and electronic equipment. The separate collection and recycling of your waste equipment at the time of disposal will help to conserve natural resources and ensure that it is recycled in a manner that protects human health and the environment. For more information about where you can drop off your waste equipment for recycling, please contact your local city office, your household waste disposal service or the shop where you purchased the product.

For future reference, enter the following information:

- Model Number (camera front): _____
- Serial Number (camera bottom): _____
- Purchase date: _____

Contents

1	Getting started	4
	Accessing the electronic User Guide.....	4
	Camera top and back	6
	Camera front and bottom.....	8
	Camera dock insert.....	8
2	Setting up your camera	9
	Install the battery.....	9
	Charge the battery.....	9
	Turn on the camera.....	9
	Choose the language.....	10
	Set the region.....	10
	Set the date and time.....	10
	Install and format an optional memory card	11
	Install the software.....	11
3	Taking pictures and recording video clips	13
	Take a still picture.....	13
	Record a video clip.....	13
4	Reviewing and deleting images and video clips	15
	Review images and video clips.....	15
	Delete an image.....	15
5	Transferring and printing images	16
	Transfer images.....	16
	Print images from the camera.....	16
6	Camera quick reference	18

1 Getting started

This printed Quick Start Guide provides the information you need to get started using the essential features of your camera. For detailed information about camera features, see the electronic User Guide.

Quick Start Guide	Electronic User Guide
<p>This printed guide will help you to:</p> <ul style="list-style-type: none">• Start using your camera quickly• Install the HP Photosmart software• Introduce you to your camera's features	<p>The electronic User Guide includes:</p> <ul style="list-style-type: none">• Descriptions of all the camera features• A description of icons on the Image Display• Battery information, including:<ul style="list-style-type: none">– Extending battery life– A description of the power indicator icons• Troubleshooting• Getting assistance from HP• Camera specifications

Accessing the electronic User Guide



The electronic User Guide is on the HP Photosmart Software CD.

To view the User Guide:

1. Insert the HP Photosmart Software CD into the CD drive of your computer.
2. **On Windows:** Click **View User Guide** on the main page of the installation screen.
On Macintosh: Open the **readme** file in the **docs** folder on the CD.

The electronic User Guide is also copied to your computer when you install the HP Photosmart Software. To view the User Guide after it has been installed on your computer:

- **On Windows:** Open the **HP Solution Center** and click on **Help and Support**.
- **On Macintosh:** Open the **HP Device Manager** and select **User Guide** from the **Information and Settings** pop-up menu.







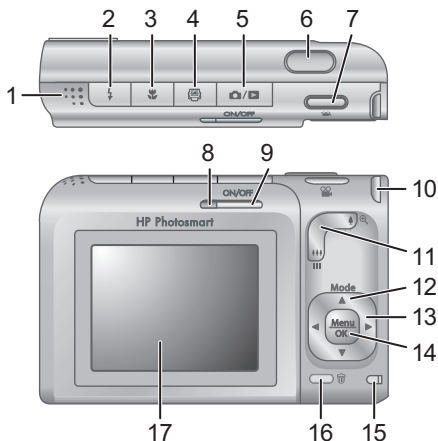



Getting assistance

- For tips and tools to help you use your camera more effectively, visit **www.hp.com/photosmart** (English only) or **www.hp.com**.
- For product assistance, diagnostics, and driver downloads 24x7, visit **www.hp.com/support**.
- For help with the HP Photosmart Software, see the online help for the HP Photosmart Software.

Camera top and back



1	Speaker.
2	Flash button—Settings are Auto, Flash On, Flash Off.
3	Focus button—Settings are Normal, Macro, Auto Macro, Infinity.
4	Photosmart Express button—Options are Print, Buy Prints Online, Share Setup.
5	Live View/Playback button—Switches between Live View and Playback (see <i>Live View and Playback</i> on page 18).
6	Shutter button.
7	Video button.
8	Power light.
9	ON/OFF button.

10	Wrist strap mount.
11	Zoom lever (Digital and Optical)—In Live View , press  to zoom in or press    to zoom out. In Playback , press  to magnify the selected image or press  to view thumbnails of your images.
12	Mode button —Press  to access the Shooting Mode menu while in Live View . Shooting Mode options are Auto Mode, Landscape, Portrait, Theatre, Panorama Right, Panorama Left, Action, Night Portrait, Night Scenery, Beach, Snow, Sunset, Document.
13	 and  buttons—Scrolls through menus and images.
14	 button—Displays camera menus, selects options, and confirms actions.
15	Battery Charging light.
16	 Delete button —Accesses the Delete function while in Playback .
17	Image Display.

Camera front and bottom

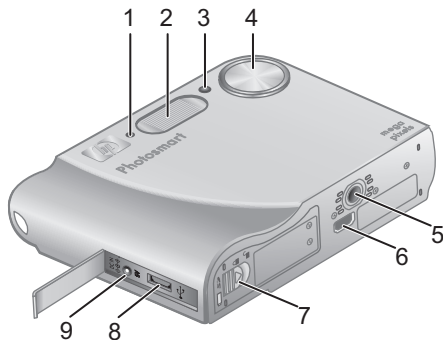

1	Microphone.
2	Flash.
3	Self-Timer/Focus assist light.
4	Lens.
5	Tripod mount.
6	Dock connector.
7	Battery/Memory card door.
8	USB connector.
9	Power adapter connector.

Camera dock insert

If you purchase an optional HP Photosmart camera dock, it will come with multiple clear inserts. When setting up the dock for use with this camera, use the dock insert with the round blue tag. See the dock User Guide for instructions.

2 Setting up your camera

Install the battery

1. Open the Battery/Memory card door by sliding the door latch as indicated on the Battery/Memory card door.
2. Insert the battery in the larger slot, pushing the battery in until the latch catches.
3. Close the Battery/Memory card door.



Note Turn the camera off before removing the battery. Fully charge the battery before using it the first time.

Charge the battery

You can charge the battery in the camera, using the AC adapter.

Connect the AC power adapter to the camera, then plug it into an electrical outlet.



The camera's blinking Battery Charging light indicates that the battery is charging; the battery is fully charged when the light stays on solid (approximately 2–3 hours).

Turn on the camera

To turn on the camera, press the ON/OFF button.

Choose the language

Use ▲▼◀▶ to choose the language that you want, then press $\frac{\text{Menu}}{\text{OK}}$.

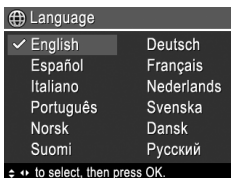

Set the region

Along with the **Language** setting, the **Region** setting determines the default date format and the format of the video signal for displaying camera images on a television.

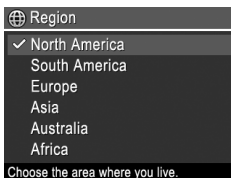

Use ▲▼ to choose the region you want, then press $\frac{\text{Menu}}{\text{OK}}$.

Set the date and time

1. Use ▲▼ to adjust the highlighted value.
2. Use ▶◀ to move to the other selections and repeat Step 1 until the date and time are set correctly.
3. Press $\frac{\text{Menu}}{\text{OK}}$ when the date, time, and format settings are correct, then press $\frac{\text{Menu}}{\text{OK}}$ again to confirm.



Install and format an optional memory card

This camera supports standard and high speed, HP-branded Secure Digital (SD) memory cards, 8MB to 2GB.



1. Turn off the camera and open the Battery/Memory card door.
2. Insert the optional memory card in the smaller slot as shown. Make sure the memory card snaps into place.
3. Close the Battery/Memory card door and turn on the camera.

Always format memory cards before first use.

1. With the camera turned on, press / until you are in **Playback**.
2. Press to display the **Delete** sub-menu.
3. Use to select **Format Card**, then press .
4. Use to select **Yes**, then press to format the card.

Once you install a memory card, all new images and video clips are stored on the card, rather than in internal memory.

To use internal memory and view images stored there, remove the memory card.

Install the software

The HP Photosmart Software provides features for transferring images and video clips to your computer, as well as features for modifying stored images (remove red

eyes, rotate, crop, resize, adjust image quality, add colors and special effects, and more).

If you have trouble installing or using the HP Photosmart Software, see the HP Customer Care website for more information: www.hp.com/support.

Windows

If your Windows computer does not meet the system requirements as stated on your camera packaging, HP Photosmart Essential is installed instead of the full HP Photosmart Premier version.

1. Close all programs and temporarily disable any virus protection software.
2. Insert the HP Photosmart Software CD into the CD drive and follow the on-screen instructions. If the installation window does not appear, click **Start**, click **Run**, type **D:\Setup.exe**, where **D** is the letter of your CD drive, then click **OK**.
3. When the software has finished installing, re-enable virus protection software.



Macintosh

1. Insert the HP Photosmart Software CD into the CD drive.
2. Double-click the CD icon on the computer desktop.
3. Double-click the installer icon, then follow the on-screen instructions.

3 Taking pictures and recording video clips



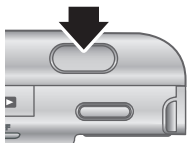

Live View allows you to frame pictures and video clips in the Image Display.

Take a still picture

1. Press  /  until  appears briefly in the upper right corner of the Image Display. This indicates you are in **Live View**.
2. Frame the subject for your picture.
3. Press the **Shutter** button halfway down to measure and lock the focus and exposure. The focus brackets in the Image Display turn solid green when focus is locked.
4. Press the **Shutter** button all the way down to take the picture.
5. To add an audio clip of up to 60 seconds, continue holding the **Shutter** button down, then release it when done.



Record a video clip

1. Press  /  until  appears briefly in the upper right corner of the Image Display. This indicates you are in **Live View**.
2. Frame the subject.
3. Press and release the **Video**  button.

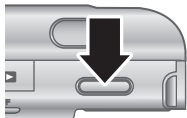





4. To stop recording video, press and release the **Video**  button again.

4 Reviewing and deleting images and video clips











Review images and video clips

You can review and work with images and video clips in **Playback**.

1. Press  /  until  appears in the briefly upper right corner of the Image Display. This indicates you are in **Playback**.
2. Use   to scroll through your images and video clips (video clips play automatically).

Delete an image

You can delete individual images during **Playback**:

1. Press  /  until  appears in the briefly upper right corner of the Image Display. This indicates you are in **Playback**.
2. Use   to select an image or video clip.
3. Press  to display the **Delete** sub-menu.
4. Use   to select **This Image**, then press  .

5 Transferring and printing images

Transfer images

If you have installed the HP Photosmart Software, use this method to transfer images and video clips to your computer. If you have not installed the HP Photosmart Software, see the electronic User Guide for an alternate method.

Tip You can also perform this task using an optional HP Photosmart camera dock (see the dock User Guide).

1. Turn off the camera, then connect it to the computer using the USB cable that came with your camera.
2. Turn on the camera and follow the instructions on the computer screen to transfer the images.

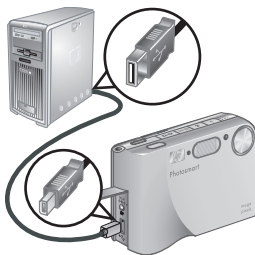

For more information,

see the Help feature in the HP Photosmart Software.

Print images from the camera

You can connect the camera to any PictBridge-certified printer to print still images and frames saved from a video clip.



1. Check that the printer is turned on, there is paper in the printer, and there are no printer error messages.

2. Connect the camera and printer using the USB cable that came with your camera.
3. Turn on the camera.
4. When the camera is connected to the printer, the **Print Setup Menu** displays on the camera. To change the settings, use ▲▼ on the camera to select a menu option, then use ◀▶ on the camera to change the setting.
5. Press $\frac{\text{Menu}}{\text{OK}}$ to begin printing.

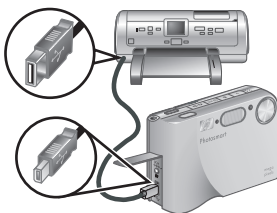

6 Camera quick reference

Use this chapter as a quick reference to camera features. To learn more about these camera features, refer to the electronic User Guide.

Live View and Playback

- **Live View** allows you to frame pictures and video clips in the Image Display. To activate **Live View**, press / until appears briefly in the upper right corner of the Image Display.
- **Playback** allows you review and work with images and video clips. To activate **Playback**, press / until appears briefly in the upper right corner of the Image Display.

Menus



When you press ^{Menu}_{OK} from either **Playback** or **Live View**, you access the tabbed camera menus, as shown in the example screen.





Use to move to the desired menu. Within a menu, use to move to specific selections.

To exit the menu, press / at any time.

Menus and options are:

Menu	Options
<p> Capture allows you to adjust camera settings that affect the characteristics of future images and video clips you capture with your camera.</p>	<ul style="list-style-type: none"> • Shooting Modes (Auto Mode, Landscape, Portrait, Theatre, Panorama Right, Panorama Left, Action, Night Portrait, Night Scenery, Beach, Snow, Sunset, Document) • Self-Timer • Red-Eye Removal • Exposure Compensation • Adaptive Lighting • Bracketing • Image Quality • Video Quality • Burst • White Balance • Auto Focus Area • AE Metering • ISO Speed • Saturation • Sharpness • Contrast • Date & Time Imprint
<p> Playback allows you to work with images you have stored in the camera.</p>	<ul style="list-style-type: none"> • Image Advice • Image Info • View Slideshow • Stitch Panorama • Record Audio • Move Images to Card

Menu	Options
 Design Gallery allows you to enhance the images you have captured.	<ul style="list-style-type: none">• Apply Artistic Effects• Modify Color• Add Borders• Remove Red Eyes• Rotate• Crop
 Setup allows you to change the camera's behavior.	<ul style="list-style-type: none">• Display Brightness• Sounds Volume• Focus Assist Light• Display Timeout• Instant Review• Digital Zoom• Date & Time• USB Configuration• TV Configuration• Language• Reset Settings
 Help provides descriptions of camera features and picture-taking tips.	<ul style="list-style-type: none">• Top Ten Tips• Camera Accessories• Camera Buttons• Using Shooting Modes• Using Design Gallery• Sharing Images• Printing Images• Recording Audio Clips• Recording Video Clips• Reviewing Images and Videos• Extracting Prints from Video• Deleting Images• Transferring Images

Menu	Options
	<ul style="list-style-type: none">• Managing Batteries• Getting Assistance• Camera Shortcuts• About...

When you press  while in **Live View** or **Playback**, you see the **Photosmart Express** menu.

Menu	Options
 Photosmart Express allows you to share your photos with friends and relatives.	<ul style="list-style-type: none">• Print• Buy Prints Online• Share All Images• Share Menu Setup

English

Appareil photo numérique HP Photosmart R725/R727

Français



Informations légales et remarques

© Copyright 2006 Hewlett-Packard Development Company, L.P.

Les informations contenues dans le présent document sont sujettes à modification sans préavis. Les seules garanties pour les produits et services HP sont énoncées dans les déclarations de garantie expresse accompagnant lesdits produits et services. Aucun élément du présent document ne saurait être interprété comme constituant une garantie supplémentaire. HP ne saurait être tenu pour responsable d'éventuelles erreurs ou omissions techniques ou rédactionnelles contenues dans le présent document.

Windows® est une marque déposée de Microsoft Corporation aux Etats-Unis.



est une marque commerciale de son propriétaire.



Mise au rebut des équipements usagés par les particuliers résidant au sein de l'Union européenne

Figurant sur le produit ou sur son emballage, ce symbole indique que vous ne devez pas jeter le produit avec vos déchets ménagers. Il vous incombe de déposer votre équipement usagé dans un centre de récupération des déchets spécialisé dans le recyclage des appareils électriques et électroniques. Le tri et le recyclage sélectifs de vos déchets contribuent à préserver les ressources naturelles et sont effectués de telle sorte que ni la santé de l'homme, ni l'environnement ne soient affectés. Pour plus d'informations sur les sites où vous pouvez déposer vos équipements usagés à des fins de recyclage, renseignez-vous auprès du service concerné à la mairie de votre lieu de résidence, du service de voirie ou du magasin où vous avez acheté votre produit.

Veillez noter les informations suivantes pour référence ultérieure :

- Numéro de modèle (indiqué en façade de l'appareil photo) : _____
- Numéro de série (sous l'appareil photo) : _____
- Date d'achat : _____

Français

Sommaire

1	Prise en main	5
	Accéder au Guide de l'utilisateur au format électronique.....	6
	Dessus et arrière de l'appareil photo	7
	Façade et dessous de l'appareil photo.....	9
	Kit d'adaptation de la station d'accueil.....	10
2	Préparation de votre appareil photo	11
	Installation de la batterie.....	11
	Chargement de la batterie.....	11
	Mise en marche de l'appareil photo.....	12
	Choix de la langue.....	12
	Sélection de la région.....	12
	Réglage de la date et de l'heure.....	13
	Installation et formatage d'une carte mémoire (en option).....	13
	Installation du logiciel.....	14
3	Prises de vue et enregistrement de clips vidéo	16
	Prise d'une photo.....	16
	Enregistrement d'un clip vidéo.....	17
4	Revisualisation et suppression des images et des clips vidéo	18
	Revisualisation des images et des clips vidéo	18
	Suppression d'une image.....	18
5	Transfert et impression d'images	20
	Transfert d'images.....	20
	Impression d'images à partir de l'appareil photo.....	21
6	Guide de référence rapide de l'appareil photo	22

1 Prise en main

Ce guide imprimé de prise en main rapide fournit les informations nécessaires à l'utilisation des principales fonctionnalités de votre appareil photo. Pour obtenir des informations détaillées sur l'ensemble de ses fonctionnalités, consultez le Guide de l'utilisateur au format électronique.

Guide de prise en main rapide	Guide de l'utilisateur au format électronique
<p>Ce guide imprimé vous permettra :</p> <ul style="list-style-type: none">• D'utiliser votre appareil photo rapidement• D'installer le logiciel HP Photosmart• De vous familiariser avec les fonctionnalités de votre appareil photo	<p>Le Guide de l'utilisateur au format électronique comprend :</p> <ul style="list-style-type: none">• Des descriptions de l'ensemble des fonctionnalités de l'appareil photo• Une description des icônes qui apparaissent à l'écran• Des informations relatives à la batterie, notamment :<ul style="list-style-type: none">– L'extension de son autonomie– Une description des icônes d'indication de charge• Résolution des problèmes• Obtenir une assistance auprès de HP

- Caractéristiques de l'appareil photo

Accéder au Guide de l'utilisateur au format électronique



Le Guide de l'utilisateur au format électronique se trouve sur le CD HP Photosmart Software.

Pour consulter le Guide de l'utilisateur :

1. Insérez le CD HP Photosmart Software dans le lecteur de CD-ROM de votre ordinateur.
2. **Sous Windows** : cliquez sur **Afficher le Guide de l'utilisateur** dans la page principale de l'écran d'installation.

Sous Macintosh : ouvrez le fichier **readme** du dossier **docs** du CD.

Le Guide de l'utilisateur au format électronique est également copié sur votre ordinateur lorsque vous installez le logiciel HP Photosmart. Pour vous assurer que le guide a bien été installé sur votre ordinateur :

- **Sous Windows** : lancez le **Centre de solutions HP** et cliquez sur **Aide et support**.
- **Sous Macintosh** : lancez le **HP Device Manager** et sélectionnez **Guide de l'utilisateur** dans le menu contextuel **Informations et paramètres**.







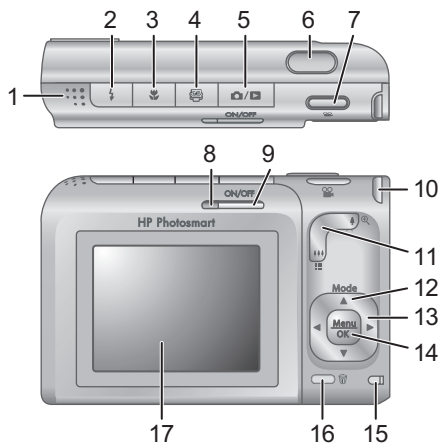







Obtenir une assistance



- Pour bénéficier de conseils et d'outils pour une utilisation plus efficace de votre appareil photo, consultez le site Web à l'adresse **www.hp.com/photosmart** (en anglais uniquement) ou **www.hp.com**.
- Pour obtenir une assistance produit, des tests de diagnostic et des pilotes à télécharger 24 heures sur 24 et 7 jours sur 7, consultez le site Web à l'adresse **www.hp.com/support**.
- Pour obtenir une assistance pour le logiciel HP Photosmart, consultez l'aide en ligne correspondante.

Dessus et arrière de l'appareil photo



1	Haut-parleur
---	--------------

2	 Bouton Flash — Les paramètres sont Auto, Flash activé, Flash désactivé.
3	 Bouton Mise au point — Les paramètres sont Normal, Macro, Macro auto, Infini.
4	 Bouton Photosmart Express — Les options sont Imprimer, Commander des tirages en ligne, Config Partage.
5	 /  Bouton Prévisualisation/Lecture — Permet de basculer entre les modes Prévisualisation et Lecture (voir <i>Prévisualisation et Lecture</i> , page 22).
6	Déclencheur.
7	 Bouton Vidéo.
8	Voyant d'alimentation.
9	Bouton ON/OFF.
10	Attache sangle.
11	Bouton de zoom (numérique et optique) — En mode Prévisualisation , appuyez sur  pour effectuer un zoom avant ou sur  pour effectuer un zoom arrière. Dans Lecture , appuyez sur  pour agrandir l'image sélectionnée ou sur  pour afficher des vues miniatures de vos images.
12	Bouton Mode — Appuyez sur  pour accéder au menu Mode de prise de vue lorsque vous êtes en mode Prévisualisation . Les options du Mode de prise de vue sont Mode auto, Paysage, Portrait, Théâtre, Panorama à droite, Panorama à gauche, Action, Portrait nuit, Paysage nuit, Plage, Neige, Coucher de soleil et Document.
13	Boutons   et   — Permettent de parcourir les menus et les images.

14	Bouton  — Permet d'afficher les menus de l'appareil photo, de sélectionner les options et de confirmer les actions.
15	Voyant de charge de la batterie.
16	 Bouton Supprimer — Permet d'accéder à la fonction Supprimer lorsque vous êtes en mode Lecture .
17	Ecran.

Façade et dessous de l'appareil photo

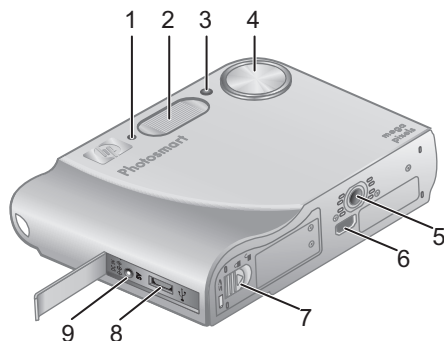

1	Microphone.
2	Flash.
3	Voyant du retardateur/de la mise au point.
4	Objectif.
5	Filetage pour trépied.
6	Connecteur de station d'accueil.
7	Volet du compartiment de la carte mémoire/batterie.

8	Connecteur USB
9	Connecteur pour adaptateur secteur

Kit d'adaptation de la station d'accueil

Lorsque vous achetez une station d'accueil HP Photosmart (en option), elle vous est fournie avec plusieurs kits d'adaptation transparents. Pour utiliser la station d'accueil avec cet appareil photo, mettez en place le kit d'adaptation comportant une pastille bleue. Reportez-vous au Guide de l'utilisateur de la station d'accueil pour obtenir des instructions.

2 Préparation de votre appareil photo

Installation de la batterie

1. Ouvrez le volet du compartiment de la batterie/carte mémoire en faisant glisser le loquet, comme indiqué sur le volet du compartiment.
2. Insérez la batterie dans le logement le plus large, puis enfoncez-la jusqu'à enclenchement du loquet.
3. Refermez le volet du compartiment de la batterie/carte mémoire.



Français

Remarque Eteignez l'appareil photo avant de retirer la batterie. Avant la première utilisation de la batterie, chargez-la complètement.

Chargement de la batterie

Vous pouvez charger la batterie directement dans l'appareil photo, en utilisant l'adaptateur secteur.



Connectez l'adaptateur secteur à l'appareil photo, puis branchez-le sur une prise électrique.

Lorsque le voyant de charge de la batterie clignote, la batterie est en cours de charge. Lorsque ce voyant

cesse de clignoter (au bout de 2 à 3 heures), la batterie est entièrement chargée.

Mise en marche de l'appareil photo

Pour mettre en marche votre appareil photo, appuyez sur le bouton ON/OFF.

Choix de la langue

Utilisez ▲▼◀▶ pour sélectionner la langue de votre choix, puis appuyez sur .

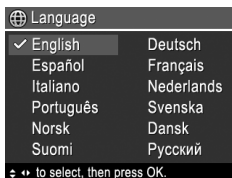



Sélection de la région

Les paramètres **Langue** et **Région** déterminent le format par défaut de la date et du signal vidéo pour l'affichage des images de l'appareil photo sur un téléviseur.



Utilisez ▲▼ pour sélectionner la région de votre choix, puis appuyez sur .

Réglage de la date et de l'heure

1. Utilisez ▲▼ pour régler la valeur en surbrillance.
2. Utilisez ◀▶ pour passer aux autres choix et réitérez l'étape 1 jusqu'à ce que la date et l'heure soient correctement réglées.
3. Appuyez sur  lorsque les paramètres de date, d'heure et de format sont corrects, puis appuyez de nouveau sur  pour confirmation.











Installation et formatage d'une carte mémoire (en option)

Cet appareil photo prend en charge les cartes mémoire SD (Secure Digital) de marque HP, de 8 Mo à 2 Go (standard et haute vitesse).



1. Éteignez l'appareil photo et ouvrez le volet du compartiment de la batterie/carte mémoire.
2. Insérez la carte mémoire (en option) dans le logement le plus petit, comme illustré. Assurez-vous que la carte mémoire est bien en place.
3. Fermez le volet du compartiment de la batterie/carte mémoire et allumez l'appareil photo.

Formatez toujours les cartes mémoire avant leur première utilisation.

1. Lorsque l'appareil est allumé, appuyez sur  /  jusqu'à ce que vous passiez en mode **Lecture**.
2. Appuyez sur  pour afficher le sous-menu **Supprimer**.
3. Utilisez   pour sélectionner **Formater la carte**, puis appuyez sur .
4. Utilisez   pour sélectionner **Oui**, puis appuyez sur  pour formater la carte.

Une fois la carte mémoire installée, toutes les nouvelles images et tous les nouveaux clips vidéo ne sont plus stockés dans la mémoire interne mais sur cette carte.

Pour utiliser la mémoire interne et visualiser les images qu'elle contient, retirez la carte mémoire.

Installation du logiciel

Le logiciel HP Photosmart vous permet de transférer des images et des clips vidéo vers votre ordinateur et de modifier des images stockées (suppression des yeux rouges, rotation, recadrage, redimensionnement, amélioration de la qualité d'image, ajout de couleurs et d'effets spéciaux, etc.).

Si vous rencontrez des difficultés pour installer le logiciel HP Photosmart, consultez le site Web du centre d'assistance clientèle HP pour plus d'informations :

www.hp.com/support.

Windows

Si votre ordinateur sous Windows ne répond pas à la configuration requise telle qu'elle est indiquée sur l'emballage de votre appareil photo, le logiciel HP Photosmart Essential est installé à la place de la version complète HP Photosmart Premier.

1. Fermez tous les programmes et désactivez temporairement tout logiciel antivirus.
2. Insérez le CD HP Photosmart Software dans le lecteur de CD-ROM et suivez les instructions à l'écran. Si la fenêtre d'installation ne s'affiche pas, cliquez sur **Démarrer**, puis sur **Exécuter** et saisissez **D:\Setup.exe** (où **D** correspond à la lettre désignant votre lecteur de CD-ROM). Cliquez ensuite sur **OK**.
3. Une fois le logiciel installé, réactivez le logiciel antivirus.



Macintosh

1. Insérez le CD HP Photosmart Software dans le lecteur de CD-ROM de votre ordinateur.
2. Cliquez deux fois sur l'icône du CD-ROM située sur le bureau.
3. Cliquez deux fois sur l'icône d'installation et suivez les instructions qui s'affichent à l'écran.

3 Prises de vue et enregistrement de clips vidéo



Le mode **Prévisualisation** vous permet de cadrer vos images et vos clips vidéo dans l'écran.

Prise d'une photo

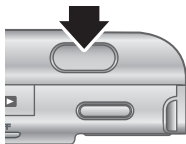

1. Appuyez sur  /  jusqu'à ce que  apparaisse brièvement dans l'angle supérieur droit de l'écran. Cela indique que vous êtes en mode **Prévisualisation**.
2. Cadrez le sujet de votre photo.
3. Enfoncez le **déclencheur** à mi-course pour mesurer la mise au point et l'exposition. Les parenthèses de mise au point à l'écran apparaissent en vert lorsque la mise au point est verrouillée.
4. Enfoncez entièrement le **déclencheur** pour prendre la photo.
5. Pour ajouter un commentaire audio de 60 secondes maximum, maintenez le **déclencheur** enfoncé, puis relâchez-le lorsque l'enregistrement est terminé.

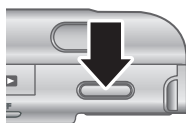

Enregistrement d'un clip vidéo

1. Appuyez sur  /  jusqu'à ce que  apparaisse brièvement dans l'angle supérieur droit de l'écran. Cela indique que vous êtes en mode







- Prévisualisation.**
2. Cadrez le sujet.
3. Appuyez sur le bouton **Vidéo**  et relâchez-le.
4. Pour arrêter l'enregistrement de la vidéo, appuyez à nouveau sur le bouton **Vidéo**  et relâchez-le.

4 Revisualisation et suppression des images et des clips vidéo





Revisualisation des images et des clips vidéo

Vous pouvez revisualiser et manipuler les images et clips vidéo en mode **Lecture**.

1. Appuyez sur  /  jusqu'à ce que  apparaisse brièvement dans l'angle supérieur droit de l'écran. Cela indique que vous êtes en mode **Lecture**.
2. Utilisez les boutons   pour parcourir vos images et vos clips vidéo (la lecture de ces derniers se lance automatiquement).

Suppression d'une image

Vous pouvez supprimer les images une à une lorsque vous êtes en mode **Lecture** :

1. Appuyez sur  /  jusqu'à ce que  apparaisse brièvement dans l'angle supérieur droit de l'écran. Cela indique que vous êtes en mode **Lecture**.
2. Utilisez  pour sélectionner une image ou un clip vidéo.
3. Appuyez sur  pour afficher le sous-menu **Supprimer**.

4. Utilisez ▲▼ pour sélectionner **Cette image**, puis appuyez sur $\frac{\text{Menu}}{\text{OK}}$.

Français

5 Transfert et impression d'images

Transfert d'images

Si vous avez installé le logiciel HP Photosmart, procédez comme suit pour transférer les images et les clips vidéo sur votre ordinateur. Dans le cas contraire, consultez le Guide de l'utilisateur au format électronique pour obtenir une autre méthode.

Conseil Vous pouvez également effectuer cette tâche à l'aide d'une station d'accueil HP Photosmart (en option) (voir le Guide de l'utilisateur de la station d'accueil).

1. Eteignez l'appareil photo, puis connectez-le à l'ordinateur à l'aide du câble USB fourni avec l'appareil.
2. Allumez l'appareil photo et suivez les instructions qui apparaissent à l'écran de l'ordinateur pour transférer les images. Pour plus d'informations, consultez l'Aide du logiciel HP Photosmart.

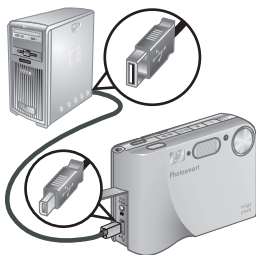

Impression d'images à partir de l'appareil photo

Vous pouvez connecter l'appareil photo à n'importe quelle imprimante compatible PictBridge pour imprimer des photos et des images provenant d'un clip vidéo.





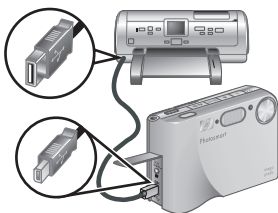



1. Vérifiez que l'imprimante est sous tension, qu'elle contient du papier et qu'elle n'affiche aucun message d'erreur.
2. Connectez l'appareil photo à l'imprimante à l'aide du câble USB fourni avec l'appareil.
3. Allumez l'appareil photo.
4. Lorsque l'appareil photo est connecté à l'imprimante, le menu **Config. d'impression** s'affiche sur l'appareil photo. Pour modifier les paramètres, utilisez ▲▼ sur l'appareil photo pour sélectionner une option de menu, puis ◀▶ pour modifier le paramètre.
5. Appuyez sur  pour lancer l'impression.



6 Guide de référence rapide de l'appareil photo

Utilisez ce chapitre comme guide de référence rapide sur les fonctionnalités de l'appareil photo. Pour plus d'informations sur les fonctionnalités de cet appareil photo, consultez le Guide de l'utilisateur au format électronique.

Prévisualisation et Lecture



- Le mode **Prévisualisation** vous permet de cadrer vos images et vos clips vidéo dans l'écran. Pour activer le mode **Prévisualisation**, appuyez sur  /  jusqu'à ce que l'icône  apparaisse brièvement dans l'angle supérieur droit de l'écran.
- Le mode **Lecture** vous permet de revisualiser et manipuler les images et les clips vidéo. Pour activer le mode **Lecture**, appuyez sur  /  jusqu'à ce que l'icône  apparaisse brièvement dans l'angle supérieur droit de l'écran.

Menus

En appuyant sur $\frac{\text{Menu}}{\text{OK}}$ à partir du mode **Lecture** ou du mode **Prévisualisation**, vous accédez aux onglets de menu de l'appareil photo, comme illustré dans cet exemple.







Utilisez ◀▶ pour atteindre le menu souhaité. Dans le menu, utilisez ▲▼ pour passer d'une sélection à une autre.

Pour quitter le menu, appuyez sur  / .

Les menus et options sont les suivants :

Menu	Options
 Capture vous permet de régler différents paramètres de l'appareil photo qui influent sur la qualité des images que vous capturez et des clips vidéo que vous enregistrez avec l'appareil photo.	<ul style="list-style-type: none">• Modes de prise de vue (Mode auto, Paysage, Portrait, Théâtre, Panorama à droite, Panorama à gauche, Action, Portrait nuit, Paysage nuit, Plage, Neige, Coucher de soleil et Document)• Retardateur• Suppression yeux rouges• Compens. exposition• Eclairage adaptatif• Bracketing• Qualité d'image• Qualité vidéo• Rafale• Balance des blancs• Zone de mise au point auto• Mesure AE• Sensibilité ISO• Saturation• Piqué• Contraste• Inclure date/heure

Menu	Options
<p> Lecture vous permet de manipuler les images que vous avez stockées dans l'appareil photo.</p>	<ul style="list-style-type: none"> • Conseils image • Propriétés de l'image • Voir diaporama • Juxtapos. pr créer panorama • Commentaire audio • Dépl. images sur carte
<p> Galerie créative vous permet d'améliorer les images que vous avez capturées.</p>	<ul style="list-style-type: none"> • Appliquer effets artistiques • Modifier couleur • Ajout bordures • Correction yeux rouges • Rotation • Recadrer
<p> Configuration vous permet de modifier le comportement de l'appareil photo.</p>	<ul style="list-style-type: none"> • Luminosité écran • Volume sonore • Voy. mise au pt • Délai d'extinction de l'écran • Revisualisation instantanée • Zoom numérique • Date et heure • Configuration USB • Configuration TV • Langue • Réinitialiser paramètres
<p> Aide comporte des descriptions des fonctionnalités de l'appareil photo et propose des conseils pour prendre vos photos.</p>	<ul style="list-style-type: none"> • 10 conseils • Accessoires de l'appareil • Boutons de l'appareil • Modes de prise de vue

Menu	Options
	<ul style="list-style-type: none"> ● Utilisation de la Galerie créative ● Partage d'images ● Impression d'images ● Enreg. comment. audio ● Enreg. de clips vidéo ● Visual. images et vidéos ● Extraction images de clips vidéo ● Suppression d'images ● Transfert d'images ● Gestion des batteries ● Obtenir de l'assistance ● Raccourcis de l'appareil photo ● A propos de...

En appuyant sur  à partir du mode **Prévisualisation** ou du mode **Lecture**, vous affichez le menu **Photosmart Express**.

Menu	Options
 Photosmart Express vous permet de partager vos photos avec vos amis et votre famille.	<ul style="list-style-type: none"> ● Imprimer ● Commander des tirages en ligne ● Partag. ttes les images ● Config Menu Partage

Français

Fotocamera digitale
HP Photosmart R725/R727

Italiano



Note legali

© Copyright 2006 Hewlett-Packard Development Company, LP
Le informazioni contenute in questo documento sono soggette a modifica senza preavviso. Le uniche garanzie per i prodotti e i servizi HP sono definite nelle dichiarazioni di garanzia esplicita che accompagnano tali prodotti e servizi. Nulla di quanto dichiarato nel presente documento costituisce una garanzia aggiuntiva. HP non sarà ritenuta responsabile di eventuali omissioni o errori tecnici o editoriali qui contenuti.

Windows® è un marchio registrato di Microsoft Corporation negli Stati Uniti.



Il logo SD è un marchio del rispettivo titolare.



Smaltimento di apparecchiature dismesse da parte dei cittadini dell'Unione Europea

La presenza di questo simbolo sul prodotto o sulla sua confezione sta ad indicare che il prodotto non può essere smaltito tra i rifiuti generici. È responsabilità di ogni singolo cittadino smaltire il prodotto consegnandolo al centro di raccolta autorizzato più vicino a scopo di riciclo. La raccolta differenziata di apparecchiature elettriche ed elettroniche dismesse e il loro smaltimento a scopo di riciclo costituiscono una efficace misura di salvaguardia della salute e dell'ambiente. Per ulteriori informazioni sullo smaltimento/riciclo di tali apparecchiature, rivolgersi al proprio rivenditore o all'ente locale preposto.

Per riferimento in futuro, inserire le seguenti informazioni:

- Numero del modello (sul lato anteriore della fotocamera): _____
- Numero di serie (sul lato inferiore della fotocamera): _____
- Data di acquisto: _____

Sommario

1	Informazioni preliminari	4
	Accesso alla Guida d'uso online.....	5
	Parte superiore e posteriore della fotocamera	6
	Lati anteriore e inferiore della fotocamera.....	8
	Inserito dell'alloggiamento per la fotocamera	8
2	Configurazione della fotocamera	10
	Installazione della batteria.....	10
	Carica della batteria.....	10
	Accensione della fotocamera.....	11
	Scelta della lingua.....	11
	Impostazione della regione.....	11
	Impostazione della data e dell'ora.....	11
	Installazione e formattazione di una scheda di memoria opzionale.....	12
	Installazione del software.....	13
3	Foto e videoclip	15
	Scatto delle foto.....	15
	Registrazione di videoclip.....	15
4	Visione e cancellazione di immagini e videoclip	17
	Visione di immagini e videoclip.....	17
	Cancellazione di un'immagine.....	17
5	Trasferimento e stampa delle immagini	18
	Trasferimento delle immagini.....	18
	Stampa delle immagini della fotocamera.....	19
6	Riferimento rapido per la fotocamera	20

1 Informazioni preliminari

Questa guida rapida fornisce le informazioni per poter iniziare ad utilizzare le funzioni di base della fotocamera. Per informazioni dettagliate sulle funzioni della fotocamera, consultare la Guida d'uso online.

Questa guida rapida	Guida d'uso online
<p data-bbox="197 496 472 519">Questa guida consente di:</p> <ul data-bbox="197 536 498 729" style="list-style-type: none"><li data-bbox="197 536 498 586">• Iniziare subito ad utilizzare la fotocamera<li data-bbox="197 594 498 644">• Installare il software HP Photosmart<li data-bbox="197 651 498 729">• Imparare a conoscere le funzioni di base della fotocamera	<p data-bbox="508 496 741 546">La Guida d'uso online contiene:</p> <ul data-bbox="508 564 809 1146" style="list-style-type: none"><li data-bbox="508 564 809 644">• Una descrizione di tutte le funzioni della fotocamera<li data-bbox="508 651 809 731">• Una descrizione delle icone visualizzate sul display LCD<li data-bbox="508 738 809 968">• Informazioni sulla batteria, tra cui:<ul data-bbox="560 803 809 968" style="list-style-type: none"><li data-bbox="560 803 809 858">– Ottimizzazione della durata della batteria<li data-bbox="560 865 809 968">– Una descrizione delle icone relative all'indicatore di alimentazione<li data-bbox="508 975 809 1001">• Soluzione dei problemi<li data-bbox="508 1008 809 1088">• Informazioni per richiedere l'assistenza HP<li data-bbox="508 1095 809 1146">• Specifiche della fotocamera

Accesso alla Guida d'uso online



La Guida d'uso online è disponibile sul CD del software HP Photosmart (HP Photosmart Software CD).

Per visualizzare la Guida d'uso:

1. Inserire il CD del software HP Photosmart nell'unità CD del computer.
2. **In Windows:** Fare clic su **Visualizza la Guida d'uso** nella pagina principale della schermata di installazione.
In Macintosh: Aprire il file **readme** nella cartella **docs** del CD.

La Guida d'uso online viene inoltre copiata sul computer quando si installa il software HP Photosmart. Per visualizzare la Guida d'uso dopo che è stata installata sul computer:

- **In Windows:** Aprire **Centro soluzioni HP** e fare clic su **Guida in linea**.
- **In Macintosh:** Aprire **HP Device Manager** e selezionare **Guida d'uso** dal menu a comparsa **Informazioni e impostazioni**.





Assistenza e supporto



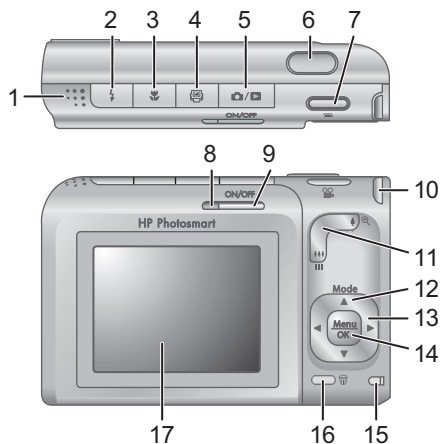









- Per suggerimenti e strumenti che permettano di ottimizzare l'utilizzo della fotocamera, visitare il sito Web all'indirizzo **www.hp.com/photosmart** (solo inglese) oppure **www.hp.com**.
- Per richiedere assistenza per il prodotto, scaricare i driver o eseguire programmi di diagnostica 24 ore al giorno, 7 giorni alla settimana, visitare il sito Web all'indirizzo **www.hp.com/support**.

- Per assistenza sull'uso del software HP Photosmart, consultare la guida online del software HP Photosmart.

Parte superiore e posteriore della fotocamera



1	Altoparlante.
2	 Pulsante flash : Le impostazioni sono Auto, Flash On, Flash Off.
3	 Pulsante messa a fuoco : Le impostazioni sono Normale, Macro, Auto Macro, Infinito.
4	 Pulsante Photosmart Express : Le opzioni disponibili sono Stampa, Acquisto stampe online, Config. Condividi.
5	 Pulsante vista al vivo/riproduzione : Consente di passare dalla modalità Vista dal vivo alla modalità

	Riproduzione (vedere <i>Vista dal vivo e Riproduzione</i> a pagina 20).
6	Pulsante otturatore .
7	 Pulsante video .
8	Spia di accensione.
9	Pulsante ON/OFF.
10	Cinghietta da polso.
11	Leva zoom (digitale e ottico): Nella vista dal vivo , premere  per aumentare l'ingrandimento oppure  per diminuirlo. Nella modalità Riproduzione , premere  per ingrandire l'immagine selezionata oppure  per visualizzare delle anteprime delle immagini.
12	Pulsante modalità di scatto : Premere  per accedere al menu delle modalità di scatto quando è attivata la vista dal vivo . Le impostazioni della modalità di scatto sono Automatica, Panorama, Ritratto, Teatro, Panoramica verso destra, Panoramica verso sinistra, Azione, Ritratto notturno, Scenario notturno, Spiaggia, Neve, Tramonto, Documento.
13	Pulsanti   e   : Consentono di scorrere i menu e le immagini.
14	Pulsante  : Consente di visualizzare i menu della fotocamera, selezionare le opzioni e confermare le azioni.
15	Spia di ricarica della batteria.
16	 Pulsante eliminazione : Consente di accedere alla funzione Elimina quando è attiva la modalità Riproduzione .
17	Display LCD.

Lati anteriore e inferiore della fotocamera

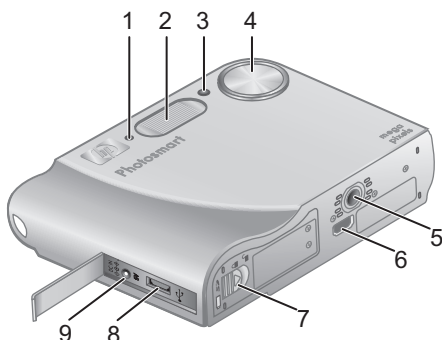

Italiano

1	Microfono.
2	Flash.
3	Spia Autoscatto/Supporto messa a fuoco.
4	Obiettivo.
5	Attacco treppiede.
6	Connettore alloggiamento.
7	Sportello vano batteria/scheda di memoria.
8	Connettore USB.
9	Connettore dell'adattatore di alimentazione.

Inserto dell'alloggiamento per la fotocamera

L'alloggiamento opzionale HP Photosmart viene fornito con più inserti. Quando si prepara l'alloggiamento perché possa essere utilizzato con questa fotocamera, utilizzare l'inserto contrassegnato da un'etichetta

circolare blu. Vedere la guida d'uso dell'alloggiamento
per le istruzioni.

Italiano

2 Configurazione della fotocamera

Installazione della batteria

1. Aprire lo sportello del vano batteria/scheda di memoria facendo scorrere il fermo come indicato sullo sportello.
2. Inserire la batteria nel vano più grande e spingerla fino a quando non si blocca in posizione.
3. Chiudere lo sportello del vano batteria/scheda di memoria.



Nota Spegnerne la fotocamera prima di rimuovere la batteria. Caricare completamente la batteria prima di utilizzarla per la prima volta.

Carica della batteria

È possibile caricare la batteria mentre è nella fotocamera usando l'adattatore CA.



Collegare l'adattatore CA alla fotocamera e poi ad una presa elettrica.

La spia di ricarica della batteria presente sulla fotocamera inizia a lampeggiare, ad indicare che la batteria si sta caricando; quando la spia smette di lampeggiare e resta accesa con luce fissa significa che la batteria è completamente carica (l'operazione di ricarica dura circa 2–3 ore).

Accensione della fotocamera

Per accendere la fotocamera, premere il pulsante ON/OFF.

Scelta della lingua

Usare ▲▼◀▶ per evidenziare la lingua desiderata e quindi premere

Menu
OK .

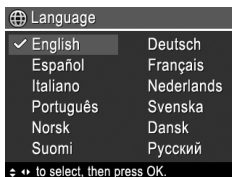

Impostazione della regione

Insieme all'impostazione della **Lingua**, quella della **Regione** determina il formato predefinito per la data e per il segnale video usato per visualizzare le immagini della fotocamera su un televisore.



Usare ▲▼ per evidenziare la regione desiderata e quindi premere Menu OK .

Impostazione della data e dell'ora

1. Usare ▲▼ per regolare il valore evidenziato.
2. Usare ◀▶ per passare alle altre selezioni e ripetere il passo 1 finché la data e l'ora non sono impostate correttamente.

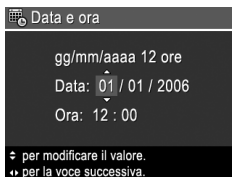

Italiano

3. Premere $\frac{\text{Menu}}{\text{OK}}$ quando le impostazioni di data, ora e formato sono corrette e quindi premere nuovamente $\frac{\text{Menu}}{\text{OK}}$ per confermare.

Installazione e formattazione di una scheda di memoria opzionale

Questa fotocamera supporta schede di memoria HP Secure Digital (SD), sia standard che ad alta velocità, da 8 MB a 2 GB.



1. Spegnerne la fotocamera e aprire lo sportello del vano batteria/scheda di memoria.
2. Inserire la scheda di memoria opzionale nell'alloggiamento più piccolo, come mostrato nella figura. Accertarsi che la scheda di memoria scatti in posizione.
3. Chiudere lo sportello del vano batteria/scheda di memoria ed accendere la fotocamera.

Formattare sempre le schede di memoria prima di utilizzarle per la prima volta.

1. Quando la fotocamera è accesa, premere $\frac{\text{C}}{\text{V}}$ fino a quando non viene attivata la modalità **Riproduzione**.
2. Premere $\frac{\text{C}}{\text{V}}$ per visualizzare il sottomenu **Elimina**.
3. Usare $\frac{\blacktriangle}{\blacktriangledown}$ per selezionare **Formatta scheda** e poi premere $\frac{\text{Menu}}{\text{OK}}$.
4. Usare $\frac{\blacktriangle}{\blacktriangledown}$ per selezionare **Sì**, quindi premere $\frac{\text{Menu}}{\text{OK}}$ per formattare la scheda.

Quando si installa una scheda di memoria nella fotocamera, tutte le nuove immagini e i videoclip

vengono memorizzati sulla scheda e non nella memoria interna.

Per utilizzare la memoria interna e visualizzare le immagini in essa memorizzate, è necessario prima rimuovere la scheda di memoria.

Installazione del software

Il software HP Photosmart dispone di specifiche funzioni per trasferire sul computer immagini e videoclip e per modificare le immagini memorizzate (ad esempio, è possibile rimuovere gli occhi rossi, ruotare, ritagliare, ridimensionare le foto, modificarne la qualità, aggiungere colori ed effetti speciali, ecc.).

Se durante l'installazione o l'uso del software HP Photosmart si verificano dei problemi, visitare il sito Web per l'assistenza clienti HP per richiedere maggiori informazioni: www.hp.com/support.

Windows

Se il computer Windows non soddisfa i requisiti di sistema indicati sulla confezione della fotocamera, al posto della versione completa HP Photosmart Premier viene installata la versione HP Photosmart Essential.

1. Chiudere tutti i programmi e disattivare temporaneamente eventuali software antivirus.
2. Inserire il CD del software HP Photosmart nell'unità CD e seguire le istruzioni visualizzate. Se non viene visualizzata la finestra di installazione, fare clic su **Start, Esegui**, digitare **D:\Setup.exe** (dove **D** è la lettera che corrisponde all'unità CD) e quindi fare clic su **OK**.

3. Terminata l'installazione del software, riattivare il software antivirus.



Macintosh

1. Inserire il CD del software HP Photosmart nell'unità CD.
2. Fare doppio clic sull'icona del CD sulla scrivania.
3. Fare doppio clic sull'icona del programma di installazione e seguire le istruzioni visualizzate.

3 Foto e videoclip



La modalità **Vista dal vivo** consente di inquadrare le foto e i videoclip sul display LCD.

Scatto delle foto

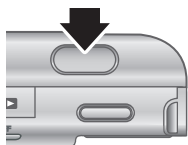

1. Premere  /  fino a quando nell'angolo superiore destro del display LCD non appare . Ciò indica che è attiva la modalità **Vista dal vivo**.
2. Inquadrare il soggetto della foto.
3. Premere a metà il pulsante **otturatore** per misurare e bloccare la messa a fuoco e l'esposizione. Il quadro di messa a fuoco sul display LCD si accende con luce verde fissa quando la messa a fuoco è bloccata.
4. Premere fino in fondo il pulsante **otturatore** per scattare la foto.
5. Per aggiungere un clip audio della durata massima di 60 secondi, continuare a tenere premuto il pulsante **otturatore** e rilasciarlo una volta terminata la registrazione.

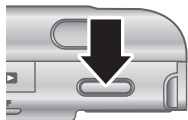

Registrazione di videoclip

1. Premere  /  fino a quando nell'angolo superiore destro del display LCD non appare . Ciò indica che è attiva la modalità **Vista dal vivo**.
2. Inquadrare il soggetto.







3. Premere e rilasciare il pulsante **video** .
4. Per interrompere la registrazione, premere e rilasciare di nuovo il pulsante **video** .

4 Visione e cancellazione di immagini e videoclip











Visione di immagini e videoclip

In modalità **Riproduzione** è possibile rivedere e manipolare foto e videoclip.

1. Premere  /  fino a quando nell'angolo superiore destro del display LCD non appare . Ciò indica che è attiva la modalità **Riproduzione**.
2. Usare   per scorrere foto e videoclip (la riproduzione dei videoclip parte automaticamente).

Cancellazione di un'immagine

Quando è attiva la modalità **Riproduzione** si possono eliminare singole immagini:

1. Premere  /  fino a quando nell'angolo superiore destro del display LCD non appare . Ciò indica che è attiva la modalità **Riproduzione**.
2. Usare   per selezionare un'immagine o un videoclip.
3. Premere  per visualizzare il sottomenu **Elimina**.
4. Usare   per selezionare **Corrente**, quindi premere  .

5 Trasferimento e stampa delle immagini

Trasferimento delle immagini

Se è stato installato il software HP Photosmart, utilizzarlo per trasferire immagini e videoclip sul computer. Se non è stato installato il software HP Photosmart, consultare la Guida d'uso online per un metodo alternativo.

Suggerimento È possibile eseguire questa operazione anche utilizzando un alloggiamento opzionale HP Photosmart (vedere la guida d'uso dell'alloggiamento).

1. Spegner la fotocamera e poi collegarla al computer usando il cavo USB fornito con la fotocamera.
2. Accendere la fotocamera e seguire le istruzioni visualizzate sullo schermo del computer per trasferire le immagini. Per ulteriori informazioni, consultare la guida online del software HP Photosmart.

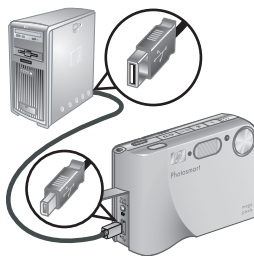

Stampa delle immagini della fotocamera

È possibile collegare la fotocamera ad una qualsiasi stampante compatibile PictBridge per stampare foto e inquadrature estratte dai videoclip.





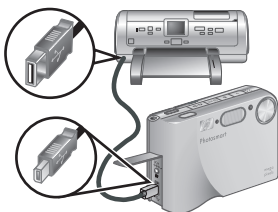



1. Verificare che la stampante sia accesa, che la carta sia caricata e che non siano visualizzati messaggi di errore relativi alla stampante.
2. Collegare la fotocamera e la stampante usando il cavo USB fornito con la fotocamera.
3. Accendere la fotocamera.
4. Dopo che la fotocamera è stata collegata alla stampante, sulla fotocamera viene visualizzato il menu **Imposta stampante**. Per modificare le impostazioni, usare ▲▼ sulla fotocamera per selezionare un'opzione e, quindi, usare ◀▶ per modificarne l'impostazione.
5. Premere $\frac{\text{Menu}}{\text{OK}}$ per iniziare a stampare.



6 Riferimento rapido per la fotocamera

Usare questo capitolo come riferimento rapido alle funzioni della fotocamera. Per maggiori informazioni sulle funzioni della fotocamera, consultare la Guida d'uso online.

Vista dal vivo e Riproduzione





- La modalità **Vista dal vivo** consente di inquadrare le foto e i videoclip nel display LCD. Per attivare la **vista dal vivo**, premere  /  fino a quando nell'angolo superiore destro del display LCD non appare .
- La modalità **Riproduzione** consente di visionare e manipolare immagini e videoclip. Per attivare la **riproduzione**, premere  /  fino a quando nell'angolo superiore destro del display LCD non appare .



Menu

Quando si preme  mentre è attiva la modalità



Riproduzione o **Vista dal vivo**, si accede ai menu della fotocamera, come mostrato nella schermata di esempio.



Usare   per spostarsi sul menu desiderato. All'interno di un menu, usare   per spostarsi sulle opzioni desiderate.

Per chiudere il menu, premere in un qualsiasi momento  / .

I menu e le opzioni sono:

Menu	Opzioni
<p> Cattura consente di regolare le impostazioni della fotocamera che incidono sulle caratteristiche di immagini e videoclip che si cattureranno con la fotocamera.</p>	<ul style="list-style-type: none">● Modalità di scatto (Automatica, Panorama, Ritratto, Teatro, Panoramica verso destra, Panoramica verso sinistra, Azione, Ritratto notturno, Scenario notturno, Spiaggia, Neve, Tramonto, Documento)● Autoscatto● Eliminazione occhi rossi● Compensazione esposizione● Illuminazione adattativa● Esposizione a forcella● Qualità img.● Qualità video● Scatto continuo● Bilanciam. bianco● Area messa a fuoco autom.● Esposizione AE● Velocità ISO● Saturazione● Nitidezza● Contrasto● Inserimento di data e ora
<p> Riproduzione consente di manipolare le immagini salvate nella fotocamera.</p>	<ul style="list-style-type: none">● Suggestimenti● Info immagine● Visualizza presentazione

Menu	Opzioni
	<ul style="list-style-type: none"> ● Cuci panoramica ● Registra audio ● Sposta imm. su scheda...
<p> Galleria effetti consente di migliorare le immagini catturate.</p>	<ul style="list-style-type: none"> ● Applica effetti artistici ● Modifica colore ● Aggiungi contorni ● Elimina occhi rossi ● Ruota ● Ritaglia
<p> Configura consente di modificare le impostazioni della fotocamera.</p>	<ul style="list-style-type: none"> ● Lumin. display ● Volume suoni ● Luce supp. fuoco ● Timeout display ● Revisione ● Zoom digitale ● Data e ora ● Configurazione USB ● Configurazione TV ● Lingua ● Ripristina impostazioni...
<p>?? descrive le funzioni della fotocamera e fornisce dei suggerimenti per migliorare gli scatti.</p>	<ul style="list-style-type: none"> ● 10 utili suggerimenti ● Accessori ● Pulsanti fotocamera ● Uso delle modalità di scatto ● Utilizzo della galleria degli effetti ● Condivisione immagini ● Stampa immagini ● Registrazione clip audio ● Registrazione videoclip

Menu	Opzioni
	<ul style="list-style-type: none"> ● Revisione immagini e video ● Estrazione stampe da video ● Cancellazione immagini ● Trasferimento immagini ● Manutenzione batterie ● Assistenza ● Accesso rapido ● Info su...

Quando si preme  mentre è attiva la modalità **Vista dal vivo** o **Riproduzione**, viene visualizzato il menu **Photosmart Express**.

Menu	Opzioni
 Photosmart Express consente di condividere le foto con parenti e amici.	<ul style="list-style-type: none"> ● Stampa ● Acquisto stampe online ● Condividi tutte ● Config. Condividi...

Italiano

HP Photosmart R725/R727 Digitalkamera

Deutsch



Rechtliche Hinweise

© Copyright 2006 Hewlett-Packard Development Company, L.P.

Die Informationen in diesem Dokument können ohne vorherige Ankündigung geändert werden. Für HP Produkte und Dienste gelten nur die Gewährleistungen, die in den ausdrücklichen Gewährleistungserklärungen des jeweiligen Produkts bzw. Dienstes aufgeführt sind. Dieses Dokument gibt keine weiteren Gewährleistungen. HP haftet nicht für technische oder redaktionelle Fehler oder Auslassungen in diesem Dokument. Windows® ist eine in den USA eingetragene Marke der Microsoft Corporation.

Das  SD-Logo ist eine Marke des entsprechenden Eigentümers.



Entsorgung von Altgeräten durch Benutzer in Privathaushalten in der EU

 Dieses Symbol auf dem Produkt oder auf der Verpackung weist darauf hin, dass das Produkt nicht als Hausmüll entsorgt werden darf. Sie sind stattdessen dafür verantwortlich, Altgeräte bei der zuständigen Sammelstelle zum Recycling von Elektrogeräten und Elektronikzubehör abzugeben. Mülltrennung und das Recycling von Altgeräten schonen die natürlichen Ressourcen und stellen sicher, dass die Geräte in einer Art und Weise wiederverwertet werden, die die Gesundheit von Menschen und die Umwelt schützt. Weitere Informationen zu den Sammelstellen für Ihre Altgeräte zum Recycling erhalten Sie bei der zuständigen Stelle der Stadtverwaltung, beim Entsorgungsunternehmen für Ihren Hausmüll oder in dem Geschäft, in dem das Produkt gekauft wurde.

Notieren Sie für zukünftige Nachfragen die folgenden Daten:

- Modellnummer (Vorderseite der Kamera): _____
- Seriennummer (Unterseite der Kamera): _____
- Kaufdatum: _____

Inhalt

1 Erste Schritte	4
Zugreifen auf das elektronische Benutzerhandbuch.....	5
Ober- und Rückseite der Kamera.....	6
Vorder- und Unterseite der Kamera.....	8
Dockinginsatz für die Kamera.....	8
2 Einrichten Ihrer Kamera	10
Einsetzen der Batterie.....	10
Aufladen der Batterie.....	10
Einschalten der Kamera.....	11
Auswählen der Sprache.....	11
Einstellen der Region.....	11
Einstellen von Datum und Uhrzeit.....	12
Einsetzen und Formatieren einer optionalen Speicherkarte.....	12
Installieren der Software.....	13
3 Aufnahmen von Bildern und Videoclips	15
Aufnahmen eines Einzelbilds.....	15
Aufnahmen eines Videoclips.....	16
4 Betrachten und Löschen von Bildern und Videoclips	17
Betrachten von Bildern und Videoclips.....	17
Löschen eines Bilds.....	17
5 Übertragen und Drucken von Bildern	19
Übertragen von Bildern.....	19
Drucken von Bildern von der Kamera aus.....	20
6 Kurzreferenz für Kamerafunktionen	21

1 Erste Schritte

Diese gedruckte Kurzeinführung enthält alle notwendigen Informationen zur erstmaligen Verwendung der grundlegenden Funktionen der Kamera. Im elektronischen Benutzerhandbuch finden Sie detaillierte Informationen zu den Funktionen der Kamera.

Kurzeinführung	Elektronisches Benutzerhandbuch
<p>Dieses gedruckte Handbuch behandelt folgende Themen:</p> <ul style="list-style-type: none">• Schnelle Inbetriebnahme der Kamera• Installation der HP Photosmart-Software• Vorstellung der Kamerafunktionen	<p>Das elektronische Benutzerhandbuch behandelt folgende Themen:</p> <ul style="list-style-type: none">• Beschreibungen aller Kamerafunktionen• Beschreibung der Symbole auf der Bildanzeige• Informationen zu Batterien/Akkus, einschließlich:<ul style="list-style-type: none">– Verlängern der Batterielebensdauer– Beschreibung der Stromversorgungssymbole• Fehlerbehebung• Unterstützung durch HP• Technische Daten der Kamera

Zugreifen auf das elektronische Benutzerhandbuch



Das elektronische Benutzerhandbuch befindet sich auf der HP Photosmart Software CD.

So zeigen Sie das Benutzerhandbuch an:

1. Legen Sie die HP Photosmart Software CD in das CD-Laufwerk Ihres Computers ein.
2. **Unter Windows:** Klicken Sie auf der Hauptseite der Installationsanzeige auf **Benutzerhandbuch anzeigen**.
Unter Macintosh: Öffnen Sie auf der CD im Ordner **docs** die **Readme**-Datei.

Das elektronische Benutzerhandbuch wird auf Ihren Computer kopiert, wenn Sie die HP Photosmart-Software installieren. Gehen Sie wie folgt vor, um sich das Benutzerhandbuch nach dessen Installation auf dem Computer anzeigen zu lassen:

- **Unter Windows:** Öffnen Sie das **HP Solution Center**, und klicken Sie auf **Hilfe und Support**.
- **Unter Macintosh:** Öffnen Sie den **HP Device Manager** (HP Geräte-Manager), und wählen Sie **User Guide** (Benutzerhandbuch) im Popup-Menü **Information and Settings** (Informationen und Einstellungen) aus.

Unterstützung

- Tipps und Tools zur effizienten Nutzung der Kamera finden Sie unter **www.hp.com/photosmart** (nur in englischer Sprache) oder **www.hp.com**.

- Weitere Unterstützung zum Produkt, Diagnosefunktionen und Treiber-Downloads erhalten Sie rund um die Uhr (24x7) unter **www.hp.com/support**.
- Weitere Hilfe zur HP Photosmart-Software finden Sie in der Onlinehilfe für die HP Photosmart-Software.

Ober- und Rückseite der Kamera

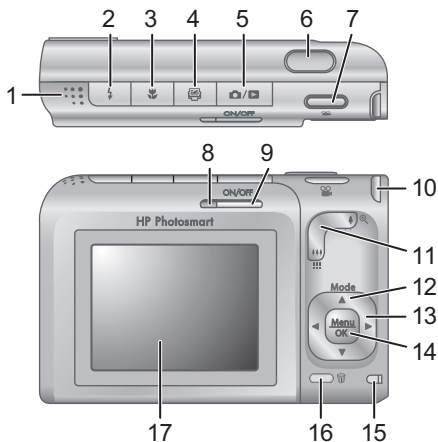

1	Lautsprecher.
2	⚡ Blitz (Taste) – Die möglichen Einstellungen sind "Autom.", "Blitz Ein" und "Blitz Aus".
3	🌸 Fokus (Taste) – Die möglichen Einstellungen sind "Normaler Fokus", "Makro", "Autom. Makro" und "Unendlich".

4	 Photosmart Express (Taste) – Die verfügbaren Optionen sind: Drucken, Abzüge online erwerben und "Share" einrichten.
5	 Vorschau/Wiedergabe (Taste) – Dient zum Wechseln zwischen Vorschau und Wiedergabe (siehe „ <i>Vorschau und Wiedergabe</i> “ auf Seite 21).
6	Auslöser.
7	 Video (Taste).
8	Netzkontrollleuchte.
9	ON/OFF (Ein-/Aus-Taste).
10	Befestigung für Halteschlaufe.
11	Zoom -Hebel (digital und optisch) – Drücken Sie im Modus Vorschau auf das Symbol  , um einzuzoomen, oder auf das Symbol  , um auszuzoomen. Drücken Sie im Modus Wiedergabe auf das Symbol  , um das ausgewählte Bild zu vergrößern, oder auf das Symbol  , um Miniaturansichten Ihrer Bilder anzuzeigen.
12	Mode (Modus, Taste) – Drücken Sie auf das Symbol  , um im Modus Vorschau auf das Menü Aufnahmemodus zuzugreifen. Das Menü Aufnahmemodus umfasst folgende Optionen: Autom., Landschaft, Portrait, Theater, Panorama Rechts, Panorama Links, Action, Nachtportrait, Nachtszene, Strand, Schnee, Sonnenuntergang, Dokument.
13	  und   (Tasten) – Dienen zum Blättern durch Menüs und Bilder.
14	 (Menü/OK, Taste) – Dient zum Anzeigen von Kameramenüs, Auswählen von Optionen und Bestätigen von Aktionen.
15	Ladekontrollleuchte.

16	 Löschen (Taste) – Dient zum Zugreifen auf die Funktion Löschen im Modus Wiedergabe .
17	Bildanzeige.

Vorder- und Unterseite der Kamera

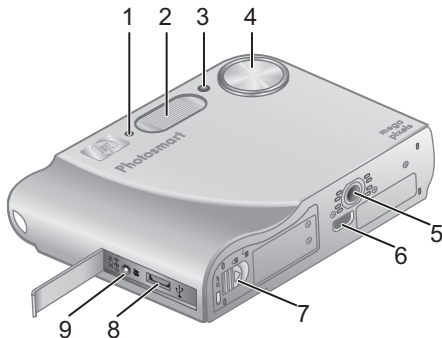

1	Mikrofon
2	Blitz
3	Selbstausröser/Fokus-Hilfslicht
4	Objektiv
5	Stativhalterung
6	Dockinganschluss
7	Klappe des Batterie-/Speicherkartenfachs
8	USB-Anschluss
9	Netzteilanschluss

Dockingeinsatz für die Kamera

Wenn Sie eine optionale HP Photosmart Kamera-Dockingstation erwerben, wird diese mit mehreren leeren Einsätzen geliefert. Verwenden Sie zum

Einrichten der optionalen Dockingstation für diese Kamera, den Dockingeinsatz mit dem runden blauen Etikett. Die zugehörigen Anweisungen finden Sie im Benutzerhandbuch für die Dockingstation.

2 Einrichten Ihrer Kamera

Einsetzen der Batterie

1. Öffnen Sie die Klappe des Batterie-/Speicherkartenfachs, indem Sie die Verriegelung wie auf der Klappe dargestellt verschieben.
2. Setzen Sie die Batterie in das größere Fach ein, und schieben Sie diese hinein, bis die Verriegelung greift.
3. Schließen Sie die Klappe des Batterie-/Speicherkartenfachs.



Hinweis Schalten Sie die Kamera aus, bevor Sie die Batterie herausnehmen. Laden Sie die Batterie vollständig auf, bevor Sie diese zum ersten Mal verwenden.

Aufladen der Batterie

Über das Netzteil können Sie eine in die Kamera eingesetzte Batterie aufladen.



Schließen Sie das Netzteil an der Kamera und anschließend an einer Netzsteckdose an.

Während des Ladevorgangs blinkt die Ladekontrollleuchte der Kamera. Die Batterie ist

vollständig aufgeladen, wenn die Kontrollleuchte permanent leuchtet (nach ungefähr 2 bis 3 Stunden).

Einschalten der Kamera

Drücken Sie zum Einschalten der Kamera die Taste ON/OFF (Ein/Aus).

Auswählen der Sprache

Mit den Tasten ▲▼
◀▶ wählen Sie die gewünschte Sprache aus. Drücken Sie anschließend die Taste $\frac{\text{Menu}}{\text{OK}}$.

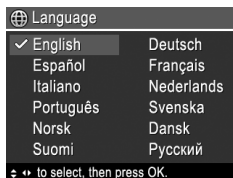

Einstellen der Region

Die Einstellung für die **Sprache** legt zusammen mit der Einstellung für die **Region** die Standardwerte für das Datumsformat und das Format von Videosignalen fest, die beim Anzeigen von Kamerabildern auf einem Fernsehgerät verwendet werden.



Mit den Tasten ▲▼ wählen Sie die gewünschte Region aus. Drücken Sie danach die Taste $\frac{\text{Menu}}{\text{OK}}$.

Deutsch

Einstellen von Datum und Uhrzeit

1. Mit den Tasten ▲▼ passen Sie den jeweils hervorgehobenen Wert an.
2. Mit den Tasten ◀▶ wechseln Sie zu den anderen Auswahlmöglichkeiten. Wiederholen Sie danach Schritt 1, bis das Datum und die Uhrzeit korrekt eingestellt sind.
3. Drücken Sie die Taste Menu / OK , sobald das Datum, die Uhrzeit und die Formateinstellungen korrekt sind. Drücken Sie danach erneut die Taste Menu / OK , um die Einstellungen zu bestätigen.

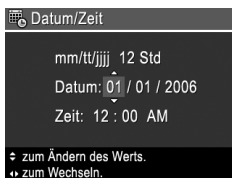











Einsetzen und Formatieren einer optionalen Speicherkarte

Diese Kamera unterstützt Secure Digital (SD) Speicherkarten der Marke HP (Standard und High Speed) mit 8 MB bis hin zu 2 GB.



1. Schalten Sie die Kamera aus, und öffnen Sie die Klappe des Batterie-/Speicherkartenfachs.
2. Setzen Sie die optionale Speicherkarte in das kleinere Fach ein (siehe Abbildung). Stellen Sie sicher, dass die Speicherkarte einrastet.
3. Schließen Sie die Klappe des Batterie-/Speicherkartenfachs, und schalten Sie die Kamera ein.

Sie müssen Speicherkarten immer formatieren, bevor Sie diese zum ersten Mal verwenden.

1. Drücken Sie bei eingeschalteter Kamera die Taste  / , bis sich die Kamera im Modus **Wiedergabe** befindet.
2. Drücken Sie die Taste , um das Untermenü **Löschen** aufzurufen.
3. Wählen Sie mit Hilfe der Tasten   die Option **Speicherk. formatieren** aus. Drücken Sie danach die Taste  .
4. Wählen Sie mit den Tasten   die Option **Ja** aus. Drücken Sie danach die Taste  , um die Speicherkarte zu formatieren.

Wenn eine Speicherkarte eingesetzt ist, werden alle neuen Bilder und Videoclips nicht mehr im internen Speicher, sondern auf der Speicherkarte gespeichert.

Nehmen Sie die Speicherkarte heraus, um den internen Speicher zu verwenden und alle dort gespeicherten Bilder anzuzeigen.

Installieren der Software

Die HP Photosmart-Software umfasst Funktionen zum Übertragen von Bildern und Videoclips auf Ihren Computer sowie zum Ändern gespeicherter Bilder (u. a. Entfernen roter Augen, Drehen, Zuschneiden, Ändern der Größe, Anpassen der Bildqualität sowie Hinzufügen von Farben und Spezialeffekten).

Sollten bei der Installation oder der Verwendung der HP Photosmart-Software Probleme auftreten, lesen Sie die Informationen auf der Website der HP Kundenunterstützung (HP Customer Care):
www.hp.com/support.

Windows

Wenn Ihr Windows Computer die auf der Kameraverpackung genannten Systemvoraussetzungen nicht erfüllt, wird HP Photosmart Essential anstelle der vollständigen Version von HP Photosmart Premier installiert.

1. Schließen Sie alle Programme, und deaktivieren Sie vorübergehend sämtliche Virenschutzsoftware.
2. Legen Sie die HP Photosmart Software CD in das CD-Laufwerk ein, und befolgen Sie die angezeigten Anweisungen. Wenn das Installationsfenster nicht angezeigt wird, klicken Sie auf **Start** und **Ausführen**. Geben Sie dann **D:\Setup.exe** ein (wobei **D** für den Buchstaben Ihres CD-Laufwerks steht). Klicken Sie danach auf **OK**.
3. Nach erfolgreicher Installation der Software müssen Sie die Virenschutzsoftware wieder aktivieren.



Macintosh

1. Legen Sie die HP Photosmart Software CD in das CD-Laufwerk ein.
2. Doppelklicken Sie auf dem Desktop auf das CD-Symbol.
3. Doppelklicken Sie auf das Symbol des Installationsprogramms, und befolgen Sie die angezeigten Anweisungen.

3 Aufnahmen von Bildern und Videoclips

Die **Vorschau** ermöglicht das Erfassen von Motiven für Bilder und Videoclips über die Bildanzeige.



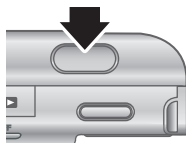

Aufnahmen eines Einzelbilds

1. Drücken Sie die Taste  / , bis das Symbol  für kurze Zeit rechts oben in der Bildanzeige erscheint. Dadurch wird angezeigt, dass sich die Kamera im Modus **Vorschau** befindet.



2. Erfassen Sie das Motiv für Ihr Bild.
3. Drücken Sie den **Auslöser** halb herunter, um Belichtung und Fokus zu sperren. Die Fokusklammern in der Bildanzeige werden grün angezeigt, sobald der Fokus gesperrt ist.
4. Drücken Sie den **Auslöser** ganz herunter, um das Bild aufzunehmen.
5. Wenn Sie einen Audioclip mit einer Länge von bis zu 60 Sekunden hinzufügen möchten, halten Sie den **Auslöser** weiterhin gedrückt. Lassen Sie ihn erst los, wenn die Aufnahme fertig gestellt ist.

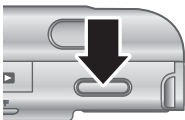



Aufnehmen eines Videoclips

1. Drücken Sie die Taste , bis das Symbol  für kurze Zeit rechts oben in der Bildanzeige erscheint. Dadurch wird angezeigt, dass sich die Kamera im Modus **Vorschau** befindet.
- 
2. Erfassen Sie das Motiv.
 3. Drücken Sie die Taste **Video** , und lassen Sie diese wieder los.
 4. Drücken Sie die Taste **Video** , erneut, und lassen Sie diese wieder los, um die Videoaufnahme zu beenden.

4 Betrachten und Löschen von Bildern und Videoclips







Betrachten von Bildern und Videoclips

Im Modus **Wiedergabe** können Sie Bilder und Videoclips betrachten und mit diesen arbeiten.

1. Drücken Sie die Taste  / , bis das Symbol  für kurze Zeit rechts oben in der Bildanzeige erscheint. Dadurch wird angezeigt, dass sich die Kamera im Modus **Wiedergabe** befindet.
2. Blättern Sie mit den Tasten   durch Ihre Bilder und Videoclips (Videoclips werden automatisch abgespielt).

Löschen eines Bilds

Im Modus **Wiedergabe** können Sie wie folgt Einzelbilder löschen:

1. Drücken Sie die Taste  / , bis das Symbol  für kurze Zeit rechts oben in der Bildanzeige erscheint. Dadurch wird angezeigt, dass sich die Kamera im Modus **Wiedergabe** befindet.
2. Wählen Sie mit den Tasten   ein Bild oder einen Videoclip aus.
3. Drücken Sie die Taste , um das Untermenü **Löschen** aufzurufen.

4. Wählen Sie mit den Tasten ▲▼ die Option **Dieses Bild** aus. Drücken Sie danach die Taste $\frac{\text{Menu}}{\text{OK}}$.

Deutsch

5 Übertragen und Drucken von Bildern

Übertragen von Bildern

Wenn die HP Photosmart-Software installiert ist, verwenden Sie die im Folgenden beschriebene Methode, um Bilder und Videoclips auf Ihren Computer zu übertragen. Wenn die HP Photosmart-Software nicht installiert ist, verwenden Sie eine Alternativmethode, die im elektronischen Benutzerhandbuch beschrieben ist.

Tipp Sie können diese Aufgabe auch mit einer optionalen HP Photosmart-Kamera-Dockingstation erledigen (siehe Benutzerhandbuch zur Dockingstation).

1. Schalten Sie die Kamera aus, und schließen Sie diese mit Hilfe des USB-Kabels, das mit der Kamera geliefert wurde, an den Computer an.
2. Schalten Sie die Kamera ein, und befolgen Sie die auf dem Computermonitor angezeigten Anweisungen, um die Bilder zu übertragen. Weitere Informationen zu diesem Thema finden Sie in der Hilfefunktion der HP Photosmart-Software.

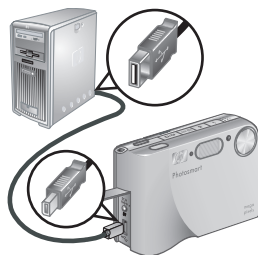

Drucken von Bildern von der Kamera aus

Sie können die Kamera mit einem beliebigen PictBridge-zertifizierten Drucker verbinden, um Einzelbilder und getrennt gespeicherte Bilder eines Videoclips zu drucken.





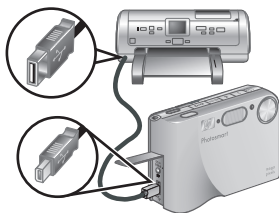



1. Vergewissern Sie sich, dass der Drucker eingeschaltet ist. Darüber hinaus muss Papier im Drucker eingelegt sein, und es dürfen keine Meldungen in Bezug auf Druckerfehler angezeigt werden.
2. Schließen Sie die Kamera mit Hilfe des USB-Kabels, das mit der Kamera geliefert wurde, an den Drucker an.
3. Schalten Sie die Kamera ein.
4. Ist die Kamera mit dem Drucker verbunden, erscheint auf der Bildanzeige der Kamera das Menü **Druckeinrichtung**. Wenn Sie die Einstellungen ändern möchten, wählen Sie mit den Tasten ▲▼ an der Kamera eine Menüoption aus. Ändern Sie dann die jeweilige Einstellung mit den Tasten ◀▶ an der Kamera.
5. Drücken Sie die Taste $\frac{\text{Menu}}{\text{OK}}$, um den Druckvorgang zu starten.



6 Kurzreferenz für Kamerafunktionen

Das folgende Kapitel dient als Kurzreferenz für die Kamerafunktionen. Weitere Informationen zu diesen Kamerafunktionen finden Sie im elektronischen Benutzerhandbuch.





Vorschau und Wiedergabe



- Die **Vorschau** ermöglicht das Erfassen von Motiven für Bilder und Videoclips über die Bildanzeige. Drücken Sie zum Aktivieren der **Vorschau** die Taste  / , bis das Symbol  für kurze Zeit rechts oben in der Bildanzeige erscheint.
- Im Modus **Wiedergabe** können Sie Bilder und Videoclips betrachten und mit diesen arbeiten. Drücken Sie zum Aktivieren der **Wiedergabe** die Taste  / , bis das Symbol  für kurze Zeit rechts oben in der Bildanzeige erscheint.

Menüs



Wenn Sie die Taste ^{Menu}OK im Modus **Wiedergabe** oder im Modus **Vorschau** drücken, werden die Kameramenüs in Form von Registerkarten (siehe Abbildung) aufgerufen.





Wechseln Sie mit den Tasten   zum gewünschten Menü. Innerhalb eines Menüs können Sie mit Hilfe der Tasten   spezifische Optionen auswählen.

Zum Beenden eines Menüs können Sie jederzeit die Taste  /  drücken.

Folgende Menüs und Optionen sind verfügbar:

Menü	Optionen
<p> Das Menü Aufnahme dient zum Anpassen der Kameraeinstellungen, die sich auf die Eigenschaften zukünftiger Bilder und Videoclips auswirken, die Sie mit der Kamera aufnehmen.</p>	<ul style="list-style-type: none">• Aufnahmemodi (Autom., Landschaft, Portrait, Theater, Panorama Rechts, Panorama Links, Action, Nachtportrait, Nachtszene, Strand, Schnee, Sonnenuntergang, Dokument)• Selbstauslöser• Rote Augen entfernen• Belichtungs-kompensation• Adaptive Beleuchtung• Bereich• Bildqualität• Videoqualität• Burst• Weißabgleich• Autofokusbereich• AE-Belichtungsmessung• ISO-Empfindlichkeit• Sättigung• Schärfe• Kontrast• Datums-/Zeitstempel
<p> Das Menü Wiedergabe dient zum Arbeiten mit Bildern, die auf der Kamera gespeichert sind.</p>	<ul style="list-style-type: none">• Bild-Tipp• Bild-Info• Diashow anzeigen• Panorama zusammensetzen

Menü	Optionen
	<ul style="list-style-type: none"> • Audio aufnehmen • Bilder auf Karte verschieben
<p> Das Menü Design-Galerie dient zum Optimieren aufgenommener Bilder.</p>	<ul style="list-style-type: none"> • Kunsteffekte anwenden • Farbe ändern • Ränder hinzufügen • Rote Augen entfernen • Drehen • Zuschneiden
<p> Das Menü Einrichten dient zum Ändern der Funktionsweise der Kamera.</p>	<ul style="list-style-type: none"> • Anzeigehelligkeit • Lautstärke • Fokus-Hilfslicht • Display-Timeout • Direkte Wiedergabe • Digital-Zoom • Datum und Zeit • USB-Konfiguration • TV-Konfiguration • Sprache • Einstellungen zurücksetzen
<p> Die Hilfe enthält Beschreibungen der Kamerafunktionen sowie Tipps zum Aufnehmen von Bildern.</p>	<ul style="list-style-type: none"> • Top Ten-Tipps • Kamerazubehör • Kameratasten • Aufnahmemodi verwenden • Design-Galerie verwenden • Bilder weitergeben • Bilder drucken • Audioclips aufnehmen • Videoclips aufnehmen

Menü	Optionen
	<ul style="list-style-type: none"> • Bilder und Video anzeigen • Bilder aus Video extrahieren • Bilder löschen • Bilder übertragen • Batterie-Management • Unterstützung • Kamera-Kurztasten • Info...

Wenn Sie die Taste  im Modus **Vorschau** oder **Wiedergabe** drücken, wird das Menü **Photosmart Express** angezeigt.

Menü	Optionen
 Photosmart Express dient zum gemeinsamen Nutzen von Fotos mit Freunden und Familienangehörigen.	<ul style="list-style-type: none"> • Drucken • Abzüge online erwerben • Alle Bilder gemeinsam nutzen • Menü "Share" einrichten

Cámara digital
HP Photosmart R725/R727

Español



Información legal y advertencias

© Copyright 2006 Hewlett-Packard Development Company, L.P.

La información que aparece en este documento está sujeta a cambios sin previo aviso. Las únicas garantías de los productos y servicios de HP se detallan en las declaraciones de garantía expresa que acompañan a dichos productos y servicios. Nada de lo que aquí se contenga se considerará como garantía adicional. HP no se hará responsable de los errores u omisiones técnicos o editoriales aquí contenidos.

Windows® es una marca registrada de Microsoft Corporation.



El logotipo SD es una marca comercial de su propietario.



Eliminación de desechos de equipamiento por parte de usuarios en domicilios particulares dentro de la Unión Europea:

Este símbolo en el producto o en su embalaje indica que no debe desecharlo con el resto de la basura de su domicilio. Bajo su responsabilidad, debería deshacerse de los desechos de equipamiento llevándolos a un punto de reciclaje de material eléctrico y equipos electrónicos. La recolección y reciclaje por separado de los desechos de equipamiento ayudará a conservar los recursos naturales y asegurará que se recicle de forma que proteja la salud y el medioambiente. Para más información acerca de dónde puede reciclar estos desechos, póngase en contacto con su ayuntamiento, con el servicio de eliminación de desechos o recogida de basuras, o con la tienda donde adquirió el producto.

Introduzca la siguiente información para referencias futuras:

- Cómo determinar el número de modelo de la cámara (parte frontal de la cámara): _____
- Número de serie (parte inferior de la cámara): _____
- Fecha de compra: _____

Contenido

1	Procedimientos iniciales	4
	Acceder a la Guía del usuario electrónica.....	5
	Cámara, parte superior y posterior	6
	Cámara, parte frontal e inferior.....	8
	Accesorio de la base para la cámara.....	8
2	Instalación de la cámara	10
	Instalación de la pila.....	10
	Carga de la pila.....	10
	Encendido de la cámara.....	11
	Elección del idioma.....	11
	Selección de la región.....	11
	Ajuste de la fecha y la hora.....	11
	Instalación y formateo de una tarjeta de memoria opcional.....	12
	Instale el software.....	13
3	Toma de imágenes y grabación de videoclips	15
	Toma de una imagen fija.....	15
	Grabación de un videoclip.....	16
4	Revisión y eliminación de imágenes y videoclips	17
	Revisión de imágenes y videoclips.....	17
	Eliminación de una imagen.....	17
5	Transferencia e impresión de imágenes	19
	Transferencia de imágenes.....	19
	Impresión de imágenes desde la cámara.....	20
6	Referencia rápida de la cámara	21

1 Procedimientos iniciales

Esta Guía de comienzo rápido proporciona la información necesaria para empezar a utilizar las funciones básicas de su cámara. Si desea información detallada sobre las funciones de la cámara, consulte la Guía del usuario electrónica.

Guía de comienzo rápido	Guía del usuario electrónica
<p data-bbox="203 558 503 608">Esta guía impresa le ayudará a:</p> <ul data-bbox="203 625 503 793" style="list-style-type: none"><li data-bbox="203 625 503 675">● Empezar a utilizar la cámara rápidamente<li data-bbox="203 682 503 732">● Instalar el software HP Photosmart<li data-bbox="203 739 503 793">● Familiarizarse con las funciones de su cámara	<p data-bbox="519 558 715 608">La Guía del usuario electrónica incluye:</p> <ul data-bbox="519 625 821 1179" style="list-style-type: none"><li data-bbox="519 625 821 704">● Descripciones de todas las funciones de la cámara<li data-bbox="519 711 821 789">● Una descripción de los iconos de la Pantalla de imagen<li data-bbox="519 796 821 1032">● Información sobre la pila, como:<ul data-bbox="560 868 821 1032" style="list-style-type: none"><li data-bbox="560 868 821 918">– Prolongación de la duración de la pila<li data-bbox="560 925 821 1032">– Una descripción de los iconos del indicador de alimentación<li data-bbox="519 1039 821 1061">● Resolución de problemas<li data-bbox="519 1068 821 1118">● Obtención de asistencia de HP<li data-bbox="519 1125 821 1179">● Especificaciones de la cámara

Acceder a la Guía del usuario electrónica



La Guía del usuario electrónica está en el disco HP Photosmart Software CD.

Para ver la Guía del usuario:

1. Introduzca el HP Photosmart Software CD en la unidad de CD-ROM del equipo.
2. **En Windows:** Haga clic en **Ver Guía del usuario** en la página principal de la pantalla de instalación.
En Macintosh: Abrir el archivo **Léame** en la carpeta **docs** del CD.

También se guarda en su equipo la Guía del usuario electrónica al instalar el software HP Photosmart. Para ver la Guía del usuario tras instalarla en el equipo.

- **En Windows:** Abra el **Centro de soluciones HP** y haga clic en **Ayuda y asistencia técnica**.
- **En Macintosh:** Abra el **Administrador de dispositivos HP** y seleccione **Guía del usuario** del menú emergente **Información y configuración**.

Obtención de asistencia







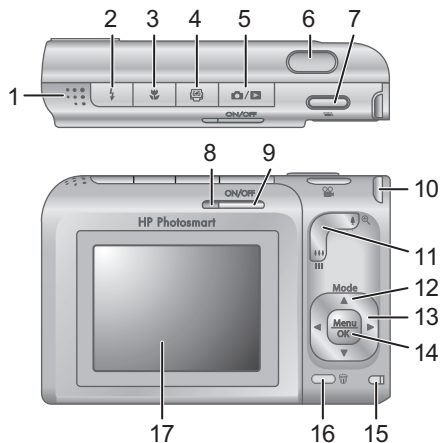







- Si desea sugerencias y herramientas que le ayuden a utilizar la cámara de manera más eficaz, visite **www.hp.com/photosmart** (sólo en inglés) o **www.hp.com**.
- Si desea obtener asistencia para productos, diagnósticos y descargas de controladores 24 horas al día, 7 días a la semana, visite **www.hp.com/support**.

- Para ayuda con el software HP Photosmart, consulte la ayuda en línea para el software HP Photosmart.

Cámara, parte superior y posterior



1	Altavoz.
2	Botón Flash : los ajustes son Automático, Flash encendido, Flash apagado.
3	Botón Enfoque : los ajustes son Normal, Macro, Macro automático e Infinito.
4	Botón Photosmart Express : las opciones son Imprimir, Comprar copias en línea, Conf. Compartir.
5	Botón Vista en directo/Reproducción : Alterna entre Vista en directo y Reproducción (consulte <i>Vista en directo</i> y <i>Reproducción</i> en la página 21).
6	Botón del Disparador .

7	 Botón Vídeo .
8	Indicador luminoso de alimentación.
9	Botón ON/OFF.
10	Soporte para muñequera.
11	Palanca de zoom (digital y óptico): En Vista en directo , pulse  para acercar la imagen o pulse    para alejar la imagen. En Reproducción , pulse el  para ampliar la imagen seleccionada o pulse el  para ver viñetas de sus imágenes.
12	Botón Modo : pulse el  para acceder al menú del Modo de fotografía en la Vista en directo . Las opciones del Modo de fotografía son Auto, Paisaje, Retrato, Teatro, Panorama hacia la derecha, Panorama hacia la izquierda, Acción, Retrato nocturno, Escena nocturna, Playa, Nieve, Puesta de sol, Documento.
13	Botones   y   : para desplazarse entre los menús y las imágenes.
14	Botón  : muestra los menús de la cámara, selecciona opciones y confirma acciones.
15	Indicador luminoso de pila cargando.
16	 Botón Eliminar : accede a la función Eliminar desde el modo Reproducción .
17	Pantalla de imagen.

Cámara, parte frontal e inferior

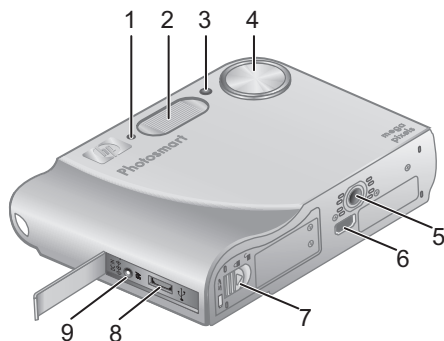

1	Micrófono.
2	Flash.
3	Indicador luminoso Temporizador automático/Ayuda enfoque.
4	Objetivo.
5	Soporte para trípode.
6	Conector de la base de acoplamiento.
7	Puerta de la pila/tarjeta de memoria.
8	Conector USB.
9	Conector del adaptador de alimentación.

Accesorio de la base para la cámara

Si adquiere una base de acoplamiento HP Photosmart opcional, vendrá suministrado con varios adaptadores transparentes. Al instalar la base de acoplamiento para utilizarla con esta cámara, utilice el adaptador de la base

con la etiqueta azul redonda. Para obtener más instrucciones, consulte la Guía del usuario de la base.

Español

2 Instalación de la cámara

Instalación de la pila

1. Abra la tapa de la pila y la tarjeta de memoria deslizando el cierre de la tapa tal y como se indica en la misma.
2. Inserte la pila en la ranura más grande, empujándola hasta que la traba quede enganchada.
3. Cierre la tapa de la pila/tarjeta de memoria.



Nota Apague la cámara antes de retirar la pila. Cargue por completo la pila antes de utilizarla por primera vez.

Carga de la pila

Puede cargar la pila en la cámara con la base de adaptador de CA.

Conecte el adaptador de alimentación de CA a la cámara y enchúfelo a una toma de corriente eléctrica.



Si el indicador luminoso de carga de la pila parpadea, significa que la pila se está cargando; la pila está totalmente cargada cuando el indicador permanece encendido fijamente (aproximadamente 2 y 3 horas).

Encendido de la cámara.

Para encender la cámara, pulse el botón ON/OFF.

Elección del idioma

Utilice ▲▼ y ◀▶ para elegir el idioma que desea y pulse

Menu
OK .

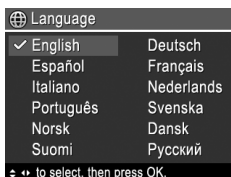

Selección de la región

Los ajustes de **Idioma** y **Región** determinan la configuración predeterminada de la fecha y la hora, y el formato de la señal de vídeo para visualizar las imágenes de la cámara en un televisor.



Utilice ▲▼ para elegir la región que desea y pulse

Menu
OK .

Ajuste de la fecha y la hora

1. Utilice ▲▼ para ajustar el valor seleccionado.
2. Utilice ◀▶ para desplazarse a las otras selecciones y repita el Paso 1 hasta que la fecha y hora sean correctas.

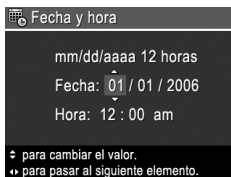

3. Pulse $\frac{\text{Menu}}{\text{OK}}$ cuando la fecha, hora y los ajustes de formato sean correctos y vuelva a pulsar $\frac{\text{Menu}}{\text{OK}}$ para confirmarlo.

Instalación y formateo de una tarjeta de memoria opcional

Esta cámara admite tarjetas de memoria de alta velocidad y estándar, Secure Digital (SD) de marca HP, de 8 MB a 2 GB.



1. Apague la cámara y abra la tapa de la pila/tarjeta de memoria.
2. Inserte la tarjeta de memoria opcional en la ranura más pequeña como se indica. Asegúrese de que encaja en su sitio.
3. Cierre la tapa y encienda la cámara.

Formatee siempre las tarjetas de memoria antes de utilizarlas por primera vez.

1. Con la cámara encendida, pulse / hasta acceder al modo **Reproducción**.
2. Pulse para mostrar el submenú **Eliminar**.
3. Utilice \blacktriangle / \blacktriangledown para seleccionar **Formatear tarjeta**, y pulse $\frac{\text{Menu}}{\text{OK}}$.
4. Utilice \blacktriangle / \blacktriangledown para seleccionar **Sí**, y pulse $\frac{\text{Menu}}{\text{OK}}$ para formatear la tarjeta.

Una vez instalada una tarjeta de memoria, se guardarán todas las imágenes y los videoclips nuevos en esa tarjeta, en lugar de almacenarlos en la memoria interna.

Para utilizar la memoria interna de la cámara y ver las imágenes guardadas en ella, extraiga la tarjeta de memoria.

Instale el software

El software HP Photosmart proporciona funciones para transferir imágenes y videoclips a su equipo, además de funciones para modificar las imágenes almacenadas (eliminar ojos rojos, rotar, recortar, redimensionar, ajustar la calidad de imagen, agregar colores y efectos especiales y más).

Si tiene dificultades para instalar o utilizar el software HP Photosmart, encontrará más información en el sitio Web de Atención al cliente de HP: **www.hp.com/support**.

Windows

Si su equipo Windows no cubre los requisitos del sistema indicados en el embalaje de la cámara, se instala HP Photosmart Essential en lugar de la versión completa de HP Photosmart Premier.

1. Cierre todos los programas y deshabilite temporalmente todo el software de protección contra virus.
2. Inserte HP Photosmart Software CD en la unidad de CD y siga las instrucciones en pantalla. Si no se abre la pantalla de instalación, en el menú **Inicio**, haga clic en **Ejecutar** y escriba **D:\Setup.exe**, donde **D** es la letra de la unidad de CD-ROM y, a continuación, haga clic en **Aceptar**.
3. Cuando se haya instalado el software, vuelva a habilitar el software de protección contra virus.

Macintosh



1. Inserte HP Photosmart Software CD en la unidad de CD.

-
2. Haga doble clic en el icono del CD en el escritorio del equipo.
3. Haga doble clic en el icono del instalador y, a continuación, siga las instrucciones mostradas en la pantalla.



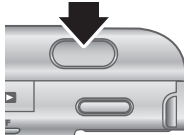

3 Toma de imágenes y grabación de videoclips

Vista en directo permite encuadrar imágenes y videoclips desde la Pantalla de imagen.

Toma de una imagen fija

1. Pulse  /  hasta que aparezca  brevemente en la esquina superior derecha de la Pantalla de imagen. Esto indica que está en el modo **Vista en directo**.
- 
2. Encuadre el sujeto para su imagen.
 3. Presione el botón del **Disparador** hasta la mitad de su recorrido para medir y bloquear el enfoque y la exposición. Los delimitadores de enfoque de la Pantalla de imagen cambian a verde cuando el enfoque está bloqueado.
 4. Presione el botón del **Disparador** hasta el final para tomar la imagen.
 5. Para agregar un clip de audio de hasta 60 segundos, mantenga pulsado el botón del **Disparador** y suéltelo cuando haya acabado.

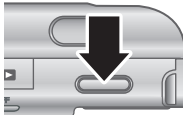



Grabación de un videoclip

1. Pulse  /  hasta que aparezca  brevemente en la esquina superior derecha de la Pantalla de imagen. Esto indica que está en el modo **Vista en directo**.
2. Encuadre el sujeto.
3. Pulse y libere el botón **Vídeo** .
4. Para dejar de grabar vídeo, vuelva a pulsar y liberar el botón **Vídeo** .

4 Revisión y eliminación de imágenes y videoclips







Revisión de imágenes y videoclips

Puede revisar y tratar imágenes y videoclips en el modo **Reproducción**.

1. Pulse  /  hasta que aparezca  brevemente en la esquina superior derecha de la Pantalla de imagen. Esto indica que está en el modo **Reproducción**.
2. Utilice   para desplazarse entre las imágenes o los videoclips (se reproducen los videoclips automáticamente).

Eliminación de una imagen

Puede eliminar imágenes individuales durante la **Reproducción**:

1. Pulse  /  hasta que aparezca  brevemente en la esquina superior derecha de la Pantalla de imagen. Esto indica que está en el modo **Reproducción**.
2. Utilice   para seleccionar una imagen o un videoclip.
3. Pulse  para mostrar el submenú **Eliminar**.

- Utilice ▲▼ para seleccionar **Esta imagen**, y pulse $\frac{\text{Menu}}{\text{OK}}$.

5 Transferencia e impresión de imágenes

Transferencia de imágenes

Si ha instalado el software HP Photosmart, utilice este método para transferir imágenes y videoclips a su equipo. Si no ha instalado el software HP Photosmart, consulte la Guía del usuario electrónica como alternativa.

Sugerencia También puede realizar este proceso utilizando una base de acoplamiento HP Photosmart opcional (consulte la Guía del usuario de la base de acoplamiento).

1. Apague la cámara y conéctela al equipo mediante el cable USB incluido con la cámara.
2. Encienda la cámara y siga las instrucciones en la pantalla del equipo para transferir las imágenes. Para obtener más información, consulte la Ayuda del software HP Photosmart.

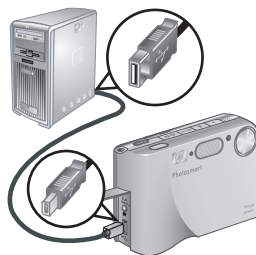

Impresión de imágenes desde la cámara

Puede conectar la cámara a cualquier impresora con certificado PictBridge para imprimir imágenes fijas y fotogramas guardados a partir de un videoclip.





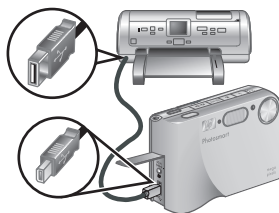



1. Compruebe que la impresora esté encendida, que hay papel y que no hay mensajes de error en la impresora.
2. Conecte la cámara a la impresora mediante el cable USB suministrado con la cámara.
3. Encienda la cámara.
4. Cuando la cámara está conectada a la impresora, aparece el menú **Configurar impresión** en la cámara. Para cambiar los ajustes, utilice ▲▼ de la cámara para seleccionar una opción de menú y utilice ◀▶ de la cámara para cambiar el ajuste.
5. Pulse $\frac{\text{Menu}}{\text{OK}}$ para iniciar la impresión.



6 Referencia rápida de la cámara

Utilice este capítulo como referencia rápida para las funciones de la cámara. Para obtener más información sobre estas funciones de la cámara, consulte la Guía del usuario electrónica.





Vista en directo y Reproducción



- **Vista en directo** permite encuadrar imágenes y videoclips desde la Pantalla de imagen. Para activar **Vista en directo**, pulse  /  hasta que aparezca  brevemente en la esquina superior derecha de la Pantalla de imagen.
- **Reproducción** permite revisar y tratar imágenes y videoclips. Para activar **Reproducción**, pulse  /  hasta que aparezca el icono  brevemente en la esquina superior derecha de la Pantalla de imagen.

Menús

Al pulsar el botón  desde el modo **Reproducción** o **Vista en directo**, accede a los menús de cámara divididos en fichas como se ve en la pantalla de ejemplo.







Utilice   para desplazarse al menú deseado. Dentro de un menú, utilice   para desplazar las selecciones específicas.

Para salir del menú, pulse  /  en cualquier momento.

Los menús y las opciones son:

Menú	Opciones
<p> Captura permiten configurar diversos ajustes que afectan a las características de las imágenes y los videoclips que capture con la cámara.</p>	<ul style="list-style-type: none"> • Modo de fotografía (Auto, Paisaje, Retrato, Teatro, Panorama hacia la derecha, Panorama hacia la izquierda, Acción, Retrato nocturno, Escena nocturna, Playa, Nieve, Puesta de sol, Documento) • Temporizador automático • Elim. de ojos rojos • Compensación de exposición • Ilum. adaptable • Delimitación • Calidad imagen • Calidad de vídeo • Ráfaga • Equilibrio de blanco • Área de enfoque automático • Medición AE • Velocidad ISO • Saturación • Nitidez • Contraste • Estampado de fecha y hora

Menú	Opciones
<p> Reproducción permite trabajar con imágenes que haya guardado en la cámara.</p>	<ul style="list-style-type: none"> • Consejos sobre la imagen • Información de la imagen • Ver presentación • Solapar panorama • Grabar audio • Cómo transferir imágenes a una tarjeta
<p> Galería de diseño permite mejorar las imágenes que ha capturado.</p>	<ul style="list-style-type: none"> • Aplicar efectos artísticos • Modificar el color • Agregar bordes • Eliminación de ojos rojos • Rotar • Recortar
<p> Configuración permite cambiar el comportamiento de la cámara.</p>	<ul style="list-style-type: none"> • Brillo de pantalla • Volumen de sonidos • Luz ayuda enfoque • Mostrar tiempo de espera • Revisión instantánea • Zoom digital • Fecha y hora • Configuración USB • Configuración TV • Idioma • Restablecer ajustes
<p> Ayuda proporciona descripciones de las funciones de la cámara y sugerencias para tomar fotografías.</p>	<ul style="list-style-type: none"> • Diez mejores consejos • Accesorios de la cámara • Botones de la cámara • Uso de modos de fotografía • Uso de la Galería de diseño

Menú	Opciones
	<ul style="list-style-type: none"> ● Publicación de imágenes ● Impresión de imágenes ● Grabación de clips de audio ● Grabación de videoclips ● Revisión imágenes y vídeos ● Extracción de copias del vídeo ● Eliminación de imágenes ● Transferencia de imágenes ● Gestión de las pilas ● Cómo obtener asistencia ● Métodos abreviados cámara ● Acerca de...

Al pulsar  desde **Vista en directo** o **Reproducción**, aparece el **menú Photosmart Express**.

Menú	Opciones
 Photosmart Express permite compartir imágenes con amigos y familiares.	<ul style="list-style-type: none"> ● Imprimir ● Comprar copias en línea ● Compartir toda imagen ● Conf. menú Compartir...

HP Photosmart R725/R727 Digitale camera

Nederlands



Wettelijke kennisgevingen

© Copyright 2006 Hewlett-Packard Development Company, L.P.

De informatie in dit document kan zonder voorafgaande kennisgeving worden gewijzigd. De enige garanties die gelden voor HP producten en diensten zijn de garanties die worden beschreven in de garantievoorwaarden behorende bij deze producten en diensten. Geen enkel onderdeel van dit document mag als extra garantie worden opgevat. HP aanvaardt geen aansprakelijkheid voor technische fouten of redactionele fouten, drukfouten of weglatingen in deze publicatie.

Windows® is een in de V.S. geregistreerd handelsmerk van of Microsoft Corporation.



Het SD-logo is een handelsmerk van de desbetreffende eigenaar.



Het weggooien van apparatuur door gebruikers in privéhuishoudens de Europese Unie

Dit symbool op het product of op de verpakking geeft aan dat dit product niet bij het gewone afval mag worden weggegooid. In plaats hiervan dient u afgedankte apparatuur in te leveren bij een recycling/inzamelingspunt voor elektrische en elektronische apparatuur. De aparte inzameling en recycling van afgedankte apparatuur zorgt ervoor dat de natuurlijke hulpbronnen behouden blijven en dat de apparatuur zonder nadelige invloed op de gezondheid en het milieu voor hergebruik kan worden verwerkt. Neem contact op met de gemeentelijke reinigingsdienst of met de winkel waar u het product hebt aangeschaft voor meer informatie over locaties waar u oude apparatuur kunt achterlaten voor recycling.

Voer de volgende gegevens in als geheugensteun:

- Modelnummer (vóór op de camera): _____
- Serienummer (onder op de camera): _____
- Datum van aanschaf: _____

Inhoudsopgave

1	Aan de slag	4
	De elektronische gebruikershandleiding raadplegen.....	5
	Bovenkant en achterkant van de camera.....	6
	Voor- en onderzijde van de camera.....	8
	Dockinzetstuk van de camera.....	8
2	De camera instellen	10
	De batterij plaatsen.....	10
	De batterij opladen.....	10
	De camera aanzetten.....	11
	De taal kiezen.....	11
	De regio instellen.....	11
	Datum en tijd instellen.....	11
	Een optionele geheugenkaart installeren en formatteren.....	12
	De software installeren.....	13
3	Foto's maken en videoclips opnemen	15
	Een foto nemen.....	15
	Een videoclip opnemen.....	15
4	Foto's en videoclips bekijken en verwijderen	17
	Foto's en videoclips bekijken.....	17
	Een opname verwijderen.....	17
5	Opnames overbrengen en afdrukken	18
	Opnames overbrengen.....	18
	Opnames afdrukken vanaf de camera.....	19
6	Beknopt overzicht van de camera	20

1 Aan de slag

Deze gedrukte introductiegids bevat de informatie die u nodig hebt aan de slag te gaan met de voornaamste functies van uw camera. Zie de elektronische gebruikershandleiding voor gedetailleerde informatie over camerafuncties.

Introductiegids	Elektronische gebruikershandleiding
<p>Aan de hand van deze gedrukte gids kunt u:</p> <ul style="list-style-type: none">• Snel aan de slag gaan met uw camera• De HP Photosmart-software installeren• Kennismaken met de functies van uw camera	<p>De elektronische gebruikershandleiding bevat:</p> <ul style="list-style-type: none">• Beschrijvingen van alle camerafuncties• Een beschrijving van pictogrammen op het LCD-scherm• Batterijgegevens, waaronder:<ul style="list-style-type: none">– De werkingsduur van batterijen verlengen– Een beschrijving van de batterijstatus-indicators• Problemen oplossen• Hulp en ondersteuning van HP• Camerascificaties

De elektronische gebruikershandleiding raadplegen



U vindt de elektronische gebruikershandleiding op de HP Photosmart Software CD.

Zo kunt u de gebruikershandleiding bekijken:

1. Plaats de HP Photosmart Software CD in het cd-rom-station van uw computer.
2. **Windows:** Klik op **Gebruikershandleiding bekijken** op de hoofdpagina van het installatiescherm.
Macintosh: Open het bestand **readme** (leesmij) in de map **docs** op de cd.

De elektronische gebruikershandleiding wordt ook naar uw computer gekopieerd wanneer u de HP Photosmart-software installeert. Zo kunt u de gebruikershandleiding bekijken nadat deze op uw computer is geïnstalleerd:

- **Windows:** Open **HP Solution Center** en klik op **Help en ondersteuning**.
- **Macintosh:** Open **HP Apparaatbeheer** en selecteer **Gebruikershandleiding** in het pop-upmenu **Informatie en instellingen**.

Hulp en ondersteuning







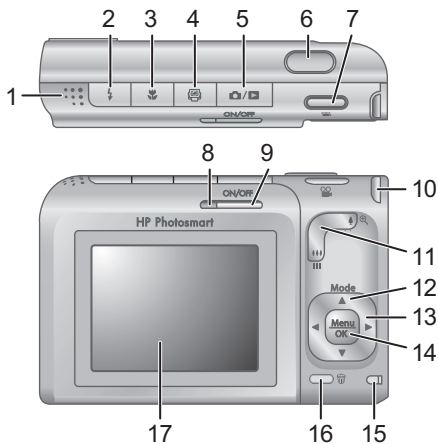

- Bezoek de website **www.hp.com/photosmart** (alleen Engels) of **www.hp.com** voor tips en hulpmiddelen voor een effectiever gebruik van uw camera.

- U kunt te allen tijde terecht op www.hp.com/support voor productassistentie, diagnoseprogramma's en downloadbare stuurprogramma's.
- Zie de online Help-informatie bij de HP Photosmart-software voor hulp bij de HP Photosmart-software.

Bovenkant en achterkant van de camera



1	Luidspreker.
2	Knop Flitser —Instellingen zijn Auto, Flitser Aan, Flitser Uit.
3	Knop Focus —Instellingen zijn Normaal, Macro, Automacro, Oneindig.
4	Knop Photosmart Express —Opties zijn Afdrukken, Afdrukken online kopen, Delen instellen.

5	Knop  /  Liveweergave/Weergave —Voor schakelen tussen Liveweergave en Weergave (zie <i>Liveweergave en Weergave</i> op pagina 20).
6	Sluiterknop.
7	Knop  Video.
8	Aan/uit-lampje.
9	Knop ON/OFF.
10	Bevestigingspunt voor polsbandje.
11	Knop In-/uitzoomen (digitaal en optisch)—In Liveweergave drukt u op  om in te zoomen of op  om uit te zoomen. In Weergave drukt u op  om de geselecteerde opname te vergroten of op  om de opnames op miniatuurformaat weer te geven.
12	Knop Mode —Druk op  om het menu Opnamemodus te openen wanneer Liveweergave actief is. Opties voor Opnamemodus zijn Modus Auto, Landschap, Portret, Theater, Panorama Rechts, Panorama Links, Actie, Nachtportret, Nachtafereel, Strand, Sneeuw, Zonsondergang, Document.
13	Knoppen   en   —Voor het bladeren door menu's en opnames.
14	Knop  —Voor het weergeven van cameramenu's, het selecteren van opties en het bevestigen van keuzen.
15	Batterijplaadindicator.
16	Knop  Verwijderen —Voor de functie Verwijderen in Weergave .
17	LCD-scherm.

Voor- en onderzijde van de camera

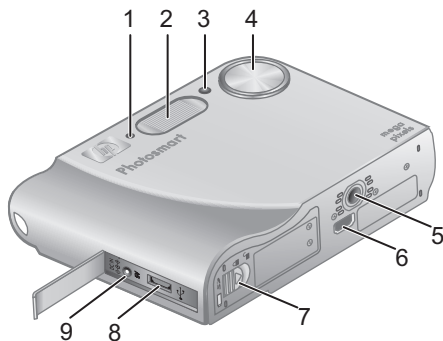

1	Microfoon.
2	Flitser.
3	Lampje van zelfontspanner/focushulp.
4	Lens.
5	Bevestigingspunt voor statief.
6	Aansluiting voor dock.
7	Klepje van vak voor batterij/geheugenkaart.
8	USB-aansluiting.
9	Aansluiting voor netadapter.

Dockinzetstuk van de camera

Als u een optioneel HP Photosmart cameradock aanschaft, wordt dit geleverd samen met enkele lichtgekleurde inzetstukken. Wanneer u het dock gereedmaakt voor gebruik met deze camera, kunt u het dockinzetstuk met het ronde blauwe merkteken

gebruiken. Zie de gebruikershandleiding van het dock voor instructies.

Nederlands

2 De camera instellen

De batterij plaatsen

1. Open het vak voor de batterij/ geheugenkaart door de vergrendeling ervan te verschuiven zoals op het klepje wordt aangegeven.
2. Plaats de batterij in de grootste sleuf en duw de batterij naar binnen totdat het ontgrendelingspalletje op zijn plaats klikt.
3. Sluit het vak voor de batterij/geheugenkaart.



Opmerking Zet de camera uit voordat u de batterij verwijdert. Laad de batterij volledig op voordat u deze voor het eerst gebruikt.

De batterij opladen

U kunt de batterij in de camera opladen met de netvoedingsadapter.

Sluit de netvoedingsadapter op de camera en vervolgens op een stopcontact aan.



De batterijoplaadindicator van de camera knippert, hetgeen aangeeft dat de batterij wordt opgeladen. De batterij is volledig opgeladen wanneer het lampje continu blijft branden (na 2 tot 3 uur).

De camera aanzetten

Zet de camera aan door op de knop ON/OFF te drukken.

De taal kiezen

Kies de gewenste taal met ▲▼ ◀▶ en druk op $\frac{\text{Menu}}{\text{OK}}$.

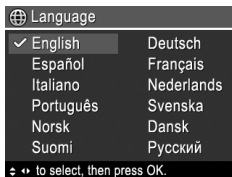

De regio instellen

Met de instellingen **Taal** en **Regio** bepaalt u de standaard datumnotatie en de indeling van het videosignaal voor het weergegeven van cameraopnames op een televisie.



Kies de gewenste regio met ▲▼ en druk op $\frac{\text{Menu}}{\text{OK}}$.

Datum en tijd instellen

1. Pas de gemarkeerde waarde aan met ▲▼.
2. Ga naar de andere selecties met ◀▶ en herhaal stap 1 totdat de datum en tijd correct zijn ingesteld.



3. Druk op $\frac{\text{Menu}}{\text{OK}}$ wanneer de instellingen voor datum, tijd en indeling correct zijn. Druk vervolgens nogmaals op $\frac{\text{Menu}}{\text{OK}}$ om de keuze te bevestigen.

Een optionele geheugenkaart installeren en formatteren

De camera ondersteunt SD-geheugenkaarten (Secure Digital) van HP, standaard en hoge snelheid, van 8 MB tot 2 GB.



1. Zet de camera uit en open het vak voor de batterij/geheugenkaart.
2. Plaats de optionele geheugenkaart in de kleinste sleuf zoals in de illustratie. Zorg ervoor dat de geheugenkaart vastklikt.
3. Sluit het vak voor de batterij/geheugenkaart en zet de camera aan.

Formateer geheugenkaarten altijd alvorens deze voor het eerst te gebruiken.

1. Zet de camera aan en druk op / totdat de modus **Weergave** actief is.
2. Druk op om het submenu **Verwijderen** weer te geven.
3. Selecteer met \blacktriangle / \blacktriangledown de optie **Kaart formatteren** en druk op $\frac{\text{Menu}}{\text{OK}}$.
4. Selecteer met \blacktriangle / \blacktriangledown de optie **Ja** en druk op $\frac{\text{Menu}}{\text{OK}}$ om de kaart te formatteren.

Wanneer u een geheugenkaart hebt geïnstalleerd, worden alle nieuwe foto's en videoclips op de kaart opgeslagen in plaats van in het interne geheugen.

Als u het interne geheugen wilt gebruiken en opnames wilt weergeven die in het geheugen zijn opgeslagen, verwijdert u de geheugenkaart.

De software installeren

De HP Photosmart-software bevat functies voor het overbrengen van foto's en videoclippen naar de computer en functies voor het wijzigen van opgeslagen opnames (onder meer rode ogen verwijderen, draaien, bijsnijden, formaat wijzigen, opnamekwaliteit wijzigen, en kleuren en speciale effecten toevoegen).

Als u bij het installeren of gebruiken van de HP Photosmart-software problemen ondervindt, kunt u voor meer informatie terecht op de website voor klantenondersteuning van HP: www.hp.com/support.

Windows

Als uw Windows-computer niet voldoet aan de systeemvereisten die op de verpakking van de camera worden vermeld, wordt HP Photosmart Essential geïnstalleerd in plaats van de volledige versie HP Photosmart Premier.

1. Sluit alle programma's en schakel eventuele antivirussoftware tijdelijk uit.
2. Plaats de HP Photosmart Software CD in het cd-rom-station en volg de aanwijzingen op het scherm. Als het installatievenster niet verschijnt, doet u het volgende: klik op **Start** en op **Uitvoeren**, typ **D:\Setup.exe**, waarbij **D** staat voor de letter van het cd-rom-station, en klik op **OK**.
3. Wanneer de installatie van de software is voltooid, schakelt u de antivirussoftware weer in.



Macintosh

1. Plaats de HP Photosmart Software CD in het cd-rom-station.
2. Dubbelklik op het pictogram van het cd-rom-station op het bureaublad van de computer.
3. Dubbelklik op het pictogram van het installatieprogramma volg de aanwijzingen op het scherm.



3 Foto's maken en videoclips opnemen

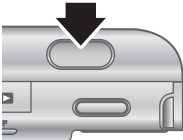

In de modus **Liveweergave** kunt u foto's en videoclips op het LCD-scherm inkaderen.

Een foto nemen

1. Druk op  /  totdat rechtsboven in de hoek van het LCD-scherm kort  wordt weergegeven. Dit geeft aan dat **Liveweergave** actief is.
- 
2. Kader het onderwerp voor de foto in.
 3. Druk de **sluiterknop** half in om de focus en belichting te meten en te vergrendelen. Het scherpstellingskader op het LCD-scherm wordt groen als de brandpuntafstand is vergrendeld.
 4. Druk de **sluiterknop** helemaal in om de foto te maken.
 5. Als u een audioclip (maximaal 60 seconden) wilt opnemen, houdt u de **sluiterknop** ingedrukt en laat u deze los om de opname te beëindigen.

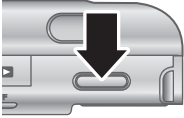
Een videoclip opnemen

1. Druk op  /  totdat rechtsboven in de hoek van het LCD-scherm kort  wordt weergegeven. Dit geeft aan dat **Liveweergave** actief is.
- 
2. Kader het onderwerp in.

3. Druk de knop **Video**  in en laat deze los.
4. U stopt de opname van de video door de knop **Video**  nogmaals in te drukken en los te laten.

Nederlands

4 Foto's en videoclips bekijken en verwijderen











Foto's en videoclips bekijken

U kunt foto's en videoclips bekijken en bewerken in de modus **Weergave**.

1. Druk op  /  totdat rechtsboven in de hoek van het LCD-scherm kort  wordt weergegeven. Dit geeft aan dat **Weergave** actief is.
2. Blader met   door uw foto's en videoclips (videoclips worden automatisch afgespeeld).

Een opname verwijderen

U kunt afzonderlijke opnames verwijderen in **Weergave**:

1. Druk op  /  totdat rechtsboven in de hoek van het LCD-scherm kort  wordt weergegeven. Dit geeft aan dat **Weergave** actief is.
2. Selecteer met   een foto of videoclip.
3. Druk op  om het submenu **Verwijderen** weer te geven.
4. Selecteer met   de optie **Deze opname** en druk op  .

5 Opnames overbrengen en afdrukken

Opnames overbrengen

Als u de HP Photosmart-software hebt geïnstalleerd, kunt met deze methode foto's en videoclips naar uw computer overbrengen. Als u de HP Photosmart-software niet hebt geïnstalleerd, kunt u in de elektronische gebruikershandleiding een andere methode vinden.

Tip U kunt deze taak ook uitvoeren met een optioneel HP Photosmart cameradock (zie de gebruikershandleiding van het dock).

1. Zet de camera uit en sluit de camera en de computer op elkaar aan met de bij de camera geleverde USB-kabel.
2. Zet de camera aan en volg de aanwijzingen op het computerscherm om de opnames over te brengen. Zie de Help-functie van de HP Photosmart-software voor meer informatie.

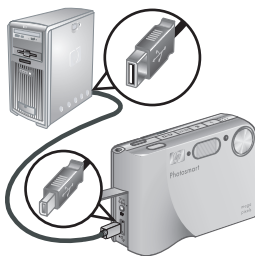

Opnames afdrukken vanaf de camera

U kunt de camera aansluiten op een willekeurige PictBridge-compatibele printer, waarmee u vervolgens foto's en frames uit een videoclip kunt afdrukken.





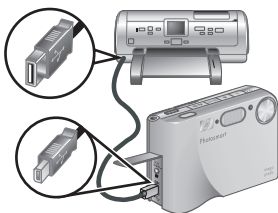

1. Controleer of de printer aan staat, of er papier in de printer is geplaatst en of er geen foutmelding op de printer wordt weergegeven.
2. Sluit de camera en de printer op elkaar aan met de bij de camera geleverde USB-kabel.
3. Zet de camera aan.
4. Wanneer de camera op de printer is aangesloten, wordt het menu **Afdrukinstellingen** op de camera weergegeven. Als u de instellingen wilt wijzigen, selecteert u op de camera een menuoptie met ▲▼ en wijzigt u vervolgens de instelling met ◀▶.
5. Druk op $\frac{\text{Menu}}{\text{OK}}$ om het afdrukken te starten.



6 Beknopt overzicht van de camera

In dit hoofdstuk kunt u in één oogopslag zien welke mogelijkheden u met de camera hebt. Meer informatie over deze functies vindt u in de elektronische gebruikershandleiding.





Liveweergave en Weergave



- In de modus **Liveweergave** kunt u foto's en videoclips op het LCD-scherm inkaderen. Als u **Liveweergave** wilt activeren, drukt u op  /  totdat in de hoek rechtsboven van het LCD-scherm kort  wordt weergegeven.
- In de modus **Weergave** kunt u foto's en videoclips bekijken en bewerken. Als u **Weergave** wilt activeren, drukt u op  /  totdat in de hoek rechtsboven van het LCD-scherm kort  wordt weergegeven.

Menu's

Wanneer u op  Menu / OK drukt in **Weergave** of **Liveweergave**, opent u de cameramenu's die over verschillende tabbladen zijn verdeeld, zoals te zien in het voorbeeldscherm.



Met   gaat u naar het gewenste menu. In een menu kunt u met   naar een bepaalde optie gaan.

U kunt het menu op elk moment afsluiten door op  /  te drukken.

Menu's en bijbehorende opties:

Menu	Opties
Met  Opname kunt u camera-instellingen wijzigen die van invloed zijn op de kenmerken van foto's en videoclips die u in het vervolg met de camera maakt.	<ul style="list-style-type: none">• Opmemodi (Modus Auto, Landschap, Portret, Theater, Panorama Rechts, Panorama Links, Actie, Nachtportret, Nachtafereel, Strand, Sneeuw, Zonsondergang, Document)• Zelfontspanner• Rode-ogenverwijdering• Belichtingscompensatie• Adaptieve belichting• Bracketing• Fotokwaliteit• Videokwaliteit• Burst• Witbalans• Autofocusgebied• AE-meting• ISO-snelheid• Verzadiging• Scherpste• Contrast• Datum & tijd toevoegen
Met  Weergave kunt u werken met in de camera opgeslagen opnames.	<ul style="list-style-type: none">• Fotoadvies• Fotogegevens• Diavoorstelling weergeven• Panorama samenvoegen

Menu	Opties
	<ul style="list-style-type: none"> ● Geluid opnemen ● Opnames naar kaart
<p>Met  Ontwerpgalerie kunt u bewerkingen op uw opnames uitvoeren.</p>	<ul style="list-style-type: none"> ● Artistieke effecten toepassen ● Kleur wijzigen ● Randen toevoegen ● Rode ogen verwijderen ● Draaien ● Bijsnijden
<p>Met  Instellen kunt u de werking van de camera wijzigen.</p>	<ul style="list-style-type: none"> ● Schermhelderheid ● Geluidsvolume ● Focushulplampje ● Time-out scherm ● Meteen bekijken ● Digitaal zoomen ● Datum & tijd ● USB-configuratie ● Tv-configuratie ● Taal ● Beginwaarden herstellen
<p>Op  Help vindt u beschrijvingen van functies en tips voor het gebruik van de camera.</p>	<ul style="list-style-type: none"> ● Toptien handigste tips ● Camera-accessoires ● Cameraknoppen ● Opnamemodi gebruiken ● Ontwerpgalerie gebruiken ● Opnames delen ● Foto's afdrukken ● Audioclips opnemen ● Videoclips opnemen ● Foto's en video bekijken

Menu	Opties
	<ul style="list-style-type: none"> ● Afdrukken uit video extraheren ● Opnames verwijderen ● Opnames overbrengen ● Batterijbeheer ● Hulp en ondersteuning ● Camerasneltoetsen ● Info...

Als u op  drukt in de modus **Liveweergave** of **Weergave**, ziet u het **Menu Photosmart Express**.

Menu	Opties
Met  Photosmart Express kunt uw foto's delen met familie en vrienden.	<ul style="list-style-type: none"> ● Afdrukken ● Afdrukken online kopen ● Alle opnames delen ● Menu Delen instellen

Nederlands

Câmera digital

HP Photosmart R725/R727

Português



Informações legais e avisos

© Copyright 2006 Hewlett-Packard Development Company, L.P.

As informações aqui contidas estão sujeitas a alterações sem aviso prévio. As únicas garantias para produtos e serviços da HP são as estabelecidas nas declarações de garantia expressa que acompanham tais produtos e serviços. Nenhuma informação aqui contida pode ser considerada como uma garantia adicional. A HP se isenta de responsabilidade por erros técnicos ou editoriais ou omissões aqui contidas.

Windows® é uma marca registrada da Microsoft Corporation nos Estados Unidos.



O logotipo SD é uma marca comercial de seu proprietário.



Descarte de equipamento residencial na União Européia

Este símbolo no produto ou na embalagem indica que ele não deve ser descartado juntamente com os demais lixos domésticos. É de sua responsabilidade o descarte do equipamento, levando-o a um local de coleta designado para a reciclagem de equipamentos elétricos e eletrônicos usados. A coleta e a reciclagem apropriadas de seu equipamento usado no momento do descarte ajudarão a conservar os recursos naturais e a garantir que a reciclagem se dará de maneira a proteger a saúde humana e o ambiente. Para mais informações sobre onde deixar seu equipamento para reciclagem, por favor, dirija-se à administração municipal, ao serviço de coleta de lixo ou à loja onde você adquiriu o produto.

Para referência futura, preencha as seguintes informações:

- Número do modelo (na frente da câmera): _____
- Número de série (na parte inferior da câmera): _____
- Data de aquisição: _____

Conteúdo

1	Primeiros passos	4
	Acessar a versão eletrônica do Guia do	
	Usuário.....	5
	Partes superior e traseira da câmera	6
	Partes frontal e inferior da câmera.....	8
	Suporte da estação de acoplamento da	
	câmera.....	8
2	Preparar a câmera	10
	Instalar a bateria.....	10
	Carregar a bateria.....	10
	Ligue a câmera.....	11
	Escolher o idioma.....	11
	Definir a região.....	11
	Configurar data e hora.....	11
	Instalar e formatar cartão de memória	
	opcional.....	12
	Instalar o software.....	13
3	Tirar fotos e gravar clipes de vídeo	15
	Tirar uma foto estática.....	15
	Gravar um clipe de vídeo.....	15
4	Rever e excluir imagens e clipes de vídeo	
	17
	Rever imagens e clipes de vídeo.....	17
	Excluir uma imagem.....	17
5	Transferir e imprimir imagens	18
	Transferir imagens.....	18
	Imprimir imagens diretamente da câmera.....	19
6	Referência rápida da câmera	20

1 Primeiros passos

Este Guia de Início Rápido fornece as informações de que você precisa para começar a usufruir dos principais recursos da câmera. Para obter informações detalhadas sobre os recursos da câmera, consulte a versão eletrônica do Guia do Usuário.

Guia de Início Rápido	Versão eletrônica do Guia do Usuário
<p>Este guia impresso irá ajudá-lo a:</p> <ul style="list-style-type: none">• Iniciar rapidamente o uso da câmera• Instalar o software HP Photosmart• Conhecer os recursos da câmera	<p>O Guia do Usuário eletrônico inclui:</p> <ul style="list-style-type: none">• Descrições de todos os recursos da câmera• Uma descrição dos ícones do Visor de imagens• Informações sobre baterias, incluindo:<ul style="list-style-type: none">– Como prolongar a vida das baterias– Uma descrição dos ícones indicadores de alimentação• Solução de problemas• Com obter assistência da HP• Especificações da câmera

Acessar a versão eletrônica do Guia do Usuário



A versão eletrônica do Guia do Usuário está no HP Photosmart Software CD.

Para visualizar o Guia do Usuário:

1. Insira o HP Photosmart Software CD na unidade de CD do computador.
2. **Em ambiente Windows:** Clique em **Ver o Guia do Usuário** na página principal da tela de instalação.
No Macintosh: Abra o arquivo **leiam** na pasta **docs** no CD.

A versão eletrônica do Guia do Usuário também é copiada para o computador, ao se instalar o software HP Photosmart. Para visualizar o Guia do Usuário após ele ter sido instalado no computador:

- **Em ambiente Windows:** Abra a **Central de Soluções HP** e clique em **Ajuda e suporte**.
- **No Macintosh:** Abra o **Gerenciador de dispositivos HP** e selecione **Guia do Usuário** no menu instantâneo **Informações e configurações**.







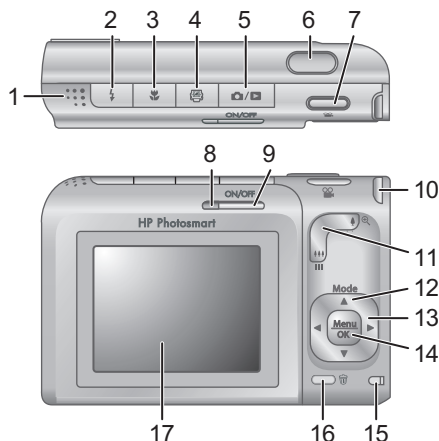

Obter assistência

- Para obter dicas e ferramentas que o ajudem a utilizar a câmera de maneira mais eficiente, visite **www.hp.com/photosmart** (somente em inglês) ou **www.hp.com**.
- Para ajuda com seu produto, diagnósticos e download de drivers 24 horas por dia, visite **www.hp.com/support**.
- Para ajuda com o software HP Photosmart, consulte a ajuda online do software HP Photosmart.

Partes superior e traseira da câmera



1	Alto-falante
2	Botão Flash — As configurações são Automático, Flash ligado e Flash desligado.
3	Botão Foco — As configurações são Normal, Macro, Macro automático e Infinito.
4	Botão Photosmart Express — As opções são: Imprimir, Encomendar impressões online e Config. Compartilhar.
5	Botão Exibição ao vivo/Reproduzir — Muda entre Exibição ao vivo e Reproduzir (veja <i>Exibição ao vivo</i> e <i>Reproduzir</i> na página 20).
6	Botão Obturador .
7	Botão Vídeo .
8	Luz de alimentação

9	Botão ON/OFF.
10	Suporte da fita de pulso
11	Controle do Zoom (Digital e Óptico) — Em Exibição ao vivo , pressione  para aumentar o zoom ou pressione  para diminuir o zoom. Em Reproduzir , pressione  para ampliar a imagem selecionada, ou pressione  para visualizar miniaturas de suas imagens.
12	Botão Mode (Modo) — Pressione  para acessar o menu Modo Fotografia enquanto estiver em Exibição ao vivo . As opções de Modo Fotografia são: Modo Automático, Paisagem, Retrato, Teatro, Panorama direita, Panorama esquerda, Ação, Retrato noturno, Cena noturna, Praia, Neve, Pôr-do-sol, Documento.
13	 e  — Rolam por menus e imagens.
14	 — Exibe menus da câmera, seleciona opções e confirma ações.
15	Luz de carregamento das baterias
16	 Botão Excluir — Acessa a função Excluir estando em Reproduzir .
17	Visor de imagens

Partes frontal e inferior da câmera

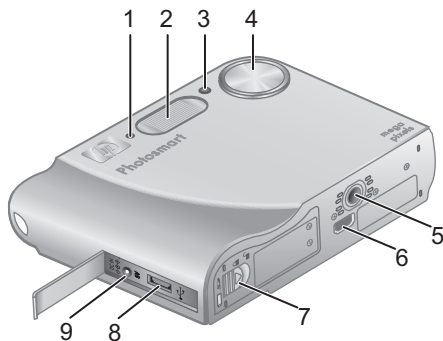

1	Microfone
2	Flash
3	Timer interno/luz auxiliar de foco
4	Lente
5	Encaixe para tripé
6	Conector da estação de acoplamento
7	Porta da bateria/cartão de memória
8	Conector USB
9	Conector do adaptador de alimentação

Suporte da estação de acoplamento da câmera

Se você comprar uma estação de acoplamento opcional HP Photosmart, ela virá com vários suportes transparentes. Ao instalar a estação de acoplamento para uso com esta câmera, use o suporte da estação de acoplamento com a etiqueta redonda azul. Consulte o

Guia do Usuário da estação de acoplamento para obter instruções.

Português

2 Preparar a câmera

Instalar a bateria

1. Abra a porta da bateria/cartão de memória, deslizando-a conforme indicado na porta.
2. Insira a bateria no slot maior, empurrando-a até que se encaixe.
3. Feche a porta da bateria/cartão de memória.



Nota Desligue a câmera antes de remover a bateria. Carregue completamente a bateria antes de utilizá-la pela primeira vez.

Carregar a bateria

Você pode carregar a bateria dentro da câmera, utilizando o adaptador AC.

Conecte o adaptador de alimentação AC à câmera e, em seguida, ligue-o a uma tomada elétrica.



A luz piscante de carregamento de bateria da câmera indica que a bateria está sendo carregada; a bateria estará totalmente carregada quando a luz parar de piscar e ficar constantemente acesa (de duas a três horas).

Ligue a câmera

Para ligar a câmera, pressione o botão ON/OFF (liga/desliga).

Escolher o idioma

Use ▲▼ ◀▶ para escolher o idioma desejado e, a seguir, pressione $\frac{\text{Menu}}{\text{OK}}$.

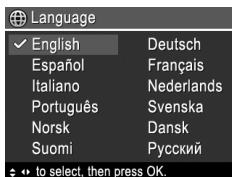

Definir a região

Juntamente com a configuração **Idioma**, a configuração **Região** determina o formato padrão de data e o formato de sinal de vídeo para exibir imagens da câmera em uma televisão.

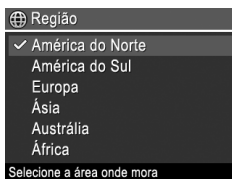

Use ▲▼ para escolher a região desejada; a seguir, pressione $\frac{\text{Menu}}{\text{OK}}$.

Configurar data e hora

1. Use ▲▼ para ajustar o valor realçado.
2. Use ◀▶ para ir para outras seleções e repita a Etapa 1 até que a data e a hora estejam configuradas corretamente.

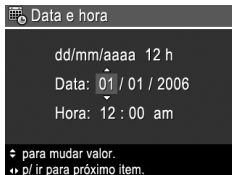

3. Pressione ^{Menu}/_{OK} quando as configurações de data, hora e formato estiverem corretas e pressione ^{Menu}/_{OK} novamente para confirmar.

Instalar e formatar cartão de memória opcional

Essa câmera é compatível com cartões de memória padrão e de alta velocidade Secure Digital (SD) de 8 MB até 2 GB.



1. Desligue a câmera e abra a porta da bateria/cartão de memória.
2. Insira o cartão de memória opcional no slot menor, como demonstrado. Verifique se o cartão de memória está encaixado.
3. Feche a porta da bateria/cartão de memória e ligue a câmera.

Sempre formate os cartões de memória antes do primeiro uso.

1. Com a câmera ligada, pressione / até entrar em **Reproduzir**.
2. Pressione para exibir o submenu **Excluir**.
3. Use para selecionar **Formatar cartão** e pressione ^{Menu}/_{OK}.
4. Use para selecionar **Sim** e pressione ^{Menu}/_{OK} para formatar o cartão.

Uma vez instalado um cartão de memória, todas as novas imagens e clipes de vídeo serão armazenados no cartão e não na memória interna.

Para utilizar a memória interna e visualizar imagens nela armazenadas, remova o cartão de memória.

Instalar o software

O software HP Photosmart oferece recursos para transferir imagens e clipes de vídeo para o computador, assim como para modificar imagens armazenadas (corrigir olhos vermelhos, girar, cortar, redimensionar, ajustar qualidade da imagem, adicionar cores e efeitos especiais, entre outros).

Se você tiver problemas para instalar ou usar o software HP Photosmart, consulte o site de Suporte ao Cliente HP para obter mais informações. www.hp.com/support.

Windows

Se a versão do Windows no computador não cumprir os requisitos mínimos de sistema declarados na embalagem da câmera, o HP Photosmart Essencial será instalado em lugar da versão completa do HP Photosmart Premier.

1. Feche todos os programas e desabilite, temporariamente, qualquer software antivírus.
2. Insira o HP Photosmart Software CD na unidade de CD e siga as instruções da tela. Se a janela de instalação não for exibida, clique em **Iniciar**, a seguir, em **Executar**, digite **D:\Setup.exe**, em que **D** é a letra da unidade de CD, e clique em **OK**.
3. Quando a instalação do software for concluída, reabilite o software antivírus.

Macintosh



1. Insira o HP Photosmart Software CD na unidade de CD.

2. Na área de trabalho do computador, clique duas vezes no ícone do CD.
3. Clique duas vezes no ícone do instalador e siga as instruções da tela.

3 Tirar fotos e gravar clipes de vídeo



A **Exibição ao vivo** permite enquadrar fotos e clipes de vídeo no Visor de imagens.

Tirar uma foto estática

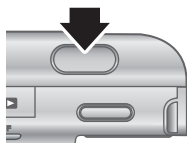

1. Pressione  /  até que  seja exibido no canto superior direito do Visor. Isso indica que a câmera está na **Exibição ao vivo**.
2. Enquadre o objeto/pessoa para sua foto.
3. Pressione o botão **Obturador** até a metade para medir e travar o foco e a exposição. Os colchetes do foco no Visor de imagens ficarão verdes quando o foco estiver travado.
4. Pressione o botão **Obturador** até o fim para tirar a foto.
5. Para adicionar um clipe de áudio de até 60 segundos, continue apertando o botão **Obturador** para baixo, soltando-o quando tiver concluído.

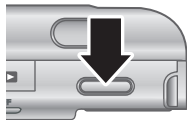

Gravar um clipe de vídeo

1. Pressione  /  até que  seja exibido no canto superior direito do Visor. Isso indica que a câmera está na **Exibição ao vivo**.
2. Enquadre o objeto/pessoa.







3. Pressione e solte o botão **Vídeo** .
4. Para interromper a gravação do vídeo, pressione e solte o botão **Vídeo**  novamente.

4 Rever e excluir imagens e clipes de vídeo











Rever imagens e clipes de vídeo

Você pode rever e trabalhar com imagens e clipes de vídeo em **Reproduzir**.

1. Pressione  /  até que  seja exibido no canto superior direito do Visor de imagens. Isso indica que você está em **Reproduzir**.
2. Use   para percorrer as imagens e clipes de vídeo (os clipes de vídeo são exibidos automaticamente).

Excluir uma imagem

Você pode excluir imagens individuais enquanto estiver em **Reproduzir**:

1. Pressione  /  até que  seja exibido no canto superior direito do Visor de imagens. Isso indica que você está em **Reproduzir**.
2. Use   para selecionar uma imagem ou clipe de vídeo.
3. Pressione  para exibir o submenu **Excluir**.
4. Use   para selecionar **Esta Imagem** e pressione  .

5 Transferir e imprimir imagens

Transferir imagens

Se você tiver instalado o software HP Photosmart, use este método para transferir imagens e clipes de vídeo para o computador. Se você não tiver instalado o software HP Photosmart, consulte a versão eletrônica do Guia do Usuário, para um método alternativo.

Dica Também é possível realizar essa tarefa usando uma estação de acoplamento opcional HP Photosmart (veja o Guia do Usuário da estação de acoplamento).

1. Desligue a câmera e conecte-a ao computador, usando o cabo USB que a acompanha.
2. Ligue a câmera e siga as instruções da tela do computador para transferir as imagens.

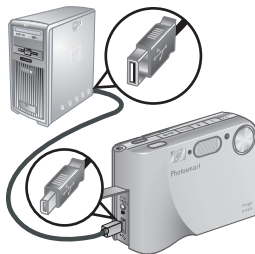

Para obter mais informações, consulte o recurso Ajuda do software HP Photosmart.

Imprimir imagens diretamente da câmera

Você pode conectar a câmera a qualquer impressora compatível com PictBridge para imprimir imagens estáticas e quadros salvos a partir de um clipe de vídeo.



1. Verifique se a impressora está ligada, se há papel e se não há mensagens de erro da impressora.
2. Conecte a câmera e a impressora, utilizando o cabo USB que acompanha a câmera.
3. Ligue a câmera.
4. Quando a câmera estiver conectada à impressora, o **Menu Configurar impressão** será exibido na câmera. Para alterar as configurações, use ▲▼ na câmera para selecionar uma opção do menu e, a seguir, use os ◀▶ na câmera para alterar a configuração.
5. Pressione $\frac{\text{Menu}}{\text{OK}}$ para iniciar a impressão.

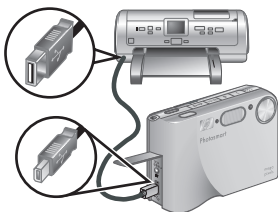

6 Referência rápida da câmera

Use este capítulo como uma referência rápida aos recursos da câmera. Para aprender mais sobre esses recursos da câmera, consulte o Guia do Usuário eletrônico.

Exibição ao vivo e Reproduzir

- A **Exibição ao vivo** permite enquadrar fotos e cliques de vídeo no Visor de imagens. Para ativar a **Exibição ao vivo**, pressione / até que seja exibido no canto superior direito do Visor de imagens.
- **Reproduzir** permite rever e trabalhar com imagens e cliques de vídeo. Para ativar **Reproduzir**, pressione / até que o seja exibido no canto superior direito do Visor de imagens.

Menus



Quando você pressiona o em **Reproduzir** ou em **Exibição ao vivo**, você acessa os menus da câmera, como demonstrado na tela de exemplo.





Use para ir até o menu desejado. Dentro de um menu, use para ir até as seleções específicas.

Para sair do menu, pressione / a qualquer hora.

Os menus e as opções são:

Menu	Opções
<p> Capturar permite ajustar as configurações da câmera que afetam as características de futuras imagens e clipes de vídeo capturadas com a câmera.</p>	<ul style="list-style-type: none">• Modos Fotografia (Modo Automático, Paisagem, Retrato, Teatro, Panorama direita, Panorama esquerda, Ação, Retrato noturno, Cena noturna, Praia, Neve, Pôr-do-sol, Documento)• Timer interno• Corrigir olhos vermelhos• Compensação da exposição• Iluminação adaptativa• Intervalo• Qualidade da imagem• Qualidade de vídeo• Disparo• Balanço de branco• Área de foco automático• Medição EA• Velocidade ISO• Saturação• Nitidez• Contraste• Gravação de data e hora
<p> Reproduzir permite trabalhar com as imagens armazenadas na câmera.</p>	<ul style="list-style-type: none">• Análise da imagem• Informações sobre a imagem• Exibir apresentação de slides

Menu	Opções
	<ul style="list-style-type: none">• Montar panorama• Gravar áudio• Mover imagens p/ cartão
 Galeria de projetos permite aprimorar as imagens que você capturar.	<ul style="list-style-type: none">• Aplicar efeitos artísticos• Modificar cor• Adicionar bordas• Corrigir olhos vermelhos• Girar• Cortar
 Configuração permite alterar o comportamento da câmera.	<ul style="list-style-type: none">• Brilho do visor• Volume dos sons• Luz auxiliar de foco• Tempo de espera do visor• Revisão instantânea• Zoom digital• Data e hora• Configuração USB• Configuração de TV• Idioma• Restaurar configurações
 Ajuda oferece descrições de recursos da câmera e dicas de como tirar fotos.	<ul style="list-style-type: none">• Dez melhores dicas• Acessórios da câmera• Botões da câmera• Usar modos de fotografia• Usar a galeria de projetos• Compartilhar imagens• Imprimir imagens• Gravar clipes de áudio• Gravar clipes de vídeo• Rever imagens e vídeos

Menu	Opções
	<ul style="list-style-type: none"> • Extrair impressões do vídeo • Excluir imagens • Transferir imagens • Gerenciar baterias • Obter assistência • Atalhos da câmera • Sobre...

Ao se pressionar  em **Exibição ao vivo** ou em **Reproduzir**, vê-se o **menu Photosmart Express**.

Menu	Opções
 Photosmart Express permite que você compartilhe suas fotos com amigos e parentes.	<ul style="list-style-type: none"> • Imprimir • Encomendar impressões online • Compart. todas as imagens • Configuração do menu Compartilhar

Português



Share Menu •
(הגדרות תפריט Setup
שיתוף)



עברית

תפריט	אפשרויות
	<ul style="list-style-type: none"> • Recording Audio Clips (הקלטת קטעי שמע) • Recording Video Clips (הקלטת קטעי וידאו) • Reviewing Images and Videos (הצגת תמונות וקטעי וידאו) • Extracting Prints from Video (חילוץ הדפסים מווידאו) • Deleting Images (מחיקת תמונות) • Transferring Images (העברת תמונות) • Managing Batteries (טיפול בסוללות) • Getting Assistance (קבלת סיוע) • Camera Shortcuts (קיצורי דרך במצלמה) • About... (אודות...)

בעת לחיצה על  מ-Live View (תצוגה חיה) או **Photosmart Express Playback** (הקרנה חוזרת), תראה את **Photosmart Express menu** (תפריט Photosmart Express).

תפריט	אפשרויות
	<ul style="list-style-type: none"> • Print (הדפסה) • Buy Prints Online (רכישת הדפסים באופן מקוון) • Share All Images (שיתוף כל התמונות)
<p>Photosmart Express </p> <p>מאפשר שיתוף צילומים עם חברים ובני משפחה.</p>	

אפשרויות	תפריט
<ul style="list-style-type: none"> ● Focus Assist Light (נורית עזרה למיקוד) ● Display Timeout (הפסקת תצוגה) ● Instant Review (סקירה מיידית) ● Digital Zoom (זום דיגיטלי) ● Date & Time (תאריך ושעה) ● USB ● Configuration (תצורת USB) ● TV Configuration (תצורת טלוויזיה) ● Language (שפה) ● Reset Settings (איפוס הגדרות) 	
<ul style="list-style-type: none"> ● Top Ten Tips (עשר עצות מובילות) ● Camera Accessories (אביזרי המצלמה) ● Camera Buttons (לחצני המצלמה) ● Using Shooting Modes (שימוש במצבי צילום) ● Using Design Gallery (שימוש בגלריית העיצוב) ● Sharing Images (שיתוף תמונות) ● Printing Images (הדפסת תמונות) 	<p data-bbox="533 706 818 763">Help ? (עזרה) מספקת תיאור למאפייני המצלמה ועצות לצילום.</p>

אפשרויות	תפריט
<ul style="list-style-type: none"> • Sharpness (חדות) • Contrast (ניגודיות) • Date & Time • Imprint (הטבעת תאריך ושעה) 	
<ul style="list-style-type: none"> • Image Advice (עצה לתמונה) • Image Info (פרטי תמונה) • View Slideshow (הצגת תצוגת שקופיות) • Stitch Panorama (חיבור פנורמה) • Record Audio (הקלטת שמע) • Move Images to Card (העברת תמונות לכרטיס) 	<p>Playback  (הקרנה חוזרת)</p> <p>מאפשר עבודה עם תמונות שאוחסנו במצלמה.</p>
<ul style="list-style-type: none"> • Apply Artistic Effects (החלת אפקטים יצירתיים) • Modify Color (שינוי צבע) • Add Borders (הוספת גבולות) • Remove Red Eyes (הסרת עיניים אדומות) • Rotate (סיבוב) • Crop (חיתוך) 	<p>Design Gallery  (גלריית עיצוב) מאפשרת שיפור של התמונות שנלכדו.</p>
<ul style="list-style-type: none"> • Display Brightness (בהירות התצוגה) • Sounds Volume (עוצמת הקול של הצלילים) 	<p>Setup  (הגדרות) מאפשר שינוי הגדרות המצלמה.</p>







תפריטים ואפשרויות:

אפשרויות	תפריט
<ul style="list-style-type: none"> • מצבי צילום (Auto Mode) (מצב אוטומטי), Landscape (נוף), Portrait (דיוקן), Theatre (תיאטרון), Panorama Right Panorama Left (ימין), (פנורמה שמאל), Action (פעולה), Night Portrait (דיוקן בלילה), Night (נוף בלילה), Scenery Beach (חוף), Snow (שלג), Sunset (שקיעה), Document (מסמך) • Self-Timer (קוצב-זמן עצמי) • Red-Eye Removal (הסרת עיניים אדומות) • Exposure Compensation (פיצוי חשיפה) • Adaptive Lighting (תאורה משתנה) • Bracketing (תחימה) • Image Quality (איכות תמונה) • Video Quality (איכות וידאו) • Burst (צילום מתפרץ) • White Balance (איזון לבן) • Auto Focus Area (מיקוד אוטומטי) • AE Metering (מדידת חשיפה אוטומטית) • ISO Speed (מהירות ISO) • Saturation (רוויה) 	<ul style="list-style-type: none"> •  Capture (לכידה) מאפשר התאמת הגדרות המצלמה המשפיעות על מאפייני התמונות וקטעי הווידאו שאתה לוכד באמצעות המצלמה.

6 עיון מהיר במצלמה

היעזר בפרק זה לצורך עיון מהיר במאפייני המצלמה. לקבלת מידע נוסף אודות מאפייני המצלמה, עיין במדריך המקוון למשתמש.

תצוגה חיה והקרנה חוזרת

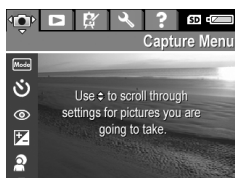

- **Live View** (תצוגה חיה) מאפשרת לך לתחום תמונות וקטעי וידאו בתצוגת התמונות. להפעלת מצב **Live View** (תצוגה חיה), לחץ על  /  עד להופעת הסמל  למשך פרק זמן קצר בפינה הימנית העליונה בתצוגת התמונות.
- **Playback** (הקרנה חוזרת) מאפשר לך להציג ולערוך תמונות וקטעי וידאו. להפעלת **Playback** (הקרנה חוזרת), לחץ על  /  עד להופעת  למשך פרק זמן קצר בפינה הימנית העליונה בתצוגת התמונות.

תפריטים



בעת לחיצה על ^{Menu}OK (תפריט) / אישור) מ-**Playback** (הקרנה חוזרת) או **Live View** (תצוגה חיה), אתה ניגש לתפריטי המצלמה בכרטיסים, כמוצג בדוגמה שבמשך.

השתמש ב- כדי לעבור לתפריט הרצוי. בתפריט, השתמש ב-  כדי לעבור לבחירות מסוימות.

ליציאה מתפריט, לחץ על  /  בכל שלב.

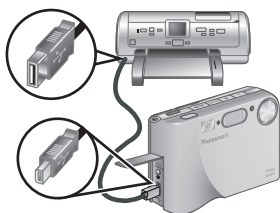

2. חבר את המצלמה ואת המדפסת בעזרת כבל ה-USB המצורף למצלמה.

3. הפעל את המצלמה.

4. כאשר המצלמה מחוברת למדפסת, יוצג במצלמה

Print Setup Menu

(תפריט הגדרת הדפסה). לשינוי ההגדרות, השתמש ב-

▲▼ במצלמה לבחירת אפשרות מהתפריט, לאחר מכן השתמש ב-◀▶ במצלמה לשינוי ההגדרות.

5. לחץ על $\frac{\text{Menu}}{\text{OK}}$ (תפריט/אישור) כדי להתחיל להדפיס.

5 העברה והדפסה של תמונות

העברת תמונות

אם התקנת את תוכנת HP Photosmart, היעזר בה לצורך העברת תמונות וקטעי וידאו למחשב. אם לא התקנת את תוכנת HP Photosmart, עיין במדריך המקוון למשתמש למידע אודות שיטות העברה אחרות.

עצה כמו כן, באפשרותך לבצע משימה זו בעזרת תחנת עגינה אופציונלית HP Photosmart למצלמה (עיין במדריך למשתמש של תחנת העגינה).

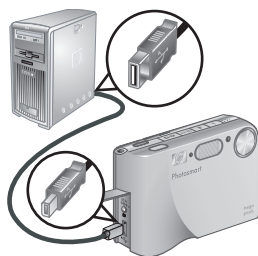

1. כבה את המצלמה ולאחר מכן חבר אותה למחשב בעזרת כבל ה-USB המצורף למצלמה.
2. הפעל את המצלמה ופעל בהתאם להוראות שעל-גבי המסך להעברת התמונות. לקבלת מידע נוסף, עיין במאפיין Help (עזרה) שבתוכנת HP Photosmart.

הדפסת תמונות מהמצלמה







באפשרותך לחבר את המצלמה לכל מדפסת מאושרת-PictBridge כדי להדפיס תמונות סטילס ותמונות שנשמרו מקטע וידאו.

1. ודא שהמדפסת מופעלת, שיש בה נייר ושלא מופיעות הודעות שגיאה במדפסת.

4 הצגה ומחיקה של תמונות וקטעי וידאו

הצגת תמונות וקטעי וידאו

באפשרותך להציג ולערוך תמונות וקטעי וידאו ב-**Playback** (הקרנה חוזרת).

1. לחץ על  /  עד להופעת  למשך פרק זמן קצר בפינה הימנית העליונה בתצוגת התמונות. סמל זה מצייין כי הנך נמצא במצב **Playback** (הקרנה חוזרת).
2. השתמש ב-  כדי לגלול בין התמונות ובין קטעי הווידאו (קטעי הווידאו יוצגו באופן אוטומטי).

מחיקת תמונה

באפשרותך למחוק תמונות יחידות במהלך מצב **Playback** (הקרנה חוזרת):

1. לחץ על  /  עד להופעת  למשך פרק זמן קצר בפינה הימנית העליונה בתצוגת התמונות. סמל זה מצייין כי הנך נמצא במצב **Playback** (הקרנה חוזרת).
2. השתמש ב-  לבחירת תמונה או קטע וידאו.
3. לחץ על  כדי להציג את תפריט המשנה **Delete** (מחיקה).
4. השתמש ב-  לבחירת האפשרות **This Image** (תמונה זו) ולאחר מכן לחץ על   (תפריט/אישור).



4. להפסקת הקלטת וידאו, לחץ שנית על הלחצן **וידאו** ושחרר אותו.

3 צילום תמונות והקלטת קטעי וידאו

Live View (תצוגה חיה) מאפשרת לך לתחום תמונות וקטעי וידאו בתצוגת התמונות.

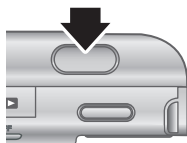



צילום תמונת סטילס

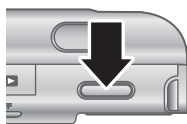

1. לחץ על  /  עד להופעת הסמל  למשך פרק זמן קצר בפניה הימנית העליונה בתצוגת התמונות. סמל זה מציין כי הנך נמצא במצב **Live View** (תצוגה חיה).
2. מסגר את נושא הצילום.
3. לחץ לחיצה חלקית על לחצן **התריס** כדי למדוד ולנעול את החשיפה והמיקוד. תוחמי המיקוד בתצוגת התמונות יופיעו בירוק רציף כאשר המיקוד ננעל.
4. לחץ לחיצה מלאה על לחצן **התריס** על מנת לצלם את התמונה.
5. להוספת קטע שמע באורך של עד 60 שניות, המשך ללחוץ על לחצן **התריס** ושחרר אותו לאחר שתסיים.

הקלטת קטע וידאו



1. לחץ על  /  עד להופעת הסמל  למשך פרק זמן קצר בפניה הימנית העליונה בתצוגת התמונות. סמל זה מציין כי הנך נמצא במצב **Live View** (תצוגה חיה).
2. מסגר את נושא הצילום.
3. לחץ על הלחצן **וידאו**  ושחרר אותו.

אם אתה נתקל בבעיה בעת התקנה או שימוש בתוכנת HP Photosmart, עיין באתר האינטרנט של שירות הלקוחות של HP לקבלת מידע נוסף, בכתובת: www.hp.com/support.

Windows

אם מחשב ה-Windows שברשותך אינו עומד בדרישות המערכת המפורטות באריזת המצלמה, תותקן התוכנה HP Photosmart Essential במקום הגרסה המלאה HP Photosmart Premier.

1. סגור את כל התוכניות והשבת באופן זמני תוכנות להגנה מפני וירוסים.
2. הכנס את תקליטור תוכנת HP Photosmart לכונן התקליטורים במחשב ופעל בהתאם להוראות על-גבי המסך. אם חלון ההתקנה לא מופיע, לחץ על **התחל** (Start), לחץ על **הפעלה** (Run), הקלד **D:\Setup.exe**, כאשר **D** היא אות כונן התקליטורים, ולאחר מכן לחץ על **אישור** (OK).
3. לאחר סיום התקנת התוכנה, הפעל מחדש את התוכנה להגנה מפני וירוסים.

Macintosh

1. הכנס את תקליטור תוכנת HP Photosmart לכונן התקליטורים.
2. לחץ לחיצה כפולה על סמל התקליטור בשולחן העבודה.
3. לחץ לחיצה כפולה על סמל ההתקנה ולאחר מכן פעל בהתאם להוראות על-גבי המסך.

התקנה ואתחול של כרטיס זיכרון אופציונלי

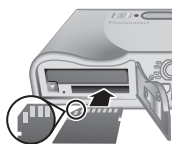

מצלמה זו תומכת בכרטיסי זיכרון Secure Digital (SD) סטנדרטיים ובעלי מהירות גבוהה מתוצרת HP, בנפח 8MB עד 2GB.

1. כבה את המצלמה ופתח את דלת הסוללה/כרטיס הזיכרון.
 2. הכנס את כרטיס הזיכרון האופציונלי לחריץ הקטן כמוצג. ודא שכרטיס הזיכרון מתייצב במקומו בנקישה.
 3. סגור את דלת הסוללה/כרטיס הזיכרון והפעל את המצלמה.
- אתחל תמיד את כרטיס הזיכרון לפני השימוש הראשוני.

1. כאשר המצלמה מופעלת, לחץ על / עד שתגיע למצב **Playback** (הקרנה חוזרת).
 2. לחץ על כדי להציג את תפריט המשנה **Delete** (מחיקה).
 3. השתמש ב- לבחירת האפשרות **Format Card** (אתחול כרטיס) ולאחר מכן לחץ על (תפריט/אישור).
 4. השתמש ב- לבחירת האפשרות **Yes** (כן) ולאחר מכן לחץ על (תפריט/אישור) לאתחול הכרטיס.
- לאחר שתתקין כרטיס זיכרון, כל התמונות וקטעי הווידאו החדשים יאוחסנו בכרטיס במקום בזיכרון הפנימי.

על מנת להשתמש בזיכרון הפנימי ולהציג את התמונות המאוחסנות בו, הסר את כרטיס הזיכרון.

התקנת התוכנה

תוכנת HP Photosmart מספקת מאפיינים להעברת תמונות וקטעי וידאו למחשב, כמו גם מאפיינים לשיפור תמונות מאוחסנות (הסרת עיניים אדומות, סיבוב, חיתוך, שינוי גודל, התאמת איכות תמונה, הוספת צבעים, אפקטים מיוחדים ועוד).

בחירת שפה

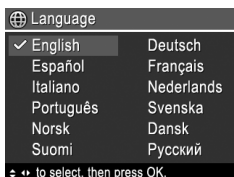

השתמש ב-▲▼▶◀ לבחירת השפה הרצויה, לאחר מכן לחץ על ^{Menu}OK (תפריט/אישור).

בחירת מדינה/אזור

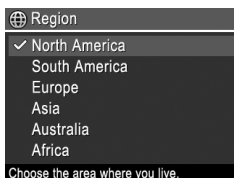

ביחד עם ההגדרה **Language** (שפה), ההגדרה **Region** (מדינה/אזור) קובעת את ברירת המחדל עבור תבנית התאריך ואת שיטת השידור של אותות הווידאו להצגת תמונות מהמצלמה בטלוויזיה.

השתמש ב-▲▼▶◀ לבחירת המדינה/אזור הרצויים, לאחר מכן לחץ על ^{Menu}OK (תפריט/אישור).

הגדרת תאריך ושעה

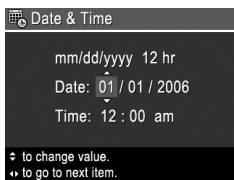

1. השתמש ב-▲▼▶◀ כדי לכוון את הערך המסומן.
 2. השתמש ב-▶◀ כדי לעבור לאפשרויות האחרות וחזור על שלב 1 עד להגדרת התאריך והשעה כהלכה.
 3. לחץ על ^{Menu}OK (תפריט/אישור)
- כאשר הגדרות התאריך, השעה והתבנית נכונות, לאחר מכן לחץ שנית על ^{Menu}OK (תפריט/אישור) לאישור.

2 הגדרת המצלמה

התקנת הסוללה



1. פתח את דלת הסוללה/כרטיס הזיכרון על-ידי החלקת תפס הדלת, כפי שמצוין על דלת הסוללה/כרטיס הזיכרון.
 2. הכנס את הסוללה לחריץ הרחב יותר, ודחוף אותה עד שהתפס יינעל.
 3. סגור את דלת הסוללה/כרטיס זיכרון.
- הערה כבה את המצלמה לפני שתסיר את הסוללה. טען את הסוללה במלואה לפני השימוש הראשוני.

טעינת הסוללה



באפשרותך לטעון את הסוללה במצלמה, בעזרת מתאם ה-AC.

חבר את מתאם המתח AC למצלמה ולאחר מכן חבר אותו לשקע חשמל.

כאשר נורית טעינת הסוללה במצלמה מהבהבת, היא מציינת שהסוללה נמצאת בטעינה; כאשר הסוללה מוארת באופן רציף, הסוללה טעונה במלואה (כ-2 עד 3 שעות).

הפעלת המצלמה

להפעלת המצלמה, לחץ על לחצן ON/OFF (הפעלה/כיבוי).

חלקה הקדמי והתחתון של המצלמה

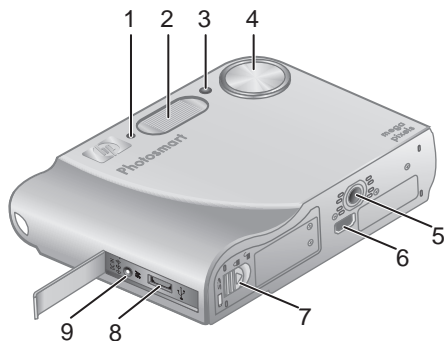

1	מיקרופון.
2	הבזק.
3	נורית קוצב-הזמן העצמי/עזרה למיקוד.
4	עדשה.
5	תושבת חצובה.
6	מחבר לתחנת עגינה.
7	דלת סוללה/כרטיס זיכרון.
8	מחבר USB.
9	מחבר מתאם מתח.

תושבת לתחנת עגינה למצלמה

בעת רכישת תחנת עגינה אופציונלית HP Photosmart, היא מצוידת בתושבות שקופות. בעת התקנת תחנת העגינה לשימוש עם המצלמה, השתמש בתושבת לתחנת העגינה בעלת התווית הכחולה העגולה. לקבלת הנחיות, עיין במדריך למשתמש בתחנת העגינה.

8	נורית הפעלה.
9	לחצן ON/OFF (הפעלה/כיבוי).
10	תושבת רצועת היד.
11	מתג זום (דיגיטלי ואופטי) - ב- Live View (תצוגה חיה), לחץ על  (זום קרוב) כדי לקרב או לחץ על  (זום רחוק) כדי להרחיק. ב- Playback (הקרנה חוזרת), לחץ על  כדי להגדיל את התמונה הנבחרת או לחץ על  כדי לראות את התמונות ממוזערות.
12	לחצן Mode (המצב) - לחץ על  כדי לגשת לתפריט Shooting Mode (מצב צילום) ב- Live View (תצוגה חיה). האפשרויות ב- Shooting Mode (מצב צילום) הן Auto Mode (מצב אוטומטי), Landscape (נוף), Portrait (דיוקן), Theatre (תיאטרון), Panorama Right (פנורמה ימין), Panorama Left (פנורמה שמאל), Action (פעולה), Night Portrait (דיוקן בלילה), Night Scenery (נוף בלילה), Beach (חוף), Snow (שלג), Sunset (שקיעה), Document (מסמך).
13	 - גלילה בין התפריטים והתמונות.
14	 (תפריט/אישור) - להצגת תפריטי המצלמה, בחירת אפשרויות ואישור פעולות.
15	נורית טעינת סוללה.
16	לחצן Delete (מחיקה)  — כדי לגשת לפונקציה Delete (מחיקה) במצב Playback (הקרנה חוזרת).
17	תצוגת תמונות.

חלקה העליון והאחורי של המצלמה

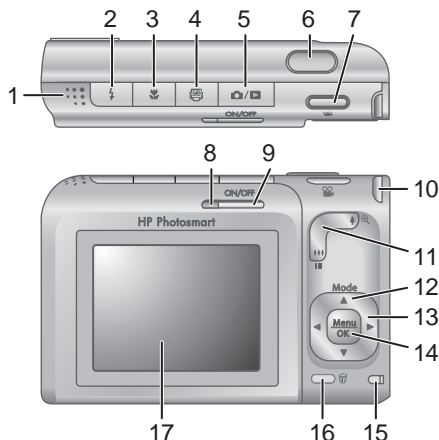

1	רמקול.
2	⚡ לחצן הבזק - ההגדרות הן Auto (אוטומטי), Flash On (הבזק פועל), Flash Off (הבזק כבוי).
3	🌸 לחצן מיקוד - ההגדרות הן Normal (רגיל), Macro (מאקרו), Auto Macro (מאקרו אוטומטי), Infinity (אינסוף).
4	🖨️ לחצן Photosmart Express - האפשרויות הן Print (הדפסה), Buy Prints Online (רכישת הדפסים באופן מקוון), Share Setup (התקנה משותפת).
5	📷/📺 לחצן Live View/Playback (תצוגה חיה/הקרנה חוזרת)—למעבר בין Live View (תצוגה חיה) לבין Playback (הקרנה חוזרת) ראה "תצוגה חיה והקרנה חוזרת" בעמוד 18).
6	לחצן תריס .
7	📹 הלחצן וידאו .

המדריך המקוון למשתמש מועתק גם למחשב בעת התקנת התוכנה HP Photosmart. להצגת המדריך למשתמש לאחר שהותקן במחשב:

- **במערכת Windows:** פתח את **HP Solution Center** ולחץ על **Help and Support** (עזרה ותמיכה).
- **במערכת Macintosh:** פתח את **HP Device Manager** ובחר ב-**User Guide** מהתפריט המוקפץ **Information and Settings**.

קבלת סיוע

- לקבלת עצות וכלים שיעזרו לך להשתמש במצלמה ביעילות רבה יותר, בקר בכתובת **www.hp.com/photosmart** (באנגלית בלבד) או בכתובת **www.hp.com**.
- לקבלת סיוע, כלי אבחון והורדות מנהלי התקן עבור המוצר, 7 ימים בשבוע, 24 שעות ביממה, בקר בכתובת **www.hp.com/support**.
- לקבלת עזרה אודות תוכנת HP Photosmart, עיין בעזרה המקוונת עבור תוכנת HP Photosmart.

1 תחילת הדרך

מדריך ההתחלה המהירה המודפס מספק את המידע שלו אתה זקוק בתחילת הדרך בשימוש המאפיינים החיוניים של המצלמה. לקבלת מידע מפורט אודות מאפייני המצלמה, עיין במדריך המקוון למשתמש.

מדריך התחלה מהירה	מדריך מקוון למשתמש
המדריך המודפס יסייע לך:	המדריך המקוון למשתמש מכיל:
<ul style="list-style-type: none">• להתחיל להשתמש במצלמה במהרה• להתקין את תוכנת HP Photosmart• להכיר את מאפייני המצלמה	<ul style="list-style-type: none">• תיאורים של כל מאפייני המצלמה• תיאור סמלים על-גבי תצוגת התמונות• מידע אודות סוללות, לרבות:<ul style="list-style-type: none">- הארכת חיי הסוללות- תיאור של סמלי מחווני ההספק• פתרון בעיות• קבלת סיוע מ-HP• מפרטי המצלמה

גישה למדריך המקוון למשתמש

המדריך המקוון למשתמש נמצא בתקליטור התוכנה
HP Photosmart



להצגת המדריך למשתמש:

1. הכנס את תקליטור תוכנת HP Photosmart לכונן התקליטורים במחשבך.
2. **במערכת Windows:** בדף הראשי במסך ההתקנה, לחץ על **View User Guide** (הצג את המדריך למשתמש).
- במערכת Macintosh:** פתח את קובץ **readme** בתיקייה **docs** שבתקליטור.

תוכן עניינים

4	1	תחילת הדרך
4		גישה למדריך המקוון למשתמש
6		חלקה העליון והאחורי של המצלמה
8		חלקה הקדמי והתחתון של המצלמה
8		תושבת לתחנת עגינה למצלמה
9	2	הגדרת המצלמה
9		התקנת הסוללה
9		טעינת הסוללה
9		הפעלת המצלמה
10		בחירת שפה
10		בחירת מדינה/אזור
10		הגדרת תאריך ושעה
11		התקנה ואתחול של כרטיס זיכרון אופציונלי
11		התקנת התוכנה
13	3	צילום תמונות והקלטת קטעי וידאו
13		צילום תמונת סטילס
13		הקלטת קטע וידאו
15	4	הצגה ומחיקה של תמונות וקטעי וידאו
15		הצגת תמונות וקטעי וידאו
15		מחיקת תמונה
16	5	העברה והדפסה של תמונות
16		העברת תמונות
16		הדפסת תמונות מהמצלמה
18	6	עיון מהיר במצלמה

מידע משפטי והודעות

Copyright 2006 Hewlett-Packard Development Company, ©
L.P.

המידע הכלול במסמך זה נתון לשינויים ללא הודעה מוקדמת. האחריות הבלעדית למוצרים ולשירותים של HP מפורטת בהצהרת האחריות המפורשת הנלווית לאותם מוצרים ושירותים. אין לפרש דבר מן האמור במסמך זה כהענקת אחריות נוספת. חברת HP לא תישא באחריות לשגיאות או השמטות מסיבות טכניות או בעקבות עריכה.

Windows® הוא סימן מסחרי רשום בארה"ב של Microsoft Corporation.

הסמל SD הוא סימן מסחרי של בעליו. 

השלכת פסולת ציוד על-ידי משתמשים במשקי בית פרטיים באיחוד האירופי



סמל זה, כאשר הוא מופיע על המוצר או על אריזתו, פירושו שאסור להשליך את המוצר יחד עם שאר האשפה הביתית. במקום זאת, מתפקידך להשליך את פריטי הציוד המשומש הזה על-ידי הפקדתם בנקודות איסוף מיוחדות לצורך מיחזור של פריטי ציוד חשמליים ואלקטרוניים משומשים. האיסוף בנפרד והמיחזור של פריטי ציוד משומשים בעת השלכתם, יסייעו בשמירה על משאבים טבעיים ויבטיחו מיחזור באופן שיש בו כדי להגן על הבריאות ועל הסביבה. לפרטים נוספים על נקודות איסוף לפריטי ציוד משומשים המיועדים למיחזור, פנה אל הרשות המקומית, אל שירות השלכת האשפה הביתית, או אל החנות שבה רכשת את המוצר.

לצורך פניות עתידיות, מלא את הפרטים הבאים:

- מספר דגם (בחלקה הקדמי של המצלמה): _____
- מספר סידורי (בחלקה התחתון של המצלמה): _____
- תאריך רכישה: _____

מצלמה דיגיטלית
HP Photosmart R725/R727

עברית

