

Multimedia

User Guide

© Copyright 2006 Hewlett-Packard
Development Company, L.P.

Microsoft and Windows are U.S. registered
trademarks of Microsoft Corporation.

The information contained herein is subject
to change without notice. The only
warranties for HP products and services are
set forth in the express warranty statements
accompanying such products and services.
Nothing herein should be construed as
constituting an additional warranty. HP shall
not be liable for technical or editorial errors
or omissions contained herein.

First Edition: September 2006

Document Part Number: 419881-001

Table of contents

1 Using multimedia hardware

Using the audio features	1
Using the audio-in (microphone) jack	3
Using the audio-out (headphone) jack	3
Using S/PDIF digital audio (select models only)	3
Adjusting the volume	4
Using the QuickPlay buttons	5
Media button—QuickPlay installed	5
Media button—QuickPlay not installed	5
DVD button—QuickPlay installed	6
DVD button—QuickPlay not installed	6
Using the video features	7
Using the external monitor port	7
Using the S-Video-out jack	8
Using the HDMI port (select models only)	9
Using the camera	10
Capturing and streaming video	11
Capturing video	11
Streaming video with an instant message program	11
Taking still photographs with the integrated camera	12
Adjusting camera properties	12
Using an optical drive	14
Identifying the installed optical drive	14
Inserting an optical disc	14
Removing an optical disc when running on battery or external power	15
Removing an optical disc when no computer power is available	16
Using the media activity functions	17
Using the media activity hotkeys	17
Using the media activity buttons	18
Previous/rewind button	18
Play/pause button	18
Next/fast forward button	19
Stop button	19

2 Working with multimedia software

Opening preinstalled multimedia software	21
Installing multimedia software from a disc	21
Using multimedia software	21
Preventing playback disruptions	22

Changing DVD region settings	23
Observing the copyright warning	23

Index	24
--------------------	-----------

1 Using multimedia hardware

Using the audio features

The following illustration and table describe the audio features of the computer.



NOTE Your computer may look slightly different from the illustration in this section.

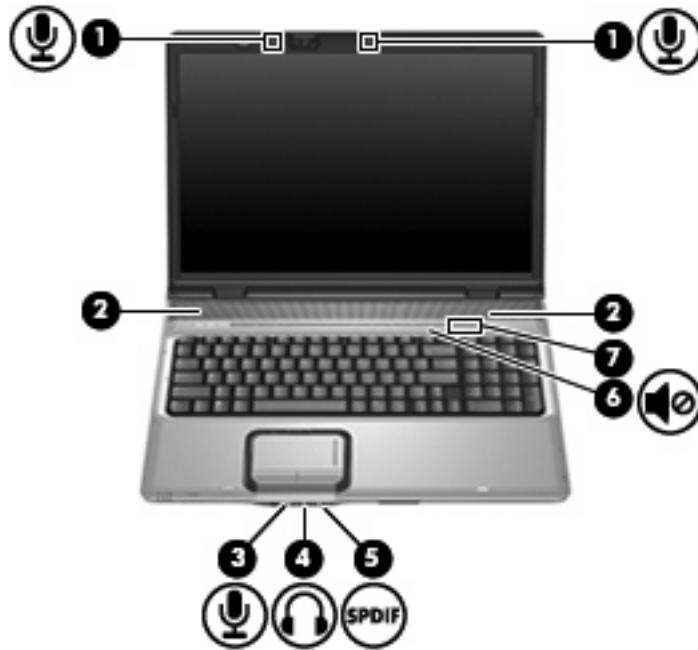

Component	Description
(1) Internal microphones (2)	Record sound.  NOTE A microphone icon next to the microphone opening indicates that the computer has an internal microphone.
(2) Speakers (2)	Produce sound.
(3) Audio-in (microphone) jack	Connects an optional computer headset microphone, stereo array microphone, or monaural microphone.
(4) Audio-out (headphone) jack	Connects optional powered stereo speakers, headphones, ear buds, a headset, or television audio.

Component	Description
(5) Audio-out (headphone) S/PDIF jack	Provides enhanced audio performance, including surround sound and other high-end audio output.
(6) Volume mute button	Mutes and restores computer sound.
(7) Volume scroll zone	Adjusts speaker volume. Slide your finger to the left to decrease volume and to the right to increase volume. You can also tap the minus sign on the scroll zone to decrease volume, or you can tap the plus sign on the scroll zone to increase volume.

Using the audio-in (microphone) jack

The computer is equipped with a stereo (dual-channel) microphone jack that supports an optional stereo array or monaural microphone. Using sound recording software with external microphones allows for stereo recordings.

When connecting a microphone to the microphone jack, use a microphone with a 3.5-mm plug.

Using the audio-out (headphone) jack



WARNING! To reduce the risk of personal injury, adjust the volume before putting on headphones, earbuds, or a headset.



CAUTION To prevent possible damage to an external device, do not plug a single sound channel (monaural) connector into the headphone jack.

In addition to connecting headphones, the headphone jack is used to connect the audio input function of an audio/video device such as a television or VCR.

When connecting a device to the headphone jack, use only a 3.5-mm stereo plug.

When a device is connected to the headphone jack, the speakers are disabled.

Using S/PDIF digital audio (select models only)

S/PDIF (Sony/Phillips Digital Interface) or digital audio provides enhanced audio performance, including surround sound and other high-end audio output.

For digital audio connections, connect the S/PDIF digital audio plug to the digital audio connector on your audio/video equipment.



NOTE In order to use S/PDIF with the headphone jack, you will need an optional mini TOS link cable and/or adapter.

Adjusting the volume

You can adjust the volume using the following controls:

- Computer volume buttons:
 - To mute or restore volume, press the mute button.
 - To decrease volume, slide your finger across the volume scroll zone from right to left.
 - To increase volume, slide your finger across the volume scroll zone from left to right.

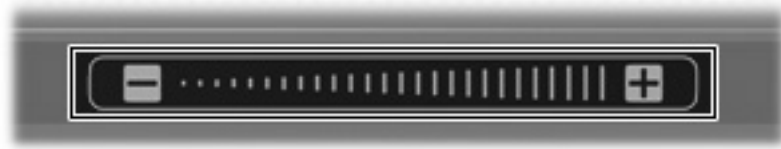

- Microsoft® Windows® volume control:
 - a. Click the **Volume** icon in the notification area, at the far right of the taskbar.
 - b. Increase or decrease the volume by moving the slider up or down. Select the **Mute** check box to mute the volume.

– or –

- a. Double-click the **Volume** icon in the notification area.
- b. In the Master Volume column, increase or decrease the volume by moving the **Volume** slider up or down. You can also adjust the balance or mute the volume.

If the Volume icon is not displayed in the notification area, follow these steps to add it:

- a. Select **Start > Control Panel > Sounds, Speech, and Audio Devices > Sounds and Audio Devices**.
 - b. Click the **Volume** tab.
 - c. Select the **Place volume icon in the taskbar** check box.
 - d. Click **Apply**.
- Program volume control:

Volume can also be adjusted within some programs.

Using the QuickPlay buttons

Media button and DVD button functions vary, depending on the software installed on your computer.

The media button (1) and the DVD button (2) allow you to listen to music, play DVDs, and watch movies with the touch of a button.

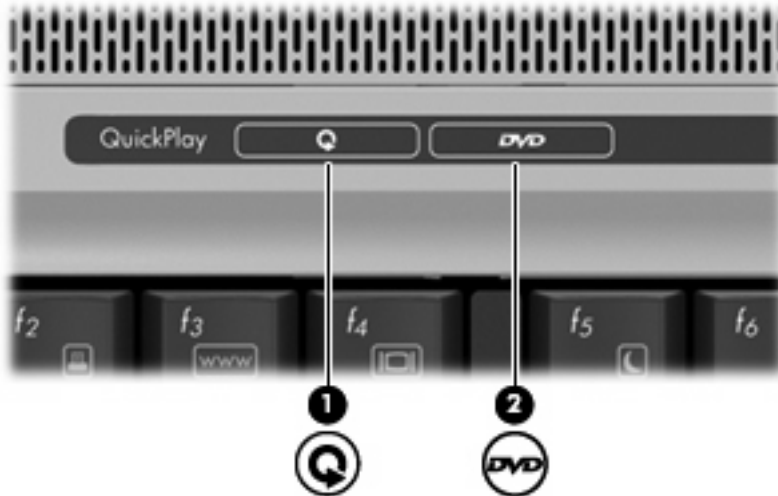

Media button—QuickPlay installed



Computer power state	Media button function
On or off	Opens a music program or the Media menu so that you can select a multimedia program. NOTE Press the power button to exit the program.
Standby	Exits standby.

Media button—QuickPlay not installed

Computer power state	Media button function
On	Opens the default media player.
Off	None.
Standby	Exits standby.

NOTE The media button does not affect the restoration from hibernation.

DVD button—QuickPlay installed

Computer power state	DVD button function
On	Opens the default DVD program so that you can play a DVD in the optical drive.  NOTE Press the power button to exit the program.
Off	Opens QuickPlay so that you can play a DVD in the optical drive.  NOTE Press the power button to exit QuickPlay.
Standby	Exits standby.

DVD button—QuickPlay not installed

Computer power state	DVD button function
On	Opens the default DVD program so that you can play a DVD in the optical drive.
Off	None.
Standby	Exits standby.
	 NOTE The DVD button does not affect the restoration from hibernation.

Using the video features

Using the external monitor port

The external monitor port connects an external display device, such as a television, an external monitor, or a projector, to the computer.

To connect a display device, connect the device cable to the external monitor port.

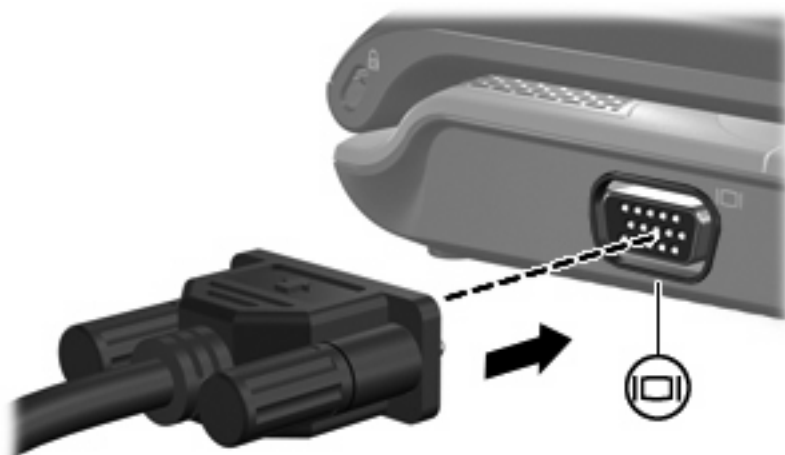

NOTE If a properly connected external display device does not display an image, press **fn+f4** to transfer the image to the device.

Using the S-Video-out jack

The 7-pin S-Video-out jack connects the computer to an optional S-Video device such as a television, VCR, camcorder, overhead projector, or video capture card.

To transmit video signals through the S-Video-out jack, you need an S-Video cable, available from most electronics retailers. If you are combining audio and video functions, such as playing a DVD movie on your computer and displaying it on your television, you also need a standard audio cable, available from most electronics retailers, to connect to the headphone jack.

The computer can support one S-Video device connected to the S-Video-out jack, while simultaneously supporting an image on the computer display or on any other supported external display.



NOTE The S-Video connection provides a higher quality image than a composite-video connection.

To connect a video device to the S-Video-out jack:

1. Plug one end of the S-Video cable into the S-Video-out jack on the computer.

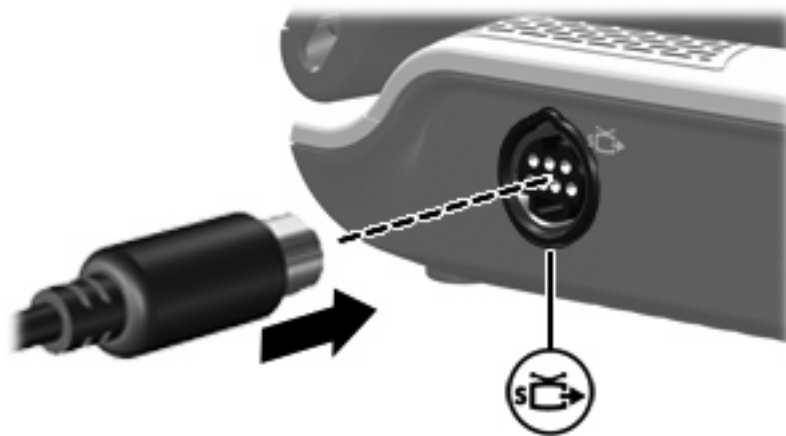

NOTE If the S-Video-out jack on the computer is not accessible because the computer is docked in an optional docking device, connect the S-Video cable to the S-Video-out jack on the docking device.

2. Plug the other end of the cable into the video device, as instructed in the user guide included with the device.
3. Press the **fn+f4** keys to switch the image between display devices connected to the computer.

Using the HDMI port (select models only)

Select computer models include an HDMI (High Definition Multimedia Interface) port. The HDMI port connects the computer to an optional video or audio device such as a high-definition television, set-top box, DVD player, or any compatible digital or audio component.

The computer can support one HDMI device connected to the HDMI port, while simultaneously supporting an image on the computer display or any other supported external display.



NOTE To transmit video signals through the HDMI port, you need an HDMI cable (purchased separately), available from most electronics retailers.

To connect a video or audio device to the HDMI port:

1. Plug one end of the HDMI cable into the HDMI port on the computer.

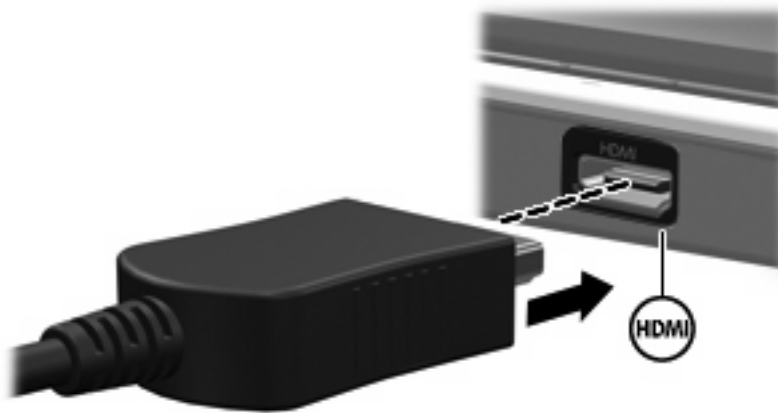

2. Connect the other end of the cable to the video device, according to the device manufacturer's instructions.
3. Press **fn+f4** to switch the image between the display devices connected to the computer.

Using the camera

Select computer models include an integrated camera, located on the top of the display. The camera can be used with a variety of software for the following functions:

- Capturing video.
- Streaming video with instant message software.
- Taking still photos.

The camera light **(1)** turns on when video software accesses the camera **(2)**.



For optimum performance, observe the following guidelines while using the integrated camera:

- Be sure that you have the latest version of an instant message program before attempting a video conversation.
- Your integrated camera may not work properly across some network firewalls. If you are having trouble viewing or sending video to someone on another LAN or outside your network firewall, contact your network administrator for assistance.
- Whenever possible, place bright light sources behind the camera and out of the picture area.

Capturing and streaming video

To illustrate how each camera feature works, the following examples use specific software, not available on all computers. Select **Start > All Programs** to locate the video software installed on your computer, and refer to the individual program's online Help for further information.

Capturing video

You can capture video for playback at a later time. The following example uses MovieMaker software:

1. Select **Start > Programs > Windows MovieMaker**.
2. Click **Capture from Video Device**. The Video Capture Wizard opens.
3. Click the listing for the integrated camera from the list of available devices.
4. Check the microphone and camera settings, and adjust if necessary.
5. Click **Next**.
6. Select the file name and path where you want to save the video file, and then click **Next**.
7. Select the video settings, and then click **Next**.
8. Click **Start Capture**. When you finish recording, click **Stop Capture**.
9. Click **Finish** to save the video file and close the wizard.

Streaming video with an instant message program

You can send real-time video through an instant message program. The following example uses Windows Messenger:

1. Open Windows Messenger by double-clicking the icon in the notification area, at the far right of the taskbar.
2. Sign in to Windows Messenger.
3. Select **Actions > Voice/Video > Start a Video Conversation**.
4. Click the name of the person you want to connect with, and then click **OK**. An instant message window is displayed, and the camera image is displayed next to the message area.
5. If the Audio and Video Tuning Wizard opens, follow the instructions to adjust your camera and microphone settings.

Taking still photographs with the integrated camera

1. Select **Start > Control Panel > Scanners and Cameras**.
2. Double-click the listing for the integrated camera, and then click **Next**.
3. Click **Take Picture**.
4. Follow the directions on the Picture wizard to select any of the following options:
 - Publish the pictures to a Web site.
 - Order prints of the pictures.
 - Save the pictures on your computer.

Adjusting camera properties

You can adjust the following camera properties:

- **Brightness**—Controls the amount of light that is incorporated into the image. A higher brightness setting creates a brighter image; a lower brightness setting creates a darker image.
- **Contrast**—Controls the difference between lighter and darker areas on the image. A higher contrast setting intensifies the image; a lower contrast setting maintains more of the original information's dynamic range but leads to a flatter image.
- **Hue**—Controls the aspect of color that distinguishes it from another color (what makes a color red, green, or blue). Hue is distinct from saturation, which measures the intensity of the hue.
- **Saturation**—Controls the strength of color in the final image. A higher saturation setting creates a bolder image; a lower saturation setting creates a more subtle image.
- **Sharpness**—Controls the definition of edges in an image. A higher sharpness setting creates a more defined image; a lower sharpness setting creates a softer image.
- **Gamma**—Controls the contrast affecting the mid-level grays or midtones of an image. Adjusting the gamma of an image allows you to change brightness values of the middle range of gray tones without dramatically altering the shadows and highlights. A lower Gamma setting makes greys look black, and makes dark colors even darker.
- **White Balance**—Controls the color temperature of the dominant light sources. This enables white objects in the image to appear truly white. The white balance settings in the Properties dialog box are displayed as WB (Red) and WB (Blue). A higher white balance setting increases the concentration of the color (red or blue); a lower white balance setting decreases the concentration of the selected color.
- **Exposure**—Controls the relative amount of light that enters the camera sensor. A higher exposure setting allows more light; a lower exposure setting allows less light.
- **Gain**—Controls the intensity range, thus altering the color contrast of the image. A higher gain setting stretches the intensity range; a lower gain setting shrinks the intensity.
- **Light Source**—Controls the settings to adjust the camera exposure for the ambient light.
- **Flip**—Reverses the captured image vertically.
- **Mirror**—Reverses the captured image horizontally.

- Privacy—Turns off the capture function.
- Low Light—Lowers the frame rate automatically in a poor lighting environment to maintain the brightness of the captured image.

The Properties dialog box is accessible from various programs that use the integrated camera, usually from a configuration, settings, or properties menu.

Using an optical drive

Depending on the type of optical drive and software installed in your computer, the optical drive plays, copies, and creates CDs or DVDs.

Identifying the installed optical drive

- ▲ Select **Start > My Computer**.

The type of optical drive installed in the computer is displayed under Devices with Removable Storage.

Inserting an optical disc

1. Turn on the computer.
2. Press the release button **(1)** on the drive bezel to release the media tray.
3. Pull out the tray **(2)**.
4. Hold the disc by the edges to avoid touching the flat surfaces and position the disc label-side up over the tray spindle.



NOTE If the tray is not fully accessible, tilt the disc carefully to position it over the spindle.

5. Gently press the disc **(3)** down onto the tray spindle until the disc snaps into place.

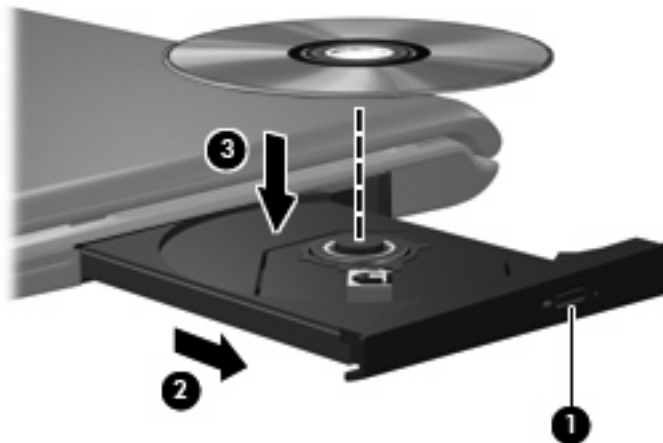

6. Close the media tray.



NOTE After you insert a disc, a short pause is normal. If you have not selected a media player, an AutoPlay dialog box opens. It prompts you to select how you want to use the media content.

Removing an optical disc when running on battery or external power

1. Press the release button (1) on the drive bezel to release the media tray, and then gently pull out the tray (2) until it stops.
2. Remove the disc (3) from the tray by gently pressing down on the spindle while lifting the outer edges of the disc. Hold the disc by the edges and avoid touching the flat surfaces.



NOTE If the tray is not fully accessible, tilt the disc carefully as you remove it.

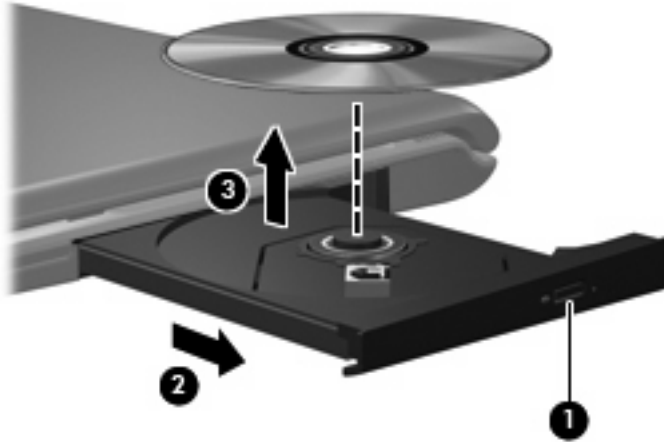

3. Close the media tray and place the disc in a protective case.

Removing an optical disc when no computer power is available

1. Insert the end of a paper clip (1) into the release access in the front bezel of the drive.
2. Press in gently on the paper clip until the tray is released, and then pull out the tray (2) until it stops.
3. Remove the disc (3) from the tray by gently pressing down on the spindle while lifting the outer edges of the disc. Hold the disc by the edges and avoid touching the flat surfaces.



NOTE If the tray is not fully accessible, tilt the disc carefully as you remove it.

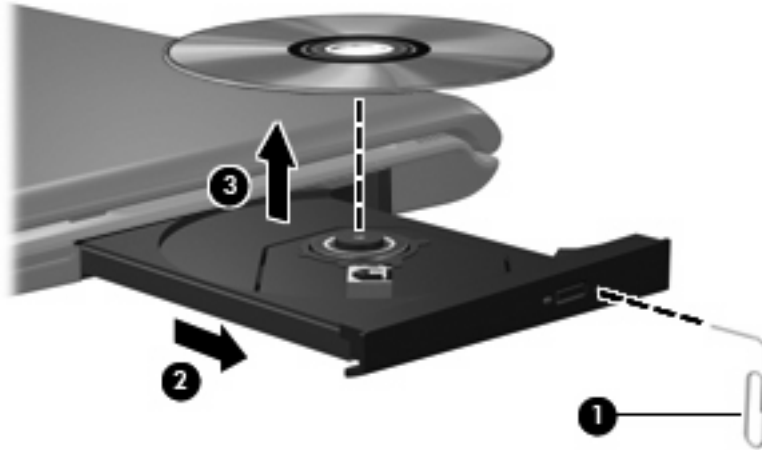

4. Close the media tray and place the disc in a protective case.

Using the media activity functions

The media activity hotkeys and the media activity buttons (select models only) control the play of an audio CD or a DVD that is inserted into the optical drive.

Using the media activity hotkeys

A media activity hotkey is a combination of the **fn** key (1) and a function key.



NOTE To control the play of a video disc, use the media activity controls in your video disc player program.

- To play, pause, or resume an audio CD or a DVD, press **fn+f9** (2).
- To stop an audio CD or a DVD that is playing, press **fn+f10** (3).
- To play the previous track of an audio CD or the previous chapter of a DVD that is playing, press **fn+f11** (4).
- To play the next track of an audio CD or the next chapter of a DVD that is playing, press **fn+f12** (5).

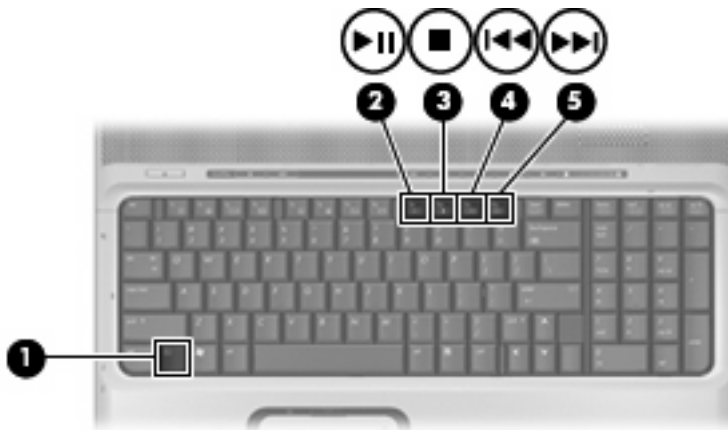

Using the media activity buttons

The following illustration and tables describe the functions of the media activity buttons when a disc is inserted in the optical drive.

- Previous/rewind button (1)
- Play/pause button (2)
- Next/fast forward button (3)
- Stop button (4)

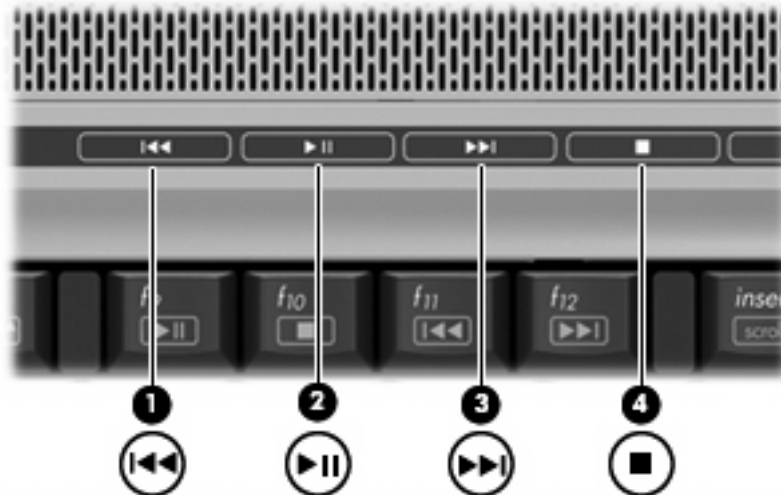

Previous/rewind button

Disc status	Button	Function
Playing	Previous/rewind button	Plays a previous track or chapter.
Playing	fn + previous/rewind button	Rewinds the playback.

Play/pause button

Disc status	Button	Function
Not playing	Play/pause button	Plays the disc.
Playing	Play/pause button	Pauses the playback.

Next/fast forward button

Disc status	Button	Function
Playing	Next/fast forward button	Plays the next track or chapter.
Playing	fn + next/fast forward button	Fast forwards the playback.

Stop button

Disc status	Button	Function
Playing	Stop button	Stops the playback.

2 Working with multimedia software

The computer includes preinstalled multimedia software. Some computer models also include additional multimedia software on an optical disc.

Depending on the hardware and software included with the computer, the following multimedia tasks may be supported:

- Playing digital media, including audio and video CDs, audio and video DVDs, and Internet radio
- Creating or copying data CDs
- Creating, editing, and burning audio CDs
- Creating, editing, and burning a video or movie to a DVD or video CD



CAUTION To prevent loss of information or damage to a disc:

Before writing to a disc, connect the computer to a reliable external power source. Do not write to a disc while the computer is running on battery power.

Before writing to a disc, close all open programs except the disc software you are using.

Do not copy directly from a source disc to a destination disc or from a network drive to a destination disc. Instead, copy from a source disc or network drive to your hard drive, and then copy from your hard drive to the destination disc.

Do not use the computer keyboard or move the computer while the computer is writing to a disc. The write process is sensitive to vibration.



NOTE For information about using software included with the computer, refer to the software manufacturer's instructions that may be provided on disc, as online Help files, or on the software manufacturer's Web site.

Opening preinstalled multimedia software

1. Select **Start > All Programs**.
2. Click the program that you want to open.

Installing multimedia software from a disc

1. Insert the disc into your optical drive.
2. When the installation wizard opens, follow the on-screen instructions.
3. Restart the computer if prompted to do so.

Using multimedia software

1. Select **Start > All Programs**, and then open the multimedia program you want to use. For example, if you want to use Windows Media Player to play an audio CD, click **Windows Media Player**.



NOTE Some programs may be located in subfolders.

2. Insert the media disc, such as an audio CD, into the optical drive.
3. Follow the instructions on the screen.

– or –

1. Insert the media disc, such as an audio CD, into the optical drive.

An AutoPlay dialog box opens.

2. Click a multimedia task from the list of tasks.



NOTE The AutoPlay dialog box allows you to select a multimedia program for the media disc. After you select a program from the list, click the **Always do the selected action** box.

3. Click **OK**.

Preventing playback disruptions

To reduce the possibility of playback disruption:

- Save your work and close all open programs before playing a CD or a DVD.
- Do not connect or disconnect hardware while playing a disc.

Do not initiate standby or hibernation while playing a disc. Otherwise, you may see the warning message “Putting the computer into hibernation or standby might stop the playback. Do you want to continue?” If this message is displayed, click **No**. After you click No:

- Playback may resume.
– or –
- Playback may stop and the screen may clear. To return to playing the CD or DVD, press the power button and then restart the disc.

Changing DVD region settings

Most DVDs that contain copyrighted files also contain region codes. The region codes help protect copyrights internationally.

You can play a DVD containing a region code only if the region code on the DVD matches the region setting on your DVD drive.



CAUTION The region settings on your DVD drive can be changed only 5 times.

The region setting you select the fifth time becomes the permanent region setting on the DVD drive.

The number of allowable region changes remaining on the drive is displayed in the Changes remaining box on the **DVD Region** tab. The number in the field includes the fifth and permanent change.

To change settings through the operating system:

1. Select **Start > My Computer**.
2. Right-click in the window and select **Properties > Hardware** tab > **Device Manager**.
3. Click **DVD/CD-ROM drives**, right-click the DVD drive for which you want to change region settings, and then click **Properties**.
4. Make the desired changes on the **DVD Region** tab.
5. Click **OK**.

Observing the copyright warning

It is a criminal offense, under applicable copyright laws, to make unauthorized copies of copyright-protected material, including computer programs, films, broadcasts, and sound recordings. Do not use this computer for such purposes.

Index

- A**
 - audio features 1
 - audio-in (microphone) jack 1, 3
 - audio-out (headphone) jack 1, 3
- B**
 - buttons
 - DVD 5
 - Media 5
 - next/fast forward 18
 - play/pause 18
 - previous/rewind 18
 - stop 18
 - volume mute 2, 4
- C**
 - camera
 - capturing video 11
 - identifying 10
 - properties 12
 - taking still photographs 12
 - CD
 - inserting 14
 - playing 22
 - protecting 20
 - removing, with power 15
 - removing, without power 16
 - writing to 20
 - copyright warning 23
- D**
 - DVD
 - changing region setting 23
 - inserting 14
 - playing 22
 - protecting 20
 - removing, with power 15
 - removing, without power 16
 - writing to 20
 - DVD button 5
 - DVD region settings 23
- E**
 - earbuds 1
 - external monitor port 7
- H**
 - headphones 1
- J**
 - jack
 - audio-in (microphone) 1
 - audio-out (headphone) 1
 - jacks
 - audio-in (microphone) 3
 - audio-out (headphone) 3
 - S-Video-out 8
- M**
 - media activity buttons 18
 - media activity hotkeys 17
 - Media button 5
 - microphones, supported 3
 - monitor, connecting 7
 - multimedia software
 - described 20
 - using 21
 - mute button 2, 4
- O**
 - optical disc
 - inserting 14
 - removing, with power 15
 - removing, without power 16
 - writing to 20
 - optical drive
 - playing 22
 - protecting 20
- P**
 - ports
 - external monitor 7
 - programs
 - multimedia 20
 - using 21
 - projector, connecting 7
 - protecting playback 22
- Q**
 - QuickPlay 5
 - QuickPlay buttons 5
- R**
 - region codes, DVD 23
- S**
 - S-Video-out jack 8
 - S/PDIF digital audio 3
 - software
 - multimedia 20
 - using 21
 - speakers 1
- T**
 - TV 3
- V**
 - VCR 3
 - volume mute button 2, 4
 - volume scroll zone 2, 4
 - volume, adjusting 4

