

Tablet PC Tour

Document Part Number: 419466-001

January 2007

This guide explains the computer hardware features.

Contents

1 Components

Top components	1-2
Lights	1-2
Pointing devices	1-4
Buttons and reader	1-6
Keys	1-7
Hotkey quick reference	1-8
Pen-activated buttons	1-9
Display components	1-10
Front components	1-12
Rear components	1-13
Right-side components	1-14
Left-side components	1-15
Bottom components	1-17
Wireless antennae	1-19
Pen components	1-20
Additional hardware components	1-21
Labels	1-22

2 Specifications

Operating environment	2-1
Rated input power	2-2

Index

Components

This chapter explains the hardware features of the computer.

To see a list of hardware installed in the computer:

1. Select **Start > Computer > System properties**.
2. In the left pane, click **Device Manager**.

You can also add hardware or modify your device configurations using Device Manager.



Components included with the computer may vary by region and by model. The illustrations in this chapter identify the standard external features included in most computer models.

Top components

Lights

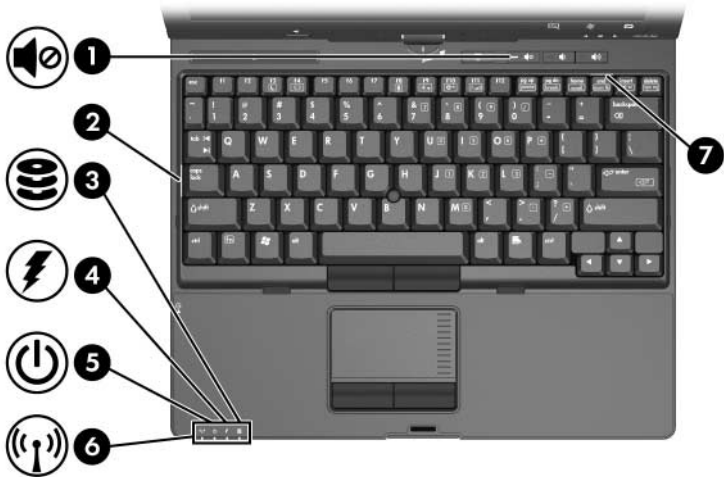

Component	Description
❶ Volume mute light	On: Computer sound is turned off.
❷ Caps lock light	On: Caps lock is on.
❸ Drive light	<ul style="list-style-type: none">■ Blinking green: The hard drive is being accessed.■ Amber: HP Mobile Data Protection 3D with accelerometer software has temporarily parked the internal hard drive.

(Continued)

Component	Description
④ Battery light	<p>Amber: A battery pack is charging.</p> <p>Green: A battery pack is close to full charge capacity.</p> <p>Blinking amber: A battery pack that is the only available power source has reached a low battery level. When the battery reaches a critical battery level, the battery light begins blinking rapidly.</p> <p>Off: If the computer is plugged into an external power source, the light is turned off when all batteries in the computer are fully charged. If the computer is not plugged into an external power source, the light stays off until the battery reaches a low battery level.</p>
⑤ Power light	<p>Green: The computer is on.</p> <p>Blinking green: The computer is in the Sleep state.</p> <p>Off: The computer is off or in Hibernation.</p>
⑥ Wireless light	<p>On: An integrated wireless device, such as a wireless local area network (WLAN) device and/or a Bluetooth® device, is turned on.</p>
⑦ Num lock light	<p>On: Num lock is on or the embedded numeric keypad is enabled.</p>

Pointing devices

Touchpad

The pointing stick and TouchPad controls can be used interchangeably. The following illustration and table describe the computer pointing devices, which vary by model.

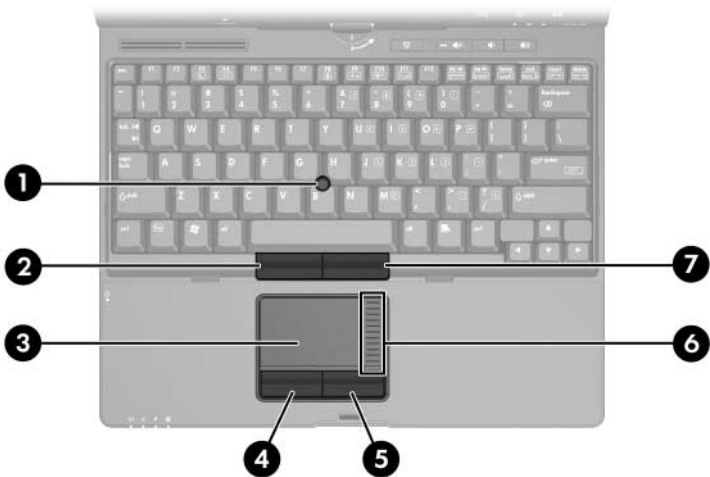

Component	Description
① Pointing stick	Moves the pointer and selects or activates items on the screen.
② Left pointing stick button	Functions like the left button on an external mouse.
③ TouchPad*	Moves the pointer and selects or activates items on the screen. Can be set to perform other mouse functions, such as scrolling, selecting, and double-clicking.

(Continued)

Component	Description
④ Left TouchPad button*	Functions like the left button on an external mouse.
⑤ Right TouchPad button*	Functions like the right button on an external mouse.
⑥ TouchPad scroll zone*	Scrolls up or down.
⑦ Right pointing stick button	Functions like the right button on an external mouse.

*This table describes default settings. To view and change Touch Pad preferences, select **Start > Control Panel > Hardware and Sound > Mouse**.

Buttons and reader

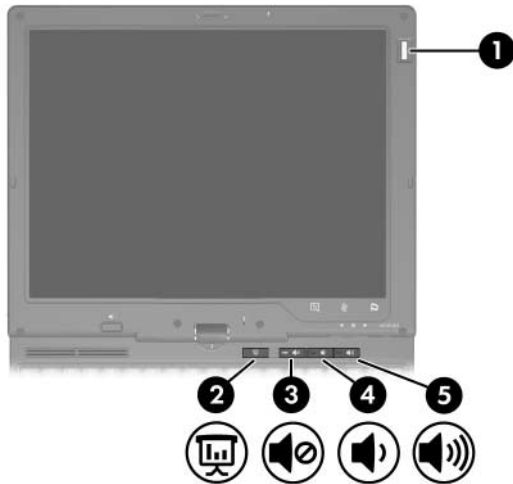

Component	Description
① Fingerprint reader	Allows a fingerprint logon to Windows®, instead of a password logon.
② Presentation button	Starts the Presentation feature.
③ Volume mute button	Mutes and restores computer sound.
④ Volume down button	Decreases computer sound.
⑤ Volume up button	Increases computer sound.

Keys

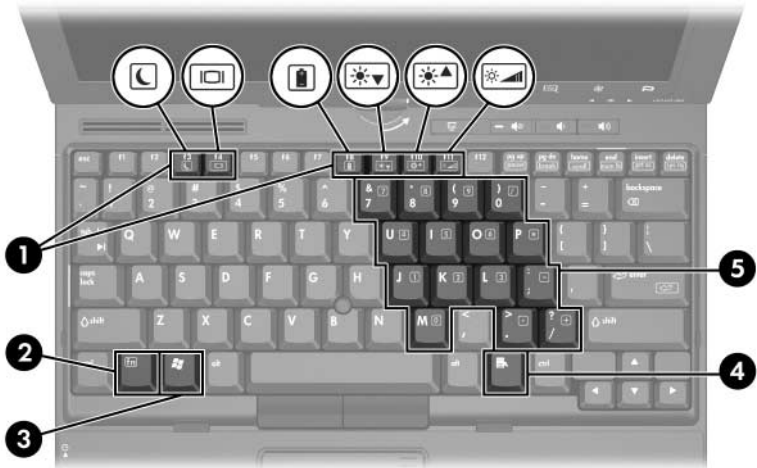

Component	Description
1 Function keys (6)	Execute frequently used system functions when pressed in combination with the fn key.
 Refer to the table in “ Hotkey quick reference ” for a description of each hotkey.	
2 fn key	Executes frequently used system functions when pressed in combination with a function key or the esc key.
3 Windows logo key	Displays the Windows Start menu.
4 Windows applications key	Displays a shortcut menu for items beneath the pointer.
5 Embedded numeric keypad keys (15)	Can be used like the keys on an external numeric keypad.

Hotkey quick reference

To perform this function	Press
Initiate Sleep	fn+f3
Exit Sleep	Slide the Power switch toward the front of the computer.
Alternate between computer display and external display	fn+f4
Display battery information	fn+f8
Clear battery information	fn+f8
Decrease screen brightness	fn+f9
Increase screen brightness	fn+f10
Display system information	fn+esc
Clear system information	esc or click OK

Pen-activated buttons

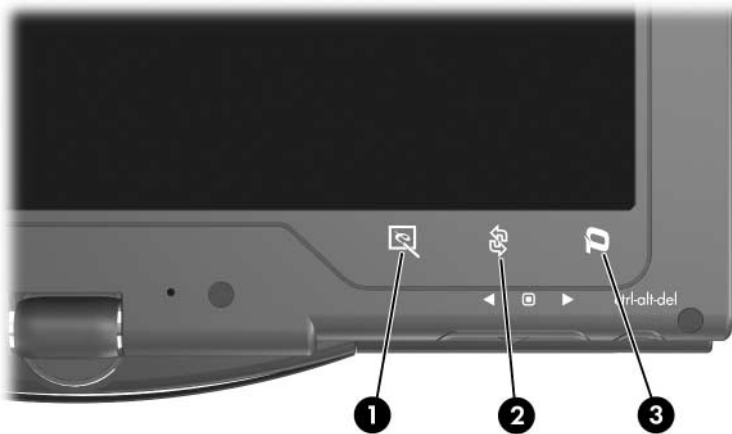

Component	Description
❶ Tablet PC Input Panel launch button*	When Windows is running, opens Microsoft Tablet PC Input Panel, which includes a handwriting pad and an on-screen keyboard.
❷ Rotate button*	Switches the image between landscape and portrait orientation.
❸ Q button*	When Windows is running, opens or closes the Q Menu.

*This table describes default settings. For information about changing the functions of the Tablet PC Input Panel launch button, rotate button, and Q button, use your pen to press the **Q button** and click **Tablet PC Settings**.

Display components

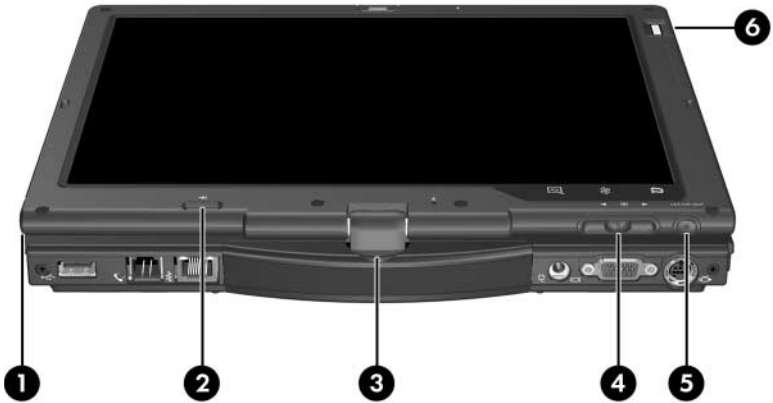

Component	Description
❶ Pen holder	Secures the pen to the computer.
❷ Pen eject button	Ejects the pen from the pen holder.
❸ Rotating hinge	Swivels the display and converts the computer from notebook mode into tablet PC mode or vice versa.
❹ Jog dial*	Functions like enter and the up and down arrow keys on a standard keyboard: <ul style="list-style-type: none">■ Press inward to enter a command.■ Rotate up to scroll up.■ Rotate down to scroll down.

(Continued)

Component	Description
⑤ Windows security button*	When pressed while <ul style="list-style-type: none">■ Windows is open, enters the ctrl+alt+delete command.[†]■ The Computer Setup utility is open, enters the reset command.
⑥ Fingerprint reader	Allows a fingerprint logon to Windows instead of a password logon.

*This table describes default settings. For information about changing the functions of the Windows security button and jog dial, refer to “Pointing Devices and Keyboard.”

[†]To protect your work and the system, the ctrl+alt+delete command cannot be entered using the **ctrl**, **alt**, and **del** keys on the on-screen keyboard.

Front components

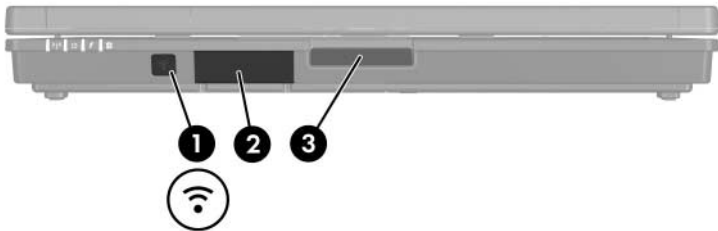

Component	Description
① Infrared port	Provides wireless communication between the computer and an optional IrDA-compliant device.
② Bluetooth module (select models only)	Sends and receives Bluetooth device signals.
⚠ Exposure to Radio Frequency Radiation.	The radiated output power of this device is below the FCC radio frequency exposure limits. Nevertheless, the device should be used in such a manner that the potential for human contact during normal operation is minimized. To avoid the possibility of exceeding the FCC radio frequency exposure limits, human proximity to the antennae should be not less than 20 cm (8 inches) during normal operation, including when the computer display is closed.
③ Display release button	Opens the computer.
⚠	Keep diskettes and other magnetic media away from the magnetic fields located around the Display release button. Magnetic fields can erase diskette data.

Rear components



Component	Description
① USB port	Connects an optional USB device.
② RJ-11 (modem) jack	Connects a modem cable.
③ RJ-45 (network) jack	Connects a network cable.
④ Power connector	Connects an AC adapter.
⑤ External monitor port	Connects an optional external VGA monitor or projector.
⑥ S-Video-out jack	<p>Connects an optional S-Video device such as a television, VCR, camcorder, overhead projector, or video capture card, with an optional, standard (4-pin) S-Video cable.</p> <p>The jack's extra 3 pins also enable an optional S-Video-to-composite adapter to be used with the computer.</p>

Right-side components

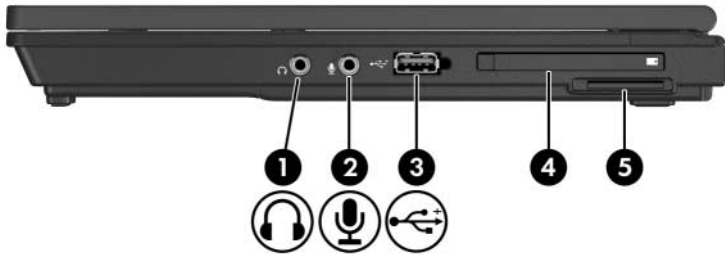

Component	Description
❶ Audio-out (headphone) jack	Produces computer sound when connected to optional powered stereo speakers, headphones, ear buds, a headset, or television audio.
❷ Audio-in (microphone) jack	Connects an optional computer headset microphone, stereo array microphone, or monaural microphone.
❸ Powered USB port	Provides power to a USB device, such as an optional external MultiBay, if used with a powered USB cable.
❹ PC Card slot or optional smart card reader	<p> On select models, the PC Card slot may be replaced with the optional smart card reader.</p> <p>If your computer has</p> <ul style="list-style-type: none"> ■ a PC Card slot, it supports optional Type I, Type II, 32-bit (CardBus), or 16-bit PC Cards. ■ a smart card reader, it accepts smart cards or Java™ Cards.
❺ Digital Media slot	Accepts SD (Secure Digital) Memory Cards or MultiMediaCards.

Left-side components

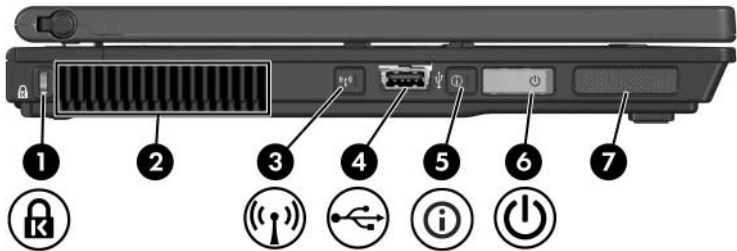

Component	Description
<p>❶ Security cable slot</p> <p>△ The security cable is designed to act as a deterrent, but may not prevent the computer from being mishandled or stolen.</p>	<p>Attaches an optional security cable to the computer.</p>
<p>❷ Vent</p> <p>△ To prevent overheating, do not obstruct vents. Using the computer only on a hard, flat surface. Do not allow another hard surface, such as an adjoining optional printer, or a soft surface, such as pillows, thick rugs, or clothing, to block airflow.</p> <p>✎ The computer fan starts up automatically to cool internal components and prevent overheating. It is normal for the internal fan to cycle on and off during routine operation.</p>	<p>Enables airflow to cool internal components.</p>
<p>❸ Wireless button (select models only)*</p> <p>✎ To establish a wireless connection, a wireless network must already be set up.</p>	<p>Turns the wireless feature on or off, but does not establish a connection.</p>
<p>❹ USB port</p>	<p>Connects an optional USB device.</p>

(Continued)

Component	Description
5 Info Center button	Launches Info Center, which enables you to open various software solutions.
6 Power switch*	<p>When the computer is off, slide the power switch toward the front of the computer and release to turn on the computer.</p> <p>If the computer has stopped responding and Windows shutdown procedures cannot be used, slide the power switch toward the front of the computer and hold for at least 5 seconds to turn off the computer. To learn more about your power settings, select Start > Control Panel > System and Maintenance > Power Options.</p>
7 Speaker	Produces computer sound.

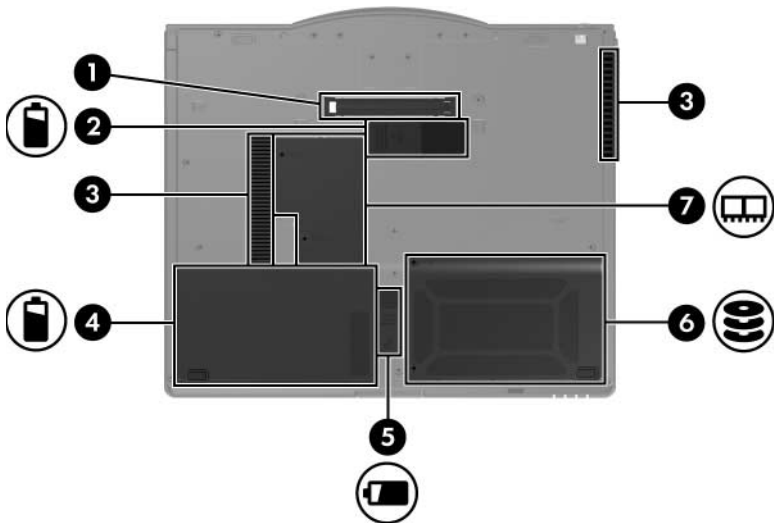

*This table describes default settings. For information about changing the functions of the power features, refer to the user guides located in Help and Support.

Bottom components



Component	Description
❶ Docking connector	Connects the computer to an optional docking device.
❷ Accessory battery connector	Connects an optional accessory battery.

(Continued)

Component	Description
<p data-bbox="155 240 302 267">③ Vents (2)</p> <p data-bbox="206 313 247 350"> To prevent overheating, do not obstruct vents. Use the computer only on a hard, flat surface. Do not allow another hard surface, such as an adjoining optional printer, or a soft surface, such as pillows, thick rugs, or clothing, to block airflow.</p> <p data-bbox="206 472 247 509"> The computer fan starts up automatically to cool internal components and prevent overheating. It is normal for the internal fan to cycle on and off during routine operation.</p>	<p data-bbox="540 240 857 293">Enable airflow to cool internal components.</p>
<p data-bbox="155 570 327 597">④ Battery bay</p>	<p data-bbox="540 570 876 597">Holds the primary battery pack.</p>
<p data-bbox="155 618 514 672">⑤ Primary battery pack release latch</p>	<p data-bbox="540 618 910 672">Releases the primary battery pack from the battery bay.</p>
<p data-bbox="155 691 362 719">⑥ Hard drive bay</p>	<p data-bbox="540 691 763 719">Holds the hard drive.</p>
<p data-bbox="155 740 501 794">⑦ Expansion memory module compartment</p>	<p data-bbox="540 740 894 794">Contains one expansion memory module slot.</p>

Wireless antennae

On select computer models, 2 wireless antennae send and receive wireless device signals. These antennae are not visible from the outside of the computer.

For wireless regulatory notices pertaining to your region, refer to the *Regulatory, Safety and Environmental Notices* located in Help and Support.



For optimal transmission, keep the areas immediately around the antennae free from obstructions.

Pen components

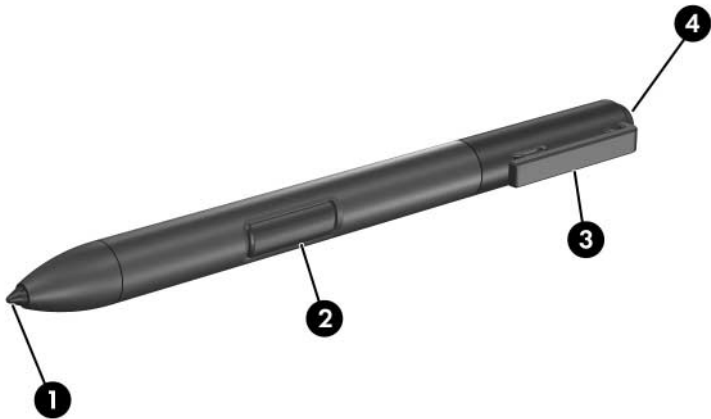

Component	Description
① Pen tip	Interacts with the tablet PC whenever the tip is touching the screen or within 1.27 cm (0.5 inch) of the screen. When tapped on or held over a pen-activated button, activates the button.
② Pen button	Functions like the right button on an external mouse.
③ Pen tether eyelet	Used with the tether eyelet on the tablet PC, enables you to tether the pen to the tablet PC.
④ Pen eraser	Enables you to erase handwriting on the tablet PC.

Additional hardware components



Component	Description
① HP Smart AC Adapter	Converts AC power to DC power.
② Power cord*	Connects an AC adapter to an AC outlet.
③ Primary battery pack*	Powers the computer when the computer is not plugged into external power.
④ Modem cable*	Connects the internal modem to an (RJ-11) telephone jack or to a country-specific modem adapter.
⑤ Country-specific modem adapter (included by region as required)*	Adapts the modem cable to a non-RJ-11 telephone jack.

*Modem cables, battery packs, and power cords vary in appearance by region and country. Battery packs vary by model.

Labels

The labels affixed to the computer provide information you may need when you troubleshoot systems problems or travel internationally with the computer.

- **Service tag**—Provides the product brand and series name, serial number (s/n), and product number (p/n) of your computer. Have this information available when you contact Customer Care. The service tag label is affixed to the bottom of the computer. The information on the service tag is also available through Help and Support.
- **Microsoft® Certificate of Authenticity**—Contains the Windows Product Key. You may need the Product Key to update or troubleshoot the operating system. This certificate is affixed to the bottom of the computer.
- **Regulatory label**—Provides regulatory information about the computer. The regulatory label is affixed to the bottom of the computer.
- **Modem approval label**—Provides regulatory information about the modem and lists the agency approval markings required by some of the countries in which the modem has been approved for use. You may need this information when traveling internationally. The modem approval label is affixed to the bottom of the computer.
- **Wireless certification label(s)**—Provide information about optional wireless devices and the approval markings of some of the countries in which the devices have been approved for use. An optional device may be a wireless local area network (WLAN) device or an optional Bluetooth® device. If your computer model includes one or more wireless devices, one certification label per wireless device is included with your computer. You may need this information when traveling internationally. Wireless certification labels are affixed to the bottom of this computer.

Specifications

The following sections provide information on the operating environment specifications and power specifications of the computer.

Operating environment

The operating environment information in the following table might be helpful if you plan to use or transport the computer in extreme environments.

Factor	Metric	U.S.
Temperature		
Operating (not writing to optical disc)	0°C to 35°C	32°F to 95°F
Operating (writing to optical disc)	5°C to 35°C	41°F to 95°F
Nonoperating	-20°C to 60°C	-4°F to 140°F
Relative humidity (noncondensing)		
Operating	10% to 90%	10% to 90%
Nonoperating	5% to 95%	5% to 95%
Maximum altitude (unpressurized)		
Operating (14.7 to 10.1 psia)	-15 m to 3,048 m	-50 ft to 10,000 ft
Nonoperating (14.7 to 4.4 psia)	-15 m to 12,192 m	-50 ft to 40,000 ft

Rated input power

The power information in this section might be helpful if you plan to travel internationally with the computer.

The computer operates on DC power, which can be supplied by an AC or a DC power source. Although the computer can be powered from a stand-alone DC power source, it is strongly recommended that the computer be powered only with an AC adapter or DC power cord supplied by or approved for an HP computer.

The computer is capable of accepting DC power within the following specifications:

Input Power	Rating
Operating voltage	18.5 V dc @ 3.5 A - 65 W
Operating current	3.5 A

This product is designed for IT power systems in Norway with phase-to-phase voltage not exceeding 240 V rms.

Index

A

- AC adapter 1–13
- accessory battery 1–17
- accessory battery connector 1–17
- altitude specifications 2–1
- audio-in (microphone) jack 1–14
- audio-out (headphone) jack 1–14

B

- battery bay, primary 1–18
- battery connector 1–17
- battery light 1–3
- battery pack
 - accessory battery connector 1–17
 - battery bay 1–18
- battery pack release latch 1–18
- Bluetooth module 1–12
- buttons
 - Info Center 1–16
 - left pointing stick 1–4
 - left TouchPad 1–5
 - pen eject 1–10
 - presentation 1–6
 - Q 1–9

- right pointing stick 1–5
- right TouchPad 1–5
- rotate 1–9
- Tablet PC Input Panel
 - launch 1–9
 - volume 1–6
- Windows security 1–11
- wireless 1–15

C

- caps lock light 1–2
- connectors
 - accessory battery 1–17
 - docking 1–17
 - power 1–13
- country-specific modem adapter 1–21

D

- Digital Media Slot 1–14
- display release button 1–12
- docking connector 1–17
- drive light 1–2

E

- embedded numeric keypad 1–7
- environmental specifications 2–1

expansion memory module
 compartment 1–18
external monitor port 1–13

F

fingerprint reader 1–6
fn key 1–7
function keys 1–7

H

hard drive bay 1–18
headphone jack 1–14
HP Smart AC Adapter 1–21
humidity specifications 2–1

I

Info Center button 1–16
infrared port 1–12

J

jacks
 audio-in (microphone)
 1–14
 audio-out (headphone)
 1–14
 RJ-11 (modem) 1–13
 RJ-45 (network) 1–13
 S-Video-out 1–13

Java Cards 1–14
jog dial
 location 1–10

K

keys
 fn 1–7
 function 1–7
 keypad 1–7

Windows applications 1–7
Windows logo 1–7

L

labels 1–22
left pointing stick button 1–4
left TouchPad button 1–5
lights
 battery 1–3
 caps lock 1–2
 drive 1–2
 num lock 1–3
 power 1–3
 volume mute 1–2
 wireless 1–3

M

memory module
 expansion compartment
 1–18
microphone jack 1–14
modem jack 1–13
MultiMediaCard 1–14
mute button 1–6

N

network jack 1–13
num lock light 1–3

O

operating environment
 specifications 2–1

P

PC Card slot 1–14
pen
 components 1–20
 eject button 1–10

- pen eraser 1–20
- pen holder 1–10
- pen-activated buttons
 - Q Menu 1–9
 - rotate 1–9
 - Tablet PC Input Panel
 - launch 1–9
- pointing stick buttons 1–4
- pointing stick location 1–4
- power connector 1–13
- power light 1–3
- power switch 1–16
- presentation button 1–6

Q

- Q button 1–9

R

- rated input power
 - specifications 2–2
- right pointing stick button 1–5
- right TouchPad button 1–5
- RJ-11 (modem) jack 1–13
- RJ-45 (network) jack 1–13
- rotate button 1–9
- rotating hinge 1–10

S

- security cable slot 1–15
- slots
 - Digital Media 1–14
 - PC Card 1–14
 - smart card reader 1–14
- smart card reader 1–14
- smart cards 1–14
- speaker 1–16

- specifications
 - operating environment 2–1
 - rated input power 2–2
- S-Video-out jack 1–13

T

- Tablet PC Input Panel launch
 - button 1–9
- temperature specifications 2–1
- TouchPad area 1–4
- TouchPad buttons 1–5
- TouchPad scroll zone 1–5
- traveling with the computer,
 - environmental specifications 2–2

U

- USB port 1–13, 1–15
- USB port, powered 1–14

V

- vents 1–15, 1–18
- volume
 - controls 1–6
 - mute light 1–2

W

- Windows applications key 1–7
- Windows logo key 1–7
- Windows security button,
 - identified 1–11
- wireless antennae 1–19
- wireless button 1–15
- wireless light 1–3

© Copyright 2007 Hewlett-Packard Development Company, L.P.

Microsoft and Windows are U.S. registered trademarks of Microsoft Corporation. Bluetooth is a trademark owned by its proprietor and used by Hewlett-Packard Company under license. SD Logo is a trademark of its proprietor. Java is a U.S. trademark of Sun Microsystems, Inc.

The information contained herein is subject to change without notice. The only warranties for HP products and services are set forth in the express warranty statements accompanying such products and services. Nothing herein should be construed as constituting an additional warranty. HP shall not be liable for technical or editorial errors or omissions contained herein.

Tablet PC Tour

First Edition: January 2007

Document Part Number: 419466-001