



HP Officejet Pro
K5300/K5400



Start
Démarrage
Inicio

ابدأ

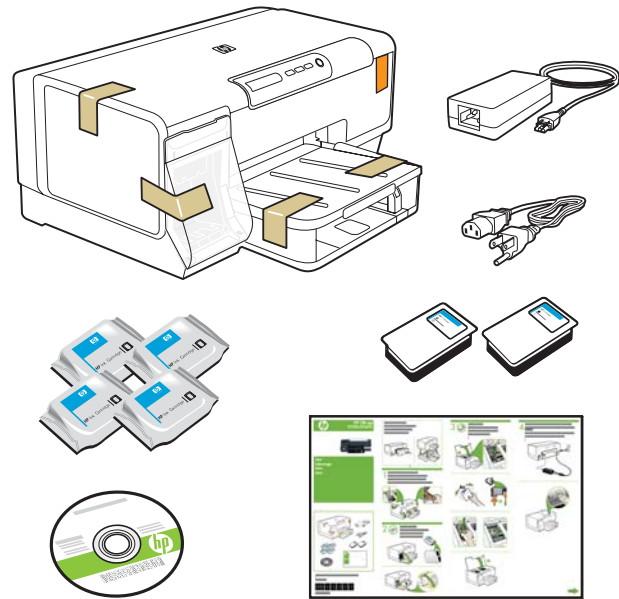

© 2007 Hewlett-Packard Development Company, L.P.

www.hp.com

Printed on recycled paper

Imprimé sur papier recyclé

Printed in Germany
Imprimé en Allemagne
Stampato in Germania



EN FR PT AR

C8184-90005

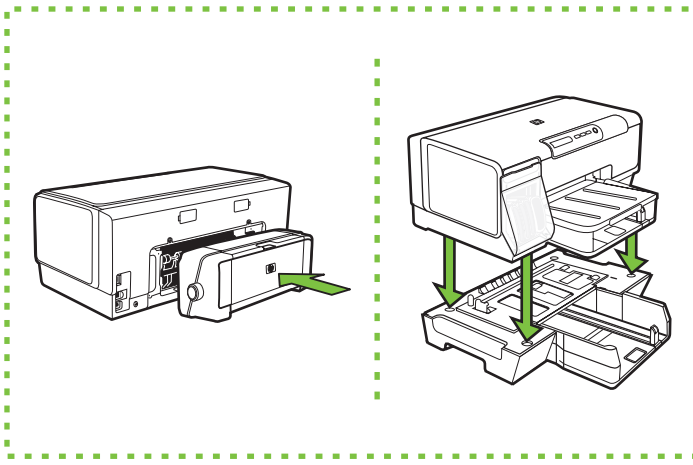

1

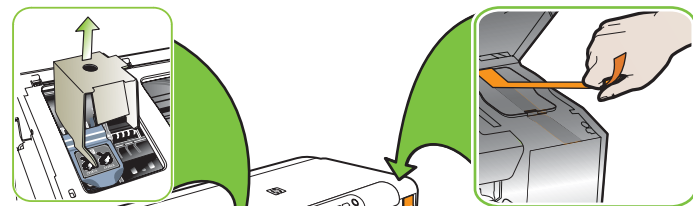

2

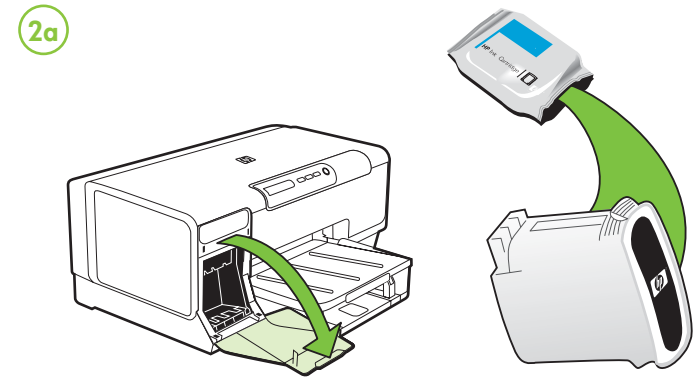

2b

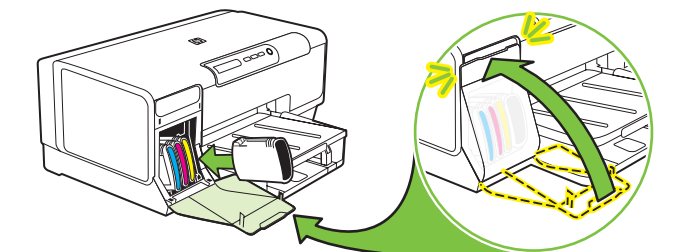

3

3a

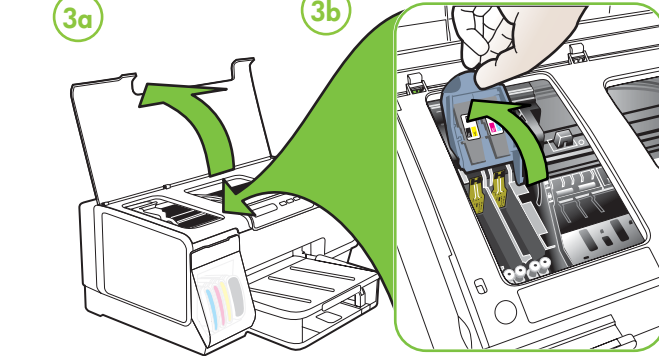

3b

3c

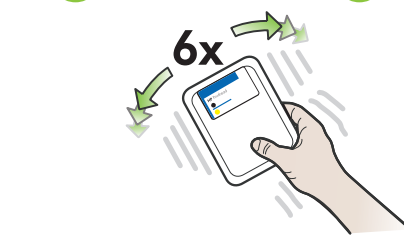

3d

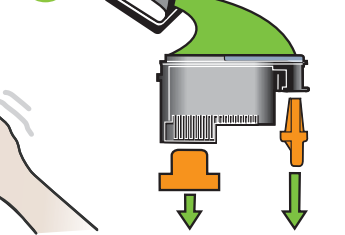

3e

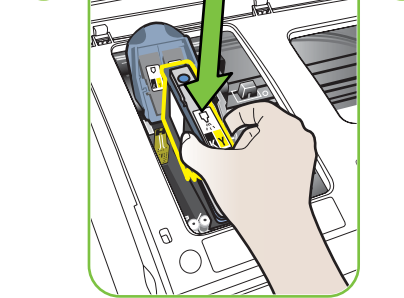

3f

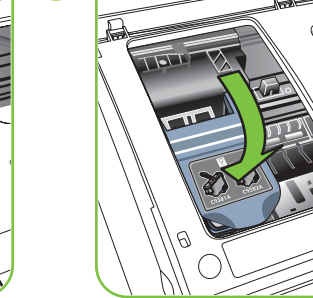

3g

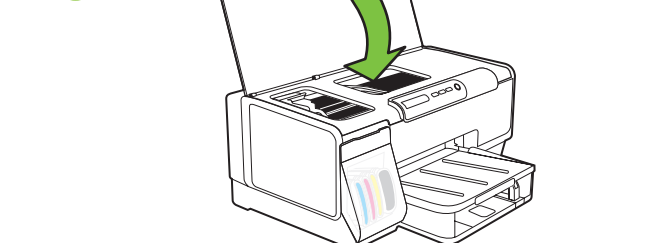

4

4a

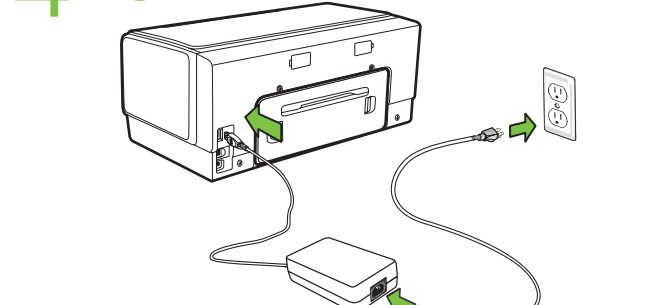

4b

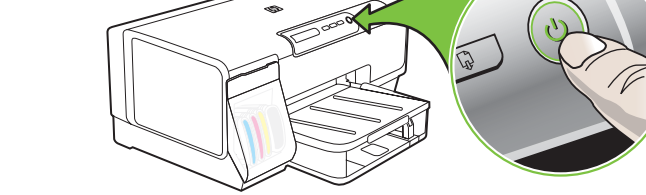

5

5a

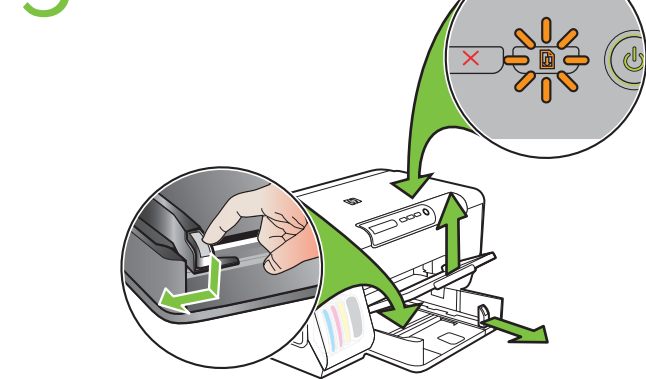

5b



5c

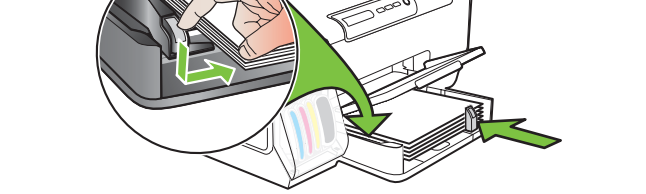

5d

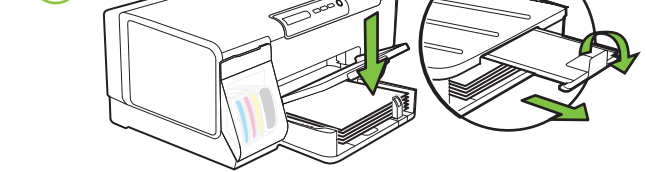

5e





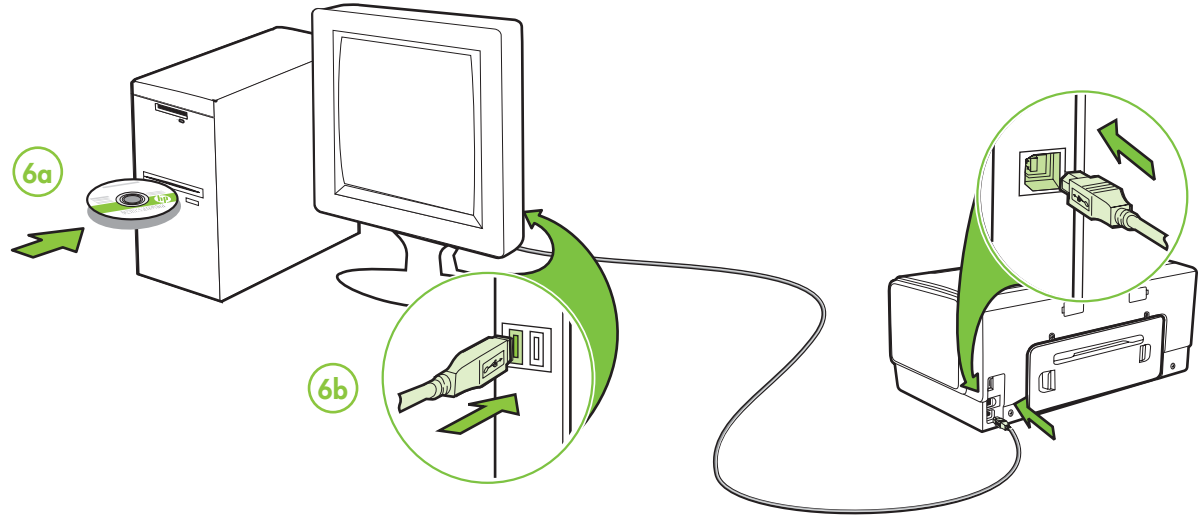

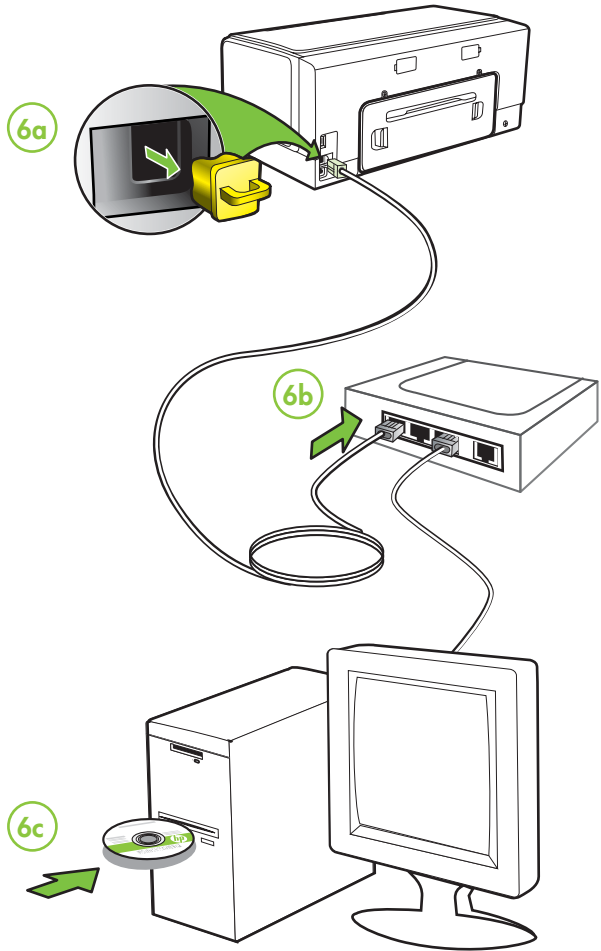
USB



Ethernet



EN Obtain IP address or hardware (MAC) address

The configuration page contains network settings and other information for the printer. To print this page, press  on the control panel.

FR Obtenez une adresse IP ou une adresse matérielle (MAC).

La page de configuration contient des paramètres réseau et d'autres informations pour l'imprimante. Pour imprimer cette page, appuyez sur  sur le panneau de commande.

PT Obtenha o Endereço IP ou o Endereço de hardware (MAC)

A página de configuração contém as configurações de rede e outras informações para a impressora. Para imprimir a página, pressione  no painel de controle.

AR الحصول على عنوان IP أو عنوان الجهاز (MAC).

صفحة التهيئة تحتوي على إعدادات الشبكة ومعلومات أخرى عن الطابعة. لطباعة هذه الصفحة، أضغط على لوحة التحكم.



EN Additional information

See the electronic User Guide on the CD-ROM that came with the device or visit www.hp.com/support for more information on the following topics:

- Troubleshooting information
- Important safety notices and regulatory information
- Detailed user instructions

Note: Ink from the cartridges is used in the printing process in a number of different ways, including in the initialization process, which prepares the device and cartridges for printing, and in printhead servicing, which keeps print nozzles clear and ink flowing smoothly. In addition, some residual ink is left in the cartridge after it is used. For more information see www.hp.com/go/inkusage.

FR Informations supplémentaires

Pour plus d'informations sur les rubriques ci-après, reportez-vous à la version électronique du Guide de l'utilisateur sur le CD-ROM fourni avec l'imprimante :

- Informations de dépannage
- Informations importantes sur la sécurité et informations réglementaires
- Instructions détaillées à l'intention de l'utilisateur

Remarque : L'encre des cartouches est utilisée dans le processus d'impression de différentes manières, notamment dans le processus d'initialisation, qui prépare l'appareil et les cartouches pour l'impression, et dans l'entretien de la tête d'impression qui maintient les buses dégagées et garantit une libre circulation de l'encre. En outre, il reste de l'encre dans la cartouche après son utilisation. Pour plus d'informations, reportez-vous à la page Web www.hp.com/go/inkusage.

PT Informações adicionais

Consulte o Guia eletrônico do usuário no CD-ROM que acompanha o dispositivo ou visite o endereço www.hp.com/support para obter mais informações sobre os tópicos a seguir:

- Informações sobre resolução de problemas
- Avisos importantes sobre segurança e informações regulamentares
- Instruções detalhadas para o usuário

Nota: A tinta dos cartuchos é usada no processo de impressão de várias maneiras, incluindo o processo de inicialização que prepara o dispositivo e os cartuchos para impressão, e o serviço de manutenção do cabeçote de impressão, que mantém os bicos de impressão limpos e a tinta fluindo normalmente. Além disso, sempre fica um pouco de tinta no cartucho após seu uso. Para obter mais informações, consulte www.hp.com/go/inkusage.

AR معلومات إضافية

أنظر دليل المستخدم الإلكتروني على الأسطوانة المدمجة المرفقة مع الجهاز أو قم بزيارة www.hp.com/support للحصول على المزيد من المعلومات عن الموضوعات التالية:

- معلومات حول حل المشكلات
- ملاحظات أمان هامة ومعلومات تنظيمية
- تعليمات تفصيلية للمستخدم

ملاحظة: يستخدم حبر الخراطيش في عمليات الطباعة في عدد مختلف من الطرق، متضمنة عملية التهيئة، و هي التي تقوم بإعداد الجهاز والخراطيش للطباعة، وفي عملية صيانة رؤوس الطباعة، و هي التي تحافظ على فوهات الطباعة نظيفة وتدفق الحبر بسلاسة. بالإضافة إلى ذلك، يترك بعض الحبر المتبقي في الخرطوشة بعد استخدامها. ولمزيد من المعلومات، انظر www.hp.com/go/inkusage.