

# C8088B

## Multifunction Finisher

### Administrator Guide

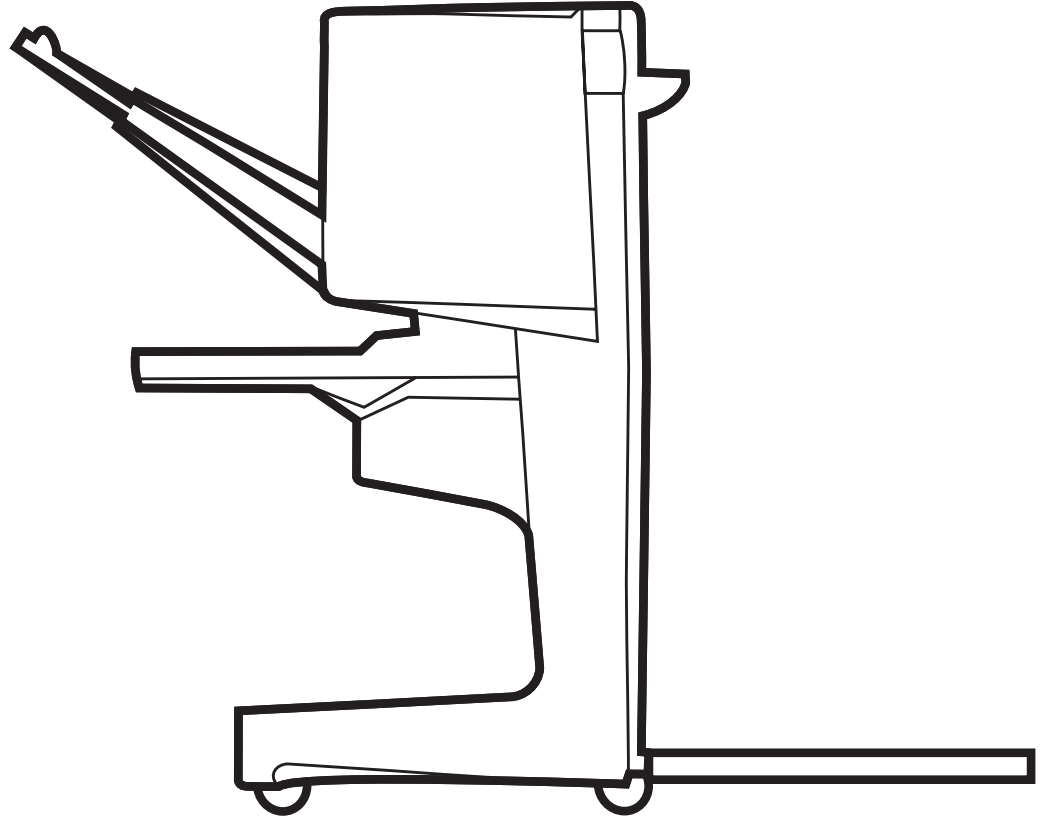



# Multifunction Finisher Administrator Guide



## Copyright and License

© 2007 Copyright Hewlett-Packard  
Development Company, L.P.

Reproduction, adaptation or translation  
without prior written permission is prohibited,  
except as allowed under the copyright laws.

The information contained herein is subject  
to change without notice.

The only warranties for HP products and  
services are set forth in the express warranty  
statements accompanying such products  
and services. Nothing herein should be  
construed as constituting an additional  
warranty. HP shall not be liable for technical  
or editorial errors or omissions contained  
herein.

Part number: C8088-90909

Edition 1, 10/2007

Trademark credits

Microsoft®, Windows®, Windows® XP, and  
Windows™ Vista are U.S. registered  
trademarks of Microsoft Corporation.

PostScript® is a registered trademark of  
Adobe Systems Incorporated.

---

# Table of contents

## 1 Product basics

Features and benefits .....	2
Identify the HP Multifunction Finisher parts .....	3
Light patterns .....	4
Compatibility with HP LaserJet 9000 Series products .....	5
Attach the HP Multifunction Finisher .....	6

## 2 Finisher tasks

Configure default control-panel settings .....	8
Configure the printer driver to recognize the HP Multifunction Finisher .....	10
Booklet printing with the HP Multifunction Finisher .....	11
About booklet printing .....	11
Print a booklet on Windows 2000, Windows XP, Windows Server 2003, and Windows Vista computers .....	11
Print a booklet on Macintosh computers .....	12
Layout options for printing on both sides of the paper .....	12
Change default settings on Windows computers .....	14
Select a booklet cover using Microsoft Windows .....	14
Saddle stitch a booklet using Microsoft Windows .....	14
Saddle stitch a booklet using Macintosh .....	15
Use the stapler .....	16
Select the stapler .....	16
Staple documents .....	17
Load the stapler cartridge .....	17
Choose the output bin .....	20
Identify the output bins .....	20
Select the output location .....	20

## 3 Problem solving

Resolve common problems .....	24
Control-panel messages .....	26
Clear jams .....	28

## Appendix A Specifications

Physical specifications .....	36
Environmental specifications .....	37
Power consumption .....	37
Power requirements .....	37

Circuit capacity .....	37
Operating environment .....	37
Protecting the environment .....	38
Disposal of Waste Equipment by Users in Private Household in the European Union .....	38
Supported media types .....	38
Supported media .....	39

**Appendix B Regulatory information**

Declaration of conformity .....	42
FCC regulations .....	43
Canadian DOC regulations .....	44
VCCI statement (Japan) .....	44
EMI statement (Korea) .....	44
EMI statement (Taiwan) .....	44

**Appendix C Service and support**

World Wide Web .....	45
Warranty information .....	45

<b>Index .....</b>	<b>47</b>
--------------------	-----------

---

# 1 Product basics

- [Features and benefits](#)
- [Identify the HP Multifunction Finisher parts](#)
- [Light patterns](#)
- [Compatibility with HP LaserJet 9000 Series products](#)
- [Attach the HP Multifunction Finisher](#)

## Features and benefits

The HP Multifunction Finisher offers multiple custom-finishing options in an easy-to-use device. You can produce complete, professional-looking documents in-house in a single step, eliminating the time and expense involved in sending documents out to professional finishing services.

You can use the device to stack, staple, saddle stitch, and fold large quantities of documents on demand. The HP Multifunction Finisher has the following features:

- It supports up to 50 pages per minute (ppm).
- It offers a choice of staple positions:
  - One or two staples (at the top left, for portrait and landscape orientation)
  - Two side staples (on the trailing edge of the media)
- It staples up to 50 sheets of A4- and letter-size paper per document.
- It staples up to 25 sheets of A3- and ledger-size paper per document.
- It folds single pages.
- It saddle stitches and folds booklets composed of up to 10 sheets of paper (40 pages).
- It provides high-capacity stacking for up to 1,000 sheets of A4- and letter-size paper or up to 500 sheets of A3- and ledger-size paper.
- It provides stacking for transparencies, envelopes, labels, and prepunched and cut-sheet paper.
- It stacks up to 40 booklets composed of up to 5 sheets (20 finished pages) of A3- and ledger-size paper.
- It allows selection of cover stock up to 199 g/m<sup>2</sup> (53 lb) in weight.
- It arranges documents using time-saving job offsets.



## Identify the HP Multifunction Finisher parts

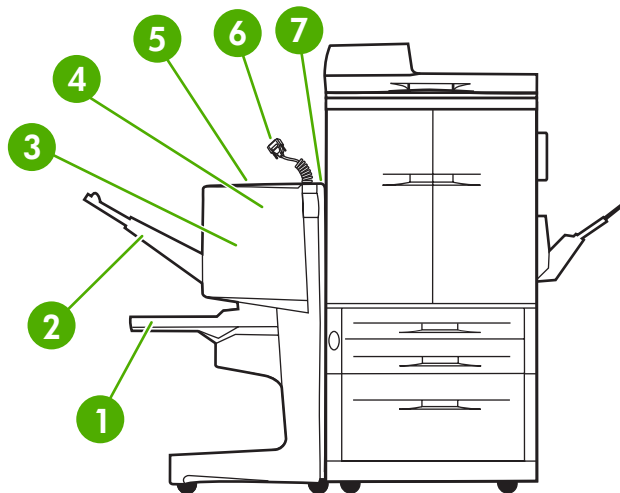

- |   |  |
|---|--|
| 1 | <b>Booklet bin:</b> This bin stacks up to 40 booklets composed of up to 5 sheets (20 finished pages) of A3- and ledger-size paper.   |
| 2 | <b>Stacker bin:</b> This bin holds up to 1,000 sheets of A4- and letter-size paper or up to 500 sheets of A3- and ledger-size paper. |
| 3 | <b>Folding area:</b> The area that folds the jobs.   |
| 4 | <b>Stapler unit:</b> The area that staples the jobs.   |
| 5 | <b>Paper path:</b> The area that receives the paper from the printer. Paper jams might need to be cleared from this area.            |
| 6 | <b>Jet-Link Connector:</b> This connector enables the communication between the printer or MFP and the HP Multifunction Finisher.    |
| 7 | <b>Flipper assembly:</b> The area that receives paper from the printer.  |

# Light patterns

**Figure 1-1** Location of LED light

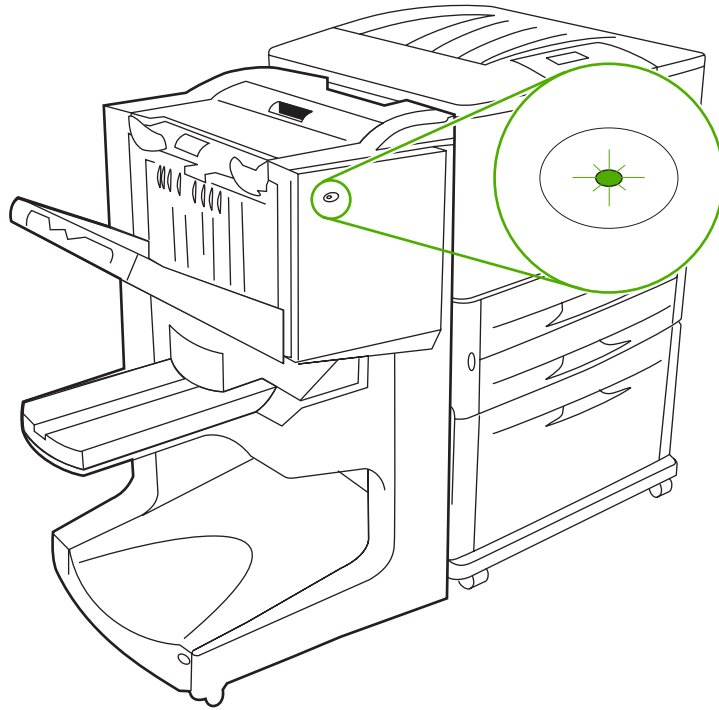

**NOTE:** Your printer or MFP model might differ from the one shown.

The user LED light, located on the front of the device, indicates a general error status. Use the following table to interpret device status using the LED light.

**Table 1-1** User LED light patterns

Light status	Interpretation
Green solid	The device is operating normally.
Green blinking	The device is in Service Mode.
Amber blinking	The device has a paper jam, a staple jam, or an operation error. Or, the device is detached from the printer.
Amber solid	The device has a malfunction.
Off	The device is off.

**NOTE:** The service LED lights, located on the back of the device, give specific error information for customer support and service agents. If the red service LED light is on, consult a service professional.

# Compatibility with HP LaserJet 9000 Series products

The HP Multifunction Finisher is compatible with the following devices:

- HP LaserJet 9040
- HP LaserJet 9050
- HP LaserJet 9040mfp
- HP LaserJet 9050mfp
- HP Color LaserJet 9500
- HP Color LaserJet 9500mfp Series products
- HP LaserJet M9040 MFP
- HP LaserJet M9050 MFP

For the HP Multifunction Finisher to work with the HP LaserJet 9000 and 9000mfp Series products, perform the following steps to update the firmware:

1. Find the firmware files for your printer at <http://www.hp.com/>. The following are the latest firmware versions:
  - HP LaserJet 9000 printer: 02.516.0A or later
  - HP LaserJet 9000Lmfp and 9000mfp: 03.801.1 or later

---

 **NOTE:** These firmware versions install the required HP Multifunction Finisher 031010 version firmware during the firmware update to allow the Multifunction Finisher to work with the HP LaserJet 9000 and 9000mfp Series products.

---

2. Open the HP Printer Utility.
3. In the **Configuration Settings** list, select **Firmware Update**.
4. Click **Choose**, navigate to the firmware file to upload, and click **OK**.
5. Click **Upload** to update the firmware files.

# Attach the HP Multifunction Finisher

**⚠ WARNING!** To avoid a malfunction, do not attach the HP Multifunction Finisher by pushing on the stacker tray. A 66.12.36 error message might appear if the device is attached incorrectly.

**Figure 1-2** Attaching the HP Multifunction Finisher - Incorrect method

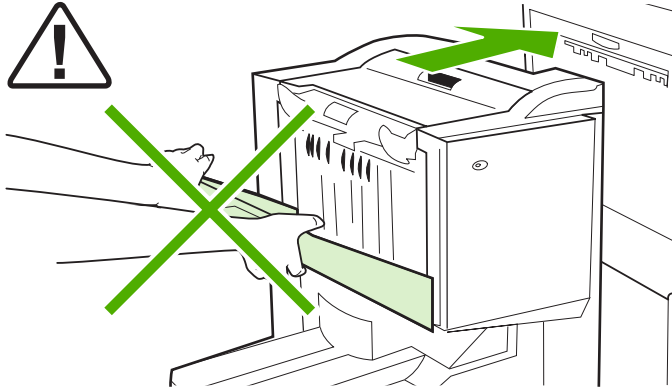

To attach the HP Multifunction Finisher, hold the device on both sides of the side cover, and push the device towards the printer.

**Figure 1-3** Attaching the HP Multifunction Finisher - Correct method

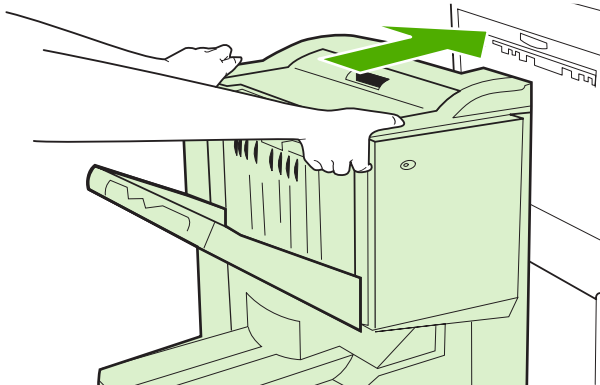

---







## 2 Finisher tasks

- [Configure default control-panel settings](#)
- [Configure the printer driver to recognize the HP Multifunction Finisher](#)
- [Booklet printing with the HP Multifunction Finisher](#)
- [Use the stapler](#)
- [Choose the output bin](#)

# Configure default control-panel settings

Change the default job offset, default stapler actions, and default fold line adjustments through the control panel.

## Configure control-panel settings on the HP LaserJet 9050, HP LaserJet 9040mfp, HP LaserJet 9050mfp, HP Color LaserJet 9500, and HP Color LaserJet 9500mfp Series

1. Press  to enter the menus.
2. Use  and  to scroll to **CONFIGURE DEVICE**, and press .
3. Use  and  to scroll to **MULTIFUNC. FINISHER**, and press .

## Configure control-panel settings on the HP LaserJet M9040 MFP and HP LaserJet M9050 MFP

1. Scroll to and touch **Administration**.
2. Scroll to and touch **Device Behavior**.
3. Scroll to and touch **Multifunct. Finisher**.

The following tables describe the control-panel settings for the HP Multifunction Finisher.

 **NOTE:** The system administrator can limit access to the job offset and default stapler actions.

**Table 2-1 OFFSET**

No	When the <b>OFFSET</b> mode is off, all of the jobs are stacked with no separation.
Yes	When the <b>OFFSET</b> mode is on, the device automatically separates complete jobs or mopies (multiple original prints of a single job). Each job or mopy is separated by setting the jobs apart from each other (for unstapled jobs).

 **NOTE:** The offset function is available only in the stacker bin (bin 1) and only for jobs that are not stapled. You can select the available stapler action through the printer driver (for example, use of one staple or two staples).

**Table 2-2 STAPLES**

NONE	If the default action is set to <b>NONE</b> , the job is not stapled.
ONE	If the default action is set to <b>ONE</b> , the staple is placed in the top left corner of the document. If you are printing in landscape format, the staple location is automatically adjusted for placement in the top left corner of the landscape layout.
TWO	If the default action is set to <b>TWO</b> , two staples are used with one job or with mopies. Both staples are placed parallel to the edge closest to the printer (the trailing edge).

**Table 2-3 STACK OPTION**

Face Up	If the default action is set to <b>FACE UP</b> , all of the printing jobs are stacked face-up.
Face Down	If the default action is set to <b>FACE DOWN</b> , all of the printing jobs are stacked face-down.

**Table 2-4 FOLD LINE ADJUST**

FOLD LINE ADJUST LTR-R and A4-R	Select <b>LTR-R &amp; A4-R</b> to adjust the fold line for 8.5 x 11-inch or 8.26 x 11-inch sheets.
FOLD LINE ADJUST LEGAL and JISB4	Select <b>LEGAL &amp; JISB4</b> to adjust the fold line for 8.5 x 14-inch or JIS B4 sheets.
FOLD LINE ADJUST 11 by 17 and A3	Select <b>11x17 &amp; A3</b> to adjust the fold line for 11 x 17-inch or A3 sheets.

Adjust the fold-line position depending on the sheet size. Adjustments are in +/- .15 mm (0.006 inch) increments, with a maximum range of +/- 2.1 mm (0.082 inch).

 **NOTE:** If the fold line and the stitch position do not match, call for service.

**Table 2-5 STAPLES OUT**

Continue	If the default action is set to <b>CONTINUE</b> , the multifunction finisher continues handling jobs from the printer that require staples even if the stapler cartridge is empty.
Stop	If the default action is set to <b>STOP</b> , the multifunction finisher goes offline until a new stapler cartridge is loaded when jobs from the printer require staples. See <a href="#">Load the stapler cartridge on page 17</a> .

**Table 2-6 SADDLE STITCH**

**NOTE:** This option is available only for color printers or MFPs.

Two Staples	If the default action is set to <b>TWO STAPLES</b> , all of the jobs sent to bin 2 are saddle stitched with two staples.
Four Staples	If the default action is set to <b>FOUR STAPLES</b> , all of the jobs sent to bin 2 are saddle stitched with four staples.

# Configure the printer driver to recognize the HP Multifunction Finisher

## Windows

 **NOTE:** To take full advantage of the paper-handling capabilities of the printer/MFP, set the operation mode in the printer driver for each user.

1. For Windows 2000, Windows XP, Windows Server 2003, and Windows Vista computers in classic view, click the **Start** button, point to **Settings**, and then click **Printers**.

For Windows XP and Windows Server 2003 computers in default view, click the **Start** button, and then click **Printers and Faxes**.

For Windows Vista computers in default view, click the **Start** button, click **Control Panel**, and then click **Printer** under the **Hardware and Sound** category.

2. Select the printer model.
3. Click **File**, and then click **Properties**.
4. Click the **Device Settings** tab.
5. Use either of the following methods to select the HP Multifunction Finisher:
  - Scroll down to **Automatic Configuration**, select **Update Now**, and click **Apply**.
  - Scroll down to **Accessory Output Bin**, select **HP Multifunction Finisher**, and click **Apply**.

## Macintosh

1. Open the Printer Center utility.
2. Select the printer model.
3. Click **File**, and then click **Show Info** (X + I).
4. Click the **Installable Options** tab.
5. Scroll to **Accessory Output Bins**, and select **HP Multifunction finisher**.
6. Click **Apply Changes**.



# Booklet printing with the HP Multifunction Finisher

This section explains the steps involved in creating a booklet in the printer driver, and provides the steps for Windows® and Macintosh computers.

 **NOTE:** Automatic folding and stapling of a booklet requires the HP Multifunction Finisher. If the printer does not have the HP Multifunction Finisher, the printer can print the pages in the correct order, and the pages can then be folded and stapled or bound manually.

---

## About booklet printing

It is possible to gain access to the automatic booklet-printing feature in some software programs, such as desktop-publishing programs. See the documentation that came with the software program for information about making booklets.

If you are using a software program that does not support making booklets, you can create booklets by using HP printer drivers.

 **NOTE:** HP recommends that you use the software program to prepare and preview the document for printing, and then use the printer driver to print and saddle stitch the booklet.

---

The following steps are involved in creating a booklet in the printer driver:

- **Preparing the booklet:** Arrange the pages on a sheet (booklet imposition) to create a booklet. Arrange the document in the software program or use the booklet-printing feature in the HP printer driver.
- **Adding a cover:** Add a cover to the booklet by selecting a different first page that uses a different paper type. A cover of the same paper type as the booklet can also be used. Booklet covers must be the same size as the remainder of the sheets. However, the covers can be printed on a paper type that is different from the remainder of the booklet.
- **Saddle stitching:** Media must be fed into the printer short-edge first. The finisher staples the center of the booklet (saddle stitching), and then folds the booklet. If the booklet is only one sheet of paper, the finisher folds the sheet but does not staple it. If the booklet consists of more than one sheet of paper, the finisher staples and then folds up to 10 sheets per booklet.

Use the booklet feature of the HP Multifunction Finisher to saddle stitch and fold booklets composed of the following media sizes:

- A3
- A4 (labeled A4-R)
- Letter (labeled letter-R)
- Legal
- 11 x 17 (ledger)

## Print a booklet on Windows 2000, Windows XP, Windows Server 2003, and Windows Vista computers

Use the following steps to print a booklet from a software program on Windows computers.

---

 **NOTE:** The following procedure changes the printer settings temporarily for a print job. After the document prints, the printer settings return to the defaults that are configured in the printer driver. To change the printer default settings, see [Change default settings on Windows computers on page 14](#).

---

1. In the software program, open the document to be printed.
2. Click **File**, and then click **Print**.
3. Select the printer.
4. Click **Preferences** or **Properties**.
5. Click the **Finishing** tab, and select a number from **Print on Both Sides**.
6. Select **Flip Pages Up**, if necessary.
7. On the **Booklet Layout** drop-down menu, select the booklet layout. The image to the right of the menu illustrates the layout.
8. Click **OK**.

## Print a booklet on Macintosh computers

Use the following steps to print a booklet from a software program on Macintosh computers.

Before printing a booklet for the first time, make sure that the HP Manual Duplex and Booklet software has been installed. This software requires a custom installation and is available for Mac OS 9.2.2 and earlier.

---

 **NOTE:** Mac OS X cannot print a booklet, but you can still use the HP Multifunction Finisher as an output device.

---

1. In the software program, open the document to be printed.
2. Click **File**, and then click **Print**.
3. Select **Layout**.
4. Click **Print on Both Sides**.
5. On the drop-down menu, select **Plug-In Preferences**, select **Print-Time Filters**, and select **Booklet**.
6. Click **Save Settings**.
7. Click **Booklet Printing**.
8. Click **Format Booklet**.
9. On the drop-down menu, select the paper size.
10. Click **Print**.

## Layout options for printing on both sides of the paper

The available print layout options are shown in [Figure 2-1 Printing left-to-right \(note the page numbers\) on page 13](#) and [Figure 2-2 Printing right-to-left \(note the page numbers\) on page 13](#). Select the binding and orientation options for the print job from the page setup options of the software program, if possible

 **NOTE:** The terminology that is used to describe layout in [Figure 2-1 Printing left-to-right \(note the page numbers\)](#) on [page 13](#) might be different for different programs.

If it is not possible to set these options in the page setup options of the software program, set them in the printer driver.

**Figure 2-1** Printing left-to-right (note the page numbers)

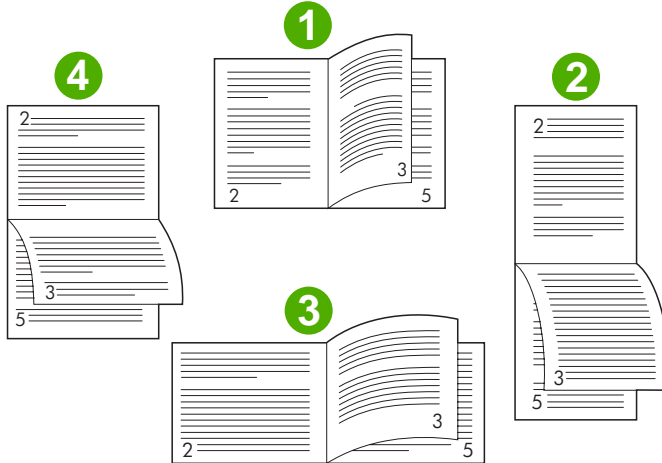

1	Long-edge portrait (default)
2	Short-edge portrait
3	Short-edge landscape
4	Long-edge landscape

**Figure 2-2** Printing right-to-left (note the page numbers)

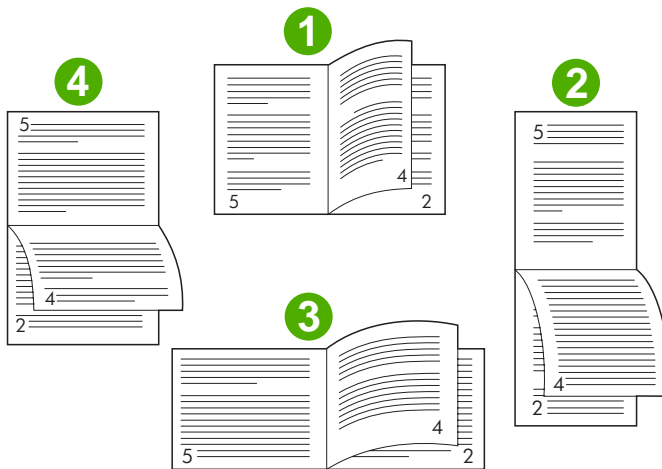

1	Long-edge portrait (default)
2	Short-edge portrait

---

3	Short-edge landscape
4	Long-edge landscape

---

## Change default settings on Windows computers

Use the following procedures to change the default settings in the printer driver for all software programs used on the computer.

Use the following steps for Windows 2000, Windows XP, Windows Server 2003, and Windows Vista computers.

1. For Windows 2000, Windows XP, Windows Server 2003, and Windows Vista computers in classic view, click the **Start** button, point to **Settings**, and then click **Printers**.

For Windows XP and Windows Server 2003 computers in default view, click the **Start** button, and then click **Printers and Faxes**.

For Windows Vista computers in default view, click the **Start** button, click **Control Panel**, and then click **Printer** under the **Hardware and Sound** category.

2. Right-click the printer icon.
3. Click **Printing Preferences**.
4. Change any of the settings on the tabs. These settings become the defaults for the printer.
5. Click **OK** to save the settings.

## Select a booklet cover using Microsoft Windows

1. Click **File**, click **Print**, and then click **Properties**.
2. Select the printer.
3. Click **Preferences** or **Properties**.
4. Click the **Paper** tab.
5. Click the **First Page** tab, and select the **Use different paper for first page** box.
6. On the **Size is**, **Source is**, and **Type is** menus, select the settings that correspond to the paper being used.
7. Use different paper and corresponding settings.

## Saddle stitch a booklet using Microsoft Windows

Use the following steps to saddle stitch a document for Windows 2000, Windows XP, Windows Server 2003, or Windows Vista.

1. Click **File**, click **Print**, and then click **Properties**.
2. Select the printer.
3. Click **Preferences** or **Properties**.

4. Select the **Output** tab.
5. Select **Fold & Stitch** under the **Staple** option of the **Output Option** section.

### Saddle stitch a booklet using Macintosh

1. Click **File**, and then click **Print**.
2. On the drop-down menu, click **Output Options**.
3. On the drop-down menu, click **Booklet Bin**.
4. Click **Fold/Saddle Stitch**.

## Use the stapler

The device can staple documents consisting of a minimum of two pages and a maximum of 50 pages of 75-g/m<sup>2</sup> (20-lb) Letter or A4 paper (a maximum of 25 pages for Ledger or A3 paper). The pages must be 64 to 199 g/m<sup>2</sup> (17 to 53 lb) in weight for any paper size that the device supports.













- The stacker bin can hold up to 1,000 sheets stacked (without staples).
- Heavier or coated media might have a stapling limit of fewer than 50 pages.
- If the job you want to have stapled consists of only one sheet, or if it consists of more than 50 sheets, the device delivers the job to the bin without staples.

## Select the stapler

You usually can select the stapler through your program or driver, although some options might be available only through the driver.

Where and how you make selections depends on your program or driver. If you cannot select the stapler from the program or driver, select the stapler from the control panel.

### HP LaserJet 9040/9050 and HP Color LaserJet 9500

1. Press  to enter the menus.
2. Use  and  to scroll to **CONFIGURE DEVICE** and press .
3. Use  and  to scroll to **MULTIFUNC. FINISHER** and press .
4. Use  and  to scroll to **Staples** and press .
5. Use  and  to scroll to the desired stapling option and press .

Your stapling options are None, One, or Two staples.

### HP LaserJet 9040mfp/9050mfp and HP Color LaserJet 9500mfp

1. Touch **Copy Settings**.
2. At the Staple menu, touch **Corner** or **Edge**, depending on where you want the documents stapled, and then touch **OK**. If you selected **Booklet** from the **Copies per Page** menu, your stapling options are **None**, **One**, **Two**, and **Saddle Stitch**.

 **NOTE:** The page icon on the right side of the touch screen shows the position of the staple.

### HP LaserJet M9040 MFP and HP LaserJet M9050 MFP

1. Scroll to and touch **Administration**.
2. Scroll to and touch **Device Behavior**.
3. Scroll to and touch **Multifunct. Finisher**.
4. Touch **Staples**
5. Touch the desired stapling option, and then touch **Save**

Your stapling options are None, One, or Two staples.

## Staple documents

### Windows

1. Click **File**, click **Print**, and then click **Properties**.
2. Select the printer.
3. Click **Preferences** or **Properties**.
4. On the **Output** tab, click the **Staple** drop-down list, and click the desired stapling option.

### Macintosh

1. On the **File** menu, click **Print** (Command + P).
2. Select the **Finishing** option.
3. For the **Output** destination, select **Stapler**.
4. In the **Finishing** option, select the desired stapling option.

## Load the stapler cartridge

The message **STAPLER LOW ON STAPLES** appears on the control panel if the stapler cartridge has 20 to 50 staples remaining. The message **STAPLER OUT OF STAPLES** appears on the control panel if the stapler cartridge contains no more staples.

1. Open the stapler-unit door.



2. Slide the stapler unit toward you.

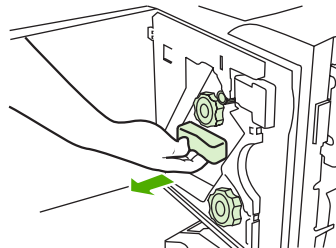

3. Turn the large green knob until you see the blue dot (this indicates that the stapler is fully open).

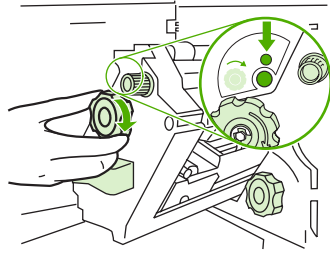

4. Turn the small green knob at the top of the stapler unit clockwise until the staple cartridge moves to the left of the stapler unit.

△ **CAUTION:** The blue dot must appear in the window of the stapler unit before you remove the staple cartridge. If you try to remove the staple cartridge before the blue dot appears in the window, you could damage the device.

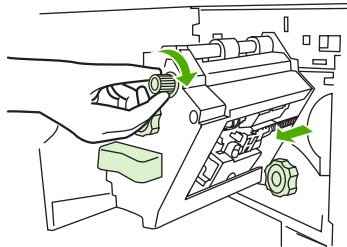

5. On the empty staple cartridge, squeeze the tabs together and pull the empty cartridge out.

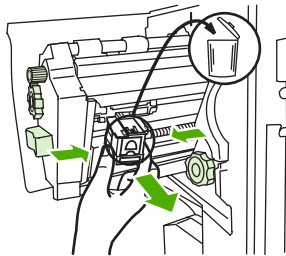

6. Insert the new staple cartridge so that it locks into place.

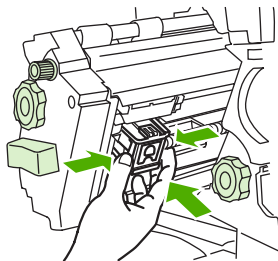



7. Slide the stapler unit into the device.

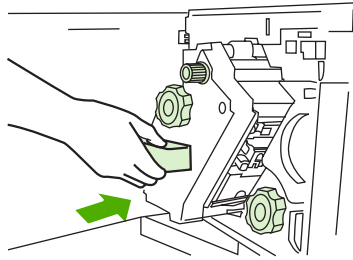

8. Close the stapler-unit door.



# Choose the output bin

## Identify the output bins

The device has two output locations: the stacker bin and the booklet bin.

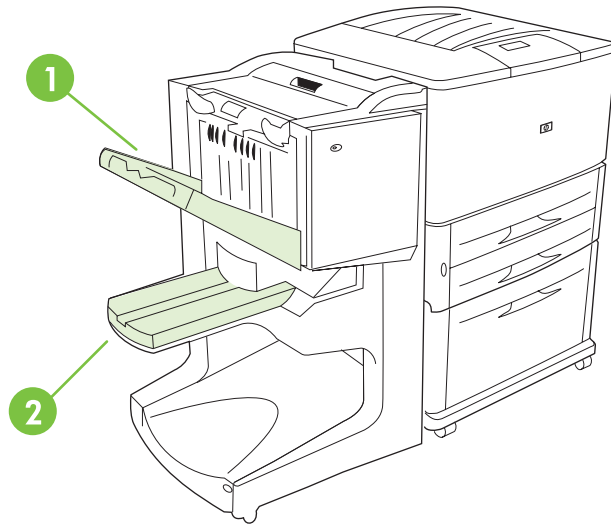

1	Stacker bin (bin 1)
2	Booklet bin (bin 2)

The default **stacker bin** (bin 1) provides 1,000 sheets of stacking capacity and delivers documents face-up or face-down, depending on which option is selected in the driver.

The **booklet bin** (bin 2) provides folding and saddle stitching for 40 booklets composed of up to 5 sheets (20 finished pages) of paper. A stacking guide automatically adjusts to accommodate the size of the booklet in production.

The stapler serves both bins, and staples as many as 50 sheets of paper per document or 10 pages per saddle-stitched document.

A sensor causes the printer to stop when the device bins are full. Operation continues when you remove all media from the bin.

 **NOTE:** Transparencies, envelopes, labels, prepunched paper and cut-sheet paper are supported in the stacker bin (bin 1).

**NOTE:** If you print envelopes, remove all envelopes from the bin once the job is complete to maintain stacking quality.

## Select the output location

You can select an output location (bin) through the software application or through your printer driver. (Where and how you make selections depends on your program or driver.) If you cannot select an output location from the program or the driver, set the default output location from the printer control panel.

### Select the output location for the HP LaserJet 9040/9050 and HP Color LaserJet 9500

1. Use ▲ or ▼ to scroll to **CONFIGURE DEVICE** and press ✓.
2. Use ▲ or ▼ to scroll to **PRINTING** and press ✓.
3. Use ▲ or ▼ to scroll to **PAPER DESTINATION** and press ✓.
4. Use ▲ or ▼ to scroll to the output bin or device you want and press ✓. Your network administrator might have changed the name of the device. An asterisk (\*) appears next to your selection.

### Select the output location for the HP LaserJet 9040mfp/9050mfp and HP Color LaserJet 9500mfp

1. Touch **MENU**.
2. Touch **CONFIGURE DEVICE**.
3. Touch **PRINTING**.
4. Touch **PAPER DESTINATION**.
5. Scroll to the output bin or device you want, and then touch **OK**. Your network administrator might have changed the name of the device. An asterisk (\*) appears next to your selection.

### Select the output location for the HP LaserJet M9040 MFP and HP LaserJet M9050 MFP

1. Scroll to and touch **Administration**.
2. Touch **Default Job Options**.
3. Touch **Default Copy Options** or **Default Print Options**.
4. Touch **Output Bin**.
5. Touch the desired output bin or device, and then touch **Save**.

Your stapling options are None, One, or Two staples.



---

# 3 Problem solving

- [Resolve common problems](#)
- [Control-panel messages](#)
- [Clear jams](#)

# Resolve common problems

**Table 3-1 Common device problems**

Situation	Possible Reason
The device does not turn on.	<ul style="list-style-type: none"><li>● Make sure that the power cord is firmly plugged into the 2,000-sheet input tray.</li></ul> <p><b>NOTE:</b> This does not apply to the HP Color LaserJet 9500mfp.</p> <ul style="list-style-type: none"><li>● Turn the printer off, check all the cable connections, and turn the printer on.</li></ul>
The printer does not recognize the device or the user LED on the device is off.	<ul style="list-style-type: none"><li>● Check the device power cord.</li><li>● Make sure that the device has been configured in the printer driver.</li><li>● Check the HP Jet-Link connector.</li><li>● Print a configuration page to see if the device is operating normally.</li><li>● If the printer still does not recognize the device, contact your local authorized HP service provider. (See <a href="#">Service and support on page 45.</a>)</li></ul>
The job was not stapled.	<ul style="list-style-type: none"><li>● The stapler is out of staples and <b>AUTO CONTINUE</b> is set to <b>ON</b>. See <a href="#">Load the stapler cartridge on page 17</a> for more information.</li><li>● A single-page job was sent to the stapler; one-page jobs are not stapled.</li><li>● The wrong size or type of paper was used for the job.</li><li>● More than 50 sheets of 75-g/m<sup>2</sup> (20-lb) media were sent to the stapler, exceeding its capacity.</li></ul> <p><b>NOTE:</b> Transparencies, envelopes, labels, and cut-sheet paper are supported in the stacker bin. The stapler can staple jobs of 2 to 50 sheets of 75-g/m<sup>2</sup> (20-lb) media. If the job is thicker than this, the job is ejected unstapled. The stacker bin can hold a maximum of 1,000 sheets, depending on the paper size and weight.</p> <ul style="list-style-type: none"><li>● The stapler has bent or broken staples in the stapler head.</li><li>● A staple jam exists, or a staple jam was recently cleared (up to two sequential jobs might not be stapled).</li><li>● The job was sent to a bin other than the stapler bin because the wrong size or type of paper was used for the job.</li><li>● The interface cable to the stapler unit might be defective or is not connected properly.</li></ul>

**Table 3-1 Common device problems (continued)**

Situation	Possible Reason
The job went to a different output location than expected.	<ul style="list-style-type: none"><li>• The paper does not meet the specifications for the output bin. (See <a href="#">Specifications on page 35</a>, or go to .)</li><li>• Make sure that the correct output bin is selected in the printer driver. For more information about changing printer driver settings, see your printer user guide.</li></ul>
The print media jams.	<ul style="list-style-type: none"><li>• Make sure that you are using the supported media weights and sizes. (See <a href="#">Supported media on page 39</a>.)</li></ul> <p data-bbox="879 512 1465 585">Using paper outside HP specifications might cause problems that require repair. This repair is not covered by the Hewlett-Packard warranty or service agreements.</p> <ul style="list-style-type: none"><li>• Check the cables and connectors between the printer and the device.</li><li>• Repeated jams that occur when print media travels between the printer and the device might mean that the printer and device are set up on an uneven floor. Level the device. See the device installation guide for instructions about leveling the device.</li></ul>
You are experiencing general repeated stapler jam problems.	<ul style="list-style-type: none"><li>• Check to see that the job to be stapled is less than 50 sheets thick.</li><li>• The stapler might have some trapped staple wires obstructing the cartridge. Remove loose staples and paper dust from the inside of the stapler. (See <a href="#">Clear a staple jam from the device on page 32</a>.)</li></ul>
You are experiencing general repeated booklet jam problems.	<ul style="list-style-type: none"><li>• The paper does not meet the specifications for the booklet bin. (See <a href="#">Specifications on page 35</a>, or go to <a href="http://www.hp.com/cposupport/">www.hp.com/cposupport/</a>.)</li><li>• To improve the quality of booklets, HP recommends that you use heavy media for the cover. If the booklets contain more than five pages, HP recommends including a 5-mm (0.19-inch) white margin at the seam.</li><li>• If booklet jams continue, contact your local authorized HP service provider. (See <a href="#">Service and support on page 45</a>.)</li></ul>

# Control-panel messages

The following table explains device messages that might appear on the control panel.

**Table 3-2 Control-panel messages**

Control panel message	Description	Recommended action
CLOSE FRONT DOOR ON LEFT ACCESSORY	The stapler door is open or is not closed correctly.	Close the stapler door correctly.
CLOSE TOP COVER ON LEFT ACCESSORY	The door is open or is not properly closed.	Close the top door.
DIFFERENT PAPER SIZES IN JOB	Different paper sizes are used for a single job.	Verify that all pages in the job are configured for the same size of paper.
FINISHING UNAVAILABLE	A failure has occurred with the finishing process.	Remove all media from the bins. If the error message reappears, record the message and call for support.
INSTALL BOOKLET BIN	The booklet bin is not correctly installed.	Verify that the booklet bin is correctly installed.
INSTALL STAPLER UNIT	The stapler unit is not correctly installed.	Verify that the stapler unit is correctly installed.
OPTIONAL BIN 01 FULL	The stacker bin is full.	Remove all media from the stacker bin.
OPTIONAL BIN 02 FULL	The booklet bin is full.	Remove all paper from the booklet bin.
OUTPUT PAPER PATH OPEN	The accessory on the left side is not correctly attached.	Verify that the accessory is correctly attached.
STAPLE AREA SAFETY PROTECTION ACTIVATED	A staple safety alert has occurred.	Remove any obstruction from the stacker bin ejection area.
STAPLER LOW ON STAPLES	The stapler cartridge has 20 to 50 staples remaining.	Replace the staple cartridge if you want to saddle stitch more than 10 sets in a job.
STAPLER OUT OF STAPLES	The stapler cartridge contains no more staples.	Replace the stapler cartridge.  See <a href="#">Load the stapler cartridge on page 17</a>
TOO MANY PAGES IN JOB TO STAPLE	The job height is greater than the stapler capacity. The height of the job to be stapled should not exceed 50 sheets of 20-lb bond.	Verify that the job is within specifications to be stapled. See <a href="#">Supported media on page 39</a>
TOO MANY PAGES TO MAKE BOOKLET	The page content is too large to be saddle stitched.	Verify that the job is within specifications to be saddle stitched.
13.12.11 - JAM IN STAPLER	A staple jam has occurred.	Check for a jammed staple in the staple cartridge.
13.12.21 - JAM IN LEFT ACCESSORY	A paper jam exists in the flipper assembly.	Check for jammed media in the output area of the printer or the input area of the device.
13.12.22 - JAM IN LEFT ACCESSORY		
13.12.23 - JAM IN LEFT ACCESSORY		
13.12.31 - JAM IN LEFT ACCESSORY	A paper jam exists in the paper-path area.	Check for jammed media in the output area of the printer or the input area of the device.
13.12.32 - JAM IN LEFT ACCESSORY		
13.12.33 - JAM IN LEFT ACCESSORY		
13.12.34 - JAM IN LEFT ACCESSORY		



**Table 3-2 Control-panel messages (continued)**

Control panel message	Description	Recommended action
13.12.41 - JAM IN LEFT ACCESSORY 13.12.42 - JAM IN LEFT ACCESSORY 13.12.43 - JAM IN LEFT ACCESSORY	A paper jam exists in the folding area.	Check for jammed media in the input area and the folding area of the device.
13.12.51 - JAM IN LEFT ACCESSORY 13.12.52 - JAM IN LEFT ACCESSORY 13.12.53 - JAM IN LEFT ACCESSORY	A paper jam exists in the booklet bin area.	Check for jammed paper in the booklet bin area and in the folding mechanism.
66.12.ZZ OUTPUT DEVICE FAILURE	A failure has occurred with the device.	Check cables and turn the product off and on again. If an error message reappears, record the message and call for support.
66.12.36	A failure has occurred because the device was attached incorrectly.	Remove and reattach the device, being careful not to hold the device by the stacker tray. See <a href="#">Attach the HP Multifunction Finisher on page 6</a>

## Clear jams

The following tasks explain what to do when a **JAM IN LEFT ACCESSORY** message or other jam-related messages appear on the control panel.

 **NOTE:** When clearing jams, be very careful not to tear the media. If even a small piece of media is left in the device, it can cause additional jams.

**Figure 3-1** Jam locations

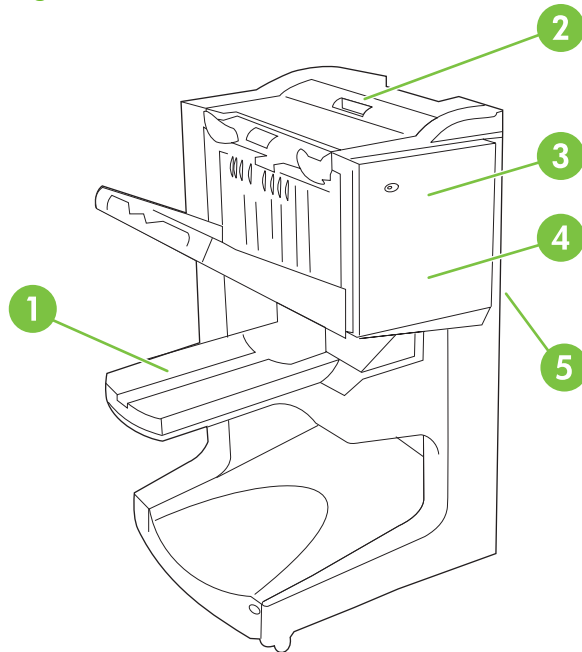

1	Booklet bin (bin 2)
2	Paper-path area
3	Stapler unit
4	Folding area
5	Flipper assembly

### Clear jams in the paper-path area of the multifunction finisher

1. Open the top cover.

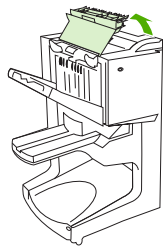

2. Slowly and carefully pull the paper straight out of the finisher so that it does not tear.

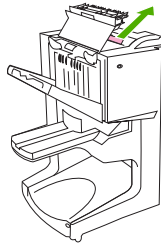

3. Close the finisher cover.

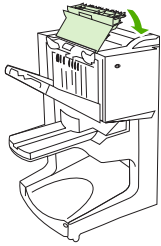

### Clear jams in between the multifunction finisher and the printer/MFP

1. Move the finisher away from the printer/MFP.

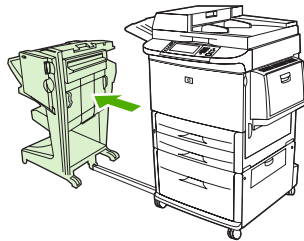

2. Carefully remove any paper from the printer/MFP output area.

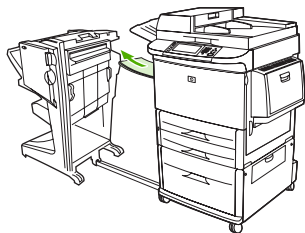

3. Carefully remove any paper from the finisher input area.

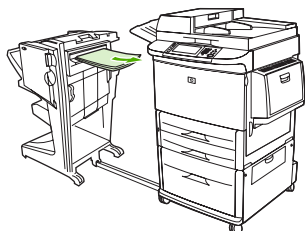

4. Push the multifunction finisher back into place.

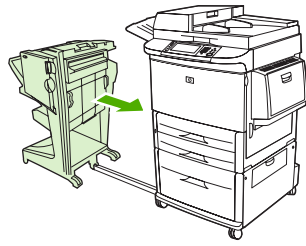

### Clear booklet jams in the multifunction finisher

1. Move the finisher away from the MFP.

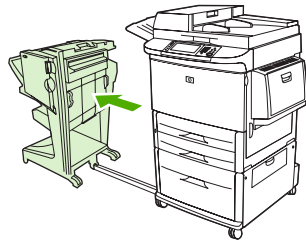

2. If paper is jammed in the finisher input area but has not entered the folding rollers, carefully remove the paper from the input area and then skip to step 7.

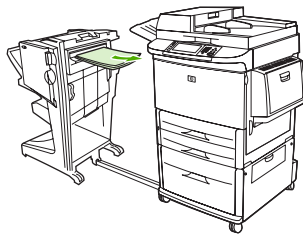

3. Open the back door on the finisher. If jammed paper inside the finisher has not entered the folding rollers, remove the paper and then skip to step 7. If the paper has entered the folding rollers, proceed to step 4.

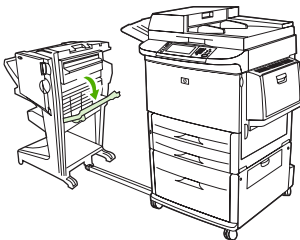

4. Open the stapler-unit door.

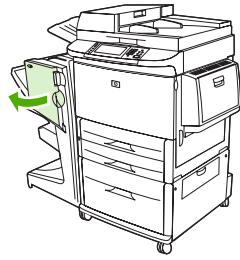

5. Turn the bottom green knob clockwise to advance the jammed paper through the folding rollers and into the booklet bin.

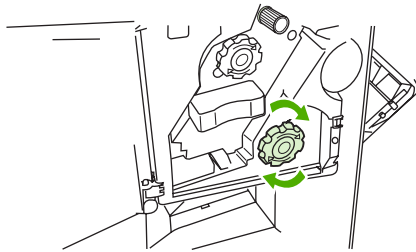

6. Close the stapler-unit door.

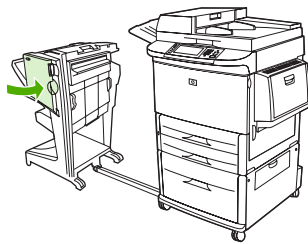

7. Push the multifunction finisher back into place.

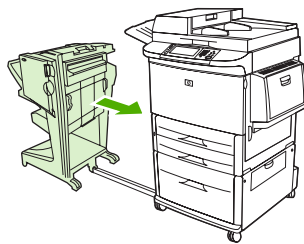

## Clear a staple jam from the device

1. Open the stapler-unit door.



2. Slide the stapler unit toward you.

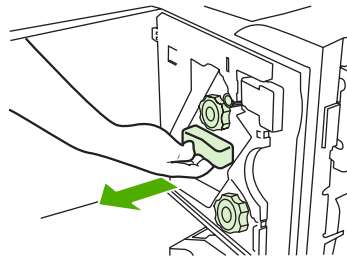

3. Turn the large green knob until you see the blue dot (this indicates that the stapler is fully open).

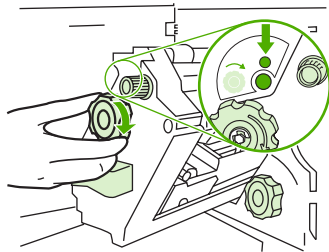

4. Turn the small green knob at the top of the stapler unit clockwise until the staple cartridge moves to the left of the stapler unit.

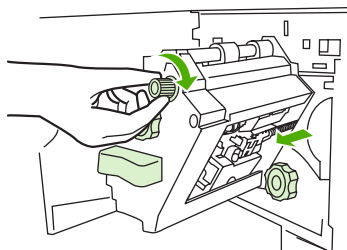

---

△ **CAUTION:** The blue dot must appear in the window of the stapler unit before you remove the staple cartridge. If you try to remove the staple cartridge before the blue dot appears in the window, you could damage the device.

---

5. Remove the staple cartridge.

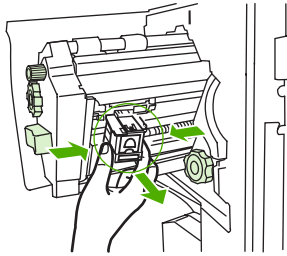

6. Pull up on the lever labeled with a green dot.

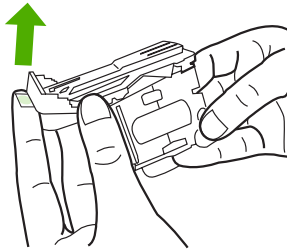

7. Remove the damaged staple.

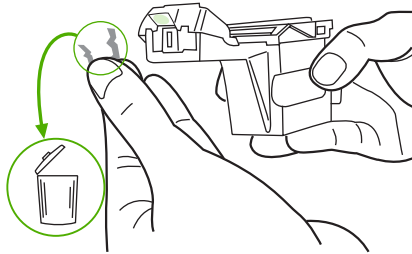

8. Press down on the lever labeled with a green dot.

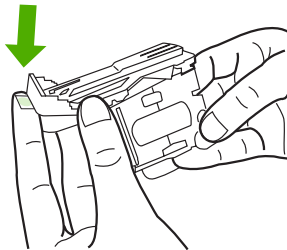

9. Reinstall the staple cartridge.

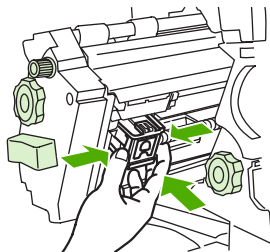

10. Slide the stapler unit into the device.

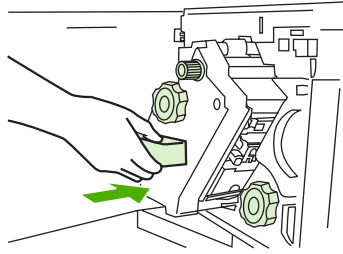

11. Close the stapler-unit door.



### Clear a jam in the upper half of the stapler head

1. Follow steps 1 through 4 of the procedure to clear a staple jam.
2. Locate the damaged staple at the back of the stapler head, and remove the staple.

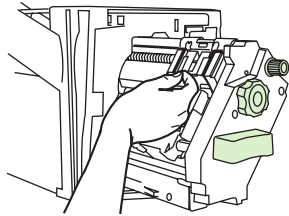

3. Follow steps 10 through 11 from the procedure to clear a staple jam.



---

# A Specifications

- [Physical specifications](#)
- [Environmental specifications](#)

## Physical specifications

Prepare a location for the device that allows for the following physical and environmental requirements, in addition to the requirements for your printer.

 **NOTE:** The drawings shown are not to scale.

**Figure A-1** HP Multifunction Finisher (side view)

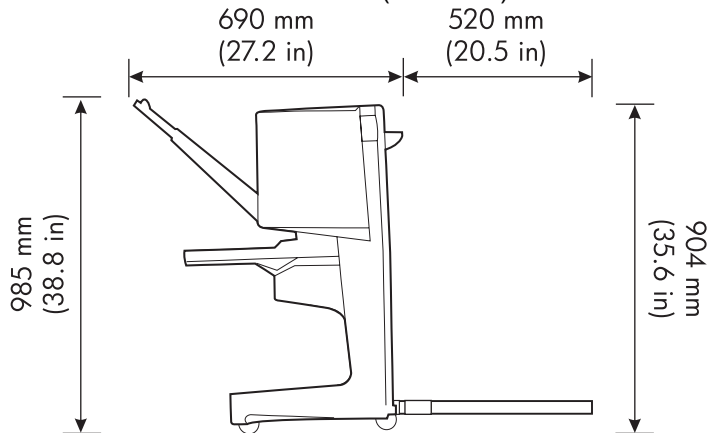

**Figure A-2** HP Multifunction Finisher (top view)

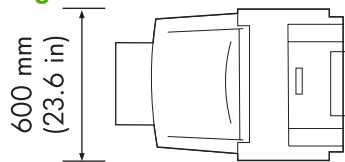

### Location requirements for the printer/MFP:

- A level area on the floor
- Space allowance around the printer
- A well-ventilated room
- No exposure to direct sunlight or chemicals, including ammonia-based cleaning solutions
- Adequate power supply (15 A, 110 V, or 220 V circuit located near the printer)
- A stable environment--no abrupt temperature or humidity changes
- Relative humidity of 10% to 80%
- Room temperature of 10° C to 32.5° C (50° F to 91° F)

Device weight of the HP Multifunction Finisher: 44.4 kg (98 lb)

# Environmental specifications

## Power consumption

Product state	Power consumption (average, in watts)	Power consumption with typical output device
Printing (110 to 127 V units) (220 to 240 V units)	1,075 watts 1,075 watts	1,130 watts 1,130 watts
Standby (110 to 127 V units) (220 to 240 V units)	440 watts 440 watts	485 watts 485 watts
PowerSave 1 (Fan is on) (110 to 127 V units) (220 to 240 V units)	70 watts 70 watts	115 watts 115 watts
Low power (100 to 127 V units) (220 to 240 V units)	230 watts 230 watts	275 watts 275 watts
Off (110 to 127 V units) (220 to 240 V units)	0.5 watts 1.3 watts	0.5 watts 1.3 watts
ADF copying/printing (110 to 127 V units) (220 to 240 V units)	1,130 watts 1,130 watts	1,185 watts 1,185 watts

## Power requirements

Power requirements (acceptable line voltage)	
110 to 127 V (+/- 10%)	50 to 60 Hz (+/- 2 Hz)
220 to 240 V (+/- 10%)	50 Hz (+/- 2 Hz)
220 V (+/- 10%)	60 Hz (+/- 2 Hz)

## Circuit capacity

Minimum recommended circuit capacity	
110 to 127 V	15.0 amps
220 to 240 V	6.5 amps

## Operating environment

Operating temperature	10° C to 32.5° C (50° F to 91° F)
Operating humidity	10% to 80% relative humidity
Storage temperature	0° C to 35° C (32° F to 95° F)
Storage humidity	10% to 95% relative humidity
Speed	50 ppm

## Protecting the environment

Hewlett-Packard Company is committed to providing quality products in an environmentally sound manner.

The HP Multifunction Finisher has been designed with several attributes that minimize impacts on the environment.

## Disposal of Waste Equipment by Users in Private Household in the European Union

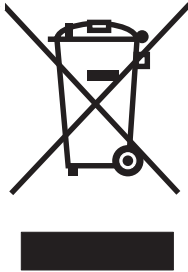

This symbol on the product or on its packaging indicates that this product must not be disposed of with your other household waste. Instead, it is your responsibility to dispose of your waste equipment by handing it over to a designated collection point for the recycling of waste electrical and electronic equipment. The separate collection and recycling of your waste equipment at the time of disposal will help to conserve natural resources and ensure that it is recycled in a manner that protects human health and the environment. For more information about where you can drop off your waste equipment for recycling, please contact your local city office, your household waste disposal service or the shop where you purchased the product

## Supported media types

The following types of media are supported by the multifunction finisher in the appropriate output bin:

- Plain paper
- Preprinted paper
- Letterhead (except raised letterhead and low-temperature inks)
- Transparencies
- Prepunched paper
- Labels
- Bond
- Recycled paper
- Color paper
- Card stock
- Rough paper
- Glossy paper

- Envelopes
- Cut-sheet paper
- User-defined paper (five types)

## Supported media

 **NOTE:** Transparencies, envelopes, prepunched, cut-sheet paper, and labels are only supported in bin 1.

**NOTE:** Custom paper sizes are not supported for booklet making.

**Table A-1 Supported media specifications**

Output bin and Stapler	Capacity	Media	Weight
Stacker bin (bin 1)	Up to 1,000 sheets, stacked, of Letter/A4  Up to 500 sheets, stacked, of Ledger/A3	<ul style="list-style-type: none"> <li>• Standard paper sizes: letter, legal, executive, ISO A3, ISO A4, ISO A5, JIS B4, JIS B5, ledger</li> <li>• Custom paper sizes: Minimum: 98 by 191 mm (3.9 by 7.5 inches) Maximum: 312 by 470 mm (12.2 by 18.4 inches)</li> <li>• Custom types: envelopes, labels, transparencies, heavy paper</li> <li>• Face-up bin only: envelopes, labels, heavy paper up to 216 g/m<sup>2</sup> (58 lb bond)</li> </ul>	64 to 216 g/m <sup>2</sup> (17 to 58 lb bond)
Booklet bin (bin 2)	Up to 40 booklets composed of 5 sheets	<ul style="list-style-type: none"> <li>• Standard paper sizes: letter, legal, ISO A3, ISO A4, JIS B4, ledger</li> </ul>	64 to 199 g/m <sup>2</sup> (17 to 53 lb bond)
Stapler	Maximum of 50 sheets of Letter/A4  Maximum of 25 sheets of Ledger/A3  <b>NOTE:</b> Stapling capacity varies depending on the paper thickness or the coating characteristics.	<ul style="list-style-type: none"> <li>• Letter, ISO A4, legal, ledger, A3, JIS B4</li> </ul>	64 to 199 g/m <sup>2</sup> (17 to 53 lb bond)

For more information about media guidelines, see the user guide supplied with your printer. Also see the *HP LaserJet Media Specification Guide* at [www.hp.com](http://www.hp.com).

**Table A-2 Number of sheets that can be stapled, listed by media weight**

Media weight	Letter/A4	Ledger/A3 and Legal/B4
64 g/m <sup>2</sup> (17 lb)	*50	*25

**Table A-2** Number of sheets that can be stapled, listed by media weight (continued)

Media weight	Letter/A4	Ledger/A3 and Legal/B4
75 g/m <sup>2</sup> (20 lb)	*50	*25
80 g/m <sup>2</sup> (21 lb)	*50	*25
90 g/m <sup>2</sup> (24 lb)	*44	*22
105 g/m <sup>2</sup> (28 lb)	*28	*14
163 g/m <sup>2</sup> (43 lb)	*18	*9
199 g/m <sup>2</sup> (53 lb)	*12	*6

\* Denotes approximate numbers

**Table A-3** Number of sheets that can be stapled and folded, listed by media weight

Media weight	Letter/A4, Ledger/A3 and Legal/B4
64 g/m <sup>2</sup> (17 lb) to 80 g/m <sup>2</sup> (21 lb)	Maximum of 10 sheets
90 g/m <sup>2</sup> (24 lb) to 105 g/m <sup>2</sup> (28 lb)	Maximum of 5 sheets
163 g/m <sup>2</sup> (43 lb) to 199 g/m <sup>2</sup> (53 lb)	Maximum of 1 sheet.

 **NOTE:** When making booklets using media weight of 64 g/m<sup>2</sup> (17 lb) to 80 g/m<sup>2</sup> (21 lb), one cover sheet up to 199 g/m<sup>2</sup> (53 lb) can be combined with the 10 sheets. Other combinations are not supported.

---

## B Regulatory information

- [Declaration of conformity](#)
- [FCC regulations](#)
- [Canadian DOC regulations](#)
- [VCCI statement \(Japan\)](#)
- [EMI statement \(Korea\)](#)
- [EMI statement \(Taiwan\)](#)

# Declaration of conformity

## Declaration of Conformity

according to ISO/IEC 17050-1 and EN 17050-1

**Manufacturer's Name:** Hewlett-Packard Company  
**Manufacturer's Address:** 11311 Chinden Boulevard,  
Boise, Idaho 83714-1021, USA

**declares, that the product**

**Product Name:** HP Multifunction Finisher  
**Model Number:** C8088A, C8088B  
**Product Options:** All

**conforms to the following Product Specifications:**

**Safety:** IEC 60950-1:2001 / EN60950-1: 2001 +A11  
GB4943-2001

**EMC:** CISPR22:2005 / EN 55022:2006 - Class A<sup>1, 2)</sup>  
EN 61000-3-2:2000  
EN 61000-3-3:1995 +A1  
EN 55024:1998 +A1 +A2  
FCC Title 47 CFR, Part 15 Class A / ICES-003, Issue 4  
GB9254-1998, GB17625.1-2003

### Supplementary Information:

The product herewith complies with the requirements of the EMC Directive 2004/108/EC and the Low Voltage Directive 2006/95/EC, and carries the CE-Marking accordingly.

This Device complies with Part 15 of the FCC Rules. Operation is subject to the following two Conditions: (1) this device may not cause harmful interference, and (2) this device must accept any interference received, including interference that may cause undesired operation.

1) The product was tested in a typical configuration with Hewlett-Packard Personal Computer Systems.

2) The product meets the requirements of EN55022 & CNS13438 Class A in which case the following applies: "Warning – This is a class A product. In a domestic environment this product may cause radio interference in which case the user may be required to take adequate measures".

Boise, Idaho , USA

**January 25, 2007**

### For regulatory topics only:

**European Contact:** Your Local Hewlett-Packard Sales and Service Office or Hewlett-Packard GmbH, Department HQ-TRE / Standards Europe, Herrenberger Straße 140, D-71034 Böblingen, Germany, (FAX: +49-7031-14-3143)

**USA Contact:** Product Regulations Manager, Hewlett-Packard Company, PO Box 15, Mail Stop 160, Boise, ID 83707-0015, , (Phone: 208-396-6000)



## FCC regulations

This equipment has been tested and found to comply with the limits for a Class A digital device, pursuant to Part 15 of the FCC rules. These limits are designed to provide reasonable protection against harmful interference in a residential installation. This equipment generates, uses, and can radiate radio frequency energy. If this equipment is not installed and used in accordance with the instructions, it may cause harmful interference to radio communications. However, there is no guarantee that interference will not occur in a particular installation. If this equipment does cause harmful interference to radio or television reception, which can be determined by turning the equipment off and on, the user is encouraged to try to correct the interference by one or more of the following measures:

- Reorient or relocate the receiving antenna.
- Increase separation between equipment and receiver.
- Connect equipment to an outlet on a circuit different from that to which the receiver is located.
- Consult your dealer or an experienced radio/TV technician.

---

 **NOTE:** Any changes or modifications to the printer that are not expressly approved by HP could void the user's authority to operate this equipment.

Use of a shielded interface cable is required to comply with the Class A limits of Part 15 of FCC rules.

## Canadian DOC regulations

Complies with Canadian EMC Class A requirements.

« Conforme à la classe A des normes canadiennes de compatibilité électromagnétiques. « CEM ». »

## VCCI statement (Japan)

この装置は、情報処理装置等電波障害自主規制協議会（VCCI）の基準に基づくクラスA情報技術装置です。この装置を家庭環境で使用すると電波妨害を引き起こすことがあります。この場合には使用者が適切な対策を講ずるよう要求されることがあります。

## EMI statement (Korea)

A급 기기 (업무용 정보통신기기)

이 기기는 업무용으로 전자파적합등록을 한 기기이오니 판매자 또는 사용자는 이 점을 주의하시기 바라며, 만약 잘못판매 또는 구입하였을 때에는 가정용으로 교환하시기 바랍니다.

## EMI statement (Taiwan)

警告使用者：

這是甲類的資訊產品，在居住的環境中使用時，可能會造成射頻干擾，在這種情況下，使用者會被要求採取某些適當的對策。

---

# C Service and support

## World Wide Web

Solutions to most issues can be found at [www.hp.com](http://www.hp.com). The HP Web site includes frequently asked questions (FAQ), troubleshooting help, information about maintenance and use, and manuals for the following products that can be used with the HP Multifunction Finisher:

- HP LaserJet 9040
- HP LaserJet 9050
- HP LaserJet 9040mfp
- HP LaserJet 9050mfp
- HP Color LaserJet 9500
- HP Color LaserJet 9500mfp Series products
- HP LaserJet M9040 MFP
- HP LaserJet M9050 MFP

## Warranty information

See the warranty booklet that came with your printer or HP Multifunction Finisher for warranty information.



---

# Index

## A

- A3 paper
  - stapling capability by weight 39
  - stapling capability by weight, booklets 40
- accessories
  - control panel messages 26
- adhesive labels 20
- amber light
  - interpreting 4
  - troubleshooting 24

## B

- benefits of product 2
- bent staples in stapler head 24
- bins
  - description 20
  - error messages 26
  - location 20
  - media supported 39
  - selecting 20
  - troubleshooting 25
- blinking lights
  - interpreting 4
  - troubleshooting 24
- booklet bin
  - description 20
  - media supported 39
  - selecting 20
  - troubleshooting 25
- booklets
  - error messages 26
  - features 2
  - layout options for both sides of paper 12
  - media supported 11, 39
  - printing 11
  - saddle stitching 14

- selecting covers 14
- stapling capability by media weight 40

## C

- Canadian DOC regulations 44
- cardstock
  - stapling 16
  - supported sizes 39
- cartridge, stapler
  - error messages 26
  - troubleshooting 25
- circuit capacity 37
- clearing jams
  - stapler head 34
- compatibility with other devices 5
- configuring printer driver 10
- consumption of power 37
- control panel
  - default settings 8
  - staple options 16
  - troubleshooting messages 26
- Corner Staple option 8
- custom media sizes
  - supported 39
- customer support
  - warranty 45
- cut-sheet paper 20

## D

- default printer driver settings, changing 14
- device not recognized 24
- drivers
  - using to select stapler 16
  - using to select stapling functions 8

## E

- electrical specifications
  - power requirements 37
- energy consumption 37
- environmental specifications 36, 37
- error messages 26

## F

- FCC regulations 43
- frequent
  - media jams 25
  - stapler jams 25

## H

- heavy media
  - supported types 38
- humidity specifications 36, 37

## I

- identifying parts 3

## J

- jams
  - troubleshooting 25
- jams, paper
  - multifunction finisher 28, 29, 30
- Japanese VCCI statement 44
- jobs
  - offset mode 8
  - stacking with or without separation 8

## K

- Korean EMI statement 44

## L

- location
  - booklet and stacker bins 20

- placement of staples 8
- saddle stitch positions 9
- selecting for output 20

## M

### media

- error messages 26
- HP LaserJet Media Specification Guide 39
- stapling capability by weight 39
- stapling capability by weight, booklets 40

## O

### offset mode

- limiting access 8

### options

- stapler 8, 16

## P

- pages per minute (ppm) 2

### paper

- stapling capability by weight 39

- paper-handling features 2

### power

- circuit capacity 37
- requirements 37
- troubleshooting 24

### print media

- HP LaserJet Media Specification Guide 39

- problems, resolving common 24

## R

- red service LED light on 4

- regulatory information 41

## S

### saddle stitching

- features 2

- service and support 45

### size specifications

- HP Multifunction Finisher 36

### specifications

- media 38, 39

### stacking

- with no separation 8

### stapler

- media supported 39

### stapling

- performing 17

- troubleshooting 24, 25

- stitching. See saddle stitching

- storage specifications 37

## T

- Taiwan EMI statement 44

### troubleshooting

- common problems 24

## W

### weight specifications

- HP Multifunction Finisher 36



© 2007 Hewlett-Packard Development Company, L.P.

[www.hp.com](http://www.hp.com)



C8088-90909