

Limited Warranty and Support Guide

Before contacting the HP Customer Care Center, it's important to have the following information handy.

Please take a moment to write down your product information for future reference.

The first four items on the list (Model Number, Product Number, Serial Number, and Software Build Number) can be viewed through the Help and Support Center. Click the **Windows Start Button, Help and Support**, and then click **System Information**.

Model Number: _____

System (Product) Number: _____

Serial Number: _____

Software Build Number: _____

Operating System: _____

Purchase Date: _____

Hardware Limited Warranty

HP Product	Duration
Hardware	One-year limited warranty One-year technical support

General Terms

This HP Hardware Limited Warranty gives you, the customer, express limited warranty rights from Hewlett-Packard, the manufacturer. Please refer to HP's Web site for an extensive description of your limited warranty entitlements. In addition, you may also have other legal rights under applicable local law or special written agreement with HP.

HP MAKES NO OTHER EXPRESS WARRANTY OR CONDITION, WHETHER WRITTEN OR ORAL, AND HP EXPRESSLY DISCLAIMS ALL WARRANTIES AND CONDITIONS NOT STATED IN THIS LIMITED WARRANTY. TO THE EXTENT ALLOWED BY THE LOCAL LAW OF JURISDICTIONS OUTSIDE THE UNITED STATES, HP DISCLAIMS ALL IMPLIED WARRANTIES OR CONDITIONS, INCLUDING ANY IMPLIED WARRANTIES OF MERCHANTABILITY AND FITNESS FOR A PARTICULAR PURPOSE. FOR ALL TRANSACTIONS OCCURRING IN THE UNITED STATES, ANY IMPLIED WARRANTY OR CONDITION OF MERCHANTABILITY, SATISFACTORY QUALITY, OR FITNESS FOR A PARTICULAR PURPOSE IS LIMITED TO THE DURATION OF THE EXPRESS WARRANTY SET FORTH ABOVE. SOME STATES OR COUNTRIES/REGIONS DO NOT ALLOW A LIMITATION ON HOW LONG AN IMPLIED WARRANTY LASTS OR THE EXCLUSION OR LIMITATION OF INCIDENTAL OR CONSEQUENTIAL DAMAGES FOR CONSUMER PRODUCTS. IN SUCH STATES OR COUNTRIES/REGIONS, SOME EXCLUSIONS OR LIMITATIONS OF THIS LIMITED WARRANTY MAY NOT APPLY TO YOU.

THE LIMITED WARRANTY TERMS CONTAINED IN THIS STATEMENT, EXCEPT TO THE EXTENT LAWFULLY PERMITTED, DO NOT EXCLUDE, RESTRICT, OR MODIFY BUT ARE IN ADDITION TO THE MANDATORY STATUTORY RIGHTS APPLICABLE TO THE SALE OF THIS PRODUCT TO YOU.

This Limited Warranty is applicable in all countries/regions and may be enforced in any country/region where HP or its authorized service providers offer warranty service for the same product model number subject to the terms and conditions set forth in this Limited Warranty.

Under the HP Global Limited Warranty program, products purchased in one country/region may be transferred to another country/region, where HP or its authorized service providers offer warranty service for the same product model number, without voiding the warranty. Warranty terms, service availability, and service response times may vary from country/region to country/region. Standard warranty service response time is subject to change due to local parts availability. If so, your HP authorized service provider can provide you with details.

HP is not responsible for any tariffs or duties that may be incurred in transferring the products. Transfer of the products may be covered by export controls issued by the United States or other governments.

This Limited Warranty applies only to HP-branded and Compaq-branded hardware products (collectively referred to in this Limited Warranty as "HP Hardware Products") sold by or leased from Hewlett-Packard Company, its worldwide subsidiaries, affiliates, authorized resellers, or country/region distributors (collectively referred to in this Limited Warranty as "HP") with this Limited Warranty. The term "HP Hardware Product" is limited to the hardware components and required firmware. The term "HP Hardware Product" DOES NOT include any software applications or programs; non-HP products or non-HP branded peripherals. All non-HP products or non-HP branded peripherals external to the HP Hardware Product—such as external storage subsystems, displays, printers, and other peripherals—are provided "AS IS" without HP warranty. However, non-HP manufacturers and suppliers, or publishers may provide their own warranties directly to you.

HP warrants that the HP Hardware Products that you have purchased or leased from HP are free from defects in materials or workmanship under normal use during the Limited Warranty Period. The Limited Warranty Period starts on the date of purchase or lease from HP or from the date HP completes installation. Your dated sales or delivery receipt, showing the date of purchase or lease of the product, is your proof of the purchase or lease date. You may be required to provide proof of purchase or lease as a condition of receiving warranty service. You are entitled to hardware warranty service according to the terms and conditions of this document if a repair to your HP Hardware Product is required within the Limited Warranty Period.

Unless otherwise stated, and to the extent permitted by local law, new HP Hardware Products may be manufactured using new materials or new and used materials equivalent to new in performance and reliability. HP may repair or replace HP Hardware Products (a) with new or previously used products or parts equivalent to new in performance and reliability or (b) with equivalent products to an original product that has been discontinued. Replacement parts are warranted to be free from defects in material or workmanship for ninety (90) days or, for the remainder of the Limited Warranty Period of the HP Hardware Product they are replacing or in which they are installed, whichever is longer.

HP will, at its discretion, repair or replace any component or hardware product that manifests a defect in materials or workmanship during the Limited Warranty Period. All component parts or hardware products removed under this Limited Warranty become the property of HP. In the unlikely event that your HP Hardware Product has recurring failures, HP, at its sole discretion, may elect to provide you with (a) a replacement unit of HP's choosing that is the same or equivalent to your HP Hardware Product in performance or (b) to give you a refund of your purchase price or lease payments (less interest) instead of a replacement. This is your exclusive remedy for defective products.

Exclusions

HP does not warrant that the operation of this product will be uninterrupted or error-free. HP is not responsible for damage that occurs as a result of your failure to follow the instructions intended for the HP Hardware Product.

This Limited Warranty does not apply to expendable or consumable parts and does not extend to any product from which the serial number has been removed or that has been damaged or rendered defective (a) as a result of accident, misuse, abuse, contamination, improper or inadequate maintenance or calibration, or other external causes; (b) by operation outside the usage parameters stated in the user documentation that shipped with the product; (c) by software, interfacing, parts, or supplies not supplied by HP; (d) by improper site preparation or maintenance; (e) by virus infection; (f) from loss or damage in transit; or (g) by modification or service by anyone other than (i) HP, (ii) an HP authorized service provider, or (iii) your own installation of end-user-replaceable HP or HP-approved parts if available for your product in the servicing country/region.

YOU SHOULD MAKE PERIODIC BACKUP COPIES OF THE DATA STORED ON YOUR HARD DRIVE OR OTHER STORAGE DEVICES AS A PRECAUTION AGAINST POSSIBLE FAILURES, ALTERATION, OR LOSS OF THE DATA. BEFORE RETURNING ANY UNIT FOR SERVICE, BE SURE TO BACK UP DATA AND REMOVE ANY CONFIDENTIAL, PROPRIETARY, OR PERSONAL INFORMATION. HP IS NOT RESPONSIBLE FOR DAMAGE TO OR LOSS OF ANY PROGRAMS, DATA, OR REMOVABLE STORAGE MEDIA. HP IS NOT RESPONSIBLE FOR THE RESTORATION OR REINSTALLATION OF ANY PROGRAMS OR DATA OTHER THAN SOFTWARE INSTALLED BY HP WHEN THE PRODUCT IS MANUFACTURED. UNITS SENT IN FOR SERVICE MAY HAVE THE DATA ERASED FROM THE HARD DRIVE AND THE PROGRAMS RESTORED TO THEIR ORIGINAL STATE.

Exclusive Remedy

TO THE EXTENT ALLOWED BY APPLICABLE LOCAL LAW, THESE TERMS AND CONDITIONS CONSTITUTE THE COMPLETE AND EXCLUSIVE WARRANTY AGREEMENT BETWEEN YOU AND HP REGARDING THE HP HARDWARE PRODUCT YOU HAVE PURCHASED OR LEASED. THESE TERMS AND CONDITIONS SUPERSEDE ANY PRIOR AGREEMENTS OR REPRESENTATIONS—INCLUDING REPRESENTATIONS MADE IN HP SALES LITERATURE OR ADVICE GIVEN TO YOU BY HP OR AN AGENT OR EMPLOYEE OF HP—THAT MAY HAVE BEEN MADE IN CONNECTION WITH YOUR PURCHASE OR LEASE OF THE HP HARDWARE PRODUCT. No change to the conditions of this Limited Warranty is valid unless it is made in writing and signed by an authorized representative of HP.

Limitation of Liability

IF YOUR HP HARDWARE PRODUCT FAILS TO WORK AS WARRANTED ABOVE, HP'S MAXIMUM LIABILITY UNDER THIS LIMITED WARRANTY IS EXPRESSLY LIMITED TO THE LESSER OF THE PRICE YOU HAVE PAID FOR THE PRODUCT OR THE COST OF REPAIR OR REPLACEMENT OF ANY HARDWARE COMPONENTS THAT MALFUNCTION IN CONDITIONS OF NORMAL USE.

EXCEPT AS INDICATED ABOVE, IN NO EVENT WILL HP BE LIABLE FOR ANY DAMAGES CAUSED BY THE PRODUCT OR THE FAILURE OF THE PRODUCT TO PERFORM, INCLUDING ANY LOST PROFITS OR SAVINGS OR SPECIAL, INCIDENTAL, OR CONSEQUENTIAL DAMAGES. HP IS NOT LIABLE FOR ANY CLAIM MADE BY A THIRD PARTY OR MADE BY YOU FOR A THIRD PARTY.

THIS LIMITATION OF LIABILITY APPLIES WHETHER DAMAGES ARE SOUGHT, OR A CLAIM MADE, UNDER THIS LIMITED WARRANTY OR AS A TORT CLAIM (INCLUDING NEGLIGENCE AND STRICT PRODUCT LIABILITY), A CONTRACT CLAIM, OR ANY OTHER CLAIM. THIS LIMITATION OF LIABILITY CANNOT BE WAIVED OR AMENDED BY ANY PERSON. THIS LIMITATION OF LIABILITY WILL BE EFFECTIVE EVEN IF YOU HAVE ADVISED HP OR AN AUTHORIZED REPRESENTATIVE OF HP OF THE POSSIBILITY OF ANY SUCH DAMAGES. THIS LIMITATION OF LIABILITY, HOWEVER, WILL NOT APPLY TO CLAIMS FOR PERSONAL INJURY.

THIS LIMITED WARRANTY GIVES YOU SPECIFIC LEGAL RIGHTS. YOU MAY ALSO HAVE OTHER RIGHTS THAT MAY VARY FROM STATE TO STATE OR FROM COUNTRY/REGION TO COUNTRY/REGION. YOU ARE ADVISED TO CONSULT APPLICABLE STATE OR COUNTRY/REGION LAWS FOR A FULL DETERMINATION OF YOUR RIGHTS.

Limited Warranty Period

The Limited Warranty Period for an HP Hardware Product is a specified, fixed period commencing on the date of purchase. The date on your sales receipt is the date of purchase unless HP or your reseller informs you otherwise in writing.

Types of Warranty Service

To enable HP to provide the best possible support and service during the Limited Warranty Period, you may be directed by HP to verify configurations, load most recent firmware, install software patches, run HP diagnostics tests, or use HP remote support solutions where applicable.

HP strongly encourages you to accept the use of or to employ available support technologies provided by HP. If you choose not to deploy available remote support capabilities, you may incur additional costs due to increased support resource requirements. Listed below are the types of warranty support service that may be applicable to the HP Hardware Product you have purchased.

Customer Self Repair Warranty Service

In countries/regions where it is available, your HP Limited Warranty may include a customer self repair warranty service. If applicable, HP will determine in its sole discretion that customer self repair is the appropriate method of warranty service. If so, HP will ship approved replacement parts directly to you to fulfill your HP Hardware Product warranty service. This will save considerable repair time. After you contact the HP Technical Support Center and the fault diagnosis identifies that the problem can be fixed using one of these parts, a replaceable part can be sent directly to you. Once the part arrives, replace the defective part pursuant to the provided instructions and documentation. If further assistance is required, call the HP Technical Support Center, and a technician will assist you over the phone. In cases where the replacement part must be returned to HP, you must ship the defective part back to HP within a defined period of time, normally thirty (30) days. The defective part must be returned with the associated documentation in the provided shipping material. Failure to return the defective product may result in HP billing you for the replacement. With a customer self repair, HP will pay all shipping and part return costs and determine the courier/carrier to be used. If customer self repair applies to you, please refer to your specific HP Hardware Product announcement. You can also obtain information on this warranty service on the HP Web site at: <http://www.hp.com/support>

Pickup and Return Warranty Service

Your HP Limited Warranty may include a pickup and return warranty service. Under the terms of pickup and return service, HP will pick up the defective unit from your location, repair it, and return it back to your location. HP will incur all repair, logistics, and insurance costs in this process.

Carry-in Warranty Service

Under the terms of carry-in service, you will be required to deliver your HP Hardware Product to an authorized service location for warranty repair. You must prepay any shipping charges, taxes, or duties associated with transportation of the product to and from the service location. In addition, you are responsible for insuring any product shipped or returned to an authorized service location and assume risk of loss during shipping.

Service Upgrades

HP has a range of additional support and service coverage for your product that can be purchased locally. However, some support and related products may not be available in all countries/regions. For information on availability of service upgrades and the cost for these service upgrades, refer to the HP Web site at:

<http://www.hp.com/support>

Options and Software Limited Warranties

The Limited Warranty terms and conditions for most HP-branded options (HP Options) are as set forth in the Limited Warranty applicable to the HP Option and are included in the HP Option product packaging. If your HP Option is installed in an HP Hardware Product, HP may provide warranty service for either the period specified in the warranty documents (HP Option Limited Warranty Period) that shipped with the HP Option or for the remaining warranty period of the HP Hardware Product in which the HP Option is being installed, whichever period is the longer, but not to exceed three (3) years from the date you purchased the HP Option. The HP Option Limited Warranty Period starts from the date of purchase from HP or an HP authorized reseller. Your dated sales or delivery receipt, showing the date of purchase of the HP Option, is your warranty start date. See your HP Option Limited Warranty for more details. Non-HP options are provided "AS IS." However, non-HP manufacturers and suppliers may provide warranties directly to you.

EXCEPT AS PROVIDED IN THE APPLICABLE SOFTWARE END-USER LICENSE OR PROGRAM LICENSE AGREEMENT, OR IF OTHERWISE PROVIDED UNDER LOCAL LAW, SOFTWARE PRODUCTS, INCLUDING ANY SOFTWARE PRODUCTS, FREWARE (AS DEFINED BELOW), AND THE OPERATING SYSTEM PREINSTALLED BY HP ARE PROVIDED "AS IS" AND WITH ALL FAULTS, AND HP HEREBY DISCLAIMS ALL OTHER WARRANTIES AND CONDITIONS, EITHER EXPRESS, IMPLIED, OR STATUTORY, INCLUDING, BUT NOT LIMITED TO, WARRANTIES OF TITLE AND NON-INFRINGEMENT, ANY IMPLIED WARRANTIES, DUTIES, OR CONDITIONS OF MERCHANTABILITY, OF FITNESS FOR A PARTICULAR PURPOSE, AND OF LACK OF VIRUSES. Some states/jurisdictions do not allow exclusion of implied warranties or limitations on the duration of implied warranties, so the above disclaimer may not apply to you in its entirety. TO THE MAXIMUM EXTENT PERMITTED BY APPLICABLE LAW, IN NO EVENT SHALL HP OR ITS SUPPLIERS BE LIABLE FOR ANY SPECIAL, INCIDENTAL, INDIRECT, OR CONSEQUENTIAL DAMAGES WHATSOEVER (INCLUDING, BUT NOT LIMITED TO,

DAMAGES FOR LOSS OF PROFITS OR CONFIDENTIAL OR OTHER INFORMATION, FOR BUSINESS INTERRUPTION, FOR PERSONAL INJURY, FOR LOSS OF PRIVACY ARISING OUT OF OR IN ANY WAY RELATED TO THE USE OF OR INABILITY TO USE THE SOFTWARE PRODUCT) EVEN IF HP OR ANY SUPPLIER HAS BEEN ADVISED OF THE POSSIBILITY OF SUCH DAMAGES AND EVEN IF THE REMEDY FAILS OF ITS ESSENTIAL PURPOSE. Some states/jurisdictions do not allow the exclusion or limitation of incidental or consequential damages, so the above limitation or exclusion may not apply to you.

HP's only warranty obligations with respect to software distributed by HP under the HP brand name are set forth in the applicable end-user license or program license agreement provided with that software. If the removable media on which HP distributes the software proves to be defective in materials or workmanship within ninety (90) days of purchase, your sole remedy shall be to return the removable media to HP for replacement. For blank tape removable media, refer to the following Web site:

<http://h20000.www2.hp.com/bizsupport/TechSupport/Document.jsp?objectID=lpg50101>

It is your responsibility to contact non-HP manufacturers or suppliers for their warranty support.

Software Technical Support

Software technical support for your HP software, HP preinstalled third-party software, and third-party software purchased from HP is available from HP via multiple contact methods, including electronic media and telephone, for one year from date of purchase. See "Contacting HP" for online resources and telephone support. Any exceptions to this will be specified in your End-User License Agreement (EULA).

Software technical support includes assistance with:

- Answering your installation questions (how-to, first steps, and prerequisites).
- Setting up and configuring the software (how-to and first steps).
- Interpreting system error messages.
- Isolating system problems to software usage problems.

Software technical support does NOT include assistance with:

- Generating or diagnosing user-generated programs or source codes.
- Installing of non-HP products.
- System optimization and customization.
- Network configuration.

Contacting HP

If your product fails during the Limited Warranty Period and the suggestions in the product documentation do not solve the problem, you can receive support by doing the following:

Locate your nearest HP Support location via the Web at:

<http://www.hp.com/support>

Contact your authorized HP dealer or authorized service provider, and be sure to have the following information available before you call:

- Product serial number, model name, and model number
- Applicable error messages
- Add-on options
- Operating system
- Third-party hardware or software
- Detailed questions

How to Check Warranty and Support Entitlement

Please check **<http://www.hp.com/support>** for warranty, service and support and product information updates.

END-USER LICENSE AGREEMENT

PLEASE READ CAREFULLY BEFORE USING THIS EQUIPMENT: This End-User license Agreement ("EULA") is a legal agreement between (a) you (either an individual or a single entity) and (b) Hewlett-Packard Company ("HP") that governs your use of any Software Product, installed on or made available by HP for use with your HP product ("HP Product"), that is not otherwise subject to a separate license agreement between you and HP or its suppliers. Other software may contain a EULA in its online documentation. The term "Software Product" means computer software and may include associated media, printed materials and "online" or electronic documentation. An amendment or addendum to this EULA may accompany the HP Product.

RIGHTS IN THE SOFTWARE PRODUCT ARE OFFERED ONLY ON THE CONDITION THAT YOU AGREE TO ALL TERMS AND CONDITIONS OF THIS EULA. BY INSTALLING, COPYING, DOWNLOADING, OR OTHERWISE USING THE SOFTWARE PRODUCT, YOU AGREE TO BE BOUND BY THE TERMS OF THIS EULA. IF YOU DO NOT ACCEPT THESE LICENSE TERMS, YOUR SOLE REMEDY IS TO RETURN THE ENTIRE UNUSED PRODUCT (HARDWARE AND SOFTWARE) WITHIN 14 DAYS FOR A REFUND SUBJECT TO THE REFUND POLICY OF YOUR PLACE OF PURCHASE.

1. GRANT OF LICENSE. HP grants you the following rights provided you comply with all terms and conditions of this EULA:

- a. Use. You may use the Software Product on a single computer ("Your Computer"). If the Software Product is provided to you via the internet and was originally licensed for use on more than one computer, you may install and use the Software Product only on those computers. You may not separate component parts of the Software Product for use on more than one computer. You do not have the right to distribute the Software Product. You may load the Software Product into Your Computer's temporary memory (RAM) for purposes of using the Software Product.
- b. Storage. You may copy the Software Product into the local memory or storage device of the HP Product.
- c. Copying. You may make archival or back-up copies of the Software Product, provided the copy contains all of the original Software Product's proprietary notices and that it is used only for back-up purposes.
- d. Reservation of Rights. HP and its suppliers reserve all rights not expressly granted to you in this EULA.
- e. Freeware. Notwithstanding the terms and conditions of this EULA, all or any portion of the Software Product which constitutes non-proprietary HP software or software provided under public license by third parties ("Freeware"), is licensed to you subject to the terms and conditions of the software license agreement accompanying such Freeware whether in the form of a discrete agreement, shrink wrap license or electronic license terms accepted at time of download. Use of the Freeware by you shall be governed entirely by the terms and conditions of such license.

f. Recovery Solution. Any software recovery solution provided with/for your HP Product, whether in the form of a hard disk drive-based solution, an external media-based recovery solution (e.g. floppy disk, CD or DVD) or an equivalent solution delivered in any other form, may only be used for restoring the hard disk of the HP Product with/for which the recovery solution was originally purchased. The use of any Microsoft operating system software contained in such recovery solution shall be governed by the Microsoft License Agreement.

2. UPGRADES. To use a Software Product identified as an upgrade, you must first be licensed for the original Software Product identified by HP as eligible for the upgrade. After upgrading, you may no longer use the original Software Product that formed the basis for your upgrade eligibility.

3. ADDITIONAL SOFTWARE. This EULA applies to updates or supplements to the original Software Product provided by HP unless HP provides other terms along with the update or supplement. In case of a conflict between such terms, the other terms will prevail.

4. TRANSFER.

a. Third Party. The initial user of the Software Product may make a one-time transfer of the Software Product to another end user. Any transfer must include all component parts, media, printed materials, this EULA, and if applicable, the Certificate of Authenticity. The transfer may not be an indirect transfer, such as a consignment. Prior to the transfer, the end user receiving the transferred product must agree to all the EULA terms. Upon transfer of the Software Product, your license is automatically terminated.

b. Restrictions. You may not rent, lease or lend the Software Product or use the Software Product for commercial timesharing or bureau use. You may not sublicense, assign or transfer the license or Software Product except as expressly provided in this EULA.

5. PROPRIETARY RIGHTS. All intellectual property rights in the Software Product and user documentation are owned by HP or its suppliers and are protected by law, including but not limited to United States copyright, trade secret, and trademark law, as well as other applicable laws and international treaty provisions. You shall not remove any product identification, copyright notices or proprietary restrictions from the Software Product.

6. LIMITATION ON REVERSE ENGINEERING. You may not reverse engineer, decompile, or disassemble the Software Product, except and only to the extent that the right to do so is mandated under applicable law notwithstanding this limitation or it is expressly provided for in this EULA.

7. TERM. This EULA is effective unless terminated or rejected. This EULA will also terminate upon conditions set forth elsewhere in this EULA or if you fail to comply with any term or condition of this EULA.

8. CONSENT TO USE OF DATA. You agree that HP and its affiliates may collect and use technical information you provide in relation to support services related to the Software Product. HP agrees not to use this information in a form that personally identifies you except to the extent necessary to provide such services.

9. DISCLAIMER OF WARRANTIES. TO THE MAXIMUM EXTENT PERMITTED BY APPLICABLE LAW, HP AND ITS SUPPLIERS PROVIDE THE SOFTWARE PRODUCT "AS IS" AND WITH ALL FAULTS, AND HEREBY DISCLAIM ALL OTHER WARRANTIES AND CONDITIONS, EITHER EXPRESS, IMPLIED, OR STATUTORY, INCLUDING, BUT NOT LIMITED TO, WARRANTIES OF TITLE AND NON-INFRINGEMENT, ANY IMPLIED WARRANTIES, DUTIES OR CONDITIONS OF MERCHANTABILITY, OF FITNESS FOR A PARTICULAR PURPOSE, AND OF LACK OF VIRUSES ALL WITH REGARD TO THE SOFTWARE PRODUCT. Some states/jurisdictions do not allow exclusion of implied warranties or limitations on the duration of implied warranties, so the above disclaimer may not apply to you in its entirety.

10. LIMITATION OF LIABILITY. Notwithstanding any damages that you might incur, the entire liability of HP and any of its suppliers under any provision of this EULA and your exclusive remedy for all of the foregoing shall be limited to the greater of the amount actually paid by you separately for the Software Product or U.S. \$5.00. TO THE MAXIMUM EXTENT PERMITTED BY APPLICABLE LAW, IN NO EVENT SHALL HP OR ITS SUPPLIERS BE LIABLE FOR ANY SPECIAL, INCIDENTAL, INDIRECT, OR CONSEQUENTIAL DAMAGES WHATSOEVER (INCLUDING, BUT NOT LIMITED TO, DAMAGES FOR LOSS OF PROFITS OR CONFIDENTIAL OR OTHER INFORMATION, FOR BUSINESS INTERRUPTION, FOR PERSONAL INJURY, FOR LOSS OF PRIVACY ARISING OUT OF OR IN ANY WAY RELATED TO THE USE OF OR INABILITY TO USE THE SOFTWARE PRODUCT, OR OTHERWISE IN CONNECTION WITH ANY PROVISION OF THIS EULA, EVEN IF HP OR ANY SUPPLIER HAS BEEN ADVISED OF THE POSSIBILITY OF SUCH DAMAGES AND EVEN IF THE REMEDY FAILS OF ITS ESSENTIAL PURPOSE. Some states/jurisdictions do not allow the exclusion or limitation of incidental or consequential damages, so the above limitation or exclusion may not apply to you.

11. U.S. GOVERNMENT CUSTOMERS. Consistent with FAR 12.211 and 12.212, Commercial Computer Software, Computer Software Documentation, and Technical Data for Commercial Items are licensed to the U.S. Government under HP's standard commercial license.

12. COMPLIANCE WITH EXPORT LAWS. You shall comply with all laws and regulations of the United States and other countries/regions ("Export Laws") to assure that the Software Product is not (1) exported, directly or indirectly, in violation of Export Laws, or (2) used for any purpose prohibited by Export Laws, including, without limitation, nuclear, chemical, or biological weapons proliferation.

13. CAPACITY AND AUTHORITY TO CONTRACT. You represent that you are of the legal age of majority in your state of residence and, if applicable, you are duly authorized by your employer to enter into this contract.

14. APPLICABLE LAW. This EULA is governed by the laws of the State of California, U.S.A.

15. ENTIRE AGREEMENT. This EULA (including any addendum or amendment to this EULA which is included with the HP Product) is the entire agreement between you and HP relating to the Software Product and it supersedes all prior or contemporaneous oral or written communications, proposals and representations with respect to the Software Product or any other subject matter covered by this EULA. To the extent the terms of any HP policies or programs for support services conflict with the terms of this EULA, the terms of this EULA shall control.

Rev. 10/03

DECLARATION OF CONFORMITY

according to ISO/IEC 17050-1 and EN 17050-1

Supplier's Name: Hewlett-Packard Company
Supplier's Address: Hewlett-Packard Company
10955 Tantau Ave
Cupertino, CA 95014

declares, that the product(s)

Product: Personal computer

Model Number(s): a000, a1000, a5000, a6000
d1000, d4000, dx2000
g2000, g3000
m000, m1000, m5000, m7000, m8000, m9000
s0000, s3000, s7000
SR1000, SR2000, SR5000, SA4000, SV2000, SV7000, SG2000, SG3000
t000, t3000
u6000
v2000, v7000,
w1000, w5000
x5000, z500, z6000, IQ700, series

Product Options: All, (including refurbish)

conforms to the following Product Specifications:

Safety: IEC 60950-1:2001 / EN60950-1: 2001
EN 60825-1: 1994 + A1: 2002 + A2: 2001, Class 1 (Laser/LED)
GB4943: 2001

EMC: CISPR 22: 1997 / EN 55022: 1998 +A1:2000 +A2:2003, Class B
CISPR 24: 1997 / EN 55024:+1998 +A1:2001 +A2:2003
EN 55020:1995
EN 55013:2001
IEC 61000-3-2:2000 / EN 61000-3-2: 2000
IEC 61000-3-3:1994 + A1: 2001 / EN 61000-3-3: 1995 + A1: 2001
GB9254: 1998
FCC Title 47 CFR, Part 15 Class B / ICES-003, Issue 4
AS/NZS CISPR 22: 2004

Telecom: TBR 21: 1998, EG 201 121: 1998

Radio: ETSI 300-826 General EMC requirements for Radio equipment
ETSI 300-328 Technical requirements for Radio equipment

Supplementary Information:

The product herewith complies with the requirements of the Low Voltage Directive 2006/95/EC, the EMC Directive 89/336/EEC and the R&TTE Directive 1999/5/EC and carries the "CE Marking" accordingly.

This device complies with Part 15 of FCC rules. Operation is subject to the following two conditions: (1) this device may not cause harmful interference, and (2) this device must accept any interference received, including interference that may cause undesired operation.

Cupertino, CA USA May 9, 2007

For regulatory compliance information only, contact:

Australia Contact: Product Regulations Manager, Hewlett-Packard Australia Pty Ltd., 31-41 Joseph Street, Blackburn, Victoria 3130
European Contact: Hewlett-Packard GmbH, HQ-TRE, Herrenberger Straße 140, 71034 Böblingen, Germany (FAX: +49-7031-14-3143)
North America Contact: Hardware Quality Eng. Manager, Hewlett-Packard, CPC, 10955 Tantau Ave., Cupertino, CA 95014

Operating Specifications

Electrical ratings:	AC INPUT	100–127V $\sqrt{}$, 3A or 4A or 6A* 200–240V $\sqrt{}$, 2A or 3A*
		50/60 Hz
Operating temperature:		5° to 35° C
Storage temperature:		–30° to 65° C
Operating humidity:		15 to 80% @ 26° C
Operating altitude:		0–2000 m
Storage altitude:		0–4572 m

* Refer to your computer's ratings label located on the back of the computer to determine exact electrical rating.

Regulatory and Safety Information



WARNING: Text set off in this manner indicates that failure to follow directions could result in damage to equipment, loss of information, bodily harm, or loss of life.



WARNING: The computer is heavy; be sure to use ergonomically correct lifting procedures when moving the computer.



WARNING: Please read the "Additional Safety Information" located later in this document before installing and connecting your computer to the electrical power system.

Batteries are delivered with this product. When empty, do not throw them away but collect as small chemical waste.

Bij dit product zijn batterijen geleverd. Wanneer deze leeg zijn, moet u ze niet weggooien maar inleveren als Klein Chemisch Afval (KCA).



Mercury statement:

Materials disposal

This HP product contains the following materials that might require special handling at end-of-life:

- Mercury in the fluorescent lamp in the display LCD.

Disposal of mercury can be regulated because of environmental considerations. For disposal or recycling information, please contact your local authorities or the Electronic Industries Alliance (EIA) (<http://www.eiae.org>).

Perchlorate statement:

Perchlorate material — special handling may apply. See <http://www.dtsc.ca.gov/hazardouswaste/perchlorate/>

This product's real-time clock battery or coin cell battery may contain perchlorate and may require special handling when recycled or disposed of in California.

FCC Regulatory and Safety Information (USA Only)

Federal Communications Commission (FCC) Radio Frequency Interference Statement



WARNING: This equipment has been tested and found to comply with the limits for a Class B digital device, pursuant to Part 15 of the FCC Rules. These limits are designed to provide reasonable protection against harmful interference in a residential installation. This equipment generates, uses, and can radiate radio frequency energy and, if not installed and used in accordance with the instructions, may cause harmful interference to radio communications. However, there is no guarantee that interference will not occur in a particular installation. If this equipment does cause harmful interference to radio or television reception, which can be determined by turning the equipment off and on, the user is encouraged to correct the interference by one or more of the following measures:

- Reorient or relocate the receiving antenna.
- Increase the separation between the equipment and the receiver.
- Connect the equipment into an outlet that is on a circuit different from the receiver.
- Consult the dealer or an experienced radio/TV technician for help.

The system RFI and Radiated Immunity tests were conducted with supported peripheral devices and shielded cables, such as those you receive with your system. Changes or modifications not expressly approved by the manufacturer could void the user's authority to operate the equipment. To comply with the limits for an FCC Class B computing device, always use shielded signal cables and the power cord supplied with this unit.

Consumer Information and FCC Requirements

Telephone Connection

- This equipment complies with Part 68 of the Federal Communications Commission rules. These rules permit this device to be directly connected to the telephone network. Standardized jacks are used for these connections. This equipment should not be used on party lines or coin lines.

- If this device is malfunctioning, it may also cause harm to the telephone network; this device should be disconnected until the source of the problem can be determined and until it has been repaired. If this is not done, the telephone company may temporarily disconnect your service.
- The telephone company may make changes in its technical operations and procedures. If such changes affect the compatibility or use of this device, the telephone company is required to give adequate notice of the changes.
- If the telephone company requests information on what equipment is connected to their lines, inform them of:
 - a The telephone number this unit is connected to
 - b The ringer equivalence number
 - c The USOC jack required: RJ-11C
 - d The FCC Registration Number

Items (b) and (c) are indicated on the label. The ringer equivalence number (REN) is used to determine how many devices can be connected to your telephone line. In most areas, the sum of the RENs on any one line should not exceed five (5.0). If too many devices are attached, they may not ring properly.

- In the event of equipment malfunction, the manufacturer or an authorized repair center should perform all repairs. It is the responsibility of users requiring service to report the problem to the manufacturer, or an authorized agent. Refer to "Where to Get Help" in this document for contact information.

Statement of Fax Branding

The Consumer Protection Act of 1991 makes it unlawful for any person to use a computer or other electronic device to send any message via telephone fax machine, unless it clearly contains: a margin at the top or bottom of each transmitted page or on the first page of the transmission, the date and time it is sent, identification of the business or other entity, or individual sending the message, the telephone number of the sending machine or such business, entity, or individual.

Canada Department of Communications (DOC) Notice

Telephone Connection

The Canada Department of Communications label identifies certified equipment. This certification means that the equipment meets certain telecommunications network protective, operational, and safety requirements. The department does not guarantee the equipment will operate to the user's satisfaction.

Before installing this equipment, the user should ensure it is permissible to connect it to the facilities of the local communications company. The equipment must be installed using an acceptable method of connection. In some cases, the company's inside wiring associated with a single line individual service may be extended by means of a certified connector assembly (telephone extension cord). The customer should be aware that compliance with the above conditions may not prevent degradation of service in some situations.

Repairs to certified equipment should be made by an authorized Canadian maintenance facility designated by the supplier. Any repairs or alterations made by the user to this equipment, or equipment malfunctions, may give the telecommunications company cause to request that the user disconnect the equipment.

Users should ensure, for their own protection, that the electrical ground connections of the power utility, telephone lines, and internal metallic water pipe systems, if present, are connected together. This precaution may be particularly important in rural areas.



WARNING: Users should not attempt to make such connections themselves, but should contact the appropriate electrical inspection authority or electrician, as appropriate.



WARNING: The Load Number .9 assigned to each terminal device denotes the percentage of the total load to be connected to a telephone loop; this is used by the device to prevent overloading. The termination on a loop may consist of any combination of devices, subject only to the requirement that the sum of the Load Numbers does not exceed 100.



WARNING: When using this device, basic safety precautions should always be followed to reduce the risk of fire, electric shock, and injury to persons, including the following:

- **Do not use this product near water, for example, near a bathtub, wash bowl, kitchen sink, or laundry tub, in a wet basement, or near a swimming pool.**
- **Avoid using this product during an electrical storm. There may be a remote risk of electric shock from lightning.**
- **Do not use this product to report a gas leak in the vicinity of the leak.**
- **Always disconnect the modem cable before opening the equipment enclosure or touching an uninsulated modem cable, jack, or internal components.**
- **If this product was not provided with a telephone line cord, use only No. 26 AWG or larger telecommunication line cord in order to reduce the risk of fire.**
- **Do not plug a modem or telephone cable into the Network Interface Card (NIC) receptacle.**

SAVE THESE INSTRUCTIONS

DOC Statement (Canada Only)

This Class B digital apparatus meets all requirements of the Canadian Interference-Causing Equipment Regulations.

Additional Safety Information

This product has not been evaluated for connection to an "IT" power system (an AC distribution system with no direct connection to earth, according to IEC 60950).

This equipment meets the applicable Industry Canada Terminal Equipment Technical Specifications. This is confirmed by the registration number. The abbreviation, IC, before the registration number signifies that registration was performed based on a Declaration of Conformity indicating that Industry Canada technical specifications were met. It does not imply that Industry Canada approved the equipment.

AC Power Safety Warning

 **WARNING:** Install the computer near an AC outlet. The AC power cord is your computer's main AC disconnecting device and must be easily accessible at all times. For your safety, the power cord provided with your computer has a grounded plug. Always use the power cord with a properly grounded wall outlet, to avoid the risk of electrical shock.

 **WARNING:** Your computer is provided with a voltage select switch for use in a 115 or 230 V[~] power system. The voltage select switch has been pre-set to the correct voltage setting for use in the particular country/region where it was initially sold. Changing the voltage select switch to the incorrect position can damage your computer and void any implied warranty.

 **WARNING:** To reduce the possibility of an electric shock from the telephone network, plug your computer into the AC outlet before connecting it to the telephone line. Also, disconnect the telephone line before unplugging your computer from the AC power outlet.

 **WARNING:** Always disconnect the modem cord from the telephone system before installing or removing your computer cover.

 **WARNING:** Do not operate the computer with the cover removed.

 **WARNING:** For your safety, always unplug the computer from its power source and from any telecommunications systems (such as telephone lines), networks, or modems before performing any service procedures. Failure to do so may result in personal injury or equipment damage. Hazardous voltage levels are inside the power supply and modem of this product.

Lithium Battery Caution

 **WARNING:** The computer uses a lithium battery, type CR2032. There is danger of an explosion if the battery is incorrectly replaced. Replace only with the same, or equivalent, type recommended by the manufacturer. Dispose of used batteries according to the manufacturer's instructions.

Laser Safety Statement Class 1 LED Product

The CD and DVD drives contain a laser system and are classified as a "Class 1 Laser Product" under a U.S. Department of Health and Human Services (DHHS) Radiation Performance standard according to the Radiation Control for Health and Safety Act of 1968.

Should the unit ever require maintenance, contact an authorized service location.

 **WARNING:** Use of controls, adjustments, or performance procedures other than those specified in the *Upgrading and Servicing Guide* may result in hazardous radiation exposure. To prevent direct exposure to laser beam, do not try to open the enclosure of the CD or DVD drives.

Laser Product Label

The following label or equivalent is located on the surface of laser products:



This label indicates that the product is classified as a CLASS 1 LASER PRODUCT. This label appears on a laser device installed in your product.

Note to CATV System Installer

This reminder is provided to call the CATV systems installer's attention to section 820-93 of the National Electric Code, which provides guidelines for proper grounding and in particular, specify that the Coaxial cable shield shall be connected to grounding system of the building, as close to the point of cable entry as practical.

TV Antenna Connectors Protection

External Television Antenna Grounding

If an outside antenna or cable system is connected to the product, be sure the antenna or cable system is electrically grounded so as to provide some protection against voltage surges and built-up static charges. Article 810 of the National Electrical Code, ANSI/NFPA 70, provides information with regard to proper electrical grounding of the mast and supporting structure, grounding of the lead-in wire to an antenna-discharge unit, size of grounding conductors, location of antenna-discharge unit, connection to grounding electrodes, and requirements for the grounding electrode.

Lightning Protection

For added protection of any product during a lightning storm, or when it is left unattended and unused for long periods of time, unplug the product from the wall outlet and disconnect the antenna or cable system. This will prevent damage to the product from lightning and power line surges.

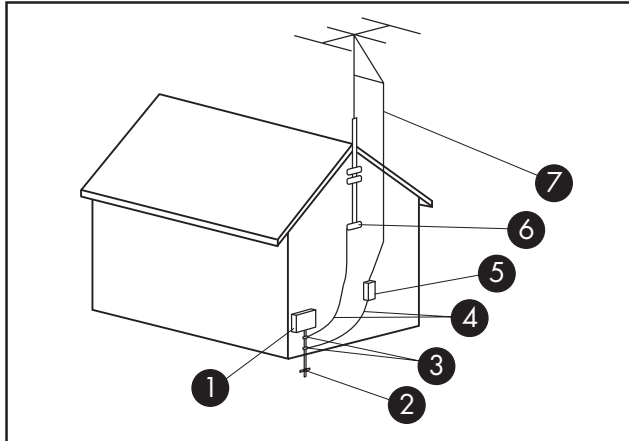

Antenna Grounding

Antenna Grounding

Reference	Grounding Component
①	Electric Service Equipment
②	Power Service Grounding Electrode System (NEC Art 250, Part H)
③	Ground Clamps
④	Grounding Conductors (NEC Section 810-21)
⑤	Antenna Discharge Unit (NEC Section 810-20)
⑥	Ground Clamp
⑦	Antenna Lead in Wire

Power Lines

An outside antenna system should not be located in the vicinity of overhead power lines or other electric light or power circuits, or where it can fall into such power lines or circuits.



WARNING: When installing an outside antenna system, extreme care should be taken to keep from touching such power lines or circuits as contact with them could be fatal.

Support Information

Don't Forget to Register!

You can register your computer through the Help and Support Center. Click the **Windows Start Button**[®], and then click **Help and Support**.

Registration is quick and easy, and it offers:

- E-mail updates containing notifications about product enhancements, the most recent support alerts, and driver updates specific to the product(s) you own.
- The HP Newsgam, our monthly online magazine packed full of product news, support tips, project ideas, and much more. Visit us at:
<http://subscription.support.hp.com>

Where to Get Help

Follow these steps when you need help

- 1** Check the setup poster and product documentation for help with setting up and using your computer.
- 2** Use the Help and Support Center for help with hardware and software questions. Click the **Windows Start Button**, and then click **Help and Support**. The Help and Support Center provides useful troubleshooting information and includes the following:
 - Link to register your computer.
 - System information, including your computer product number, model number, and serial number.
 - E-mail support.
 - HP Real Time Chat with qualified support specialists.
 - Support phone numbers.
 - Link to the User Guides for your computer.
- 3** If you think you have a hardware issue, before calling the Customer Care Center, run the hardware diagnostic tools that are preinstalled on your computer. Click the **Windows Start Button, All Programs, PC Help & Tools**, and then click **Hardware Diagnostic Tools**.
- 4** HP Technical Support Web site. Go to:
<http://www.hp.com/support> for product information, driver updates, troubleshooting, and much more.

- 5** If you have not solved the problem, call HP Total Care, toll-free, by phone, 24 hours a day, seven days a week in English, Spanish (U.S. only), and French (Canada only) at:

HP: **1-800-474-6836** (800-HP-invent)

Compaq: **1-800-652-6672** (800-OK-Compaq)

When you call, please have your product model number, serial number, and date of purchase available. Telephone support is free during your limited warranty period.

Where Are My User Guides?

The User Guides are on your computer. Click the **Windows Start Button, All Programs**, and then click **User Guides**. Documentation is also available at <http://www.hp.com/support> where you can search for the support page for your model.

Software and Connectivity Support

America Online

U.S.: 1-888-346-3704

Canada: 1-888-265-4357

<http://www.aol.com>

AT&T/SBC

1-800-400-1447

<http://www.att.net>

Comcast

1-800-266-2278 (1-800-COMCAST)

<http://www.comcast.com>

Corel

<http://www.corel.com>

EarthLink

Dial-up customer service and technical support

1-800-890-6356

Broadband customer service and technical support

1-888-829-8466

<http://www.earthlink.net>

HP Photosmart Essential

<http://www.hp.com/go/pse>

MSN

1-800-386-5550

<http://support.msn.com>

NetZero

1-800-638-9376 (1-800-NETZERO)
<http://netzero.net>

Symantec – Norton Internet Security

<http://www.symantec.com/techsupp>

Intuit – Quicken Basic

1-900-555-4688
<http://www.intuit.com>

CyberLink

<http://www.cyberlink.com>

HP Total Care

HP Total Care provides fast, friendly, and effective expert advice for all your HP products. If you have a question or if a problem arises, we offer extensive service and support options around the clock to better handle your needs. Go to your computer's Help and Support Center for the fastest resolutions. For more information on your support and services options visit:

<http://www.hp.com/go/totalcare>

Or

<http://www.hp.ca/totalcare> (Canada)

When Should I Contact HP Total Care Support and Services?

- The Help and Support Center or other support tools on your computer do not identify or help solve your problem.
- You either do not have Internet access or cannot connect to the Internet to use the HP Technical Support Web site or to chat with qualified online support specialists.
- There is obvious damage or a mechanical breakdown with your product, and it does not work.

HP Total Care Agents are available 24 hours a day in English, Spanish (U.S. only), and French (Canada only) via telephone to provide expert assistance.

HP: **1-800-474-6836** (800-HP-invent)
Compaq: **1-800-652-6672** (800-OK-Compaq)

NOTE: Support options, availability, and hours vary by product, country/region, and language and are subject to change.

HP Total Care Out-of-Warranty Support Options

Even after your warranty has ended, HP can still provide you with service and support options.

- Visa and MasterCard holders in the United States or callers from Canada, call:
HP: **1-800-474-6836** (800-HP-invent)
Compaq: **1-800-652-6672** (800-OK-Compaq)
- 1-time technical support,
\$40* USD (Can \$39.99*) per call.
- 1-year unlimited technical support,
\$75* USD (Can \$69.99*).

*Prices are subject to change without notice and may vary based on your product.

Fees are charged to your Visa or MasterCard.

Protect Your Investment

Protect your investment by purchasing an extended service plan. Allow Total Care to provide you with total peace of mind, while you get the most out of your investment. Service coverage begins on product purchase date, and you must purchase the service within the first year after purchasing the computer. The hardware service offering is determined based on the outcome of system self-test programs that you run during your initial call to HP Total Care.

For more information visit:

<http://www.hp.com/go/totalcare> (U.S. only)

or call:

1-866-234-1377

Or

<http://www.hp.ca/totalcare> (Canada only)

or call:

1-877-231-4351

Recycle – HP Planet Partners

HP is sensitive to the environment and has a program, Planet Partners, to make it simple for us to reclaim your old product for recycling. HP will help you recycle your old equipment even if it is not an HP product; we take back all makes and models. Visit our Web site to find out how easy it is to recycle: <http://www.hp.com/recycle>

The information contained herein is subject to change without notice.

Copyright © 2004–2008 Hewlett-Packard Development Company, L.P.

www.hp.com

Printed in



5 9 9 2 - 1 1 0 4