

# Getting Started

The only warranties for Hewlett-Packard products and services are set forth in the express statements accompanying such products and services. Nothing herein should be construed as constituting an additional warranty. HP shall not be liable for technical or editorial errors or omissions contained herein.

HP assumes no responsibility for the use or reliability of its software on equipment that is not furnished by HP.

This document contains proprietary information that is protected by copyright. No part of this document may be photocopied, reproduced, or translated to another language without the prior written consent of HP.

Hewlett-Packard Company  
P.O. Box 4010  
Cupertino, CA 95015-4010  
USA

Copyright © 2000–2007 Hewlett-Packard Development Company, L.P.

This product incorporates copyright protection technology that is protected by U.S. patents and other intellectual property rights. Use of this copyright protection technology must be authorized by Macrovision, and is intended for home and other limited pay-per-view viewing uses only unless otherwise authorized by Macrovision. Reverse engineering or disassembly is prohibited.

Microsoft and Windows Vista are U.S. registered trademarks of Microsoft Corporation.

The Windows logo and Windows Vista are trademarks or registered trademarks of Microsoft Corporation in the United States and/or other countries/regions.

HP supports lawful use of technology and does not endorse or encourage the use of our products for purposes other than those permitted by copyright law.

The information in this document is subject to change without notice.

# Table of Contents

|   |          |
|---|----------|
| <b>Setting Up the Computer .....</b>                                    | <b>1</b> |
| Putting the Computer Together .....                                     | 1        |
| Placing the computer in the proper location .....                       | 1        |
| Using surge protection .....  | 1        |
| Connecting to the computer .....  | 2        |
| Connecting a Digital Camera (Photo or Video).....                       | 8        |
| Connecting Other Devices .....  | 10       |
| Storing Documentation and Recovery Discs.....                           | 10       |
| Adjusting the Monitor.....  | 11       |
| Adjusting the screen resolution by using Vista .....                    | 11       |
| Adjusting the screen resolution by using the NVIDIA Control Panel ..... | 11       |
| Setting Up a Local Area Network .....                                   | 12       |
| Setting Up a Wired (Ethernet) Connection .....                          | 13       |
| Integrated Wireless Devices .....                                       | 14       |
| Connecting the Wireless LAN Device.....                                 | 14       |
| Checking the wireless LAN device installation .....                     | 15       |
| Using wireless security features .....                                  | 16       |
| Connecting a Modem .....  | 16       |

|   |           |
|---|-----------|
| <b>Connecting Speakers or Microphone .....</b>                            | <b>17</b> |
| Sound Connector Types .....   | 17        |
| Connecting a Microphone .....   | 20        |
| Speaker Configurations.....   | 21        |
| Speaker types .....   | 22        |
| Connecting 2/2.1 (Two speakers and a subwoofer) audio speakers.....       | 22        |
| Connecting 4.1 (Four speakers and a subwoofer) audio speakers .....       | 23        |
| Connecting 5.1 (Five speakers and a subwoofer) audio speakers.....        | 25        |
| Connecting 7.1 (Seven speakers and a subwoofer) audio speakers .....      | 26        |
| Connecting your home stereo system (optional) .....                       | 28        |
| 2.1 home stereo installation .....  | 29        |
| 5.1 home audio installation .....   | 30        |
| 5.1 home audio installation procedure.....                                | 31        |
| 7.1 home audio installation .....   | 32        |
| 7.1 home audio installation procedure.....                                | 33        |
| Connecting digital audio .....  | 34        |
| Connecting Headphones .....   | 35        |
| Using a 2.1 speaker system with headphones.....                           | 35        |
| Using a 5.1 to 7.1 speaker system with headphones .....                   | 35        |
| Connecting Speakers Using the Creative Sound Blaster X-Fi Sound Card..... | 36        |
| Connecting the speakers .....   | 36        |
| Connecting the FlexiJack connector.....                                   | 37        |
| <b>Getting Help .....</b>   | <b>39</b> |
| Finding Onscreen Guides.....  | 39        |
| Finding Guides on the Web.....  | 39        |
| Using the Onscreen Help and Support Center .....                          | 40        |
| Using the PC Help & Tools Folder .....                                    | 40        |
| Using the hardware diagnostic tools .....                                 | 40        |
| Using HP Total Care Advisor Software .....                                | 41        |
| <b>Turning On the Computer for the First Time .....</b>                   | <b>43</b> |
| Turning Off the Computer .....  | 44        |
| Using Shut Down .....   | 44        |
| Using Lock.....   | 45        |
| Using Sleep mode .....  | 45        |
| Using Hibernate mode .....  | 46        |
| Automatic Sleep, Hibernate, or Away mode .....                            | 46        |
| Restarting the Computer .....   | 47        |
| Connecting to the Internet.....   | 47        |

|   |           |
|---|-----------|
| Using the Computer with Safety and Comfort .....                            | 48        |
| Setting Up User Accounts .....  | 49        |
| Protecting the Computer .....   | 50        |
| Using passwords .....   | 50        |
| Using antivirus software.....   | 52        |
| Using firewall software.....  | 52        |
| Configuring the computer for automatic Microsoft software updates.....      | 53        |
| Installing critical security updates.....                                   | 54        |
| Guidelines for Installing Software and Hardware Devices.....                | 54        |
| Transferring Files and Settings from an Old Computer to a New Computer..... | 55        |
| <b>Using the Keyboard.....</b>  | <b>57</b> |
| Identifying Keyboard Features.....  | 57        |
| Alphanumeric keys .....   | 57        |
| Function keys .....   | 58        |
| Edit keys.....  | 58        |
| Arrow keys .....  | 58        |
| Numeric keys.....   | 59        |
| Keyboard indicators .....   | 59        |
| Special keyboard buttons .....  | 60        |
| Identifying Special Keyboard Buttons .....                                  | 60        |
| Customizing the keyboard buttons .....                                      | 62        |
| Keyboard Shortcuts.....   | 63        |
| Wireless Mouse and Keyboard Troubleshooting.....                            | 64        |
| Synchronizing a wireless mouse and keyboard .....                           | 64        |
| <b>Using the Mouse .....</b>  | <b>67</b> |
| Using the Mouse Buttons .....   | 68        |
| Scrolling.....  | 68        |
| Autoscrolling.....  | 69        |
| Panning.....  | 69        |
| Changing Mouse Settings.....  | 69        |
| Switching mouse button functions.....                                       | 69        |
| Changing mouse pointer speed.....   | 70        |
| Changing the double-click speed.....  | 70        |
| Turning on the ClickLock option.....  | 70        |
| Changing the scroll wheel speed.....  | 71        |
| Wireless Mouse and Keyboard Troubleshooting.....                            | 71        |

|   |           |
|---|-----------|
| <b>Configuring Speaker and Sound Options .....</b>                      | <b>73</b> |
| Adjusting speaker volume .....  | 74        |
| Selecting a microphone .....  | 75        |
| Configuring audio output .....  | 75        |
| Using the Creative Sound Blaster X-Fi or X-Fi Fatality audio card ..... | 76        |
| Configuring the FlexiJack connector .....                               | 77        |
| Sound Blaster X-Fi configuration modes .....                            | 77        |
| Configuring speakers with Realtek HD Audio Manager .....                | 78        |
| The Realtek HD Audio Manager control screens .....                      | 79        |
| Configuring sound for recording with the Realtek HD Audio Manager ..... | 81        |
| Retasking front panel audio connectors .....                            | 82        |
| Configuring multistreaming audio .....                                  | 83        |
| When to use multistreaming audio .....                                  | 84        |
| Setting up multistreaming audio .....                                   | 84        |
| Configuring audio for Windows Media Center .....                        | 85        |
| Selecting recording devices .....                                       | 86        |
| Resolving sound issues .....  | 86        |
| <b>Using the Windows Media Center Remote Control .....</b>              | <b>87</b> |
| Remote Control Buttons Overview .....                                   | 88        |
| About the Remote Control .....  | 90        |
| Troubleshooting the Remote Control .....                                | 91        |
| Remote sensor is not receiving a signal from the remote control .....   | 91        |
| <b>Introducing Your Computer Software .....</b>                         | <b>93</b> |
| Learning More About Software .....                                      | 93        |
| Using the Desktop .....   | 93        |
| Removing desktop icons .....  | 94        |
| Retrieving desktop icons .....  | 94        |
| Removing files permanently .....  | 94        |
| Using the Windows Start Button Menu .....                               | 94        |
| Using the All Programs menu .....                                       | 94        |
| Organizing the All Programs list .....                                  | 95        |
| Using the Control Panel .....   | 95        |
| Resizing Windows .....  | 96        |
| Working with Digital Images .....                                       | 96        |
| About the Internet .....  | 97        |
| Using a Browser .....   | 98        |
| Searching the Internet .....  | 98        |
| Restricting Internet content .....                                      | 99        |

|  |            |
|--|------------|
| Using the Norton Internet Security Antivirus Software .....              | 100        |
| Configuring and registering Norton Internet Security software .....      | 100        |
| Manually running a scan .....  | 100        |
| Setting a Full System Scan time .....                                    | 101        |
| Setting up a Custom Scan time .....                                      | 101        |
| Sending and Receiving E-Mail.....  | 102        |
| Using Windows Mail .....   | 102        |
| Using the e-mail program provided by your ISP .....                      | 102        |
| Software Quick Reference Table.....                                      | 103        |
| <b>Managing Files .....</b>  | <b>107</b> |
| Organizing Files with Folders.....                                       | 107        |
| Creating Folders.....  | 108        |
| Moving Files .....   | 108        |
| Finding Files .....  | 109        |
| Renaming Files.....  | 110        |
| Deleting Files .....   | 110        |
| Retrieving Files from the Recycle Bin .....                              | 110        |
| Copying Files.....   | 111        |
| Using a Printer .....  | 111        |
| <b>Using CD and DVD Media Drives .....</b>                               | <b>113</b> |
| Using the CD and DVD Drives.....   | 113        |
| Handling CDs and DVDs .....  | 114        |
| Inserting and removing CDs and DVDs.....                                 | 114        |
| Compatibility Information .....  | 115        |
| Disc Features and Compatibility Table .....                              | 116        |
| Optical Drive Quick Reference Table .....                                | 117        |
| Using Blu-ray and HD Disc Drives .....                                   | 118        |
| <b>Using the Memory Card Reader .....</b>                                | <b>119</b> |
| Media Insertion Guide .....  | 120        |
| Understanding the Activity Light .....                                   | 123        |
| Formatting a Memory Card .....   | 123        |
| Troubleshooting the Memory Card Reader.....                              | 124        |
| <b>Using the HP Personal Media Drive and HP Pocket Media Drive .....</b> | <b>125</b> |
| Connecting the Drive .....   | 126        |
| Inserting the Drive into an HP Drive Bay .....                           | 127        |
| Connecting the Drive to a Computer Without a Drive Bay .....             | 128        |
| Locating the Drive and Assigning a Drive Letter .....                    | 129        |
| Using the Drive .....  | 130        |
| Transferring files to another computer manually .....                    | 130        |
| Disconnecting the Drive.....   | 130        |
| Troubleshooting the HP Media Drive .....                                 | 131        |

|  |            |
|--|------------|
| <b>Playing CDs, DVDs, or VCDs .....</b>  | <b>133</b> |
| Using Music.....   | 133        |
| Using Music with Windows Media Center.....                                       | 134        |
| Using the music library.....   | 135        |
| Adding music to the music library.....   | 135        |
| Adding music files from the hard disk drive.....                                 | 135        |
| Adding music files from a CD.....  | 136        |
| Deleting music files from the music library.....                                 | 137        |
| Using supported music file types.....  | 137        |
| Playing Music Files in Windows Media Center.....                                 | 138        |
| Changing the visualization settings.....   | 139        |
| Playing an album in Windows Media Center.....                                    | 140        |
| Playing a song in Windows Media Center.....                                      | 140        |
| Creating a Queue in Windows Media Center.....                                    | 141        |
| Finding and Playing an Album in Windows Media Center.....                        | 141        |
| Using album details.....   | 141        |
| Using Search in Windows Media Center.....  | 142        |
| Searching for music tracks and files.....  | 142        |
| Creating a Playlist in Windows Media Center.....                                 | 143        |
| Copying Music Files to CD in Windows Media Center.....                           | 144        |
| Listening to Online Radio Stations.....  | 146        |
| Playing Music CDs.....   | 146        |
| Playing CDs with Windows Media Player.....                                       | 147        |
| Playing DVDs.....  | 147        |
| Using Windows Media Center to play DVDs.....                                     | 148        |
| Troubleshooting poor playback when playing DVDs.....                             | 148        |
| Using country/region codes.....  | 149        |
| Playing DVD Movies in Windows Media Center.....                                  | 149        |
| Changing the DVD Settings.....   | 150        |
| Changing the DVD movie language.....   | 150        |
| Changing DVD remote control options.....   | 151        |
| Changing DVD closed captioning.....  | 152        |
| Changing DVD Audio Settings.....   | 152        |
| Playing DVDs with Windows Media Player.....                                      | 153        |
| Using DVD Play to Play DVDs, Videos, High-Definition DVDs, and Blu-ray DVDs..... | 153        |
| Playing Video CDs (VCDs).....  | 155        |
| Playing video CDs (VCDs) with Windows Media Player.....                          | 155        |
| <b>Using Windows Media Center .....</b>  | <b>157</b> |
| Setting Up Windows Media Center.....   | 158        |
| Completing the setup wizard.....   | 158        |
| Windows Media Center Start Menu.....   | 160        |
| Windows Media Center Start menu items.....                                       | 160        |



|   |            |
|---|------------|
| Windows Media Center Features .....   | 161        |
| The right music for the moment .....  | 162        |
| Playing Internet radio .....  | 162        |
| Sharing your digital memories.....  | 162        |
| Transforming your living space into a theater .....                               | 163        |
| Online media.....   | 163        |
| Navigating Windows Media Center .....   | 163        |
| Opening Windows Media Center with a mouse.....                                    | 163        |
| Opening Windows Media Center with the Windows Media Center<br>remote control..... | 164        |
| Using the Windows Media Center menu bars .....                                    | 164        |
| Selecting items in Windows Media Center.....                                      | 165        |
| Windows Media Center control menu .....   | 166        |
| Changing Windows Media Center Settings .....                                      | 166        |
| Windows Media Center Settings categories.....                                     | 167        |
| Using Windows Media Center power settings.....                                    | 168        |
| <b>Creating Audio and Data Discs .....</b>  | <b>169</b> |
| Erasing Rewritable Discs Before Recording .....                                   | 170        |
| Working with Audio CDs .....  | 170        |
| Audio CD tips .....   | 171        |
| Before you begin creating discs.....  | 172        |
| Creating audio CDs .....  | 172        |
| Creating video discs .....  | 173        |
| Copying a disc .....  | 174        |
| Creating data discs.....  | 175        |
| Making a disc label using LightScribe Technology .....                            | 175        |
| Making a paper disc label.....  | 177        |
| <b>Working with Pictures and Videos .....</b>                                     | <b>179</b> |
| Working with Digital Images .....   | 179        |
| Viewing Pictures in Windows Media Center .....                                    | 180        |
| Adding Pictures in Windows Media Center .....                                     | 180        |
| Adding picture files from the hard disk drive .....                               | 180        |
| Viewing Pictures in Windows Media Center .....                                    | 181        |
| Viewing pictures as a slide show .....  | 182        |
| Viewing a slide show with music .....   | 182        |
| Using supported picture file types in Windows Media Center.....                   | 183        |
| Editing Pictures in Windows Media Center .....                                    | 184        |
| Fixing red eye or contrast.....   | 184        |
| Cropping pictures in Windows Media Center .....                                   | 184        |
| Rotating pictures.....  | 185        |
| Printing Pictures in Windows Media Center .....                                   | 186        |
| Copying Pictures to CDs and DVDs in Windows Media Center .....                    | 186        |

|   |            |
|---|------------|
| Playing Videos in Windows Media Center .....                  | 187        |
| Playing digital videos.....                                   | 187        |
| Using supported video file types .....                        | 188        |
| Transferring and Recording Video Files .....                  | 188        |
| Recording analog and digital video files .....                | 188        |
| Creating a DVD from Video Files in Windows Media Center ..... | 189        |
| <b>Creating Movies by Using muvee autoProducer.....</b>       | <b>191</b> |
| Basic steps for making a movie .....                          | 191        |
| Using muvee autoProducer .....                                | 193        |
| Getting started .....   | 193        |
| Capturing video from a digital video camera .....             | 195        |
| Adding videos.....  | 196        |
| Adding pictures.....  | 198        |
| Adding music.....   | 199        |
| Selecting the style .....                                     | 199        |
| Changing the settings.....                                    | 200        |
| Making the movie.....   | 201        |
| Previewing the movie .....                                    | 202        |
| Modifying the movie .....                                     | 202        |
| Saving the movie project .....                                | 204        |
| Recording the movie project to disc .....                     | 205        |
| Upgrading muvee autoProducer .....                            | 206        |
| Supported muvee autoProducer output file types .....          | 206        |
| <b>Index.....</b>   | <b>207</b> |

# Setting Up the Computer



**WARNING:** The power supply is preset for the country/region in which you purchased your computer. If you move, please check the voltage requirements for your new location before plugging the computer into an AC power outlet.

---



**WARNING:** Please read “Safety Information” in the *Limited Warranty and Support Guide* before installing and connecting the computer to the electrical power system.

---

## Putting the Computer Together

Follow the steps on the setup poster to set up the computer. Read the topics in this section to learn more about the location of components and connectors on the computer, and to learn about some setup alternatives.

Look in the computer box for printed details or updates regarding the computer.

### Placing the computer in the proper location

When setting up your new computer, place it where ventilation openings are unobstructed. Make sure that all connections are secure and that all cabling is out of the way. Do not place cabling in walkways or where it can be stepped on or damaged from placing furniture on it.

### Using surge protection

Help protect the monitor, computer, and accessories by connecting all power cords for the computer and peripheral devices (such as a monitor, printer, or scanner) to a surge protection device, such as a power strip with surge protection or an uninterruptible power supply (UPS). Many surge protection devices have surge protection inputs and outputs for modem or telephone lines. Telephone lines are a common path for lightning spikes to get into the system. Some surge protection devices have surge protection for television cable connections as well. Use those if the computer has a television tuner installed.

Not all power strips provide surge protection; the power strip must be specifically labeled as having this capability. Use a power strip whose manufacturer offers a damage replacement policy that replaces the equipment if surge protection fails.







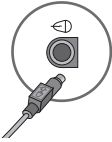

## Connecting to the computer

Connect the main hardware devices, such as the monitor, keyboard, and mouse, to the back of the computer. Other peripheral devices, such as a printer, scanner, or camera, also plug into connectors on the back of the computer. Some computers also have connectors on the front of the computer. The following table shows some, but not all, connectors:





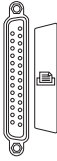











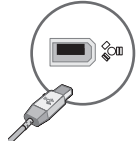

---















**NOTE:** The location, availability, and number of connectors on the computer may vary.











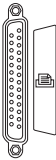



---









| Connector   | Icon/Label  | Description and function   |
|---|---|--|
|    |    | Mouse (PS/2 connector).  |
|   |    | Keyboard (PS/2 connector).   |
|  |  | Universal Serial Bus (USB) for mouse, keyboard, digital cameras, or other devices with USB connectors. |
|  |  | Printer (parallel).  |
|  | Serial  | Serial port for some digital cameras or other serial devices.  |

---









| Connector   | Icon/Label  | Description and function (continued)  |
|---|---|---|
|    |          | Audio Line Out (powered speakers).  |
|    |          | Audio Line In.  |
|    |          | Headphones.   |
|    |          | Microphone.   |
|    |          | FireWire® (IEEE 1394) for video cameras or other devices with very fast transfer rates.<br><b>NOTE:</b> You must use a 6-pin FireWire (IEEE 1394) transfer cable with this 6-pin connector. |
|  | digital audio<br>in out   | Digital audio in and digital audio out.   |
|  |  side  | Side speaker out.   |
|  |  rear  | Rear speaker out.   |
|  |  c/sub | Center/Subwoofer.   |
|  | S-Video 2   | Secondary S-video connector to connect a VCR, video camera, or other analog source to the computer.   |

| Connector   | Icon/Label  | Description and function (continued)   |
|---|---|--|
|    | Composite Video 2   | Secondary Composite video connector (yellow) to connect to a VCR, video camera, or other analog source to the computer.  |
|    | A/V In Audio 2 L  | Secondary Left audio input connector (white).<br><b>NOTE:</b> This Audio In connector is connected to the TV tuner. You must use the Audio In connector, which is connected to the motherboard and located on the back of the computer, to record audio only (select models only). |
|    | A/V In Audio 2 R  | Secondary Right audio input connector (red).<br><b>NOTE:</b> This Audio In connector is connected to the TV tuner. You must use the Audio In connector, which is connected to the motherboard and located on the back of the computer, to record audio only (select models only).  |
|    |    | Headphones Out connector (green) to connect to headphones.   |
|   |  | Microphone In connector (pink) to connect to a microphone.   |
|  |  | Universal Serial Bus (USB) 2.0 connector to connect to a mouse, keyboard, digital camera, or another device with a USB connector.  |
|  |   | Power connector.   |
|  |  | Mouse connector to connect a mouse.  |
|  |  | Keyboard connector to connect a keyboard.  |

| Connector   | Icon/Label   | Description and function (continued)   |
|---|--|--|
|    |           | Printer (parallel) connector to connect a parallel printer (select models only).   |
|    |           | Universal Serial Bus (USB) 2.0 connector to connect a mouse, keyboard, digital camera, or another device with a USB connector.   |
|    | <b>ETHERNET</b>  | <p>Ethernet LAN connector is a network interface adapter (also called a network interface card, or NIC) that connects to an Ethernet (10BaseT) or Fast Ethernet (100BaseT) network hub.</p> <p>Connect this adapter on the computer with your local area network (LAN) hub or any broadband connection.</p> <p>The green LED indicates a valid connection.</p> |
|    |           | Microphone In (Mic) (pink) to connect to a microphone (also functions as a center/subwoofer Line Out when a multichannel audio configuration is activated).  |
|  | <br>OUT | Audio Line Out (green) to connect front speakers.  |
|  | <br>IN  | Audio Line In (blue) connector to connect to an analog audio device such as a CD player for input into computer (also functions as rear Line Out when a multichannel audio configuration is activated).  |
|  | Center   | Line C/Sub (gold) connector to connect Center/Subwoofer speakers in a multichannel audio configuration.  |
|  | Rear   | Line Rear (black) connector to connect rear speakers in a multichannel audio configuration.  |
|  | Side   | Line Side (gray) connector to connect side speakers in an eight-speaker system (7.1).  |
|  | S-Video  | S-video In connector to connect from a set-top box output connector.   |

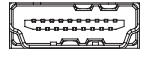
| Connector   | Icon/Label       | Description and function (continued)  |
|---|------------------|---|
|    | Composite Video  | Composite Video In connector (yellow) to connect to a TV set-top box.   |
|    | A/V In Audio 1 L | Primary left audio input from set-top box connector (white).<br><b>NOTE:</b> Audio can be recorded by using this Audio In connector, which is connected to the motherboard. Some computers include this primary left audio input connector on the front of the computer (select models only). |
|    | A/V In Audio 1 R | Primary right audio input from set-top box connector (red).<br><b>NOTE:</b> Audio can be recorded by using this Audio In connector, which is connected to the motherboard. Some computers include this primary right audio input connector on the front of the computer (select models only). |
|    | TV/Cable Ant     | TV In (TV antenna or cable input from wall outlet with no set-top box).   |
|   | ATSC             | TV In connector for TV cable or antenna, which receives ATSC channels (Advanced Television System Committee), which are over-the-air digital transmission channels.   |
|  | CATV             | TV In connector for TV cable or antenna, which receives CATV (Community Antenna Television) or cable TV channels.   |
|  | NTSC             | TV In connector for TV cable or antenna, which receives NTSC channels (National Television System Committee), which are over-the-air analog transmission channels.  |
|  | FM Ant           | FM In (radio antenna input) connector, which connects to the FM antenna cable.<br>Plug the FM radio antenna cable into the FM In port on the back of the computer on the TV tuner card. You may want to extend the ends of the cable to improve your FM radio signal reception.               |



| Connector   | Icon/Label   | Description and function (continued)  |
|---|--|---|
|    |                 | Modem (Line In RJ-11) (select models only).<br>Plug the modem cable (provided in the computer box) into the computer modem connector on the back of the computer. Plug the other end to the telephone line wall jack connector.   |
|    | Analog Video   | Analog Video Out: S-video or composite video connector (select models only), which connects to a TV.  |
|    | VGA/Monitor<br> | VGA/Monitor (blue) display output connector, which connects to a VGA monitor. You may need to use a VGA-to-DVI adapter to connect the display to the computer.  |
|    | HDMI   | HDMI display output connector, which connects to an HDMI monitor or TV display. You may need to use a HDMI-to-DVI adapter to connect the display to the computer.   |
|    | DVI  | Digital video output connector, which connects to a TV or monitor (select models only). You may need to use a VGA-to-DVI or a HDMI-to-DVI adapter to connect the display to the computer.<br><br>See the documentation that came with the display device.   |
|  | digital audio<br>in out  | Digital audio input (white) connector, which connects to a digital audio device with digital input (such as a home audio receiver/amplifier) or digital speakers (select models only).<br><br>Digital audio output (red) connects to a digital audio device with digital output (select models only). |
|  | Digital Audio<br>Out   | Digital Out (orange) connector, which connects to a digital audio device with digital input (such as a home audio receiver/amplifier) or digital speakers (select models only).   |

# Connecting a Digital Camera (Photo or Video)

The following instructions apply only to digital photo cameras and digital video cameras.

---

**NOTE:** When connecting an analog video camera to the computer, use the Video and Audio In connectors on the front or back of the computer.

---

Refer to the documentation that came with your digital photo camera or digital video camera.

To connect a digital photo camera or a digital video camera:

- 1 Turn on the computer, and wait for the Microsoft® Windows Vista® operating system to start.

---

**NOTE:** If a Digital Video Device AutoPlay window appears when you connect the camera, click **Cancel**.

---

- 2 Connect the 6-pin video camera transfer cable into the camera, and then into an open port on the front or back of the computer. Most digital video cameras use either the FireWire (IEEE 1394) port or the USB port.

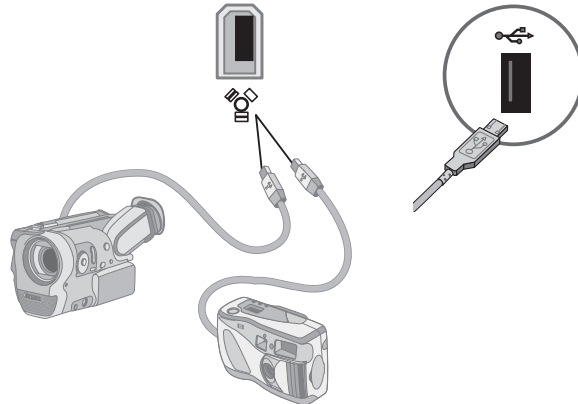

- 3 A *Found New Hardware* message appears. Wait 2 or 3 minutes for Windows Vista to make the necessary settings for the new device. When installation is complete, a message appears, indicating that the camera is ready to use.
- 4 You may need to install driver software for your camera. If so, Windows displays a message asking if you want to locate and install driver software. Insert the driver software CD, click **Locate and install driver software**, and then follow any onscreen instructions to install the software.

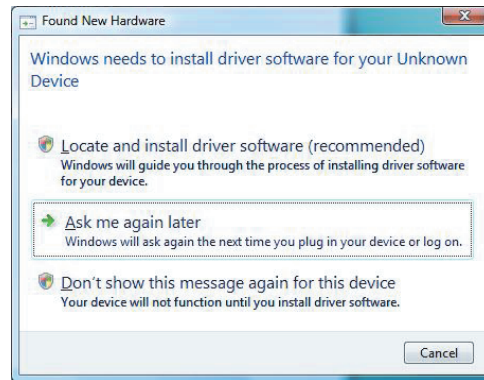

If the computer does not recognize the digital photo camera or the digital video camera:

- 1 Click the **Windows Start Button**®  on the taskbar, and then click **Control Panel**.
- 2 Click **System and Maintenance**, and then click **System**.
- 3 Click **Device Manager**.
- 4 Click the plus sign (+) next to the camera port. If the name of the camera appears, the device is ready. If the name is not there, try the following:
  - Click **Action**, and then click **Scan for hardware changes**. Look in Device Manager for a new addition under the port.
  - Unplug the video camera transfer cable from the computer, and plug it into a different port. Look in Device Manager for a new addition under the port.

## Connecting Other Devices

Other peripheral devices can be connected to the front or back of the computer by using USB or FireWire (IEEE 1394) ports. These peripheral devices include printers, scanners, video cameras, digital photo cameras, memory card readers, and PDAs (personal digital assistants) or handheld computers. Refer to the documentation that came with your device.

---

**NOTE:** Some peripheral devices are not included with the computer.

---

**NOTE:** You must use a 6-pin (not a 4-pin) FireWire (IEEE 1394) cable with the 6-pin FireWire (IEEE 1394) connector on the computer.

---

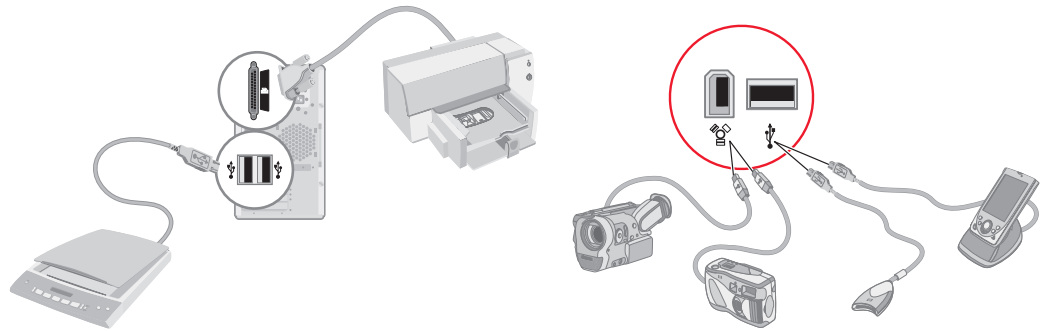

## Storing Documentation and Recovery Discs

Store all computer user manuals and warranty information in an easy-to-find, safe location. It is a good idea to store the system recovery discs with the documentation. This allows easy access to all important computer documents and files.

# Adjusting the Monitor

## Adjusting the screen resolution by using Vista

To change the screen resolution by using Vista:

- 1 Right-click an empty area of the desktop, and then click **Personalize**.
- 2 Click **Display Settings**.
- 3 If necessary, select the monitor, and then adjust the screen resolution by using the slider under Resolution.
- 4 Click **Apply**.
- 5 Click **Yes**, if it is present.
- 6 Click **OK**.

---

**NOTE:** You can connect more than one display device (CRT monitor, flat panel monitor, TV, and so on) to the computer at a time (select models only). You can quickly change which device displays the computer desktop by pressing Alt+F5. Each time you press Alt+F5, the computer desktop appears on the next device. If pressing Alt+F5 does not work, restart the computer and try again.

---

## Adjusting the screen resolution by using the NVIDIA Control Panel

To change the screen resolution by using the NVIDIA Control Panel:

- 1 Right-click an empty area of the desktop, and then click **NVIDIA Control Panel**.
- 2 Select **Standard** or **Advanced** and then click **OK**.
- 3 Under Display, click **Change resolution**.
- 4 If necessary, select the display, and then adjust the screen resolution by using the slider under Display resolution.
- 5 Click **Apply**, and then click **Yes** if you want to apply that resolution.

Or

Click **No**, and change the resolution by using the slider under Display resolution again, click **Apply** and then click **Yes**.

# Setting Up a Local Area Network

A home local area network (LAN) may consist of either a wired or a wireless network that you can use to connect the computer to other devices on the network, including other computers. The network components may include a hub or a switch, which can connect multiple devices to the network, or a router, which can connect computers or a broadband Internet connection to the network. This network connection also enables you to share data and printers or other devices among your computers. The network connection to the Internet is usually through a dial-up or cable modem.

A *wired network* uses Ethernet cables to connect the devices on the network. For example, the Ethernet cable plugs into the computer network interface adapter and the router.

A *wireless network* uses radio waves to connect the devices on the network. For example, both the computer and the router have an antenna and adapter that use the same Wi-Fi industry standard: 802.11n, 802.11b, 802.11g, or 802.11a.

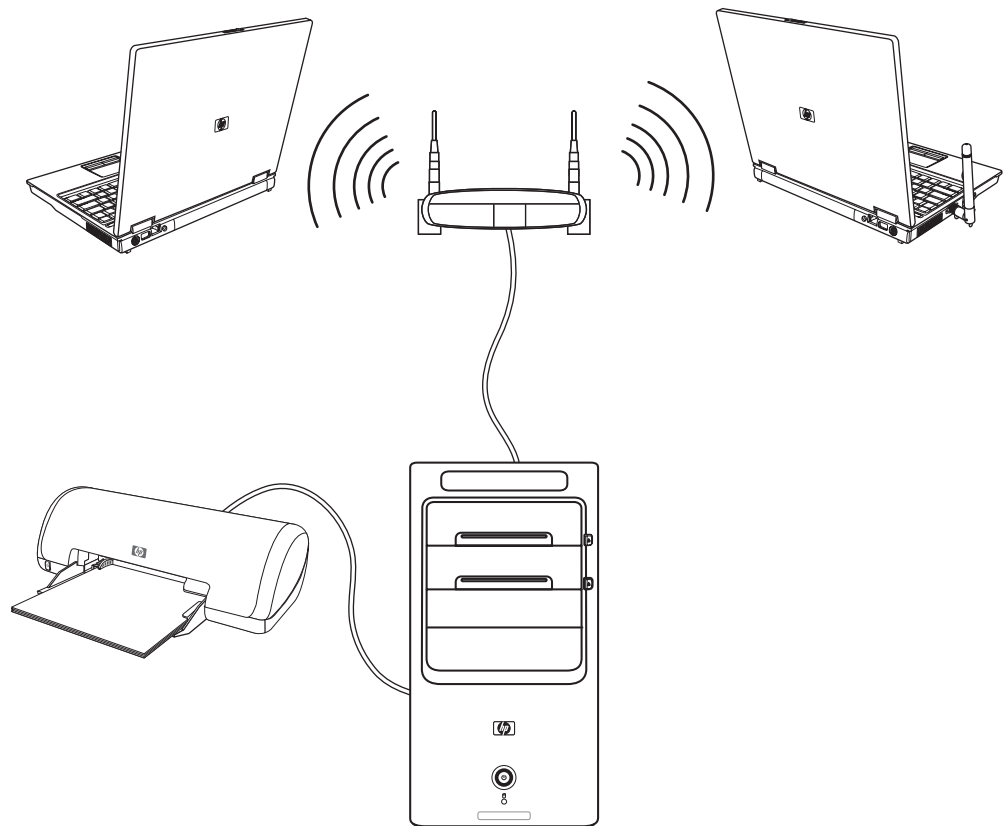

The preceding illustration shows a home LAN. The desktop computer has a wired connection to a wireless router. The desktop computer also has a printer that it shares with the other computers on the network. Each notebook computer has a wireless connection to the network router.

# Setting Up a Wired (Ethernet) Connection

The *Ethernet* connection, which may be called network interface adapter, Network Interface Card, or NIC, provides a high-speed or broadband connection to an Ethernet (10BaseT) or Fast Ethernet (100BaseT) network. After you connect this interface to a network, such as a LAN, you can connect to the Internet through the network.

- 1 Connect an Ethernet cable to the Ethernet connector (**A**) on the back of the computer, and to the network router or LAN device.

---

**NOTE:** Your computer may not come with an Ethernet connector.

---

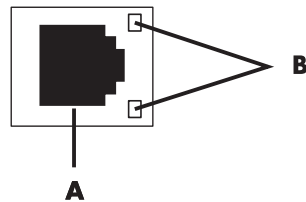

**A** Ethernet connector (RJ-45 port)

**B** Ethernet indicator lights

- 2 With the computer turned on, check the indicator lights (**B**) next to the Ethernet connector for the status:
  - **ACTIVITY** — Lit yellow during network data transfer activity
  - **LINK** — Lit green when there is a valid network connection

---

**NOTE:** Your Ethernet connector may have only one indicator light.

---

# Integrated Wireless Devices

Wireless technology transfers data across radio waves instead of wires. Your computer may be equipped with one or more of the following integrated wireless devices:

- **Wireless local area network (WLAN) devices** connect the computer to wireless local area networks (commonly referred to as wireless networks, wireless LANs, or WLANs) in corporate offices, your home, and public areas such as airports and restaurants. In a WLAN, each mobile wireless device communicates with a wireless access point, which can be several hundred feet away.

Computers with WLAN devices may support one or more of the four IEEE physical layer industry standards: 802.11n, 802.11b, 802.11g, or 802.11a.

- **Bluetooth devices** create a personal area network (PAN) to connect to other Bluetooth-enabled devices such as computers, phones, printers, headsets, speakers, and cameras. In a PAN, each device communicates directly with the other devices, and the devices must be relatively close together—within 33 feet (10 meters) of each other.
- **Wireless wide area network (WWAN) devices** provide access to information anytime and anywhere that you have cellular (data) coverage. In a WWAN, each mobile device communicates to a public carrier's base station. Public carriers install networks of base stations (similar to cell phone towers) throughout large geographic areas, effectively providing coverage across entire states, or even entire countries/regions.

For more information about wireless technology, go to:  
**<http://www.hp.com/go/techcenter/wireless>**

## Connecting the Wireless LAN Device

### (Select models only)

You can connect the computer to an 802.11n (select models only), 802.11b or 802.11g wireless network by using the external antenna that was included with the system. This device enables you to establish a wireless network using the computer as a wireless access point, or you can use the computer as a wireless client (Station Mode) if you already have a wireless network running.

You need an existing wireless LAN with an Internet connection (consult your Internet Service Provider for further information). An external antenna is supplied with the system; you must connect it to the 802.11 module to increase the range and sensitivity of the radio.



To connect the wireless LAN antenna:

- 1 Screw the wireless LAN antenna cable into the wireless LAN connector on the back of the computer.
- 2 For the best wireless performance, place the antenna on the computer or in an elevated and open area.

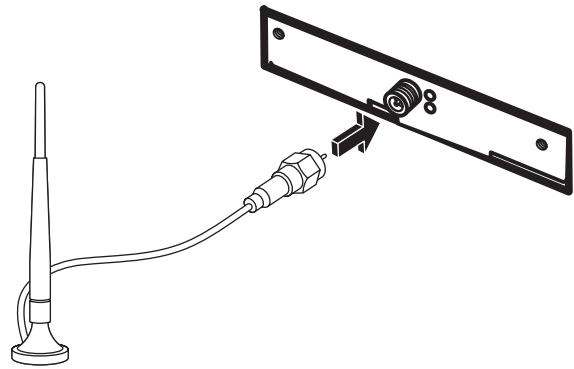

---

**NOTE:** The appearance of your wireless antenna may vary.

---

## Checking the wireless LAN device installation

To set up your wireless network, verify that the integrated WLAN device is installed on the computer correctly:

- 1 Click the **Windows Start Button**  on the taskbar.
- 2 Type *Device Manager* into the Start Search box, and then click **Device Manager** to open the Device Manager window.
- 3 Click **Network adapters**. Your WLAN device should be listed here. The WLAN device may include the term *wireless*, *wireless LAN*, or *802.11*.

---

**NOTE:** If no WLAN device is listed, either the computer does not have an integrated WLAN device, or the driver for the device is not properly installed.

---

- 4 Click the **Windows Start Button**  on the taskbar.
- 5 Type *Network and Sharing Center* into the Start Search box, and then click **Network and Sharing Center** to open the Network and Sharing Center window.
- 6 Click **Connect to a network**, and then follow onscreen instructions.

For more information about setting up a wireless network:

- Click the **Windows Start Button** , click **Help and Support**, and then type *Setting up a wireless network* into the Search Help box.
- Go to: <http://www.hp.com/go/techcenter/wireless> (English only).
- Go to: <http://hp.com/support> and search for wireless topics.

## Using wireless security features

When you set up a home WLAN or access an existing public WLAN, always enable security features to protect the network from unauthorized access. The most common security levels are Wi-Fi Protected Access Personal (WPA-Personal) and Wired Equivalent Privacy (WEP).

When setting up a network, HP recommends that you use one or more of the following security measures:

- Enable WPA-Personal or WEP security encryption on the router.
- Change the default network name (SSID) and password.
- Set up a firewall.
- Set security on your Web browser.

For more information about setting up wireless security features, go to:  
**<http://www.hp.com/go/techcenter/wireless>**

## Connecting a Modem

For information on connecting to the Internet, see “Connecting to the Internet” in this guide.

The modem is used for connecting to an ISP that provides a telephone dial-up connection to the Internet.

---

**NOTE:** Your computer may not come with a modem.

---

Before you can use telephone dial-up to connect to the Internet and send or receive e-mail and faxes, you must connect your telephone service line to the modem (**A**), which is on the back of the computer (**B**). The setup poster shows you how to plug a modem/telephone cable into the computer modem connector and into the telephone service line wall jack connector.

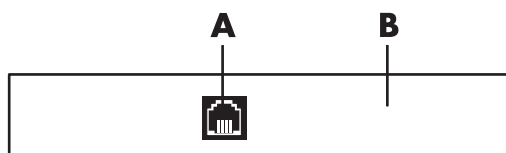

- A** Modem connector  
**B** Back of computer

# Connecting Speakers or Microphone

Speakers are included with the monitor (select models only), or they are sold separately.

---

**NOTE:** For product information on the HP Support Web site, go to:  
<http://www.hp.com/support>

---

For details about connecting stereo speakers to the computer, see the setup poster.

---

**NOTE:** Speakers may be *passive* (no power button or power cord) or *active* (power button or power cord). Your computer supports only active (powered) speaker systems; the speaker system must have its own power cord.

A *stereo speaker set* is a left-right, two-channel speaker system. A *multichannel audio speaker system* is a system with more than two channels, and it may include a subwoofer. For example, 5.1 channels, referred to as *six-speaker mode*, uses two front speakers (left-right), two rear speakers (left-right), a center speaker, and a subwoofer.

---

If the computer has multichannel audio speaker capacity (select models only), you can connect four channels for four-speaker output, or six channels for 5.1 speaker output.

Connect the speaker system to the computer, and then configure the audio software for sound output.

## Sound Connector Types

Your model may include one of three analog sound connector types on the back of the computer:

- Three connectors
- Six connectors
- Audio card



The connectors are 3.5 mm (1/8-inch) stereo mini-jacks that connect from the back of the computer to speakers and microphones.

Your system may also have a separate Digital Out connector (select models only).

Software configuration is different for each connector type, as noted in the instructions.

**NOTE:**

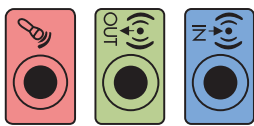
- Type 3 has three connectors.
- Type 6 has six connectors.
- Type S has audio card.

| Sound connector      |  | Illustration  | Type     |
|----------------------|--|---|----------|
| Three connectors     | Your computer model may include three sound connectors. You can connect up to a 5.1 audio system to the computer.  |  | <b>3</b> |
| Six connectors       | Your computer model may include six sound connectors on the back of your computer. You can connect up to a 7.1 audio system to the computer.                                 |  | <b>6</b> |
| Audio card connector | Your computer may include a audio card. You can connect up to a 5.1 audio system (7.1 audio system for select models) or digital speakers to the audio card on the computer. | See the following illustrations.  | <b>S</b> |

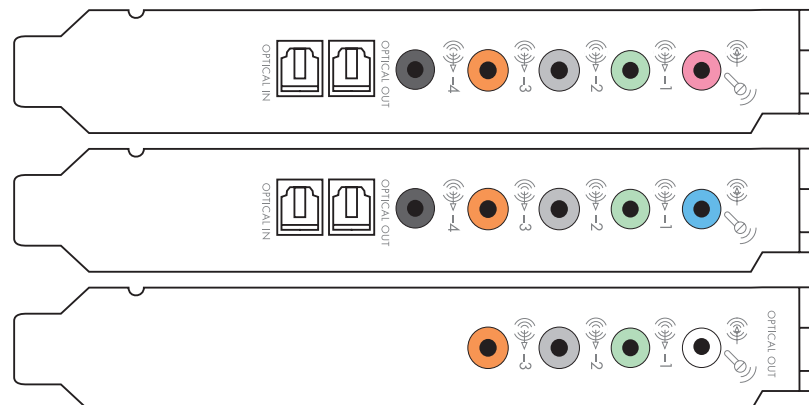



When installing cables, use the sound connectors that match your computer model, as shown in the installation procedure steps.

The following table shows the sound connectors on the back panel of computer systems.

| Sound connector   |   |   | Description   |
|---|---|---|---|
| Type 3  | Type 6  | Type 5  |   |
|    |   |    | Line <b>Side</b> (gray) connects to side left and right analog speakers in an eight-speaker system (7.1).   |
|   |    |    | Line <b>C/Sub</b> (gold) connects to front center/subwoofer speakers in a multichannel audio configuration.   |
|   |    |    | Line <b>Rear</b> (black) connects to rear left and right analog speakers in a multichannel audio configuration.   |
|    |    |    | Line <b>Out</b> (lime green) connects to front left and right analog speakers.  |
|    |    |    | <b>Mic</b> (pink) connects to a microphone.<br>(Type 3 also functions as center/subwoofer Line Out when a multichannel audio configuration is enabled.)   |
|  |  |  | Line <b>In</b> (light blue) connects to an analog audio device such as a CD player for input into computer.<br>(Type 3 also functions as rear Line Out when a multichannel audio configuration is enabled.)   |
|  |  |  | <b>Digital Audio Out</b> or <b>SPDIF Out</b> (orange) connects to a digital audio device with digital input (such as a home audio receiver/amplifier) or to digital speakers (select models only).  |
|   |   |  | <b>FlexiJack</b> (pink) connects to analog Line In devices or a microphone.<br>The FlexiJack supports two functions. You must select either the microphone or the Line In function in the Creative Console Launcher. See "Configuring the FlexiJack connector." |

## Sound connector (continued)

| Type 3 | Type 6 | Type S  | Description   |
|--------|--------|---|---|
|        |        |  | <b>FlexiJack</b> (blue) connects to analog Line In devices or a microphone.<br><br>The FlexiJack supports two functions. You must select either the microphone or the Line In function in the Creative Console Launcher. See “Configuring the FlexiJack connector.” |
|        |        |  | <b>Optical In</b> (optical SPDIF input) connects recording devices such as a mini disc recorder, digital audio tape recorder, or external hard disk recorder.   |
|        |        |  | <b>Optical Out</b> (optical SPDIF output) connects playback devices such as a mini disc player, digital audio tape player, or DVD player.   |

### NOTE:

- Type 3 has three connectors.
- Type 6 has six connectors.
- Type S has audio card.

## Connecting a Microphone

Your computer comes with one microphone connector in the back of the computer. Some models have a second microphone connector in the front of the computer. Only one microphone connector works at a time, and the back connector is ready to use unless you have the multichannel audio speakers option. For computers with the multichannel audio speakers option, the microphone connector in the front of the computer, if present, is ready to use.

To use a microphone connected to the front of your computer (select models only), select the working microphone. See “Selecting a microphone.”

HP computers support many different audio options, sound connections, and speaker configurations. You may set up your computer for two stereo speakers or for multichannel audio speaker systems. Connect your speaker system to the computer, and then configure the audio software for sound output. For more details about connecting stereo speakers to the computer, see the setup poster.

This chapter describes the most typical options. Your system may have different components.

Speakers are included with the monitor (select models only) or are sold separately.

**NOTE:** For additional information on connecting the speakers, refer to the setup poster that came with the computer and the documentation that came with your speakers.

# Speaker Configurations

You may set up your computer for the following supported configurations:

| <b>Name</b>          | <b>Speaker system</b>   | <b>See</b>  |
|----------------------|---|---|
| Headphones           | None, muted.  | "Connecting Headphones."  |
| 2 (stereo)           | Left speaker, right speaker.  | "Connecting 2/2.1 (Two speakers and a subwoofer) audio speakers." |
| 2.1                  | Left speaker, right speaker, and a subwoofer.   | "Connecting 2/2.1 (Two speakers and a subwoofer) audio speakers." |
| 4.1                  | Two front speakers, two rear speakers, and a subwoofer.   | "Connecting 4.1 (Four speakers and a subwoofer) audio speakers."  |
| 6/5.1                | Two front speakers, two rear speakers, a center speaker, and a subwoofer.   | "Connecting 5.1 (Five speakers and a subwoofer) audio speakers."  |
| 8/7.1                | Two front speakers, two rear speakers, two side speakers, a center speaker, and a subwoofer (select models only). | "Connecting 7.1 (Seven speakers and a subwoofer) audio speakers." |
| Home audio system    | Home stereo or home theater audio system with passive speakers.   | "Connecting your home stereo system (optional)."                  |
| Digital audio        | Digital speakers or digital input connector on audio system.  | "Connecting digital audio."                                       |
| Multistreaming audio | Two front speakers, two rear speakers, two side speakers, a center speaker, and a subwoofer (select models only). | "Configuring multistreaming audio."                               |

## Speaker types

Speakers may be included with the monitor (select models only) or are sold separately. Refer to the product documentation for your speakers.

Your computer supports only an active (powered) speaker system. An active speaker system must have its own power cord. A home audio system does not require active speakers, because the receiver provides amplification.

A stereo speaker set is a left-right, two-channel speaker system. A multichannel audio speaker system has a left-right front and left-right rear channel, and it may include a subwoofer and a center speaker. Side speakers are included in more advanced systems. A subwoofer provides enhanced bass sounds.

".1" indicates a subwoofer. For example, 7.1 channels refers to an eight-speaker mode and uses two front speakers (left-right), two side speakers (left-right), two rear speakers (left-right), a center speaker, and a subwoofer.

## Connecting 2/2.1 (Two speakers and a subwoofer) audio speakers

To connect simple left/right stereo active speakers or two speakers and a subwoofer for two-channel (2.1 speaker) output:

- 1 Turn off the computer.
- 2 Connect the speaker cable to the lime green Audio Line Out connector that matches the back of your computer.

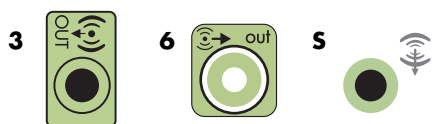

---

### NOTE:

- Type 3 is three connectors.
  - Type 6 is six connectors.
  - Type S is sound card.
- 
- 3 Connect the cable to the audio system. For 2.1 speakers that were shipped with your computer (select models only), connect the Audio Line Out connector to the subwoofer.
  - 4 Connect the left and right speakers to the subwoofer. Refer to the speaker documentation.



5 Turn on the computer.

---

**NOTE:** Always turn on the computer before you turn on the speaker system.

---

6 Plug in the speaker system power.

7 Turn on the speaker system.

Step 8 is optional for a two-speaker setup.

8 After the speakers are connected to the computer, configure the audio software for sound output for your computer model. See "Connecting Speakers or Microphone."

- Type 3: See "Configuring speakers with Realtek HD Audio Manager."
- Type 6: See "Configuring speakers with Realtek HD Audio Manager."
- Type S (audio card): See "Using the Creative Sound Blaster X-Fi or X-Fi Fatality audio card."

The following diagram shows a typical 2.1 audio installation:

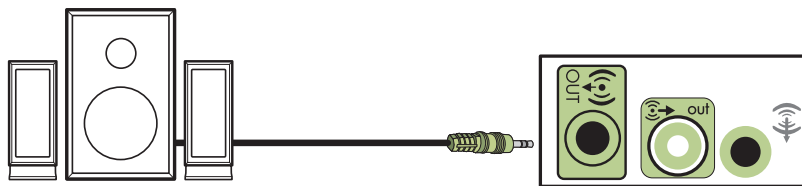

## Connecting 4.1 (Four speakers and a subwoofer) audio speakers

To connect two front speakers, two rear speakers, and a subwoofer for four-channel (4.1 speaker) output:

- 1 Turn off the computer.
- 2 Connect the front speaker cable to the lime green Audio Line Out connector that matches the back of your computer.

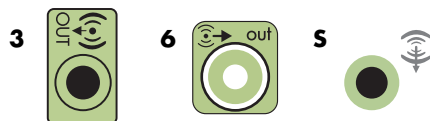

---

**NOTE:**

- Type 3 is three connectors.
  - Type 6 is six connectors.
  - Type S is sound card.
-

- 3 Connect the rear speaker cable to the black connector that matches the back of your computer.



For type 3-connector systems, the blue Audio Line In connector functions as a Rear Line Out when a multichannel audio configuration is activated.

- 4 Connect the cables to the audio system.
- 5 Connect the front and rear speakers to the subwoofer. Refer to the speaker documentation.
- 6 Turn on the computer.

---

**NOTE:** Always turn on the computer before you turn on the speaker system.

---

- 7 Plug in the speaker system power.
- 8 Turn on the speaker system.
- 9 After the speakers are connected to the computer, configure the audio software for sound output for your computer model. See “Configuring Speaker and Sound Options.”
  - Type 3: See “Configuring speakers with Realtek HD Audio Manager.”
  - Type 6: See “Configuring speakers with Realtek HD Audio Manager.”
  - Type S (audio card): See “Using the Creative Sound Blaster X-Fi or X-Fi Fatality audio card.”

The following diagram shows a typical 4.1 audio installation:

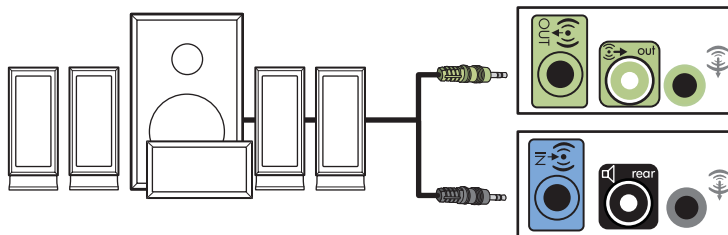

## Connecting 5.1 (Five speakers and a subwoofer) audio speakers

To connect two front speakers, two rear speakers, a center speaker, and a subwoofer for six-channel (5.1 speaker) output:

- 1 Turn off the computer.
- 2 Connect the front speaker cable to the lime green Audio Line Out connector that matches the back of your computer.

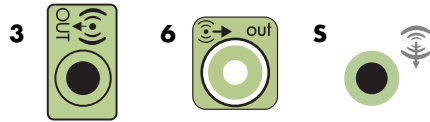

---

### NOTE:

- Type 3 is three connectors.
  - Type 6 is six connectors.
  - Type S is sound card.
- 

- 3 Connect the rear speaker cable to the black connector that matches the back of your computer.



For type 3-connector systems, the blue Audio Line In connector functions as a Rear Line Out when a multichannel audio configuration is activated.

- 4 Connect the center/subwoofer speaker cable to the gold (or pink Mic) connector that matches the back of your computer.



For type 3-connector systems, the pink Mic connector functions as a center/subwoofer speaker Line Out when a multichannel audio configuration is activated.

- 5 Connect the cables to the audio system.
- 6 Connect the front, rear, and center speakers to the subwoofer. Refer to the speaker documentation.
- 7 Turn on the computer.

---

**NOTE:** Always turn on the computer before you turn on the speaker system.

---

- 8 Plug in the speaker system power.
- 9 Turn on the speaker system.
- 10 After the speakers are connected to the computer, configure the audio software for sound output for your computer model. See “Configuring Speaker and Sound Options.”
  - Type 3: See “Configuring speakers with Realtek HD Audio Manager.”
  - Type 6: See “Configuring speakers with Realtek HD Audio Manager.”
  - Type 6 — multistreaming: See “Configuring multistreaming audio.”
  - Type S (audio card): See “Using the Creative Sound Blaster X-Fi or X-Fi Fatality audio card.”

The following diagram shows a typical 5.1 audio installation:

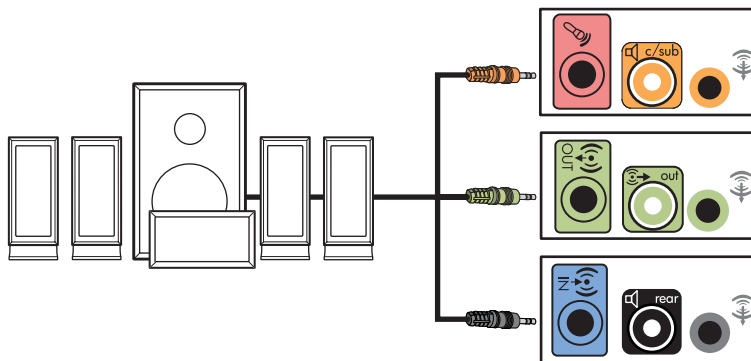

## Connecting 7.1 (Seven speakers and a subwoofer) audio speakers

### (Select models only)

To connect two front speakers, two side speakers, two rear speakers, a center speaker, and a subwoofer for eight-channel (7.1 speaker) output:

- 1 Turn off the computer.
- 2 Connect the front speaker cable to the lime green Audio Line Out connector on the back of your computer.



- 3 Connect the rear speaker cable to the black Audio Line Rear connector on the back of your computer.



- 4 For type 6 connectors only, connect the side speaker cable to the gray Audio Line Side connector on the back of your computer.



- 5 Connect the center speaker and subwoofer speaker cable to the gold Audio Line C/ Sub connector on the back of your computer.



- 6 Connect the cables to the audio system.
- 7 Connect the front, rear, side, and center speakers to the subwoofer. Refer to the speaker documentation.
- 8 Turn on the computer.

---

**NOTE:** Always turn on the computer before the speaker system.

---

- 9 Connect the speaker system to the power.
- 10 Turn on the speaker system.
- 11 After the speakers are connected to the computer, configure the audio software for sound output for your computer model.
  - Type 6 – multistreaming: See “Configuring multistreaming audio.”

The following diagram shows a typical 7.1 audio installation.

|   | Color      | Description                  |
|---|------------|------------------------------|
| 1 | Lime green | Front audio input            |
| 2 | Black      | Rear audio input             |
| 3 | Orange     | Center/subwoofer audio input |
| 4 | Gray       | Side audio input (not shown) |

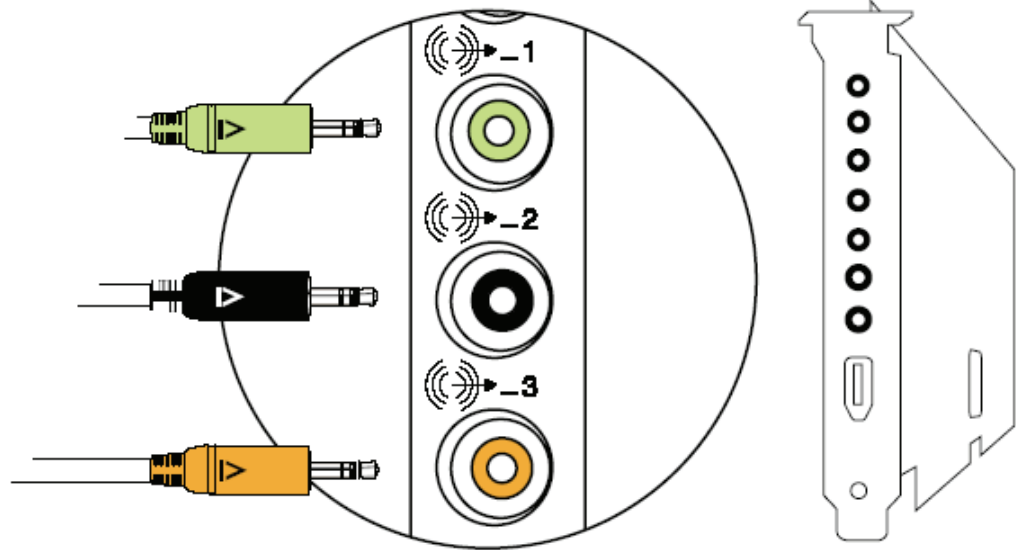

## Connecting your home stereo system (optional)

Most home receivers/amplifiers have RCA-type input connectors. You must connect Y adapter cables between your computer and your receiver/amplifier. Y adapter cables have one 3.5 mm (1/8-inch) stereo mini-jack on one end, and two RCA connectors on the other. These cables are purchased separately.

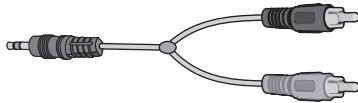

The number of Y adapter cables that you need to connect to your home stereo system depends on the number of speakers that you install:

- 2/2.1 speaker system: One Y adapter cable
- 4/4.1 speaker system: Two Y adapter cables
- 6/5.1 speaker system: Three Y adapter cables
- 8/7.1 speaker system: Four Y adapter cables

Connecting a home stereo system to a computer requires audio cables that are long enough to reach from the computer to the stereo. You also must purchase Y adapter or mini-extension cables.

---

**NOTE:** Y adapter and mini-extension cables are purchased separately.

---

## 2.1 home stereo installation

The following diagram shows a typical two-channel (2.1 speaker) installation that uses passive stereo speakers and plugs into a home stereo standard left and right input.

This is only a suggested configuration. Your system may be different.

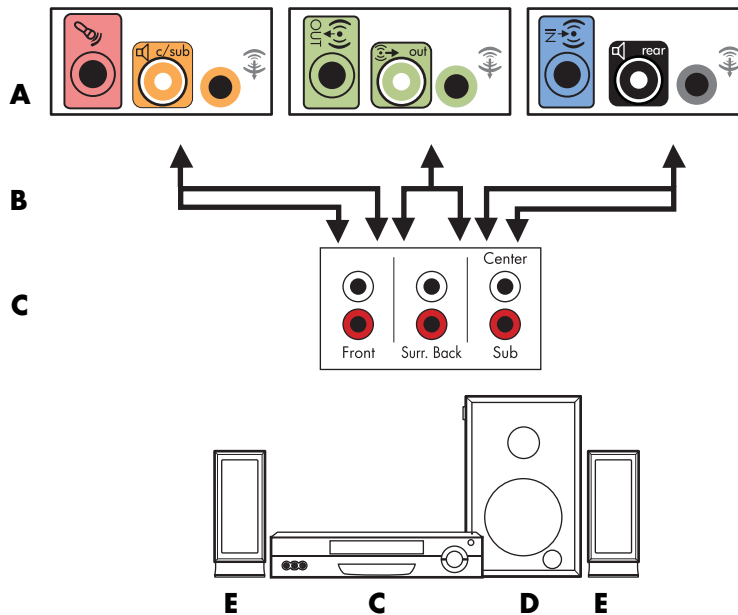

### Computer to 2.1 multichannel audio system connection

- A** Computer back-panel connectors (type 3, type 6, or sound card)
- B** Y adapter cables
- C** Receiver/amplifier (audio input jacks)
- D** Subwoofer
- E** Front speakers (left and right)

## 5.1 home audio installation

The following diagram shows a typical advanced home theater audio six-channel (6/5.1 speaker) installation that requires multichannel inputs on a receiver/amplifier.

This is only a suggested configuration. Your system may be different.

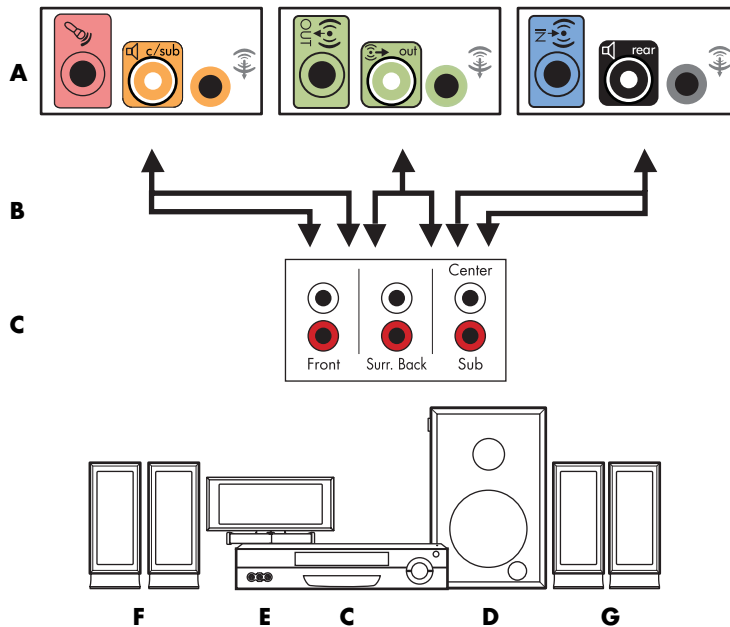

### Computer to 5.1 multichannel audio system connection

- A Computer back-panel connectors (type 3, type 6, or sound card)
- B Y adapter cables
- C Receiver/amplifier (audio input jacks)
- D Subwoofer
- E Center speaker
- F Front speakers (left and right)
- G Rear speakers (left and right)



## 5.1 home audio installation procedure

To connect a six-channel (5.1 speaker) home audio system to the computer:

- 1 Turn off the computer.
- 2 Turn off the receiver/amplifier.
- 3 Connect the front stereo mini-jack end of a Y adapter cable into the lime green Audio Line Out connector that matches the back of your computer.

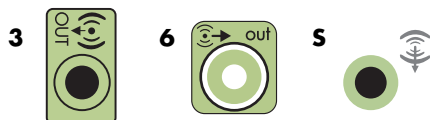

---

### NOTE:

- Type 3 is three connectors.
- Type 6 is six connectors.
- Type S is sound card.

---

**NOTE:** Receiver/amplifier input connectors may be labeled Surround, 5.1 Channel inputs, 6 Channel inputs, CD, DVD, or DVD In.

---

Connect the left and right ends of the Y adapter cable into the front left (L) and right (R) inputs on the back of the receiver/amplifier.

- 4 If you have rear speakers, connect the rear stereo mini-jack end of a Y adapter cable into the Audio Line In (blue) or the Rear Speaker Out (black) connector that matches the back of your computer.



- Connect the left and right ends of the Y adapter cable into the rear left (L) and right (R) inputs on the back of the receiver/amplifier.
- 5 If you have a center/subwoofer speaker, connect the stereo mini-jack of a Y adapter cable into the microphone (pink) connector or the center speaker/subwoofer (gold) connector that matches the back of your computer.

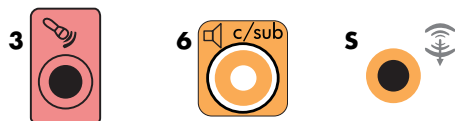

- Connect the left and right ends of the Y adapter cable into the center/subwoofer inputs on the back of the receiver/amplifier (6/5.1 or higher-channel system).
  - Plug the Y adapter cable into the subwoofer connector on the back of the receiver even if a subwoofer is not used.
- 6 Turn on the receiver/amplifier.

- 7 Select the receiver/amplifier input that the Y adapter cables are plugged into.
- 8 Turn on the computer.
- 9 After the audio system is connected to the computer, configure the audio software for sound output for your computer model. See "Connecting Speakers or Microphone."
  - Type 3: See "Configuring speakers with Realtek HD Audio Manager."
  - Type 6: See "Configuring speakers with Realtek HD Audio Manager."
  - Type S (audio card): See "Using the Creative Sound Blaster X-Fi or X-Fi Fatality audio card."

## 7.1 home audio installation

The following diagram shows a typical advanced home theater system with an eight-channel 8/7.1 speaker installation that requires multichannel inputs on a receiver/amplifier.

This is only a suggested configuration. Your system may be different.

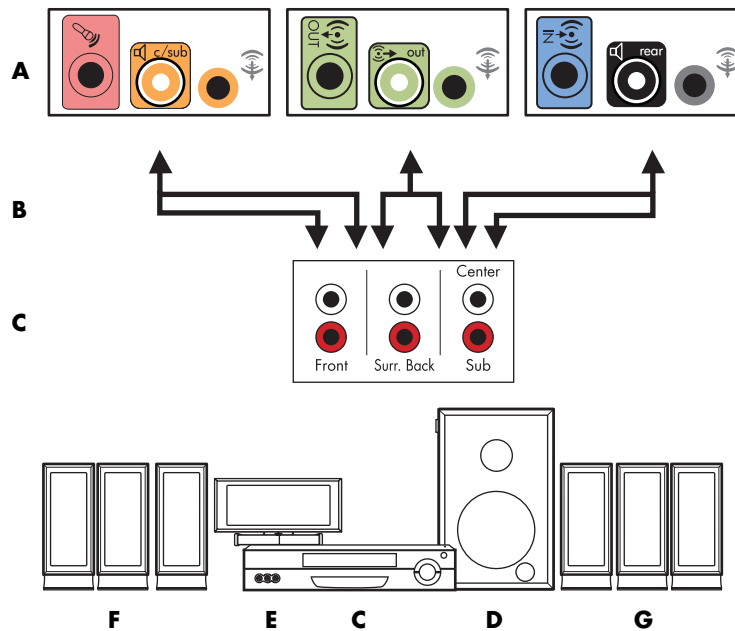

### Computer to 7.1 multichannel audio system connection

- A** Computer back-panel connectors (type 3, type 6, or type S)
- B** Y adapter cables
- C** Receiver/amplifier (audio input jacks)
- D** Subwoofer
- E** Center speaker
- F** Front speakers (left and right)
- G** Rear speakers (left and right)

## 7.1 home audio installation procedure

To connect an eight-channel (7.1 speaker) home audio system to the computer:

- 1 Turn off the computer.
- 2 Turn off the receiver/amplifier.
- 3 Connect the front stereo mini-jack end of a Y adapter cable into the lime green Audio Line Out connector on the back of your computer.

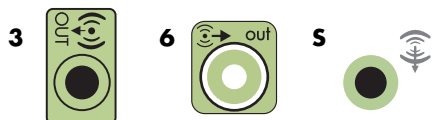

---

### NOTE:

- Type 3 has three connectors.
- Type 6 has six connectors.
- Type S has audio card.

---

**NOTE:** Receiver/amplifier input connectors may be labeled Surround, 7.1 Channel inputs, 6 Channel inputs, CD, DVD, or DVD In.

---

Connect the left and right ends of the Y adapter cable into the front left (L) and right (R) inputs on the back of the receiver/amplifier.

- 4 If you have rear speakers, connect the rear stereo mini-jack end of a Y adapter cable into the Audio Line In (light blue) or the Rear Speaker Out (black) connector on the back of your computer.



Connect the left and right ends of the Y adapter cable into the rear left (L) and right (R) inputs on the back of the receiver/amplifier.

- 5 If you have a center/subwoofer speaker, connect the stereo mini-jack of a Y adapter cable into the microphone (pink) connector or the center speaker/subwoofer (gold) connector on the back of your computer.



Connect the left and right ends of the Y adapter cable into the center/subwoofer inputs on the back of the receiver/amplifier (8/7.1 or higher-channel system).

Connect the Y adapter cable to the subwoofer connector on the back of the receiver, even if you are not using a subwoofer.

- 6 Turn on the receiver/amplifier.
- 7 Select the receiver/amplifier input to which the Y adapter cables are connected.
- 8 Turn on the computer.
- 9 After the audio system is connected to the computer, configure the audio software for sound output for your computer model. See “Configuring Speaker and Sound Options.”
  - Type 3: See “Configuring speakers with Realtek HD Audio Manager.”
  - Type 6: See “Configuring speakers with Realtek HD Audio Manager.”
  - Type S (audio card): See “Using the Creative Sound Blaster X-Fi or X-Fi Fatality audio card.”

## Connecting digital audio

### (Select models only)

If you have an audio card and you are connecting your home stereo AV receiver via digital out, connect the 3.5 mm (1/8-inch) stereo plug to the Digital Audio Out connector on the audio card. Connect the red RCA stereo plug on the 3.5 mm (1/8-inch) Y adapter cable to the AV receiver’s digital input connector on the AV receiver. If the red RCA stereo plug does not work, try the white stereo plug. Only one of the connectors is needed.

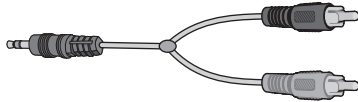

To connect digital audio, your computer must include a Digital Audio Out connector on either the audio card or the back panel. You must connect multichannel speaker outputs if you connect the digital output.

To connect digital audio speakers:

- 1 Turn off the computer.
- 2 Connect the orange Digital Audio Out connector on the back panel of your computer to the digital input (S/PDIF) on the digital speakers or a digital audio system.
- 3 Turn on the computer.

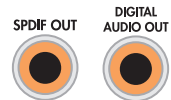

---

**NOTE:** Always turn on the computer before the speaker system.

---

- 4 Connect the speaker system to the power.

- 5 Turn on the speaker system.
- 6 After the speakers are connected to the computer, configure the audio software for sound output for your computer model. See “Configuring Speaker and Sound Options.”
  - Audio card with digital output and type 3 connectors: See “Configuring speakers with Realtek HD Audio Manager.” Follow the instructions to enable digital audio output.
  - Audio card with digital output and type 6 connectors: See “Configuring speakers with Realtek HD Audio Manager.” By default, digital audio output is already enabled.
  - Audio card: See “Using the Creative Sound Blaster X-Fi or X-Fi Fatality audio card.” Follow the instructions to enable digital audio output.

## Connecting Headphones

Your computer comes with a headphones connector (lime green) on the front of the computer. The headphones connector is labeled with a headphones icon.



You can also connect headphones to the Line Out connector (lime green) on the back of your computer.



### Using a 2.1 speaker system with headphones

For select models with the 2.1 speaker system, look for the headphones connector on the right side of the main speaker. When headphones are plugged in, the sound to the speakers and the subwoofer is muted.

### Using a 5.1 to 7.1 speaker system with headphones

For select models that include a 5.1 or higher speaker system, a headphones connector is located on the right side of the control tower.

If the control tower displays *HP* (for headphones), the headphones are enabled; the sound to the speakers and the subwoofer is muted.

- Push and hold the On button on the control tower for several seconds to enable sound from the speakers.
- Press the On button briefly to enable the headphones.

# Connecting Speakers Using the Creative Sound Blaster X-Fi Sound Card





This section provides an overview of connecting to the Creative Sound Blaster X-Fi sound card.

---

**NOTE:** For additional information on connecting the speakers, refer to the documentation that came with your speakers.

---

## Connecting the speakers

| Connector   | Description   |
|---|---|
| <br>AD_LINK            | AD-Link for AD_Link X-Fi I/O Console (the X-Fi console is sold separately)  |
| <br>3                  | Line Out_3 (orange or yellow)<br>5.1 audio setup: Front center, subwoofer<br>6.1 audio setup: Front center, subwoofer, and rear center<br>7.1 audio setup: Front center, subwoofer, and side left             |
| <br>2                | Line Out_2 (black)<br>4.1, 5.1, 6.1 audio setup: Rear left and right<br>7.1 audio setup: Rear left, rear right, and side right  |
| <br>1                | Line Out_1 (lime green)<br>2/2.1 audio setup: Front left and right  |
| <br>OR<br>DIGITAL_IO | FlexiJack (white) for Line In, Microphone, Digital In/Out<br>The FlexiJack supports three functions. You must select the function in the Creative Console Launcher. See "Connecting the FlexiJack connector." |

To connect the X-Fi sound card to your speakers:

- 1 Use the audio connection table to connect your audio system to the sound card.
- 2 Turn on the computer.
- 3 Plug in and turn on the speaker system power.

After connecting the speaker system to the sound card, follow the steps in “Configuring the FlexiJack connector” to configure the speaker settings in the Creative Sound Blaster X-Fi software.

## Connecting the FlexiJack connector

The FlexiJack connector performs three functions:

- Digital Input/Output
- Line In
- Microphone

You must select the function in the Creative Console Launcher.

---

**NOTE:** If you are using the FlexiJack as your Digital In connection and you want to connect digital speakers as your output device, you will need a special connector from Creative.

---





## Finding Onscreen Guides

Onscreen guides are available in the User's Guides folder (select models only).

- 1 Click the **Windows Start Button**  on the taskbar.
- 2 Click **All Programs**.
- 3 Click **User Guides**.
- 4 Click an item to view it or use it.

---

**NOTE:** If there are no guide titles listed in the folder, your computer has no onscreen guides.

---

## Finding Guides on the Web

You can find guides and information for your computer by using the Internet to access the Support Web site.

- 1 Go to **<http://www.hp.com/support>** in your Web browser.
- 2 Select your country/region and language.
- 3 Click **Support and Drivers**.
- 4 Enter the model number of your computer, and then click **Search** .
- 5 Click **Manuals**.
- 6 Locate the manual you want, and then do one of the following:
  - Click the title to display the file in Adobe Acrobat Reader (which you can download from the Manuals page if it is not currently installed on your computer).
  - Right-click the title, click **Save Target As**, specify a location on the computer where you want to save the file, rename the file (retaining the .pdf extension), and then click **Save**.

# Using the Onscreen Help and Support Center

Information about your computer is in the onscreen Help and Support Center (select models only). Here, you can find links to driver updates, access to technical support options, and information about commonly asked questions.

To open the Help and Support Center:

- Press the Help button (select models only) on your keyboard.

Or

- Click the **Windows Start Button**  on the taskbar, and then click **Help and Support**.

# Using the PC Help & Tools Folder

The PC Help & Tools folder contains special utilities for computer owners, such as support information and programs.

To see the items in the PC Help & Tools folder:

- 1 Click the **Windows Start Button**  on the taskbar.
- 2 Click **All Programs**.
- 3 Click **PC Help & Tools**.
- 4 Click **Hardware Diagnostic Tools** to view or use these tools.

## Using the hardware diagnostic tools

The hardware diagnostic tools help you to do the following:

- View the computer system information, such as memory usage, drive capacity and CPU usage.
- Find alerts about your computer.
- Show information, and run diagnostic tests on computer hardware and some computer peripheral hardware, such as printers, monitors, speakers, and network adapters.
- Run a computer system test.

# Using HP Total Care Advisor Software

HP Total Care Advisor is a desktop tool you use to monitor and access system health information about key areas of your computer. HP Total Care Advisor has four major areas:

- PC Health & Security provides a dashboard view of the status of key areas of your computer.
- PC Action Center receives messages and alerts that inform you of changes in the status of your computer health.
- PC Help provides simple access to help and support information for your computer.
- Products Showcase provides a listing of products and services available for your computer, and presents comparison shopping information about those items.

To open HP Total Care Advisor:

- 1** Click the **Windows Start Button**  on the taskbar.
- 2** Click **All Programs**.
- 3** Click **HP Total Care Advisor**.



# Turning On the Computer for the First Time

After you have completed the steps on the setup poster, you are ready to turn on the computer.

- 1 Press the Power button on the monitor.
- 2 Press the On button on the front of the computer.
- 3 Turn on the speakers, if they are present.
- 4 Set up the computer by following the onscreen instructions. If prompted, select the country/region in which you are physically located, and wait while the computer makes preparations. (When you select an alternate language, it may take up to 30 minutes for this one-time language setup on the computer.)
- 5 Set up Microsoft Windows Vista by following the onscreen instructions.
- 6 Follow the onscreen instructions to register with HP or Compaq, sign up for updates, and get online. If you do not want to set up an Internet connection at this time, you can do so later by manually starting Easy Internet Services. See "Connecting to the Internet."
- 7 Norton Internet Security automatically opens. Follow the onscreen instructions to set up this tool, which protects the computer and your privacy.

---

**NOTE:** If you stop the setup procedure, when you are ready to finish, double-click the **Easy Setup** icon on the desktop to run the first-time wizard.

---

# Turning Off the Computer

For best results, when using Microsoft Windows Vista, do not shut down the computer, except when you must turn off the power for safety reasons, such as to make repairs, install new hardware or cards in the computer chassis, or change a battery.

As an alternative to shutting down the computer, you can lock it or put it into either Sleep or Hibernate mode, if it is available. You can set the power management timers to put the computer automatically into Sleep or Hibernate mode.

Sleep and Hibernate modes are power states. Sleep mode saves your work to memory, so you can resume quickly; saves your work to the hard disk; and then goes to a reduced-power state. During Sleep mode, the computer hardware light remains on, and the computer is ready to wake quickly and resume your work where you left off. Hibernate mode saves the system memory to a temporary file on the hard disk and then turns off the hardware.

Some computers also have a reduced-power state called Away mode. Away mode turns off the display and mutes the audio, but otherwise keeps the computer operational. During Away mode, the computer can perform tasks such as recording a scheduled TV program or streaming video and music files to a remote location.

## Using Shut Down

For best results, when using Windows Vista, turn off the computer without pressing any buttons on the computer chassis.

---

**NOTE:** For information on the Windows Start Button , see "Using the Windows Start Button Menu."

---

- 1 Close any open software programs by clicking the **X** at the upper-right corner of each program window.
- 2 Click the **Windows Start Button**  on the taskbar.
- 3 Click the **Arrow** button next to the Lock button.
- 4 Click **Shut Down**.
- 5 Turn off the monitor.

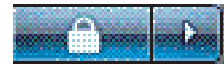

To turn on the computer after a shut down:

- 1 Press the power button on the monitor.
- 2 Press the On button on the front of the computer.

## Using Lock

If you lock the computer, only you or the administrator can log on to it.

- 1 Click the **Windows Start Button**  on the taskbar.
- 2 Click the **Lock** button.
- 3 To unlock this computer, you must enter your password.



## Using Sleep mode

When the computer is in Sleep mode, it goes into a reduced-power state. The monitor is blank, as if it were turned off. By using Sleep mode:

- You save time, because you do not have to wait for the computer to go through the normal startup routine when you wake it again. The next time that you use the computer, any programs, folders, and documents that were open before you put the computer into Sleep mode are available.
- The computer can receive faxes, if you set it to do so.
- The computer can retrieve e-mail messages and download information from the Internet automatically, if you set it to do so.

To put the computer into Sleep mode manually:

- Press the Sleep button on the keyboard, if it is present.

Or



- 1 Click the **Windows Start Button**  on the taskbar.
- 2 Click the **Power** button.

Or



- 1 Click the **Windows Start Button**  on the taskbar.
- 2 Click the **Arrow** button next to the Lock button.
- 3 Click **Sleep**.

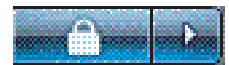

To wake the computer from Sleep mode:

- Press the Sleep button on the keyboard.

Or

- Quickly press the On button on the front of the computer.

If the computer does not work properly when you wake it from Sleep mode, restart the computer.

- 1 Click the **Windows Start Button**  on the taskbar.
- 2 Click the **Arrow** button next to the Lock button.
- 3 Click **Restart**.



Or

Quickly press the On button on the front of the computer.

## Using Hibernate mode

Hibernate mode is available as an advanced power setting. When the computer is in Hibernate mode, it saves to the hard disk drive everything that is in computer memory, turns off the monitor and the hard disk drive, and then turns itself off. When you turn on the computer again, your programs, folders, and documents are restored to the screen.

To put the computer into Hibernate mode manually:

- 1 Click the **Windows Start Button**  on the taskbar.
- 2 Click the **Arrow** button next to the Lock button.
- 3 Click **Hibernate**, if it is present.

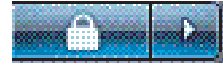

---

**NOTE:** If Hibernate is not present, you can set up the computer to go into Hibernate mode automatically; see “Automatic Sleep, Hibernate, or Away mode.”

---

To wake the computer from Hibernate mode, press the On button on the front of the computer.

If the computer does not work properly when you wake it from Hibernate mode, restart the computer.

- 1 Click the **Windows Start Button**  on the taskbar.
- 2 Click the **Arrow** button next to the Lock button.
- 3 Click **Restart**.



## Automatic Sleep, Hibernate, or Away mode

You can set the computer to go into Sleep, Hibernate, or Away modes automatically when it is idle for a specified number of minutes. To put the computer into a mode automatically, modify the power management settings.

- 1 Click the **Windows Start Button**  on the taskbar.
- 2 Click **Control Panel**.
- 3 Click **System and Maintenance**.
- 4 Click **Power Options**.
- 5 Click **Change when the computer sleeps**.
- 6 For Sleep or Away mode, select an option from the Put the computer to sleep drop-down menu, and click **Save changes**.

Or

For Hibernate or Away mode:

- a Click **Change advanced power settings**.
- b Click the plus sign (+) next to Sleep.
- c Click an item and make selections, and then click **Apply**.
- d Click **OK**.



# Restarting the Computer

When you restart the computer, the computer clears some settings and starts over using the operating system and software in its memory. Restarting is the easiest and most effective way to solve many software issues for the computer.

Also, you may want to install additional software programs or hardware devices onto the computer, and doing so may require that you restart the computer after installation.

- 1 Click the **Windows Start Button**  on the taskbar.
- 2 Click the **Arrow** button next to the Lock button.
- 3 Click **Restart**.

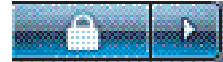

Or

Quickly press the On button on the front of the computer.

# Connecting to the Internet

The computer can connect to the Internet through the telephone modem. There are other ways to connect to the Internet that do not use the telephone modem, such as a LAN (local area network) or DSL (digital subscriber line). Check with your Internet Service Provider (ISP) for specific information on the connection. See "About the Internet" for more information about using the Internet.

Refer to the "Setting Up the Computer" chapter of this guide to make the hardware connections: for a modem, see "Connecting a Modem" and for a network see "Setting Up a Local Area Network."

To connect to the Internet, you must have:

- A computer.
- A dial-up modem, a cable modem, or a DSL modem for high-speed broadband connections. Contact your ISP for any specific software and hardware that you may need.
- Internet service with an ISP.
- A Web browser.

To connect to the Internet:

- 1 Sign up with an ISP. If you already have an account with an ISP, skip this step and follow the instructions provided by the ISP.
- 2 If you did not set up for Internet service during the initial setup of the computer, set it up now by using Easy Internet Services.
  - a Click the **Windows Start Button**  on the taskbar.
  - b Click **All Programs**.
  - c Click **Online Services** and then click **Easy Internet Services**.
  - d Follow the onscreen instructions to select an ISP and set up Internet service.

---

**NOTE:** Easy Internet Services provides a list of ISPs; however, you may choose another ISP or transfer an existing account to this computer. To transfer existing accounts, follow the instructions provided by the ISP.

---

- 3 Connect to the Internet. You must connect through your ISP.
  - Double-click the ISP-provided icon on the desktop, and log in.
- 4 Open your Web browser and browse the Internet.

You can use any Web browser; most computers have Microsoft Internet Explorer. To open Internet Explorer:

- a Click the **Windows Start Button**  on the taskbar.
- b Click **Internet Explorer**.

---

**NOTE:** If you have questions, contact your ISP directly.

---

## Using the Computer with Safety and Comfort



**WARNING:** To reduce the risk of serious injury, read the *Safety & Comfort Guide*. It describes proper workstation setup, posture, and health and work habits for computer users. It also provides important electrical and mechanical safety information.

---

Before you begin using the computer, arrange the computer and your work area to maintain your comfort and productivity. Refer to the *Safety & Comfort Guide* for important ergonomic information:

- Click the **Windows Start Button**  on the taskbar, click **All Programs**, click **User Guides**, and then click **Safety & Comfort Guide**.

Or

- Type  
`http://www.hp.com/ergo`  
into the Web browser address box, and then press Enter on the keyboard.

# Setting Up User Accounts

User accounts enable you to set the privileges for each user of the computer. For example, you can set the software programs that each user is allowed to access.

Windows Vista provides three types of user accounts:

- **Administrator:**
  - Is allowed to change account types for other users, change passwords, change system-wide settings, access all files on the computer, and install software and drivers that are compatible with Windows Vista.
- **Limited - Standard User:**
  - Is not allowed to change other user settings or passwords. A Limited account may not be able to install or run some software.
  - Is allowed to change the limited account picture, and to create, edit, or delete the account password.
- **Guest:**
  - Is allowed to use most software and change system settings that do not affect other users or the security of the computer.
  - Is not allowed to change other user settings or passwords, or install software.
  - Does not have access to password-protected files, folders, and settings.

Creating multiple user accounts on the same computer has certain advantages, as well as some drawbacks.

- **Advantages to multiple user accounts:**
  - Ability to create individual user settings
  - Ability to limit access to software for certain users
- **Drawbacks to multiple user accounts:**
  - More memory (RAM) usage
  - Multiple Temporary Internet Files folders to remove during Disk Cleanup
  - More data to back up
  - Longer time to complete virus scan

# Protecting the Computer

Protect the computer, personal settings, and data from a variety of risks by using:

- Passwords.
- Antivirus software.
- Firewall software.
- Critical security updates.

---

**NOTE:** Security solutions are designed to act as deterrents, but they may not be able to prevent software attacks or to prevent the computer from being mishandled or stolen.

---

| Computer risk  | Security feature  |
|--|---|
| Unauthorized use of the computer or user account   | User password   |
| Computer viruses   | Norton Internet Security software (antivirus program)                         |
| Unauthorized access to data  | Norton Internet Security software (firewall program)<br>Windows Vista updates |
| Unauthorized access to Setup Utility, BIOS settings, and other system identification information | Administrator password  |
| Ongoing or future threats to the computer  | Critical security updates from Microsoft                                      |

---

## Using passwords

A *password* is a group of characters that you choose to secure the computer information. Several types of passwords can be set, depending on how you want to control access to your information. Passwords can be set in the Microsoft Windows Vista operating system on the computer.



**CAUTION:** To avoid being locked out of the computer, record each password you set. Because passwords are not displayed as they are set, changed, or deleted, it is essential to record each password immediately and store it in a secure place.

---

Use the following list as a basic guide when choosing a password:

- Choose a password that is easy for you to remember but difficult for others to guess.
- Choose a long password (minimum of six characters).
- Use a combination of uppercase and lowercase letters, numbers, and symbols.

- Don't use personal information that others can easily figure out, such as your birthday, child's name, or phone number.
- Don't write down passwords unless you store them in a secure place away from the computer. Do not store passwords in a file on the computer.

You can use the same password for more than one Windows Vista security feature.

- A password can have any combination of up to eight letters and numbers, and it is not case sensitive.
- A password must be set and entered with the same keys. For example, if you set the password with number keys on the keyboard, the password is not recognized if you subsequently try to enter it with the embedded numeric keypad.

---

**NOTE:** Select models include a separate numeric keypad, which functions exactly like the keyboard number keys, except in the case of passwords.

---

- A password set in Windows Vista must be entered at a Windows Vista prompt.

The following table lists the Windows Vista passwords and describes their functions. For information on how to set passwords, see "Using passwords." For additional information on Windows Vista passwords, such as screen saver passwords, type *passwords* into the Search Help box in the Help and Support Center.

| Password                             | Function   |
|--------------------------------------|--|
| Windows Vista Administrator password | Protects administrator-level access to computer contents.  |
| Windows Vista User password          | Protects access to a Windows Vista user account and the computer contents. It must be entered when you resume from Sleep or Away mode. |



**CAUTION: If you forget the Administrator password, you cannot access Setup Utility.**

---

## Using antivirus software

When you use the computer for e-mail, network, or Internet access, you expose it to computer viruses. Computer viruses can disable the operating system, software programs, or utilities, or cause them to function abnormally.

Antivirus software can detect most viruses, destroy them, and in most cases repair any damage that viruses may have caused. To provide ongoing protection against newly discovered viruses, antivirus software must be kept up to date.

The Norton Internet Security program, which is preinstalled on the computer, includes antivirus and firewall components. The software includes a free update period. It is strongly recommended that you protect the computer against new viruses beyond the free period by purchasing extended update service. Instructions for using and updating Norton Internet Security software, and for purchasing extended update service, are provided within the program.

To open and access Norton Internet Security:

- 1 Click the **Windows Start Button**  on the taskbar.
- 2 Click **All Programs**.
- 3 Click **Norton Internet Security**, and then click **Norton Internet Security** in the list.

See “Using the Norton Internet Security Antivirus Software” for more information about using the Norton antivirus software.

For more information about computer viruses, type *viruses* into the Search Help box in the Help and Support Center.

## Using firewall software

When you use the computer for e-mail, network, or Internet access, unauthorized persons may be able to gain access to information about you, the computer, and your data. To protect your privacy, use firewall software. Microsoft Windows Vista includes firewall software preinstalled on the computer. Also, Norton Internet Security, which is preinstalled on the computer, includes a firewall program.

Firewall features include logging, reporting, and automatic alarms to monitor all incoming and outgoing communications.

To open and access Norton Internet Security:

- 1 Click the **Windows Start Button**  on the taskbar.
- 2 Click **All Programs**.
- 3 Click **Norton Internet Security**, and then click **Norton Internet Security** in the list.

Under some circumstances, a firewall can block access to Internet games, interfere with printer or file sharing on a network, or block authorized e-mail attachments. To solve the problem temporarily, disable the firewall, perform the task that you want to perform, and then enable the firewall again. To resolve the problem permanently, reconfigure the firewall.

## Configuring the computer for automatic Microsoft software updates

Microsoft continually updates the Windows Vista operating system. HP recommends that you run Windows Vista Update monthly to install these updates. One way to keep the operating system up to date is to use the Automatic Updates feature.

When you are connected to the Internet, Windows Vista Update automatically notifies you through a pop-up message or icon in the notification area when critical updates are available. When you see the Windows Vista Update message, allow the updates to download to your system. If you update the system weekly, or even monthly, the time required for download is minimal.

To configure Automatic Updates:

- 1 Click the **Windows Start Button**  on the taskbar.
- 2 Click **Control Panel**.
- 3 Click **Security**.
- 4 Click **Windows Update**.
- 5 Click **Change settings**.
- 6 Select the desired configuration:
  - **Install updates automatically (recommended)** — This is the default setting, and it enables you to specify a day and time to automatically download and install recommended updates.
  - **Download updates but let me choose whether to install them**
  - **Check for updates but let me choose whether to download and install them**
  - **Never check for updates (not recommended)** — This option makes the computer more vulnerable to security threats and performance problems and is not recommended.
- 7 Click **OK**.

## Installing critical security updates



**CAUTION:** To reduce the risk of information damage or loss from security breaches and computer viruses, install all critical updates from Microsoft as soon as you receive an alert.

Additional updates to the operating system and other software may have become available after the computer was shipped. Download all available updates and install them onto the computer.

To get the latest updates for the computer:

- 1 Click the **Windows Start Button**  on the taskbar.
- 2 Click **Help and Support**, and then click **Software, drivers, and BIOS updates**.
- 3 Follow any onscreen instructions to complete downloading and installing the latest updates.

## Guidelines for Installing Software and Hardware Devices

After you set up the computer, you may want to install additional software programs or hardware devices. Keep in mind the following important guidelines:

- Before installation, make a restore point by using the Microsoft System Restore program.
  - a Make sure you are logged in as an Administrator.
  - b Click the **Windows Start Button**  on the taskbar.
  - c Click **Control Panel**.
  - d Click **System and Maintenance**.
  - e Click **Backup and Restore Center**.
  - f Click **Create a restore point or change settings**.
  - g In the System Properties window, on the System Protection tab, click **Create**. Follow the onscreen instructions.

The *restore point* is a snapshot of the computer settings. By using System Restore, you ensure that you have a stable set of settings to use. For information on System Restore, go to the Microsoft Web site at: <http://www.microsoft.com/worldwide>

- Choose software that is compatible with the computer; check the operating system, memory, and other requirements listed for the new software.
- Install the new software according to the directions provided by the software manufacturer. If you need help, check the manufacturer's documentation or customer service information.



- If you need to restore factory settings after you install a program that is incompatible:
  - a Make sure you are logged in as an Administrator.
  - b Click the **Windows Start Button**  on the taskbar.
  - c Click **Help and Support**.
  - d Click **Recover factory settings**.
  - e Choose an option, and then follow the onscreen instructions.
- For antivirus software, uninstall the existing software program before reinstalling it or installing a new antivirus program.

---

**NOTE:** Use only licensed original software. Installing copied software may be illegal, or it may result in an unstable installation or infect the computer with a virus.

---

## Transferring Files and Settings from an Old Computer to a New Computer

You can copy files from the old computer to a new computer by using media such as CDs or DVDs, memory sticks, or personal media drives. You can also copy certain settings such as Web browser Favorites and address books by using Windows Easy Transfer software, which is included with Microsoft Windows Vista.

To transfer your files and settings:

- 1 Click the **Windows Start Button**  on the taskbar.
- 2 Click **Help and Support**.
- 3 Type *transfer files* into the Search Help box.
- 4 Click the overview article **Transfer files and settings from another computer**. This article describes a Microsoft solution for moving your files to your new computer.
- 5 Click **Windows Easy Transfer**.
- 6 Follow the onscreen instructions in the Windows Easy Transfer wizard to transfer your files from an old computer to a new one.



# Using the Keyboard

---

**IMPORTANT:** Please see the documentation that came with the keyboard for additional information about using the keyboard, customizing keyboard buttons, and using any special keyboard keys. You may need to install keyboard software and drivers to access all the special features and functions of the keyboard.

---

Your computer may include either a standard keyboard or a wireless keyboard. Using the keyboard is the primary way that you enter text and commands for the computer.

A *standard keyboard* connects to the keyboard connector in the back of the computer.

A *wireless keyboard* (select models only) uses a receiver/transmitter, instead of a connector cable, to communicate with the computer. A light on the receiver indicates receiver activity.

## Identifying Keyboard Features

The keyboard contains an arrangement of standard keys, indicator lights, and special buttons (select models only). Your keyboard may vary from the illustrations that follow.

### Alphanumeric keys

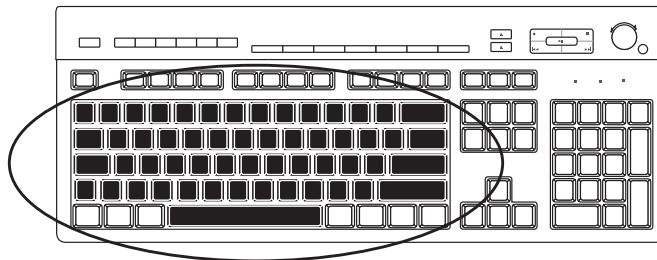

The alphanumeric keys are the main keys found on a standard typewriter.

## Function keys

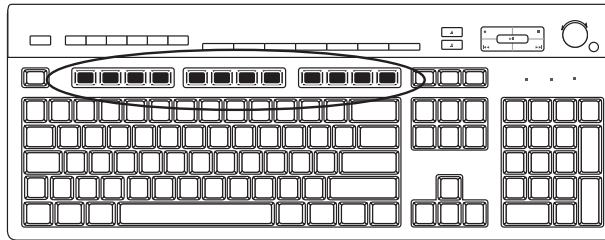

The function keys, located above the main keys, are labeled F1 through F12. Most function key operations vary by software program. F1 and F3 are available at all times:

- Pressing F1 opens a Help window for the software program being used.
- Pressing F3 opens a search window.

## Edit keys

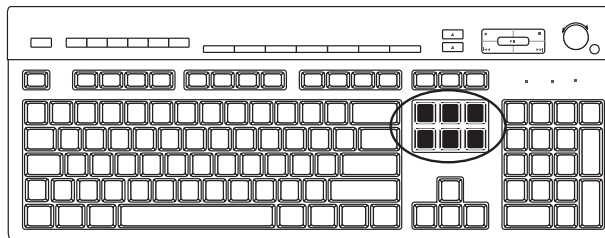

The edit keys are Insert, Home, Page Up, Delete, End, and Page Down. Use these keys to insert and delete text, and to quickly move the cursor on the screen. The edit keys function differently with some software programs.

## Arrow keys

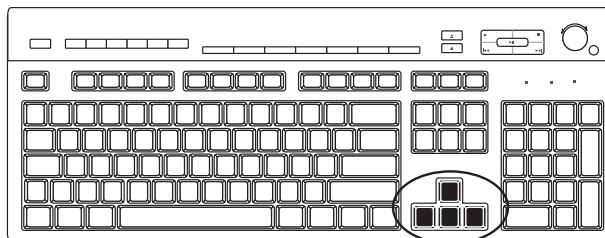

The arrow keys are controls for moving up, down, right, and left. You can use these keys instead of the mouse to move the cursor for navigation on a Web page, in a document, or in a game.

## Numeric keys

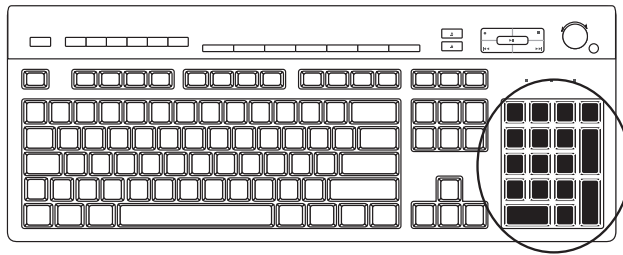

Press the Num Lock key to lock and unlock the numeric key functions:

- When the Num Lock light on the keyboard is on, the numeric keys work in the same way as the number keys and arithmetic functions found on a basic calculator.
- When the Num Lock light on the keyboard is off, the numeric keys are directional keys used to move the cursor or play games.

## Keyboard indicators

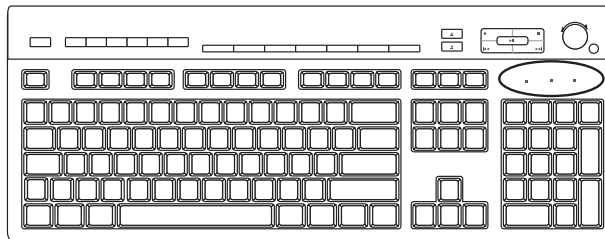

Each keyboard indicator is a light labeled with a name or with an icon for its status:

| Icon | Name        | Description  |
|------|-------------|--|
| 1    | Num Lock    | When lit, numeric keys are locked as number keys and arithmetic functions. |
| A    | Caps Lock   | When lit, alphanumeric keys are locked to uppercase.                       |
| ↓    | Scroll Lock | When lit, scroll function is locked.                                       |

## Special keyboard buttons

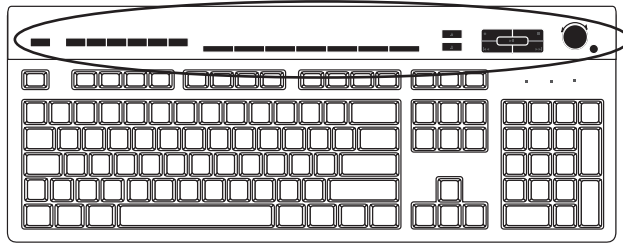

There are special buttons (select models only) at the top of the keyboard. These buttons operate a CD or DVD player, control speaker volume, connect you to the Internet, or provide quick access to specific functions. (Some keyboard models have some of these special buttons to the left side of the main keys, some do not have the Internet buttons, and some use a different layout on the top right.)

## Identifying Special Keyboard Buttons









Your keyboard may not include some of the buttons listed.



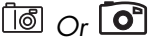

---

**NOTE:** The number, location, and labeling of buttons vary by keyboard model.













---

### Access buttons

| Icon   | Feature           | Description  |
|--|-------------------|--|
|   | Sleep             | Puts computer into or out of power-saving mode. It may take 10–30 seconds before screen reappears. |
|   | User              | Switches between computer users.   |
|   | Information       | Opens Help and Support Center.   |
|  Or  | Pictures (Photos) | Opens imaging software program. Can be reconfigured.   |
|  Or  | Music             | Opens music software program. Can be reconfigured.   |
|   | Video             | Opens video software program. Can be reconfigured.   |
|   | Internet          | Opens an Internet browser. Can be reconfigured to open any Web site or software program.           |

| Icon  | Feature                | Description (continued)   |
|---|------------------------|---|
|    | Search                 | Opens page designed to search the Internet. Can be reconfigured to open any Web site or software program. |
|  Or   | E-mail                 | Opens e-mail program. Can be reconfigured to open any Web site or software program.                       |
|  Or   | HP Club                | Links to HP Web site.   |
|  Or  Or        | Compaq<br>My Presario  | Links to Compaq Web site.   |
|  Or  Or        | Shopping               | Goes to a shopping Web site. Can be reconfigured to open a site or software program.                      |
|  Or   | Sports                 | Goes to a sports Web site. Can be reconfigured to open a site or software program.                        |
|  Or   | Finance                | Goes to a finance Web site. Can be reconfigured to open a site or software program.                       |
|  Or  Or  | Connect to<br>Internet | Goes to an Internet browser page. Can be reconfigured to open a site or software program.                 |
|  Or  Or  | Search                 | Goes to a search engine. Can be reconfigured to open a site or software program.                          |
|  Or   | Chat                   | Goes to chat Web site. Can be reconfigured to open a site or software program.                            |
|    | Entertainment          | Goes to a entertainment Web site. Can be reconfigured to open a site or software program.                 |
|    | Offers                 | Goes to popular Web site. Can be reconfigured to open a site or software program.                         |
|    | Calculator             | Opens calculator. Can be reconfigured.  |

## Media control or playback buttons

| Icon  | Label               | Description   |
|---|---------------------|---|
|    | Eject 1 and Eject 2 | Opens or closes upper and lower optical drive trays.  |
|    | Rec                 | Starts recording to selected media.   |
|    | Stop                | Stops media.  |
|    | Play/Pause          | Plays or pauses media.  |
|    | Prev                | Rewinds media.  |
|    | Next                | Fast-forwards media.  |
| <br><br><br>Or<br> | Volume              | Volume knob controls speaker volume: Turn clockwise to increase speaker volume and counterclockwise to decrease volume.<br><b>NOTE:</b> The Volume knob can continue to be turned, even after maximum volume has been reached.<br>Volume Up and Down buttons control speaker volume: Press the Volume Up button to increase volume and the Volume Down button to decrease volume. |
| <br>Or<br>  | Mute                | Turns speaker sound on and off.   |

## Customizing the keyboard buttons

You can customize some of the special buttons on the keyboard (select models only) to open different programs or files or go to favorite Web sites.

If you cannot customize the keyboard buttons using the following procedure, see the documentation that came with the keyboard.

- 1 Click the **Windows Start Button**  on the taskbar.
- 2 Click **Control Panel**.
- 3 Click **Hardware and Sound**, if it is present.
- 4 Click **Keyboard**.



- 5 Click the **Buttons** tab, and then double-click the button that you want to change.

---

**NOTE:** You can click the **Speed** tab to adjust the character repeat delay speed or the cursor blink rate. You can also click the **Hardware** tab, and then click the **Properties** button to view keyboard information.

---

- 6 For the button configuration, click the **Down arrow** to the right of the list and choose the button capability, such as **Complex remote page with label** or **Simple local file with label**.
- 7 Enter a display label and the address information. For a Web page, enter the URL.
- 8 Click **OK**.
- 9 On the Buttons tab, click **Apply**.
- 10 Repeat steps 5 through 9 for each button that you want to customize.
- 11 Click **OK** to finish.

---

**NOTE:** Click the **Restore Defaults** button on the Buttons tab to restore all of the buttons to the factory settings.

---

## Keyboard Shortcuts

Keyboard shortcuts are combinations of keys that you press simultaneously to perform specific actions. For example, from the Windows Vista desktop, press the Alt (alternate) key, the Ctrl (control) key, and the S key (the letter S) to display support information for the computer (including the model number, serial number, and service ID). You see this combination of keys represented as Alt+Ctrl+S. In Windows Vista, press Ctrl+C to copy an item that you've highlighted or selected, Ctrl+V to paste a copied item, or Ctrl+Z to undo the previous action. These shortcuts perform the same actions that you can perform through menus, but they save you time and mouse clicks.

# Wireless Mouse and Keyboard Troubleshooting

## Synchronizing a wireless mouse and keyboard

If the wireless mouse and keyboard do not respond, use this procedure to resynchronize the devices.

- 1 Plug the receiver into a USB port on the computer. If you have a choice, a USB port on the front of the computer is best if it will be closer to the mouse and keyboard.
- 2 Push the Connect button **(A)** on the receiver, and hold it for 5 to 10 seconds until the blue light starts to flash.

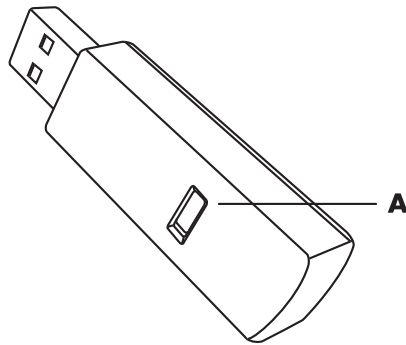

- 3 Push and hold the Connect button **(B)** on the underside of the mouse until the blue LED on the receiver stops flashing.

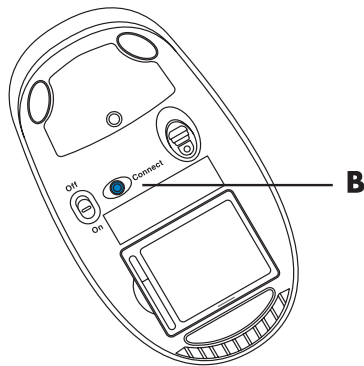

---

**NOTE:** The receiver connection session times out after 60 seconds. To ensure the connection was established instead of the receiver timing out, move the mouse and check for response.

---

After the mouse connection is established, repeat the procedure with the keyboard:

- 1 Push the Connect button on the receiver, and hold it for 5 to 10 seconds until the blue light starts to flash.
- 2 Push and hold the Connect button (C) on the underside of the keyboard until the blue LED on the receiver stops flashing.

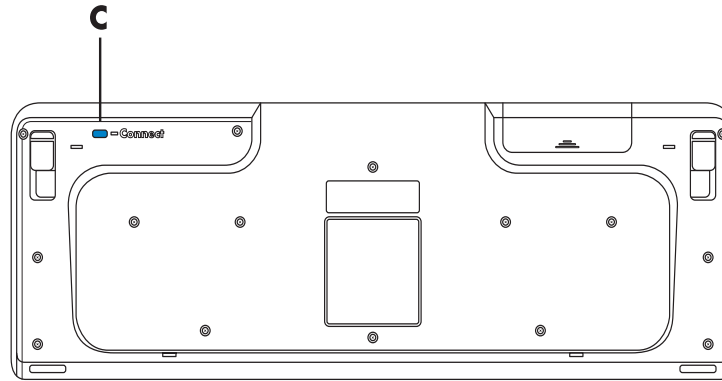

For additional mouse and keyboard troubleshooting tips, refer to the *Troubleshooting and Maintenance Guide*.



# Using the Mouse

---

**IMPORTANT:** Please see any documentation that came with the mouse for additional information about using the mouse, customizing mouse buttons, and using special buttons or features that are included with the mouse. You may need to install mouse software and drivers to access all the special features and functions of the mouse.

---

Your computer includes a mouse for directing the cursor (pointer) on the Windows Vista desktop. The mouse uses a roller ball or optics (a light and sensor) to sense movement and cause the cursor on the screen to move. Use the mouse on a flat surface.

---

**NOTE:** The optical mouse cannot work on a glass, translucent, or reflective surface.

---

A *wireless mouse* (select models only) is an optical mouse that uses a receiver/transmitter, instead of a connector cable, to communicate with your computer. A light on the receiver indicates receiver activity.

---

**NOTE:** The wireless mouse goes into a sleep or suspend mode after 20 minutes of inactivity. Click a button on the mouse to wake it. (Moving the wireless mouse does not wake it.)

---

# Using the Mouse Buttons

The mouse has two or three buttons on the top:

- Click the left mouse button (**A**) to position the cursor or select an item.
- Click the right mouse button (**C**) to display a menu of commands for the item you clicked.
- On select models, use the scroll wheel button (**B**) in the center for scrolling and panning.

---

**NOTE:** Your mouse may look different from the one shown here.

---

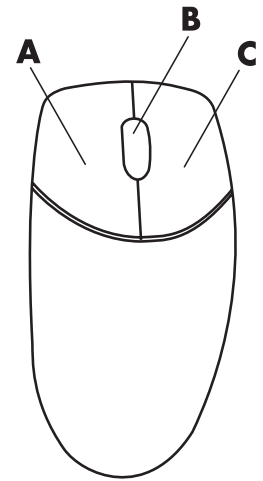

You see these terms for using the mouse:

- *Click* means to press and release the left mouse button once.
- *Double-click* means to click the left mouse button and then quickly click it again.
- *Right-click* means to press and release the right button once.

To select an item, click it.

To select sequential items in a list or group, click the first item in the list, and then press and hold the Shift key on the keyboard while you click the last item.

To select non-sequential items, click the first item, and then press and hold the Ctrl key on the keyboard while you click the additional items.

You can switch the function of the left and right buttons for left-handed use. See “Changing Mouse Settings.”

## Scrolling

Click the left mouse button to place the cursor in a document, and then:

- To scroll toward the beginning of the document, roll the scroll wheel button up (away from you).
- To scroll toward the end of the document, roll the scroll wheel button down (toward you).

## Autoscrolling

- 1 Place the cursor anywhere in the document, and then press the scroll wheel button once. An autoscroll icon appears.
- 2 Move the mouse in the direction you want to scroll. The farther you move the mouse from the starting point, the faster the document scrolls.
- 3 To stop autoscrolling, press the scroll wheel button again.



---

**NOTE:** Autoscrolling does not work with some software programs.

---

## Panning

- 1 Place the cursor anywhere in the document, and then press and hold down the scroll wheel button.
- 2 Slowly move the mouse in the direction you want to pan. The farther that you move the mouse from the starting point, the faster the document pans.
- 3 To stop panning, release the scroll wheel button.

---

**NOTE:** Panning works only if the horizontal scroll bar in the window is active. Panning does not work with some software programs.

---

# Changing Mouse Settings

## Switching mouse button functions

To switch the functions of the right and left mouse buttons for left-handed use:

- 1 Click the **Windows Start Button**  on the taskbar.
- 2 Click **Control Panel**.
- 3 Click **Hardware and Sound**, if it is present.
- 4 Click **Mouse**.
- 5 Click the **Buttons** tab, and check **Switch primary and secondary buttons**.
- 6 Click **Apply** (using the new primary button), and then click **OK**.

## Changing mouse pointer speed

To change the speed of the cursor on the screen relative to the motion of the mouse:

- 1 Click the **Windows Start Button**  on the taskbar.
- 2 Click **Control Panel**.
- 3 Click **Hardware and Sound**, if it is present.
- 4 Click **Mouse**.
- 5 Click the **Pointer Options** tab.
- 6 In the Motion area, use the slider to adjust the pointer speed. You can select other pointer options by placing a check in the check box next to the setting that you want.
- 7 Click **Apply**, and then click **OK**.

## Changing the double-click speed

To change the double-click speed of the right mouse button:

- 1 Click the **Windows Start Button**  on the taskbar.
- 2 Click **Control Panel**.
- 3 Click **Hardware and Sound**, if it is present.
- 4 Click **Mouse**.
- 5 Click the **Buttons** tab.
- 6 In the Double-click speed area, use the slider to adjust the double-click speed.
- 7 Click **Apply**, and then click **OK**.

## Turning on the ClickLock option

ClickLock enables you to highlight or drag an object without holding down the mouse button.

To turn on the ClickLock option:

- 1 Click the **Windows Start Button**  on the taskbar.
- 2 Click **Control Panel**.
- 3 Click **Hardware and Sound**, if it is present.
- 4 Click **Mouse**.
- 5 Click the **Buttons** tab.
- 6 In the ClickLock area, place a check in the **Turn on ClickLock** check box.
- 7 Click **Apply**, and then click **OK**.



## Changing the scroll wheel speed

To change the scroll wheel speed:

- 1 Click the **Windows Start Button**  on the taskbar.
- 2 Click **Control Panel**.
- 3 Click **Hardware and Sound**, if it is present.
- 4 Click **Mouse**.
- 5 Click the **Wheel** tab.
- 6 In the Vertical Scrolling area, adjust the number of lines per scroll by clicking the arrow buttons.  
*Or*  
In the Horizontal Scrolling area, adjust the number of lines per scroll by clicking the arrow buttons.
- 7 Click **Apply**, and then click **OK**.

## Wireless Mouse and Keyboard Troubleshooting

If the wireless mouse and keyboard do not respond, see “Synchronizing a wireless mouse and keyboard” in the “Using the Keyboard” chapter to resynchronize the devices.



# Configuring Speaker and Sound Options

Speakers are included with the monitor (select models only), or they are sold separately. For details about connecting stereo speakers to the computer, see the setup poster. For details about connecting multichannel speakers, see “Connecting Speakers or Microphone.”

---

**NOTE:** Speakers may be *passive* (no power button or power cord) or *active* (power button or power cord). Your computer supports only active (powered) speaker systems; the speaker system must have its own power cord.

A *stereo speaker set* is a left-right, two-channel speaker system. A *multichannel audio speaker system* is a system with more than two channels, and it may include a subwoofer. For example, a 5.1 channel speaker system, referred to as *six-speaker mode*, uses two front speakers (left-right), two rear speakers (left-right), a center speaker, and a subwoofer.

---

If your computer has multichannel audio speaker capacity (select models only), you can connect four channels for four-speaker output, or six channels for 5.1 speaker output.

Your model may include one of three analog sound connector types on the back of the computer:

- Three connectors (Realtek Audio)
- Six connectors (Realtek Audio)
- Audio sound card (Creative Sound Blaster X-Fi and X-Fi Fatality, or Analog Devices, Inc (ADI))

Your system may also have a separate Digital Out connector (select models only).

See “Connecting Speakers or Microphone” for more information about connecting your speaker system, and then configure the audio software for sound output as described in this section.

## Adjusting speaker volume

Use the Volume icon on the taskbar to set speaker volume. Then, you can adjust the volume by using:

- The Volume knob or buttons on the keyboard (select models only).
- The Volume knob on the speakers (select models only).

There are two ways to use the Volume icon:

- 1 Click the orange **Realtek HD Audio Manager Volume** icon on the taskbar.
- 2 Select a tab, such as **Digital Output**, and then adjust the volume by clicking the slider and moving it.
- 3 When you are satisfied with the sound level, click outside the Volume window to close it.



Or

- 1 Right-click the white **Microsoft Volume** icon on the taskbar, and then click **Open Volume Mixer**. The Volume Mixer settings window opens.
- 2 Adjust the volume by clicking the slider and moving it.
- 3 When you are satisfied with the sound level, click the **Close** box (the **X** in the upper-right corner) to close this window.

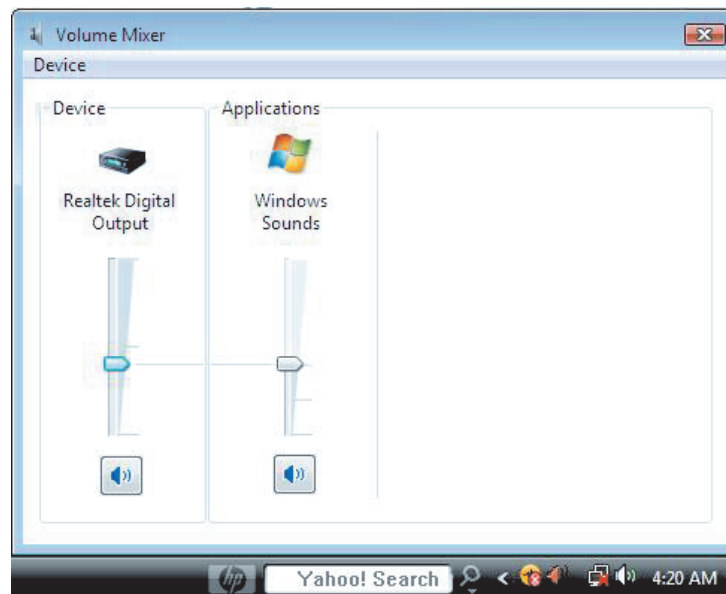

## Selecting a microphone

Your computer comes with one microphone connector on the back of the computer. Some models have a second microphone connector on the front of the computer. Only one microphone connector works at a time, and the back connector is ready to use unless you have the multichannel audio speakers option. For computers with the multichannel audio speakers option, the microphone connector on the front of the computer, if it is present, is ready to use.

To use a microphone connected to the front of your computer (select models only), select the working microphone:

---

**NOTE:** If you connect your microphone to the back of your computer, you do not need to perform this procedure.

---

- 1 Right-click the white **Microsoft Volume** icon on the taskbar, and then click **Recording Devices**. The Sound window opens.
- 2 Select the **Recording** tab.
- 3 Double-click **Microphone**, and select the **General** tab.
- 4 Click the microphone connector that you want to use, and then click **Apply**.
- 5 Click **OK**.



## Adjusting microphone volume

To adjust the volume of the microphone:

- 1 Right-click the orange **Realtek HD Audio Manager Volume** icon on the taskbar, and then click **Audio Devices**.
- 2 Click the **Recording** tab.
- 3 Double-click **Microphone**, and then click the **General** tab.
- 4 Click the microphone connector that you want to use.
- 5 Click the **Levels** tab.
- 6 Adjust the volume for the microphone by clicking the slider and moving it.
- 7 Click **OK**, and then click **OK** again.



## Configuring audio output

You can configure your speaker audio output by using the following software. Use the software that applies to your computer model:

- Creative Sound Blaster X-Fi or X-Fi Fatality Speaker Settings Configuration (audio card)
- Realtek HD Audio Manager (multistreaming audio)
- Windows Media Center (all systems)

# Using the Creative Sound Blaster X-Fi or X-Fi Fatality audio card

This section provides an overview of configuring and recording with the Creative Sound Blaster X-Fi or X-Fi Fatality audio card (select models).



## Configuring the audio card software

After you have installed and connected the speakers, follow these steps to configure multichannel audio output for computers:

---

**NOTE:** Three modes are available; Entertainment Mode is selected here. For information about the other modes, see “Sound Blaster X-Fi configuration modes.”

---

- 1 Click the **Windows Start Button**  on the taskbar.
- 2 Point to **All Programs**.
- 3 Click **Creative, Sound Blaster X-Fi**, and then click **Creative Console Launcher**.
- 4 The Entertainment Mode window opens. If a different mode displays, click the **Mode** button, and then select **Entertainment Mode**.
- 5 Click the **Windows Start Button** , **All Programs**, **Creative**, and then **Creative Console Launcher**.
- 6 Click the **Speakers** button.
- 7 Click **Auto Detect**. Creative automatically detects the type of speakers that are connected to your system.

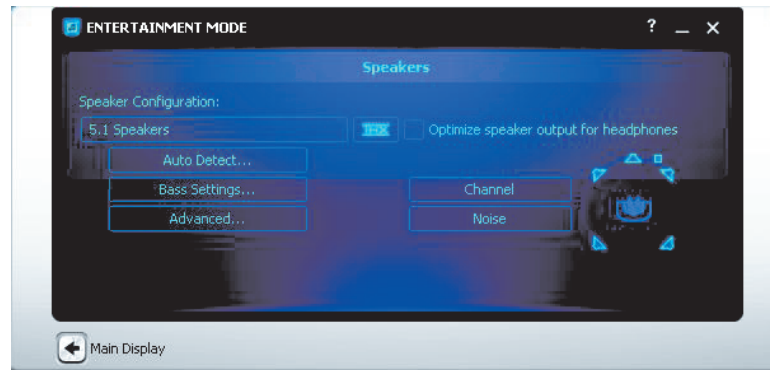

- 8 Click **X** to close the window.

Now that you have configured the audio card software, you must configure audio output for your media software program. The procedure is different for each program. Refer to the instructions that came with the media software program.

## Configuring the FlexiJack connector

Your audio device may have a FlexiJack connector that supports both microphone and Line input. If so, you can change the FlexiJack mode, if necessary. To do this, you must select the function in the Creative Console Launcher after you connect the audio cable to the FlexiJack connector on the audio card.

---

**NOTE:** If you are using the FlexiJack as your Digital In connection, and you want to connect digital speakers as your output device, you need a special connector from Creative.

---

- 1 Connect your audio cable to the FlexiJack connector on the audio card.
- 2 Click the **Windows Start Button** , **All Programs, Creative**, and then **Creative Console Launcher**.
- 3 Click the **Jacks** button.
- 4 Under FlexiJack Mode, select either **Digital I/O** or **Mic-In/Line-In**.
- 5 Close the window.



## Sound Blaster X-Fi configuration modes

The Sound Blaster X-Fi audio card includes three modes: Audio Creation Mode, Entertainment Mode, and Game Mode.

The main functions, such as speaker configuration, equalizer, and volume control, are available in all three modes. However, each mode optimizes the audio card resources to provide the best audio performance for different activities.

### Using Audio Creation Mode

The Audio Creation Mode enables advanced recording functions.

Available features:

- Recording from several audio sources
- Applying studio-quality effects
- Mixer settings
- Equalizer settings

## Using Entertainment Mode

The Entertainment Mode optimizes the audio card for playing movies and music.

Available features:

- Configuring speakers and headphones
- Configuring surround sound, DTS, and THX
- Volume, bass, and treble controls
- Mixer settings

## Using Game Mode

The Game Mode optimizes the audio card for playing games.

Available features:

- Volume, bass, and treble controls
- Mixer settings
- Configuring speakers and headphones
- Configuring surround sound

## More information

For more information about configuring and using the audio card, go to the Creative Sound Blaster X-Fi documentation:

- 1 Click the **Windows Start Button**  on the taskbar.
- 2 Point to **All Programs**.
- 3 Click **Creative, Sound Blaster X-Fi**, and then click **Documentation**.
- 4 Click **Online Manual**.

## Configuring speakers with Realtek HD Audio Manager

After you have installed and connected your speakers, complete the following steps if your computer model has type 6 connectors and is capable of multistreaming audio:

- 1 Click the **Windows Start Button**  on the taskbar.
- 2 Click **Control Panel**.
- 3 Click **Hardware and Sound**.
- 4 Click **Realtek HD Audio Manager**. The window opens.

---

**NOTE:** You must have your speakers connected for Realtek to display the Speakers tab.

---

- 5 Click the **Speakers** tab to open that control screen.



- 6 Click the **Speaker Configuration** tab.
- 7 Select your type of speakers from the drop-down menu.
- 8 Click **OK**.

## The Realtek HD Audio Manager control screens

- **Digital Output:** Enables you to select the Environment and Equalizer settings. You can select an environment, such as **Stone Room** or **Auditorium**. Under Equalizer, you can either click a preset button, such as **Pop** or **Live**, or manually adjust the settings and then save them for easy selection later.

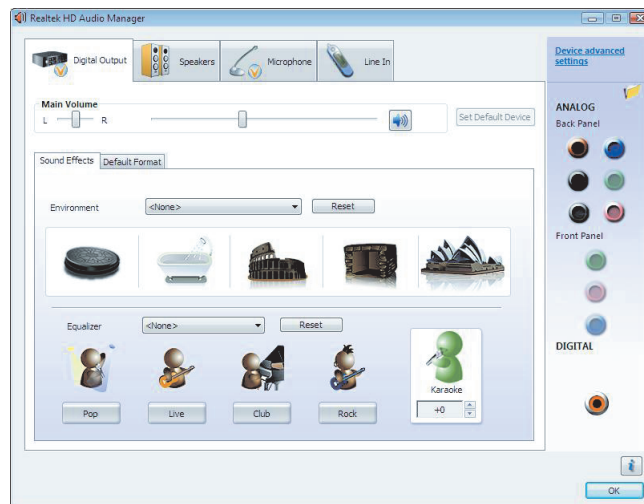

- **Speakers:** Enables you to select the number of speakers, view whether the connectors are analog or digital, and select the digital audio output and digital audio input devices. Only speakers that are currently being used are displayed.

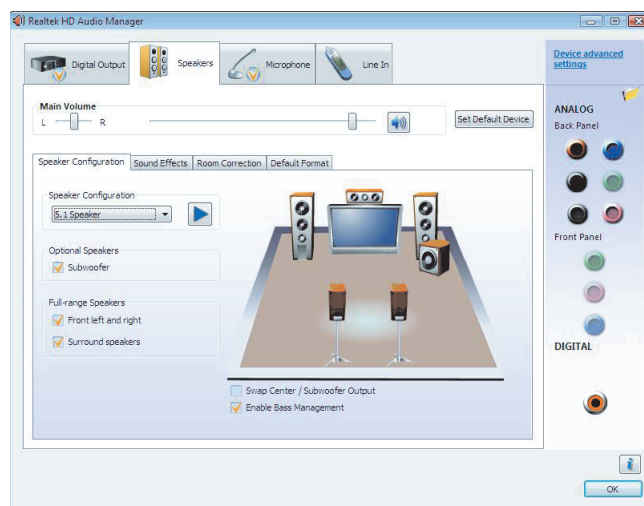

- **Microphone:** Enables fine control over the recording volume and playback volume of the microphone. Includes buttons for noise suppression and acoustic echo cancellation.

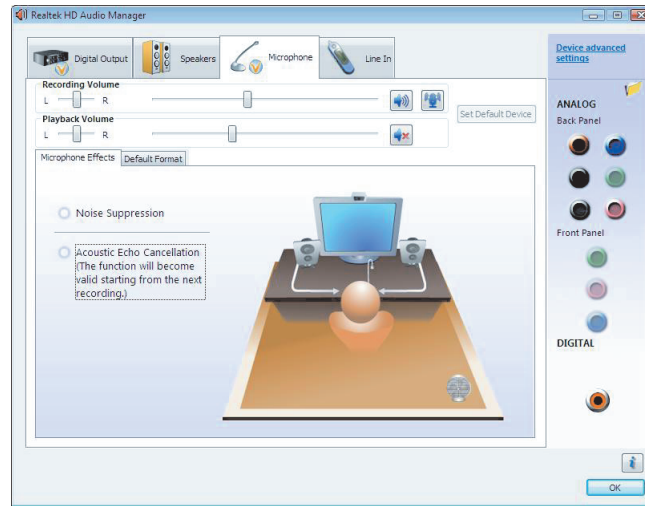

- **Line In (Digital Input):** Enables control over volume, playback, mute, recording, and multistreaming audio.

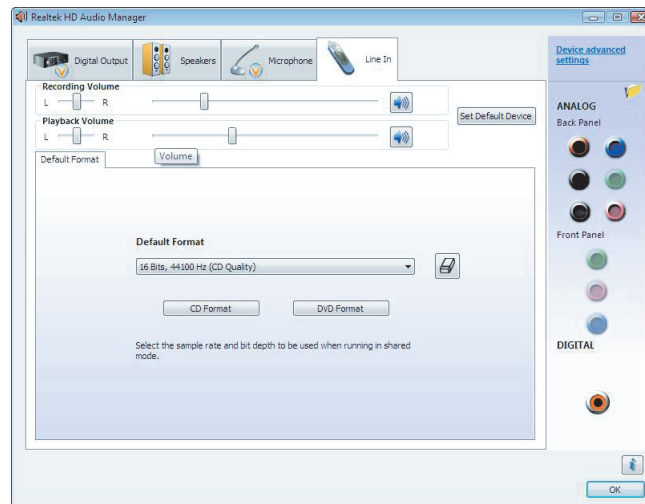

- **HDMI Output:** Enables you to select the Environment and Equalizer settings. You can select an environment, such as **Stone Room** or **Auditorium**. Under Equalizer, you can either click a preset button, such as **Pop** or **Live**, or manually adjust the settings and then save them for easy selection later.

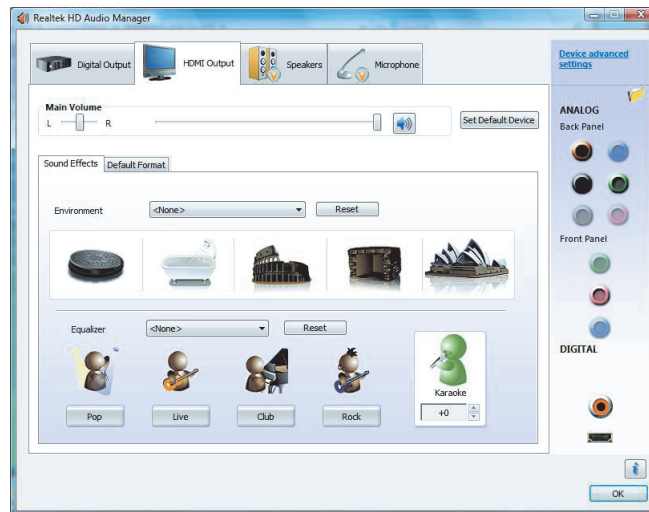

## Configuring sound for recording with the Realtek HD Audio Manager

The microphone connector is ready to use for recording sound. If you want to use another connector for recording, such as the Digital Audio In connector, complete the following steps to select it:

- 1 Click the **Windows Start Button**  on the taskbar.
- 2 Click **Control Panel**.
- 3 Click **Hardware and Sound**, and then **Realtek HD Audio Manager**.
- 4 Click the **Line In** tab.
- 5 Click **Digital In** tab, and then select **Set Default Device**.
- 6 Click **OK** to close the window.

---

**NOTE:** You can retask the front pink, blue, and green connectors to perform other audio functions; see “Retasking front panel audio connectors.”

---

## Retasking front panel audio connectors

You can retask the Line In, Mic In, Headphone, and Front Speaker Out connectors on the front of the computer, as necessary.

- 1 Click the **Windows Start Button**  on the taskbar.
- 2 Click **Control Panel**.
- 3 Click **Hardware and Sound**, and then click **Realtek HD Audio Manager**.
- 4 Click a front connector icon that you want to retask.

---

**NOTE:** Only the connectors that are not dimmed are able to be retasked.

---



- 5 Place a check in the device check box that you want to select, and then click **OK**.

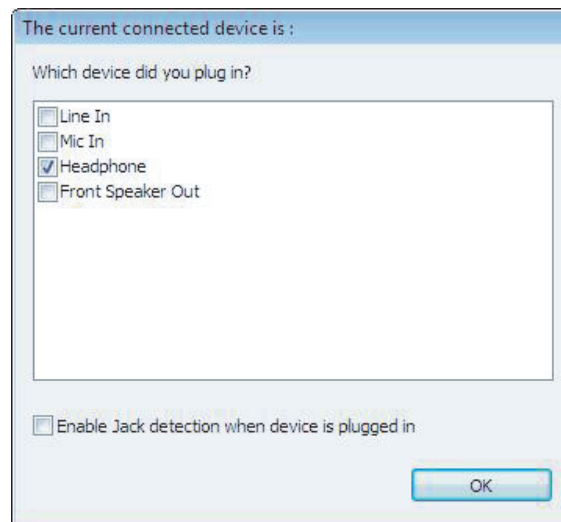

You can now use the front connectors as either input or output devices.

## Configuring multistreaming audio

The Realtek HD Audio Manager software enables you to listen to two different audio sources on two different speaker sets.

For example, you can hear one audio source through a rear-panel speaker connection, and a second source through a front-panel headphone or speaker connection. You must configure multistreaming audio for the system if you want to hear two audio sources on separate speakers.

### Audio output overview

The front-panel audio output is the green stereo headphone connector only.

The rear-panel outputs are the speaker connectors that can be set up as multichannel out from stereo 2.0 to 7.1 (select models only) configurations. Refer to your user documentation for information about setting up powered speakers or your AV receiver.

### Audio input overview

You can select two of the following audio sources to play through front-panel headphone and rear-panel speaker connectors:

- 1 From an externally connected device source, such as:
  - A microphone with cable connected to Mic In (pink).
  - An MP3 player with cable connected to Line In (blue).
- 2 From an internal source inside, or directly connected to, the computer, audio files may reside on: hard disk drives, DVDs, CDs, USB drives, HP Personal Media Drives, or any connected device. Play internal media files through programs such as:
  - Microsoft Windows Media Player.
  - Other installed media player software.

---

**NOTE:** Digital Audio In cannot be multistreamed.

---

## When to use multistreaming audio

You may multistream two audio sources as described in the following typical examples:

- 1 For online gaming:
  - You hear 5.1 game sound on AV receiver or powered speakers.
  - You also hear gaming conversation on a headset.See “Example 1: For online gaming.”
- 2 For digital home entertainment:
  - You hear DVD sound on a living room TV/display or AV receiver from the rear-speaker connections.
  - You also hear sound on the computer or powered speakers that are connected to the front-panel green headphone jack, from one of the following external computer audio sources:
    - a Front-panel Line In
    - b Internal source residing on a hard disk drive, DVD, CD, USB drive, or other external deviceSee “Example 2: For digital home entertainment.”

## Setting up multistreaming audio

### Example 1: For online gaming

To configure multistreaming audio output for online gaming with Realtek HD Audio Manager, you must enable Voice-over-IP software (software used to converse over the Internet). Other players hear your voice from the microphone via the Internet, and you hear the game audio from the rear speakers.

- 1 Connect the audio input and output connectors as follows:
  - A headphone set to the front Headphone Out (green) connector
  - A microphone to the front Mic In (pink) connector for online conversation
  - A set of powered stereo 5.1 or 7.1 speakers to the rear Speaker Out connectors for gaming sound output
- 2 Click the **Realtek HD Audio Manager** icon on the taskbar to open the Realtek HD Audio Manager window. 
- 3 Click the **Device Advanced Settings** button.
- 4 Select **Make front and rear output devices playback two different audio streams simultaneously**.
- 5 Place a check in the **Output Mic In/Line In to front panel** check box, and click **OK**.

Or

Place a check in the **Output Mic In/Line In to rear panel** check box, and click **OK**.

## Example 2: For digital home entertainment

To configure multistreaming audio output for digital home entertainment with Realtek HD Audio Manager:

- 1 Connect the audio output connectors as follows:
  - A headphone set or powered speakers to the front Headphone Out (green) connector for stereo music playback
  - A set of powered stereo 5.1 or 7.1 speakers to the rear Speaker Out connectors for DVD playback sound output
- 2 Click the **Realtek HD Audio Manager** icon on the taskbar to open the Realtek HD Audio Manager window. 
- 3 Click the **Device Advanced Settings** button.
- 4 Select **Make front and rear output devices playback two different audio streams simultaneously**.
- 5 Place a check in the **Output Mic In/Line In to front panel** check box, and then click **OK**.  
Or  
Place a check in the **Output Mic In/Line In to rear panel** check box, and then click **OK**.

## Configuring audio for Windows Media Center

After you have installed, connected, and configured the speakers, follow these steps to configure multichannel audio output for Windows Media Center:

- 1 Click the **Windows Start Button**  on the taskbar.
- 2 Click **Windows Media Center**.
- 3 Under Tasks, click **settings, General**, and then click **Windows Media Center Setup**.
- 4 Click **Set Up Your Speakers**. The Welcome to Speaker Setup window opens.
- 5 Click **Next**.
- 6 Choose the speaker connection type, and then click **Next**.
- 7 Select the number of speakers, and then click **Next**.
- 8 Click **Test** to test the speakers.
- 9 Click **Finish**.

## Selecting recording devices

### (Type 6 connectors only)

To select a sound recording device:

- 1 Click the **Windows Start Button**  on the taskbar.
- 2 Click **Control Panel**.
- 3 Click **Sounds and Audio Devices** (or **Sounds, Speech and Audio Devices**). The Sounds and Audio Devices window opens.
- 4 Click the **Audio** tab.
- 5 Under Sound Recording, select a recording device, such as **Realtek HD Front Pink Jack**.
- 6 Click **OK**.
- 7 Close the window.

## Resolving sound issues

If you do not have sound from the speakers, try the following:

- Check the volume and mute settings. See “Connecting Headphones.”
- Use active (powered) speakers, or speakers with an amplifier.
- Check the sound cable connections.
- Ensure that the software program and sound software are properly configured.
- Some software programs may result in low volume, even when the Volume is turned to the maximum value. If this is the case, click the **Volume** icon on the taskbar, and increase the system volume.
- Reconfigure the sound software for surround sound.
- Reinstall the audio card drivers by using application reinstallation program; refer to the *Troubleshooting and Maintenance Guide* that came with the computer.



# Using the Windows Media Center Remote Control

## (Select models only)

**NOTE:** The remote control is included with select models only. Features and location may vary.

The remote control is designed to work with Windows Media Center. You can use the remote control with Windows Media Center to play CDs and DVDs, view pictures, and much more.

This remote control helps you navigate the Windows Media Center windows on the computer just as a TV remote control helps you navigate cable TV options or control the playback of a movie in a VCR or DVD player.

## The remote control can:

- Navigate and control all Windows Media Center windows.
- Control the video display.
- Place the computer in and out of sleep mode.
- Shut down or restart the computer.
- Log off from Windows Media Center or switch users.

## The remote control cannot:

- Navigate the Windows desktop or control other computer programs outside of Windows Media Center.
- Be used as a VCR, DVD player, or stereo remote control.
- Turn on or off a TV that is connected to the computer (select models only).
- Turn on the computer.

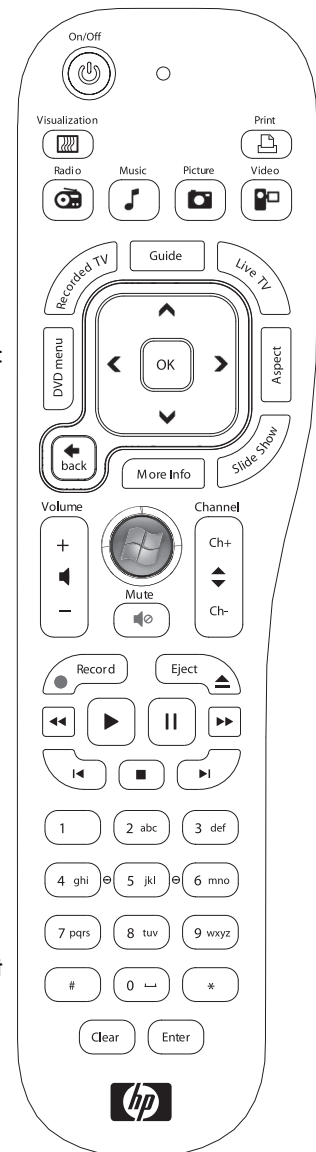

# Remote Control Buttons Overview

- 1 **On/Off (Sleep)** — Puts the computer into and out of a power-reduced Sleep mode. It does not turn the computer off.

---

- 2 **Visualization** — Displays visual imagery that is synchronized to the sound of the music tracks.

---

- 3 **Music** — Opens the Music Library window in Windows Media Center.

---

- 4 **Radio** — Opens the FM Radio window in Windows Media Center.

---

- 5 **Guide** — Opens the Television Program Guide.

---

- 6 **Recorded TV** — Opens the recorded tv window where recorded TV programs are listed.

---

- 7 **Arrows** — Moves the cursor to navigate and select actions within all Windows Media Center windows.

---

- 8 **DVD Menu** — Opens the Play DVD window in Windows Media Center or opens the main menu of a DVD movie, if available.

---

- 9 **Back** — Returns to the previous window within Windows Media Center.

---

- 10 **More Info** — Displays available information about a selected media file and displays other menus.

---

- 11 **Start** — Opens the Windows Media Center main menu.

---

- 12 **Volume** — Increases (+) and decreases (–) volume.

---

- 13 **Mute** — Turns computer sound off. The word *Mute* is displayed when Mute is turned on.

---

- 14 **Record** — Records a selected television program and stores it on the hard disk drive.

---

- 15 **Play** — Plays the selected media.

---

- 16 **Rewind** — Moves the media backward at three speeds.

---

- 17 **Skip Backward** — Moves media backward 7 seconds, or to the beginning of a music track or a DVD chapter.

---

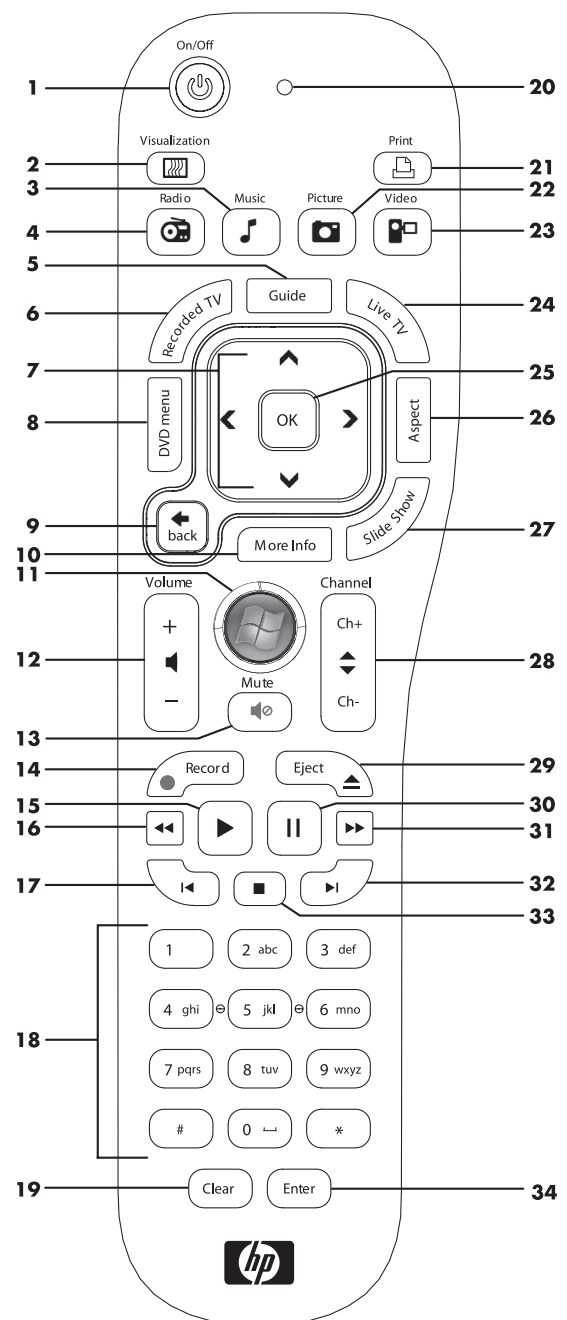
- 
- 18 0 to 9, #, \*** – Enters text and numbers into a Windows Media Center search or text box. Each time you press a number button, a different character appears. Press the Enter button to select a character.
- 
- 19 Clear** – Deletes the last character entered.
- 
- 20 LED** – Activity indicator light. The LED tells you that the remote control is emitting a signal when you press a button.
- 
- 21 Print** – Prints an item in Windows Media Center.
- 
- 22 Picture** – Opens the Pictures Library window in Windows Media Center.
- 
- 23 Video** – Opens the Videos Library window in Windows Media Center.
- 
- 24 Live TV** – Displays the full-screen view of live TV. Moves a TV program forward to the end of the pause buffer and resumes playing live TV.
- 
- 25 OK** – Selects the desired action or window option and acts as the Enter key.
- 
- 26 Aspect** – Changes the aspect ratio of the display. Zooms in on the picture three times then returns to the full-screen aspect ratio.
- 
- 27 Slide Show** – Plays a slide show of all the pictures on the hard disk drive.
- 
- 28 CH/PG up (+) and down (-)** – Changes the TV channels or moves pages up and down, depending on available options. Moves to the next DVD chapter.
- 
- 29 Eject** – Ejects CD or DVD drive.
- 
- 30 Pause** – Pauses audio and video tracks and live or recorded TV programs.
- 
- 31 Fast Forward** – Moves media forward at three speeds.
- 
- 32 Skip Forward** – Moves media forward 30 seconds in videos and live TV, one music track, or one DVD chapter.
- 
- 33 Stop** – Stops the media currently playing.
- 
- 34 Enter** – Selects the desired action, menu, or window option.
- 

**NOTE:** The remote control requires two AA batteries. The remote control operates up to 8 meters (26 feet) away from the remote sensor. Make sure there is nothing blocking the pathway between the remote control and the remote sensor.

---

**NOTE:** Make sure you turn off the monitor and turn down or mute the volume, for example, if you have a scheduled recording in the middle of the night and do not want to be disturbed. The computer does not automatically go into Sleep mode if Windows Media Center is open. It is recommended that you close Windows Media Center before you manually place the computer in sleep mode.

---

**NOTE:** If the computer model does not include a TV tuner, some remote control buttons are inactive.

---

# About the Remote Control

Use the remote control to open the Windows Media Center program, and use it to view TV, record TV programs, play previously recorded TV programs, and play music, movies, or video.

To open Windows Media Center using the remote control, simply point it at the remote sensor, and press the Windows Media Center Start button .

Use the remote control at a maximum distance of 8 meters (26 feet) from the remote sensor and at a maximum of 22.5 degrees (45 degrees total) from the center of the remote sensor.

---

**NOTE:** Use alkaline batteries in the remote control.

---

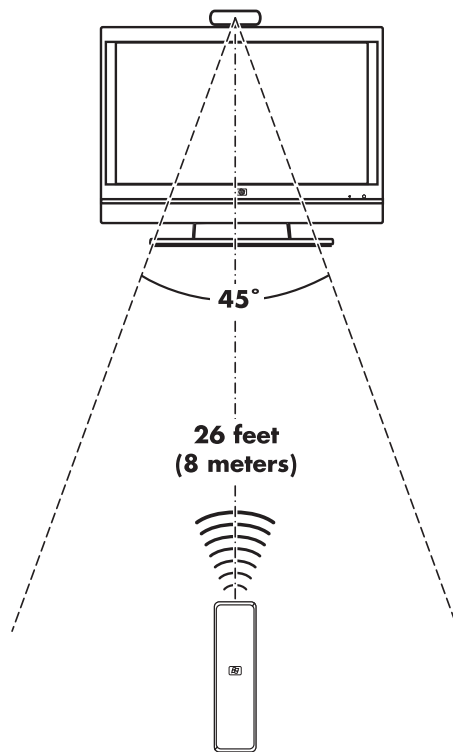

# Troubleshooting the Remote Control

If the remote doesn't work:

- Make sure that the batteries for the remote control are charged and installed correctly.
- Make sure the front of the remote sensor (IR receiver) is not blocked.
- Point the remote control within a 45-degree angle range and less than 8 meters (26 feet) away.
- If a pressed key repeats itself or sticks, unplug the remote sensor from the USB connector, wait 1 minute, and plug the remote sensor back in. Try altering the lighting conditions in the room or moving the location of the remote sensor if this continues.
- Press the Enter button on the remote control after changing a channel.
- Point the remote control toward the remote sensor, and press a button. A faint red light should appear on the remote sensor. If the light appears, then the problem is probably in the Windows Media Center software. Close Windows Media Center, restart the computer, and then open Windows Media Center again.
- If the remote control works in Windows Media Center but not when changing channels, you need to reconfigure the Windows Media Center software settings for the cable set-top box or satellite receiver.

## Remote sensor is not receiving a signal from the remote control

If a faint red light doesn't appear when you point the remote control at the remote sensor and press the OK button, try the following:

- 1 Click the **Windows Start Button**  on the taskbar, right-click **Computer**, and then select **Properties**.
- 2 Click **Device Manager**.
- 3 Click the plus (+) sign next to Universal Serial Bus Controllers.
- 4 If the *eHome Infrared Receiver* is listed under Universal Serial Bus Controllers, Windows is properly detecting the IR Receiver. If it is not listed, go to the next step.
- 5 Unplug the end of the USB cable on the remote sensor from the computer, and plug it into the same USB port.
- 6 Disconnect all other USB devices, leave the remote sensor plugged in, and then restart the computer. Plug in other USB devices after the remote sensor appears in the Device Manager window.



# Introducing Your Computer Software

The operation of your computer is controlled by two kinds of software:

- The Microsoft Windows Vista operating system, which displays the desktop on the monitor and controls your computer's hardware, peripherals, and software programs.
- Software programs that perform specific functions, such as word processing.

The software programs included with the computer may vary by model and by country/region.

## Learning More About Software

You can find information on using software and on the Microsoft Windows Vista operating system in this guide and the onscreen Help. For Microsoft Windows Vista, you can also open the built-in Help and Support Center.

- Press the Help button (labeled with a question-mark icon) on your keyboard (select models only).

Or

- Click the **Windows Start Button**  on the taskbar, and then click **Help and Support**.

For help with specific software, refer to the onscreen Help within the program.

## Using the Desktop

The *desktop* is the work area that appears on the monitor screen. It includes the taskbar along one edge, and shortcut icons that make it easy to find the things you need.

The taskbar shows the *Windows Start Button* ; a button for each open window, so that you can switch between programs; and the notification area that includes the time.

A *shortcut icon* is a small picture that you click to open a folder or start a program. One icon on the desktop that performs a special function is for the Recycle Bin, which collects files or shortcuts that you delete. When you empty the Recycle Bin, the files or shortcuts are permanently deleted. You can retrieve items from the Recycle Bin until you empty it.

## Removing desktop icons

You can remove most desktop icons by deleting them.

To delete a desktop icon:

- 1 Right-click the desktop icon.
- 2 Click **Delete**. The icon is placed in the Recycle Bin.

## Retrieving desktop icons

- 1 Double-click the **Recycle Bin** icon on your desktop.
- 2 Drag the icon onto the desktop.

## Removing files permanently

- 1 Right-click a file, and then click **Delete**.
- 2 Right-click the **Recycle Bin** icon on the desktop, and then click **Empty Recycle Bin**.

# Using the Windows Start Button Menu

Click the **Windows Start Button**  on the taskbar to open the Start menu. From the Start menu, you can:

- Open programs or documents.
- Open the Help and Support Center.
- Start a search.
- Open the Control Panel to view or change settings.

## Using the All Programs menu

To find the software programs on your computer:

- 1 Click the **Windows Start Button**  on the taskbar.
- 2 Click **All Programs**.

The All Programs menu displays a list of folders organized according to task (select models only).

A *folder* contains a list of items. Each item is actually a shortcut, or link, to a program, a document, or another folder. The Music folder, for example, contains shortcuts to the programs that you use to play music CDs.



## Organizing the All Programs list

To change the name of an item:

- 1 Right-click the item.
- 2 Click **Rename**.
- 3 Type the new name, and then press Enter on the keyboard.
- 4 Click **Yes** in the message that appears.

To copy an item:

- 1 Right-click the item.
- 2 Click **Copy**.
- 3 Go to the desktop or folder, right-click an empty area, and then click **Paste**.

If you use Add or Remove Programs in the Control Panel to delete a software program, the shortcut in All Programs may not be removed. To remove a shortcut:

- 1 Click the **Windows Start Button**  on the taskbar.
- 2 Click **All Programs**.
- 3 Click the folder.
- 4 Right-click the shortcut, and then click **Delete**.

## Using the Control Panel

The Control Panel is where you can set up or change properties and settings for the monitor, the keyboard, the mouse, the modem, a network connection, and other components and features of the computer. The Control Panel also provides tools for changing system performance, adding hardware, adding or removing programs, and other tasks.







To open the Control Panel:

- 1 Click the **Windows Start Button**  on the taskbar.
- 2 Click **Control Panel**.

# Resizing Windows

All windows have three buttons in the upper-right corner. The middle button is either the Maximize button or the Restore Down button, depending on the state of the window.



| Feature  | Name         | Description  |
|--|--------------|--|
|   | Minimize     | Collapses the window to the taskbar (but does not close it). To bring the window back up, click the taskbar button with the name of the window.  |
|   | Maximize     | Expands the window to the full-screen size.  |
|   | Restore Down | Reduces the window from full-screen size, so that it covers only a portion of the screen.  |
|   | Close        | Closes the window, and stops the program or task.  |
|   | Resize       | Resizes a window (not available when window is maximized). Move your mouse cursor over any window border until the cursor becomes a double-headed arrow. Click and hold down the left mouse button. Drag the border to the left or right to change the width. Drag the border up or down to change the height. |
|  | Scroll bar   | Appears in a window when the information does not fit on one screen. Clicking and dragging a vertical scroll bar moves the screen up and down. Clicking and dragging a horizontal scroll bar moves the screen left and right.  |

## Working with Digital Images

You can connect a digital image source, such as a digital camera or a digital video camera, to the computer either directly or through a docking station. Digital picture files that you copy or download from the device appear in the Pictures folder.

Digital cameras and other digital imaging devices use memory cards, or media, to store digital picture files. You can copy digital picture files from the memory cards used by digital cameras and other digital imaging devices by using the memory card reader (select models only).

# About the Internet

This section describes connecting to and using the Internet, including how to use a Web browser and electronic mail (e-mail).

Use the Internet to search for information or services on the Web, or to retrieve, read, or send e-mail messages.

The *Internet* is a group of computers that communicate with each other through telephone lines, digital services, or cable lines. Each Internet computer is independent, and its operators choose which files to make available to users of the Internet. To connect your computer to the Internet and use the information and services available there, you need an Internet Service Provider (ISP).

*ISPs* are businesses that give you access to the Internet, and most of them provide e-mail service. ISPs usually charge a monthly fee for their services. When your computer connects to the Internet, it is actually communicating with the Internet computer belonging to the ISP. The ISP verifies your account, and then provides you access to the Internet. You use a Web browser program to search for and display Web site information. Some ISPs allow you to choose a browser program, while others provide their own browser.

Your connection to an ISP may be through a traditional telephone dial-up modem, local area network (LAN), cable modem, digital subscriber line (DSL), or asymmetric digital subscriber line (ADSL). (DSL, ADSL, and cable ISPs are not available in all countries/regions.)

The *World Wide Web* (WWW), also called the *Web*, is a public part of the Internet used by individuals, companies, governments, and organizations. These individuals and groups have created millions of Web sites in support of their activities. A Web site consists of one or more Web pages. A *Web page* is a file or group of files that a user can access by entering the file location, or Uniform Resource Locator (URL).

The *URL* identifies a Web site location, typically in the form *http://www.name.extension* (for example, **http://www.hp.com**). The URL may include the path to a specific file within that site. Each period, or dot, in the URL separates elements within the address. For example, you will see the URL extension *.com* used by companies. When you enter the URL into your browser address box and press the Enter key on your keyboard, the browser contacts that location and opens the Web page for you.

Imagine that you are reading a newspaper. On page 1, you may read something like “For more details, see page 3, column 2.” You turn the page for more information. A *hyperlink* on a Web page works the same way, except that you move to the new page by clicking the hyperlink. The way that a hyperlink links files together is what gives the Web its name, because the Web weaves together and connects ideas from all over the world.

Your *e-mail address* identifies the electronic post office box where people can send you electronic mail. E-mail addresses have the form *name@domain.extension*. The domain is usually the name of the ISP or organization. The extension usually identifies the type of organization. For example, if your name is Jane Jones, and XYZ is your ISP, your e-mail address might be *JaneJones@xyz.com*, with the extension *.com* indicating that XYZ is a company. For information on using e-mail, see “Sending and Receiving E-Mail.”

# Using a Browser

A Web browser program searches for and displays Web site information. How you explore the Internet depends on whether your ISP provides the browser or allows you to choose your own.

Once you are connected to the Internet, your browser opens the home Web page. You can go to a different Web site by entering its address (such as **http://www.hp.com**) into the address box in the browser, and then pressing Enter on your keyboard. Or you can use the browser search feature to search for references to a specific word or phrase on the Web.

## Searching the Internet

Most Web browser programs include a search feature. You may need to click a button or select a menu option to display the search feature, depending on the type of browser program. Type a question, or a word that describes the information that you want to find, into the Search box, and then press Enter.

The Windows search feature includes direct use of Internet Explorer Search.

---

**NOTE:** If your ISP provides the browser, you may not be able to use Internet Explorer to search the Internet.

---

To begin a search:

- 1 Click the **Windows Start Button**  on the taskbar.
- 2 Type a word or question; what you type automatically appears in the *Start Search* box. As you type, the search results appear in the left pane.
- 3 Do one of the following:
  - Click a result to open it.
  - Click the **X** in the search window to clear the results of the search and return to the main list of programs.
  - Click **See all results** to display a list of all found search items on the computer and for advanced options.
  - Click **Search the Internet** to search the Internet by opening your browser.

## Restricting Internet content

The Internet provides you with a wide variety of information, but some information may not be suitable for every viewer. With Content Advisor (a feature of Internet Explorer), you can:

- Set up a password.
- Control Internet access.
- Set up a list of Web sites that people who use your computer cannot view.
- Adjust the type of content people can view with and without your permission.

Once you set up restricted rating levels in Content Advisor, users can view Web sites and other pages that you have specified under the rating setup. However, to view unrated Web sites or pages, users must enter the Content Advisor password that you have set. This means that any unrated page, even Help and Support or Internet Explorer, is not viewable if the user does not know the password.

To enable Content Advisor:

- 1 Click the **Windows Start Button**  on the taskbar.
- 2 Click **Internet Explorer**.
- 3 Click **Tools**, and then click **Internet Options**.
- 4 Click the **Content** tab.
- 5 In the Content Advisor area, click **Enable**.
- 6 Click the **General** tab, click **Create password**, and type a password.
- 7 Click **OK**, and then click **OK** again.

To allow access to an unrated site or page you approve of:

- 1 Open the Web site.
- 2 When the password window appears, select the **Always allow viewing** or **Allow viewing only this time** option.

# Using the Norton Internet Security Antivirus Software

When you use the computer for e-mail, network, or Internet access, you expose it to computer viruses. Computer viruses can disable or damage your operating system, software programs, or computer utilities.

Antivirus software can detect most viruses, remove them, and, in most cases, repair any damage that they have caused. To provide ongoing protection against newly discovered viruses, you must keep antivirus software up to date.

Norton Internet Security, an antivirus software program, is preinstalled on your computer and includes a free trial subscription of protection updates. You can enable Symantec's LiveUpdate™ to obtain updates automatically whenever you are online. Hewlett-Packard strongly recommends that you protect the computer against new viruses beyond the trial period by purchasing an extended update service.

## Configuring and registering Norton Internet Security software

When you first set up the computer, Norton Internet Security helps you to configure and register your copy of Norton Internet Security.

Ensure that you set up Norton Internet Security before you start using the Internet.

- 1 Double-click the **Norton Internet Security** icon on the desktop.

Or

Click the **Windows Start Button**  on the taskbar, **All Programs**, **Norton Internet Security**, and then click **Norton Internet Security**.

- 2 Click a task under Tasks & Scans, and then follow any onscreen instructions.

For information about using and updating the Norton Internet Security software, open Norton Internet Security, and then click **Help** under Quick Links.



## Manually running a scan

To select and run a scan:

- 1 Double-click the **Norton Internet Security** icon on the desktop.
- 2 Click the **Norton Internet Security** tab.
- 3 Click the **Tasks & Scans** bar.
- 4 Click **Run a Scan**.
- 5 Select **Run Full System Scan** to scan your entire hard disk drives for viruses and security risks. Depending on the number of files on your computer, this may take several minutes.
- 6 When the scan is complete, click **Finish**.



## Setting a Full System Scan time

To schedule a time for a Norton Internet Security Full System Scan:

- 1 Double-click the **Norton Internet Security** icon on the desktop.
- 2 Click the **Norton Internet Security** tab.
- 3 Click the **Tasks & Scans** bar.
- 4 Click **Configure a Scan**.
- 5 Click **Schedule Full System Scan**.
- 6 Click **New**.
- 7 Set the frequency and time that you want the scan to run.
- 8 When you are done, click **OK**.



---

**NOTE:** If the computer is in Sleep mode, the Norton Internet Security program does not perform a scheduled antivirus scan.

---

## Setting up a Custom Scan time

To create a Custom Scan for specific files, folders, and drives:

- 1 Double-click the **Norton Internet Security** icon on the desktop.
- 2 Click the **Norton Internet Security** tab.
- 3 Click the **Tasks & Scans** bar.
- 4 Click **Configure a Scan**.
- 5 Click **Manage Custom Scans**.
- 6 Click **Create Custom Scan**, and then click **Next**.
- 7 Click **Add Folders** or **Add Files**. Place a check mark next to the files and folders that you want to scan, click **Add**, and then click **Next**.
- 8 Type a name for your customized scan, and then click **Finish**.
- 9 Click **Schedule** next to the customized scan that you just created.
- 10 Click **New**.
- 11 Set the frequency and time that you want the scan to run.
- 12 When you are done, click **OK**.



---

**NOTE:** If the computer is in Sleep mode, the Norton Internet Security program does not perform a scheduled antivirus scan.

---

# Sending and Receiving E-Mail

E-mail enables you to send and receive letters, pictures, postcards, and even music and video clips.

---

**NOTE:** E-mail may contain a virus in the message itself or as an attachment. To protect your computer, do not open any message that originates from an unfamiliar source or that appears suspect to you. Instead, delete such messages.

---

Your computer comes with an e-mail program from Microsoft called Windows Mail (select models only). You may also use e-mail programs from other vendors. Some ISPs provide their own e-mail programs. You use an e-mail program to send, receive, and organize your messages. You can organize, read, and create new messages even when you are offline (not connected to the Internet).

## Using Windows Mail

To set up Windows Mail, you first need some information from your ISP: your e-mail address, user name, password, the names of your incoming and outgoing e-mail servers, and perhaps some other details.

The first time you start Windows Mail, make sure the computer is connected to the Internet, and follow the wizard to set up your account.

To add an account in Windows Mail:

- 1 Click the **Windows Start Button**  on the taskbar.
- 2 Click **All Programs**.
- 3 Click **Windows Mail**.
- 4 Click **Tools**, and then click **Accounts**.
- 5 Click **Add, E-mail Account**, and then click **Next**.
- 6 Follow the onscreen instructions to add your account.

## Using the e-mail program provided by your ISP

Follow the instructions provided by your ISP to install its Web browser and e-mail program, and to set up and use your e-mail account. You can then send and receive e-mail when your computer is connected to your ISP.



# Software Quick Reference Table

## (Select models only)





Your computer includes a number of software programs that:

- Record and play CDs.
- Record data CDs.
- Import and edit video files.
- Record video CDs and DVDs.
- Organize digital media files.

The following table describes the functionality that is specific to each of these programs. Use the table to determine which program to use to perform a task.

Note that some of the programs that are listed may not be included with your model, and that this is not a complete list of all included software.

To open any of these programs, click the **Windows Start Button**  on the taskbar, click **All Programs**, select the program folder (for example, **DVD Play**), and then click the program name to open the software.

| With this program:   | You can:  |
|--|---|
| DVD Play<br>(select models only)<br>                 | <ul style="list-style-type: none"><li>■ Play DVD movies and video CDs (VCDs).</li><li>■ Play Blu-ray and High-Definition DVDs if the computer has a Blu-ray and HD DVD disc drive.</li><li>■ Use the Zoom and Pan features.</li><li>■ Create viewing bookmarks.</li></ul>   |
| HP Photosmart Essential<br>(select models only)<br> | <ul style="list-style-type: none"><li>■ View, organize, and print your photos.</li><li>■ Share your photos with friends and family.</li><li>■ Create electronic photo albums.</li><li>■ Edit your photos: crop, resize, flip, rotate, make black and white, change the contrast, and more.</li></ul> <p>To open this program, click the <b>Windows Start Button</b> , <b>All Programs</b>, <b>HP</b>, and then click <b>HP Photosmart Essential</b>.</p> |
| Rhapsody<br>(select models only)<br>                | <ul style="list-style-type: none"><li>■ Play music CDs, .mp3s, and other audio files.</li><li>■ Record music files.</li><li>■ Record a copy of an existing music or data CD to use on the computer.</li><li>■ Organize digital files into a library for recording or listening.</li></ul>   |

**With this program: You can: (continued)**

muvee autoProducer  
(select models only)



- Add your own style to your movies with music, pictures, titles, scene transitions, and captions.
- Edit your home movies.
- Save and burn multiple movie files to DVD.
- Use the magicSpot feature to control the motion effects applied to your pictures.

CyberLink Power2Go  
(select models only)



- Record data and music files.
- Record a copy of an existing music or data CD to use on the computer.
- Create customized music CDs from CDs in your collection, or from .wav, .mp3, or .wma files. These CDs can be played in your home or car stereo.
- Copy and share data files.
- Create archive CDs or DVDs from files on your computer.
- Copy video files.
- Verify that the disc has been created without errors.

CyberLink  
PowerDirector  
(select models only)



- Record movie files to create VCDs and DVDs that you can play on some DVD players.
- Copy and share video files.
- Capture video files.
- Edit video files.

CyberLink LabelPrint  
(select models only)



- Burn a label directly onto LightScribe-enabled CDs, DVDs, and mini-discs by using LightScribe technology.
- Burn a label directly onto the disc's label side by using Labelflash technology.
- Print labels to attach directly onto a disc.

HP Total Care Advisor  
(select models only)

- Quickly organize the Web links you want to keep available to you on your desktop.
- Comparison-shop using the convenient shopping search engine.
- Get HP software and driver updates.
- Get important messages from HP.
- Access PC Health and Security and PC Help tools.

**With this program: You can: (continued)**

Backup My PC  
(select models only)

- Create computer backup files to protect your data and other important files on your computer.

**NOTE:** This software is included with the Personal Media Drive only.

Microsoft Windows  
Movie Maker  
(select models only)



- Import audio, video, and other media files from videotape, audiotape, Web cameras, or television broadcasts.
- Record audio and video files to create a video project that becomes a Microsoft Windows Media source file with a .wmv extension.
- Edit and preview files.
- Send a movie in an e-mail or upload it to a Web server.
- Add music files (.mp3).
- Import audio files such as .mp3, .asf, or .wma; video files such as .wmv, .asf, .avi, or .mpg; or image files such as .jpg or .gif.
- Create .avi and .wmv (Windows Media Video) files.

---

**NOTE:** You may have a software update CD included with your computer. You may need to install this CD before using the DVD Writer/CD Writer drive. To do this, follow the installation instructions that came with the CD.

---



# Managing Files

A *file* is any unit of information that is named and stored on the computer hard disk drive or other electronic storage media, such as a CD, diskette, or even in a digital camera. A file can be a document, picture, music, video, or other data. Almost everything that you do on the computer involves working with files.

The computer can copy files to other storage media within component drives, such as diskettes, memory cards, CDs or DVDs, or it can send them to output devices, such as a printer.

## Organizing Files with Folders

In Windows Vista, folders enable you to organize the files on the computer. Like paper folders within a filing cabinet, folders on the computer provide a way to group related files together.

A folder can contain any type of file, and it can even contain other folders. Each file within a folder must have a unique name, but two different folders can have files with the same name.

There are two methods for working with files and folders on the computer:

- The Computer view enables you to quickly see all the files and folders within a specific folder on the computer. It also contains links to common tasks for managing files, such as copying, moving, deleting, and renaming.



To open the Computer view, click the **Windows Start Button**  on the taskbar, and then click **Computer**.

- Windows Explorer enables you to quickly see all the folders and files on the computer. It also makes it easy to move or copy files from one folder to another.

To open Windows Explorer, click the **Windows Start Button**  on the taskbar, and then click **Windows Explorer**.

To navigate the Computer and Windows Explorer views, double-click folders to open and display their contents. Click the **Back** arrow button to retrace the path through the opened folders.

# Creating Folders



- 1 Click the **Windows Start Button**  on the taskbar, and then click **Computer**.  
Or  
Click the **Windows Start Button**  on the taskbar, and then click **Windows Explorer**.
- 2 Navigate to the location where you want to place the new folder.
- 3 Click **Organize**, and then click **New Folder**.
- 4 Type a name for the folder, and then press Enter on the keyboard.

# Moving Files



**CAUTION:** Do not move any file that is part of an installed program. Doing so can cause the program to become unusable.

---

- 1 Click the **Windows Start Button**  on the taskbar, and then click **Computer**.  
Or  
Click the **Windows Start Button**  on the taskbar, and then click **Windows Explorer**.
- 2 Find the file that you want to move, and then click it to select it.
- 3 Click **Organize**, and then **Cut**.
- 4 Find and open the folder in which you want to put the file.
- 5 Click **Organize**, and then **Paste**.

---

**NOTE:** You can also move files by dragging them into a new location. (You can have two or more Windows Explorer windows open at one time.) Select an item in Computer or in Windows Explorer, and then press and hold the right mouse button while moving the item into another folder. Release the mouse button and click **Move Here** to place the item in the new location.

---

# Finding Files

To find a file, you can use the Search box at the top of every folder, or the search box on the Windows Start Button menu, which searches the whole computer.

To search from a folder Search box:

- 1 Click the **Windows Start Button**  on the taskbar, and then click **Computer**.

Or

Click the **Windows Start Button**  on the taskbar, and then click **Windows Explorer**.

- 2 Find the folder that you want to search. Search looks in the current folder and all subfolders.
- 3 Click in the search box at the top of the window, and begin to type.

The Search box filters according to what you type. It displays files if your term matches the file name, tags, or other file properties. It displays text documents if the term occurs in any of the text inside the document file.



To search from the Windows Start Button menu:

- 1 Click the **Windows Start Button**  on the taskbar.
- 2 Type a word or question; what you type automatically appears in the *Start Search* box. As you type, the search results appear in the left pane.
- 3 Do one of the following:
  - Click a result to open it.
  - Click the **X** to clear the results of the search and return to the main list of programs.
  - Click **See all results** to show the results in a folder for advanced options.
  - Click **Search the Internet** to search the Internet by opening the browser.

# Renaming Files



**CAUTION:** Do not change the file name extension (the last three characters of a file name, after the period). Doing so could make the file unrecognizable to the computer.

- 1 Click the **Windows Start Button**  on the taskbar, and then click **Computer**.  
Or  
Click the **Windows Start Button**  on the taskbar, and then click **Windows Explorer**.
- 2 Find the file or folder you want to rename, and then click it to select it.
- 3 Click **Organize**, and then **Rename**.
- 4 Type the new name, and then press Enter on the keyboard.

**NOTE:** Another way to rename a file is to right-click the file, and then click **Rename**.

# Deleting Files



**CAUTION:** Do not delete any file that is part of an installed program. Doing so can cause the program to become unusable.

- 1 Find the file that you want to delete, and then click it to select it.
- 2 Click **Organize**, and then **Delete**.
- 3 Click **Yes** to confirm the delete and send the file to the Recycle Bin.

If you make a mistake and need to retrieve the deleted file, see “Retrieving Files from the Recycle Bin.”

**NOTE:** Another way to delete a file is to right-click the file, and then click **Delete**.



# Retrieving Files from the Recycle Bin

If you discover that you need a file that you have deleted, you can usually retrieve it from the Recycle Bin. When a file is deleted, it goes to the Recycle Bin and stays there until the Recycle Bin is emptied manually or it is cleared to make room for more recently deleted files.

- 1 Double-click the **Recycle Bin** icon on the desktop.
- 2 Right-click the file that you want to retrieve, and then click **Restore this item**.  
The file is removed from the Recycle Bin and goes back to its previous location.



# Copying Files

- 1 Click the **Windows Start Button**  on the taskbar, and then click **Computer**.  
Or  
Click the **Windows Start Button**  on the taskbar, and then click **Windows Explorer**.
- 2 Find the file that you want to copy, and then click it to select it.
- 3 Click **Organize**, and then **Copy**.
- 4 Find and open the folder in which you want to put the file.
- 5 Click **Organize**, and then **Paste**.

---

**NOTE:** You can also copy files by dragging them into a new location. Select an item in Computer or in Windows Explorer, and then press and hold the right mouse button while moving the item into another folder. Release the mouse button, and then select **Copy Here** to copy the item to the new location.

---

# Using a Printer

For instructions on connecting and using a printer, refer to the user manual that came with the printer.

Printers receive instructions from the computer by means of software programs called printer drivers. In many cases, the computer automatically finds the necessary printer driver for your particular printer to work with the computer. If it does not, follow the instructions that came with the printer to install the specific printer driver manually.

You can print text and graphics from most software programs and Web sites if you have a printer connected to the computer, and if the computer has the necessary software installed for the printer.

To print:

- 1 Click **File** on the program menu bar, and then click **Print**.
- 2 Select your printing options:
  - Select the printer.
  - Choose the page range (for example: all pages, current page, or range of pages).
  - Determine the number of copies.
- 3 Click **OK** or **Print**.



# Using CD and DVD Media Drives

## Using the CD and DVD Drives

Your computer can come with several types of CD or DVD drives that allow you to perform different tasks. What you can do depends on what kind of drive you have.

| <b>Allows you to:</b>                 | <b>CD-ROM</b> | <b>CD-RW</b> | <b>DVD-ROM</b> | <b>DVD+RW/+R</b> | <b>Blu-ray<br/>DVD+RW/+R</b> | <b>HD<br/>DVD+RW/+R</b> |
|---------------------------------------|---------------|--------------|----------------|------------------|------------------------------|-------------------------|
| Read data from CDs.                   | •             | •            | •              | •                | •                            | •                       |
| Play music CDs.                       | •             | •            | •              | •                | •                            | •                       |
| Read DVDs.                            |               |              | •              | •                | •                            | •                       |
| Record (burn) data or music to discs. |               | •            |                | •                | •                            | •                       |
| Play DVD movies.                      |               |              | •              | •                | •                            | •                       |
| Record (burn) DVD movies.             |               |              |                | •                | •                            | •                       |
| Read Blu-ray discs.                   |               |              |                |                  | •                            |                         |
| Record data to Blu-ray discs.         |               |              |                |                  | •                            |                         |
| Read HD discs.                        |               |              |                |                  |                              | •                       |

The combination (combo) drive is available on select models only. It combines the functions of two drives into one: either a DVD+RW/+R drive (DVD writer) and a CD-RW drive (CD writer), or a DVD-ROM drive and a CD-RW drive.

## Handling CDs and DVDs

To avoid damaging a disc, follow these guidelines:

- Return the disc to the case when you are finished using it.
- Handle the disc by its outside edges or center hole only.
- Do not touch the unlabeled side of a disc or place the unlabeled side down on a desk. Doing so could scratch the surface of the disc.
- Store discs at room temperature.

## Inserting and removing CDs and DVDs



**CAUTION:** Use only standard-shaped (circular) discs in the drives. Using non-standard discs, such as heart-shaped discs or business-card discs, may damage the drive.

---

To insert a CD or DVD:

- 1 With the computer turned on, press the Eject button near the front of the drive to open the disc tray.

---

**NOTE:** On some computers, the drive is located behind a door on the front of the computer.

---

- 2 Remove the CD or DVD from its case, holding the disc edges or center hole only.
- 3 Gently place the disc in the tray with the label facing up or facing right if the CD drive is vertically positioned in the computer.

---

**NOTE:** On a double-sided DVD, read the text around the center hole to determine which side (A versus B or Standard versus Widescreen) to play. Place the disc in the tray with the label facing up for the side that you want to play. If the CD drive is vertically positioned in the computer, place the disc with the label facing right for the side that you want to play.

---

#### 4 Close the disc tray by:

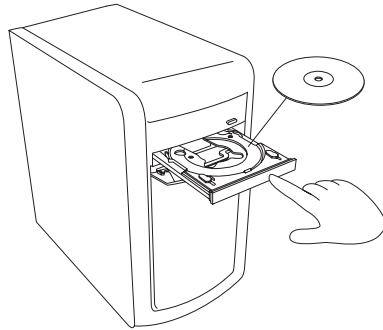

- Gently pushing the tray into the computer.

Or

- Clicking the open/close button on the control panel for the program that controls the drive.

Or

- Pressing the media control open/close button or Eject button on the keyboard (select models only).

Or

- Pressing the Eject button on the drive, if it is accessible.

To remove a CD or DVD:

- 1 With the computer turned on, open the disc tray by pressing the Eject button.
- 2 Holding on to the disc edges or center hole only, lift the CD or DVD out of the tray.
- 3 Place the disc in its case.
- 4 Close the disc tray by gently pushing the tray into the computer.

## Compatibility Information

An important feature of a DVD Writer/CD Writer drive is its high level of compatibility with other optical drives and CD and DVD players:

- The CDs that you create play in most home and car stereos as well as most computer DVD-ROM and CD-ROM drives.
- The DVDs that you create are compatible with some DVD video players and with most computer DVD-ROM drives.
- CD-R discs are more compatible with home and car stereos than CD-RW discs are.
- Blu-ray disc drives are required to play Blu-ray discs.
- Blu-ray disc drives can read Blu-ray discs and record to Blu-ray discs.
- HD disc drives are capable of playing HD discs but not recording HD data to disc.

The DVD Writer/CD Writer drive is able to read from and record to almost every type of optical disc. Writing speed rates for the DVD Writer/CD Writer drive are fast, allowing quick recording times.

# Disc Features and Compatibility Table

| Disc                            | File type | Can be recorded onto | Plays in computer | Plays in home or car stereo | Plays in home DVD player |
|---------------------------------|-----------|----------------------|-------------------|-----------------------------|--------------------------|
| <b>CD-ROM</b>                   | Data      | No                   | Yes               | No                          | No                       |
|                                 | Music     | No                   | Yes               | Yes                         | Varies by model          |
| <b>CD-R</b>                     | Data      | Yes                  | Yes               | No                          | No                       |
|                                 | Music     | Yes                  | Yes               | Varies by model             | Varies by model          |
| <b>CD-RW</b>                    | Data      | Yes                  | Yes               | No                          | No                       |
|                                 | Music     | Yes                  | Yes               | Varies by model             | Varies by model          |
| <b>DVD-ROM</b>                  | Data      | No                   | Yes               | No                          | No                       |
|                                 | DVD movie | No                   | Yes               | No                          | Yes                      |
| <b>DVD-RAM</b>                  | Data      | Yes                  | Varies by model   | No                          | No                       |
|                                 | DVD movie | Yes                  | Varies by model   | No                          | Varies by model          |
| <b>DVD+R and DVD-R</b>          | Data      | Yes                  | Yes               | No                          | No                       |
|                                 | DVD movie | Yes                  | Yes               | No                          | Varies by model          |
| <b>Double-layer DVD+R/DVD-R</b> | Data      | Yes                  | Varies by model   | No                          | Varies by model          |
|                                 | DVD movie | Yes                  | Varies by model   | No                          | Varies by model          |
| <b>DVD+RW and DVD-RW</b>        | Data      | Yes                  | Yes               | No                          | No                       |
|                                 | DVD movie | Yes                  | Yes               | No                          | Varies by model          |
| <b>Blu-ray DVD</b>              | Data      | Yes                  | Yes               | No                          | Varies by model          |
|                                 | Movie     | Yes                  | Yes               | No                          | Varies by model          |
| <b>HD DVD</b>                   | Data      | No                   | Yes               | No                          | Varies by model          |
|                                 | Movie     | No                   | Yes               | No                          | Varies by model          |
| <b>VCD</b>                      | DVD movie | No                   | Yes               | No                          | Varies by model          |

**NOTE:** Some computers come with the double-layer DVD Writer. It supports single-layer and double-layer DVD media. Double-layer technology gives you greater capacity and allows you to store up to 8 GB\* of data on double-layer DVD+R or DVD-R media. Double-layer is a new technology. Double-layer media compatibility varies widely with some home DVD players and DVD-ROM drives. \* 1 GB is defined as 1 billion bytes. 1 GB = 1 billion bytes when referring to hard disk drive capacity. Actual formatted capacity is less.

For the latest disc compatibility information for your computer, go to the HP Support Web site at: <http://www.hp.com/support>

**NOTE:** Double-layer DVD technology is supported by select models only.

# Optical Drive Quick Reference Table

| <b>Optical drive can:</b>                           | <b>CD-ROM</b> | <b>CD-RW</b> | <b>DVD-ROM</b> | <b>DVD-RAM</b> | <b>DVD+RW/+R<br/>DVD-RW/-R</b> | <b>Double-layer<br/>DVD</b> | <b>Combo<br/>CD-RW/<br/>DVD</b> | <b>LightScribe<br/>DVD+RW/+R</b> | <b>BD HD<br/>DVD+RW/+R</b> |
|---|---------------|--------------|----------------|----------------|--------------------------------|-----------------------------|---------------------------------|----------------------------------|----------------------------|
| Read CDs, CD-Rs, and CD-RWs.                        | Yes           | Yes          | Yes            | Yes            | Yes                            | Yes                         | Yes                             | Yes                              | Yes                        |
| Read DVDs.  | No            | No           | Yes            | Yes            | Yes                            | Yes                         | Yes                             | Yes                              | Yes                        |
| Read data on a CD.                                  | Yes           | Yes          | Yes            | Yes            | Yes                            | Yes                         | Yes                             | Yes                              | Yes                        |
| Play music.   | Yes           | Yes          | Yes            | Yes            | Yes                            | Yes                         | Yes                             | Yes                              | Yes                        |
| Record data or music to disc for storage or backup. | No            | Yes          | No             | Yes            | Yes                            | Yes                         | Yes                             | Yes                              | Yes                        |
| View DVD movies.                                    | No            | No           | Yes            | Yes            | Yes                            | Yes                         | Yes                             | Yes                              | Yes                        |
| Record DVD movies.                                  | No            | No           | No             | Yes            | Yes                            | Yes                         | No                              | Yes                              | Yes                        |
| Play games.   | Yes           | Yes          | Yes            | No             | Yes                            | Yes                         | Yes                             | Yes                              | Yes                        |
| Create LightScribe label.                           | No            | No           | No             | No             | No                             | No                          | No                              | Yes                              | Yes                        |
| Play Blu-ray DVD.                                   | No            | No           | No             | No             | No                             | No                          | No                              | No                               | Yes                        |
| Play HD DVD.  | No            | No           | No             | No             | No                             | No                          | No                              | No                               | Yes                        |
| Record data to Blu-ray disc.                        | No            | No           | No             | No             | No                             | No                          | No                              | No                               | Yes                        |
| Record HD data to DVD.                              | No            | No           | No             | No             | No                             | No                          | No                              | No                               | No                         |

# Using Blu-ray and HD Disc Drives

If the computer came with a Blu-ray (BR) and high-definition (HD) disc drive, there are three programs that are designed specifically for use with this drive:

- DVD Play plays Blu-ray, high-definition (HD), and regular commercial DVD discs.
- PowerDirector is a video editing program for creating Blu-ray or DVD discs.
- PowerToGo is a Blu-ray disc recording (burning) program for different types of data storage, such as video, music, pictures, and other data. This program enables you to record data to Blu-ray, HD DVD, and other recordable DVD discs.

---

**NOTE:** The BD HD DVD+RW/+R drive does not support recording high-definition data to disc.

---

For more information about using these programs, see “Playing DVDs” and “Creating Audio and Data Discs.”



# Using the Memory Card Reader

Digital cameras and other digital imaging devices use memory cards, or *media*, to store digital picture files. The optional memory card reader (select models only) can read from and write to a variety of types of memory cards and the IBM Microdrive disk drive.

The card reader is accessible directly on the front of the computer. It has four or two horizontal card slots, which accept the memory cards and the Microdrive disk drive.

You can place media in one or more of the card slots and use each media independently. Place only one piece of media in a slot at one time.

Each card slot has its own drive letter and icon. When you insert media, the display label may change to the title of the media, if a title is present.

When you insert media, the Safely Remove Hardware window may appear. If it opens, or if you open the Safely Remove Hardware window by mistake, click **Close**.



**CAUTION: Do not click *Stop* in the Safely Remove Hardware window with the USB Mass Storage Device selected. Doing so removes the operating system recognition of the memory card reader from your computer, and you must restart the computer to see your memory card reader again.**

---

To use the memory card reader:

- 1 Insert the media into the card slot until it stops.

The activity light **(A)** on the memory card reader lights, and the computer automatically detects the media.

---

**NOTE:** You must insert media correctly. Note the direction of the notched corner on the media. For more information, see "Media Insertion Guide." CompactFlash and Microdrive are keyed and cannot be inserted incorrectly. Insert the receptacle edge (holes) of this media into the slot.

---

- 2 Select a program to access your files. The computer opens a program, so that you can access the media contents. You can copy files from or to the media.

Or

If the AutoPlay window does not open, click the **Windows Start Button**  on the taskbar, click **Computer**, and then double-click the **Memory Card** icon to display the files on the memory card.

- 3 When you are finished, right-click the drive icon, click **Eject**, check that the activity light is on but not blinking, and then remove the media. A steady activity light indicates that the computer is not reading or writing the media card.



**CAUTION: Do not try to remove media when the activity light is blinking. Doing so may cause loss of data.**

---

## Media Insertion Guide

### 4-slot memory card reader (select models only)

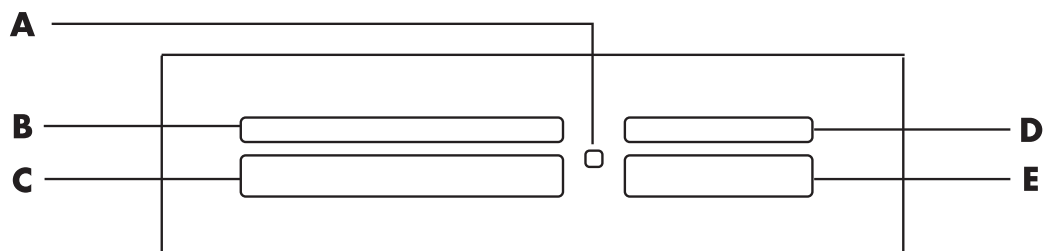

- A Activity light
- B Upper-left slot
- C Lower-left slot
- D Upper-right slot
- E Lower-right slot

| <b>Card</b>                               | <b>Insert the media</b> | <b>4-slot reader location</b>            |
|---|-------------------------|--|
| SmartMedia (SM) memory card               | Facing up               | <b>B</b> (upper-left) <b>SM</b>          |
| xD media                                  | Facing up               | <b>B</b> (upper-left) <b>xD</b>          |
| CompactFlash Type I media                 | Receptacle edge (holes) | <b>C</b> (lower-left) <b>CF/I</b>        |
| CompactFlash Type II media                | Receptacle edge (holes) | <b>C</b> (lower-left) <b>CF/II</b>       |
| Microdrive disk drive                     | Receptacle edge (holes) | <b>C</b> (lower-left) <b>MD</b>          |
| Secure Digital (SD) memory card           | Facing up               | <b>D</b> (upper-right) <b>SD</b>         |
| Mini Secure Digital (MiniSD) Memory Card* | Facing up               | <b>D</b> (upper-right) <b>MiniSD</b>     |
| MultiMediaCard (MMC)                      | Facing up               | <b>D</b> (upper-right) <b>MMC</b>        |
| Reduced size MultiMediaCard (RSMMC)*      | Facing up               | <b>D</b> (upper-right) <b>RSMMC</b>      |
| MultiMediaCard Plus (MMC +)*              | Facing up               | <b>D</b> (upper-right) <b>MMC Plus</b>   |
| MultiMediaCard Mobile (MMC Mobile)*       | Facing up               | <b>D</b> (upper-right) <b>MMC Mobile</b> |
| Memory Stick (MS) memory card             | Facing up               | <b>E</b> (lower-right) <b>MS</b>         |
| Memory Stick (MS-Pro) memory card         | Facing up               | <b>E</b> (lower-right) <b>PRO</b>        |
| Memory Stick (MS-Pro Duo) memory card*    | Facing up               | <b>E</b> (lower-right) <b>PRO Duo</b>    |
| Memory Stick (MS-Duo) memory card*        | Facing up               | <b>E</b> (lower-right) <b>MS Duo</b>     |





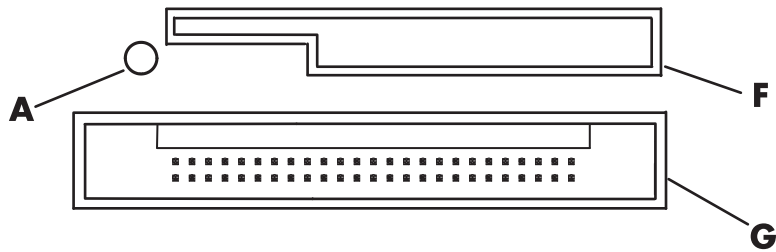

\*Select models only. Not available in all countries/regions.

**NOTE:** Some memory cards, such as CF Ultra/III, are not compatible with the memory card reader that came with the computer.

## 2-slot memory card reader (select models only)



- A** Activity light
- F** Upper slot
- G** Lower slot

| Card                              | Insert the media                           | 2-slot reader location   |
|-----------------------------------|--|--|
| Secure Digital (SD) Memory Card   | Facing up<br>(gold connector fingers down) | <b>F</b> (upper)    |
| MultiMediaCard (MMC)              | Facing up<br>(gold connector fingers down) | <b>F</b> (upper)    |
| Memory Stick (MS) Memory Card     | Facing up<br>(gold connector fingers down) | <b>F</b> (upper)   |
| Memory Stick (MS-Pro) Memory Card | Facing up<br>(gold connector fingers down) | <b>F</b> (upper)  |
| SmartMedia (SM) Memory Card       | Facing down<br>(gold connector fingers up) | <b>F</b> (upper)  |
| xD media                          | Facing up<br>(gold connector fingers down) | <b>F</b> (upper)  |
| IBM Microdrive disk drive         | Receptacle edge (holes)                    | <b>G</b> (lower)   |
| CompactFlash Type I media         | Receptacle edge (holes)                    | <b>G</b> (lower)   |
| CompactFlash Type II media        | Receptacle edge (holes)                    | <b>G</b> (lower)   |

**NOTE:** Do not use SM and xD media in the memory card reader at the same time. Only the first one that is inserted is recognized by the memory card reader.

# Understanding the Activity Light

The memory card reader activity light is off when there are no media cards plugged into the slots.

The light turns on when a media card is inserted into a slot.

The light blinks when data is being transferred between the card and the computer.

## Formatting a Memory Card

If you have not used the memory card before, or if the card has become corrupted, you may need to format the card before using it.

---

**NOTE:** Some memory cards have a lock position. To view or edit your picture files, make sure that the memory card is in the unlocked position.

---

- 1 Format the memory card in your digital camera. Follow the instructions that came with your digital camera.  
Or  
Insert the media into the correct card slot on the reader until it stops and locks into place. The activity light on the memory card reader lights, and the computer automatically detects the media.
- 2 Click the **Windows Start Button**  on the taskbar, and then click **Computer**.
- 3 In the Devices with Removable Storage area, right-click the correct memory card icon.
- 4 Select **Format**, and then type a label name into the label box.
- 5 For best compatibility, select **FAT** as the file system settings.
- 6 Click **Start**.
- 7 Click **OK** in the Format Complete window, and then click **Close**.

# Troubleshooting the Memory Card Reader

If you are having problems reading from or writing to a memory card, try the following:

- Some cards have a read/write or security switch on the card. Make sure that the read/write switch is set to Write Enabled before attempting to write data to the card.
- Make sure that the amount of data that you want to store is not larger than the storage limit of the memory card.
- Make sure that the memory card is one of the supported types: CompactFlash Type I and II, Microdrive, Memory Stick, Memory Stick Pro, MultiMediaCard, Secure Digital, SmartMedia, or xD media.
- Make sure that the memory card is fully inserted into the correct slot.
- Remove the memory card when the activity light is not blinking, and shine a flashlight into the empty slot. If any of the pins are bent, replace the memory card reader, or have the computer serviced if a pin is touching another pin. To straighten slightly bent pins, use the tip of a fine-point retracted ballpoint pen with the computer off.
- Inspect the ends of the memory cards for anything that could be blocking a proper connection. Clean the contacts with a lint-free cloth and small amounts of alcohol. Replace the memory card, if necessary.
- The memory card reader is a device that uses the Safely Remove Hardware task. This appears as a taskbar icon next to the time. Do not click **Stop** in the Safely Remove Hardware window. Doing so disconnects the drive. If this happens, restart the computer.
- Do not insert or remove memory cards when the activity light is blinking. Doing so may cause data loss, or it may permanently damage the card reader.
- Format a memory card before you use it. See “Formatting a Memory Card.”

# Using the HP Personal Media Drive and HP Pocket Media Drive

The HP Personal Media Drive and the HP Pocket Media Drive (HP Media Drives) can be used as internal or external USB hard disk drives designed to quickly and easily increase the storage capacity and to transfer media files such as digital photos, music, videos, and other important files. You can also use the HP Media Drives to back up other drives on the computer.

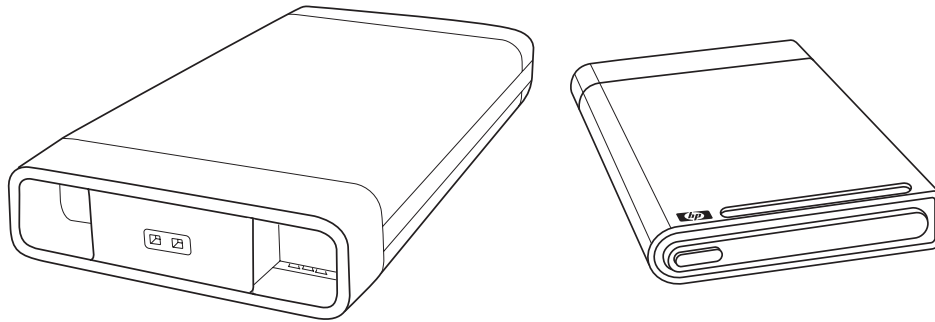

---

**NOTE:** The HP Personal Media Drive and the HP Pocket Media Drive are included with select models only. Both drives are sold separately.

---

The HP Media Drives are designed to:

- Work with computers that have a USB port.
- Store large media files and personal files from digital cameras, digital video camcorders, and MP3 players.
- Quickly transfer files between PCs.
- Play media files.
- Back up your files. Perform system backups for added data security.

For more information about using HP Media Drives with Windows Media Center, refer to the documentation on the HP Support Web site at: <http://www.hp.com/support>

## Connecting the Drive

The HP Media Drive is designed to work with most computers as an external drive that is connected by using a USB cable, but it also can be inserted into specifically designed HP computers. These computers have a special horizontal or vertical drive bay that connects to the drive by using an internal USB connector. The drive can be easily inserted and removed from the hard disk drive bay without turning off the computer. This is sometimes referred to as *warm-swappable*.

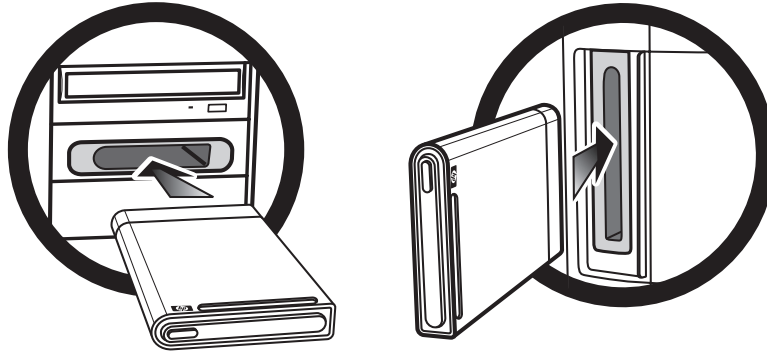

The drive turns on when it is plugged into an active USB port. If the computer is turned on with the drive connected, the drive automatically turns on. When the USB cable for the drive is not plugged in or when the USB power from the computer is turned off, the drive automatically turns off. When the computer is in sleep mode (a reduced-power state), the drive remains turned on.



---

**WARNING: Do not move the computer with the HP Media Drive inserted in the bay or connected to a USB port on the computer. This can cause both damage to the drive and data loss.**

---



# Inserting the Drive into an HP Drive Bay

- 1 Turn on the computer.
- 2 In the horizontal position, insert the drive with the HP logo facing up and the HP product name right-reading. In the vertical position, the drive's flat side is down, and the rounded side is up. Do not force the drive into the bay; it should slide easily into the bay.
- 3 Slide the drive all the way into the drive bay until the drive is firmly connected to the internal connections. With the computer turned on and the drive inserted correctly, the power LED (**B, D**) on the front of the drive is lit.

## HP Media Drive fronts

- A** Drive activity indicator light
- B** Power on indicator light
- C** HP Personal Media Drive guide ridges
- D** Power/drive activity LED indicator

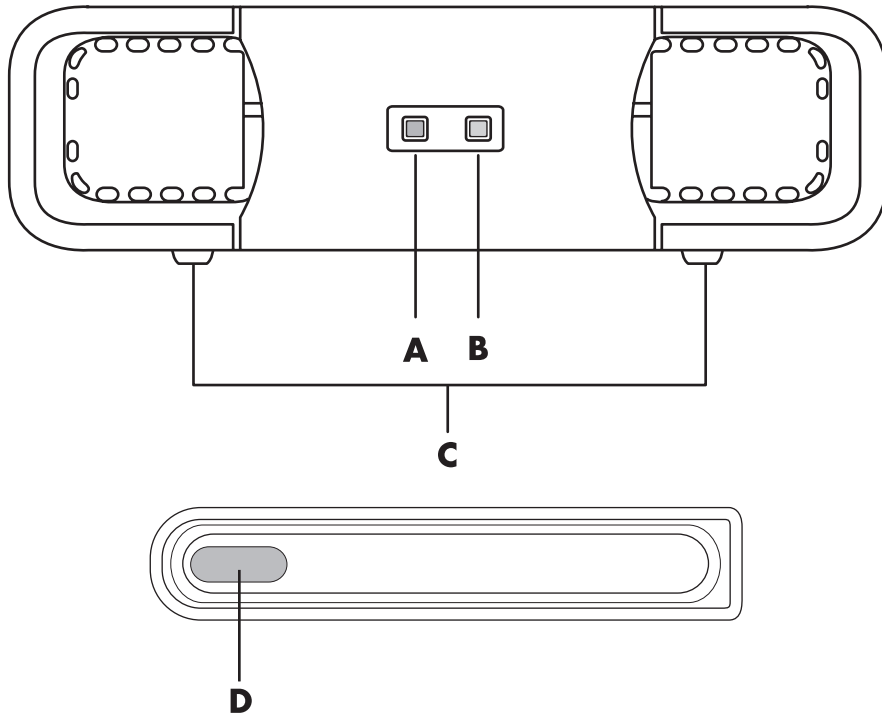

HP Personal Media Drive (**A, B, C**)

HP Pocket Media Drive (**D**)

# Connecting the Drive to a Computer Without a Drive Bay

The HP Media Drives are designed to work with most computers as an external hard disk drive that you connect by using a USB 2.0 cable. If the computer has USB 1.1 ports, use two USB ports to insure that enough power is supplied. Most USB 2.0 ports can supply enough power so that only one USB connection is required.

When connecting the drive to a computer without a drive bay, the HP Personal Media Drive requires a separate power supply in addition to a USB 2.0 connection. The HP Pocket Media Drive does not require a separate power supply because power is supplied through the USB 2.0 connection.

---

**NOTE:** The HP Personal Media Drive comes with a built-in fan; the HP Pocket Media Drive does not come with a fan.

---

To connect the drive:

- 1 Turn on the computer.
- 2 Plug the rectangular end of the USB 2.0 cable (**E**) into an available USB port on the computer. Plug the square end of the USB 2.0 cable (**F**) into the USB connector on the back of the HP Media Drive.

---

**NOTE:** USB 2.0 uses only one USB connector. USB 1.x systems use both USB connectors.

---

- 3 Install the software and drivers. Refer to the HP Media Drive documentation for more information.

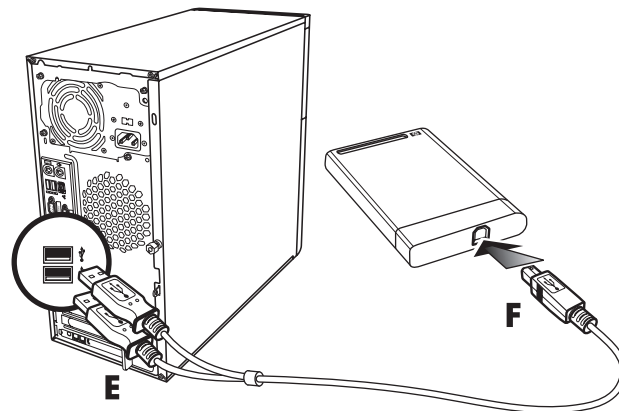

# Locating the Drive and Assigning a Drive Letter

When you plug the drive into a USB 2.0 connector or insert it into an HP Media Drive bay, the operating system automatically assigns a letter to the hard disk drive. The assigned letter depends on other storage devices connected to the computer.

To locate the drive:

- 1 Click the **Windows Start Button**  on the taskbar.
- 2 Click **Computer**.
- 3 Select the drive under Hard Disk Drives or Devices with Removable Storage. The default volume name of this drive is *HP Personal Media Drive* or *HP Pocket Media Drive*.

You can rename the drive in the Computer window by right-clicking the drive, selecting **Rename**, and then typing in a new name. HP recommends renaming a drive if you have more than one external hard disk drive.

You can permanently assign a drive letter to avoid the letter changing when you connect and disconnect this drive and other devices. Also, it is easier for a software program to locate the files on the HP Media Drive if a drive letter is assigned. Some programs may not be able to find files if the drive has a new drive letter.

It is always best to remove the drive safely to avoid errors. See “Disconnecting the Drive.”

To assign a drive letter:

- 1 Click the **Windows Start Button**  on the taskbar.
- 2 Right-click **Computer**.
- 3 Select **Manage**.
- 4 Click **Disk Management**.
- 5 Right-click **HP Media Drive**.
- 6 Select **Change Drive Letter and Paths**.

---

**NOTE:** To avoid multiple hard disk drives from using the same drive letter when connecting and removing the drives, assign the letter Z.

---

- 7 Click **Change**.
- 8 Select a letter from the drop-down menu, and then apply the changes by clicking **OK**.

## Using the Drive

When running for long periods of time, the aluminum case of the HP Media Drive may become very warm. This is part of the HP Media Drive's advanced design and is completely normal.

The built-in, low-noise fan is designed to turn on automatically at pre-set temperatures. If you are using the HP Media Drive connected externally to the computer, place the drive in a well-ventilated area.

### Transferring files to another computer manually

You can transfer your computer profile information, which includes how the computer looks, as well as the personal files such as photos, music, or video you have created.

To transfer your files manually:

- 1 Connect the drive to the computer.
- 2 Select your files, and then drag and drop them to the HP Media Drive in the Computer window.
- 3 Disconnect the drive and then connect it to another computer.
- 4 Select your files and then drag and drop them to the new computer's hard disk drive.

## Disconnecting the Drive



**CAUTION: To avoid hardware damage and data loss, always disconnect the HP Media Drive safely when it is not saving or transferring files.**

---

You can safely remove the drive when it is not active. When the amber activity light is blinking, the drive is active, saving or transferring data. Removing the drive while the light is blinking may cause data loss or damaged files.

To disconnect the HP Media Drive safely:

- 1 Close all programs that may be accessing the HP Media Drive. Make sure that the activity light on the drive is off.
- 2 Double-click the **Safely Remove Hardware** icon in the system tray at the bottom of the desktop. If this icon is hidden, click the arrows on the taskbar to display it. The Safely Remove Hardware window opens.

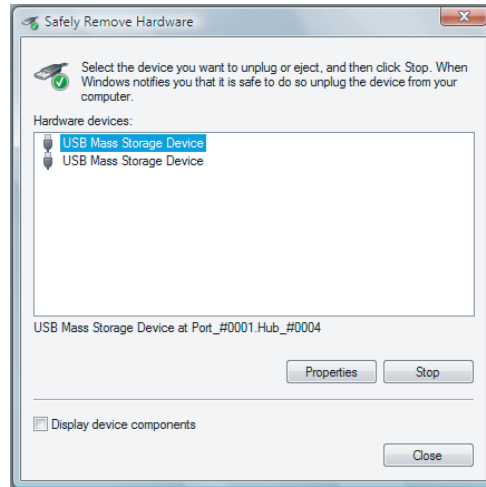

---

**NOTE:** For some computers, this may be called the Unplug Hardware or Eject Hardware icon.

---

- 3 Double-click **USB Mass Storage Device** to locate the HP Media Drive. USB Mass Storage Device may be listed twice. One may contain a memory card reader or other mass storage drive. Look for the label of this drive.
- 4 Select **HP Media Drive**, and then click **OK**. The name of the drive may be different if you renamed it, or it may appear as Generic Volume followed by the assigned drive letter.  
*A Safe to Remove Hardware message appears in the system tray, letting you know that the device is safe to disconnect.*
- 5 Click **Stop** to make sure the HP Media Drive is not active, and then click **Close**.
- 6 Disconnect the drive from the computer.

## Troubleshooting the HP Media Drive

### Microsoft updates

Make sure you have the latest Microsoft operating system service packs and other Windows updates installed on your system before you try to troubleshoot a drive problem. These service packs are issued to fix bugs, add drivers, and enhance the security features of your system. See <http://support.microsoft.com> for details about how to install service packs and Windows updates in your system. Contact Microsoft Customer Service for information about obtaining these system enhancements if you do not have Internet access.

## Drive does not appear on my computer

Try the following solutions in the order listed:

- 1 Check to see if the drive is on. The power LED on the front of the drive should be lit.
- 2 Check that the USB cable is securely and properly connected to the drive and the USB connector on the computer.
- 3 While the computer is turned on, unplug the USB cable. Wait 10 seconds, and then reconnect the USB cable.
- 4 See if the computer is recognizing the USB port you are using by checking in the Device Manager window. See the documentation that came with the computer for more information.

## Data transfer rate seems slow with my USB 2.0 adapter card

The HP Media Drive operates as fast as the host adapter card allows (up to the maximum burst rate of 480MB/sec.). If you are having performance issues, make sure that the USB 2.0 card drivers are the most current available and are installed properly.

## HP Media Drive software has stopped working

Reinstall the software. Refer to the software and drivers installation instructions that came with the HP Media Drive.

## Write Cache Enable does not stay enabled

For protection of your data, Write Cache Enable is turned off with the HP Pocket Media Drive. For more information, go to: <http://www.hp.com/support>

## Administrator privilege for installing software

Depending on the operating system, you may need to be logged on as the administrator to install software.

To change a user's account:

- 1 Click the **Windows Start Button**  on the taskbar.
- 2 Click **Control Panel, User Accounts and Family Safety**, and then click **User Accounts**.
- 3 Click **Manage another account**, and then click the account you want to change.
- 4 Click **Change the account type**, select the account type you want, and then click **Change Account Type**.

# Playing CDs, DVDs, or VCDs

This section describes how to play CDs, DVDs, or VCDs by using Windows Media Center, Windows Media Player, or other audio and video programs.

This section also describes using Music and radio, and changing DVD and audio settings.

## Using Music

The Music area in Windows Media Center is a great way to play, organize, and back up your music files. It is designed to work with the Windows Media Player program.

You can find and play your favorite music files and CDs that you have added to the music library and the Windows Media Player music library. In addition, you can listen to various Internet radio stations.

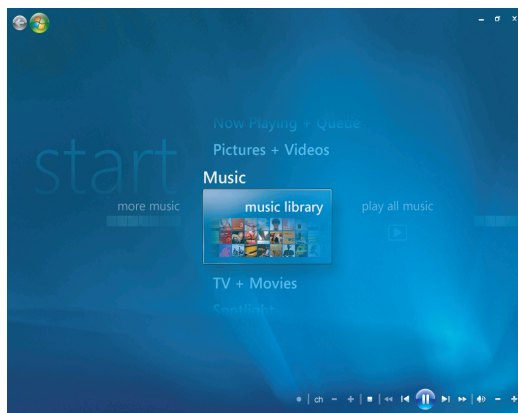

There are several Windows Media Center music menus from which you can choose:

- Music library
- Play all
- Radio
- Search

All these menu options are described in detail in this section.

# Using Music with Windows Media Center

You can copy digital music files and organize a music library by using music library in the Windows Media Center or by using the Windows Media Player program.

Music files that are added to music library in the Windows Media Center and in the Windows Media Player are accessible from within Windows Media Center and the Windows Media Player.

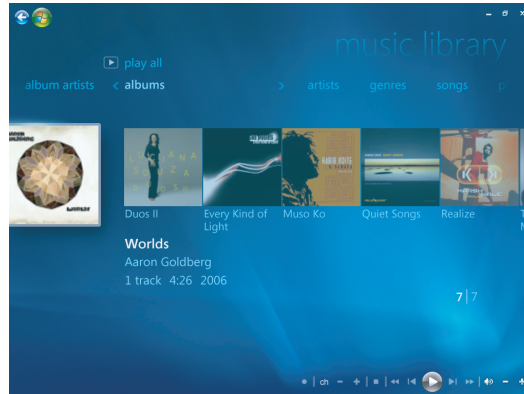

In Windows Media Center Music, you can:

- Play CDs or selected music tracks from your created music library in the Windows Media Center or the Windows Media Player.
- Select and edit a personalized list of songs in the *playlist* from the music library.
- Delete songs from a music library or a queue list.
- Burn your favorite songs to CDs.
- Back up your music tracks to a DVD or to an HP Personal Media Drive or other storage device.
- Listen to Internet Radio (select models only).
- Search music tracks and files.
- Organize your music by artist, album, song, composer, year, playlist, and genre.



# Using the music library

## Adding music to the music library

When you add music files to the music library, they are placed into the music library in the Windows Media Center and the Windows Media Player. The added music files can immediately be found and played back using Music in Windows Media Center or the Windows Media Player.

You can also add music files to the music library from within the Windows Media Player program. For more information about adding and deleting music files to the library, use the Windows Media Player Help menu.

## Adding music files from the hard disk drive

- 1 Click the **Windows Start Button**  on the taskbar, and then click **Windows Media Center**.

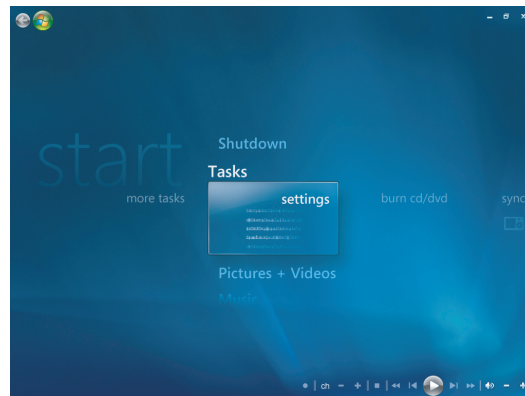

- 2 From the Tasks menu, click **settings**.
- 3 Click **Library Setup**.
- 4 Click **Add folder to watch**, and then click **Next**.

- 5 Click **Add folders on this computer**, and then click **Next**.



- 6 Use the arrow buttons on the keyboard or the remote control to select a location. When you find the folder that contains the music folder, select it by making sure an arrow appears next to the folder. Repeat this step to add additional folders, click **Next**, and then click **Finish**.
- 7 Click **OK**.

## Adding music files from a CD

To add the CD tracks to the Windows Media Center music library:

- 1 Click the **Windows Start Button**  on the taskbar, and then click **Windows Media Center**.
- 2 Click **Music**.
- 3 Click **music library**.
- 4 Insert a CD into the CD drive.
- 5 Select **albums**.
- 6 Select the album CD you want to add to the music library.
- 7 Click **Copy CD**. The first time that you copy a music CD, you must select the copy-protection option, and then follow any onscreen instructions.
- 8 After selecting the choices for copy options in the next few windows, click **Next**.
- 9 Click **Yes** to begin copying tracks to the music library. This process may take several minutes, depending on the length of the music tracks.
- 10 Click **OK**.

---

**NOTE:** You can select **Play Album**, **Add to Queue**, **Burn (CD/DVD)**, **Edit Info**, and **Delete** in the album details window from any of these options by clicking any album.

---

## Deleting music files from the music library

- 1 Click the **Windows Start Button**  on the taskbar, and then click **Windows Media Center**.
- 2 Click **Music**.
- 3 Click **music library**.
- 4 Click **albums**.
- 5 Select the album that you would like to delete, and then click **Delete**.
- 6 Click **Yes** when the Confirm Delete window is displayed.

---

**NOTE:** To delete individual songs, click **songs**, right-click a song and then click **Delete**.

---

## Using supported music file types

You can play the following types of digital audio files in Music. Refer to Windows Media Player Help for more information about supported file types.

| File extension               | File type                |
|------------------------------|--------------------------|
| <b>.cda</b>                  | Audio CDs                |
| <b>.wav</b>                  | Windows audio file       |
| <b>.mp3, .m3u</b>            | MP3 audio file           |
| <b>.wma, .asx, .wmx, .wm</b> | Windows Media Audio file |

---

**NOTE:** Only supported audio file types are displayed in the Music window. Unsupported file types do not display or play.

---

# Playing Music Files in Windows Media Center

To open Windows Media Center, select **Music** by scrolling up or down in the Windows Media Center window, and then by clicking **music library**. You will find a few music albums and tracks listed in the Windows Media Center and Windows Media Player music library.

To play music, click one or more songs, and then click **play**. You can also click **play all** to hear all of the tracks that are stored in Music.

---

**NOTE:** You may not find any audio files when you click **playlists** for the first time unless you have already added audio files to your Windows Media Center and Windows Media Player music libraries. When you copy music files using Windows Media Center or Windows Media Player, the CD information is copied and displayed in Windows Media Center and in the Windows Media Player music library.

---

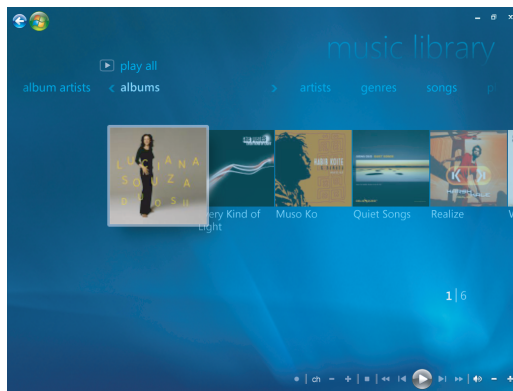

---

**NOTE:** You can place all your music files into the Music folder or into other folders on the hard disk drive, but you need to add those files to the Windows Media Center or Windows Media Player music library for either program to be able to find and play them.

---

If you insert a music CD when Windows Media Center is not open, the AutoPlay window appears and lists various options. You can select the Audio CD options by using the Windows Media Center or Windows Media Player. If you have another program set as the default audio player, Windows opens the program and begins playing the CD. You can set the AutoPlay defaults in the Control Panel.



## Changing the visualization settings

You can change the visualization settings such as the alchemy, bars and waves, and battery settings. You can also set the visualization options to start visualizations when the music plays at the beginning of the song, always, or never.

Click the **Windows Start Button**  on the taskbar, and then click **Windows Media Center**.

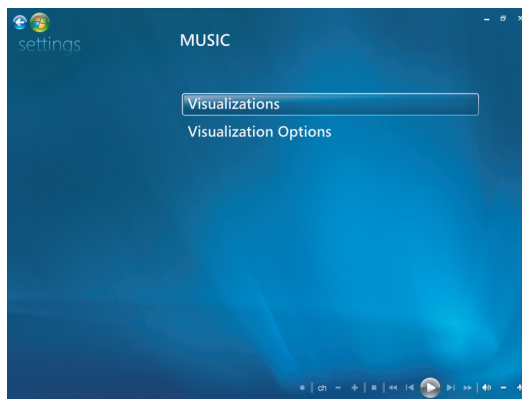

- 1 From the Tasks menu, click **settings**, and then click **Music**.
- 2 Click **Visualizations** or **Visualization Options**.
- 3 After making the changes, click **Save**.

## Playing an album in Windows Media Center

- 1 Click the **Windows Start Button**  on the taskbar, and then click **Windows Media Center**.
- 2 Click **Music**.
- 3 Click **music library**.
- 4 Insert a music CD into the CD drive.
- 5 Click **albums**.
- 6 Select the album that you want to play.
- 7 Click **Play Album**.

## Playing a song in Windows Media Center

You can play a song from anywhere in Music. You can select it from the *songs* list, or from the *albums*, *artists*, *genres*, *composers* and other lists. You can also play a single song from a playlist:

- 1 Click the **Windows Start Button**  on the taskbar, and then click **Windows Media Center**.
- 2 Click **Music**.
- 3 Click **music library**.
- 4 Click **songs**. The list displays all of the songs in the library.
- 5 Use the arrow buttons on the remote control or the arrow keys on the keyboard or select a song by moving the mouse and clicking the song.
- 6 Click **Play Song** to play it.

---

**NOTE:** You can select **View Queue**, **Visualize**, **Play Slide Show**, **Shuffle**, **Repeat**, and **Buy Music** in the now playing window while you play a music track.

You can select **Add to Queue**, **Buy Music**, **Edit Info**, and **Delete** in the song details window while you play a song.

---

# Creating a Queue in Windows Media Center

A *queue* is a temporary list of songs that is created in Music as you select songs, albums, or playlists to play. You can continue to add songs, or you can delete songs from the queue.

You can create a queue and save it as a playlist that you can access in Windows Media Center or the Windows Media Player.

1 From the Music window:

- Select **music library**, select **songs**, and then use the arrow keys to select a song you want, or move the mouse over the songs. Click the song that you would like to add to the queue, and then click **Add to Queue**.

Or

- Select **albums** or **playlists**, select an album or a playlist, and then select **Add to Queue** to add the entire album or playlist to the queue.

2 Use the Back button on the remote control or the Backspace key on the keyboard to go back to the songs, albums, or playlists menus if you want to select more songs to add to the queue list. Repeat step 1. Or click the mouse on the left arrow on the top left of the screen to go back. 

3 After you add the last song for the queue list, select **play all**. All of the songs in the queue list are played in the order you have selected them.

4 While the queue is being played, you can view the queue by selecting **View Queue**. You can edit or clear a queue, save it as a playlist or burn a queue list on a CD or a DVD. You can also select to shuffle the songs in the queue list.

# Finding and Playing an Album in Windows Media Center

1 From Windows Media Center, click **Music**, and then click **music library**.

2 Use the arrow buttons on the remote control, or the arrow keys on the keyboard or the mouse, to select an album, and then press OK on the remote control. Press the Enter key on the keyboard or click the album to select the album and see the album details.

## Using album details

In the album details window, you can select from:

- **Play** to play the album.
- **Add to Queue** to add to a queue list.
- **Burn** to burn the tracks on a CD or a DVD.
- **Edit** to edit the information of the album.
- **Delete** to delete the album.

- 1 Click **Play Album** to play the album from the album details window.
- 2 The now playing window opens, and the album starts playing.
- 3 In the now playing window, you can also select:
  - **View Queue** to view an ordered list of all tracks that will be played on the album.
  - **Visualize** to view a moving picture while listening to a song.
  - **Play Slide Show** to play a slide show while the album is playing.
  - **Shuffle** to rearrange the play order.
  - **Repeat** to play the album again.
  - **Buy Music** to connect to the Internet, find CD information, and buy music CDs.
  - To go back to Windows Media Center, press Start on the remote control, or click the left arrow on the top left of the screen.
- 4 To return to the previous window, press the Back button on the remote control or the Backspace key on the keyboard, or click the left arrow on the top left of the screen to go back. 

## Using Search in Windows Media Center

### Searching for music tracks and files

You can search for music files if you cannot locate them:

- 1 Click the **Windows Start Button**  on the taskbar, and then click **Windows Media Center**.
- 2 Click **Music**, and then double-click **search**.



- 3 To search, enter letters by using either the alphanumeric keypad on the remote or the keyboard. The search begins when you enter the first letter.



# Creating a Playlist in Windows Media Center

A *playlist* is a customized list of songs that you can keep to play later or record to a CD. Using playlists, you can group various digital music files together and determine the order in which you want the files to play.

You can create a playlist that includes several tracks from various CDs or even a playlist that contains background music for a slide show.

You can create playlists in Windows Media Center or the Windows Media Player.

To create a playlist:

- 1 Select **Music**, select **music library**, and then select either **albums**, **artists**, **playlists**, **songs**, or **genres**.
- 2 Use the arrow buttons on the remote control, or the arrow keys on the keyboard, or use the mouse to navigate to and select the music that you want to add to the playlist.



- 3 Press OK on the remote control, or press the Enter key on the keyboard, or click the selection to select a song.
- 4 Click **Add to Queue** to add the music to the list of music in the queue.

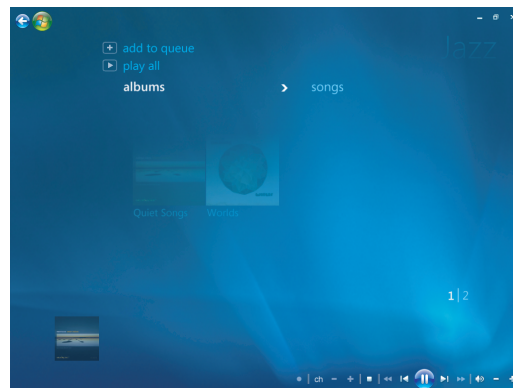

- 5 Go back to the Windows Media Center. Click the mouse on the left arrow on the top left of the screen to go back to Windows Media Center. 
- 6 Click **play all**.
- 7 Click **View Queue**.
- 8 Click **Save As Playlist**, and give the playlist a name.
- 9 Use the alphanumeric keypad to enter a name for the playlist, and then click **Save**.

---

**NOTE:** If the computer is connected to the Internet, the CD track titles and cover art appear in Windows Media Center.

---

## Copying Music Files to CD in Windows Media Center

To copy the music files to CD:

- 1 Click the **Windows Start Button**  on the taskbar, and then click **Windows Media Center**.

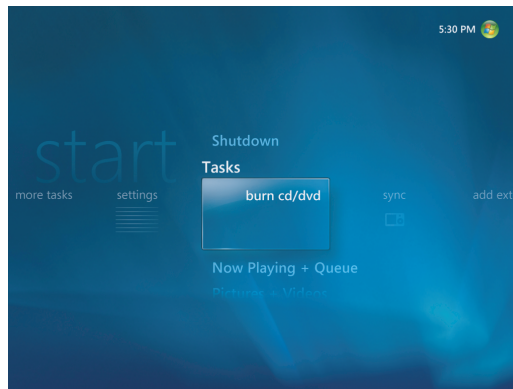

- 2 Click **Tasks**, and then click **burn cd/dvd**.
- 3 A message opens asking you to insert media. Insert a blank CD-R disc, and then click **Retry**.

- 4 Select a disc format, either **Audio CD** or **Data CD**, and then click **Next**.

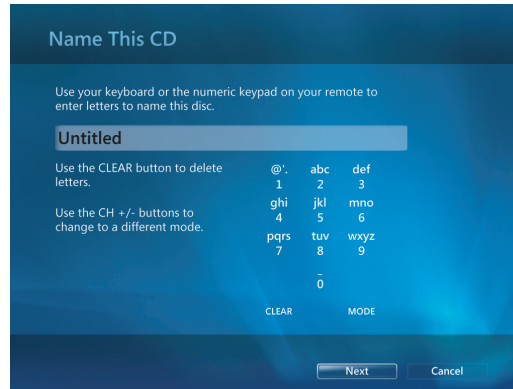

- 5 Use the arrow keys on the keyboard to select the **Untitled** text box.
- 6 Use the alphanumeric keypad buttons on the remote control or the keyboard to enter a name for the CD, and then click **Next**. This will take you to the Choose Music window.
- 7 Use the arrow keys to scroll through songs. You can select more songs by clicking **albums**, **playlists**, and other music menu options. A check mark appears next to the song when it is selected. Press the Back button on the remote control or click **Add More** in the Review & Edit List to select more songs from different menus. You can also change the name of the CD by clicking **Change Name**, and clear all selections by clicking **Clear All** in this window.
- 8 Click **Next** when you have selected all the songs to record to CD.
- 9 Click **Burn CD** to record your music to disc.
- 10 Click **Yes** to confirm you want to burn a disc with these files.
- 11 Click **OK** to do other things while the disc is being burned.
- 12 Click **Done** when the recording is complete.

---

**IMPORTANT:** HP supports the lawful use of technology and does not endorse or encourage the use of our products for purposes other than those permitted by copyright law.

---

**NOTE:** For more information about writable media, refer to “Disc Features and Compatibility Table.”

---

# Listening to Online Radio Stations

In the radio area of Windows Media Center, you can play, listen, and preset various online radio stations.

- 1 From the Windows Media Center, click **Music**, and then click **radio** twice.
- 2 Click **presets** to preset and organize your favorite radio stations.
- 3 By clicking **sources**, you can access the Music and Radio menu.

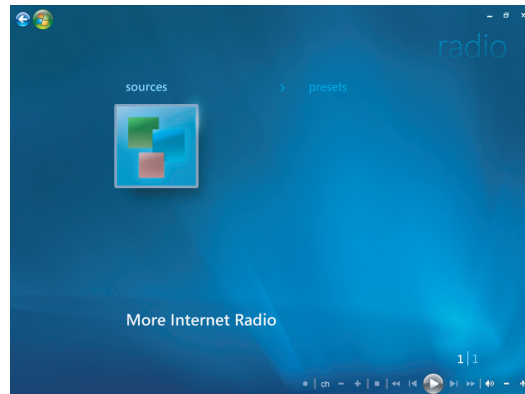

- 4 Click the right mouse button to view a list and to go to the settings menu.
- 5 Click the right mouse button for the icons to appear to go to the previous menu.

# Playing Music CDs

To play music CDs, you must have either a CD or DVD drive.

- Insert the music CD into the CD or DVD drive.
- The default audio program opens. If a dialog window opens, choose the program you want to use from the list. You may have to scroll down in the window to see all available programs.
- The music CD automatically begins to play.

# Playing CDs with Windows Media Player

---

**NOTE:** Some commercial music CDs are copy-protected and cannot be played with Windows Media Player. Such CDs come with their own (built-in) player that must be used.

---

- 1 Insert the music CD or DVD movie into the drive.
  - When the AutoPlay window opens, select **Windows Media Player** from the list. You may have to scroll down in the window to see Windows Media Player.

Or

  - If the Windows Media Player window does not automatically open, click the **Windows Start Button**  on the taskbar, click **All Programs**, and then click **Windows Media Player**.
- 2 To play the CD or DVD, click the **Now Playing** tab on the Windows Media Player taskbar. You can also control playback by using the media control buttons on the keyboard (select models only).

---

**NOTE:** The computer must have a connection to the Internet to see CD information such as artist name, song titles, and album art.

---

For more information on using Windows Media Player, click the drop-down arrow on the Player taskbar, and then click **Help**.

## Playing DVDs

The computer must have a DVD drive to play DVD movies. Some computer models include a DVD drive that can also play Blu-ray DVDs (BD) and High-Definition DVDs (HD DVD).

To play a DVD, you must have a DVD drive:

- 1 Insert the DVD into the DVD drive.
- 2 When the DVD dialog window opens, choose the program you want to use from the list. You may have to scroll down in the window to see all available programs.

Or



If the dialog window does not appear, click the **Windows Start Button**  on the taskbar, click **All Programs**, and then click **HP DVD Play** or **DVD Play BD/HD**, or **Power Cinema** depending on the type of DVD drive and computer model that you have.
- 3 Use the controls in the DVD program to play the DVD.
- 4 To reduce the DVD Play window, double-click anywhere in the window. To return the display to full-size, double-click anywhere in the window again.

## Using Windows Media Center to play DVDs

- 1 Click the **Windows Start Button**  on the taskbar.
- 2 Click **Windows Media Center** to open Windows Media Center.
- 3 Scroll to **TV+ Movies**, and then click **HP DVD Play**.
- 4 Use the mouse to operate the media controls to control the movie.
- 5 To play the DVD in full-screen mode, double-click anywhere in the DVD Play window.

## Troubleshooting poor playback when playing DVDs

If you experience poor playback, such as skipping, when playing DVDs with DVD Play or Power Cinema, try the following solutions in the order listed:

- 1 If the computer includes Windows Media Center, try playing the DVD from within Windows Media Center. Windows Media Center automatically adjusts the display for the best screen resolution to allow optimal DVD playback.
  - a Click the **Windows Start Button**  on the taskbar, click **All Programs**, and then click **Windows Media Center**.
  - b Scroll up to the TV + Movies menu, and then select **HP DVD Play**.
  - c Use the DVD controls to play the movie.
- 2 Change the resolution of the display until the issue is resolved.
  - a Click the **Windows Start Button**  on the taskbar, click **Control Panel**, and then, under Appearance and Personalization, click **Adjust screen resolution**.
  - b Move the Resolution slider to a slightly lower resolution, and then click **Apply**.
  - c Click **Yes**.
  - d Try playing the DVD again. If the playback is still poor, repeat steps **a** to **d** until a better display resolution is found.
- 3 Try reducing the size of the playback window.

---

**NOTE:** Having a higher-end computer graphics (video) card and increasing computer memory may also improve DVD playback.

---

## Using country/region codes

Most DVD discs have country/region codes embedded in the disc data that limit where the DVD movie can be played.

The country/region number is usually placed over a world globe that is printed on the DVD packaging and disc. DVDs without country/region codes play on any player or drive in any country/region.



**WARNING:** You can change countries/regions only five times before the country/region code locks and becomes permanent. Once the code locks, you can play DVDs from that country/region only. If the country/region code locks and you need help, contact Support.

---

## Playing DVD Movies in Windows Media Center

### (Select models only)

Watching DVDs in Windows Media Center allows you to control the playback with the remote control. If you play the DVD in another program outside of Windows Media Center, you will not be able to use the remote control.

- 1 Click the **Windows Start Button**  on the taskbar, and then click **Windows Media Center**.
- 2 Insert the DVD into the drive. If you have other media playing, Windows Media Center asks if you want to play the DVD. Select **HP DVD Play**. If you don't select an option, the DVD automatically plays in full-screen mode after a few seconds.

---

**NOTE:** To view more information about a DVD that you are watching, such as the DVD title, chapter title, genre, parental rating, length, and current position, press the *i* (More information) button on the remote control.

---

Or

If the DVD is already in the drive, select **HP DVD Play**. The DVD movie begins playing in full-screen mode.

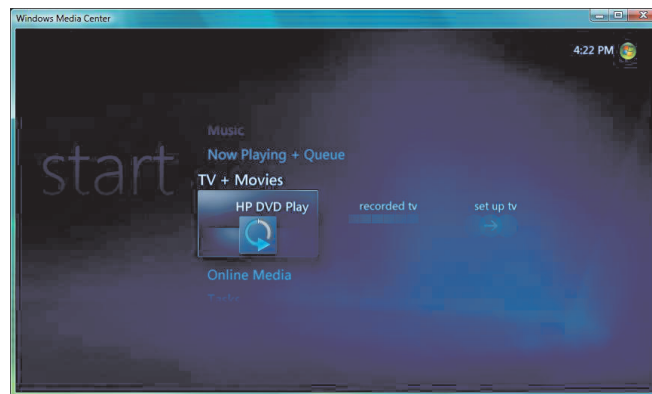

- 3 If a DVD menu appears, use the remote control or the mouse to select the DVD menu items and control the DVD movie playback.
- 4 To stop playing the DVD, press Stop on the remote control or move the mouse to display the media controls, and then click the **Stop** button.
- 5 Move the mouse for other icons to appear.

---

**NOTE:** To view additional controls, click the right mouse button. A window pops up, displaying additional options such as: *zoom*, *movie details*, *title menu*, *eject*, and *settings*.

---

## Changing the DVD Settings

You can change the DVD settings such as the DVD language, closed captioning, and remote control options.

Click the **Windows Start Button**  on the taskbar, and then click **Windows Media Center**.

- 1 From the Tasks menu, click **settings**.
- 2 In the Settings window, select **DVD**.
- 3 Click **DVD Language**, **Closed Captioning**, or **Remote Control Options**.
- 4 Select the settings, and then click **Save**.

## Changing the DVD movie language

To select DVD language settings for subtitles, audio track and menu:

- 1 Click the **Windows Start Button**  on the taskbar, and then click **Windows Media Center**.
- 2 From the Tasks menu, click **settings**, **DVD**, and then **DVD Language**.
- 3 Use the arrow buttons on the remote control or the arrow keys on the keyboard to select (+) or (-). Press OK on the remote control, or press the Enter key on the keyboard, to scroll through the languages available.



- 4 When you find the language you want, click **Save**.

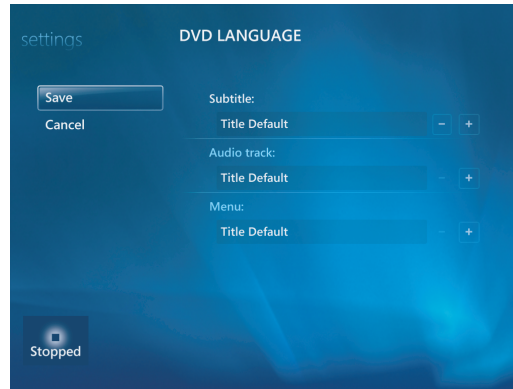

- 5 To return to the main settings window, press the Backspace key on the keyboard or press the Back button on the remote control, or click the left arrow on the top left of the screen.



## Changing DVD remote control options

To change the DVD remote control options:

- 1 Click the **Windows Start Button**  on the taskbar, and then click **Windows Media Center**.
- 2 From the Tasks menu, click **settings**.
- 3 In the settings window, click **DVD**.
- 4 In the DVD Settings window, click **Remote Control Options**.

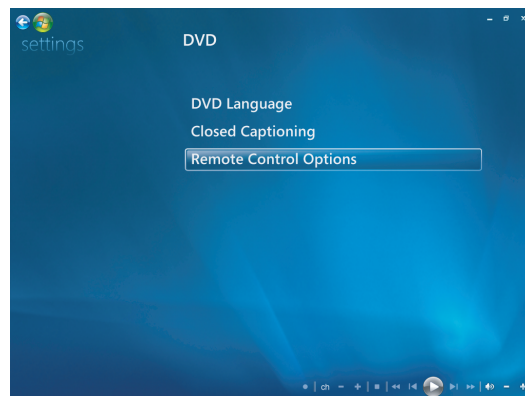

- 5 After making the changes, click **Save**.

## Changing DVD closed captioning

You can change the DVD closed captioning options:

- 1 Click the **Windows Start Button**  on the taskbar, and then click **Windows Media Center**.
- 2 From the Tasks menu, click **settings**.
- 3 In the settings window, click **DVD**.
- 4 In the DVD Settings window, click **Closed Captioning**.

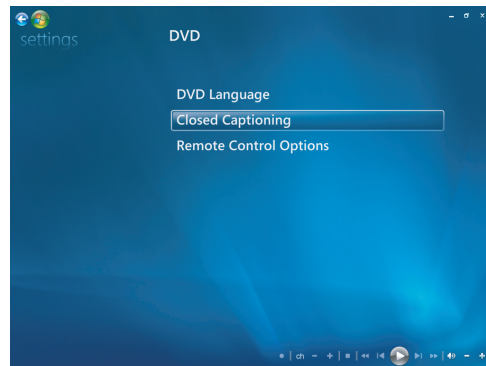

- 5 After making the changes, click **Save**.

## Changing DVD Audio Settings

To select DVD audio settings for viewing the DVD:

- 1 Click the **Windows Start Button**  on the taskbar, and then click **Windows Media Center**.
- 2 From the Tasks menu, click **settings**.
- 3 Click **TV**.
- 4 Click **Audio**. The TV Audio window opens.

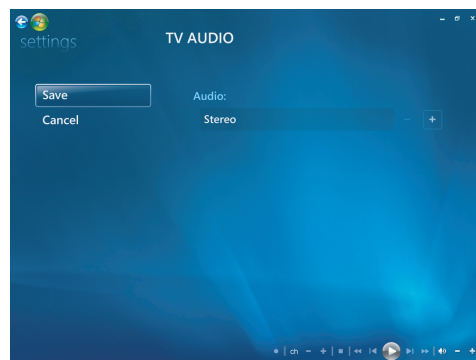

- 5 Select the speaker and sound options. Select the speaker output and the channel mode, if applicable. Click **Save**.

# Playing DVDs with Windows Media Player

The computer must have a DVD drive to play DVD movies.

- 1 Insert the DVD movie into the drive.
  - When the AutoPlay window opens, select **Windows Media Player** from the list. You may have to scroll down in the window to see Windows Media Player.

Or

  - If the Windows Media Player window does not automatically open, click the **Windows Start Button**  on the taskbar, click **All Programs**, and then click **Windows Media Player**.
- 2 To play the DVD, click the **Now Playing** tab on the Player taskbar, and then click the **Play** button. You can also control playback by using the media control buttons on the keyboard (select models only).

For more information on using Windows Media Player, click the drop-down arrow on the Player taskbar, and then click **Help**.
- 3 In the List pane, click a DVD title or chapter name. You can double-click a chapter to begin playing the movie at that point. You can also right-click a chapter and click **Find DVD Info** to find online information about the movie.

## Using DVD Play to Play DVDs, Videos, High-Definition DVDs, and Blu-ray DVDs

Depending on the type of DVD drive that is included with the computer, you can play DVDs, HD DVDs, or Blu-ray discs. The front of the drive is labeled with the type of discs that the DVD drive can play. Some drives can play both Blu-ray and HD DVDs. This means a better movie viewing experience, greater picture quality, and more bonus content.

Keep the following in mind when playing Blu-ray and HD DVDs:

- The DVD Play BD/HD DVD player software is capable of playing standard DVD movie discs; however, the enhanced features are available only with Blu-ray and HD DVD discs.
- HD DVD and Blu-ray movies play only through the DVD Play BD/HD DVD software.
- CPU power is dedicated to support HD DVD and Blu-ray playback functions. It is recommended that you close all other applications before and during HD DVD and Blu-ray playback.
- AACS keys are integrated into the computer for copy protection purposes. Occasional renewal of the AACS key is required, and easily done by connecting to the Internet.

- Some HD DVD and Blu-ray advanced features may not be supported.
- As HD DVD and Blu-ray are new formats containing new technologies, certain disc, digital connection, compatibility, and/or performance issues may arise, and do not constitute defects in the product. Flawless playback on all systems is not guaranteed.
- For some HD-DVD and Blu-ray titles to play, they may require a DVI or HDMI digital connection, and the display may require HDCP support.

To play a DVD, you must have a DVD drive:

- 1 Insert the DVD into the DVD drive.

The default DVD program opens. If the DVD wizard window opens, choose the program that you want to use from the list. You may have to scroll down the window to see all available programs.

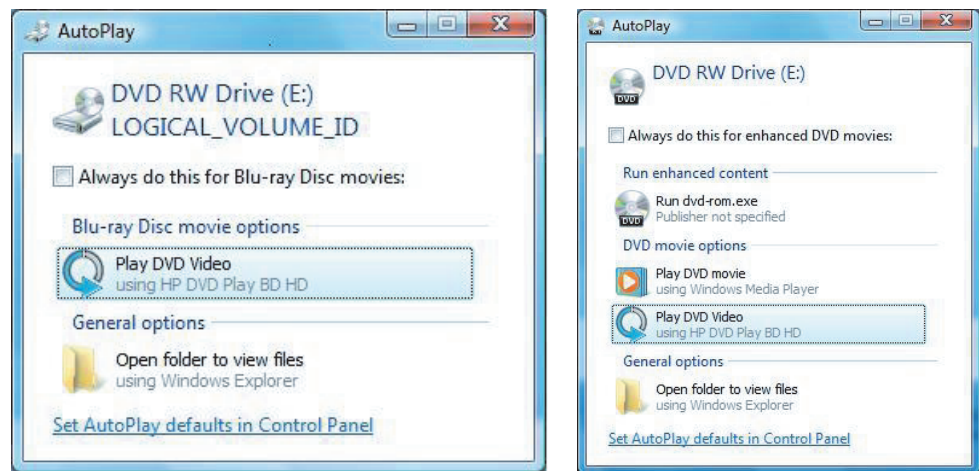

- 2 Use the controls in the DVD program to play the DVD.

---

**NOTE:** To use the DVD Play controls, you must use the mouse.

---

**NOTE:** The Advanced Access Content System (AACS) key that DVD Play uses must be updated every seventeen months in order for it to play DVD titles. For more information about playing video clips, click the ? (Help) button in the DVD Play control bar.

---

# Playing Video CDs (VCDs)

To play a VCD you must have either a CD or DVD drive:

- 1 Insert the VCD into the CD or DVD drive.

The default video CD program opens. If the Video CD wizard window opens, choose the program you want to use from the list. You may have to scroll down in the window to see all available programs.

- 2 Use the controls in the VCD program to play the VCD.

## Playing video CDs (VCDs) with Windows Media Player

To play VCDs with Windows Media Player you must have either a CD or DVD drive:

- 1 Insert the (VCD) into the DVD or CD drive.
- 2 Select **Play using Windows Media Player**, and then click **OK**.

Or

If the program doesn't open, click the **Windows Start Button** , click **All Programs**, and then click **Windows Media Player**.

- 3 To play the VCD, click the **Now Playing** tab on the Player taskbar, and then click **Play VCD**. You can also control playback by using the media control buttons on the keyboard (select models only).

For more information on using Windows Media Player, click the drop-down arrow on the Windows Media Player taskbar and then click **Help**.

- 4 In the List pane, double-click a VCD chapter to start playing the VCD at that point.



# Using Windows Media Center

Microsoft Windows Media Center lets you do amazing things with your computer. With a full range of easy-to-use digital entertainment features, you can experience movies, music, and photos like never before.

Windows Media Center is simple and convenient to use. You can easily find and choose your media. You can play movies, listen to music, and view photos with a single remote control (select models only). Combine the powerful features of your computer with a home theater receiver to enjoy an even more dynamic entertainment experience.

Windows Media Center is optimized for widescreen and high-definition displays. With the new onscreen layout of your photos, music, and videos, you can now see up to three times more content on a widescreen display than with previous versions of Windows Media Center.



# Setting Up Windows Media Center

The first time that you start Windows Media Center on the computer, a Windows Media Center setup wizard opens. You must complete each step in the setup wizard to be able to use all the features in Windows Media Center. The Windows Media Center setup wizard may take several minutes to complete. If there are steps that you still need to complete, you can go to the Settings menu to do so. See “Completing the setup wizard.”



---

**NOTE:** For more information about setting up the computer, refer to the setup instructions that came with the computer.

---

## Completing the setup wizard

If you did not complete the Windows Media Center setup wizard steps the first time through, you can complete or change your selections by using the following procedure. You need to complete all of the required setup steps to access all of the Windows Media Center features.

- 1 Press the Windows Media Center Start button  on the remote control, or, with the mouse, click the **Windows Start Button**  on the taskbar, and then click **Windows Media Center**.
- 2 Scroll up or down to the Tasks menu, and then select **settings**. Use the arrow keys on the keyboard or on the remote control to scroll right and left to see all of the Tasks menu items.
- 3 Select **General, Windows Media Center Setup**, and then **Run Setup Again**. Follow the onscreen instructions to complete the wizard.

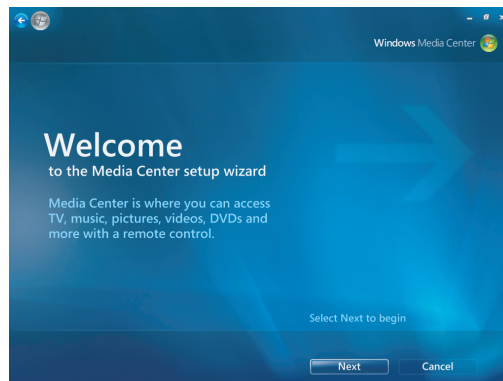

---

**NOTE:** You can change the Windows Media Center settings in the Settings menu.

---



The following are some of the items that are included in the setup wizard:

- **Check for your Internet connection.** An Internet connection allows you to access media links, display information about your music CDs and DVDs, and download the Television Program Guide if your computer came with a TV tuner.

---

**NOTE:** You must subscribe to an Internet Service Provider to have an Internet connection.

---

- **Optimize how Windows Media Center looks on your display.** You can:
  - Change display settings such as brightness, contrast, color, and centering.
  - Test and adjust the display settings of the monitor, TV, or other display.
  - Use the Windows Media Center video to help you change onscreen centering, sizing, aspect ratio (shape), brightness, contrast, color, and sharpness of the display with either the TV remote control or the monitor controls.
- **Set up your speakers.** Select how many speakers you have, and test them. Speakers are sold separately for some models.
- **Set up your Music, Picture, and Video Libraries.** Set up Windows Media Center to scan your Music, Picture, and Video folders for new media files. Windows Media Center can then automatically add these files to your media libraries. You can have Windows Media Center scan other folders or stop scanning a folder.

# Windows Media Center Start Menu

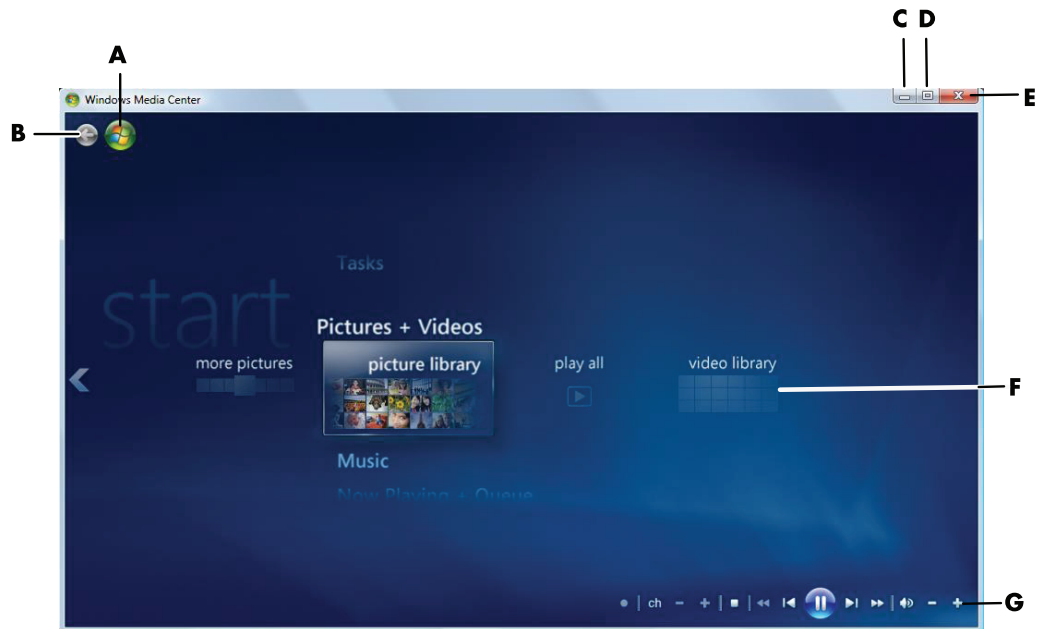

- A** Open the Windows Media Center Start menu.
- B** Go back one screen.
- C** Minimize the Windows Media Center window.
- D** Resize the Windows Media Center window.
- E** Close the Windows Media Center window.
- F** Use arrow keys to scroll up and down, left and right through the submenu items.
- G** Use media playback controls: Play, Stop, Pause, Skip, Fast-forward, Replay, Rewind, Record, Volume Up/Down, Mute, and Channel Up/Down.

## Windows Media Center Start menu items

- **HD DVD Play or Play DVD** — See "Playing DVD Movies in Windows Media Center."
- **Online Media** — Get access to various photo, video, radio, TV, and various media providers.
- **Pictures + Videos** — View digital pictures, play a slide show, or print photos. Watch home videos. See "Playing video CDs (VCDs) with Windows Media Player."

- **Music** — Play music files or music CDs, create and edit playlists, and record music files to CD. See “Using Music with Windows Media Center” and “Copying Music Files to CD in Windows Media Center.” Listen to internet radio station. See “Listening to Online Radio Stations.”
- **Tasks** — Change program settings. See “Changing Windows Media Center Settings.” Add a Windows Media Center Extender device. Synchronize content from another device with the computer. Burn CDs and DVDs. See “Copying Music Files to CD in Windows Media Center.” Find utilities and programs.
  - **Shutdown** — Get access to the Shutdown, Restart, Sleep, Close, Log Off, and Media Only menus. Media Only mode gives you access to Windows Media Center, but not to the rest of the computer. See “Windows Media Center control menu.”

---

**NOTE:** Some of the features and programs that are listed are for select models only.

---

## Windows Media Center Features

You can control the Windows Media Center functions and navigate Windows Media Center windows by using the remote control (select models only), keyboard, or mouse. You can easily switch back and forth between them by either moving the mouse, or by pressing a button on the remote control or the keyboard.

---

**NOTE:** Some of the Windows Media Center features listed are for select models only. Some of the components listed in the computer documentation, such as speakers and TV tuners, are optional or sold separately.

---

You can run Windows Media Center side-by-side with other Windows software programs. It is possible to browse through your pictures, watch videos, and play music while using other Windows programs.

With Windows Media Center, you can:

- Play back your digital videos.
- View your digital pictures or play them as a slide show with music.
- Easily print your photos.
- Browse, select, and play music CD files with full-screen visualizations.
- Record CD tracks to your media library.
- Play DVD movies. Resume playing your DVDs where you left off.

---

**NOTE:** If your computer came with a rewritable DVD drive, the drive is able to read and record to DVD+/-R/-RW media.

---

- Listen to Internet radio stations.
- Access streaming music and video subscription services. Some music and video subscription services may not be available in all countries/regions.

- Open specific windows in Windows Media Center by using the shortcut buttons on the remote control.
- Easily back up your media files to CD, DVD, or another hard disk drive, such as the HP Personal Media Drive and HP Pocket Media Drive (sold separately).
- Use the Optimization setting to keep the computer running smoothly.
- Use Sleep mode to save power when the computer is not in use. Then, you can display the computer desktop instantly by touching a keyboard key or a remote control button.

## The right music for the moment

In the Music section, you can quickly browse the entire music library by artist, song, or album title, as well as by genre, composer, or year. Windows Media Center automatically downloads thumbnails of album art, giving you a very visual way to find the albums that you want to hear. You can shuffle and repeat your music, create playlists, apply visualizations, and burn playlists to CD or DVD with the push of a button.

You can also start a picture slide show directly from your music library when you are selecting or playing your music. If you subscribe to music services, you can now add this option directly to the Start menu, next to the Music Library.

It is easy to search for and add music to your library from another Windows-based computer in your home.

## Playing Internet radio

Windows Media Center can also play Internet radio. You can access various Internet radio Web sites.

## Sharing your digital memories

With Windows Media Center, you can turn your simple photo collection into a cinematic slide show that can be shared on the computer or the television in the living room. The Play All option on the Start menu enables a full slide show of photos at the click of a button, and you can even enjoy the slide show with music from your music collection for a truly memorable experience.

If you want to create a slide show with a soundtrack, you can easily create a playlist of photos and music to burn to DVD.

In the Picture Library, you can navigate easily through your photos by folder or by the date on which they were taken, with thumbnails and highlighting that help you quickly identify the specific images or folders that you want to see. You can also perform basic editing functions, such as rotating or touching up pictures, either from within the Picture Library or during a slide show.

## Transforming your living space into a theater

In the Videos Library, you can easily play any of the home movies that have been imported from your video recorder. Windows Media Center has built-in support for high-definition video.

Whether you are watching a DVD movie or your own home videos, Windows Media Center delivers a rich viewing experience with a high-quality digital sound system. Sit back, and enjoy the show.

## Online media

Online Media is a link to various media providers, where you can find various media offers and services. The Online Media window is periodically updated by Microsoft. Some of the services that are listed may not be available in certain countries/regions.





Your computer must be connected to the Internet to access the Online Media Web sites.

# Navigating Windows Media Center

## Opening Windows Media Center with a mouse

You can use either the remote control or the mouse to open and navigate Windows Media Center.



To use the mouse:

- 1 Click the **Windows Start Button**  on the taskbar, and then click **Windows Media Center** .
- 2 Move the mouse over the Windows Media Center Start menu items, and click a category to select it. To scroll the list of Start menu items, move the mouse pointer over the list until an item is selected, then continue moving the pointer up or down the list to see the items that are not displayed.
- 3 After you select a menu category, scroll the mouse left or right, and then click an item to open that window.
- 4 Move the mouse to display the Windows Media Center menu bar, and then click the back arrow at the top of the window to go to a previous window. 
- 5 Click the **Windows Media Center Start**  icon at the top of the Windows Media Center window to return to the Windows Media Center Start menu.

## Opening Windows Media Center with the Windows Media Center remote control

You can use either the remote control or the mouse to open and navigate Windows Media Center.

To use the remote control:

- 1 Press the Windows Media Center Start button  on the remote control.
- 2 Use the arrow buttons on the remote control to select a Windows Media Center menu.
- 3 Press the OK button to enter your selection and open that window. To scroll the list of Start menu items, use the arrow buttons until the item is highlighted, and then continue moving the arrow buttons down the list to see the items that are not displayed.
- 4 Press the Back button on the remote control to go to a previous window.
- 5 Press the Windows Media Center Start button  on the remote control to return to the Windows Media Center Start menu.

## Using the Windows Media Center menu bars

When you move the mouse, the Windows Media Center menu bars appear. These menu bars allow you to access:

- Media controls (play, fast-forward, rewind, stop, and others).
- The back arrow.
- Window-control icons (minimize, maximize, and close).
- The Windows Media Center icon that takes you to the main Windows Media Center menu.



If you use the remote control, or if you stop using the mouse (after 5 seconds), the Windows Media Center menu bars become hidden.

---

**NOTE:** You can use the resize buttons to switch to the desktop or to run Windows Media Center side-by-side with another program.

---

## Selecting items in Windows Media Center

You can control the Windows Media Center functions and navigate Windows Media Center windows by using the remote control, the keyboard, or a mouse.

In the Windows Media Center windows, a selected item such as a folder, file, or menu item is either highlighted or moves to a zoomed-out position.



To select items in Windows Media Center, use the mouse, the arrow keys on the keyboard or the arrow buttons on the remote control, and then press the Enter key on the keyboard or the OK button on the remote control to enter your selection.

If you have media playing, such as music or a slide show, it appears in an inset window in the lower-left corner. To switch from watching media in the inset window to watching it in full-screen mode, use the arrow buttons on the remote control or the arrow keys on the keyboard to select it, and then press the OK button on the remote control or the Enter key on the keyboard.

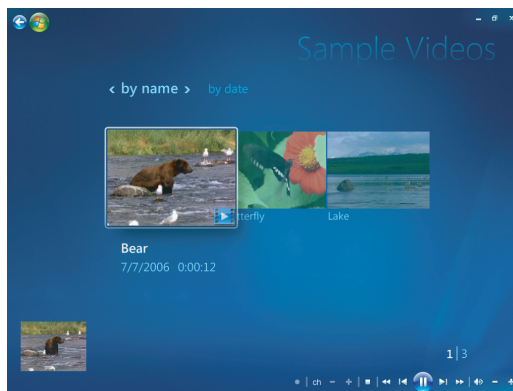

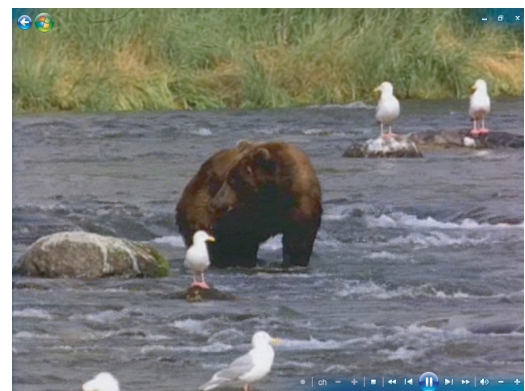

**Inset window**









**Full-screen mode**

## Windows Media Center control menu

To access the control menu in Windows Media Center, move the mouse to display the menu bars:



- 1 Click the **Windows Start Button**  on the taskbar, and then click **Windows Media Center**.
- 2 From the Tasks menu, click **shutdown** to open the window with the menu items that are listed in the following table. Use the arrow keys on the remote control or the keyboard to scroll to the right or left of the screen to select the other options. 

| Icon  | Action  |
|---|---|
|    | Closes Windows Media Center.  |
|    | Logs off and ends your Windows Media Center session and switches users.   |
|    | Shuts down the computer.  |
|   | Restarts the computer.  |
|  | Puts the computer in a power-reduced or Sleep mode.   |
|  | Puts the computer in Media Only mode, which gives you access to Windows Media Center, but not to the rest of the computer.<br><b>NOTE:</b> This option is listed in the Tasks menu. |

## Changing Windows Media Center Settings

In the Windows Media Center settings window, you can change settings for viewing your pictures and slide shows, and for controlling sound and the display of all of the Windows Media Center windows.

To change your Windows Media Center settings:

- 1 Press the Windows Media Center Start button , or, with the mouse, click the **Windows Start Button**  on the taskbar, and then click **Windows Media Center**.
- 2 From the Tasks menu, select **settings**.



- 3 Select a settings category.
- 4 Select one of the settings listed. Then, use the arrow keys on the keyboard or the arrow buttons on the remote control to select an option, or follow the onscreen instructions.
- 5 Select **Save** to save your changes.

## Windows Media Center Settings categories

### ■ General

- **Startup and Window behavior.**
- **Visual and Sound Effects** to set transition animations, sounds, and background colors when navigating in Windows Media Center.
- **Program Library Options** to allow programs in the Program Library to control the media experience and access media information in Windows Media Center. Also, you can hide Internet security warnings.
- **Windows Media Center Setup** to configure an Internet connection and speakers, run Windows Media Center setup again, and configure the TV display or monitor.
- **Parental Controls** to block unwanted TV channels and movie ratings, change access code, and reset parental controls.

---

**NOTE:** The parental controls, captions display, radio, and TV settings listed in Windows Media Center do not apply to computer models that do not include a TV tuner.

---

- **Automatic Downloads Options** to get media information about CDs, DVDs, and movies from the Internet.
- **Optimization** to keep the computer running smoothly by performing various tasks on a regularly scheduled basis. The Optimization setting closes and then opens Windows Media Center at a specific time each day that you determine.
- **TV** to set up TV signal, audio, and closed captioning (not all channels support closed captioning). You can download or edit the Television Program Guide, set hard disk drive recorder storage space, configure the display, and set recording defaults.
- **Pictures** to set slide show settings.
- **Music** to select visualizations or song information to display when playing a song.
- **DVD** to select a language for subtitles, audio tracks, and menus of your DVDs; program the Skip and Replay buttons on the remote control for your DVDs; and select closed captioning.
- **Library Setup** to have Windows Media Center scan specified computer folders for media files.
- **Radio** to organize or delete preset radio stations.

To view information for your computer, go to the Support Web address that is listed in the *Limited Warranty and Support Guide*, and search for your model's name and number. The product model is on the lower front of the computer.

To find the online documentation for your product, search for your model number, and then click **Manuals**.

---

**NOTE:** Information and guides are associated with specific computer model numbers. Some models do not have guides or manuals available on the Web site.

---

## Using Windows Media Center power settings

When the computer is in Sleep mode, it appears off, but you can actually still perform tasks such as recording TV programs or music files. Sleep mode turns off the display and mutes the audio.

---

**NOTE:** The audio or video of TV recordings is not affected when the computer is in Sleep mode.

---

You can activate Sleep mode by pressing the Sleep button on the computer, keyboard, or remote control.



You can return to the desktop almost instantly by pressing any Sleep button again, by pressing any key on the keyboard, by moving the mouse, or by pressing any button on the remote control.

To change the computer power settings:

- 1 Click the **Windows Start Button**  on the taskbar, and then click **Control Panel**.
- 2 Click **System and Maintenance**.
- 3 Click **Power Options**.
- 4 Select the **Balanced**, **Power saver**, or **High performance** option.
- 5 Click **Change plan settings**.
- 6 Click the drop-down arrow next to *turn off the display* to select a time span to turn off the display.
- 7 Click the drop-down arrow next to *put the computer to sleep* to select a time span for putting the computer into Sleep mode.
- 8 Click **Save changes**.

# Creating Audio and Data Discs

This chapter contains the procedures that you must perform to record (or *burn*) files to recordable CD and DVD discs. It also includes information about labeling the discs by using the LightScribe labeling technology that is available on select models or by creating a paper label.

The computer includes one or more CD, DVD, or combination optical drives that are capable of recording. Additionally, the computer may include the following software programs for recording to CDs or DVDs:

- CyberLink Power2Go (select models only)
- CyberLink PowerDirector (select models only)
- CyberLink LabelPrint (select models only)
- Windows Vista
- Windows Media Center

These programs include features that enable you to copy, archive, and manage music, video, image, and data files, and then record the files to CDs or DVDs. You can also use Windows Media Player to download and copy music files to a portable device or memory card.

---

**IMPORTANT:** HP supports the lawful use of technology and does not endorse or encourage the use of our products for purposes other than those permitted by copyright law.

---

---

**NOTE:** *Burn* is an industry term used to describe the recording of information onto a DVD or CD. Optical recording uses a laser beam to place information onto the disc, thus the term *burning*.

---

# Erasing Rewritable Discs Before Recording

Previously recorded files on rewritable discs (CD-RW, DVD-RW, or DVD+RW) must be erased before recording new files. CD-R, DVD-R, and DVD+R discs cannot be erased.

To erase a rewritable disc in CyberLink Power2Go:

- 1 Click the **Windows Start Button**  on the taskbar, **All Programs**, and then click **CyberLink DVD Suite**.
- 2 Click the icon in the lower-right corner of the window to open a list of CyberLink programs, and then click **Power2Go**.
- 3 Click the **Disc Utilities** icon in the Select a Burning Task window, click **Erase Disc**, and then click **OK**.
- 4 Insert the rewritable disc that you want to erase.
- 5 Click the **Quick erase** or **Full erase** option, and then click the **Erase** button.
- 6 Click **OK** when the disc has been erased.

## Working with Audio CDs

You can create audio CDs that play in the car or home CD player, and on computers. You can create two main types of music CDs:

- **Uncompressed** — Typical CD format, like you would purchase on a commercial CD. This type of CD holds 10 to 20 songs, depending on their length.

Uncompressed files can be burned on CD-Rs (which play in most home and car stereos, DVD players, and computers) or CD-RWs (which play only in some stereos, DVD players, and computers).

The procedure for creating this type of CD is described in “Creating audio CDs.”

- **Compressed** — Files are burned to a disc using a compressed file format (.mp3, wma, or .m4a). The smaller file format enables you to fit approximately ten times as many songs onto the disc (depending on length and format).

Compressed files can be burned to CD-Rs, CD-RWs, DVDs, DVD-RWs, or DVD+RWs (select models only). Compressed files can only be played on computers, CD players, or DVD players that support the *file format* that you use to create the disc (.mp3 is most commonly supported). For file format compatibility, check the documentation for the device in which you intend to play the disc. You may hear a slight loss of sound quality using compressed audio files.

For more compatibility information, see “Disc Features and Compatibility Table.”

CyberLink Power2Go allows you to create *closed-session* or *multisession* CDs and DVDs. For closed-session CDs and DVDs, you must record or copy all files on one disc in one recording session. For multisession CDs and DVDs, you can record or copy files in several sessions until the disc is filled or until you close the session.

---

**NOTE:** Music files can be recorded repeatedly on a rewritable CD-RW disc, but all previously recorded files must be erased first. CD-R discs cannot be erased.

---

---

**IMPORTANT:** HP supports the lawful use of technology and does not endorse or encourage the use of our products for purposes other than those permitted by copyright law.

---

## Audio CD tips

When recording music files, it is important to note that:

- As you add music files in the recording session, the software calculates and displays the amount of recording time that is available to record additional music files. If you try to record more than a standard CD can hold, a message opens warning you that all the tracks may not fit on the disc.
- If the recording fails, manually select a slower recording speed, if available, each time you make a recording. Refer to the Help menu in the selected software program for more information about selecting a slower recording speed.
- If you change the write speed of the recording, run a Write Simulation test to verify that the burner can burn to the disc at the selected speed without causing recording errors.
- You can select the “Enable buffer underrun protection” option when burning a disc to ensure that data is written to disc without interruption. An interruption in data can result in an unusable disc.
- You can select the “Verify recorded data” option to compare recorded data to the source data to ensure accurate burning.

---

**IMPORTANT:** HP supports the lawful use of technology and does not endorse or encourage the use of our products for purposes other than those permitted by copyright law.

---



## Before you begin creating discs

- Save all work, and close all open programs.
- Turn off the screen saver.

## Creating audio CDs

This section provides instructions for burning an audio CD that can be played in most home and car CD players.

To create an audio CD:

- 1 Insert a writable CD into the disc-burning drive.  
CD-R discs play in most home and car stereos, DVD players, and computers. CD-RW discs play only in some stereos, DVD players, and computers.
- 2 Click the **Windows Start Button**  on the taskbar, **All Programs**, and then click **CyberLink DVD Suite**.
- 3 Click the icon in the lower-right corner of the window to open a list of CyberLink programs, and then click **Power2Go**.
- 4 Select the **Music Disc** icon.
- 5 Select the disc type, **CD** or **DVD**, select the content type, and then click **OK**.
- 6 Locate the music files that you want to add, and then click them and drag them to the bottom half of the Power2Go window.
- 7 When you are done adding files, click the **Burn** icon in the toolbar. 

---

**NOTE:** For more help using CyberLink Power2Go, click the **Help** icon in the program. 

---

- 8 Select the recording options. See "Audio CD tips."
- 9 Click **Burn** to begin recording your music files to disc.
- 10 Click **OK** when the audio CD is completed.

## Creating video discs

This section provides instructions for creating a video disc. You can create a video disc from files on the computer hard disk drive or directly from a digital video camera.

- 1 Insert a writable disc into the disc-burning drive.
- 2 Open the CyberLink PowerDirector program by clicking the **Windows Start Button** , **All Programs**, and then clicking **CyberLink DVD Suite**.
- 3 Click the icon in the lower-right corner of the window to open a list of CyberLink programs, and then click **PowerDirector**.
- 4 Click the **File** menu, select **Import**, and then click **Media Files**. Browse to your file and click **Open** to import it into your video project.

Or

Click the **Capture** button:

- a Select a capture device, such as **DV Camera**, **TV**, **PC Camera**, **CD**, or **DVD** from the toolbar.
  - b Click the **Play** button to playback your video.
  - c Click the **Record** button when you find the place in your file you want to add to your video project and then click the **Stop** button to end the recording.
  - d When the Capture File Name window opens, type in a name for your captured video file, and then click **OK**. Your captured video is added to your video project.
- 5 After you have imported or captured all of your video files, click the **Edit** button. Use the editing tools on the left side of the window to edit your video file.
  - 6 Click the **Produce** button. Select your settings and then click the arrow button to continue. Click the check mark button to begin rendering your video.
  - 7 Select a file type, such as **video file** or **streaming file**, and then click the arrow button to continue.
  - 8 Select your settings and then click the arrow icon to continue.
  - 9 Click the check mark icon to begin rendering your video.
  - 10 Click the **Create Disc** button. You can add a style or menu buttons to your video.
  - 11 Click the **Burn Disc** icon, and then select your recording options. 
  - 12 When ready to create the video disc, click **OK**.
  - 13 When the recording is complete, click **OK**.

---

**NOTE:** For more help using CyberLink PowerDirector, click the **Help** menu, and then click **PowerDirector Help**.

---

## Copying a disc

The following section explains how to make a copy of an existing CD or DVD.

### Copying a disc using two disc drives

If you have two disc drives, you can copy a CD or DVD directly from one drive to the other. To copy a DVD by using this method, you must have two DVD drives. Otherwise, use the steps in the next section to copy the DVD.

To copy a CD or DVD using two disc drives:

- 1 Insert a writable CD or DVD into a disc-burning drive.
- 2 Insert the disc that you want to copy into the other disc drive.
- 3 Click the **Windows Start Button**  on the taskbar, **All Programs**, and then click **CyberLink DVD Suite**.
- 4 Click the icon in the lower-right corner of the window to open a list of CyberLink programs, and then click **Power2Go**.
- 5 Click the **Copy Disc** icon, and then click **OK**.
- 6 Ensure that the correct disc drives are selected.
- 7 Click the **Copy** button.

---

**NOTE:** For more help using CyberLink Power2Go, click the **Help** icon in the program.



### Copying a disc using one disc drive

If you have only one disc drive, CyberLink Power2Go stores an image file of the disc temporarily on the computer hard disk drive.

Use these steps to copy a CD or DVD using one disc drive:

- 1 Insert the disc that you want to copy into the disc-burning drive.

---

**NOTE:** If a CD-playing program opens automatically, close it before going to step 2.

---



- 2 Click the **Windows Start Button**  on the taskbar, **All Programs**, and then click **CyberLink DVD Suite**.
- 3 Click the icon in the lower-right corner of the window to open a list of CyberLink programs, and then click **Power2Go**.
- 4 Click the **Copy Disc** icon, and then click **OK**.
- 5 Select the burn options, and then click the **Copy** button.  
Power2Go creates an image file of the disc. This file is temporarily stored on the computer hard disk drive.
- 6 When you are prompted, insert a writable CD or DVD into the disc-burning drive, and then click **OK**.
- 7 When the message *Copy Disc: Completed successfully* appears, click **OK**. The disc is ejected automatically.



## Creating data discs

This section provides instructions for burning data files onto a disc.

To create a data disc:

- 1 Insert a writable disc into the disc-burning drive.
- 2 Click the **Windows Start Button**  on the taskbar, **All Programs**, and then click **CyberLink DVD Suite**.
- 3 Click the icon in the lower-right corner of the window to open a list of CyberLink programs, and then click **Power2Go**.
- 4 Click the **Data Disc** icon. 
- 5 Select disc type, and then click **OK**.
- 6 Locate files from the hard disk drive, and then click and drag them to the lower section of the window.
- 7 When you are done adding files, click the **Burn** icon in the toolbar. 

---

**NOTE:** For more help using CyberLink Power2Go, click the **Help** icon in the program. 

---

- 8 Select the recording options.
- 9 Click **Burn** to begin recording your music files to disc.
- 10 Click **OK** when the data disc is completed.

## Making a disc label using LightScribe Technology

### (Select models only)

The following section provides instructions for making a disc label by using LightScribe technology. For instructions on making a paper label, refer to "Making a paper disc label."

### What is LightScribe?

LightScribe is an innovative technology that uses a special disc drive, special media (CDs or DVDs), and label-making software to burn labels directly onto CDs and DVDs. A LightScribe-enabled CD or DVD disc drive uses the optical laser in the drive to burn a label onto a thin dye coating on the label side of the disc. There is no ink to smear or paper to curl, and there are no adhesives to loosen.

## LightScribe requirements

Burning a label with LightScribe requires three things:

- A LightScribe-enabled disc drive (select models only), identified by the LightScribe logo
- Labeling software that supports LightScribe
- A writable LightScribe disc (sold separately)





## Making a LightScribe label by using CyberLink LabelPrint

You may burn data, music, and videos to the disc before or after labeling the disc. See "Creating audio CDs" and "Creating data discs."

To make a LightScribe label:

- 1 Place the disc into the disc drive with the top of the disc facing down. The top is the gold non-reflective side of the disc, opposite of the side that you record data onto.
- 2 Close the drive.
- 3 Click the **Windows Start Button**  on the taskbar, **All Programs**, and then click **CyberLink DVD Suite**.
- 4 Click the icon in the lower-right corner of the window to open a list of CyberLink programs, and then click **LabelPrint**.
- 5 Under **Step 1: Select the type of label you want to print**, select one of following:
  - **Disc Label** (LightScribe label)

Or

  - **MiniDisc Label** (LightScribe label)
- 6 Click the arrow button at the bottom of the window to continue. 
- 7 Under **Step 2: Edit titles and other information**, design the disc label:
  - a Type in a disc title, author, and date.
  - b Type in song titles, artist/author and time/size of the files.
  - c You can click the **Import** icon to import MP3 information, if desired. 
- 8 Click the arrow button at the bottom of the window to continue. 

- 9 Under **Step 3: Select the label's layout and background:**
  - a Select a layout style by clicking the arrows under Layout Style to scroll through the different label layouts available, and then click the **Select** button when you find the one that you want.
  - b Select a background image by clicking the arrows under Background Image to scroll through the different background images that are available, and then click the **Select** button when you find the one that you want.
  - c If you are creating a paper label, select a paper size under Paper Template by using the drop-down arrow.
- 10 Click the arrow button at the bottom of the window to continue.
- 11 When you are ready to create the LightScribe label, click the **Print** icon.
- 12 Click **OK** to create the LightScribe label. The estimated time to complete the label displays, along with a progress bar. It is possible to continue to work on the computer while the LightScribe label is created.



For more help using CyberLink LabelPrint, click the **Help** icon to open the Help information.



## Making a paper disc label

The following section provides instructions for creating a paper label for the disc. To create a LightScribe label, refer to "Making a disc label using LightScribe Technology."

- 1 Load the printer with adhesive label paper. You can purchase label paper at most office-supply stores.
- 2 Click the **Windows Start Button**  on the taskbar, **All Programs**, and then click **CyberLink DVD Suite**.
- 3 Click the icon in the lower-right corner of the window to open a list of CyberLink programs, and then click **LabelPrint**.
- 4 Under **Step 1: Select the type of label you want to print**, select one of the following:
  - **Front Cover** (paper insert label)
  - **Back of Front Cover** (paper insert label)
  - **Disc Inlay** (paper insert label)
- 5 Click the arrow button at the bottom of the window to continue.
- 6 Under **Step 2: Edit titles and other information**, design the disc label:
  - a Type in a disc title, author, and date.
  - b Type in song titles, artist/author, and time/size of the files.
  - c Click the **Import** icon to import MP3 information.



7 Click the arrow button at the bottom of the window to continue.



8 Under **Step 3: Select the label's layout and background:**

- a Select a layout style by clicking the arrows under Layout Style to scroll through the different label layouts available, and then click the **Select** button when you find the one that you want.
- b Select a background image by clicking the arrows under Background Image to scroll through the different background images that are available, and then click the **Select** button when you find the one that you want.
- c If you are creating a paper label, select a paper size under Paper Template by using the drop-down arrow.

9 Click the arrow button at the bottom of the window to continue.

10 When you are ready to create the LightScribe label, click the **Print** icon.



For more help using CyberLink LabelPrint, click the **Help** icon to open the Help information.



# Working with Pictures and Videos

You can view, copy, edit, print, and share digital images and videos by using the computer.

You can transfer digital images and videos to the computer by using the following methods:

- CD or DVD: Insert the disc into the CD or DVD drive.
- Digital camera or digital video camera: Connect the device to the computer by using the transfer cable that came with the device. (Select models have a digital camera docking bay.)
- Memory card: Insert the memory card into the memory card reader (select models only).

Digital images that you copy or transfer to the computer may appear in the Pictures folder by default.

## Working with Digital Images

You can connect a digital image source, such as a digital photo or video camera, directly to the computer or through a docking station. Most digital picture files that you copy or download from the device appear in the Pictures folder.

---

**NOTE:** When transferring pictures from a digital photo camera to the computer, set the camera's USB setting to disk drive instead of digital camera.

---

Windows Vista detects the external device and opens a message, asking if you want to view the images.

You can copy digital picture files from the memory cards that are used by digital cameras and other digital imaging devices by using the memory card reader (select models only).

# Viewing Pictures in Windows Media Center

With Windows Media Center, you can view, sort, edit, print, and create a CD or DVD of the pictures from the folders that you create in the Pictures directory in Windows Explorer.

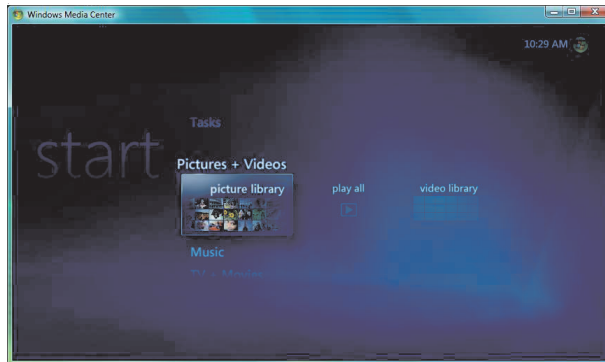

Pictures is a folder on the hard disk drive in the Documents window, and it is also a Windows Media Center menu item that enables you to view and search for the digital images by using the remote control or the keyboard and mouse.

The Pictures + Videos menu in Windows Media Center provides all the tools that you need for viewing, organizing, editing, printing, sharing, and protecting the digital images.



# Adding Pictures in Windows Media Center

## Adding picture files from the hard disk drive

- 1 Click the **Windows Start Button**  on the taskbar, and then click **Windows Media Center**.
- 2 Click **Pictures + Videos**.
- 3 Click **picture library**.
- 4 Press Ctrl+D on the keyboard or the *i* (More information) button on the remote control, and then click **Library Setup**. 
- 5 Click **Add folder to watch**, and then click **Next**.
- 6 Click **Add folders on this computer**, and then click **Next**.
- 7 Place a check mark next to the folders that you want Windows Media Center to check, and then click **Next**.
- 8 Click **Finish**.

# Viewing Pictures in Windows Media Center

After you organize your pictures in the Pictures folder in Windows Explorer, open Windows Media Center to view them:



- 1 Click the **Windows Start Button**  on the taskbar, and then click **Windows Media Center**.
- 2 Click **Pictures + Videos** and then click **picture library**.
- 3 Select a folder, **tags**, or **date taken**. The window shows a small picture image (thumbnail) of each photo.
  - Select **date taken** to view each photo with the date it was taken.
  - Select **folders** if you have organized your pictures into folders. Each folder icon displays a thumbnail of photos. The pictures are displayed just as you organized them in the Pictures folder in Windows Explorer.
- 4 Use the arrow keys on the keyboard to move through the picture files and folder files, and select a picture.
- 5 Press the Enter key on the keyboard to select a picture or folder to view. The selected picture opens in full-screen mode.
- 6 Press the Enter key on the keyboard again to zoom to 150 percent; press it again to zoom to 225 percent. Use the remote control arrow buttons to pan across a picture. Press Enter or OK a third time to return the picture to its original size.

---

**NOTE:** While viewing a picture, you can press the *i* (More information) button on the remote control or Ctrl+D on the keyboard, click **Picture Details**, click **Settings**, and then click **Pictures** to:

- Select a slide transition, a slide time delay, and a background color.
  - Include picture folders you have created.
  - Show captions.
  - Display pictures randomly.
  - Show song information during a slide show.
-

## Viewing pictures as a slide show

- 1 Click the **Windows Start Button**  on the taskbar, and then click **Windows Media Center**.
- 2 Click **Pictures + Videos**, and then click **picture library**.
- 3 Select the folder of pictures that you want to view as a slide show, and then press Enter on the keyboard.
- 4 Click **play slide show**, and then press Enter on the keyboard.
- 5 Press Ctrl+D on the keyboard or the *i* (More information) button on the remote control, and then click **Picture Details**. The picture name, location, and last modification date are displayed, if they are available. 
- 6 Press the Backspace key on the keyboard or the Back button on the remote control to go to a previous screen.
- 7 Use the arrow keys on the keyboard or the arrow buttons on the remote control to display the next or previous pictures.

If you do not select the pictures that you want to view as a slide show, Windows Media Center uses the first folder that is listed. If you have picture files that are not stored in folders that you created, Windows Media Center plays all of the files that are stored in the Pictures folder.

## Viewing a slide show with music

- 1 Click the **Windows Start Button**  on the taskbar, and then click **Windows Media Center**.
- 2 Click **Music**, and then click **music library**.
- 3 Select the music that you want, and then press Enter on the keyboard.

---

**NOTE:** If the music does not start automatically, move the mouse to display the media control menu bar, and then click the **Play** button, or press the Play button on the remote control.

---

- 4 Press the Backspace key on the keyboard until you are back at the Windows Media Center Start menu.
- 5 Click **Pictures + Videos**, and then click **picture library**.
- 6 Select the folder of pictures that you want to view as a slide show, and then press Enter on the keyboard.
- 7 Click **play slide show**, and then press the Enter key on the keyboard. When Windows Media Center switches to full-screen mode, the inset window disappears, but the music continues to play.



## Using supported picture file types in Windows Media Center

You can view the following types of image files in Windows Media Center.

| File extension     | File type                        |
|--------------------|----------------------------------|
| <b>.jpg, .jpeg</b> | Joint Photographic Experts Group |
| <b>.tif, .tiff</b> | Tagged Image File Format         |
| <b>.gif</b>        | Graphics Interchange Format      |
| <b>.bmp</b>        | Bitmap                           |
| <b>.wmf</b>        | Windows MetaFile                 |
| <b>.png</b>        | Portable Network Graphics        |

- Only supported image file types display in the Pictures + Videos area of Windows Media Center. Unsupported files are skipped in a slide show.

---



**NOTE:** If the message *Image cannot be displayed* appears, the file may be corrupted, or it may be an unsupported file type. You may need to edit the image with a photo editor and save it in a supported file format.

---

- Folder icons appear even if the images inside them cannot be displayed.
- Corrupted and unsupported image file types display a generic image icon, but they cannot be displayed.
- Some file types are supported only if appropriate filters and software are installed.

# Editing Pictures in Windows Media Center

## Fixing red eye or contrast

- 1 Click the **Windows Start Button**  on the taskbar, and then click **Windows Media Center**.
- 2 Click **Pictures + Videos**, and then click **picture library**.
- 3 Select a picture to edit.
- 4 Press the *i* (More information) button on the remote control or Ctrl+D on the keyboard, and then select **Picture Details**. 
- 5 Click **Touch Up**.

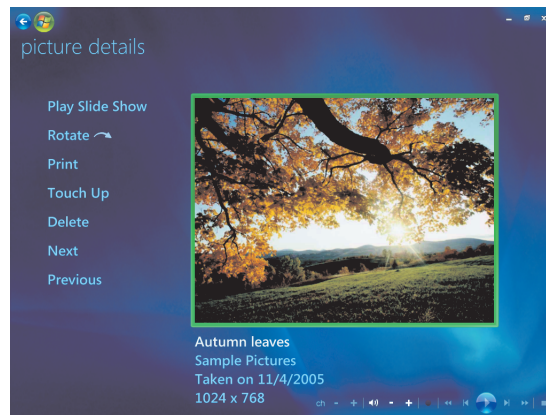

- 6 Click **Contrast** or **Red Eye**.
- 7 Click **Preview** to see the result.
- 8 After you select the options that you want to fix, click **Save**. The picture displays with the new settings.
- 9 Click **Yes** to save changes and replace the original picture file.

## Cropping pictures in Windows Media Center

- 1 Click the **Windows Start Button**  on the taskbar, and then click **Windows Media Center**.
- 2 Click **Pictures + Videos**, and then click **picture library**.
- 3 Select a picture to edit.

- 4 Press the *i* (More information) button on the remote control or Ctrl+D on the keyboard, and then select **Picture Details**.
- 5 Click **Touch Up**.
- 6 Click **Crop**.



- 7 Use the mouse and keyboard to do one or more of the following:
  - Select the arrows under the picture to move the picture side to side, or up or down.
  - Select the magnifying glass tools to move the cropping tool in or out.
  - Select the rotate tool to move the cropping tool to a vertical or horizontal position.
- 8 After you select the settings that you want to fix, click **Save**. Once you save the picture, you cannot revert to the original picture.
- 9 Click **Yes** to save changes and replace the original picture file.

## Rotating pictures

If the picture appears horizontally or vertically, and you want to change the orientation, you can change it in Windows Media Center:



- 1 Click the **Windows Start Button**  on the taskbar, and then click **Windows Media Center**.
- 2 Click **Pictures + Videos**.
- 3 Select the picture you want to rotate.
- 4 Press the *i* (More information) button on the remote control or Ctrl+D on the keyboard, and then select **Picture Details**.
- 5 Click **Rotate**. Rotation occurs clockwise in 90° increments.

# Printing Pictures in Windows Media Center

---

**NOTE:** You must set up the printer before you try to print from Windows Media Center; otherwise, by default, the file is saved to the Documents folder when you try to print the picture.

---

- 1 Click the **Windows Start Button**  on the taskbar, and then click **Windows Media Center**.
- 2 Click **Pictures + Videos**, and then click **picture library**.
- 3 Select the picture that you want to print.
- 4 Press Ctrl+D on the keyboard or the *i* (More information) button on the remote control, and then click **Picture Details**. Click **Print**, and then click **Print** again. 
- 5 Follow any onscreen instructions.

# Copying Pictures to CDs and DVDs in Windows Media Center

---

**NOTE:** In Windows Media Center, all pictures are copied to CDs as .jpg files.

---

- 1 Click the **Windows Start Button**  on the taskbar and then click **Windows Media Center**.
- 2 From the Tasks menu, click **burn cd/dvd**.
- 3 Insert writable media (CD-R, CD-RW, DVD+/-R, or DVD+/-RW) into the drive.
- 4 Click **Data CD/DVD**, and then click **Next**.

---

**NOTE:** If you are using a writable disc that contains data, you must select **Erase Disc** to continue.

---

- 5 Select the **Untitled** area, enter the name of the disc by using the numeric keys on the keyboard or the remote control, and then select **Next**. Use the Backspace key on the keyboard or the Clear button on the remote control to delete letters.
- 6 Click **Picture Library**, and then click **Next**.
- 7 Select the pictures that you want to copy, and then click **Next**. A check mark appears next to a picture when you select it.
- 8 Click **Add More** to add more pictures to the disc.
- 9 After you have selected all of your pictures, select **Burn CD**.
- 10 Click **Yes**. Windows Media Center opens a message if you need to insert an additional disc to complete the recording. Windows Media Center opens a message when the disc has been created.
- 11 Click **Done** when the disc has been created.

# Playing Videos in Windows Media Center

The Pictures + Videos area in Windows Media Center makes it easy to play home video files that you created or video files that you downloaded from the Internet.

In Pictures + Videos you can:

- Play videos that are stored anywhere on the hard disk drive.
- Create a CD or DVD of your video files.
- View your videos in full-screen mode or from an inset window in Windows Media Center.
- View small thumbnail images and the titles of your video files.

## Playing digital videos

After you organize the videos in the Videos folder or Shared Video folder in Windows Explorer, open Windows Media Center to watch them:

- 1 Click the **Windows Start Button**  on the taskbar, and then click **Windows Media Center**.
- 2 Click **Pictures + Videos**.
- 3 Click **video library**.
- 4 Select the video folder that you want. The video folder opens, displaying a list of video files. You may need to use the scroll arrows at the bottom of the window to display all videos.

---

**NOTE:** Use the mouse to select the up arrows and down arrows at the bottom of the window, to scroll to other pages of video files and folders.

---

- 5 Click the video file. The video plays in full-screen mode. Use the mouse to resize the window if you want to watch the video while doing something else on the desktop.
- 6 To exit full-screen mode and return to the previous window, press the Back button on the remote control or the Backspace key on the keyboard. The video continues to play in the inset window.
- 7 When the video is finished, click **Restart** to replay the video, or click **Done** to close the file and return to the Videos area.

---

**NOTE:** You can maximize the media that is playing in the inset window by using the arrow buttons to select the inset window and then pressing OK on the remote control or Enter on the keyboard, or you can just click the inset window.

---

## Using supported video file types

You can view the following types of video files in Windows Media Center. Other file types are supported if the computer has the correct software installed:

| File extension                              | File type  |
|---|--|
| <b>.avi</b>                                 | Windows Video file (Audio Video Interleaved)       |
| <b>.dvr-ms</b>                              | Digital Video Recording—Microsoft (TV file format) |
| <b>.mpeg, .mpg, .mpe, .m1v, .mp2, .mpv2</b> | Movie file   |
| <b>.wm, .asf</b>                            | Windows Media file                                 |
| <b>.wmv</b>                                 | Windows Media Video file                           |

**NOTE:** For more information about supported video file types, refer to *Help and Support*. Click the **Windows Start Button**  on the taskbar, and then click **Help and Support**.

## Transferring and Recording Video Files

Once you capture the video by using video capture and editing software, you can use Windows Media Center to find it and add it to the Videos area.

### Recording analog and digital video files

Refer to *Help and Support* for more information about capturing and recording video files from analog and digital video cameras.

To find information in Help and Support:

- 1 Click the **Windows Start Button**  on the taskbar, and then click **Help and Support**.
- 2 Type in search words such as *recording video*.

# Creating a DVD from Video Files in Windows Media Center

- 1 Click the **Windows Start Button**  on the taskbar, and then click **Windows Media Center**.
- 2 From the Tasks menu, click **burn cd/dvd**.
- 3 Insert writable media (CD-R, CD-RW, DVD+/-R, or DVD+/-RW) into the drive.
- 4 Select **Video DVD**, and then click **Next**.

---

**NOTE:** If you are using a rewritable disc that contains data, you must select **Erase Disc** to continue.

---

- 5 Select the **Untitled** area, enter the name of the disc by using the numeric keys on the keyboard or the remote control, and then click **Next**. Use the Backspace key on the keyboard or the Clear button on the remote control to delete letters.
- 6 Click **Video Library**, and then click **Next**.
- 7 Select the files you want to copy, and then click **Next**. A check mark appears next to a file when you select it.
- 8 Click **Add More** to add more files to the disc.
- 9 After you have selected all of the files, click **Burn DVD**.
- 10 Click **Yes**. Windows Media Center opens a message if you need to insert an additional disc to complete the recording. Windows Media Center opens a message when the disc has been created.
- 11 Click **Done** when the disc has been created.





# Creating Movies by Using muvee autoProducer

## (Select models only)



Creating personalized and professional-looking video movies is simple with muvee autoProducer, a software program that is installed on the computer. The 6.0 version of muvee autoProducer includes features such as video capture and disc recording.

## Basic steps for making a movie

The basic steps for producing a movie with muvee autoProducer are the following:

- 1 Capture digital video:** Capture live or recorded video to the hard disk drive directly from a compatible digital video (DV) camera.
- 2 Add videos and pictures:** Select video and still-image (picture) files from the computer folders. You can easily add videos and still images to the movie project.

You can use the following video and picture file types in the movie project:

| File extension     | File type   |
|--------------------|---|
| <b>.dv-avi</b>     | Digital Video   |
| <b>.avi</b>        | Audio Video Interleaved   |
| <b>.mpeg-1</b>     | Motion Picture Experts Group video playback                                     |
| <b>.mpeg-2</b>     | MPEG for DVD video playback   |
| <b>.MP4</b>        | MPEG for high-quality video format (Web streaming, wireless devices, and so on) |
| <b>.mov</b>        | QuickTime Movie   |
| <b>.wmv</b>        | Windows Media AV file (movie video)   |
| <b>.asf</b>        | Windows Media file (Advanced Streaming Format)                                  |
| <b>.jpg, .jpeg</b> | Joint Photographic Experts Group, still image                                   |
| <b>.gif</b>        | Graphics Interchange Format, still image  |

| File extension | File type (continued)                  |
|----------------|--|
| <b>.png</b>    | Portable Network Graphics, still image |
| <b>.tif</b>    | Tagged Image File Format, still image  |
| <b>.bmp</b>    | Bitmap, still image                    |

**NOTE:** If you upgrade muvee autoProducer, you can use the DivX video format. See “Upgrading muvee autoProducer.”

- 3 Add music:** Select music files on the computer to add to the movie soundtrack. You can use the following music file types in the movie project:

| File extension | File type                            |
|----------------|--------------------------------------|
| <b>.aac</b>    | Advanced Audio Coding                |
| <b>.mp3</b>    | MPEG Layer 3                         |
| <b>.m4a</b>    | MPEG-4 Audio layer (unprotected AAC) |
| <b>.wav</b>    | Windows Audio                        |
| <b>.wma</b>    | Windows Media Audio                  |

- 4 Select a style:** Apply a movie style editing template for different effects and picture transitions in the movie.
- 5 Add captions:** Personalize the movie with an opening title and closing credits.
- 6 Make the movie:** Automatically analyze the videos, pictures, music, movie style, and captions that you added to the project, and save the project to the computer hard disk drive before recording it to disc.
- 7 Modify the movie:** Make final changes to the movie before you save it.
- 8 Burn to disc:** You can record the movie to DVD, VCD, or SVCD.

The following sections provide detailed instructions for each of these steps.

# Using muvee autoProducer

## Getting started

To open muvee autoProducer (select models only):

- 1 Click the **Windows Start Button**  on the taskbar.
- 2 Click **All Programs, muvee autoProducer, Home movies made easy!**, and then click **Launch muvee autoProducer 6** to open muvee autoProducer.
- 3 On the File menu, select either **New Project** to start a new project or **Open Project** to open an existing project.









---

**NOTE:** By default, muvee autoProducer opens ready to start a new project.

---



4 Select one of the following buttons:

| Button  | Enables you to:  | See   |
|---|--|---|
| <b>Get Video from Camera</b><br>       | Open the muvee Video Capture window to capture (copy) live or recorded video.  | "Capturing video from a digital video camera."                        |
| <b>Add Video</b><br>                   | Open the Add Video window to add existing video files to the project.  | "Adding videos."  |
| <b>Add Pictures</b><br>                | Open the Add Pictures window to add existing still-image files to the project.   | "Adding pictures."  |
| <b>Add Music</b><br>                   | Open the Add Music window to add existing music files to the project.  | "Adding music."   |
| <b>Personalize</b><br>                 | Open the muvee Personalize Settings window to adjust audio and video production settings for the movie.  | "Changing the settings."  |
| <b>Title/Credits</b><br>               | Open the muvee Title and Credits window to enter an opening title and closing credits to the movie.<br><br><b>NOTE:</b> You must open the Personalize window to access the Title/Credits button. | "Changing the settings."  |
| <b>Make muvee</b><br>                | Open the Make muvee window to create and preview the movie automatically.  | "Making the movie."   |
| <b>Save and share your muvee</b><br> | Open the Listed muvee Files window to save the finished movie to the computer hard disk drive, or to record the finished movie to a disc.  | "Saving the movie project."<br>"Recording the movie project to disc." |
| <b>Tweak muvee</b><br>               | Make quick final changes to the movie before saving it.  | "Modifying the movie."  |

## Capturing video from a digital video camera

You can use muvee autoProducer to capture (copy) digital video files to the hard disk drive in either of the following ways:

- **Live** (known as *camera mode*), by using a compatible digital video (DV) camera. See “Capturing live video from a DV camera.”
- **Recorded** (known as *VCR mode*), by using a recorded tape in the DV camera. See “Capturing recorded video from a DV camera.”

Captured video files are automatically added to the movie project. To remove a file from the movie project, select it in the list of captured video files, and then click the **trash can** icon.



When capturing video, it is important to be aware of the amount of available free space on the computer hard disk drive. Capturing video can use a large amount of disk space. The amount of free disk space displays in the Capture Video window while you are capturing video.

### Capturing live video from a DV camera

Capturing live video in camera mode enables you to create a video file without even having a tape in the camera.

To capture live video to the hard disk drive by using muvee autoProducer:

- 1 Connect the DV camera to the FireWire (IEEE 1394) port on the computer.
- 2 Turn on the camera, and set it to VCR mode. Refer to the instructions in the manufacturer’s documentation.
- 3 Click the **Import video/pictures from a device** button.
- 4 Select **From My Camcorder**.
- 5 Browse to the camera, and then click **Open**. Your video appears in the Video/Pictures area.
- 6 Click **Import Now** to start capturing the live image directly to the hard disk drive.
- 7 Click **Filename** to specify a file name for the captured video file.
- 8 Click **Done** to add a captured video file automatically to the movie project.



### Capturing pictures from a DV camera

To transfer pictures to the hard disk drive by using muvee autoProducer:

- 1 Connect the DV camera to the FireWire (IEEE 1394) port on the computer.
- 2 Turn on the camera. Refer to the instructions in the manufacturer’s documentation.
- 3 Click the **Import video/pictures from a device** button.
- 4 Select **From My Camera/Device**.
- 5 Under Import my pictures/video, select the camera in the drop-down list.
- 6 Click **Media Screen**.



- 7 Click **Browse** to select a place to save the files, and then click **OK**.
- 8 Click **Filename** to specify a file name for the captured video file.
- 9 Click **Done** to add the captured video file automatically to the movie project.

## Capturing recorded video from a DV camera

For best results when using muvee autoProducer, capture only video footage that you are most interested in using in the movie project.

To capture recorded video to the hard disk drive:

- 1 Connect the DV camera to the FireWire (IEEE 1394) port on the computer.
- 2 Turn on the camera, and set it to VCR mode. Refer to the instructions in the manufacturer's documentation.
- 3 Click the **Import Video/Pictures from a device** button.
- 4 Select **From My Camcorder**.
- 5 Click the **Play** button to start viewing the video.
- 6 Click **Start Capture** when you see the start of the video footage that you want to use in the movie project.
- 7 Click **Stop Capture** to stop capturing.
- 8 Repeat steps 5 and 6 to capture additional sections of video footage.
- 9 Click **Capture Folder** to specify a folder for the captured video file.
- 10 Click **Filename** to specify a file name for the captured video file.
- 11 Click **Done** to automatically add the captured video files to the movie project.



## Adding videos

To add video files to the movie project:

- 1 Click the **Add video** button in the Video/Pictures area. The Add Video window opens.
- 2 Browse the folders on the hard disk drive to select existing video files for the movie:
  - Add up to three video files.
  - Select multiple video files by pressing and holding the Ctrl key on the keyboard while you select the files.



- 3 Adjust the order of the video files by dragging and dropping the files.

---

**NOTE:** To remove a clip from the project, select it, and then click the **trash can** icon.

---

- 4 You can use the magicMoments feature in muvee autoProducer to mark specific scenes in a video clip that you want to include in, or leave out of, the final movie:

- a Select a video file in the Select Video/Pictures window, and then click the **magicMoments** button. The magicMoments window opens.
- b Click the **Play** button to start viewing the video.
- c Use the magicMoments controls to mark the video scenes to include and exclude:



- Click and hold down the **green thumbs-up** button to mark scenes that must be included in the movie.
- Click and hold down the **red thumbs-down** button to mark scenes that must be left out of the movie.

---

**NOTE:** Press the Shift key on the keyboard, and then click the scene to undo scenes that were marked with the thumbs-up or thumbs-down buttons.

---

- Click and hold down the **gray thumb** button to unmark one second of a selected scene.
- Click and hold down the arrow buttons to navigate backward and forward through the video footage.

Video footage left unmarked is still analyzed when you make the movie, and you can decide at that time whether to include it in the final version of the movie.

For best results when using the magicMoments feature:

- Keep each magicMoment to less than 10 seconds.
  - Keep the total duration of magicMoments to less than 50 percent of the duration of the movie. It is recommended that you select only a few scenes.
- d When you are done marking scenes, click **OK**. The window closes. Note that the video clip is marked on the lower-left side.

## Adding pictures

To add still-image picture files to the movie project:



- 1 Click the **Add pictures** button in the Video/Pictures area. The Add Pictures window opens. 
- 2 Browse the folders on the hard disk drive to select existing still-image files for the movie:
  - Add up to 50 picture files.
  - Select multiple picture files by pressing and holding the Ctrl key on the keyboard while you select the files.
  - Click **Open** to add pictures to the Video/Pictures area.
- 3 Adjust the order of the picture files by dragging and dropping them.

---

**NOTE:** To remove a picture from the project, select it, and then click the **trash can** icon.

---



- 4 Click the **Rotate Image Clockwise** button to rotate a picture. 
- 5 You can use the magicSpot feature in muvee autoProducer to control the pan and zoom motion that is applied to the picture:
  - a Click the **magicSpot** button to open the magicSpot window. 
  - b Click the **Manual** button to display two overlapping frames over the picture.



- c Move the frames around to set the start and end points for motion. The arrow in the frames shows the direction of motion.
- d When you are done, click **OK**.



## Adding music

To add music files to the movie project as a soundtrack:

- 1 Click the **Add music** button in the Music area. The Add Music window opens. 
- 2 Browse the folders on the hard disk drive to select existing music files for the movie:
  - Add up to three music files.
  - Select multiple music files by pressing and holding the Ctrl key on the keyboard while selecting the files.
  - Click **Open** to add the music files to the Music area.
- 3 Adjust the order of the music files by dragging and dropping the files.

---

**NOTE:** To remove music from the project, select it, and then click the **trash can** icon. 

---

## Selecting the style

The muvee autoProducer program comes with a set of style templates for setting the pace, scene-transition effects, and caption fonts. The style that you use also affects how muvee autoProducer combines the video, picture, and music files in the movie project to produce the final movie.

For example, using the Back-in-Time style results in a movie that is in a scratchy sepia to black-and-white format.

To select a style, just click it in the list. A sample of the style is displayed in the Select Style window.

## Changing the settings

---

**IMPORTANT:** Each time that you make a change to a movie project, you must click the **make muvee** button again to add that change to the movie.

---

To adjust the audio and video project settings for the movie:

- 1 Click the **Personalize** button. The Personalize window opens.
- 2 Click the **Duration** tab to set preferences for the length of the video production. Click one of the following settings:
  - **Fit to music:** The produced version may reuse or drop some video and pictures. This option automatically selects material from the video and pictures to fit the total duration of the music track(s).
  - **Best fit for videos and pictures:** The produced version may repeat or trim music. This option uses as much of the material as possible.
  - **User defined:** Use this option to select the duration for each picture (2, 3, 4, 5, or 6 seconds).
- 3 Click the **Video/Pictures** tab to set preferences for the video and still images (pictures). Click one of the following settings:
  - **Style default:** Select this style to sequence still images and video clips.
  - **Keep shots in sequence:** Select this style to use the sequence of still images and video clips as they appear in the Add Video/Pictures area.
  - **Shuffle settings:** Select this style to determine the frequency of sequencing still images and video clips by moving the slider.
    - Place a check in the **Interleave pictures** check box to blend still images with video clips at intervals.
    - Place a check in the **Use every picture once** check box to prevent pictures from being dropped.
- 4 Click the **Audio** tab to set the sound preferences. Click one of the following settings:
  - **Use every music track:** Select this style to use the sequence of sound files in the Add Music window.
  - **Seamlessly transition between multiple music tracks:** Select this style to automatically remove silence between music tracks.
  - **Sound check:** Select this style to automatically adjust audio playback volume to the same level.
- 5 Click the **Superstyle** tab to customize the style that you selected in the main muvee autoProducer window. You can select the following settings:
  - **Response to music**
  - **Cutting rate**
  - **Film color**

- 6 Click the **Title** tab to type in the movie title.
  - Select the animation style of the title.
  - Choose the background color or image style. Click the **Use image** button to browse for an image that you want to use with the title.
  - Type in the title. Select **Use Font**, and then click the **Use Font** button to open the Font window. Select a font, and then click **OK**.
- 7 Click the **Credits** tab to type in the movie credits.
  - Select the animation style of the credits.
  - Choose the background color or image style. Click the **Use image** button to browse for an image that you want to use with the credits.
  - Type in the credits. Select **Use Font**, and then click the **Use Font** button to open the Font window. Select the font, and then click **OK**.
- 8 When you are done adjusting the settings for the movie project, click **OK**.  
*Or*  
Click **Cancel** to undo any settings.

## Making the movie

After you have added at least one video or picture file to the movie project, you can have muvee autoProducer make the movie.

The muvee autoProducer program makes a movie by combining the video, picture, and music files that you have selected, along with the style of movie, to produce a professional-looking movie in just a few steps.

- 1 Click the **make muvee** button.
- 2 Click **OK**, as required.
- 3 After making a movie, you can preview it in the muvee autoProducer Preview window. Use the controls in the Preview window to play, pause, and stop the movie preview.

You can revise and preview the movie as often as you want, to experiment with different styles and with the content of the movie.

---

**IMPORTANT:** Each time that you make a change to a movie project, you must click the **make muvee** button again to add that change to the movie.

---

## Previewing the movie

After you have made the movie, you can preview how it looks and sounds, and take snapshots of frames in the movie.

- 1 Click the **Start Playback** button. The movie starts playing.
- 2 Use the **Stop** and **Previous Frame/Next Frame** buttons to navigate through the movie.
- 3 Click the **Take a Snapshot** button to save the current frame as a picture file (.jpeg, .bmp, or .gif format).
- 4 Click the **Go to the source of the segment** button to open the magicSpot window. For more information about using magicMoments, see “Adding videos.”
- 5 Click the **Full-screen preview** button to view the movie in the full-screen mode.
- 6 Click the **Audio mix** button to adjust sound levels for the movie.



## Modifying the movie

After you have created the movie, muvee autoProducer enables you to make some quick final changes to the project before you save it. You can also have muvee autoProducer replace pictures or videos with other similar or contrasting ones. Alternatively, you can manually choose the replacement shots.

To modify a movie:

- 1 Click the **tweak muvee** button. The Tweak muvee window opens.
- 2 Click the **Start Playback** button. The movie starts playing.
- 3 Click the **Pause Playback** button to stop the movie at any time.
- 4 You can also click on the seek bar or drag the slider to move to a particular point in the movie.



5 Use the controls in the Tweak muvee window to modify the movie project:

---

**NOTE:** In the Tweak muvee window, you can replace a video segment only with another video segment from the original footage; likewise you can replace pictures only with other pictures. You cannot expand the duration of the selected clip or the replacement clip.

---

- Click the **Auto-replace with similar** button to automatically replace a picture or video segment with another similar picture or video segment.
- Click the **Auto-replace with different** button to automatically replace a picture or video segment with a completely different picture or video segment.
- Click the **Manually replace the selected segment** button to replace a picture or video segment with a picture or video segment of your choice.
- Click the **Start recording voiceover** button to record your voice-over content. When you are finished recording, click the **Stop recording voiceover** button.
- You can click the **Remove voiceover** button to delete voice from a segment of the movie.
- Click the **Undo** or **Redo** button as needed.

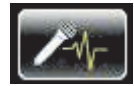

6 When you are done modifying the movie project, click **OK** to save the changes and close the Tweak muvee window.



Or

To close the Tweak muvee window without saving the changes, click **Cancel**.

7 Click the **make muvee** button to save the changes to the movie.

## Saving the movie project

After you are satisfied with the look of the movie project, you are ready to save the movie as a file on the hard disk drive:

- 1 Click the **muveeShare** button. The Listed muvee Files window opens, with all the muvee files listed.
- 2 Remove the check mark next to any muvee files that you do not want to save.
- 3 Edit the muvee files before you save them:
  - Click the **Rename** button to change the name of the selected muvee file.
  - Click the **Move up** or **Move down** button to change the order of the selected muvee file in the list.
  - Click the **Select all** or **Deselect all** button to save all muvee files or to save none of them, respectively.
  - Click the **trash can** icon to delete the selected file.
- 4 The TV System area shows the current TV format (NTSC or PAL). To change the format, click the name of the current format, and then select the correct format in the window that opens.
- 5 Click **Save Now**. The muveeShare window opens.
- 6 Choose where you want to save the movie (**disc**, **e-mail**, **Web streaming**, **PC**, or **Mobile Device**) by clicking one of the icons at the top of the window, and then select the settings.
- 7 When you are done, click **Close**.  
Or  
Click **Open output** to see where the files are saved.  
Or  
Click **Play muvees**.
- 8 When you are done, click **Close**.

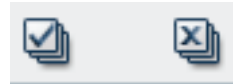
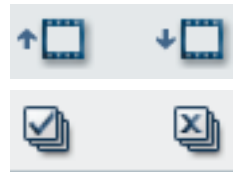

## Recording the movie project to disc

To create a DVD, VCD, or SVCD disc of the movie project:

- 1 Click the **muveeShare** button. The Listed muvee files window opens with all the muvee files listed.
- 2 Remove the check mark next to any muvee files that you do not want to save.
- 3 Edit the muvee files before you save them:
  - Click the **Rename** button to change the name of the selected muvee file.
  - Click the **Move up** or **Move down** button to change the order of the selected muvee file in the list.
  - Click the **Select all** or **Deselect all** button to save all muvee files or to save none of the muvee files, respectively.
  - Click the **trash can** icon to delete the selected file.
- 4 Click the **disc** icon to create copies of all of the picture and video files that are used to create the muvee file.
- 5 The TV System area shows the current TV format (NTSC or PAL). To change the format, click the name of the current format, and then select the correct format in the window that opens.
- 6 Under Disc title, type a title for the disc.
- 7 Select the disc menu theme in the drop-down list. You can preview the different themes in the window.
- 8 Select the **CD** or **DVD** burner drive in the drop-down list.
- 9 Click **Burn Now**.
- 10 Select the type of video disc that you want to create: **DVD**, **VCD**, or **SVCD**. The window shows the disc capacity, the disc capacity used, and available disc space.
- 11 If you want to create more than one disc of the same muvee file:
  - a Click a number next to **Number of copies**, and then click **OK**.
  - b Select the number of copies to record, and then click **OK**.
- 12 Insert a disc into the DVD recording drive.
- 13 Click **Burn Now** to start recording the movie to disc.

---

**NOTE:** For best disc quality, it is recommended that you not perform other computer tasks while the movie is being recorded to disc.

---

Or

To save the current settings for future use, click **Burn Later**.

- 14 When the recording is complete, click **OK**.
- 15 Click **Close**.



## Upgrading muvee autoProducer

You can purchase an upgraded version of muvee autoProducer. The upgraded version enables you to use unlimited video clips, audio clips, and still images in the movie project. It also includes support for DivX file types, so that you can import or create DivX-format movies. (Purchasing DivX videos from DivX services may require a subscription.)

To see muvee autoProducer offers for HP customers:

- 1 At the top of the muvee autoProducer window, click **Help**.
- 2 Click **Check for updates**. The program accesses the Internet and displays muvee autoProducer offers.

## Supported muvee autoProducer output file types

The supported muvee autoProducer file types are the following:

| File extension | File type                                   |
|----------------|---|
| <b>.dv-avi</b> | Digital Video                               |
| <b>.avi</b>    | Audio Video Interleaved                     |
| <b>.mpeg-1</b> | Motion Picture Experts Group video playback |
| <b>.mpeg-2</b> | MPEG for DVD video playback                 |
| <b>.wmv</b>    | Windows Media AV file (movie video)         |



# Index

## A

- adding
  - CD tracks to the music library 136
  - music files to the music library
    - from the hard disk drive 135
- adjusting monitor 11
- antivirus, installing program 55
- audio connector 5
  - Audio Line Out 5
  - retasking (multistreaming) 82
- audio input, left and right connectors 4
- autoscroll 69

## B

- batteries
  - installing in remote control 90
  - type for remote control 90
- Bluetooth devices 14
- Blu-ray
  - compatibility 115
  - DVD 118
  - using a Blu-ray drive 113, 116, 118
- burning
  - audio and data disc 170–175
- buttons
  - keyboard, customizing 62
  - media control or playback 62
  - Off, See turning off computer 44
  - remote control 88

## C

- cable modem, using 12, 47, 97
- card reader, memory 119
- carpal tunnel syndrome 48
- CDs
  - erasing rewritable 170
  - playing 141
- change the speed of the cursor 70
- CompactFlash media 121
  - troubleshooting memory card reader 124
- CompactFlash Type I 122
- CompactFlash Type II 122
- Composite video connector 4, 6
- computer
  - front-panel connectors 2
  - Help & Tools 40
  - setting up 1
  - transferring files 55
  - turning off 44
- connecting
  - devices 10
  - digital camera 8
  - digital video camera 8
  - headphones 35
  - peripherals 2
- connection
  - modem 16
  - wired network 13

- connector
  - Audio Line In 5
  - Audio Line Out 5
  - back panel 7
  - Composite Video In 6
  - computer 2
  - FM In 6
  - headphones 4
  - keyboard 4
  - Microphone In 4
  - modem 7
  - monitor 7
  - mouse 4
  - printer 5
  - S-video In 5
  - TV/Cable Ant 6
  - USB 4, 5
- country/region codes 149
- Creative Sound Blaster X-Fi Sound Card
  - audio modes 77
  - configuring 76
- cursor speed 70
- customizing keyboard buttons 62
- CyberLink LabelPrint
  - creating a LightScribe label 176
  - features 104
- CyberLink Power2Go
  - copying a disc 174
  - erasing discs 170
  - features 104
- CyberLink PowerDirector
  - creating video disc 173
- D**
- desktop
  - switching from Windows Media Center 164
- devices
  - connecting 10
- digital camera
  - connecting 8, 10
- digital images 179
- digital picture 119, 179
- digital video camera
  - connecting to a computer 8
  - recording videos 173, 195
  - troubleshooting 9
- digital video camera capture 195
- discs
  - drive compatibility 115
  - erasing rewritable 170
  - features and compatibility 116
- documentation, onscreen 39
- DV camera capture 195
- DVD movies
  - changing
    - audio settings 152
    - language 150
  - playing
    - in Windows Media Center 149
- DVD Play, features 103
- DVDs
  - erasing rewritable 170
  - High-Definition 117
  - playing Blu-ray DVDs 147
  - playing HD DVDs 147
- E**
- erasing rewritable discs 170
- error messages
  - Image cannot be displayed 183
- errors
  - reducing recording speed 171
- Ethernet connection 13
- Ethernet network hub 5
- F**
- file type
  - music 137, 192
  - picture 183, 191, 192
  - video 188, 191, 206
- FireWire 195, 196
- FM In connector 6
- FM radio antenna
  - connecting 6
- Found New Hardware* message, connecting a digital camera 9
- H**
- headphones
  - connector 4
  - using 35
- Help and Support 40
- High-Definition 118
  - disc drives 116
- home videos 173, 195

HP Media Drive 125  
  activity and power lights 127  
  automatic on and off feature 126  
  disconnecting the drive 130  
  inserting a drive 127  
  location and drive letter 129  
HP Photosmart Essential 103  
HP Pocket Media Drive 125  
HP Total Care Advisor 41

## I

IBM Microdrive 122  
Internet security 52, 100

## K

keyboard  
  connector 4  
  customizing buttons 62  
  shortcuts 63  
  types of buttons 57  
  using 57

## L

LAN (local area network) 12  
  antenna 15  
  checking wireless LAN device 15  
  connecting Ethernet LAN 5  
  connecting wireless LAN device 14  
  setting up 13  
  using Local Area Network 12  
LightScribe, creating a LightScribe disc label 175  
local area network (LAN) 12

## M

magicSpot 198  
manuals  
  storing 10  
memory card reader 179  
  card types 119  
  in-use light 123  
  troubleshooting 124  
  using 119  
memory card, formatting 123  
Memory Stick (MS) 121  
Memory Stick (MS-Duo) 121  
Memory Stick (MS-Pro Duo) 121  
Memory Stick (MS-Pro) 121

Microdrive disk drive 121  
microphone connector 4, 5  
Mini Secure Digital (MiniSD) 121  
mini-jack 18  
modem  
  connection 16  
  connector 7, 16  
monitor  
  adjusting 11  
monitor connector 7  
mouse  
  autoscroll 69  
  cursor speed 70  
  panning 69  
  switching button functions 69  
mouse connector 4  
MultiMediaCard (MMC) 121  
MultiMediaCard Plus (MMC+) 121  
Music 133  
  deleting music from the Music library 137  
  finding and playing an album 141  
  playing a song 140  
  supported file types 137  
music  
  playing with Windows Media Player 147, 153  
music library  
  adding CD tracks 136  
  creating 135  
Mute button 62  
muvee autoProducer  
  adding a title and credits 194  
  adding music 194  
  adding pictures 194, 198  
  adding video 194, 196  
  basic steps to create a movie 191  
  changing settings 200  
  copying a movie to disc 205  
  features 104  
  getting started 193  
  getting video from a camera 194  
  making a movie 201  
  previewing a movie 202  
  rotating images clockwise 198  
  selecting style 199  
  setting the duration of video 200  
  upgrading 206  
  using the magicMoments feature 197

## N

- network interface adapter 5
- Network Interface Card (NIC) 13
- Norton Internet Security
  - configuring 100
  - registering 100

## O

- Off button, See turning off computer 44
- optical drive quick reference 117
- Optimization setting 162, 167

## P

- panning with the mouse 69
- peripherals 2
- pictures 179
  - copying pictures to CD 186
  - editing 184
  - printing 184
  - rotating 185
  - turning captions on or off 181
  - types of files it can display 183
  - viewing 181
  - viewing a slide show with music 182
  - viewing pictures as a slide show 182
- playing
  - digital music files 138
  - digital videos 187
  - DVDs in Windows Media Center 149
  - music CDs 146
  - music CDs in Windows Media Center 138
  - songs 142
- playlist
  - creating in Music 143
- power connector 4
- PowerDirector, features 104
- printer
  - connecting 10
  - connector 5

## R

- recording
  - videos from digital video camera 173, 195
  - with Realtek HD Audio Manager 81
- reduced size MultiMediaCard (RSMMC) 121

- remote control
  - buttons 88
  - range 90
  - type of battery to use 90
  - using 90

- remote sensor 91
  - using 90

- repetitive strain injury (RSI), see *Safety & Comfort Guide*
- rewritable discs, erasing 170

## S

- Safety & Comfort Guide* 48
- safety warnings 48
- scanner, connecting 10
- scrolling with the mouse 68
- Secure Digital (SD) memory card 121
- setting up computer 1
- settings
  - for sound 166
  - general 166
  - Internet connections 166
  - remote control and remote sensor 91
- Shared Video folder 187
- shortcuts
  - keyboard 63
- shutting down computer 44
- sleep mode button 60
- slide show
  - displaying information about pictures 182
  - viewing pictures 182
  - viewing with music 182
- software programs
  - CyberLink LabelPrint 104, 176
  - CyberLink Power2Go 104, 170
  - CyberLink PowerDirector 104, 173
  - DVD Play 103
  - Windows Movie Maker 105
- speaker systems 21
- speakers
  - connecting multichannel audio speakers to the computer 17, 19–35
  - multichannel audio
    - connecting 78
  - resolving sound issues 86
- Start menu
  - Windows Media Center 163
- surge protector 1
- SVCD 205
- S-video In connector 3, 5
- switching mouse button functions 69

## T

- transferring information to your new computer 55
- troubleshooting
  - remote sensor 91
- turning off computer 44

## U

- update, Windows Vista 53
- updating, system 53
- USB connector 4, 5
- user accounts
  - creating 49

## V

- VCD 205
  - playing with Windows Media Player 155
- video capture
  - live 195
  - recorded video 195
- video editing
  - getting started with muvee autoProducer 193
- video movies
  - transferring and recording 188
- videos 187
  - creating a DVD 189
  - playing 187
  - playing digital videos 187
  - transferring videos 188
  - working with home videos 8
- visualization settings 139
- volume
  - controls 62

## W

- WEP 16
- Windows Media Center
  - menu bars 164
  - navigating 165
  - opening with remote control 90
  - playing DVDs 149
  - playing videos 187
  - resizing window 164
  - using with another program open 164
  - viewing your pictures 181
  - what you can do
    - in Music 133
- Windows Media Player
  - playing DVDs 153
  - playing music CDs 147
  - playing video CDs 155
  - setting as default player 137
  - types of files 137
- Windows Movie Maker, features 105
- Windows Vista update 53
- wired network connection 13
- wireless devices 14
- wireless LAN 14
- wireless LAN connection 14
- wireless local area network (WLAN) 14
- wireless network
  - security 16
- wireless network device
  - checking installation 15
- wireless wide area networks (WWAN) devices 14
- WLAN security 16
- working in comfort 48
- WPA 16

## X

- xD media 122

## Y

- Y adapter cables 28

Part number: 5992-2246