

Advanced Setup Guide

The only warranties for Hewlett-Packard products and services are set forth in the express statements accompanying such products and services. Nothing herein should be construed as constituting an additional warranty. HP shall not be liable for technical or editorial errors or omissions contained herein.

HP assumes no responsibility for the use or reliability of its software on equipment that is not furnished by HP.

This document contains proprietary information that is protected by copyright. No part of this document may be photocopied, reproduced, or translated to another language without the prior written consent of HP.

Hewlett-Packard Company
P.O. Box 4010
Cupertino, CA 95015-4010
USA

Copyright © 2000–2007 Hewlett-Packard Development Company, L.P.

This product incorporates copyright protection technology that is protected by U.S. patents and other intellectual property rights. Use of this copyright protection technology must be authorized by Macrovision, and is intended for home and other limited pay-per-view viewing uses only unless otherwise authorized by Macrovision. Reverse engineering or disassembly is prohibited.

Microsoft and Windows Vista are U.S. registered trademarks of Microsoft Corporation.

The Windows logo and Windows Vista are trademarks or registered trademarks of Microsoft Corporation in the United States and/or other countries/regions.

HP supports lawful use of technology and does not endorse or encourage the use of our products for purposes other than those permitted by copyright law.

The information in this document is subject to change without notice.

Table of Contents

Setting Up the Computer	1
Putting the Computer Together	1
Placing the computer in the proper location	1
Using surge protection	2
Connecting to the computer	2
Connecting a Digital Camera (Photo or Video).....	8
Connecting Other Devices	10
Storing Documentation and Recovery Discs.....	10
Adjusting the Monitor.....	11
Adjusting the screen resolution by using Vista	11
Adjusting the screen resolution by using the NVIDIA Control Panel	11
Setting Up a Local Area Network	12
Setting Up a Wired (Ethernet) Connection	13
Integrated Wireless Devices	13
Connecting the Wireless LAN Device.....	14
Checking the wireless LAN device installation	15
Using wireless security features	15
Connecting a Modem	16

Connecting Speakers or Microphone	17
Sound Connector Types	17
Connecting a Microphone	20
Speaker Configurations.....	21
Speaker types	22
Connecting 2/2.1 (Two speakers and a subwoofer) audio speakers.....	22
Connecting 4.1 (Four speakers and a subwoofer) audio speakers	23
Connecting 5.1 (Five speakers and a subwoofer) audio speakers.....	25
Connecting 7.1 (Seven speakers and a subwoofer) audio speakers	26
Connecting your home stereo system (optional)	29
2.1 home stereo installation	30
5.1 home audio installation	31
5.1 home audio installation procedure.....	31
7.1 home audio installation	33
7.1 home audio installation procedure.....	34
Connecting digital audio	35
Connecting Speakers Using the Creative Sound Blaster X-Fi Sound Card.....	37
Connecting the speakers	37
Connecting the FlexiJack connector.....	38
Connecting the Television Signal and Video Cables.....	39
Using TV Cables.....	39
Audio and Video Cables and Adapters.....	40
Connecting the TV Signal Source.....	41
Connecting a dual tuner	42
Connecting the Remote Sensor	43
Connecting the TV Signal Source When You Have an Existing Setup	44
Wall to VCR to TV, using coaxial cable.....	44
Wall to cable TV set-top box or satellite box to VCR to TV, using coaxial cable	45
Wall to cable TV set-top box or satellite box to VCR and TV, using S-video cable or composite video cable between the box and the VCR or TV	46
Using a TV as a Monitor	48
Cables for connecting the computer to a TV	48
Connecting the computer to a TV.....	48
Viewing the computer desktop on a TV screen.....	49
Adjusting the screen resolution	49
Connecting more than one display	49
Using the Windows Media Center Setup for Optional Setup of the TV Display.....	50
Disabling the TV-out Option	51
Disconnecting the TV.....	51

Connecting to a Monitor or High-Definition TV 51
 Choosing the AV connection to use 51
 Connecting an HDMI device 53
 Connecting a DVI device 54
Connecting to a Standard TV 55
 Connecting to component video 55
 Connecting to S-video 56
Configuring the TV Tuner 56
 Digital versus analog tuner 57
 Initial configuration using Windows Media Center setup wizard 57
 Changing the tuner settings 58
Index.....59

Setting Up the Computer



WARNING: The power supply is preset for the country/region in which you purchased your computer. If you move, please check the voltage requirements for your new location before plugging the computer into an AC power outlet.



WARNING: Please read “Safety Information” in the *Limited Warranty and Support Guide* before installing and connecting the computer to the electrical power system.

Putting the Computer Together

Follow the steps on the setup poster to set up the computer. Read the topics in this section to learn more about the location of components and connectors on the computer, and to learn about some setup alternatives.

Look in the computer box for printed details or updates regarding the computer.

Placing the computer in the proper location

When setting up your new computer, place it where ventilation openings are unobstructed. Make sure that all connections are secure and that all cabling is out of the way. Do not place cabling in walkways or where it can be stepped on or damaged from placing furniture on it.

Using surge protection









Help protect the monitor, computer, and accessories by connecting all power cords for the computer and peripheral devices (such as a monitor, printer, or scanner) to a surge protection device, such as a power strip with surge protection or an uninterruptible power supply (UPS). Many surge protection devices have surge protection inputs and outputs for modem or telephone lines. Telephone lines are a common path for lightning spikes to get into the system. Some surge protection devices have surge protection for television cable connections as well. Use those if the computer has a television tuner installed.

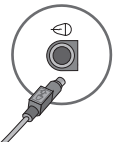





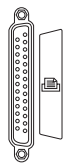



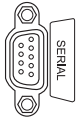





Not all power strips provide surge protection; the power strip must be specifically labeled as having this capability. Use a power strip whose manufacturer offers a damage replacement policy that replaces the equipment if surge protection fails.

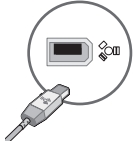











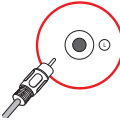

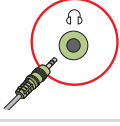
Connecting to the computer











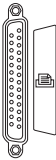



Connect the main hardware devices, such as the monitor, keyboard, and mouse, to the back of the computer. Other peripheral devices, such as a printer, scanner, or camera, also plug into connectors on the back of the computer. Some computers also have connectors on the front of the computer. The following table shows some, but not all, connectors:









NOTE: The location, availability, and number of connectors on the computer may vary.









Connector	Icon/Label	Description and function
		Mouse (PS/2 connector).
		Keyboard (PS/2 connector).
		Universal Serial Bus (USB) for mouse, keyboard, digital cameras, or other devices with USB connectors.
		Printer (parallel).

Connector	Icon/Label	Description and function (continued)
	Serial	Serial port for some digital cameras or other serial devices.
	 OUT	Audio Line Out (powered speakers).
	 IN	Audio Line In.
		Headphones.
		Microphone.
		FireWire® (IEEE 1394) for video cameras or other devices with very fast transfer rates. NOTE: You must use a 6-pin FireWire (IEEE 1394) transfer cable with this 6-pin connector.
	digital audio in out	Digital audio in and digital audio out.
	 side	Side speaker out.
	 rear	Rear speaker out.
	 c/sub	Center/Subwoofer.

Connector	Icon/Label	Description and function (continued)
	S-Video 2	Secondary S-video connector to connect a VCR, video camera, or other analog source to the computer.
	Composite Video 2	Secondary Composite video connector (yellow) to connect to a VCR, video camera, or other analog source to the computer.
	A/V In Audio 2 L	Secondary Left audio input connector (white). NOTE: This Audio In connector is connected to the TV tuner. You must use the Audio In connector, which is connected to the motherboard and located on the back of the computer, to record audio only (select models only).
	A/V In Audio 2 R	Secondary Right audio input connector (red). NOTE: This Audio In connector is connected to the TV tuner. You must use the Audio In connector, which is connected to the motherboard and located on the back of the computer, to record audio only (select models only).
		Headphones Out connector (green) to connect to headphones.
		Microphone In connector (pink) to connect to a microphone.
		Universal Serial Bus (USB) 2.0 connector to connect to a mouse, keyboard, digital camera, or another device with a USB connector.
		Power connector.
		Mouse connector to connect a mouse.
		Keyboard connector to connect a keyboard.

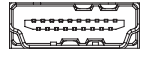
Connector	Icon/Label	Description and function (continued)
		Printer (parallel) connector to connect a parallel printer (select models only).
		Universal Serial Bus (USB) 2.0 connector to connect a mouse, keyboard, digital camera, or another device with a USB connector.
	ETHERNET	<p>Ethernet LAN connector is a network interface adapter (also called a network interface card, or NIC) that connects to an Ethernet (10BaseT) or Fast Ethernet (100BaseT) network hub.</p> <p>Connect this adapter on the computer with your local area network (LAN) hub or any broadband connection.</p> <p>The green LED indicates a valid connection.</p>
		Microphone In (Mic) (pink) to connect to a microphone (also functions as a center/subwoofer Line Out when a multichannel audio configuration is activated).
		Audio Line Out (green) to connect front speakers.
		Audio Line In (blue) connector to connect to an analog audio device such as a CD player for input into computer (also functions as rear Line Out when a multichannel audio configuration is activated).
	Center	Line C/Sub (gold) connector to connect Center/Subwoofer speakers in a multichannel audio configuration.
	Rear	Line Rear (black) connector to connect rear speakers in a multichannel audio configuration.
	Side	Line Side (gray) connector to connect side speakers in an eight-speaker system (7.1).
	S-Video	S-video In connector to connect from a set-top box output connector.

Connector	Icon/Label	Description and function (continued)
	Composite Video	Composite Video In connector (yellow) to connect to a TV set-top box.
	A/V In Audio 1 L	Primary left audio input from set-top box connector (white). NOTE: Audio can be recorded by using this Audio In connector, which is connected to the motherboard. Some computers include this primary left audio input connector on the front of the computer (select models only).
	A/V In Audio 1 R	Primary right audio input from set-top box connector (red). NOTE: Audio can be recorded by using this Audio In connector, which is connected to the motherboard. Some computers include this primary right audio input connector on the front of the computer (select models only).
	TV/Cable Ant	TV In (TV antenna or cable input from wall outlet with no set-top box).
	ATSC	TV In connector for TV cable or antenna, which receives ATSC channels (Advanced Television System Committee), which are over-the-air digital transmission channels.
	CATV	TV In connector for TV cable or antenna, which receives CATV (Community Antenna Television) or cable TV channels.
	NTSC	TV In connector for TV cable or antenna, which receives NTSC channels (National Television System Committee), which are over-the-air analog transmission channels.
	FM Ant	FM In (radio antenna input) connector, which connects to the FM antenna cable. Plug the FM radio antenna cable into the FM In port on the back of the computer on the TV tuner card. You may want to extend the ends of the cable to improve your FM radio signal reception.

Connector	Icon/Label	Description and function (continued)
		Modem (Line In RJ-11) (select models only). Plug the modem cable (provided in the computer box) into the computer modem connector on the back of the computer. Plug the other end to the telephone line wall jack connector.
	Analog Video	Analog Video Out: S-video or composite video connector (select models only), which connects to a TV.
	VGA/Monitor 	VGA/Monitor (blue) display output connector, which connects to a VGA monitor. You may need to use a VGA-to-DVI adapter to connect the display to the computer.
	HDMI	HDMI display output connector, which connects to an HDMI monitor or TV display. You may need to use a HDMI-to-DVI adapter to connect the display to the computer.
	DVI	Digital video output connector, which connects to a TV or monitor (select models only). You may need to use a VGA-to-DVI or a HDMI-to-DVI adapter to connect the display to the computer. See the documentation that came with the display device.
	digital audio in out	Digital audio input (white) connector, which connects to a digital audio device with digital input (such as a home audio receiver/amplifier) or digital speakers (select models only). Digital audio output (red) connects to a digital audio device with digital output (select models only).
	Digital Audio Out	Digital Out (orange) connector, which connects to a digital audio device with digital input (such as a home audio receiver/amplifier) or digital speakers (select models only).

Connecting a Digital Camera (Photo or Video)

The following instructions apply only to digital photo cameras and digital video cameras.

NOTE: When connecting an analog video camera to the computer, use the Video and Audio In connectors on the front or back of the computer.

Refer to the documentation that came with your digital photo camera or digital video camera.

To connect a digital photo camera or a digital video camera:

- 1 Turn on the computer, and wait for the Microsoft® Windows Vista® operating system to start.

NOTE: If a Digital Video Device AutoPlay window appears when you connect the camera, click **Cancel**.

- 2 Connect the 6-pin video camera transfer cable into the camera, and then into an open port on the front or back of the computer. Most digital video cameras use either the FireWire (IEEE 1394) port or the USB port.

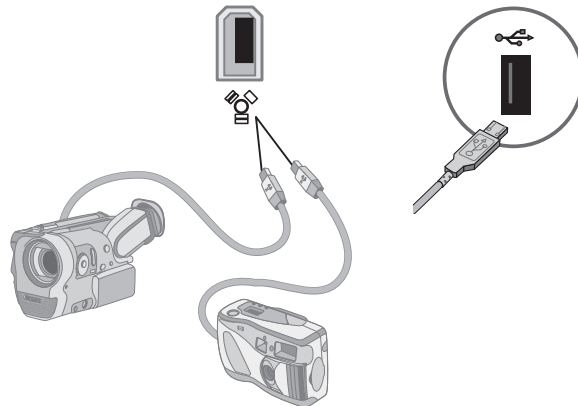

- 3 A *Found New Hardware* message appears. Wait 2 or 3 minutes for Windows Vista to make the necessary settings for the new device. When installation is complete, a message appears, indicating that the camera is ready to use.

- 4 You may need to install driver software for your camera. If so, Windows displays a message asking if you want to locate and install driver software. Insert the driver software CD, click **Locate and install driver software**, and then follow any onscreen instructions to install the software.



If the computer does not recognize the digital photo camera or the digital video camera:

- 1 Click the **Windows Start Button**  on the taskbar, and then click **Control Panel**.
- 2 Click **System and Maintenance**, and then click **System**.
- 3 Click **Device Manager**.
- 4 Click the plus sign (+) next to the camera port. If the name of the camera appears, the device is ready. If the name is not there, try the following:
 - Click **Action**, and then click **Scan for hardware changes**. Look in Device Manager for a new addition under the port.
 - Unplug the video camera transfer cable from the computer, and plug it into a different port. Look in Device Manager for a new addition under the port.

Connecting Other Devices

Other peripheral devices can be connected to the front or back of the computer by using USB or FireWire (IEEE 1394) ports. These peripheral devices include printers, scanners, video cameras, digital photo cameras, memory card readers, and PDAs (personal digital assistants) or handheld computers. Refer to the documentation that came with your device.

NOTE: Some peripheral devices are not included with the computer.

NOTE: You must use a 6-pin (not a 4-pin) FireWire (IEEE 1394) cable with the 6-pin FireWire (IEEE 1394) connector on the computer.

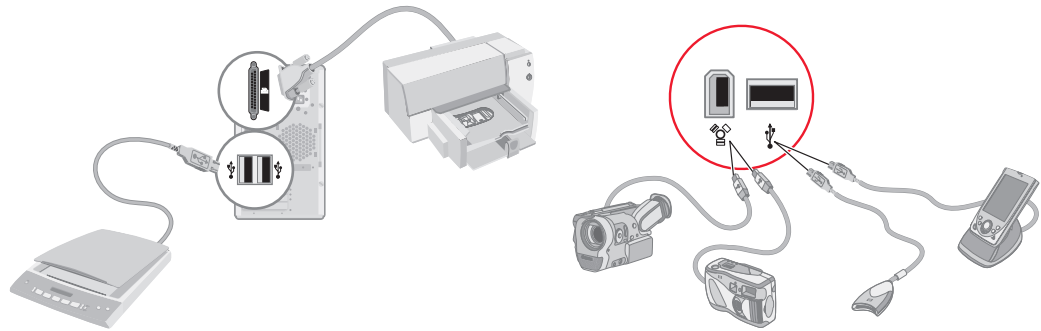

Storing Documentation and Recovery Discs

Store all computer user manuals and warranty information in an easy-to-find, safe location. It is a good idea to store the system recovery discs with the documentation. This allows easy access to all important computer documents and files.

Adjusting the Monitor

Adjusting the screen resolution by using Vista

To change the screen resolution by using Vista:

- 1 Right-click an empty area of the desktop, and then click **Personalize**.
- 2 Click **Display Settings**.
- 3 If necessary, select the monitor, and then adjust the screen resolution by using the slider under Resolution.
- 4 Click **Apply**.
- 5 Click **Yes**, if it is present.
- 6 Click **OK**.

NOTE: You can connect more than one display device (CRT monitor, flat panel monitor, TV, and so on) to the computer at a time (select models only). You can quickly change which device displays the computer desktop by pressing Alt+F5. Each time you press Alt+F5, the computer desktop appears on the next device. If pressing Alt+F5 does not work, restart the computer and try again.

Adjusting the screen resolution by using the NVIDIA Control Panel

To change the screen resolution by using the NVIDIA Control Panel:

- 1 Right-click an empty area of the desktop, and then click **NVIDIA Control Panel**.
- 2 Select **Standard** or **Advanced** and then click **OK**.
- 3 Under Display, click **Change resolution**.
- 4 If necessary, select the display, and then adjust the screen resolution by using the slider under Display resolution.
- 5 Click **Apply**, and then click **Yes** if you want to apply that resolution.

Or

Click **No**, and change the resolution by using the slider under Display resolution again, click **Apply** and then click **Yes**.

Setting Up a Local Area Network

A home local area network (LAN) may consist of either a wired or a wireless network that you can use to connect the computer to other devices on the network, including other computers. The network components may include a hub or a switch, which can connect multiple devices to the network, or a router, which can connect computers or a broadband Internet connection to the network. This network connection also enables you to share data and printers or other devices among your computers. The network connection to the Internet is usually through a dial-up or cable modem.

A *wired network* uses Ethernet cables to connect the devices on the network. For example, the Ethernet cable plugs into the computer network interface adapter and the router.

A *wireless network* uses radio waves to connect the devices on the the network. For example, both the computer and the router have an antenna and adapter that use the same Wi-Fi industry standard: 802.11n, 802.11b, 802.11g, or 802.11a.

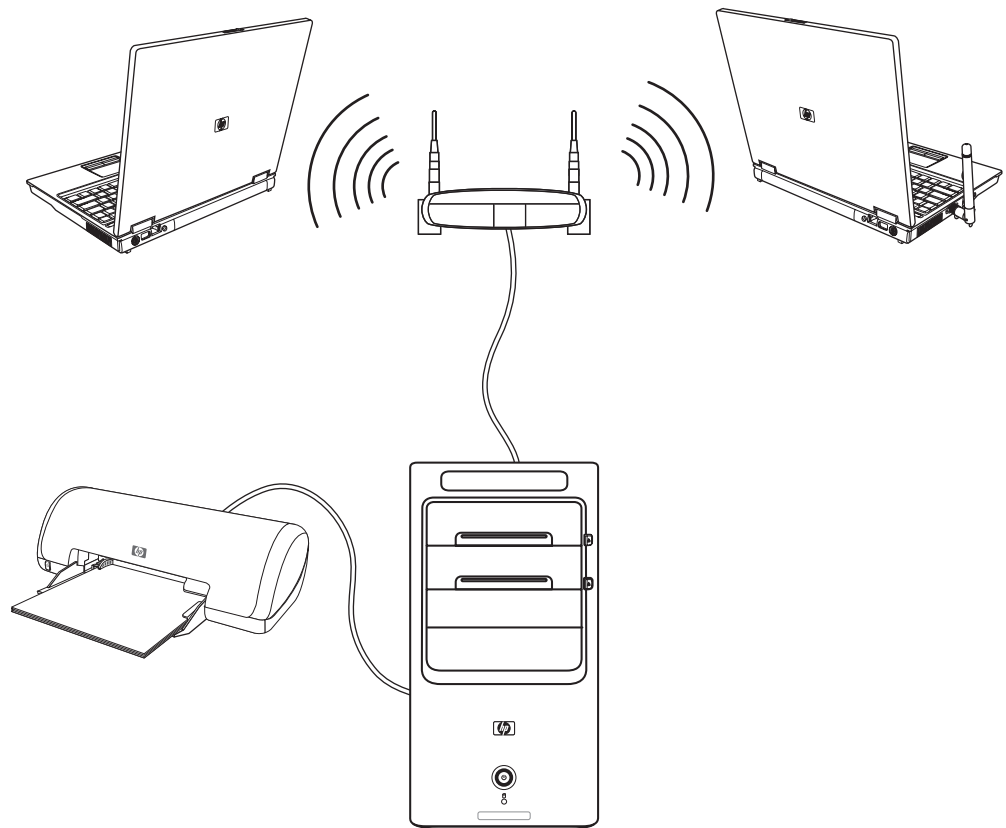

The preceding illustration shows a home LAN. The desktop computer has a wired connection to a wireless router. The desktop computer also has a printer that it shares with the other computers on the network. Each notebook computer has a wireless connection to the network router.

Setting Up a Wired (Ethernet) Connection

The *Ethernet* connection, which may be called network interface adapter, Network Interface Card, or NIC, provides a high-speed or broadband connection to an Ethernet (10BaseT) or Fast Ethernet (100BaseT) network. After you connect this interface to a network, such as a LAN, you can connect to the Internet through the network.

- 1 Connect an Ethernet cable to the Ethernet connector (**A**) on the back of the computer, and to the network router or LAN device.

NOTE: Your computer may not come with an Ethernet connector.

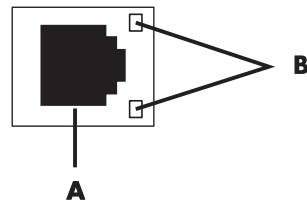

- A** Ethernet connector (RJ-45 port)
B Ethernet indicator lights

- 2 With the computer turned on, check the indicator lights (**B**) next to the Ethernet connector for the status:
 - **ACTIVITY** — Lit yellow during network data transfer activity
 - **LINK** — Lit green when there is a valid network connection

NOTE: Your Ethernet connector may have only one indicator light.

Integrated Wireless Devices

Wireless technology transfers data across radio waves instead of wires. Your computer may be equipped with one or more of the following integrated wireless devices:

- **Wireless local area network (WLAN) devices** connect the computer to wireless local area networks (commonly referred to as wireless networks, wireless LANs, or WLANs) in corporate offices, your home, and public areas such as airports and restaurants. In a WLAN, each mobile wireless device communicates with a wireless access point, which can be several hundred feet away.

Computers with WLAN devices may support one or more of the four IEEE physical layer industry standards: 802.11n, 802.11b, 802.11g, or 802.11a.

- **Bluetooth devices** create a personal area network (PAN) to connect to other Bluetooth-enabled devices such as computers, phones, printers, headsets, speakers, and cameras. In a PAN, each device communicates directly with the other devices, and the devices must be relatively close together—within 33 feet (10 meters) of each other.

- **Wireless wide area network (WWAN) devices** provide access to information anytime and anywhere that you have cellular (data) coverage. In a WWAN, each mobile device communicates to a public carrier's base station. Public carriers install networks of base stations (similar to cell phone towers) throughout large geographic areas, effectively providing coverage across entire states, or even entire countries/regions.

For more information about wireless technology, go to:
<http://www.hp.com/go/techcenter/wireless>

Connecting the Wireless LAN Device

(Select models only)

You can connect the computer to an 802.11n (select models only), 802.11b or 802.11g wireless network by using the external antenna that was included with the system. This device enables you to establish a wireless network using the computer as a wireless access point, or you can use the computer as a wireless client (Station Mode) if you already have a wireless network running.

You need an existing wireless LAN with an Internet connection (consult your Internet Service Provider for further information). An external antenna is supplied with the system; you must connect it to the 802.11 module to increase the range and sensitivity of the radio.

To connect the wireless LAN antenna:

- 1 Screw the wireless LAN antenna cable into the wireless LAN connector on the back of the computer.
- 2 For the best wireless performance, place the antenna on the computer or in an elevated and open area.

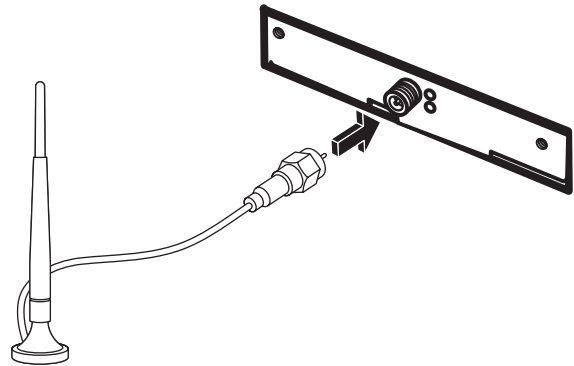

Checking the wireless LAN device installation

To set up your wireless network, verify that the integrated WLAN device is installed on the computer correctly:

- 1 Click the **Windows Start Button**  on the taskbar.
- 2 Type *Device Manager* into the Start Search box, and then click **Device Manager** to open the Device Manager window.
- 3 Click **Network adapters**. Your WLAN device should be listed here. The WLAN device may include the term *wireless*, *wireless LAN*, or *802.11*.

NOTE: If no WLAN device is listed, either the computer does not have an integrated WLAN device, or the driver for the device is not properly installed.

- 4 Click the **Windows Start Button**  on the taskbar.
- 5 Type *Network and Sharing Center* into the Start Search box, and then click **Network and Sharing Center** to open the Network and Sharing Center window.
- 6 Click **Connect to a network**, and then follow onscreen instructions.

For more information about setting up a wireless network:

- Click the **Windows Start Button**  on the taskbar, click **Help and Support**, and then type *Setting up a wireless network* into the Search Help box.
- Go to: <http://www.hp.com/go/techcenter/wireless> (English only).
- Go to: <http://hp.com/support> and search for wireless topics.

Using wireless security features

When you set up a home WLAN or access an existing public WLAN, always enable security features to protect the network from unauthorized access. The most common security levels are Wi-Fi Protected Access Personal (WPA-Personal) and Wired Equivalent Privacy (WEP).

When setting up a network, HP recommends that you use one or more of the following security measures:

- Enable WPA-Personal or WEP security encryption on the router.
- Change the default network name (SSID) and password.
- Set up a firewall.
- Set security on your Web browser.

For more information about setting up wireless security features, go to:
<http://www.hp.com/go/techcenter/wireless>

Connecting a Modem

For information on connecting to the Internet, see “Connecting to the Internet” in the *Getting Started* guide.

Connecting Speakers or Microphone

Speakers are included with the monitor (select models only), or they are sold separately.

For details about connecting stereo speakers to the computer, see the setup poster.

If the computer has multichannel audio speaker capacity (select models only), you can connect four channels for four-speaker output, or six channels for 5.1 speaker output.

Connect the speaker system to the computer, and then configure the audio software for sound output.

Sound Connector Types

Your model may include one of three analog sound connector types on the back of the computer:

- Three connectors
- Six connectors
- Audio card



The connectors are 3.5 mm (1/8-inch) stereo mini-jacks that connect from the back of the computer to speakers and microphones.

Your system may also have a separate Digital Out connector (select models only).

Software configuration is different for each connector type, as noted in the instructions.

NOTE:

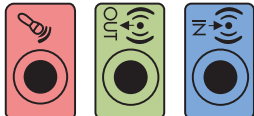
- Type 3 has three connectors.
- Type 6 has six connectors.
- Type S has audio card.

Sound connector	Illustration	Type
Three connectors Your computer model may include three sound connectors. You can connect up to a 5.1 audio system to the computer.		3
Six connectors Your computer model may include six sound connectors on the back of your computer. You can connect up to a 7.1 audio system to the computer.		6
Audio card connector Your computer may include a audio card. You can connect up to a 5.1 audio system (7.1 audio system for select models) or digital speakers to the audio card on the computer.	See the following illustrations.	S

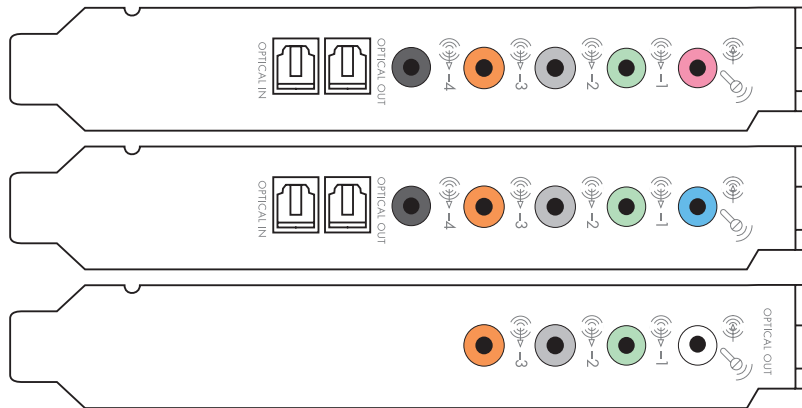



When installing cables, use the sound connectors that match your computer model, as shown in the installation procedure steps.

The following table shows the sound connectors on the back panel of computer systems.

Sound connector			Description
Type 3	Type 6	Type 5	
			Line Side (gray) connects to side left and right analog speakers in an eight-speaker system (7.1).
			Line C/Sub (gold) connects to front center/subwoofer speakers in a multichannel audio configuration.
			Line Rear (black) connects to rear left and right analog speakers in a multichannel audio configuration.
			Line Out (lime green) connects to front left and right analog speakers.
			Mic (pink) connects to a microphone. (Type 3 also functions as center/subwoofer Line Out when a multichannel audio configuration is enabled.)
			Line In (light blue) connects to an analog audio device such as a CD player for input into computer. (Type 3 also functions as rear Line Out when a multichannel audio configuration is enabled.)
			Digital Audio Out or SPDIF Out (orange) connects to a digital audio device with digital input (such as a home audio receiver/amplifier) or to digital speakers (select models only).
			FlexiJack (pink) connects to analog Line In devices or a microphone. The FlexiJack supports two functions. You must select either the microphone or the Line In function in the Creative Console Launcher. See "Configuring the FlexiJack connector" in the <i>Getting Started</i> guide.

Sound connector (continued)

Type 3	Type 6	Type S	Description
			FlexiJack (blue) connects to analog Line In devices or a microphone. The FlexiJack supports two functions. You must select either the microphone or the Line In function in the Creative Console Launcher. See “Configuring the FlexiJack connector” in the <i>Getting Started</i> guide.
			Optical In (optical SPDIF input) connects recording devices such as a mini disc recorder, digital audio tape recorder, or external hard disk recorder.
			Optical Out (optical SPDIF output) connects playback devices such as a mini disc player, digital audio tape player, or DVD player.

NOTE:

- Type 3 has three connectors.
- Type 6 has six connectors.
- Type S has audio card.

Connecting a Microphone

Your computer comes with one microphone connector in the back of the computer. Some models have a second microphone connector in the front of the computer. Only one microphone connector works at a time, and the back connector is ready to use unless you have the multichannel audio speakers option. For computers with the multichannel audio speakers option, the microphone connector in the front of the computer, if present, is ready to use.

To use a microphone connected to the front of your computer (select models only), select the working microphone. See “Selecting a microphone” in the *Getting Started* guide.

HP computers support many different audio options, sound connections, and speaker configurations. You may set up your computer for two stereo speakers or for multichannel audio speaker systems. Connect your speaker system to the computer, and then configure the audio software for sound output. For more details about connecting stereo speakers to the computer, see the setup poster.

This chapter describes the most typical options. Your system may have different components.

Speakers are included with the monitor (select models only) or are sold separately.

NOTE: For additional information on connecting the speakers, refer to the setup poster that came with the computer and the documentation that came with your speakers.

Speaker Configurations

You may set up your computer for the following supported configurations:

Name	Speaker system	See
2 (stereo)	Left speaker, right speaker.	"Connecting 2/2.1 (Two speakers and a subwoofer) audio speakers."
2.1	Left speaker, right speaker, and a subwoofer.	"Connecting 2/2.1 (Two speakers and a subwoofer) audio speakers."
4.1	Two front speakers, two rear speakers, and a subwoofer.	"Connecting 4.1 (Four speakers and a subwoofer) audio speakers."
6/5.1	Two front speakers, two rear speakers, a center speaker, and a subwoofer.	"Connecting 5.1 (Five speakers and a subwoofer) audio speakers."
8/7.1	Two front speakers, two rear speakers, two side speakers, a center speaker, and a subwoofer (select models only).	"Connecting 7.1 (Seven speakers and a subwoofer) audio speakers."
Home audio system	Home stereo or home theater audio system with passive speakers.	"Connecting your home stereo system (optional)."
Digital audio	Digital speakers or digital input connector on audio system.	"Connecting digital audio."
Multistreaming audio	Two front speakers, two rear speakers, two side speakers, a center speaker, and a subwoofer (select models only).	See "Configuring multistreaming audio" in the <i>Getting Started</i> guide.

Speaker types

Speakers may be included with the monitor (select models only) or are sold separately. Refer to the product documentation for your speakers.

Your computer supports only an active (powered) speaker system. An active speaker system must have its own power cord. A home audio system does not require active speakers, because the receiver provides amplification.

A stereo speaker set is a left-right, two-channel speaker system. A multichannel audio speaker system has a left-right front and left-right rear channel, and it may include a subwoofer and a center speaker. Side speakers are included in more advanced systems. A subwoofer provides enhanced bass sounds.

".1" indicates a subwoofer. For example, 7.1 channels refers to an eight-speaker mode and uses two front speakers (left-right), two side speakers (left-right), two rear speakers (left-right), a center speaker, and a subwoofer.

Connecting 2/2.1 (Two speakers and a subwoofer) audio speakers

To connect simple left/right stereo active speakers or two speakers and a subwoofer for two-channel (2.1 speaker) output:

- 1 Turn off the computer.
- 2 Connect the speaker cable to the lime green Audio Line Out connector that matches the back of your computer.

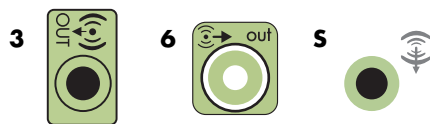

NOTE:

- Type 3 is three connectors.
- Type 6 is six connectors.
- Type S is sound card.

-
- 3 Connect the cable to the audio system. For 2.1 speakers that were shipped with your computer (select models only), connect the Audio Line Out connector to the subwoofer.
 - 4 Connect the left and right speakers to the subwoofer. Refer to the speaker documentation.
 - 5 Turn on the computer.

NOTE: Always turn on the computer before you turn on the speaker system.

- 6 Plug in the speaker system power.
- 7 Turn on the speaker system.

Step 8 is optional for a two-speaker setup.

- 8 After the speakers are connected to the computer, configure the audio software for sound output for your computer model. See “Connecting Speakers or Microphone.”
 - Type 3: See “Configuring speakers with Realtek HD Audio Manager” in the *Getting Started* guide.
 - Type 6: See “Configuring speakers with Realtek HD Audio Manager” in the *Getting Started* guide.
 - Type S (audio card): See “Using the Creative Sound Blaster X-Fi or X-Fi Fatality audio card” in the *Getting Started* guide.

The following diagram shows a typical 2.1 audio installation:

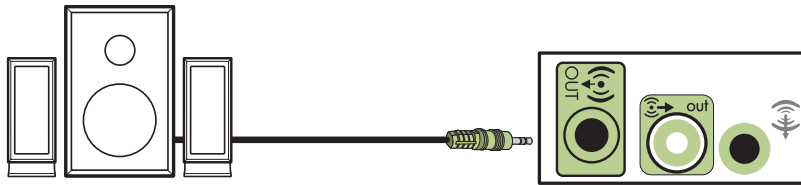

Connecting 4.1 (Four speakers and a subwoofer) audio speakers

To connect two front speakers, two rear speakers, and a subwoofer for four-channel (4.1 speaker) output:

- 1 Turn off the computer.
- 2 Connect the front speaker cable to the lime green Audio Line Out connector that matches the back of your computer.

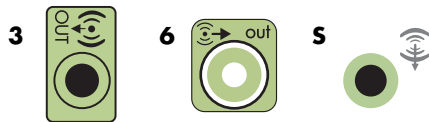

NOTE:

- Type 3 is three connectors.
 - Type 6 is six connectors.
 - Type S is sound card.
-

- 3 Connect the rear speaker cable to the black connector that matches the back of your computer.



For type 3-connector systems, the blue Audio Line In connector functions as a Rear Line Out when a multichannel audio configuration is activated.

- 4 Connect the cables to the audio system.
- 5 Connect the front and rear speakers to the subwoofer. Refer to the speaker documentation.
- 6 Turn on the computer.

NOTE: Always turn on the computer before you turn on the speaker system.

- 7 Plug in the speaker system power.
- 8 Turn on the speaker system.
- 9 After the speakers are connected to the computer, configure the audio software for sound output for your computer model. See "Configuring Speaker and Sound Options" in the *Getting Started* guide.
 - Type 3: See "Configuring speakers with Realtek HD Audio Manager" in the *Getting Started* guide.
 - Type 6: See "Configuring speakers with Realtek HD Audio Manager" in the *Getting Started* guide.
 - Type S (audio card): See "Using the Creative Sound Blaster X-Fi or X-Fi Fatality audio card" in the *Getting Started* guide.

The following diagram shows a typical 4.1 audio installation:

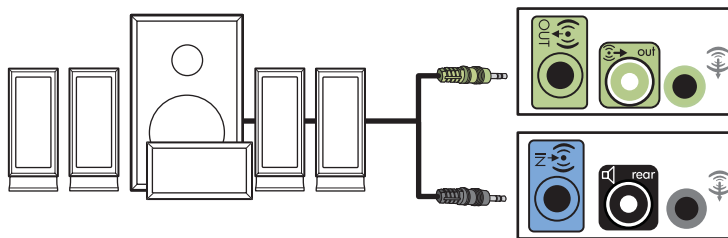

Connecting 5.1 (Five speakers and a subwoofer) audio speakers

To connect two front speakers, two rear speakers, a center speaker, and a subwoofer for six-channel (5.1 speaker) output:

- 1 Turn off the computer.
- 2 Connect the front speaker cable to the lime green Audio Line Out connector that matches the back of your computer.

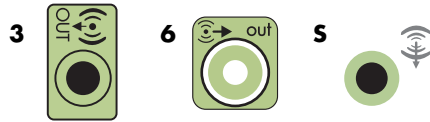

NOTE:

- Type 3 is three connectors.
- Type 6 is six connectors.
- Type S is sound card.

- 3 Connect the rear speaker cable to the black connector that matches the back of your computer.



For type 3-connector systems, the blue Audio Line In connector functions as a Rear Line Out when a multichannel audio configuration is activated.

- 4 Connect the center/subwoofer speaker cable to the gold (or pink Mic) connector that matches the back of your computer.



For type 3-connector systems, the pink Mic connector functions as a center/subwoofer speaker Line Out when a multichannel audio configuration is activated.

- 5 Connect the cables to the audio system.
- 6 Connect the front, rear, and center speakers to the subwoofer. Refer to the speaker documentation.
- 7 Turn on the computer.

NOTE: Always turn on the computer before you turn on the speaker system.

- 8 Plug in the speaker system power.
- 9 Turn on the speaker system.
- 10 After the speakers are connected to the computer, configure the audio software for sound output for your computer model. See "Configuring Speaker and Sound Options" in the *Getting Started* guide.
 - Type 3: See "Configuring speakers with Realtek HD Audio Manager" in the *Getting Started* guide.
 - Type 6: See "Configuring speakers with Realtek HD Audio Manager" in the *Getting Started* guide.
 - Type 6 – multistreaming: See "Configuring multistreaming audio" in the *Getting Started* guide.
 - Type S (audio card): See "Using the Creative Sound Blaster X-Fi or X-Fi Fatality audio card" in the *Getting Started* guide.

The following diagram shows a typical 5.1 audio installation:

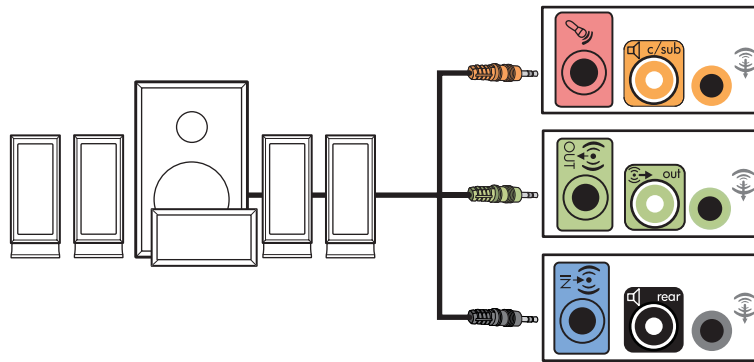

Connecting 7.1 (Seven speakers and a subwoofer) audio speakers

(Select models only)

To connect two front speakers, two side speakers, two rear speakers, a center speaker, and a subwoofer for eight-channel (7.1 speaker) output:

- 1 Turn off the computer.
- 2 Connect the front speaker cable to the lime green Audio Line Out connector on the back of your computer.



- 3 Connect the rear speaker cable to the black Audio Line Rear connector on the back of your computer.



- 4 For type 6 connectors only, connect the side speaker cable to the gray Audio Line Side connector on the back of your computer.



- 5 Connect the center speaker and subwoofer speaker cable to the gold Audio Line C/ Sub connector on the back of your computer.



- 6 Connect the cables to the audio system.
- 7 Connect the front, rear, side, and center speakers to the subwoofer. Refer to the speaker documentation.
- 8 Turn on the computer.

NOTE: Always turn on the computer before the speaker system.

- 9 Connect the speaker system to the power.
- 10 Turn on the speaker system.
- 11 After the speakers are connected to the computer, configure the audio software for sound output for your computer model.
 - Type 6 — multistreaming: See “Configuring multistreaming audio” in the *Getting Started* guide.

The following diagram shows a typical 7.1 audio installation.

	Color	Description
1	Lime green	Front audio input
2	Black	Rear audio input
3	Orange	Center/subwoofer audio input
4	Gray	Side audio input (not shown)

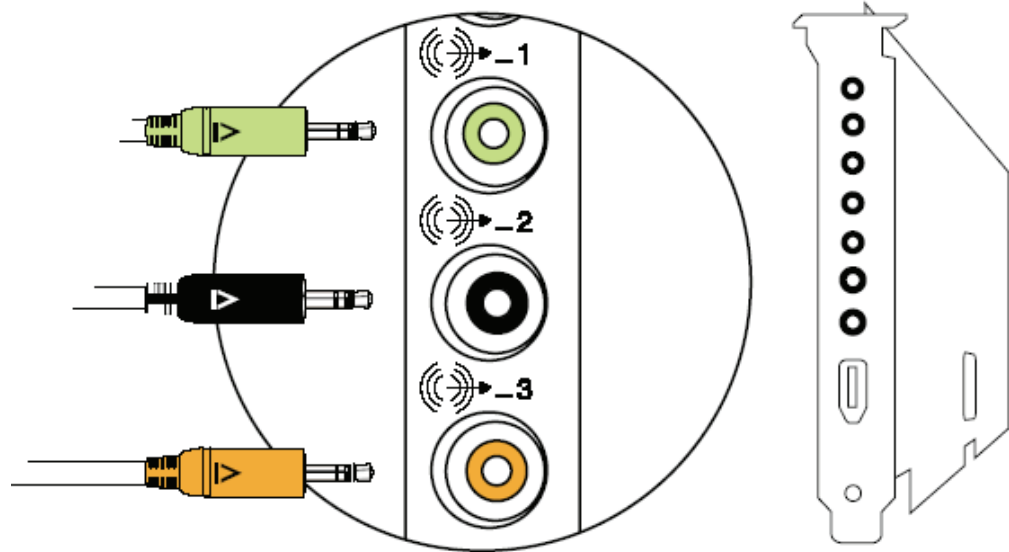

Connecting your home stereo system (optional)

Most home receivers/amplifiers have RCA-type input connectors. You must connect Y adapter cables between your computer and your receiver/amplifier. Y adapter cables have one 3.5 mm (1/8-inch) stereo mini-jack on one end, and two RCA connectors on the other. These cables are purchased separately.

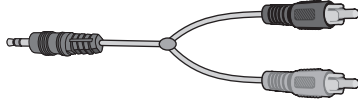

The number of Y adapter cables that you need to connect to your home stereo system depends on the number of speakers that you install:

- 2/2.1 speaker system: One Y adapter cable
- 4/4.1 speaker system: Two Y adapter cables
- 6/5.1 speaker system: Three Y adapter cables
- 8/7.1 speaker system: Four Y adapter cables

Connecting a home stereo system to a computer requires audio cables that are long enough to reach from the computer to the stereo. You also must purchase Y adapter or mini-extension cables.

NOTE: Y adapter and mini-extension cables are purchased separately.

2.1 home stereo installation

The following diagram shows a typical two-channel (2.1 speaker) installation that uses passive stereo speakers and plugs into a home stereo standard left and right input.

This is only a suggested configuration. Your system may be different.

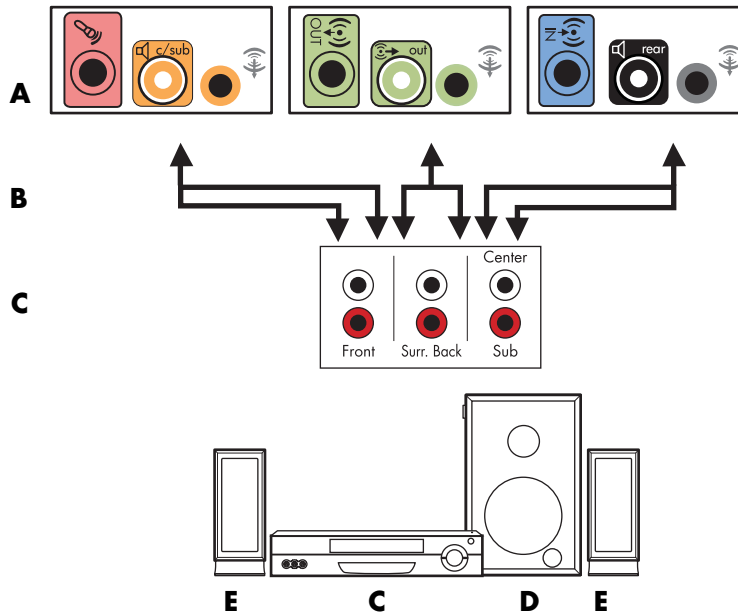

Computer to 2.1 multichannel audio system connection

- A** Computer back-panel connectors (type 3, type 6, or sound card)
- B** Y adapter cables
- C** Receiver/amplifier (audio input jacks)
- D** Subwoofer
- E** Front speakers (left and right)

5.1 home audio installation

The following diagram shows a typical advanced home theater audio six-channel (6/5.1 speaker) installation that requires multichannel inputs on a receiver/amplifier. This is only a suggested configuration. Your system may be different.

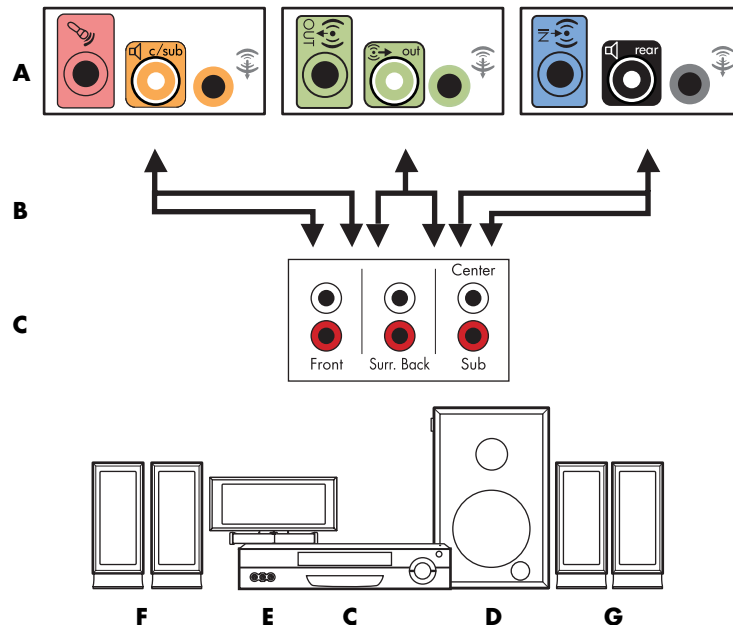

Computer to 5.1 multichannel audio system connection

- A Computer back-panel connectors (type 3, type 6, or sound card)
- B Y adapter cables
- C Receiver/amplifier (audio input jacks)
- D Subwoofer
- E Center speaker
- F Front speakers (left and right)
- G Rear speakers (left and right)

5.1 home audio installation procedure

To connect a six-channel (5.1 speaker) home audio system to the computer:

- 1 Turn off the computer.
- 2 Turn off the receiver/amplifier.

- 3 Connect the front stereo mini-jack end of a Y adapter cable into the lime green Audio Line Out connector that matches the back of your computer.

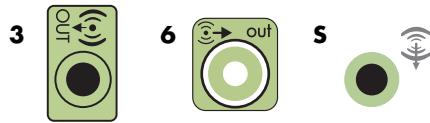

NOTE:

- Type 3 is three connectors.
 - Type 6 is six connectors.
 - Type S is sound card.
-

NOTE: Receiver/amplifier input connectors may be labeled Surround, 5.1 Channel inputs, 6 Channel inputs, CD, DVD, or DVD In.

Connect the left and right ends of the Y adapter cable into the front left (L) and right (R) inputs on the back of the receiver/amplifier.

- 4 If you have rear speakers, connect the rear stereo mini-jack end of a Y adapter cable into the Audio Line In (blue) or the Rear Speaker Out (black) connector that matches the back of your computer.



- Connect the left and right ends of the Y adapter cable into the rear left (L) and right (R) inputs on the back of the receiver/amplifier.
- 5 If you have a center/subwoofer speaker, connect the stereo mini-jack of a Y adapter cable into the microphone (pink) connector or the center speaker/subwoofer (gold) connector that matches the back of your computer.



- Connect the left and right ends of the Y adapter cable into the center/subwoofer inputs on the back of the receiver/amplifier (6/5.1 or higher-channel system).
 - Plug the Y adapter cable into the subwoofer connector on the back of the receiver even if a subwoofer is not used.
- 6 Turn on the receiver/amplifier.
 - 7 Select the receiver/amplifier input that the Y adapter cables are plugged into.
 - 8 Turn on the computer.

- 9 After the audio system is connected to the computer, configure the audio software for sound output for your computer model. See “Connecting Speakers or Microphone.”
- Type 3: See “Configuring speakers with Realtek HD Audio Manager” in the *Getting Started* guide.
 - Type 6: See “Configuring speakers with Realtek HD Audio Manager” in the *Getting Started* guide.
 - Type S (audio card): See “Using the Creative Sound Blaster X-Fi or X-Fi Fatality audio card” in the *Getting Started* guide.

7.1 home audio installation

The following diagram shows a typical advanced home theater system with an eight-channel 8/7.1 speaker installation that requires multichannel inputs on a receiver/amplifier.

This is only a suggested configuration. Your system may be different.

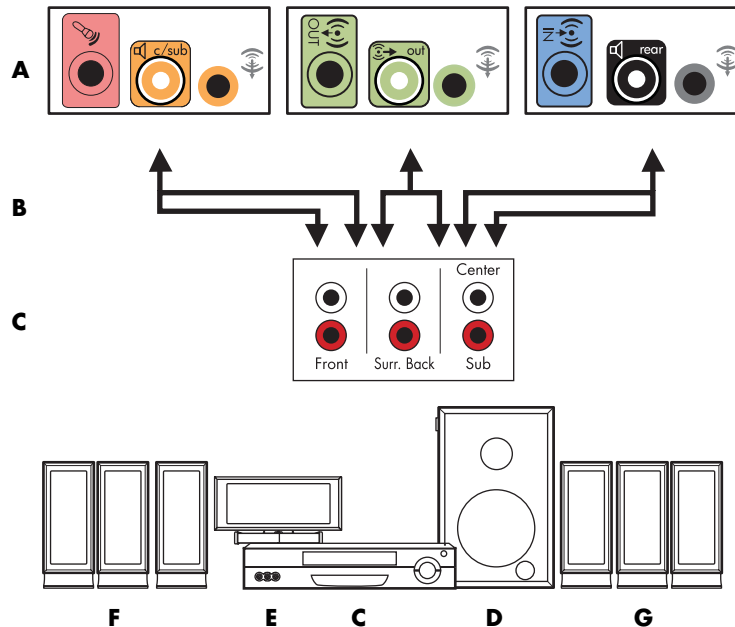

Computer to 7.1 multichannel audio system connection

- A Computer back-panel connectors (type 3, type 6, or type S)
- B Y adapter cables
- C Receiver/amplifier (audio input jacks)
- D Subwoofer
- E Center speaker
- F Front speakers (left and right)
- G Rear speakers (left and right)

7.1 home audio installation procedure

To connect an eight-channel (7.1 speaker) home audio system to the computer:

- 1 Turn off the computer.
- 2 Turn off the receiver/amplifier.
- 3 Connect the front stereo mini-jack end of a Y adapter cable into the lime green Audio Line Out connector on the back of your computer.

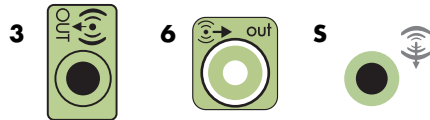

NOTE:

- Type 3 has three connectors.
- Type 6 has six connectors.
- Type S has audio card.

NOTE: Receiver/amplifier input connectors may be labeled Surround, 7.1 Channel inputs, 6 Channel inputs, CD, DVD, or DVD In.

Connect the left and right ends of the Y adapter cable into the front left (L) and right (R) inputs on the back of the receiver/amplifier.

- 4 If you have rear speakers, connect the rear stereo mini-jack end of a Y adapter cable into the Audio Line In (light blue) or the Rear Speaker Out (black) connector on the back of your computer.



Connect the left and right ends of the Y adapter cable into the rear left (L) and right (R) inputs on the back of the receiver/amplifier.

- 5 If you have a center/subwoofer speaker, connect the stereo mini-jack of a Y adapter cable into the microphone (pink) connector or the center speaker/subwoofer (gold) connector on the back of your computer.

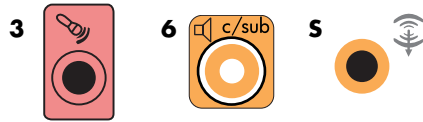

Connect the left and right ends of the Y adapter cable into the center/subwoofer inputs on the back of the receiver/amplifier (8/7.1 or higher-channel system).

Connect the Y adapter cable to the subwoofer connector on the back of the receiver, even if you are not using a subwoofer.

- 6 Turn on the receiver/amplifier.
- 7 Select the receiver/amplifier input to which the Y adapter cables are connected.
- 8 Turn on the computer.
- 9 After the audio system is connected to the computer, configure the audio software for sound output for your computer model. See “Configuring Speaker and Sound Options” in the *Getting Started* guide.
 - Type 3: See “Configuring speakers with Realtek HD Audio Manager” in the *Getting Started* guide.
 - Type 6: See “Configuring speakers with Realtek HD Audio Manager” in the *Getting Started* guide.
 - Type S (audio card): See “Using the Creative Sound Blaster X-Fi or X-Fi Fatality audio card” in the *Getting Started* guide.

Connecting digital audio

(Select models only)

If you have an audio card and you are connecting your home stereo AV receiver via digital out, connect the 3.5 mm (1/8-inch) stereo plug to the Digital Audio Out connector on the audio card. Connect the red RCA stereo plug on the 3.5 mm (1/8-inch) Y adapter cable to the AV receiver’s digital input connector on the AV receiver. If the red RCA stereo plug does not work, try the white stereo plug. Only one of the connectors is needed.

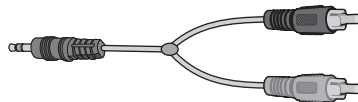

To connect digital audio, your computer must include a Digital Audio Out connector on either the audio card or the back panel. You must connect multichannel speaker outputs if you connect the digital output.

To connect digital audio speakers:

- 1 Turn off the computer.
- 2 Connect the orange Digital Audio Out connector on the back panel of your computer to the digital input (S/PDIF) on the digital speakers or a digital audio system.
- 3 Turn on the computer.

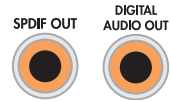

NOTE: Always turn on the computer before the speaker system.





- 4 Connect the speaker system to the power.
- 5 Turn on the speaker system.
- 6 After the speakers are connected to the computer, configure the audio software for sound output for your computer model. See “Configuring Speaker and Sound Options” in the *Getting Started* guide.
 - Audio card with digital output and type 3 connectors: See “Configuring speakers with Realtek HD Audio Manager” in the *Getting Started* guide. Follow the instructions to enable digital audio output.
 - Audio card with digital output and type 6 connectors: See “Configuring speakers with Realtek HD Audio Manager” in the *Getting Started* guide. By default, digital audio output is already enabled.
 - Audio card: See “Using the Creative Sound Blaster X-Fi or X-Fi Fatality audio card” in the *Getting Started* guide. Follow the instructions to enable digital audio output.

Connecting Speakers Using the Creative Sound Blaster X-Fi Sound Card

This section provides an overview of connecting to the Creative Sound Blaster X-Fi sound card.

NOTE: For additional information on connecting the speakers, refer to the documentation that came with your speakers.

Connecting the speakers

Connector	Description
 AD_LINK	AD-Link for AD_Link X-Fi I/O Console (the X-Fi console is sold separately)
 3	Line Out_3 (orange or yellow) 5.1 audio setup: Front center, subwoofer 6.1 audio setup: Front center, subwoofer, and rear center 7.1 audio setup: Front center, subwoofer, and side left
 2	Line Out_2 (black) 4.1, 5.1, 6.1 audio setup: Rear left and right 7.1 audio setup: Rear left, rear right, and side right
 1	Line Out_1 (lime green) 2/2.1 audio setup: Front left and right
 OR DIGITAL_IO	FlexiJack (white) for Line In, Microphone, Digital In/Out The FlexiJack supports three functions. You must select the function in the Creative Console Launcher. See "Connecting the FlexiJack connector."

To connect the X-Fi sound card to your speakers:

- 1 Use the audio connection table to connect your audio system to the sound card.
- 2 Turn on the computer.
- 3 Plug in and turn on the speaker system power.

After connecting the speaker system to the sound card, follow the steps in “Configuring the FlexiJack connector” in the *Getting Started* guide to configure the speaker settings in the Creative Sound Blaster X-Fi software.

Connecting the FlexiJack connector

The FlexiJack connector performs three functions:

- Digital Input/Output
- Line In
- Microphone

You must select the function in the Creative Console Launcher.

NOTE: If you are using the FlexiJack as your Digital In connection and you want to connect digital speakers as your output device, you will need a special connector from Creative.

Connecting the Television Signal and Video Cables

This section describes how to connect the computer to the television and which cables to use.

NOTE: Some graphic cards have a DVI connector and a DVI-to-VGA converter included in the box (select models only). If the monitor has a VGA connector but no DVI connector, use the DVI-to-VGA converter to connect to the computer: Connect the DVI-to-VGA converter to the DVI connector on the computer graphic card, and then connect the VGA cable to the converter and to the monitor.

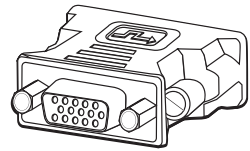

Using TV Cables

The computer includes video and audio cables to connect the television signals.

Use the video and audio cables to connect:



- Video out from the computer to the TV.
- TV signal source video in to the computer.
- Audio out from the computer to the TV.
- TV signal source audio in to the computer.



NOTE: The location and number of connectors may vary by model.

Audio and Video Cables and Adapters

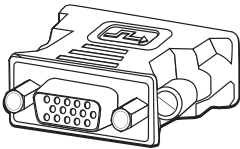
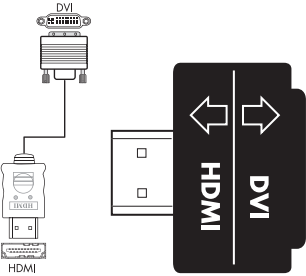
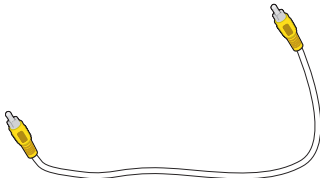
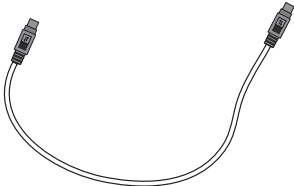
The following table shows the cable and adapter types that may be required to connect the computer to the television system.

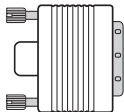
NOTE: The number and type of cables required to connect the computer may vary by model. Some cables are included for select models only.

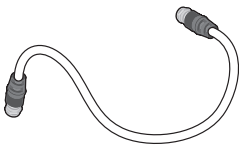
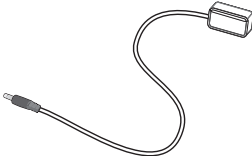
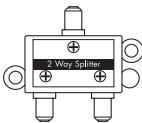
Cable	Name	Description
	DVI-to-VGA adapter	Connects a DVI monitor to a VGA connector on the computer or connects a VGA monitor to a DVI connector on the back of the computer.
	DVI-to-HDMI cable or adapter	Connects a DVI monitor to an HDMI connector on the computer or connects an HDMI monitor to a DVI connector on the back of the computer. This allows the graphic card driver to transfer HDMI signals to a monitor or a TV display.
	Composite video cable	RCA yellow end. Plugs into an RCA connector such as Composite Video Out or TV Source In.
	S-video cable	Y/C, 4-pin. Plugs into an S-video connector such as S-video Video Out or TV Source In. Delivers a sharper image than composite video cable by providing separate color and black-and-white image signals.
	Analog video cable/adapter (select models only)	Used with analog video output connector. Provides S-video and composite video output.
	DVI-I or DVI-D cable	Digital Video Out. Plug into a DVI-I or DVI-D input of an HDTV-capable TV or monitor.

Cable	Name	Description (continued)
	TV coaxial cable	Plugs into a TV signal source input connector from cable set-top boxes or antennas.
	Remote Infrared (IR) cable (Infrared transmitter)	Controls TV signal source from set-top box.
	Splitter	Connects one signal source to two RF inputs on the computer.
	RCA stereo	RCA red and white ends. Connects TV signal source Audio In and Audio Out connectors to TV.

You may need to purchase extra cables separately. Your computer may not include all the cables you need for the computer setup, and the cables included may vary by model.

For example, if the TV has an S-video input connector, you may want to use an S-video cable to connect the TV-out on the computer to the TV.

Connecting the TV Signal Source

Connect the signal source for the TV by using the TV In coaxial connector or the S-video or composite video In connector.

NOTE: The location and number of connectors may vary by model.

- 1 Plug the connector of a coaxial cable from the TV cable into the TV/Cable Ant connector on the back of the computer, and then turn the connector to tighten it.

Or

Plug a cable into the S-video or composite video In connector on the back of the computer; use an S-video cable (not provided) or the composite video cable. Plug the other end of the cable into the set-top box or other device that is providing the signal source for the TV.

- 2 If you are using a set-top box with S-video or composite video output, plug audio cables (not provided) from the set-top box into the Audio In right (red) connector and the Audio In left (white) connector on the back of the computer.

If you are using a set-top box, connect the Remote Emitter cable. See “Connecting the Remote Sensor.”

Connecting a dual tuner

(Select models only)

NOTE: The Television (Electronic) Program Guide is not available in all countries/regions.

The computer records television programs and enables you to control the television channels. The computer supports two tuner configurations:

TV tuner	Description	Requirements
Single-tuner TV source	Watch or record only one program in the NTSC or PAL format.	<ul style="list-style-type: none">■ If you are using a TV antenna or standard cable connector, the signal is routed to a single tuner.
Dual-tuner TV source	Watch a show on one channel while Windows Media Center records another show on a different channel. You can also record two different programs at the same time.	<ul style="list-style-type: none">■ If you are using a TV antenna or standard cable connector, the signal is routed to both tuners internally.■ If you are using a cable or satellite set-top box, you must connect a second set of inputs. Otherwise, connect a second set-top box to the second set of back-panel connectors.■ TV sources must be of the same type: either cable TV, digital cable TV, satellite TV, or antenna.■ TV sources must also have the same, identical channel lineups; for example, if you are using two satellite TV sources, they must provide exactly the same channels.■ All TV viewing and scheduling is provided through the Television (Electronic) Program Guide in Windows Media Center, so both TV sources must have identical Television Program Guides.

Connecting the Remote Sensor

The remote sensor is a small device that connects to the computer and enables the remote control to work with the Windows Media Center program.

- 1** If you have a cable TV set-top box, a satellite set-top box, or another set-top box that controls the TV signal, connect the remote control sensor cable (emitter) **(A)** to connector **(1)** on the back of the remote sensor; otherwise, skip to step 3. If you have a second set-top box, you can also use connector **(2)**.
- 2** Remove the paper from the backing tape on the end of the cable **(B)**, and then press the end of the cable over the remote infrared (IR) receiver window on the cable TV set-top box **(C)**. To locate the remote IR receiver window on the cable TV set-top box, use a flashlight to shine through the plastic on the front of most devices.
- 3** Plug the remote control sensor cable into a USB connector **(D)** on the back of the computer.
- 4** Place the remote sensor so that you can easily point at it with the remote control. (An ideal spot would be on top of the monitor or desk.)

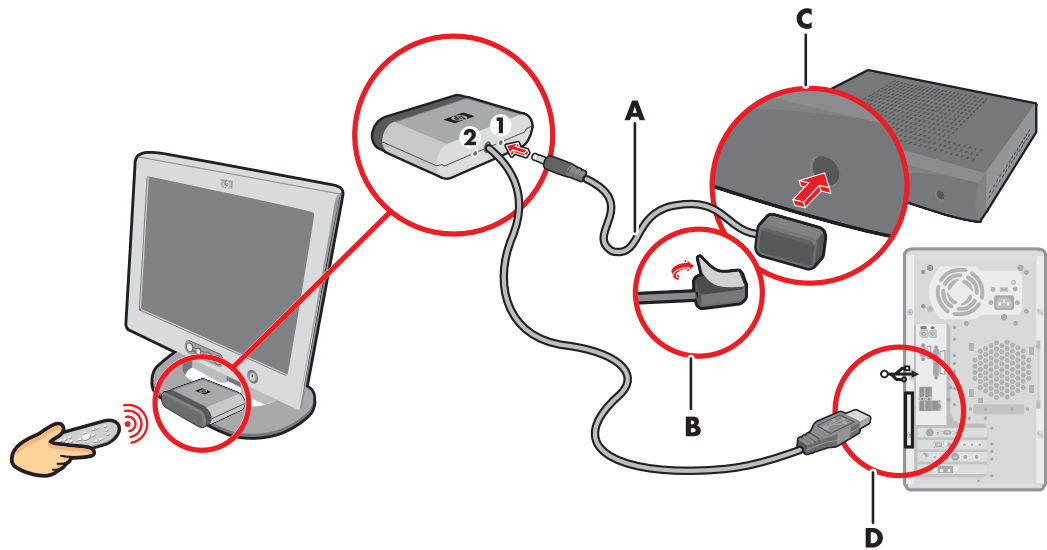

Connecting the TV Signal Source When You Have an Existing Setup

This section describes how to connect the computer to an existing setup for the TV signal source.

Wall to VCR to TV, using coaxial cable

- 1 Disconnect the coaxial cable from the input to the VCR, and connect it to the input of a coaxial cable signal splitter (not included; available at electronics stores).
- 2 Connect two coaxial cables to the splitter outputs.
- 3 Connect one of these cables to the input of the VCR, and the other cable to the TV connector on the back of the computer.

Existing setup Setting up the computer with a splitter

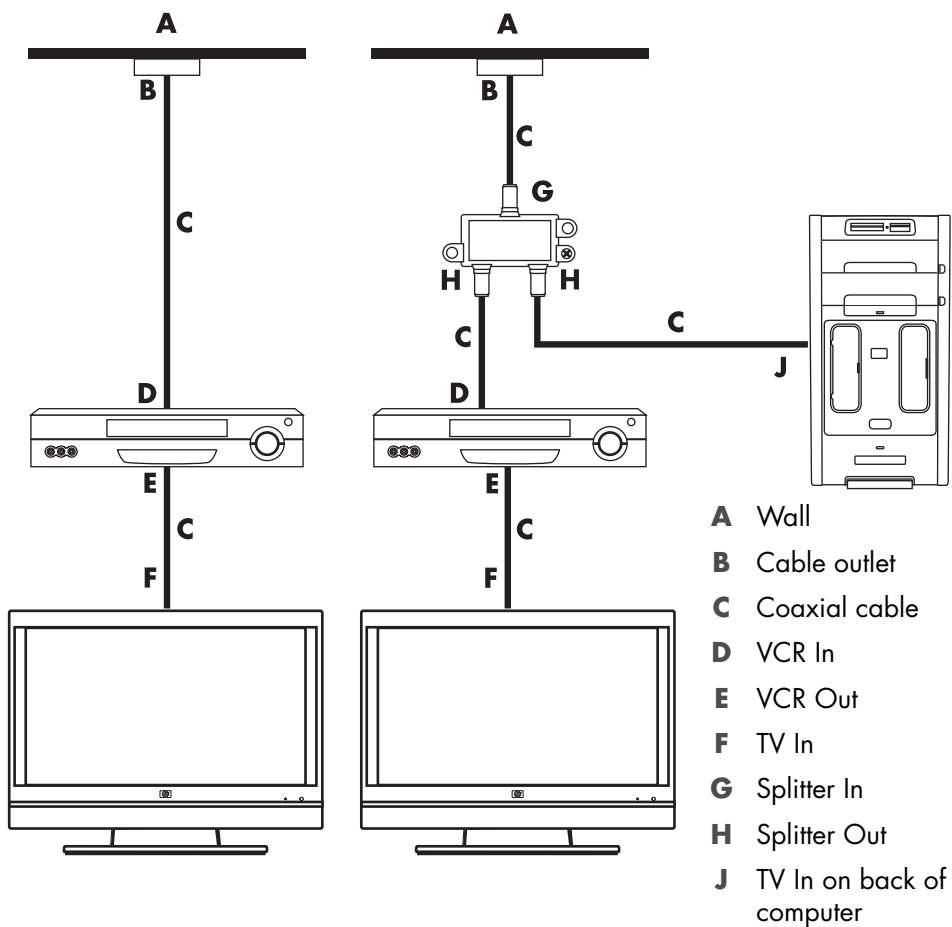

Wall to cable TV set-top box or satellite box to VCR to TV, using coaxial cable

- 1 Disconnect the coaxial cable from the input to the VCR, and connect it to the input of a coaxial cable signal splitter (not included; available at electronics stores).
- 2 Connect two coaxial cables to the splitter outputs.
- 3 Connect one of these cables to the input of the VCR, and the other cable to the TV connector on the back of the computer.
- 4 Connect the remote control sensor cable (emitter), and position it on the set-top box or satellite box. This enables the computer to change the channel on the box. See "Connecting the Remote Sensor."

Existing setup Setting up the computer with a splitter

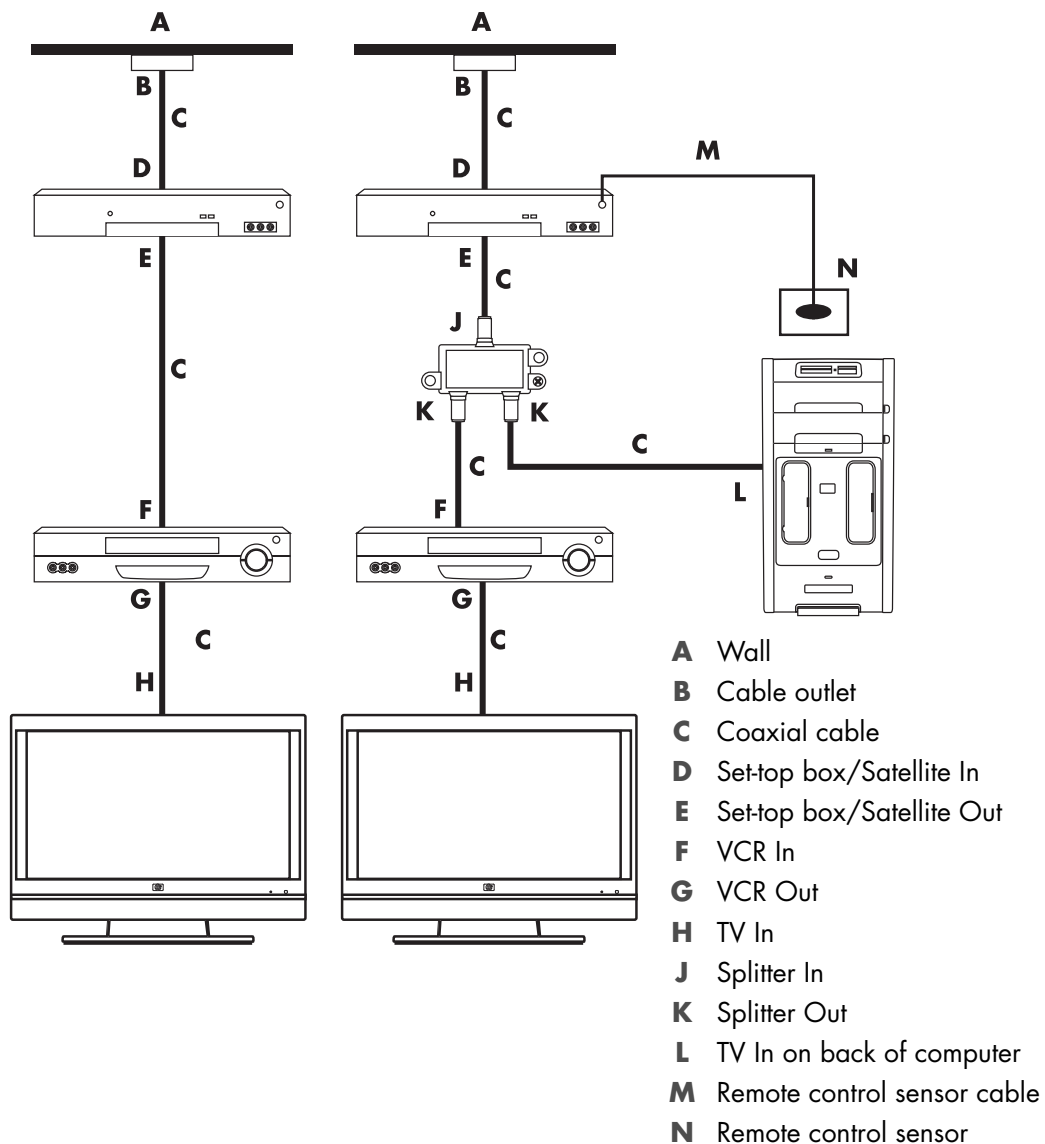

Wall to cable TV set-top box or satellite box to VCR and TV, using S-video cable or composite video cable between the box and the VCR or TV

- 1** Do not detach any cables from the existing setup.
- 2** Connect an additional cable by doing one of the following:
 - Connect one end of an S-video cable (not included) to a second output on the set-top box or satellite box. Connect the other end to the S-video In connector on the back of the computer.

Or

 - Connect one end of a composite video cable to a second output on the set-top box or satellite box. Connect the other end to the S-video-to-composite video adapter cable, and then connect the adapter to the S-video In connector on the back of the computer.
- 3** If you are using a composite video or S-video cable, you must also connect audio cables (not included) from the satellite box or set-top box to the Audio In right (red) and Audio In left (white) connectors on the back of the computer.
- 4** Connect the remote control sensor cable (emitter), and position it on the set-top box or satellite box. This enables the computer to change the channel on the box. See "Connecting the Remote Sensor."

Existing setup

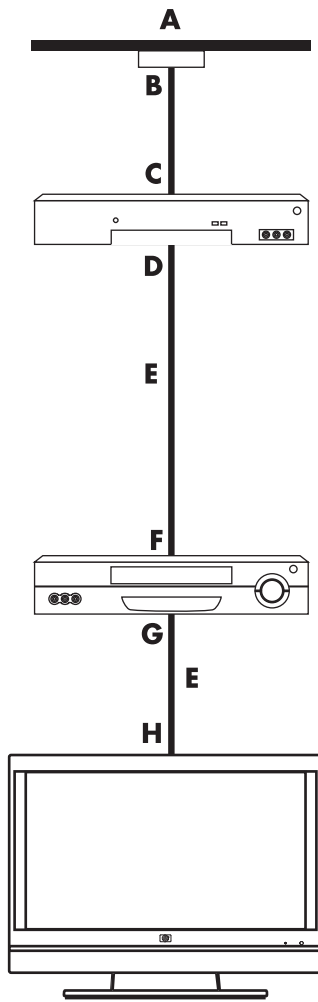

With a computer

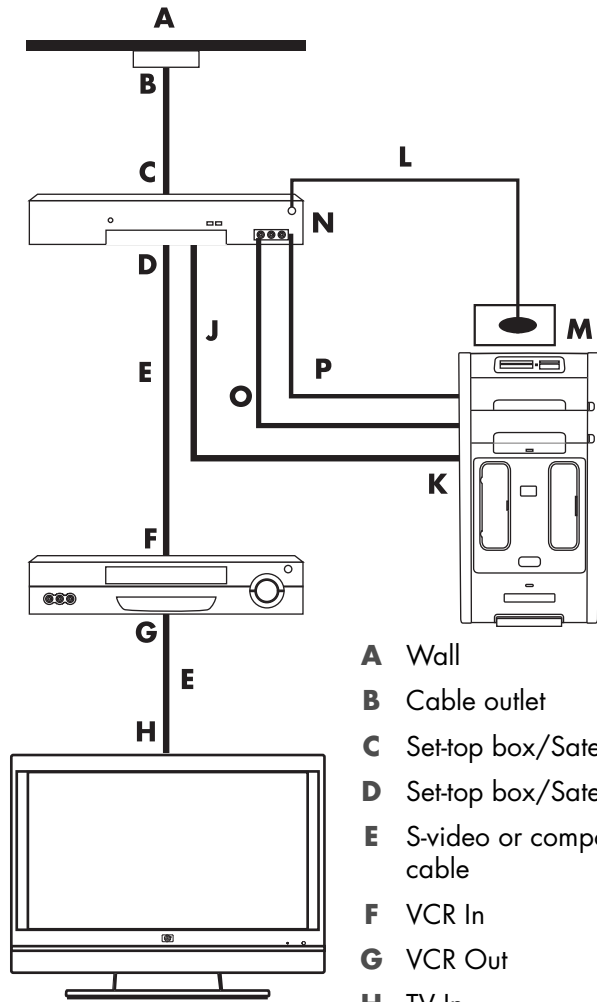

- A** Wall
- B** Cable outlet
- C** Set-top box/Satellite In
- D** Set-top box/Satellite Out
- E** S-video or composite cable
- F** VCR In
- G** VCR Out
- H** TV In
- J** Add an S-video or composite cable with adapter
- K** S-video In on back of computer
- L** Remote control sensor cable
- M** Remote control sensor
- N** Set-top box/second output
- O** R-Audio
- P** L-Audio

Using a TV as a Monitor

(Select models only)

Your computer may have TV-out capability, that is, video output connectors, such as DVI-out, Component-out, and S-video-out connectors. If so, you can connect a TV to one of the output connector sets, and then view the computer desktop image, watch DVD movies, or play games on the TV screen. TV-out connectors are an optional feature.

Cables for connecting the computer to a TV

To connect the computer to a TV, you need a video cable and an audio cable. The type of video cable that you need depends on the connection jacks on the TV:

- If the TV has an S-video input connector, you need an S-video cable.
- If the TV has a composite video connector, you need a composite video cable. Depending on the jacks on the back of the computer, you may also need an S-video adapter cable.

Connecting the computer to a TV

- 1 Turn off the computer.
- 2 Connect the TV cable by doing one of the following, depending on the connection connectors on the TV.

NOTE: There may be two S-video connectors on the back of the computer: S-video Out on the video card (select models only), and S-video In on the TV tuner card.

- If the TV has an S-video connector, connect an S-video cable (**A**) (not included) from the S-video In connector on the TV to the S-video Out connector (**B**) on the back of the computer (select models only).

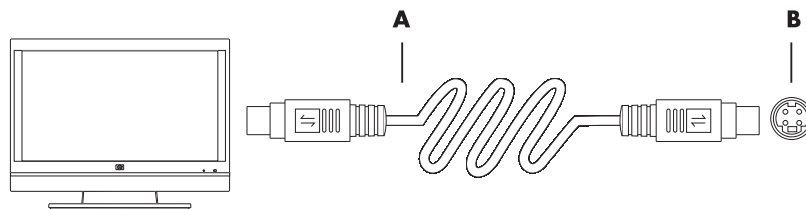

- If the TV has a composite video input connector, and the computer has a composite video output connector, connect a composite video cable (**C**) to the Video In connector on the TV and to the composite video out connector (**D**) on the back of the computer (select models only).

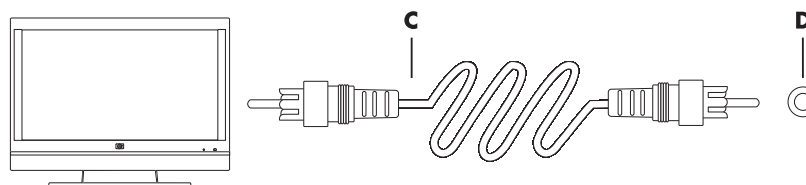

- 3 To have sound come from the TV instead of from the computer, plug an audio cable into the audio input connector (Audio Line In) on the TV, and plug the other end of the audio cable into the audio output connector (Audio Line Out) on the back of the computer.
- 4 Turn on the TV, and then select the TV In video source. For more information, refer to the documentation for the TV set.
- 5 Turn on the computer. Enable the computer desktop for the TV. For more information, see “Viewing the computer desktop on a TV screen.”

Viewing the computer desktop on a TV screen

The type of video card on the computer determines how the computer selects the TV-out option.

When you want to disconnect the TV from the computer, you may need to disable the TV-out option to return the computer desktop to its original resolution.

To enable the TV-out option:

- 1 Right-click an empty area of the desktop, and then click **Personalize**.
- 2 Click **Display Settings**.
- 3 If necessary, select the monitor or TV.
- 4 Click the **Advanced** button.
- 5 Click the tab for the video card. (The tab may be labeled *Displays*, *ATI Displays*, *Ge Force xxx*, *nView*, or *Devices*.)
- 6 Choose the **TV** option, and then follow the onscreen instructions.

Adjusting the screen resolution

To change the screen resolution:

- 1 Right-click an empty area of the desktop, and then click **Personalize**.
- 2 Click **Display Settings**.
- 3 If necessary, select the monitor, and then adjust the screen resolution.
- 4 Click **Apply**.
- 5 Click **Yes**, if it is present.
- 6 Click **OK**.

Connecting more than one display



You can connect more than one display device (CRT monitor, flat panel monitor, TV, and so on) to the computer at a time (select models only). You can quickly change which device displays the computer desktop by pressing Alt+F5. Each time that you press Alt+F5, the computer desktop appears on the next device. If pressing Alt+F5 does not work, restart the computer and try again.

Using the Windows Media Center Setup for Optional Setup of the TV Display

If the TV connects to the computer with a composite or S-video connection, the Windows Media Center setup wizard cannot automatically adjust the settings for the display. This automatic adjustment is available only during the Optional Setup, within the “Optimize how Windows Media Center looks on your display” step.

The following procedure describes what to do within the Windows Media Center setup, and how to use the Windows Desktop Properties window to adjust the settings for the TV display:

NOTE: The type of video card on the computer determines how the computer selects the TV-out option. Some options and menus in this procedure may be different for the computer.

- 1 Press the Windows Media Center Start button  on the remote control. Or, with the mouse, click the **Windows Start Button**  on the taskbar, and then click **Windows Media Center**.
- 2 From the Tasks menu, click **settings**, and then click **TV**.
- 3 Click **Configure Your TV or Monitor** to go to the Display Configuration screen.
- 4 Click **Next**.
- 5 Select the preferred display, and then click **Next**.
- 6 Select the display type and connection type for the TV display:
 - If you select the **Composite or S-video** option:
 - Click **Next**, which will take you to the screen to optimize the display.
 - Select the appropriate setting, and then click **Next**.
 - When you have adjusted all the display settings, click **Finish this Wizard**.
 - If you select **DVI, VGA, or HDMI** or **Component (YPbPr)**:
 - Continue to select the appropriate settings, then click **Next**.
 - When you have adjusted all the display settings, click **Finish this Wizard**.
- 7 Close or minimize the Windows Media Center window.
- 8 Right-click an empty area of the desktop, and then click **Personalize**.
- 9 Click **Display Settings**.
- 10 If necessary, select the monitor or TV.
- 11 Click the **Advanced Settings** button.
- 12 Click the tab for the video card. (The tab may be labeled *Displays*, *ATI Displays*, *Ge Force xxx*, *nView*, or *Devices*.)
- 13 Choose the **TV** option, and then follow the onscreen instructions.

Disabling the TV-out Option

When you want to disconnect the TV from the computer and view the computer desktop on the original monitor, you may need to disable the TV option to return the computer display to its original resolution.

NOTE: The TV must be connected to the computer to change the display settings.

To disable the TV-out option:

- 1 Right-click an empty area of the desktop, and click **Personalize**.
- 2 Click **Display Settings**.
- 3 If necessary, select the TV.
- 4 Click the **Advanced Settings** button.
- 5 Click the tab for the video card. (The tab may be labeled *Displays*, *ATI Displays*, *Ge Force xxx*, *nView*, or *Devices*.)
- 6 Disable the TV option (by choosing the monitor only for display), and then follow the onscreen instructions.

Disconnecting the TV

- 1 Disable the TV-out option. See “Disabling the TV-out Option.”
- 2 Turn off the TV and the computer.
- 3 Remove the video and audio cables from the TV and the computer.

Connecting to a Monitor or High-Definition TV







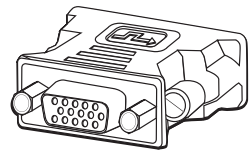

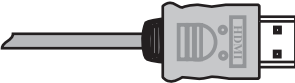
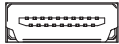
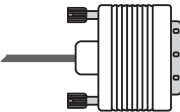

Choosing the AV connection to use

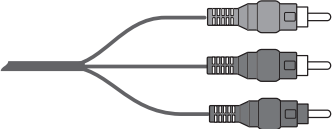
When you connect optional equipment as signal sources, the connectors on the equipment may limit the type of connection that you can use. When the optional equipment has more than one type of output connector, choose the connection that provides the best-quality playback image. For best results, choose the best-quality connection type that is supported by the optional equipment.

NOTE: Some graphic cards have a DVI connector and a DVI-to-VGA converter included in the box (select models only). If the monitor has a VGA connector but no DVI connector, use the DVI-to-VGA converter to connect to the computer: Connect the DVI-to-VGA converter to the DVI connector on the computer graphic card, and then connect the VGA cable to the converter and to the monitor.

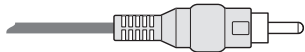

The following table shows the possible AV connection types, listed in order of decreasing video playback quality (from best to good):

Cable	Port	Connection description
		<p>HDMI transmits an all-digital signal and is the recommended choice for playback from a digital DVD or DVR.</p> <p>It is capable of transmitting both uncompressed digital audio and digital video signals, because it has video, audio and control signals.</p> <p>For more information, see "Connecting an HDMI device."</p>
		<p>DVI transmits an all-digital video signal for playback from a digital DVD or DVR.</p> <p>For more information, see "Connecting a DVI device."</p>
	  	<p>Component video transmits video as separate red (Pr), green (Y), and blue (Pb) signals. It is available in standard-definition and high-definition (HD) versions.</p> <p>It delivers higher quality than S-video and composite video connections.</p> <p>Example: A TV to a DVD player.</p> <p>For more information, see "Connecting to component video."</p>
		<p>S-video transmits video. (The "S" stands for "separate.")</p> <p>It delivers a sharper image than a composite video connection.</p> <p>Example: A TV to a VCR.</p> <p>For more information, see "Connecting to S-video."</p>
		<p>Composite video transmits video as a single signal. It usually has a yellow tip.</p> <p>It delivers a less sharp image than component video and S-video connections.</p> <p>Example: A DVD/VHS player to a TV.</p>

The remainder of this chapter describes how to connect optional equipment, including the audio connections when applicable. The order follows that of the preceding table.



WARNING: Before connecting optional equipment, unplug the power cord for the TV and all connected components. Ensure that the optional equipment is turned off.

Connecting an HDMI device

This is the recommended connection for video and audio. The HDMI cable is sold separately.

To connect an HDMI device:

- 1 Connect the HDMI cable to the HDMI connector on the computer. (There are no separate audio inputs for HDMI.)

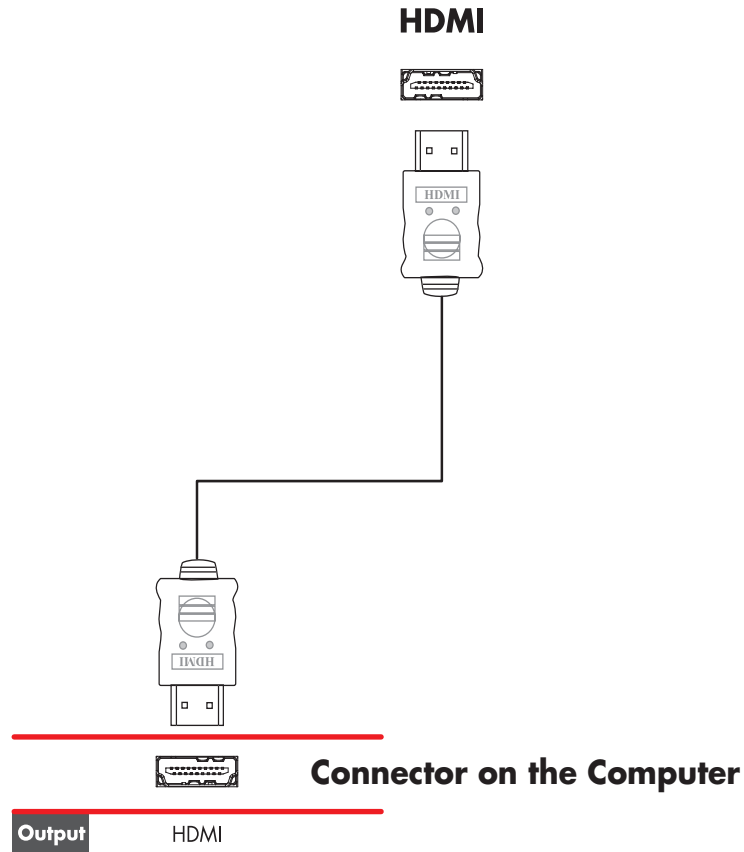

- 2 Connect the cable to the HDMI device.
- 3 Turn on the HDMI device, and start play.
- 4 Plug in the computer.
- 5 Turn on the computer.
- 6 In the TV Option menu, define the HDMI Setup items.

Connecting a DVI device

The DVI cable, DVI-to-HDMI converter, and audio cables are sold separately.

1 Connect the video cables:

- If the computer has an HDMI connector, use a DVI video cable with a DVI-to-HDMI converter. Connect the HDMI end of the converter to the Digital Video connector on the computer, and then connect the DVI cable to the DVI equipment.

Or

- If the computer has a DVI connector, use a DVI video cable, and connect the cable to the computer and to the DVI equipment.

2 Connect the audio cables to the DVI equipment and to the computer.

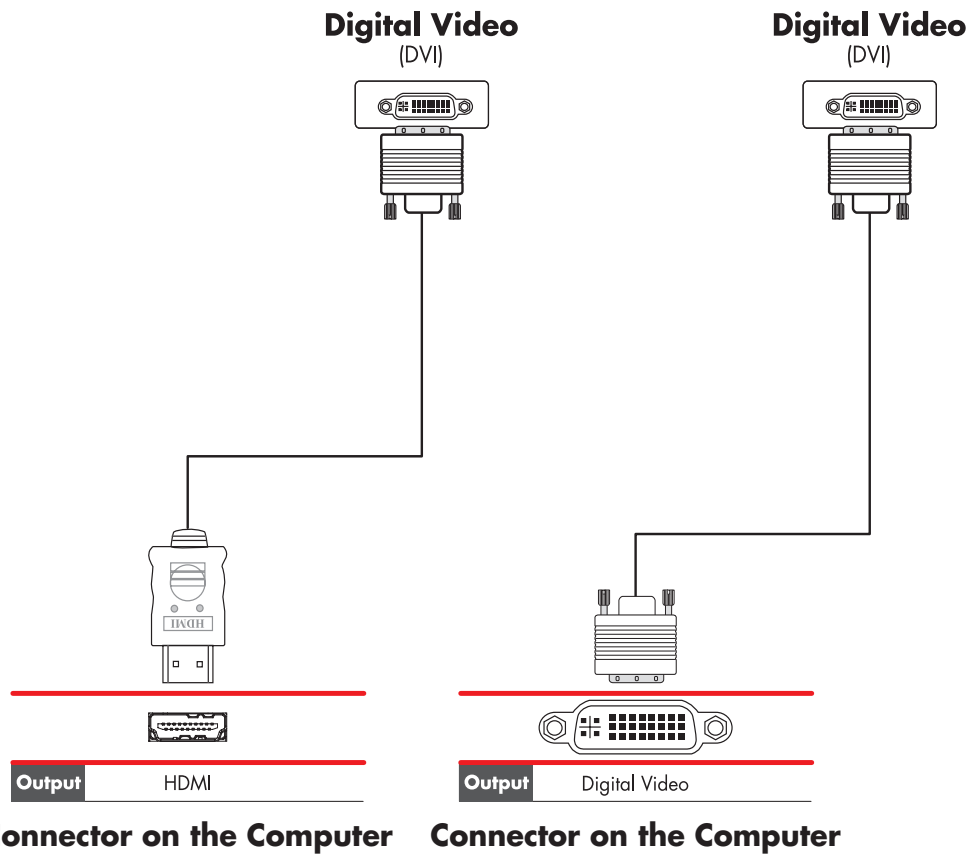

3 Turn on the DVI device, and start play.

4 Plug in the computer.

5 Turn on the computer.

Connecting to a Standard TV

NOTE: Cables are sold separately.

Connecting to component video



WARNING: In this example, both Input 1 and Input 2 have both Component and Video connectors, which share the left and right Audio connectors. Connect only one video input for each input set.

- 1 Connect the component video cable to the Component (Y, Pb, Pr) connectors. The example shows two sets of Component connectors that you can use: Input 1 or Input 2.

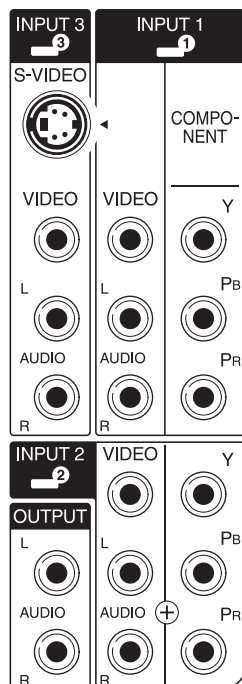

- 2 Connect the component audio cable to the left and right Audio connectors for the component input.
- 3 Connect the cables to the component device.
- 4 Turn on the device, and start play.
- 5 Plug in the computer.
- 6 Turn on the computer.

Connecting to S-video



WARNING: In this example, Input 3 has both S-video and Video connectors, which share the left and right Audio connectors. Connect only one video input for Input 3.

- 1 Connect the S-video equipment to the S-video connector (Input 3 in this example):



- 2 Connect the audio cable connectors to the left and right Audio connectors for Input 3.
- 3 Connect the cables to the device.
- 4 Turn on the device, and start play.
- 5 Plug in the computer.
- 6 Turn on the computer.

Configuring the TV Tuner

The computer includes a TV tuner that can receive analog or digital (DVB-T) broadcasts.

NOTE: In the countries/regions that do not support digital tuner functionality, you must use the analog tuner.

You must run the Windows Media Center setup wizard to configure (or confirm) the following settings on the computer:

- Country/region where the computer is being used
- Whether you want to receive analog or digital broadcasts (you cannot receive both at the same time)

NOTE: You need to select analog or digital if you are using an antenna to receive TV signals. You do not need to perform this part of the setup if you are using a cable or satellite set-top box.

Digital versus analog tuner

The setup wizard makes it easy to perform the tuner configuration. One thing to consider before starting the wizard is whether you want to receive analog or digital TV signals.

The digital tuner offers the following advantages over analog:

- No distortion caused by interference or being far from the broadcast transmitter. If you are within range of a digital signal, the picture quality is the same, regardless of the distance from the broadcaster.
- Widescreen (16:9) format is supported.

The analog tuner offers the following advantage over digital:

- Subtitles and teletext are supported.



In both tuners:

- Interactive TV is not supported.
- High-Definition (HD) is not supported.
- You cannot watch TV if you do not perform the configuration by using the setup wizard.
- In your area, some stations may be available only in analog or digital. You can use the procedure described in “Initial configuration using Windows Media Center setup wizard” (step 5) to compare the stations that are available for each type of tuner.

Initial configuration using Windows Media Center setup wizard

The first time that you start Windows Media Center, the Windows Media Center setup wizard displays. The Wizard contains *Express setup* and *Custom setup* options. The “Configure tuners, TV signal, and Guide” step is part of the Custom setup.

Perform the initial Windows Media Center configuration as follows:

- 1 Start the computer, and then perform the initial Windows configuration steps.
- 2 Start Windows Media Center by clicking the **Windows Start Button**  on the taskbar, and then **Windows Media Center**, or by pressing the Windows Media Center Start button  on the remote control. The Windows Media Center setup wizard displays.
- 3 Follow the onscreen instructions to complete the Required Setup steps. After completing the Required Setup steps, the Optional Setup screen displays.

- 4 Select **Configure tuners, TV signal, and Guide**, and then click **Next**.
- 5 Follow the onscreen instructions. After performing the Scan for Stations step, the wizard displays all the TV stations that the selected tuner is able to receive.
- 6 If the list does not contain stations that you want to view, click **Back** until you return to the Select Your TV Signal Type window and select the other tuner setting (analog if you selected digital first, or digital if you selected analog).
- 7 Complete the configuration steps until the list of stations for the new tuner type displays in the Scan for Stations window.
 - If you are satisfied with the stations that are listed, click **Next** and complete the configuration by following the onscreen instructions.
 - If you are not satisfied with the stations that are listed, return to step 6 and change back to the original tuner.

Changing the tuner settings

Complete the following procedure to reconfigure the computer if you move it to another country/region, or change the type of TV signals that you receive (cable, satellite, or antenna):

- 1 Click the **Windows Start Button**  on the taskbar, and then click **Windows Media Center**.
- 2 Click **Tasks, Settings, TV**, and then **Set Up TV Signal**.
- 3 Follow the onscreen instructions.

Index

A

- adjusting monitor 11
- adjusting the screen resolution 49
- analog video cable/adaptor 40
- audio cables 40
- audio connector 5
 - Audio Line Out 5
- audio input, left and right connectors 4

B

- Bluetooth devices 13

C

- cable modem, using 12
- cables
 - audio 40
 - Component video 52
 - Composite video 52
 - connecting computer to TV 48
 - DVI 52
 - HDMI 52
 - included 40
 - S-video 52
 - TV 39
 - video 40
- coaxial cable
 - connecting the TV signal source 45
- Composite video cable 40
- Composite video connector 4, 6
- computer
 - connecting the remote sensor 43
 - connecting the TV signal source 41
 - connecting TV signal source with set-top box and VCR 45
 - front-panel connectors 2
 - setting up 1

- connecting
 - devices 10
 - digital camera 8
 - digital video camera 8
 - dual tuner 42
 - DVI device 54
 - HDMI device 53
 - monitor 51
 - more than one display 49
 - peripherals 2
 - Standard TV 55
 - Standard video 55
 - S-video 56
- connection
 - wired network 13
- connector
 - Audio Line In 5
 - Audio Line Out 5
 - back panel 7
 - Composite Video In 6
 - computer 2
 - FM In 6
 - headphones 4
 - keyboard 4
 - Microphone In 4
 - modem 7
 - monitor 7
 - mouse 4
 - printer 5
 - S-video In 5
 - TV/Cable Ant 6
 - USB 4, 5

D

- devices
 - connecting 10
- digital camera
 - connecting 8, 10
- digital video camera
 - connecting to a computer 8
 - troubleshooting 9
- disabling the TV-Out option 51
- disconnecting the TV 51
- DVI-I or DVI-D cable 40

E

- Ethernet connection 13
- Ethernet network hub 5

F

- FM In connector 6
- FM radio antenna
 - connecting 6
- Found New Hardware* message, connecting a digital camera 8

H

- headphones
 - connector 4
- High-Definition
 - component video 52
 - TV, connecting 51

K

- keyboard
 - connector 4

L

- LAN (local area network) 12
 - antenna 14
 - checking wireless LAN device 15
 - connecting Ethernet LAN 5
 - connecting wireless LAN device 14
 - setting up 13
 - using Local Area Network 12
- local area network (LAN) 12

M

- manuals
 - storing 10
- microphone connector 4, 5
- mini-jack 17
- modem
 - connector 7
- monitor
 - adjusting 11
- monitor connector 7
- mouse connector 4

N

- network interface adapter 5
- Network Interface Card (NIC) 13

P

- peripherals 2
- power connector 4
- printer
 - connecting 10
 - connector 5

R

- RCA stereo cable 41
- remote sensor
 - connecting 43
- Remote IR cable 41

S

- satellite box 46
- scanner, connecting 10
- screen resolution
 - adjusting 49
- setting up computer 1
- set-top box 46
- speaker systems 21
- speakers
 - connecting multichannel audio speakers to the computer 17, 19–36
- splitter cable, using 41
- surge protector 2
- S-video cable 40
- S-video In connector 4, 5

T

Television signal/television signals 39

TV

connecting 48

connecting the TV signal source 41, 44, 46

disconnecting 51

using as a monitor 48

TV coaxial cable

using 41

TV tuner

connecting TV to computer 48

signal source 41

U

USB connector 4, 5

using

coaxial cable 44

TV cables 39

your TV as a monitor 48

V

video cables 39, 40

videos

working with home videos 8

W

WEP 15

wired network connection 13

wireless devices 13

wireless LAN 14

wireless LAN connection 14

wireless local area network (WLAN) 13

wireless network

security 15

wireless network device

checking installation 15

wireless wide area networks (WWAN) devices 14

WLAN security 15

WPA 15

Y

Y adapter cables 29

Part number: 5992-3573