

# Memory Modules

## User Guide

© Copyright 2008 Hewlett-Packard  
Development Company, L.P.

The information contained herein is subject to change without notice. The only warranties for HP products and services are set forth in the express warranty statements accompanying such products and services. Nothing herein should be construed as constituting an additional warranty. HP shall not be liable for technical or editorial errors or omissions contained herein.

First Edition: June 2008

Document Part Number: 462946-001

## Product notice

This user guide describes features that are common to most models. Some features may not be available on your computer.



---

# Table of contents

## **Adding or replacing memory modules**

Adding or replacing a memory module in the expansion memory module slot .....	2
Upgrading a memory module in the primary memory module slot .....	5

<b>Index .....</b>	<b>10</b>
--------------------	-----------



---

# Adding or replacing memory modules

The computer has two memory module compartments. The primary memory module compartment is located under the keyboard. The expansion memory module compartment is located on the bottom of the computer.

The memory capacity of the computer can be upgraded by adding a memory module to the vacant expansion memory module slot or by upgrading the existing memory module in the primary memory module slot.

- 
- △ **WARNING!** To reduce the risk of electric shock and damage to the equipment, unplug the power cord and remove all batteries before installing a memory module.
  - △ **CAUTION:** Electrostatic discharge (ESD) can damage electronic components. Before beginning any procedure, touch a grounded metal object to be sure that you are discharged of static electricity.

# Adding or replacing a memory module in the expansion memory module slot

To add or replace a memory module in the expansion memory module slot, follow these steps:

1. Save your work.
2. Shut down the computer and close the display.

If you are not sure whether the computer is off or in Hibernation, turn the computer on by pressing the power button. Then shut down the computer through the operating system.

3. Disconnect all external devices connected to the computer.
4. Unplug the power cord from the AC outlet.
5. Turn the computer upside down on a flat surface.
6. Remove the battery from the computer.
7. Loosen the memory module compartment cover screw (1).
8. Lift the memory module compartment cover (2) away from the computer.

---

 **NOTE:** If the expansion memory module slot is not populated, bypass step 9 and proceed to step 10.

---

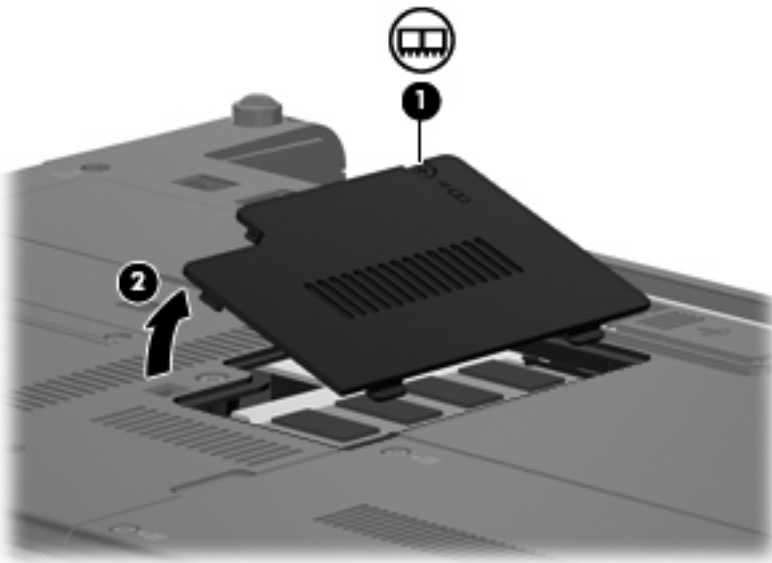

9. Remove the memory module:
  - a. Pull away the retention clips (1) on each side of the memory module.

The memory module tilts up.

---

 **CAUTION:** To prevent damage to the memory module, hold the memory module by the edges only. Do not touch the components on the memory module.

---



- b. Grasp the edge of the memory module (2), and gently pull the module out of the memory module slot.

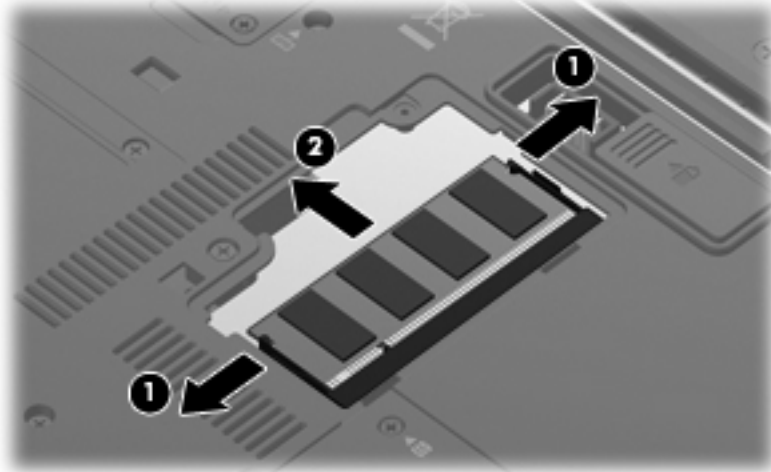

To protect a memory module after removal, place it in an electrostatic-safe container.

10. Insert a memory module:

△ **CAUTION:** To prevent damage to the memory module, hold the memory module by the edges only. Do not touch the components on the memory module, and do not bend the memory module.

- a. Align the notched edge (1) of the memory module with the tab in the memory module slot.
- b. With the memory module at a 45-degree angle from the surface of the memory module compartment, press the module (2) into the memory module slot until it is seated.
- c. Gently press the memory module (3) down, applying pressure to both the left and right edges of the memory module, until the retention clips snap into place.

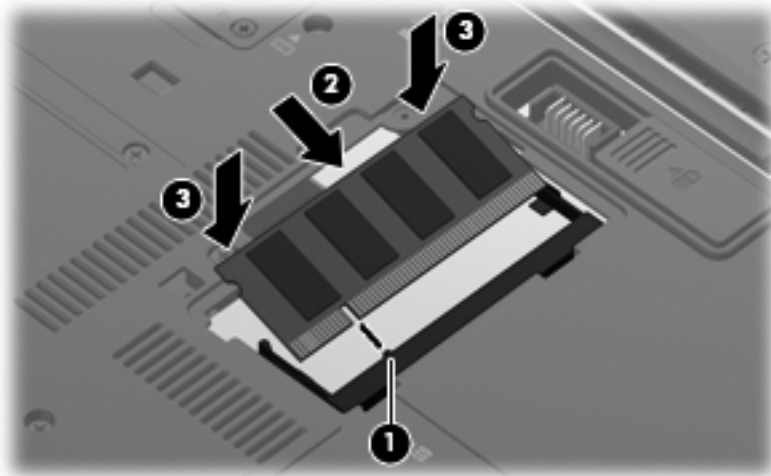

11. Align the tabs (1) on the memory module compartment cover with the notches on the computer.
12. Close the cover (2).

13. Tighten the memory module compartment cover screw (3).

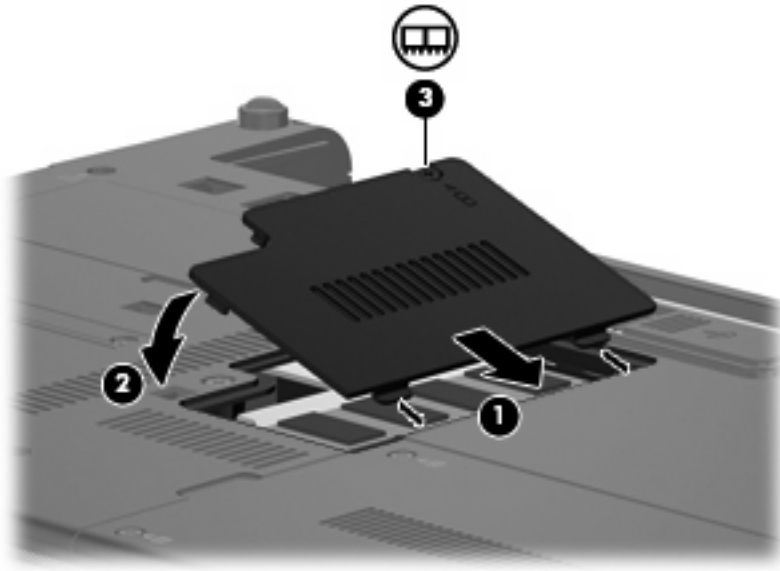

14. Replace the battery.
15. Turn the computer right-side up, and then reconnect external power and external devices.
16. Turn on the computer.

## Upgrading a memory module in the primary memory module slot

To upgrade a memory module in the primary memory module slot, follow these steps:

1. Save your work.

2. Shut down the computer.

If you are not sure whether the computer is off or in Hibernation, turn the computer on by pressing the power button. Then shut down the computer through the operating system.

3. Disconnect all external devices connected to the computer.

4. Unplug the power cord from the AC outlet.

5. Turn the computer upside down on a flat surface.

6. Remove the battery from the computer.

7. Remove the 3 keyboard access screws.

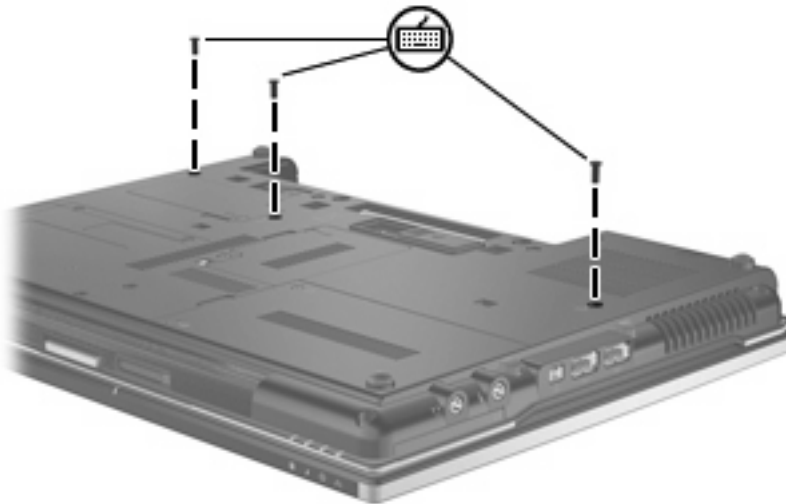

8. Turn the computer right-side up, and open it.

- Slide the 4 keyboard release latches to release the keyboard.

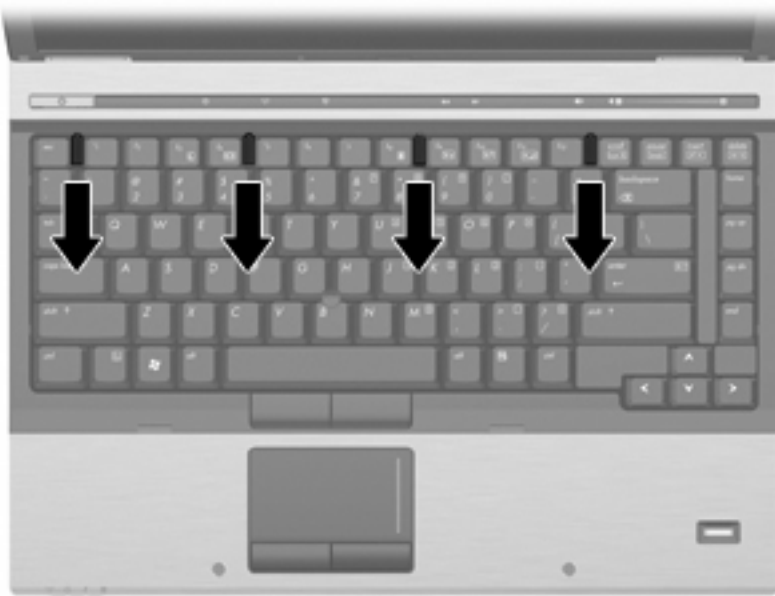

- Carefully lift the top edge of the keyboard and tilt the keyboard over until it rests on the palm rest of the computer.

 **NOTE:** If the left side of the keyboard releases before the right side, pull the keyboard slightly to the left to release the right side.



- Remove the memory module:
  - Pull away the retention clips (1) on each side of the memory module.

The memory module tilts up.

 **CAUTION:** To prevent damage to the memory module, hold the memory module by the edges only. Do not touch the components on the memory module.

- b. Grasp the edge of the memory module (2), and gently pull the module out of the memory module slot.

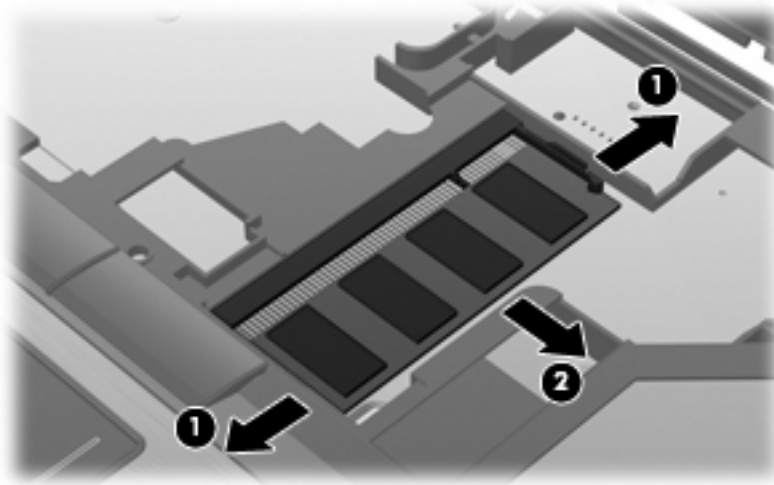

To protect a memory module after removal, place it in an electrostatic-safe container.

**12.** Insert a memory module:

△ **CAUTION:** To prevent damage to the memory module, hold the memory module by the edges only. Do not touch the components on the memory module, and do not bend the memory module.

- a. Align the notched edge (1) of the memory module with the tab in the memory module slot.
- b. With the memory module at a 45-degree angle from the surface of the memory module compartment, press the module (2) into the memory module slot until it is seated.
- c. Gently press the memory module (3) down, applying pressure to both the left and right edges of the memory module, until the retention clips snap into place.

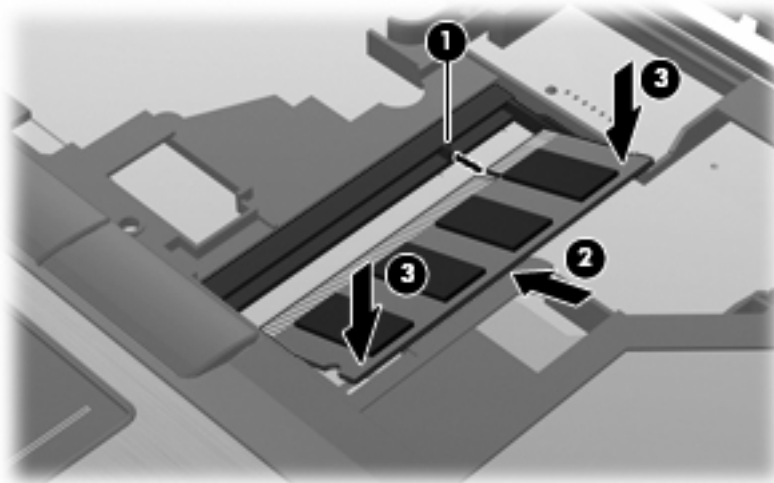

13. Replace the keyboard.



14. Slide the 4 keyboard release latches to lock the keyboard.

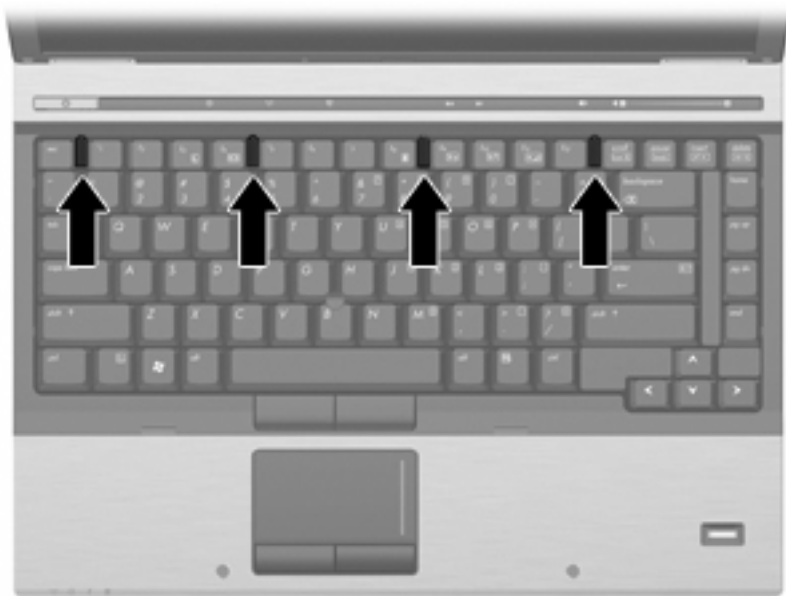

15. Turn the computer upside down on a flat surface.

16. Replace the keyboard access screws.

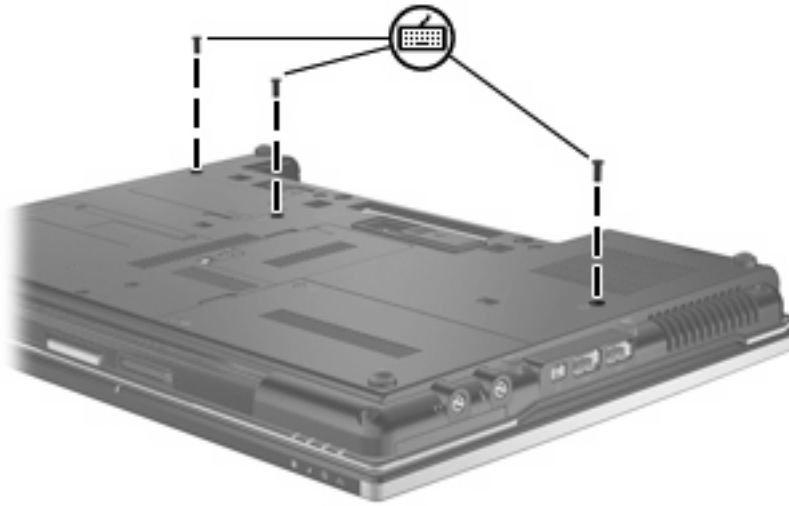

17. Replace the battery.
18. Turn the computer right-side up, and then reconnect external power and external devices.
19. Turn on the computer.

---

# Index

## K

keyboard screws  
    removing 5  
    replacing 9

## M

memory module  
    inserting 7  
    removing 2, 6  
    replacing 2, 5  
    upgrading primary 5  
memory module compartment  
    cover  
        removing 2  
        replacing 3  
memory, replacing memory  
    modules 2, 5



