

# Drives

## User Guide

© Copyright 2008 Hewlett-Packard  
Development Company, L.P.

Microsoft, Windows, and Windows Vista are either trademarks or registered trademarks of Microsoft Corporation in the United States and/or other countries.

The information contained herein is subject to change without notice. The only warranties for HP products and services are set forth in the express warranty statements accompanying such products and services. Nothing herein should be construed as constituting an additional warranty. HP shall not be liable for technical or editorial errors or omissions contained herein.

First Edition: June 2008

Document Part Number: 468146-001

## Product notice

This user guide describes features that are common to most models. Some features may not be available on your computer.



---

# Table of contents

## 1 Handling drives

### 2 Using an optical drive

Identifying the installed optical drive .....	3
Using optical discs .....	4
Selecting the right disc .....	5
CD-R discs .....	5
CD-RW discs .....	5
DVD±R discs .....	5
DVD±RW discs .....	5
LightScribe DVD+R discs .....	5
Blu-ray Disc .....	6
Playing a CD or DVD .....	7
Configuring AutoPlay .....	8
Changing DVD region settings .....	9
Observing the copyright warning .....	10
Copying a CD or DVD .....	11
Creating or “burning” a CD or DVD .....	12
Removing an optical disc (CD or DVD) .....	13
Removing the optical drive .....	14

### 3 Improving hard drive performance

Using Disk Defragmenter .....	16
Using Disk Cleanup .....	16

### 4 Using HP ProtectSmart Hard Drive Protection (select models only)

Identifying HP ProtectSmart Hard Drive Protection status .....	18
Using HP ProtectSmart Hard Drive Protection software .....	19

### 5 Replacing the hard drive

### 6 Troubleshooting

The optical disc tray does not open for removal of a CD or DVD .....	25
The computer does not detect the optical drive .....	26
A disc does not play .....	27
A disc does not play automatically .....	28
The process of burning a disc does not begin, or it stops before completion .....	29
A DVD playing in Windows Media Player produces no sound or display .....	30

A device driver must be reinstalled .....	31
Obtaining the latest HP device drivers .....	31
Obtaining the latest Windows device drivers .....	32

<b>Index .....</b>	<b>33</b>
--------------------	-----------

---

# 1 Handling drives

Drives are fragile computer components that must be handled with care. Refer to the following cautions before handling drives. Additional cautions are included with the procedures to which they apply.

△ **CAUTION:** To reduce the risk of damage to the computer, damage to a drive, or loss of information, observe these precautions:

Before you move a computer or external hard drive from one location, initiate Sleep, and allow the screen to clear.

Before handling a drive, discharge static electricity by touching the unpainted metal surface of the drive.

Do not touch the connector pins on a removable drive or on the computer.

Handle a drive carefully; do not drop a drive or place items on it.

Before removing or inserting a drive, shut down the computer. If you are unsure whether the computer is off, in the Sleep state, or in Hibernation, turn the computer on, and then shut it down through the operating system.

Do not use excessive force when inserting a drive into a drive bay.

Do not type on the keyboard or move the computer while the optical drive is writing to a disc. The write process is sensitive to vibration.

When the battery is the only source of power, be sure that the battery is sufficiently charged before writing to media.

Avoid exposing a drive to temperature or humidity extremes.

Avoid exposing a drive to liquids. Do not spray the drive with cleaning products.

Remove media from a drive before removing the drive from the drive bay, or traveling with, shipping, or storing a drive.

If a drive must be mailed, place the drive in a bubble-pack mailer or other suitable protective packaging and label the package "FRAGILE."

Avoid exposing a drive to magnetic fields. Security devices with magnetic fields include airport walk-through devices and security wands. The airport security devices that check carry-on luggage, such as conveyor belts, use X-rays instead of magnetism and will not damage a drive.

---

---

## 2 Using an optical drive

Your computer includes an optical drive that expands the functionality of the computer. Identify what kind of device is installed in your computer to see its capabilities. The optical drive allows you to read data discs, play music, and watch movies. If your computer includes a Blu-ray Disc ROM Drive, then you can also watch high-definition video from disc.



## Identifying the installed optical drive

Select **Start > Computer**.

You will see a list of all the devices installed on your computer, including your optical drive. You may have one of the following types of drives:

- DVD-ROM Drive
- DVD±RW/R and CD-RW Combo Drive
- DVD±RW/R and CD-RW Combo Drive with Double-Layer (DL) support
- LightScribe DVD±RW/R and CD-RW Combo drive with Double-Layer (DL) support
- Blu-ray Disc ROM Drive with SuperMulti DVD±R/RW Double Layer (DL) support

---

 **NOTE:** Some of the drives listed above may not be supported by your computer.

---

## Using optical discs

An optical drive, such as a DVD-ROM drive, supports optical discs (CDs and DVDs). These discs store information, such as music, photos, and movies. DVDs have a higher storage capacity than CDs.

Your optical drive can read standard CD and DVD discs. If your optical drive is a Blu-ray Disc ROM Drive, it can also read Blu-ray discs.

 **NOTE:** Some of the optical drives listed may not be supported by your computer. The listed drives are not necessarily all of the supported optical drives.

Some optical drives can also write to optical discs as described in the following table.

Optical drive type	Write to CD-RW	Write to DVD±RW/R	Write to DVD+R DL	Write label to LightScribe CD or DVD ±RW/R
DVD/CD-RW Combo Drive	Yes	No	No	No
SuperMulti DVD±RW and CD-RW Combo Drive with DL support	Yes	Yes	Yes	No
SuperMulti LightScribe DVD±RW and CD-RW Combo Drive with DL support	Yes	Yes	Yes	Yes
Blu-ray Disc ROM with SuperMulti DVD±R/RW Double Layer	Yes	Yes	Yes	No

 **CAUTION:** To prevent possible audio and video degradation, loss of information, or loss of audio or video playback functionality, do not initiate Sleep or Hibernation while reading or writing to a CD or DVD.

# Selecting the right disc

An optical drive supports optical discs (CDs and DVDs). CDs, used to store digital data, are also used for commercial audio recordings and are convenient for your personal storage needs. DVDs are used primarily for movies, software, and data backup purposes. DVDs are the same form factor as CDs but have 6 to 7 times the storage capacity.

 **NOTE:** The optical drive on your computer may not support all the types of optical discs discussed in this section.

---

## CD-R discs

Use CD-R (write-once) discs to create permanent archives and to share files with virtually anyone. Typical uses include the following:

- Distributing large presentations
- Sharing scanned and digital photos, video clips, and written data
- Making your own music CDs
- Keeping permanent archives of computer files and scanned home records
- Offloading files from your hard drive to free up disk space

After data is recorded, it cannot be erased or written over.

## CD-RW discs

Use a CD-RW disc (a rewritable version of a CD) to store large projects that must be updated frequently. Typical uses include the following:

- Developing and maintaining large documents and project files
- Transporting work files
- Making weekly backups of hard drive files
- Updating photos, video, audio, and data continuously

## DVD±R discs

Use blank DVD±R discs to permanently store large amounts of information. After data is recorded, it cannot be erased or written over.

## DVD±RW discs

Use DVD±RW discs if you want to be able to erase or write over data that you saved earlier. This type of disc is ideal for testing audio or video recordings before you burn them to a CD or DVD that cannot be changed.

## LightScribe DVD+R discs

Use LightScribe DVD+R discs for sharing and storing data, home videos, and photos. These discs are read-compatible with most DVD-ROM drives and DVD video players. With a LightScribe-enabled drive and LightScribe software, you can write data to the disc and then add a designer label to the outside of the disc.

## Blu-ray Disc

Also called BD, Blu-ray Disc is a high-density optical disc format for the storage of digital information, including high-definition video. A single-layer Blu-ray Disc can store 25 GB, over five times the size of the 4.7-GB single-layer DVD. A dual-layer Blu-ray Disc can store 50 GB, almost 6 times the size of the 8.5-GB dual-layer DVD.

Typical uses include the following:

- Storage of large amounts of data
- High-definition video playback and storage

## Playing a CD or DVD

1. Turn on the computer.
2. Press the release button (1) on the drive bezel to release the disc tray.
3. Pull out the tray (2).
4. Hold the disc by the edges to avoid touching the flat surfaces and position the disc label-side up over the tray spindle.

 **NOTE:** If the tray is not fully accessible, tilt the disc carefully to position it over the spindle.

5. Gently press the disc (3) down onto the tray spindle until the disc snaps into place.

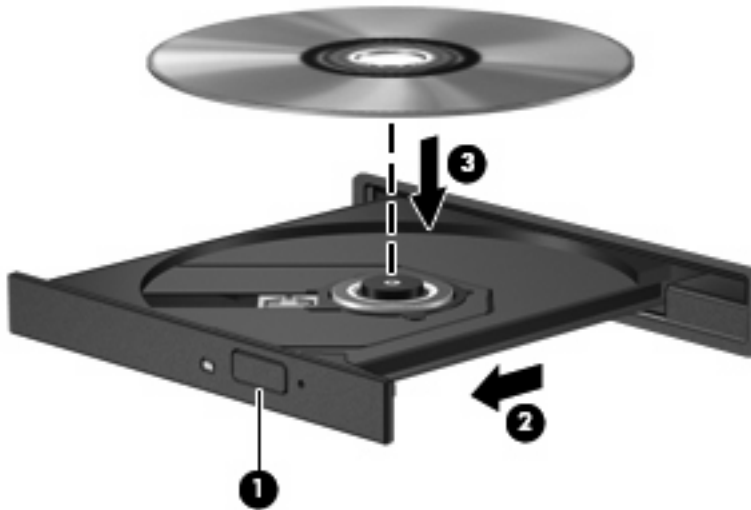

6. Close the disc tray.

If you have not yet configured AutoPlay, as described in the following section, an AutoPlay dialog box opens. It prompts you to select how you want to use the media content.

## Configuring AutoPlay

1. Select **Start > Control Panel > Play CDs or other media automatically**.
2. Confirm that the **Use AutoPlay for all media and devices** check box at the upper left of the computer screen is selected.
3. Click **Choose a default**, and then select one of the available options for each media type listed.
4. Click **Save**.

---

 **NOTE:** For more information about AutoPlay, refer to Windows Help.

# Changing DVD region settings

Most DVDs that contain copyrighted files also contain region codes. The region codes help protect copyrights internationally.

You can play a DVD containing a region code only if the region code on the DVD matches the region setting on your DVD drive.

---

△ **CAUTION:** The region settings on your DVD drive can be changed only 5 times.

The region setting you select the fifth time becomes the permanent region setting on the DVD drive.

The number of region changes remaining is displayed on the DVD Region tab.

---

To change settings through the operating system:

1. Select **Start > Computer > System properties**.
2. In the left pane, click **Device Manager**.

---

 **NOTE:** Windows includes the User Account Control feature to improve the security of your computer. You may be prompted for your permission or password for tasks such as installing software, running utilities, or changing Windows settings. Refer to Windows Help for more information.

---

3. Click the plus sign (+) next to **DVD/CD-ROM drives**.
4. Right-click the DVD drive for which you want to change region settings, and then click **Properties**.
5. Click the **DVD Region** tab, and change settings.
6. Click **OK**.

## Observing the copyright warning

It is a criminal offense, under applicable copyright laws, to make unauthorized copies of copyright-protected material, including computer programs, films, broadcasts, and sound recordings. Do not use this computer for such purposes.

---

△ **CAUTION:** To prevent loss of information or damage to a disc, observe the following guidelines:

Before writing to a disc, connect the computer to a reliable external power source. Do not write to a disc while the computer is running on battery power.

Before writing to a disc, close all open programs except the disc software you are using.

Do not copy directly from a source disc to a destination disc or from a network drive to a destination disc. Save the information to your hard drive, and then burn from your hard drive to the destination disc.

Do not use the computer keyboard or move the computer while the computer is writing to a disc. The write process is sensitive to vibration.

📄 **NOTE:** For details about using software included with the computer, refer to the software manufacturer's instructions, which may be provided on disc, in the software Help, or on the manufacturer's Web site.

---



## Copying a CD or DVD

1. Select **Start > All Programs > CyberLink DVD Suites > Power2Go**.
2. Insert the disc you want to copy into the optical drive.
3. Click **Copy** at the bottom right of the screen.
4. When prompted, remove the source disc from the optical drive and insert a blank disc into the drive.  
After the information is copied, the disc you created ejects automatically.

## Creating or “burning” a CD or DVD

If your computer includes a CD-RW, DVD-RW, or DVD±RW optical drive, you can use software such as Windows Media Player or CyberLink Power2Go to burn data and audio files, including MP3 and WAV music files. To burn video files to a CD or DVD, use MyDVD.

Observe the following guidelines when burning a CD or DVD:

- Before burning a disc, save and close any open files and close all programs.
- A CD-R or DVD-R is usually best for burning audio files because after the information is copied, it cannot be changed.

---

 **NOTE:** You cannot create an audio DVD with CyberLink Power2Go.

---

- Because some home and car stereos will not play CD-RWs, use CD-Rs to burn music CDs.
- A CD-RW or DVD-RW is generally best for burning data files or for testing audio or video recordings before you burn them to a CD or DVD that cannot be changed.
- DVD players used in home systems usually do not support all DVD formats. Refer to the user guide that came with your DVD player for a list of supported formats.
- An MP3 file uses less space than other music file formats, and the process for creating an MP3 disc is the same as the process for creating a data file. MP3 files can be played only on MP3 players or on computers with MP3 software installed.

To burn a CD or DVD, follow these steps:

1. Download or copy the source files into a folder on your hard drive.
2. Insert a blank CD or DVD into the optical drive.
3. Select **Start > All Programs**, and then select the name of the software you want to use.

---

 **NOTE:** Some programs may be located in subfolders.

---

4. Select the kind of CD or DVD you want to create—data, audio, or video.
5. Right-click **Start**, click **Explore**, and navigate to the folder where the source files are stored.
6. Open the folder, and then drag the files to the drive that contains the blank optical disc.
7. Initiate the burning process as directed by the program you have selected.

For specific instructions, refer to the software manufacturer's instructions, which may be provided with the software, on disc, or on the manufacturer's Web site.

---

△ **CAUTION:** Observe the copyright warning. It is a criminal offense, under applicable copyright laws, to make unauthorized copies of copyright-protected material, including computer programs, films, broadcasts, and sound recordings. Do not use this computer for such purposes.

---

## Removing an optical disc (CD or DVD)

1. Press the release button (1) on the drive bezel to release the disc tray, and then gently pull out the tray (2) until it stops.
2. Remove the disc (3) from the tray by gently pressing down on the spindle while lifting the outer edges of the disc. Hold the disc by the edges and avoid touching the flat surfaces.

 **NOTE:** If the tray is not fully accessible, tilt the disc carefully as you remove it.

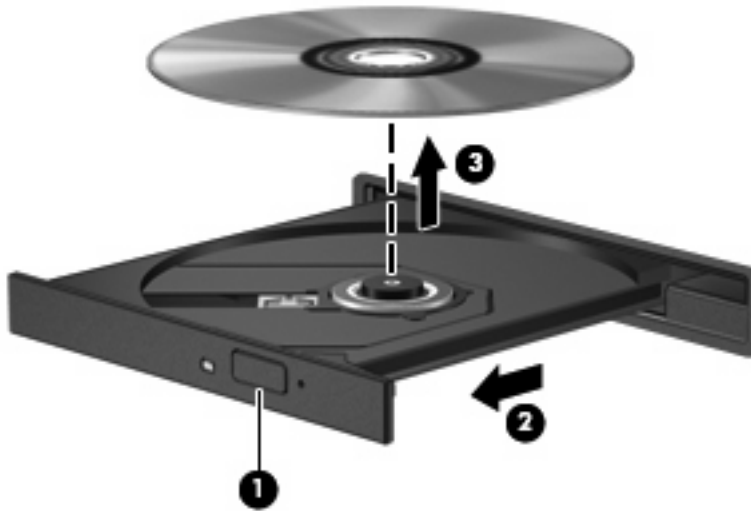

3. Close the disc tray and place the disc in a protective case.

## Removing the optical drive

The optical drive can be removed to reduce the weight of the computer:

1. Save your work.
2. Shut down the computer and close the display.  
If you are not sure whether the computer is off or in Hibernation, turn the computer on by pressing the power button. Then shut down the computer through the operating system.
3. Disconnect all external devices connected to the computer.
4. Unplug the power cord from the AC outlet.
5. Turn the computer upside down on a flat surface.
6. Remove the battery from the computer.
7. Remove the security screw from the optical drive.

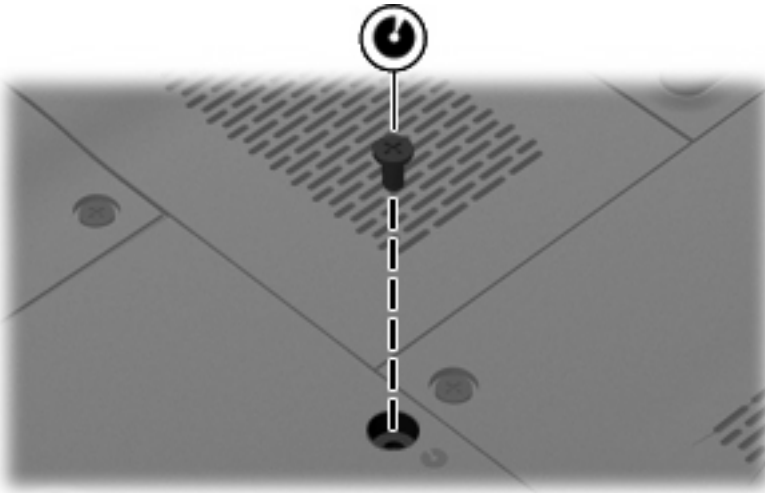

8. Remove the optical drive from the optical drive bay.



9. Insert the protective insert into the optical drive bay.



10. Replace the security screw.
11. Reconnect external power and external devices.
12. Turn on the computer.

---

## 3 Improving hard drive performance

### Using Disk Defragmenter

As you use the computer, files on the hard drive become fragmented. Disk Defragmenter consolidates the fragmented files and folders on the hard drive so that the system can run more efficiently.

After you start Disk Defragmenter, it works without supervision. Depending on the size of your hard drive and the number of fragmented files, Disk Defragmenter may take more than an hour to complete. You may want to set it to run during the night or another time when you do not need access to your computer.

HP recommends defragmenting your hard drive at least once a month. You may set Disk Defragmenter to run on a monthly schedule, but you can defragment your computer manually at any time.

To run Disk Defragmenter:

1. Select **Start > All Programs > Accessories > System Tools > Disk Defragmenter**.
2. Click **Defragment now**.

---

 **NOTE:** Windows® includes the User Account Control feature to improve the security of your computer. You may be prompted for your permission or password for tasks such as installing software, running utilities, or changing Windows settings. Refer to Windows Help for more information.

---

For additional information, access the Disk Defragmenter software Help.

### Using Disk Cleanup

Disk Cleanup searches the hard drive for unnecessary files that you can safely delete to free up disk space and help the computer to run more efficiently.

To run Disk Cleanup:

1. Select **Start > All Programs > Accessories > System Tools > Disk Cleanup**.
2. Follow the on-screen instructions.

---

## 4 Using HP ProtectSmart Hard Drive Protection (select models only)

HP ProtectSmart Hard Drive Protection protects the hard drive by parking the drive and halting I/O requests under either of the following conditions:

- You drop the computer.
- You move the computer with the display closed while the computer is running on battery power.

A short time after the end of one of these events, HP ProtectSmart Hard Drive Protection returns the hard drive to normal operation.

---

 **NOTE:** Hard drives that are in an optional docking device or are connected to a USB port are not protected by HP ProtectSmart Hard Drive Protection.

---

For more information, refer to the HP ProtectSmart Hard Drive Protection software Help.

# Identifying HP ProtectSmart Hard Drive Protection status

The drive light on the computer turns on to show that the drive is parked. To determine whether drives are currently protected or whether a drive is parked, select **Start > Control Panel > Mobile PC > Windows Mobility Center**:

- If the software is enabled, a green check mark is superimposed over the hard drive icon.
- If the software is disabled, a red X is superimposed over the hard drive icon.
- If the drives are parked, a yellow moon is superimposed over the hard drive icon.

---

 **NOTE:** The icon in the Mobility Center may not show the most up-to-date status for the drive. For immediate updates after a change in status, you need to enable the notification area icon.

---

To enable the notification area icon:

1. Select **Start > Control Panel > Hardware and Sound > HP ProtectSmart Hard Drive Protection**.

---

 **NOTE:** If prompted by User Account Control, click **Allow**.

---

2. On the **Icon in System Tray** row, click **Show**.
3. Click **OK**.

If HP ProtectSmart Hard Drive Protection has parked the drive, the computer will behave in the following ways:

- The computer will not shut down.
- The computer will not initiate Sleep or Hibernation, except as described in the following Note.

---

 **NOTE:** If the computer is running on battery power and reaches a critical battery level, HP ProtectSmart Hard Drive Protection allows the computer to initiate Hibernation.

---

- The computer will not activate battery alarms set on the Alarms tab in Power Options properties.

Before you move the computer, HP recommends that you either shut it down or initiate Sleep or Hibernation.



# Using HP ProtectSmart Hard Drive Protection software

The HP ProtectSmart Hard Drive Protection software enables you to perform the following tasks:

- Enable and disable HP ProtectSmart Hard Drive Protection.

 **NOTE:** Depending on your user privileges, you may not be able to enable or disable HP ProtectSmart Hard Drive Protection. Additionally, members of an Administrator group can change the privileges for non-Administrator users.

- Determine whether a drive in the system is supported.

To open the software and change settings, follow these steps:

1. In Mobility Center, click the hard drive icon to open the HP ProtectSmart Hard Drive Protection window.

– or –

Select **Start > Control Panel > Hardware and Sound > HP ProtectSmart Hard Drive Protection**.

2. Click the appropriate button to change settings.
3. Click **OK**.

## 5 Replacing the hard drive

△ **CAUTION:** To prevent information loss or an unresponsive system:

Shut down the computer before removing the hard drive from the hard drive bay. Do not remove the hard drive while the computer is on, in the Sleep state, or in Hibernation.

If you are not sure whether the computer is off or in Hibernation, turn the computer on by pressing the power button. Then shut down the computer through the operating system.

To remove the hard drive:

1. Save your work.
2. Shut down the computer and close the display.
3. Disconnect all external devices connected to the computer.
4. Unplug the power cord from the AC outlet.
5. Turn the computer upside down on a flat surface.
6. Remove the battery from the computer.
7. With the hard drive bay toward you, loosen the 2 hard drive cover screws (1).
8. Lift the hard drive cover away from the computer (2).

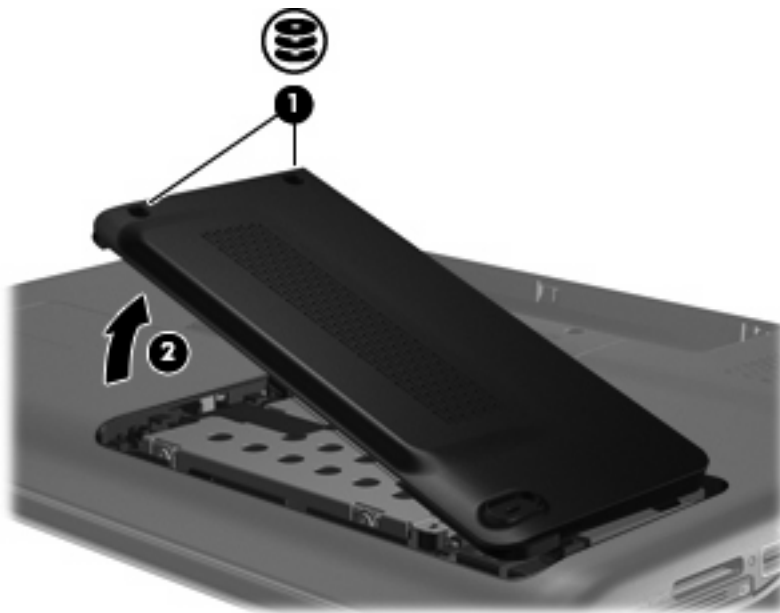

9. Remove the 3 hard drive screws.

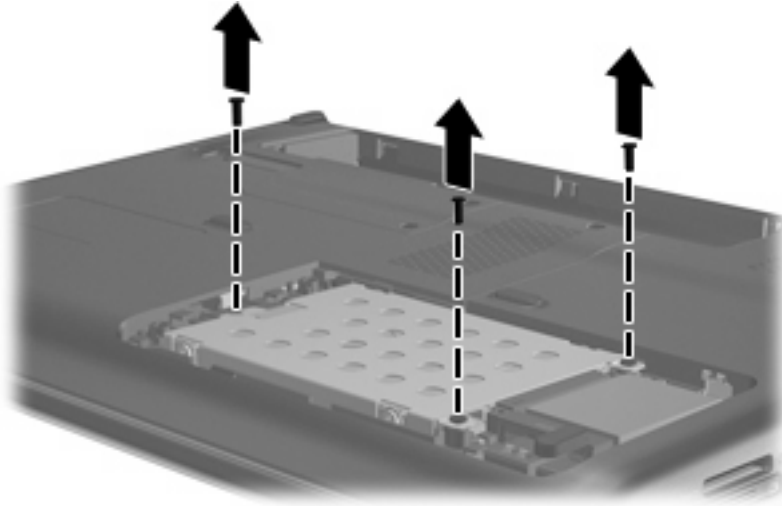

10. Pull the hard drive tab to the left (1), and then lift the hard drive away from the computer (2).

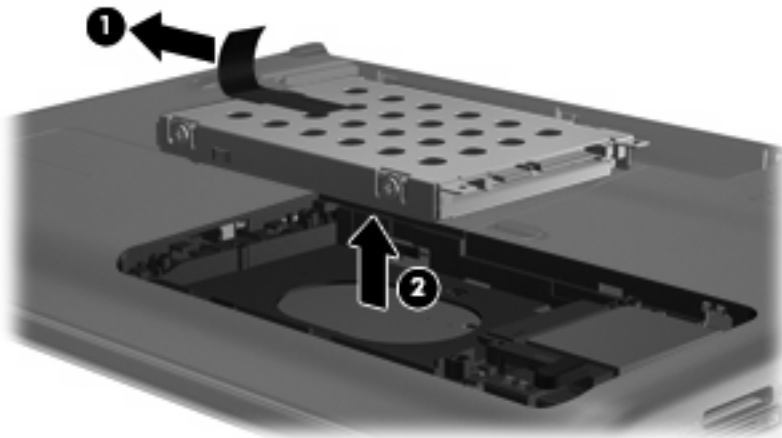

To install a hard drive:

1. Insert the hard drive into the hard drive bay (1).

2. Slide the hard drive to the right until it snaps into place (2).

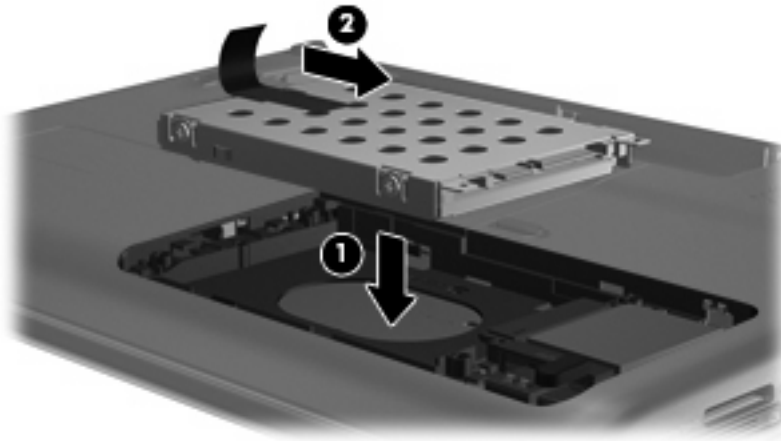

3. Replace the 3 hard drive screws.

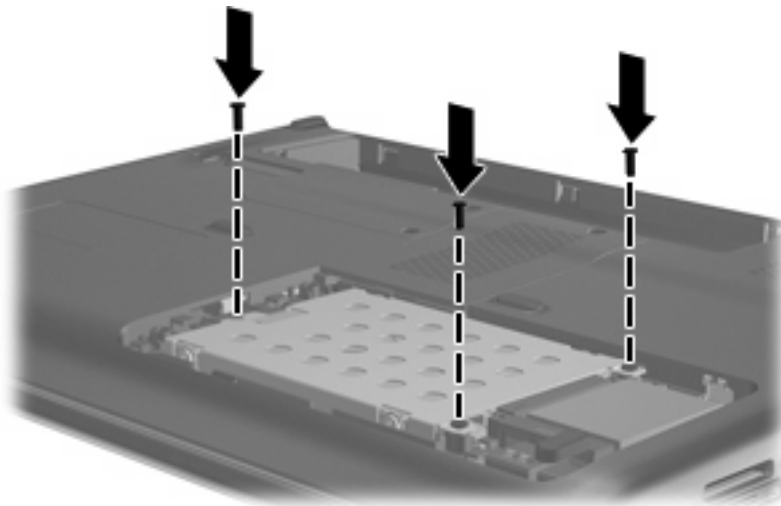

4. Align the tabs (1) on the hard drive cover with the notches on the computer.
5. Close the cover (2).

6. Tighten the hard drive cover screws (3).

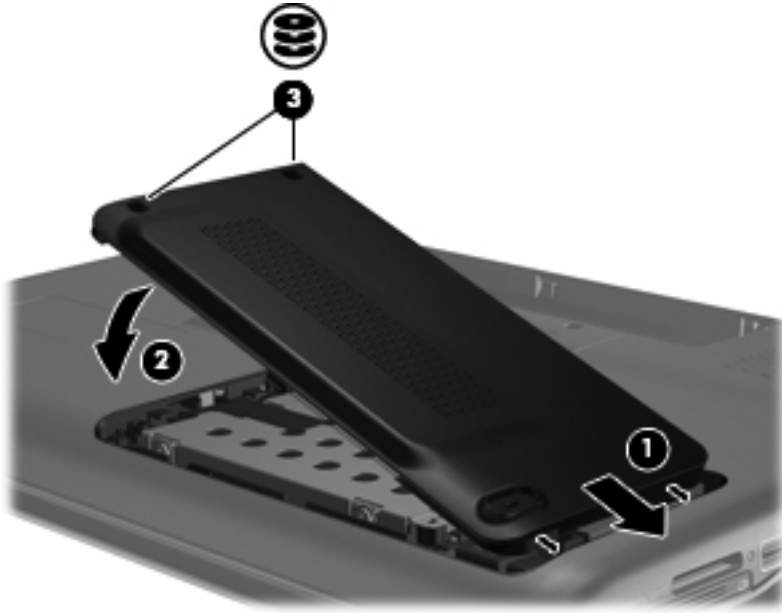

---

# 6 Troubleshooting

The following sections describe several common issues and resolutions.

## The optical disc tray does not open for removal of a CD or DVD

1. Insert the end of a paper clip (1) into the release access in the front bezel of the drive.
2. Press in gently on the paper clip until the disc tray is released, and then pull out the tray (2) until it stops.
3. Remove the disc (3) from the tray by gently pressing down on the spindle while lifting the outer edges of the disc. Hold the disc by the edges and avoid touching the flat surfaces.

 **NOTE:** If the tray is not fully accessible, tilt the disc carefully as you remove it.



4. Close the disc tray and place the disc in a protective case.

## The computer does not detect the optical drive

If Windows does not detect an installed device, the device driver software may be missing or corrupted. If you suspect that the DVD/CD-ROM drive is not being detected, verify that the optical drive is listed in the Device Manager utility.

1. Remove any discs from the optical drive.
2. Click **Start** and type `device manager` in the **Start Search** box.

As you type, search results are listed in the pane above the box.

3. In the results pane, click **Device Manager**. If prompted by User Account Control, click **Continue**.
4. In the Device Manager window, click the plus sign (+) next to **DVD/CD-ROM drives**, unless a minus sign (-) is already showing. Look for an optical drive listing.

If the drive is not listed, install (or reinstall) the device driver as instructed in “A device driver must be reinstalled” found later in this section.



## A disc does not play

- Save your work and close all open programs before playing a CD or a DVD.
- Log off the Internet before playing a CD or a DVD.
- Be sure that you insert the disc properly.
- Be sure that the disc is clean. If necessary, clean the disc with filtered water and a lint-free cloth. Wipe from the center of the disc to the outer edge.
- Check the disc for scratches. If you find scratches, treat the disc with an optical disc repair kit available at many electronics stores.
- Disable Sleep mode before playing the disc.

Do not initiate Hibernation or Sleep while playing a disc. Otherwise, you may see a warning message asking if you want to continue. If this message is displayed, click **No**. After you click No, the computer may behave in either of the following ways:

- Playback may resume.
  - or –
  - The playback window in the multimedia program may close. To return to playing the disc, click the **Play** button in your multimedia program to restart the disc. In rare cases, you may need to exit the program and then restart it.
- Increase system resources:
    - Turn off printers and scanners, and unplug cameras and portable handheld devices. Disconnecting these Plug and Play devices frees up valuable system resources and results in better playback performance.
    - Change desktop color properties. Because the human eye cannot easily tell the difference between colors beyond 16 bits, you should not notice any loss of color while watching a movie if you lower system color properties to 16-bit color, as follows:
      1. Right-click on a blank area of the computer desktop, and select **Personalize > Display Settings**.
      2. Set **Colors** to **Medium (16 bit)**, if this setting is not already selected.

## A disc does not play automatically

1. Click **Start** and type `autoplay` in the **Start Search** box.

As you type, search results are listed in the pane above the box.

2. In the results pane, click **Autoplay**. If prompted by User Account Control, click **Continue**.
3. Select the check box for **Use AutoPlay for all media and devices**, and then click **Save**.

A CD or DVD should now start automatically when it is inserted into the optical drive.

## The process of burning a disc does not begin, or it stops before completion

- Be sure that all other programs are closed.
- Turn off Sleep mode and Hibernation.
- Be sure that you are using the right kind of disc for your drive. See your user guides for more information about disc types.
- Be sure that the disc is inserted properly.
- Select a slower write speed and try again.
- If you are copying a disc, save the information on the source disc to your hard drive before trying to burn the contents to a new disc, and then burn from your hard drive.
- Reinstall the disc-burning device driver located in the DVD/CD-ROM drives category in Device Manager.

## A DVD playing in Windows Media Player produces no sound or display

Use QuickPlay or DVDPlay to play a DVD. QuickPlay and DVDPlay are installed on the computer, and are also available from the HP Web site at <http://www.hp.com>.

## A device driver must be reinstalled

1. Remove any discs from the optical drive.
2. Click **Start** and type `device manager` in the **Start Search** box.  
As you type, search results are listed in the pane above the box.
3. In the results pane, click **Device Manager**. If prompted by User Account Control, click **Continue**.
4. In Device Manager, click the plus sign (+) next to the type of driver you want to uninstall and reinstall (for example, DVD/CD-ROMs, Modems, and so on) unless the minus sign (-) is already showing.
5. Click a listed driver, and press the `delete` key. When prompted, confirm that you want to delete the driver, but do not restart the computer.

Repeat for any other drivers you want to delete.

6. In the Device Manager window, click the **Scan for hardware changes** icon in the toolbar. Windows scans your system for installed hardware and installs default drivers for any devices requiring drivers.

---

 **NOTE:** If you are prompted to restart the computer, save all open files, and then continue with the restart.

---

7. Reopen Device Manager, if necessary, and then verify that the drivers are once again listed.
8. Try running your program again.

If uninstalling and reinstalling the default device drivers does not correct the problem, you may need to update your drivers using the procedures in the following sections.

## Obtaining the latest HP device drivers

You can obtain the latest HP device drivers in either of the following ways:

- Using the HP Update Utility
- Using the HP Web site

To use the HP Update Utility:

1. Select **Start > All Programs > HP > HP Update**.
2. On the HP Welcome screen, click **Settings** and select a time when the utility should check for software updates on the Web.
3. Click **Next** to immediately check for HP software updates.

To use the HP Web site:

1. Open your Internet browser, go to <http://www.hp.com/support>, and select your country or region.
2. Click the option for software and driver downloads, type your computer model number in the search box, and then press `enter`.

– or –

If you want a specific SoftPaq, enter the SoftPaq number in the **Search** box, press `enter`, and follow the instructions provided. Proceed to step 6.

3. Click your specific product from the models listed.
4. Click the Windows Vista® operating system.
5. When the list of drivers is displayed, click an updated driver to open a window containing additional information.
6. Click **Install now** to install the updated driver without downloading the file.

– or –

Click **Download only** to save the file to your computer. When prompted, click **Save** and then select a storage location on your hard drive.

After the file is downloaded, navigate to the folder where the file was stored, and double-click the file to install.

7. If prompted to do so, restart your computer after the installation is complete, and then verify the operation of the device.

## Obtaining the latest Windows device drivers

You can obtain the latest Windows device drivers by using Microsoft® Update. This Windows feature can be set to automatically check for and install updates for the Windows operating system and other Microsoft products.

To use Microsoft Update:

1. Open your Internet browser and go to <http://www.microsoft.com>.
2. Click **Security & Updates**.
3. Click **Microsoft Update** to get the latest updates for your computer operating system, programs, and hardware.
4. Follow the on-screen instructions to install Microsoft Update. If prompted by User Account Control, click **Continue**.
5. Click **Change settings** and select a time for Microsoft Update to check for updates to the Windows operating system and other Microsoft products.
6. If prompted to do so, restart your computer.

---

# Index

## A

airport security devices 1  
AutoPlay 8

## B

Blu-ray Disc ROM with SuperMulti  
DVD±R/RW Double Layer 4

## C

CD  
burning 12, 29  
copying 11  
playing 7  
removing 13  
CD drive 2  
copyright warning 10

## D

device drivers  
HP drivers 31  
Windows drivers 32  
Disk Cleanup software 16  
Disk Defragmenter software 16  
disk performance 16  
drive light 18  
drives  
caring for 1  
hard 20, 21  
optical 2  
See *also* hard drive; optical drive  
DVD  
burning 12, 29  
changing region setting 9  
copying 11  
playing 7  
removing 13  
DVD drive 2  
DVD region settings 9  
DVD/CD-RW Combo Drive 4

## H

hard disk drive  
HP ProtectSmart Hard Drive  
Protection 17  
installing 21  
removing 20  
replacing 20  
hard drive  
HP ProtectSmart Hard Drive  
Protection 17  
installing 21  
removing 20  
replacing 20  
HP ProtectSmart Hard Drive  
Protection 17

## L

light, drive 18

## M

maintenance  
Disk Cleanup 16  
Disk Defragmenter 16

## O

optical disc  
removing 13  
optical drive  
removing 14

## R

region codes, DVD 9

## S

software  
Disk Cleanup 16  
Disk Defragmenter 16  
SuperMulti DVD±RW and CD-RW  
Combo Drive with DL support 4

SuperMulti LightScribe DVD±RW  
and CD-RW Combo Drive with DL  
support 4

## T

troubleshooting  
burning discs 29  
device driver 31  
disc play 27, 28  
HP device drivers 31  
optical disc tray 25  
optical drive detection 26  
Windows drivers 32

