

Multimedia User Guide

© Copyright 2008 Hewlett-Packard
Development Company, L.P.

Windows is a U.S. registered trademark of
Microsoft Corporation.

The information contained herein is subject
to change without notice. The only
warranties for HP products and services are
set forth in the express warranty statements
accompanying such products and services.
Nothing herein should be construed as
constituting an additional warranty. HP shall
not be liable for technical or editorial errors
or omissions contained herein.

First Edition: June 2008

Document Part Number: 487053-001

Product notice

This user guide describes features that are common to most models. Some features may not be available on your computer.

Table of contents

1 Multimedia features

Identifying your multimedia components	2
Adjusting the volume	3

2 Multimedia software

Accessing your preinstalled multimedia software	5
Installing multimedia software from a disc	6

3 Audio

Connecting external audio devices	8
Checking your audio functions	9

4 Video

Connecting an external monitor or projector	11
---	----

5 Optical drive (select models only)

Identifying the installed optical drive	12
Using optical discs (CDs and DVDs)	13
Playing a CD or DVD	14
Configuring AutoPlay	15
Observing the copyright warning	16
Copying a CD or DVD	17
Creating or “burning” a CD or DVD	18
Removing a CD or DVD	19
Preventing playback disruptions	20
Changing DVD region settings	21

6 HP Webcam

Webcam tips	23
Adjusting webcam properties	24
Controlling the webcam focus mode (select models only)	25

7 Troubleshooting

The optical disc tray does not open for removal of a CD or DVD	27
A disc does not play	28
A disc does not play automatically	29
A DVD movie stops, skips, or plays erratically	30
A DVD movie is not visible on an external display	31
A DVD playing in Windows Media Player produces no sound or display	32
The process of burning a disc does not begin, or it stops before completion	33
The computer does not detect the optical drive	34
A new device driver is needed	35
Obtaining Microsoft device drivers	35
Obtaining HP device drivers	35

Index	36
--------------------	-----------

1 Multimedia features

Your computer includes multimedia features that allow you to listen to music, watch movies, and view pictures. Your computer may include the following multimedia components:

- Optical drive for playing audio and video discs
- Integrated speakers for listening to music
- Integrated microphone for recording your own audio
- Integrated webcam that allows you to capture and share video
- Preinstalled multimedia software that allows you to play and manage your music, movies, and pictures
- Hotkeys that provide fast access to multimedia tasks

 **NOTE:** Your computer may not include all of the components listed.

The following sections explain how to identify and use the multimedia components included with your computer.

Identifying your multimedia components

The following illustration and table describe the multimedia features of the computer.

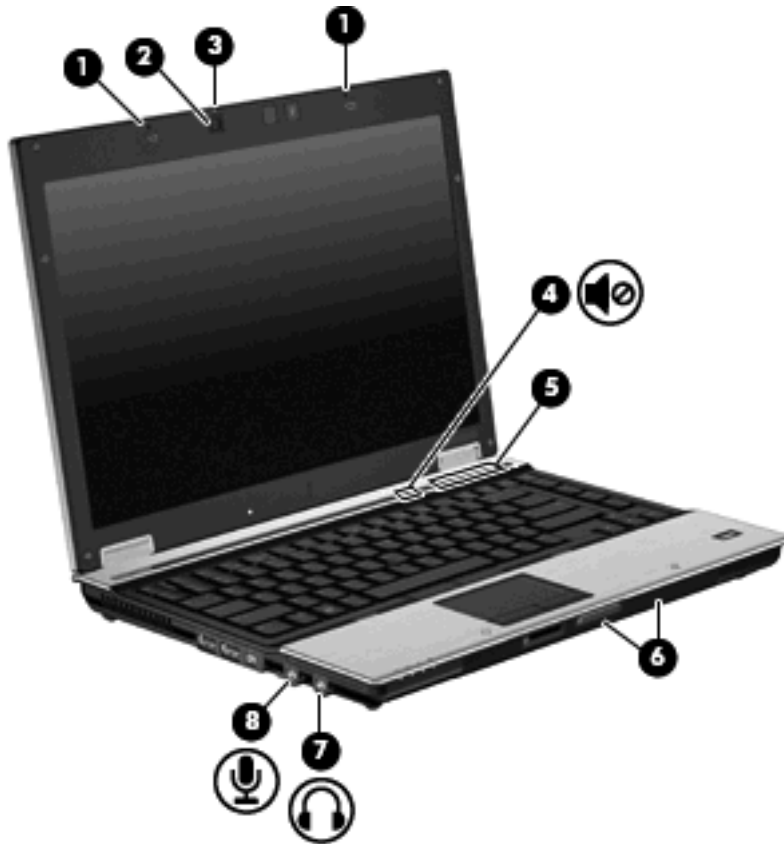

Component	Description
(1) Internal microphones (2)	Record sound.
(2) HP Webcam	Records audio and video and captures still photographs.
(3) HP Webcam light	Turns on when video software accesses the webcam.
(4) Volume mute button	Mutes and restores speaker sound.
(5) Volume scroll zone	Adjusts speaker volume.
(6) Speakers (2)	Produce sound.
(7) Audio-out (headphone) jack	Produces sound when connected to optional powered stereo speakers, headphones, ear buds, a headset, or television audio. NOTE: When a device is connected to the headphone jack, the computer speakers are disabled.
(8) Audio-in (microphone) jack	Connects an optional computer headset microphone, stereo array microphone, or monaural microphone.

Adjusting the volume

You can adjust the volume using the following controls:

- Computer volume buttons:
 - To mute or restore volume, press the mute button **(1)**.
 - To decrease volume, slide your finger across the volume scroll zone from right to left, or press the volume down button **(2)**.
 - To increase volume, slide your finger across the volume scroll zone from left to right, or press the volume up button **(3)**.

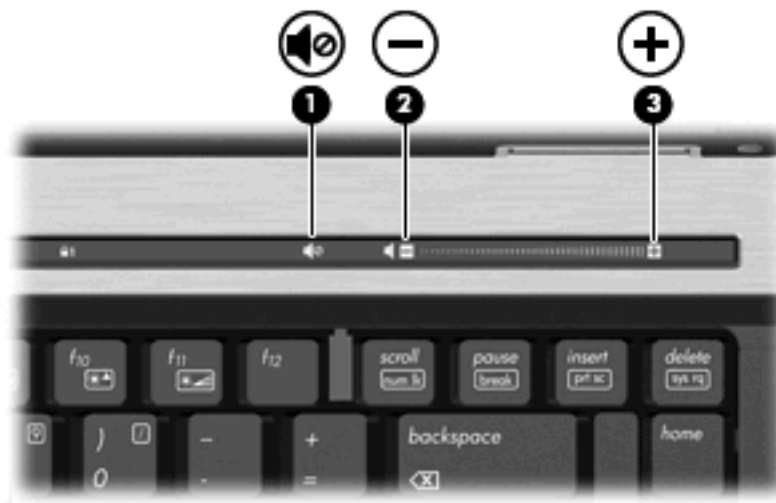

- Windows® volume control:
 - a. Click the **Volume** icon in the notification area, at the far right of the taskbar.
 - b. Increase or decrease the volume by moving the slider up or down. Select the **Mute** check box to mute the volume.

– or –

- a. Double-click the **Volume** icon in the notification area.
- b. In the Speakers column, increase or decrease the volume by moving the **Volume** slider up or down. You can also adjust the balance or mute the volume.

If the Volume icon is not displayed in the notification area, follow these steps to add it:

- a. Select **Start > Control Panel > Sounds, Speech, and Audio Devices > Sounds and Audio Devices > Volume** tab.
 - b. Select the **Place volume icon in the taskbar** check box.
 - c. Click **Apply**.
- Program volume control:

Volume can also be adjusted within some programs.

2 Multimedia software

Your computer includes preinstalled multimedia software that allows you to play music, watch movies, and view pictures. The following sections provide details about preinstalled multimedia software.

Accessing your preinstalled multimedia software

To access your preinstalled multimedia software:

- ▲ Select **Start > All Programs**, and then open the multimedia program you want to use.

 **NOTE:** Some programs may be located in subfolders.

 **NOTE:** For details about using software included with the computer, refer to the software manufacturer's instructions, which may be provided with the software, on disc, or on the manufacturer's Web site.

Installing multimedia software from a disc

To install any multimedia software from a CD or DVD, follow these steps:

1. Insert the disc into the optical drive.
2. When the installation wizard opens, follow the on-screen instructions.
3. Restart the computer if you are prompted to do so.

3 Audio

Your computer enables you to use a variety of audio features:

- Play music using your computer speakers and/or connected external speakers
- Record sound using the internal microphone or connect an external microphone
- Download music from the Internet
- Create multimedia presentations using audio and images
- Transmit sound and images with instant messaging programs
- Stream radio programs (select models only) or receive FM radio signals
- Create or “burn” audio CDs (select models only)

Connecting external audio devices

 **WARNING!** To reduce the risk of personal injury, adjust the volume before putting on headphones, earbuds, or a headset. For additional safety information, refer to the *Regulatory, Safety and Environmental Notices*.

To connect external devices such as external speakers, headphones, or a microphone, refer to the information provided with the device. For best results, remember the following tips:

- Be sure that the device cable is securely connected to the correct jack on your computer. (Cable connectors are normally color-coded to match the corresponding jacks on the computer.)
- Be sure to install any drivers required by the external device.

 **NOTE:** A driver is a required program that acts like a translator between the device and the programs that use the device.

Checking your audio functions

To check the system sound on your computer, follow these steps:

1. Select **Start > Control Panel**.
2. Click **Sounds, Speech, and Audio Devices > Sounds and Audio Devices**.
3. When the Sound and Audio Devices Properties window opens, click the **Sounds** tab. Under **Program events**, select any sound event, such as a beep or alarm, and then click the **Test** button.

You should hear sound through the speakers or through connected headphones.

To check the record functions of the computer, follow these steps:

1. Select **Start > All Programs > Accessories > Entertainment > Sound Recorder**.
2. Click **Record** and speak into the microphone. Save the file to your desktop.
3. Open Windows Media Player and play back the sound.

 **NOTE:** For best results when recording, speak directly into the microphone and record sound in a setting free of background noise.

- ▲ To confirm or change the audio settings on your computer, right-click the **Sound** icon on the taskbar, or select **Start > Control Panel > Sounds, Speech, and Audio Devices > Sounds and Audio Devices**.

4 Video

Your computer enables you to use a variety of video features:

- Watch movies
- Play games over the Internet
- Edit pictures and video to create presentations
- Connect external video devices

Connecting an external monitor or projector

The external monitor port connects an external display device such as an external monitor or a projector to the computer.

- ▲ To connect a display device, connect the device cable to the external monitor port.

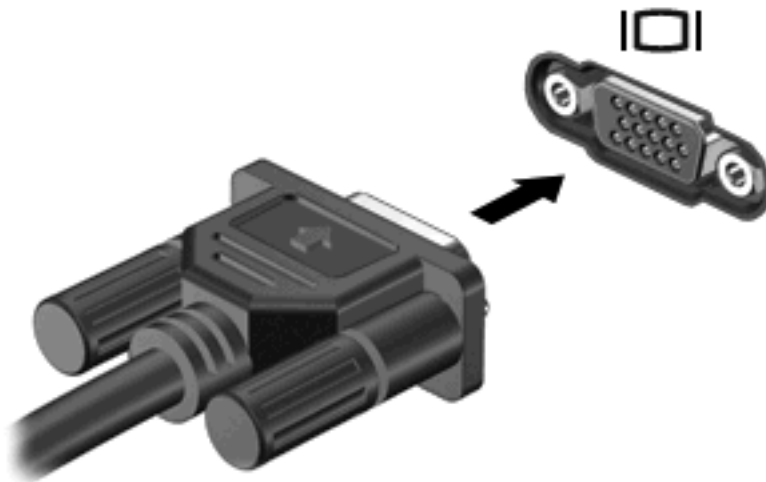

 **NOTE:** If a properly connected external display device does not display an image, press **fn+f4** to transfer the image to the device. Repeatedly pressing **fn+f4** alternates the screen image between the computer display and the device.

5 Optical drive (select models only)

Identifying the installed optical drive

- ▲ Select **Start > My Computer**.

The type of optical drive installed in the computer is displayed under Devices with Removable Storage.

Using optical discs (CDs and DVDs)

An optical drive, such as a DVD-ROM drive, supports optical discs (CDs and DVDs). These discs store or transport information and play music and movies. DVDs have a higher storage capacity than CDs.

All optical drives can read from optical discs and some drives can also write to optical discs, as described in the following table.

 **NOTE:** Some of the optical drives listed may not be supported by your computer. The listed drives are not necessarily all of the supported optical drives.

Optical drive type	Read CD and DVD-ROM media	Write to CD-R/RW media	Write to DVD (includes DVD +R DL, DVD ±RW/R, and DVD-RAM media)	Write label to LightScribe CD or DVD	Read Blu-ray	Write to Blu-ray R/RE
DVD-ROM Drive	Yes	No	No	No	No	No
DVD/CD-RW Combo Drive	Yes	Yes	No	No	No	No
DVD±RW SuperMulti DL* Lightscribe† Drive	Yes	Yes	Yes	Yes	No	No
Blu-ray R/RE DVD±RW SuperMulti DL* Drive	Yes	Yes	Yes	No	Yes	Yes

*Double-layer discs can store more data than single-layer discs. However, double-layer discs burned with this drive may not be compatible with many single-layer DVD drives and players.

†LightScribe discs must be purchased separately. LightScribe creates a grayscale image similar to black-and-white photography.

Playing a CD or DVD

1. Turn on the computer.
 2. Press the release button **(1)** on the drive bezel to release the disc tray.
 3. Pull out the tray **(2)**.
 4. Hold the disc by the edges to avoid touching the flat surfaces and position the disc label-side up over the tray spindle.
-
-  **NOTE:** If the tray is not fully accessible, tilt the disc carefully to position it over the spindle.
5. Gently press the disc **(3)** down onto the tray spindle until the disc snaps into place.

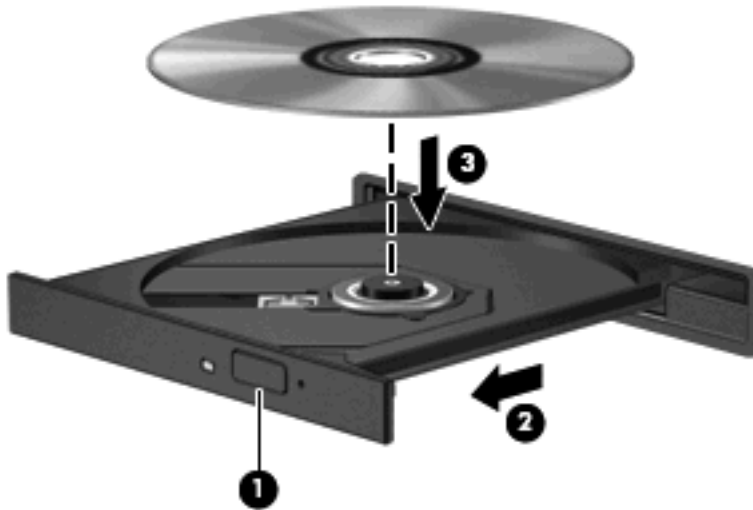

6. Close the disc tray.

If you have not yet configured AutoPlay, as described in the following section, an AutoPlay dialog box opens. It prompts you to select how you want to use the media content.

Configuring AutoPlay

1. Select **Start > My Computer**.
2. Right-click the device (such as CD-ROM drive), and then click **Properties**.
3. Click the **AutoPlay** tab, and then select one of the available actions.
4. Click **OK**.

 **NOTE:** For more information about AutoPlay, refer to Help and Support.

Observing the copyright warning

It is a criminal offense, under applicable copyright laws, to make unauthorized copies of copyright-protected material, including computer programs, films, broadcasts, and sound recordings. Do not use this computer for such purposes.

△ **CAUTION:** To prevent loss of information or damage to a disc, observe the following guidelines:

Before writing to a disc, connect the computer to a reliable external power source. Do not write to a disc while the computer is running on battery power.

Before writing to a disc, close all open programs except the disc software you are using.

Do not copy directly from a source disc to a destination disc or from a network drive to a destination disc.

Do not use the computer keyboard or move the computer while the computer is writing to a disc. The write process is sensitive to vibration.

📄 **NOTE:** For details about using software included with the computer, refer to the software manufacturer's instructions, which may be provided with the software, on disc, or on the manufacturer's Web site.

Copying a CD or DVD

1. Select **Start > All Programs > Roxio > Creator Business**.
2. In the right pane, click **Copy Disc**.
3. Insert the disc you want to copy into the optical drive.
4. Click **Copy** at the bottom right of the screen.

Creator Business reads the source disc and copies the data to a temporary folder on your hard drive.

5. When prompted, remove the source disc from the optical drive and insert a blank disc into the drive.

After the information is copied, the disc you created is ejected automatically.

Creating or “burning” a CD or DVD

If your computer includes a CD-RW, DVD-RW, or DVD+/-RW optical drive, you can use software such as Windows Media Player or Roxio Creator Business to burn data and audio files, including MP3 and WAV music files. To burn video files to a CD or DVD, use Windows Movie Maker.

Observe the following guidelines when burning a CD or DVD:

- Before burning a disc, save and close any open files and close all programs.
- A CD-R or DVD-R is usually best for burning audio files because after the information is copied, it cannot be changed.
- Because some home and car stereos will not play CD-RWs, use CD-Rs to burn music CDs.
- A CD-RW or DVD-RW is generally best for burning data files or for testing audio or video recordings before you burn them to a CD or DVD that cannot be changed.
- DVD players used in home systems usually do not support all DVD formats. Refer to the user guide that came with your DVD player for a list of supported formats.
- An MP3 file uses less space than other music file formats, and the process for creating an MP3 disc is the same as the process for creating a data file. MP3 files can be played only on MP3 players or on computers with MP3 software installed.

To burn a CD or DVD, follow these steps:

1. Download or copy the source files into a folder on your hard drive.
2. Insert a blank CD or DVD into the optical drive.
3. Select **Start > All Programs** and the name of the software you want to use.
4. Select the kind of CD or DVD you want to create—data, audio, or video.
5. Right-click **Start > Explore** and navigate to the folder where the source files are stored.
6. Open the folder, and then drag the files to the drive that contains the blank optical disc.
7. Initiate the burning process as directed by the program you have selected.

Refer to the software Help file or user guide for more specific instructions.

Removing a CD or DVD

1. Press the release button (1) on the drive bezel to release the disc tray, and then gently pull out the tray (2) until it stops.
2. Remove the disc (3) from the tray by gently pressing down on the spindle while lifting the outer edges of the disc. Hold the disc by the edges and avoid touching the flat surfaces.

 **NOTE:** If the tray is not fully accessible, tilt the disc carefully as you remove it.



3. Close the disc tray and place the disc in a protective case.

Preventing playback disruptions

- Save your work and close all open programs before playing a CD or a DVD.
- Log off the Internet before playing a CD or a DVD.
- Be sure that you insert the disc properly.
- Be sure that the disc is clean. If necessary, clean the disc with filtered water and a lint-free cloth. Wipe from the center of the disc to the outer edge.
- Check the disc for scratches. If you find scratches, treat the disc with an optical disc repair kit available at many electronics stores.
- Disable Standby before playing a disc.

Do not initiate Hibernation or Standby while playing a disc. Otherwise, you may see a warning message asking if you want to continue. If this message is displayed, click **No**. After you click No, the computer may behave in either of the following ways:

- Playback may resume.

– or –

- The playback window in the multimedia program may close. To return to playing the disc, click the **Play** button in your multimedia program to restart the disc. In rare cases, you may need to exit the program and then restart it.

- Increase system resources:

Turn off external devices such as printers and scanners. This practice frees up valuable system resources and results in better playback performance.

Change desktop color properties. Because the human eye cannot easily tell the difference between colors beyond 16 bits, you should not notice any loss of color while watching a movie if you lower system color properties to 16-bit color, as follows:

- Right-click anywhere on the desktop—not on an icon—select **Properties > Settings**.
- Set **Colors** to **Medium (16 bit)**.

Changing DVD region settings

Most DVDs that contain copyrighted files also contain region codes. The region codes help protect copyrights internationally.

You can play a DVD containing a region code only if the region code on the DVD matches the region setting on your DVD drive.

△ **CAUTION:** The region settings on your DVD drive can be changed only 5 times.

The region setting you select the fifth time becomes the permanent region setting on the DVD drive.

The number of region changes remaining is displayed on the DVD Region tab.

To change settings through the operating system:

1. Select **Start > My Computer**.
2. Right-click in the window, and select **Properties > Hardware tab > Device Manager**.
3. Click the plus sign (+) next to **DVD/CD-ROM drives**.
4. Right-click the DVD drive for which you want to change region settings, and then click **Properties**.
5. Click the **DVD Region** tab, and change settings.
6. Click **OK**.

6 HP Webcam

Your computer includes an integrated HP Webcam, located at the top of the display. With the preinstalled software, you can use the webcam to take a photo, record a video, or make an audio recording. You can preview the photo, video recording, or audio recording, and save it on your computer hard drive.

To access the webcam and HP Webcam software, select **Start > All Programs > HP Webcam**.

The webcam software enables you to experiment with the following features:

- Video—Record and play back webcam video.
- Audio—Record and play back audio.
- Streaming video—Use with instant message software solutions that support UVC (Universal Video Class) cameras.
- Snapshots—Take still photos.
- HP Presto! Bizcard (select models only)—Use to transform business cards into a usable database of contact information.

Webcam tips

For optimum performance, observe the following guidelines while using the webcam:

- Be sure that you have the latest version of an instant message program before starting a video conversation.
- The webcam may not work properly across some network firewalls. If you are having trouble viewing or sending video to someone on another LAN or outside your network firewall, temporarily disable the firewall.

 **NOTE:** Under some circumstances a firewall can block access to Internet games, interfere with printer or file sharing on a network, or block authorized e-mail attachments. To temporarily solve the problem, disable the firewall, perform the task you want to perform, and then reenable the firewall. To permanently resolve the problem, reconfigure the firewall.

- Whenever possible, place bright light sources behind the webcam and out of the picture area.

 **NOTE:** For details about using your webcam, click the **Help** menu in the webcam software Help.

Adjusting webcam properties

You can adjust the following webcam properties:

- **Brightness**—Controls the amount of light that is incorporated into the image. A higher brightness setting creates a brighter image; a lower brightness setting creates a darker image.
- **Contrast**—Controls the difference between lighter and darker areas on the image. A higher contrast setting intensifies the image; a lower contrast setting maintains more of the original information's dynamic range but leads to a flatter image.
- **Hue**—Controls the aspect of color that distinguishes it from another color (what makes a color red, green, or blue). Hue is distinct from saturation, which measures the intensity of the hue.
- **Saturation**—Controls the strength of color in the final image. A higher saturation setting creates a bolder image; a lower saturation setting creates a more subtle image.
- **Sharpness**—Controls the definition of edges in an image. A higher sharpness setting creates a more defined image; a lower sharpness setting creates a softer image.
- **Gamma**—Controls the contrast affecting the mid-level grays or midtones of an image. Adjusting the gamma of an image allows you to change the brightness values of the middle range of gray tones without dramatically altering the shadows and highlights. A lower gamma setting makes grays look black, and makes dark colors even darker.
- **Backlight Compensation**—Compensates in cases where a subject with a large amount of background light would otherwise be obscured by blooming or silhouetting.
- **NightMode**—Compensates for low-light conditions.
- **Zoom (select models only)**—Adjusts the zoom percentage for taking photos or recording videos.
- **Horizontal or vertical**—Rotates the image horizontally or vertically.
- **50Hz or 60Hz**—Adjusts the shutter speed to achieve a video recording that does not flicker.

Customizable preset profiles for multiple lighting conditions compensate for the following lighting conditions: incandescent, fluorescent, halogen, sunny, cloudy, night.

Controlling the webcam focus mode (select models only)

The following focus mode options are available:

- **Normal**—The factory setting of the camera is appropriate for normal photography. This range extends from several feet in front of the lens to infinity.
- **Macro**—The close-up focus setting, this mode is for taking photos and capturing video at a very close range (select models only).

 **NOTE:** The Bizcard reader (select models only) is always preset to a macro mode setting during its operation.

To view or change the HP Webcam focus mode, follow these steps:

- ▲ Selecting **Start > All Programs > HP Webcam > Settings > Options**.

7 Troubleshooting

The following sections describe several common issues and resolutions.

The optical disc tray does not open for removal of a CD or DVD

1. Insert the end of a paper clip (1) into the release access in the front bezel of the drive.
2. Press in gently on the paper clip until the disc tray is released, and then pull out the tray (2) until it stops.
3. Remove the disc (3) from the tray by gently pressing down on the spindle while lifting the outer edges of the disc. Hold the disc by the edges and avoid touching the flat surfaces.

 **NOTE:** If the tray is not fully accessible, tilt the disc carefully as you remove it.



4. Close the disc tray and place the disc in a protective case.

A disc does not play

- Save your work and close all open programs before playing a CD or a DVD.
- Log off the Internet before playing a CD or a DVD.
- Be sure that you insert the disc properly.
- Be sure that the disc is clean. If necessary, clean the disc with filtered water and a lint-free cloth. Wipe from the center of the disc to the outer edge.
- Check the disc for scratches. If you find scratches, treat the disc with an optical disc repair kit available at many electronics stores.
- Disable Standby before playing a disc.

Do not initiate Hibernation or Standby while playing a disc. Otherwise, you may see a warning message asking if you want to continue. If this message is displayed, click **No**. After you click No, the computer may behave in either of the following ways:

- Playback may resume.
- or –
- The playback window in the multimedia program may close. To return to playing the disc, click the **Play** button in your multimedia program to restart the disc. In rare cases, you may need to exit the program and then restart it.
- Increase system resources:
 - Turn off external devices such as printers and scanners. This practice frees up valuable system resources and results in better playback performance.
 - Change desktop color properties. Because the human eye cannot easily tell the difference between colors beyond 16 bits, you should not notice any loss of color while watching a movie if you lower system color properties to 16-bit color, as follows:
 1. Right-click on a blank area of the computer desktop, and select **Properties > Settings**.
 2. Set **Colors** to **Medium (16 bit)**, if this setting is not already selected.

A disc does not play automatically

1. Select **Start > My Computer**.
2. Right-click the device (such as CD-ROM drive), and then click **Properties**.
3. Click the **AutoPlay** tab, and then select one of the available actions.
4. Click **OK**.



NOTE: For more information about AutoPlay, refer to **Help and Support**.

A DVD movie stops, skips, or plays erratically

- Check to be sure the disc is not scratched or damaged.
- Clean the disc.
- Conserve system resources by trying the following suggestions:
 - Log off the Internet.
 - Change the color properties of the desktop:
 1. Right-click on a blank area of the computer desktop, and select **Properties > Settings**.
 2. Set **Colors** to **Medium (16 bit)**, if this setting is not already selected.
 - Disconnect external devices, such as a printer, scanner, camera, or handheld device.

A DVD movie is not visible on an external display

1. If both the computer display and an external display are turned on, press **fn+f4** one or more times to switch between the 2 displays.
2. Configure the monitor settings to make the external display primary:
 - a. Right-click on a blank area of the computer desktop, and select **Properties > Settings**.
 - b. Specify a primary display and a secondary display.

 **NOTE:** When using both displays, the DVD image will not appear on any display designated as the secondary display.

To get information about a multimedia question not covered in this guide, select **Start > Help and Support**.

A DVD playing in Windows Media Player produces no sound or display

You must use WinDVD, which is preinstalled on the computer, to play a DVD.

The process of burning a disc does not begin, or it stops before completion

- Be sure that all other programs are closed.
- Turn off Standby and Hibernation.
- Be sure that you are using the right kind of disc for your drive. See your user guides for more information about disc types.
- Be sure that the disc is inserted properly.
- Select a slower write speed and try again.
- If you are copying a disc, save the information on the source disc to your hard drive before trying to burn the contents to a new disc, and then burn from your hard drive.
- Reinstall the disc-burning device driver located in the DVD/CD-ROM drives category in Device Manager.

The computer does not detect the optical drive

If the computer does not detect the optical drive, use Device Manager to troubleshoot the device and then update, uninstall, or disable the device driver.

To check your device and drivers in Device Manager, follow these steps:

1. Remove any discs from the optical drive.
2. Select **Start > My Computer**.
3. Right-click in the window and select **Properties > Hardware** tab, and then click **Device Manager**.
4. In the Device Manager window, click the plus sign (+) next to **Disc Drives** or **DVD/CD-ROM drives**, unless a minus sign (-) is already showing. Look for an optical drive listing.
5. Right-click the optical device listing to perform the following tasks:
 - Update the driver.
 - Disable the device.
 - Scan for hardware changes. Windows scans your system for installed hardware and installs any required drivers.
 - Click **Properties** to see if the device is working properly:
 - Click **Troubleshoot** to fix problems.
 - Click the **Driver** tab to update, disable, or uninstall drivers for this device.

A new device driver is needed

Obtaining Microsoft device drivers

Your computer is set to automatically check for and install Microsoft device drivers when new devices are connected to your computer.

Obtaining HP device drivers

You can obtain the latest HP device drivers in either of the following ways:

- Using HP Update
- Using the HP Web site

To use HP Update:

1. Select **Start > All Programs > HP > HP Update**.
2. On the HP Welcome screen, click **Settings**, and then select a time when the utility should check for software updates on the Web.
3. Click **Next** to immediately check for HP software updates.

To use the HP Web site:

1. Open your Internet browser, and go to <http://www.hp.com/support>.
2. Select your country or region.
3. Click the option for software and driver downloads, and then type your computer model number in the product box.
4. Press **enter**, and then follow the on-screen instructions.

Index

- A**
 - audio devices, connecting
 - external 8
 - audio features 7
 - audio functions, checking 9
 - audio-in (microphone) jack 2
 - audio-out (headphone) jack 2
 - AutoPlay 15
- B**
 - button, volume mute 3
- C**
 - CD
 - burning 18
 - copying 17
 - playing 14
 - removing 19
 - CD drive 12
 - checking audio functions 9
 - controlling the webcam focus 25
 - copyright warning 16
- D**
 - device drivers
 - HP devices 35
 - Microsoft devices 35
 - uninstalling, reinstalling 35
 - drives
 - Blu-ray R/RE DVD±RW
 - SuperMulti DL Drive 13
 - CD 12
 - DVD 12
 - DVD-ROM Drive 13
 - DVD/CD-RW Combo Drive 13
 - DVD±RW SuperMulti DL
 - LightScribe Drive 13
 - optical 12
 - DVD
 - burning 18
 - changing region setting 21
 - copying 17
 - playing 14
 - removing 19
 - DVD region settings 21
- E**
 - earbuds 2
 - external audio devices, connecting 8
 - external monitor port 11
- F**
 - focus, webcam 25
- H**
 - headphone (audio-out) jack 2
 - headphones 2
 - HP Webcam
 - adjusting properties 24
 - controlling the focus 25
 - identifying 2
 - tips 23
 - using 22
 - HP Webcam light, identifying 2
- I**
 - internal microphone, identifying 2
 - issues, resolving 26
- J**
 - jacks
 - audio-in (microphone) 2
 - audio-out (headphone) 2
- M**
 - microphone, internal 2
 - monitor, connecting 11
 - multimedia components, identifying 2
 - multimedia software
 - accessing 5
 - installing 6
 - mute button 3
- O**
 - optical discs, using 13
 - optical drive 12
- P**
 - ports, external monitor 11
 - preventing playback disruptions 20
 - projector, connecting 11
- R**
 - region codes, DVD 21
- S**
 - speakers 2
- T**
 - tips, webcam 23
 - troubleshooting
 - device drivers 35
 - disc burning 33
 - disc play 28, 29
 - DVD movie play 30
 - external display 31
 - optical disc tray 27
 - optical drive detection 34
- U**
 - using the webcam 22
- V**
 - video, using 10
 - volume mute button 3
 - volume scroll zone 3
 - volume, adjusting 3

W

webcam

adjusting properties 24

controlling the focus 25

identifying 2

tips 23

using 22

webcam light, identifying 2

