

# Multimedia User Guide

© Copyright 2008 Hewlett-Packard  
Development Company, L.P.

Microsoft and Windows are U.S. registered  
trademarks of Microsoft Corporation.

The information contained herein is subject  
to change without notice. The only  
warranties for HP products and services are  
set forth in the express warranty statements  
accompanying such products and services.  
Nothing herein should be construed as  
constituting an additional warranty. HP shall  
not be liable for technical or editorial errors  
or omissions contained herein.

First Edition: June 2008

Document Part Number: 463796-001

## Product notice

This user guide describes features that are common to most models. Some features may not be available on your computer.



---

# Table of contents

## 1 Multimedia features

Identifying your multimedia components .....	1
Adjusting the volume .....	3
Creating or “burning” a CD or DVD .....	4

## 2 Multimedia software

Accessing your preinstalled multimedia software .....	5
Installing multimedia software from a disc .....	5

## 3 Audio

Connecting external audio devices .....	6
Checking your audio functions .....	6

## 4 Video

Connecting an optional external monitor or projector .....	8
Connecting an optional S-Video device .....	9

## 5 HP Webcam (select models only)

Webcam tips .....	10
Adjusting webcam preferences .....	10
Controlling the webcam focus (select models only) .....	11
For more information .....	11

## 6 Troubleshooting

The optical disc tray does not open for removal of a CD or DVD .....	12
The computer does not detect the optical drive .....	12
A new device driver is needed .....	13
A disc does not play .....	13
A disc does not play automatically .....	14
A DVD movie is not visible on an external display .....	14
The process of burning a disc does not begin, or it stops before completion .....	14

<b>Index .....</b>	<b>16</b>
--------------------	-----------



---

# 1 Multimedia features

Your computer includes multimedia features that allow you to listen to music and view photos and video. Your computer may include the following multimedia components:

- Integrated stereo speakers for listening to music
- Integrated microphone for recording your own audio
- Integrated HP Webcam that allows you to capture and share video (select models only)
- Preinstalled multimedia software that allows you to play and manage your music, movies, and photos and video
- Hotkeys that provide fast access to multimedia tasks

---

 **NOTE:** Your computer may not include all of the components listed.

---

The following sections explain how to identify and use the multimedia components included with your computer.

## Identifying your multimedia components

The following illustration and table describe the multimedia features of the computer.



Component	Description
(1) Internal microphones (2) (select models only)	Record sound. <b>NOTE:</b> Some models have one internal microphone.
(2) HP Webcam (select models only)	Records audio and video and captures still photographs.
(3) Speakers (2)	Produce sound.
(4) Audio-out (headphone) jack	Produces sound when connected to optional powered stereo speakers, headphones, ear buds, or a headset. <b>WARNING!</b> To reduce the risk of personal injury, adjust the volume before putting on headphones, earbuds, or a headset. For additional safety information, refer to the <i>Regulatory, Safety and Environmental Notices</i> . <b>NOTE:</b> When a device is connected to the headphone jack, the computer speakers are disabled.
(5) Audio-in (microphone) jack	Connects an optional computer headset microphone, stereo array microphone, or monaural microphone.



## Adjusting the volume

You can adjust the volume using the following controls:

- Computer volume buttons (select models only):
  - To mute or restore volume, press the mute button **(1)**.
  - To decrease volume, slide your finger across the volume scroll zone **(2)** from right to left.
  - To increase volume, slide your finger across the volume scroll zone **(2)** from left to right.

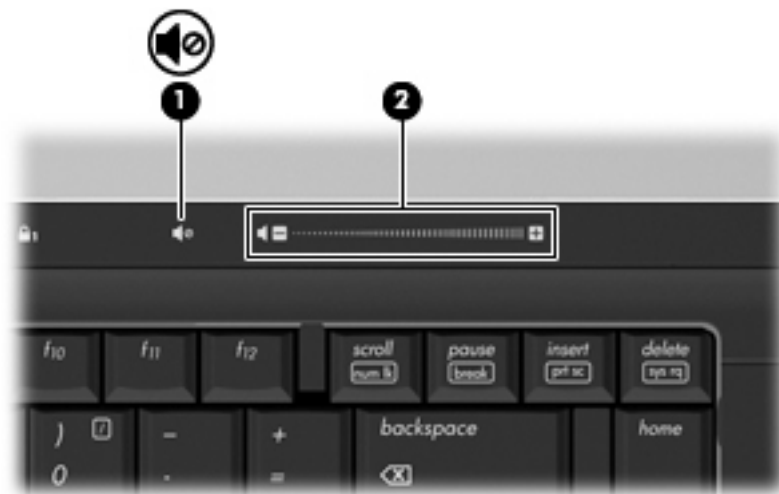

- Windows® volume control:
  - a. Click the **Volume** icon in the notification area, at the far right of the taskbar.
  - b. Increase or decrease the volume by moving the slider up or down. Click the **Mute** icon to mute the volume.

– or –

- a. Right-click the **Volume** icon in the notification area, and then click **Open Volume Mixer**.
- b. In the Speakers column, you can increase or decrease the volume by moving the **Volume** slider up or down. You can also mute the volume by clicking the **Mute** icon.

If the Volume icon is not displayed in the notification area, follow these steps to add it:

- a. Right-click in the notification area, and then click **Properties**.
  - b. Click the **Notification Area** tab.
  - c. Under System icons, select the **Volume** check box.
  - d. Click **OK**.
- Program volume control:

Volume can also be adjusted within some programs.

## Creating or “burning” a CD or DVD

If your optical drive is a CD-RW, DVD-RW, or DVD±RW optical drive, you can use software such as Windows Media Player to burn data and audio files, including MP3 and WAV music files. To burn video files to a CD or DVD, use MyDVD.

Observe the following guidelines when burning a CD or DVD:

- Before burning a disc, save and close any open files and close all programs.
- A CD-R or DVD-R is usually best for burning audio files because after the information is copied, it cannot be changed.
- Because some home and car stereos will not play CD-RWs, use CD-Rs to burn music CDs.
- A CD-RW or DVD-RW is generally best for burning data files or for testing audio or video recordings before you burn them to a CD or DVD that cannot be changed.
- DVD players used in home systems usually do not support all DVD formats. Refer to the user guide that came with your DVD player for a list of supported formats.
- An MP3 file uses less space than other music file formats, and the process for creating an MP3 disc is the same as the process for creating a data file. MP3 files can be played only on MP3 players or on computers with MP3 software installed.

To burn a CD or DVD, follow these steps:

1. Download or copy the source files into a folder on your hard drive.
2. Insert a blank CD or DVD into the optical drive.
3. Select **Start > All Programs** and the name of the software you want to use.
4. Select the kind of CD or DVD you want to create—data, audio, or video.
5. Right-click **Start**, click **Explore**, and navigate to the folder where the source files are stored.
6. Open the folder, and then drag the files to the drive that contains the blank optical disc.
7. Initiate the burning process as directed by the program you have selected.

For specific instructions, refer to the software manufacturer's instructions, which may be provided with the software, on disc, or on the manufacturer's Web site.

---

△ **CAUTION:** Observe the copyright warning. It is a criminal offense, under applicable copyright laws, to make unauthorized copies of copyright-protected material, including computer programs, films, broadcasts, and sound recordings. Do not use this computer for such purposes.

---

---

## 2 Multimedia software

Your computer includes preinstalled multimedia software that allows you to play music and view photos and video. The following section provides details about how to access your preinstalled software.

### Accessing your preinstalled multimedia software

To access your preinstalled multimedia software:

- ▲ Select **Start > All Programs**, and then open the multimedia program you want to use.

 **NOTE:** Some programs may be located in subfolders.

---

### Installing multimedia software from a disc

To install any multimedia software from a CD or DVD, follow these steps:

1. Insert the disc into the optical drive.
2. When the installation wizard opens, follow the on-screen instructions.
3. Restart the computer if you are prompted to do so.

 **NOTE:** For details about using software included with the computer, refer to the software manufacturer's instructions, which may be provided with the software, on disc, or on the manufacturer's Web site.

---

---

## 3 Audio

Your computer enables you to use a variety of audio features:

- Play music using your computer speakers and/or connected external speakers
- Record sound using the internal microphone or connect an external microphone
- Download music from the Internet
- Create multimedia presentations using audio and images
- Transmit sound and images with instant messaging programs
- Stream audio (select models only)
- Create or “burn” audio CDs

### Connecting external audio devices

To connect external devices such as external speakers, headphone, or a microphone, refer to the information provided with the device. For best results, remember the following tips:

- Be sure that the device cable is securely connected to the correct jack on your computer. (Cable connectors are normally color-coded to match the corresponding jacks on the computer.)
- Be sure to install any drivers required by the external device.

---

 **NOTE:** A driver is a required program that acts like a translator between the device and the programs that use the device.

---

### Checking your audio functions

To check the system sound on your computer, follow these steps:

1. Select **Start > Control Panel**.
2. Click **Hardware and Sound**.
3. Click **Sound**.
4. When the Sound window opens, click the **Sounds** tab. Under **Program**, select any sound event, such as a beep or alarm, and click the **Test** button.

You should hear sound through the speakers or through connected headphones.

To check the record functions of the computer, follow these steps:

1. Select **Start > All Programs > Accessories > Sound Recorder**.
2. Click **Record** and speak into the microphone. Save the file to your desktop.
3. Open Windows Media Player and play back the sound.

---

 **NOTE:** For best results when recording, speak directly into the microphone and record sound in a setting free of background noise.

---

- ▲ To confirm or change the audio settings on your computer, right-click the **Sound** icon on the taskbar, or select **Start > Control Panel > Audio**.

---

## 4 Video

Your computer enables you to use a variety of video features:

- Play games over the Internet
- Edit pictures and video to create presentations
- Connect external video devices

### Connecting an optional external monitor or projector

The external monitor port connects an external display device such as an external monitor or a projector to the computer.

- ▲ To connect a display device, connect the device cable to the external monitor port.

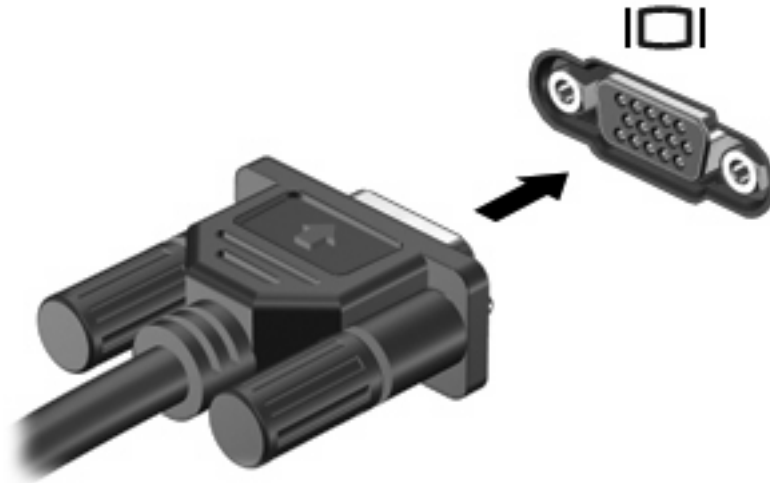

---

**NOTE:** If a properly connected external display device does not display an image, press **fn+f4** to transfer the image to the device. Repeatedly pressing **fn+f4** alternates the screen image between the computer display and the device.

---

## Connecting an optional S-Video device

The 4-pin S-Video-out jack connects the computer to an optional S-Video device such as a television, VCR, camcorder, overhead projector, or video capture card.

To transmit video signals through the S-Video-out jack, you need an S-Video cable, available from most electronics retailers. If you are combining audio and video functions, such as playing a DVD movie on your computer and displaying it on your television, you also need a standard audio cable, available from most electronics retailers, to connect to the headphone jack.

The computer can support one S-Video device connected to the S-Video-out jack, while simultaneously supporting an image on the computer display or on any other supported external display.

 **NOTE:** The S-Video connection provides a higher quality image than a composite-video connection.

To connect a video device to the S-Video-out jack:

1. Plug one end of the S-Video cable into the S-Video-out jack on the computer.

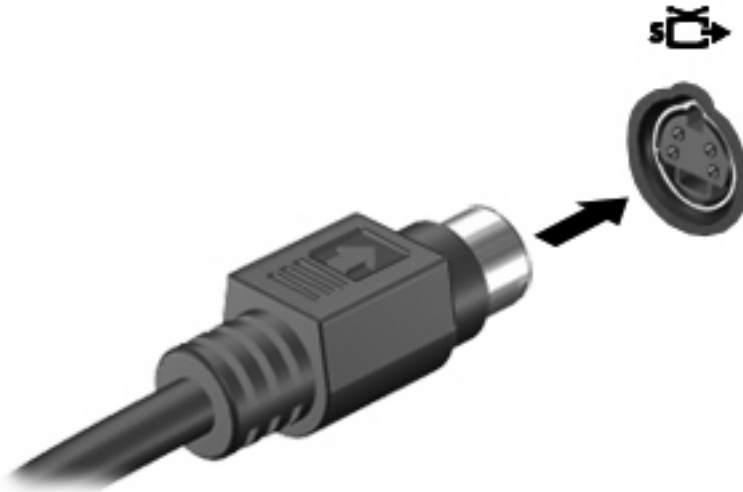

2. Plug the other end of the cable into the video device, as instructed in the user guide included with the device.
3. Press the **fn+f4** keys to switch the image between display devices connected to the computer.

---

## 5 HP Webcam (select models only)

Your computer may include an integrated webcam, located at the top of the display. With the preinstalled software, you can use the webcam to take a photo, record a video, or make an audio recording. You can preview the photo, video recording, or audio recording, and save it on your computer hard drive.

To access the webcam and webcam software, select **Start > Programs > HP Webcam**.

The webcam software enables you to experiment with the following features:

- Video—Record and play back webcam video.
- Audio—Record and play back audio.
- Streaming video—Use with instant message software that supports UVC (Universal Video Class) cameras.
- Snapshots—Take still photos.
- HP Presto! Bizcard (select models only)—Use to transform business cards into a usable database of contact information.

### Webcam tips

For optimum performance, observe the following guidelines while using the webcam:

- Be sure that you have the latest version of an instant message program before starting a video conversation.
- The webcam may not work properly across some network firewalls.

 **NOTE:** If you are having trouble viewing or sending multimedia files to someone on another LAN or outside your network firewall, temporarily disable the firewall, perform the task you want to perform, and then reenable the firewall. To permanently resolve the problem, reconfigure the firewall as necessary, and adjust the policies and settings of other intrusion detection systems. For additional information, contact your network administrator or IT department.

- Whenever possible, place bright light sources behind the webcam and out of the picture area.

### Adjusting webcam preferences

You can adjust webcam preferences, including the following:

- **Brightness**—Controls the amount of light that is incorporated into the image. A higher brightness setting creates a brighter image; a lower brightness setting creates a darker image.
- **Contrast**—Controls the difference between lighter and darker areas on the image. A higher contrast setting intensifies the image; a lower contrast setting maintains more of the original information's dynamic range but leads to a flatter image.
- **Hue**—Controls the aspect of color that distinguishes it from another color (what makes a color red, green, or blue). Hue is distinct from saturation, which measures the intensity of the hue.
- **Saturation**—Controls the strength of color in the final image. A higher saturation setting creates a bolder image; a lower saturation setting creates a more subtle image.



- **Sharpness**—Controls the definition of edges in an image. A higher sharpness setting creates a more defined image; a lower sharpness setting creates a softer image.
- **Gamma**—Controls the contrast affecting the mid-level grays or midtones of an image. Adjusting the gamma of an image allows you to change the brightness values of the middle range of gray tones without dramatically altering the shadows and highlights. A lower gamma setting makes grays look black, and makes dark colors even darker.
- **Backlight Compensation**—Compensates in cases where a subject with a large amount of background light would otherwise be obscured by blooming or silhouetting.
- **NightMode**—Compensates for low light conditions.
- **Zoom (select models only)**—Adjusts the zoom percentage for taking photos or recording videos.
- **Horizontal or vertical**—Rotates the image horizontally or vertically.
- **50Hz or 60Hz**—Adjusts the shutter speed to achieve a video recording that does not flicker.

Customizable preset profiles for multiple lighting conditions compensate for the following lighting conditions: incandescent, fluorescent, halogen, sunny, cloudy, night.

## Controlling the webcam focus (select models only)

You can control the webcam focus by selecting **Start > All Programs > HP Webcam > HP Webcam > Settings > Options**.

The following focus options are available:

- **Normal**—The default setting, appropriate for normal photography. This range extends from several feet in front of the lens to infinity.
- **Macro**—The close-up setting, for taking photos and capturing video at a very close range (select models only).

---

 **NOTE:** The Bizcard reader (select models only) operates on the macro setting.

---

## For more information

For details about using your webcam, select the Help menu in the software Help.

---

## 6 Troubleshooting

The following sections describe several common issues and resolutions.

### The optical disc tray does not open for removal of a CD or DVD

1. Insert the end of a paper clip (1) into the release access in the front bezel of the drive.
2. Press in gently on the paper clip until the disc tray is released, and then pull out the tray (2) until it stops.
3. Remove the disc (3) from the tray by gently pressing down on the spindle while lifting the outer edges of the disc. Hold the disc by the edges and avoid touching the flat surfaces.



**NOTE:** If the tray is not fully accessible, tilt the disc carefully as you remove it.

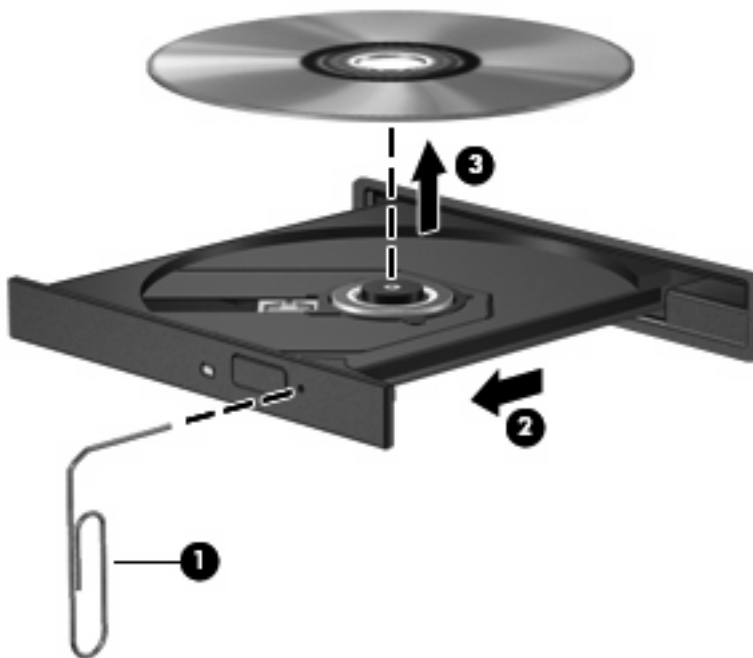

4. Close the disc tray and place the disc in a protective case.

### The computer does not detect the optical drive

If Windows does not detect the optical drive, use the Device Manager to troubleshoot the device and update, uninstall, or roll back the device driver.

To check your device and drivers in Device Manager, follow these steps:

1. Remove any discs from the optical drive.
2. Select **Start > Control Panel > System and Maintenance > Device Manager**. If prompted by User Account Control, click **Continue**.
3. In the Device Manager window, click the plus sign (+) next to **Disc Drives** or **DVD/CD-ROM drives**, unless a minus sign (-) is already showing. Look for an optical drive listing.
4. Right-click the optical device to perform the following tasks:
  - Update the driver.
  - Uninstall the device.
  - Scan for hardware changes. Windows scans your system for installed hardware and installs any required default drivers.
  - Click **Properties** to see if the device is working properly.
    - Click **Troubleshoot** to fix problems.
    - Click the **Driver** tab to update, roll back, disable, or uninstall drivers for this device.

## A new device driver is needed

### Obtaining Microsoft device drivers

Your computer is set to automatically check for and install updates for the most recent Windows operating system and other Microsoft products.

### Obtaining HP device drivers

Follow these steps to obtain HP device drivers:

1. Select **Start > All Programs > HP > HP Update**.
2. On the HP Welcome screen, click **Settings** and select a time when the utility should check for software updates on the Web.
3. Click **Next** to immediately check for HP software updates.

To use the HP Web site:

1. Open your Internet browser and go to <http://www.hp.com/support>.
2. Select your country or region.
3. Click the option for software and driver downloads, and then type your computer model number in the search box.
4. Press **enter**, and then follow the on-screen instructions.

## A disc does not play

- Save your work and close all open programs before playing a CD or a DVD.
- Log off the Internet before playing a CD or a DVD.
- Be sure that you insert the disc properly.

- Be sure that the disc is clean. If necessary, clean the disc with filtered water and a lint-free cloth. Wipe from the center of the disc to the outer edge.
- Check the disc for scratches. If you find scratches, treat the disc with an optical disc repair kit available at many electronics stores.
- Disable Sleep mode before playing the disc.

Do not initiate Hibernation or Sleep while playing a disc. Otherwise, you may see a warning message asking if you want to continue. If this message is displayed, click **No**. After you click No, the computer may behave in either of the following ways:

- Playback may resume.
- or –
- The playback window in the multimedia program may close. To return to playing the disc, click the **Play** button in your multimedia program to restart the disc. In some cases, you may need to exit the program and then restart it.
- Increase system resources by turning off external devices connected to the computer.

## A disc does not play automatically

1. Click **Start** and type `autoplay` in the **Start Search** box.  
As you type, search results are listed in the pane above the box.
2. In the results pane, click **Autoplay**. If prompted by User Account Control, click **Continue**.
3. Select the check box for **Use AutoPlay for all media and devices**, and then click **Save**.  
A CD or DVD should now start automatically when it is inserted into the optical drive.

## A DVD movie is not visible on an external display

1. If both the computer display and an external display are turned on, press `fn+f4` one or more times to switch between the 2 displays.
2. Configure the monitor settings to make the external display primary:
  - a. Right-click on a blank area of the computer desktop, and select **Personalize > Display Settings**.
  - b. Specify a primary display and a secondary display.

 **NOTE:** When using both displays, the DVD image will not appear on any display designated as the secondary display.

To get information about a multimedia question not covered in this guide, select **Start > Help and Support**.

## The process of burning a disc does not begin, or it stops before completion

- Be sure that all other programs are closed.
- Turn off Sleep mode and Hibernation.

- Be sure that you are using the right kind of disc for your drive. See your user guides for more information about disc types.
- Be sure that the disc is inserted properly.
- Select a slower write speed and try again.
- If you are copying a disc, save the information on the source disc to your hard drive before trying to burn the contents to a new disc, and then burn from your hard drive.
- Reinstall the disc-burning device driver located in the DVD/CD-ROM drives category in Device Manager.

---

# Index

## A

- audio devices, connecting
  - external 6
- audio features 6
- audio functions, checking 6
- audio-in (microphone) jack, identifying 2
- audio-out (headphone) jack, identifying 2

## B

- button, volume mute 3

## C

- checking audio functions 6

## E

- earbuds 2
- external audio devices, connecting 6
- external monitor port 8

## H

- headphone (audio-out) jack 2
- headphones 2

## I

- internal microphone, identifying 2
- issues, resolving 12

## J

- jacks
  - audio-in (microphone) 2
  - audio-out (headphone) 2
  - S-Video-out 9

## M

- microphone (audio-in) jack 2
- microphone, internal 2
- monitor, connecting 8
- multimedia components, identifying 1
- multimedia software 5
- multimedia software, installing 5
- mute button 3

## P

- ports, external monitor 8
- projector, connecting 8

## S

- S-Video-out jack 9
- speakers 2

## T

- tips, webcam 10
- troubleshooting
  - disc burning 14
  - disc play 13, 14
  - DVD movie play 14
  - HP device drivers 13
  - optical disc tray 12
  - optical drive detection 12
  - Windows device drivers 13

## V

- video, using 8
- volume mute button 3
- volume, adjusting 3

## W

- webcam 2
- webcam preferences, adjusting 10
- webcam tips 10
- webcam, identifying 2
- webcam, using 10

