

Power Management User Guide

© Copyright 2008 Hewlett-Packard
Development Company, L.P.

Windows is a U.S. registered trademark of
Microsoft Corporation.

The information contained herein is subject
to change without notice. The only
warranties for HP products and services are
set forth in the express warranty statements
accompanying such products and services.
Nothing herein should be construed as
constituting an additional warranty. HP shall
not be liable for technical or editorial errors
or omissions contained herein.

First Edition: June 2008

Document Part Number: 463793-001

Product notice

This user guide describes features that are common to most models. Some features may not be available on your computer.

Table of contents

1 Power control and light locations

2 Shutting down the computer

3 Setting power options

Using power-saving states	4
Initiating and exiting Standby	4
Initiating and exiting Hibernation	5
Using the Power Meter	6
Using power schemes	7
Viewing the current scheme	7
Selecting a different power scheme	7
Customizing power schemes	7
Setting password protection upon exiting Standby	8

4 Using battery power

Finding battery information in Help and Support	10
Displaying the remaining battery charge	11
Inserting or removing the battery	12
Charging a battery	13
Managing low battery levels	14
Identifying low battery levels	14
Resolving a low battery level	15
Resolving a low battery level when external power is available	15
Resolving a low battery level when a charged battery is available	15
Resolving a low battery level when no power source is available	15
Resolving a low battery level when the computer cannot exit Hibernation	15
Calibrating a battery	16
Step 1: Fully charge the battery	16
Step 2: Disable Hibernation and Standby	16
Step 3: Discharge the battery	17
Step 4: Fully recharge the battery	18
Step 5: Reenable Hibernation and Standby	18
Conserving battery power	19

Storing a battery	20
Disposing of a used battery	21

5 Using external AC power

Connecting the AC adapter	23
---------------------------------	----

Index	24
--------------------	-----------

1 Power control and light locations

The following illustration and table identify and describe the power control and light locations.

 **NOTE:** Your computer may look slightly different from the illustration in this section.

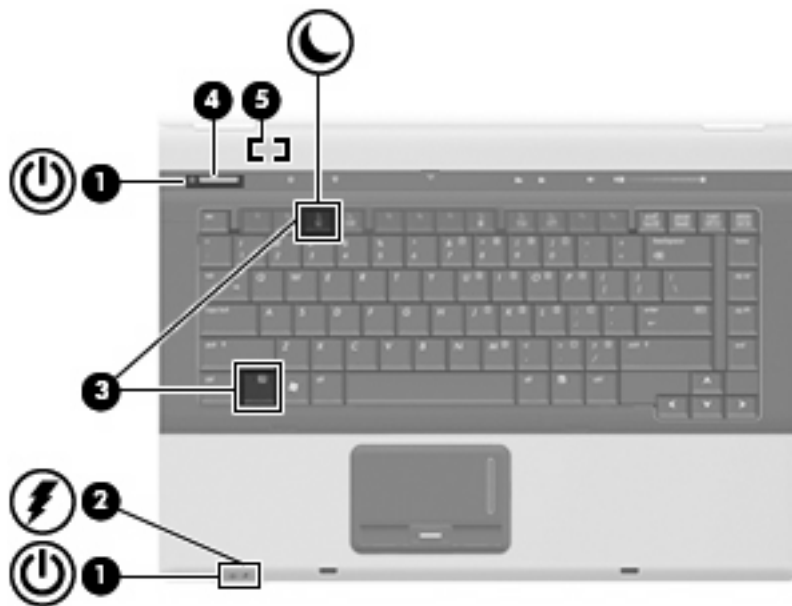

Component	Description
(1) Power lights (2)*	<ul style="list-style-type: none">• On: The computer is on.• Blinking: The computer is in Standby.• Off: The computer is off or in Hibernation.
(2) Battery light	<ul style="list-style-type: none">• Amber: A battery is charging.• Turquoise: A battery is close to full charge capacity.• Blinking amber: A battery that is the only available power source has reached a low battery level. When the battery reaches a critical battery level, the battery light begins blinking rapidly.• Off: If the computer is plugged into an external power source, the light turns off when all batteries in the computer are fully charged. If the computer is not plugged into an external power source the light stays off until the battery reaches a low battery level.

Component	Description
(3) fn+f3	Initiates Standby.
(4) Power button	<ul style="list-style-type: none"> • When the computer is off, press the button to turn on the computer. • When the computer is on, press the button to shut down the system. • When the computer is in Standby, press the button briefly to exit Standby. • When the computer is in Hibernation, press the button briefly to exit Hibernation. <p>If the computer has stopped responding and Windows® shutdown procedures are ineffective, press and hold the power button for at least 5 seconds to turn off the computer.</p> <p>To learn more about your power settings, select Start > Control Panel > Performance and Maintenance > Power Options.</p>
(5) Internal display switch	Turns off the display if the display is closed while the power is on.

*The 2 power lights display the same information. The light on the power button is visible only when the computer is open. The power light on the front of the computer is visible whether the computer is open or closed.

2 Shutting down the computer

△ **CAUTION:** Unsaved information will be lost when the computer is shut down.

The Shut Down command closes all open programs, including the operating system, and then turns off the display and computer.

Shut down the computer under any of the following conditions:

- When you need to replace the battery or access components inside the computer
- When you are connecting an external hardware device that does not connect to a USB port or a 1394 port
- When the computer will be unused and disconnected from external power for an extended period

To shut down the computer, follow these steps:

 **NOTE:** If the computer is in Standby or in Hibernation, you must first exit Standby or Hibernation before shutdown is possible.

1. Save your work and close all open programs.
2. Select **Start > Turn Off Computer > Turn Off**.

 **NOTE:** If you have been registered to a network domain, the button you click will be called Shut Down instead of Turn Off Computer.

If the computer is unresponsive and you are unable to use the preceding shutdown procedures, try the following emergency procedures in the sequence provided:

- Press and hold the power button for at least 5 seconds.
- Disconnect the computer from external power and remove the battery.

3 Setting power options

Using power-saving states

The computer has two power-saving states enabled at the factory: Standby and Hibernation.

When Standby is initiated, the power lights blink and the screen clears. Your work is saved to memory. Exiting Standby is faster than exiting Hibernation. If the computer is in Standby for an extended period or if the battery reaches a critical battery level while in Standby, the computer initiates Hibernation.

When Hibernation is initiated, your work is saved to a hibernation file on the hard drive and the computer turns off.

 **CAUTION:** To prevent possible audio and video degradation, loss of audio or video playback functionality, or loss of information, do not initiate Standby or Hibernation while reading from or writing to a disc or an external media card.

 **NOTE:** You cannot initiate any type of networking connection or perform any computer functions while the computer is in Standby or in Hibernation.

NOTE: When HP 3D DriveGuard has parked a drive, the computer will not initiate Standby or Hibernation, and the display will be turned off.

Initiating and exiting Standby

The system is set at the factory to initiate Standby after 10 minutes of inactivity when running on battery power and 25 minutes of inactivity when running on external power.

Power settings and timeouts can be changed using Power Options in Windows® Control Panel.

With the computer on, you can initiate Standby in any of the following ways:

- Press **fn+f3**.
- Click **Start > Turn Off Computer > Stand By**.

If Stand by is not displayed, follow these steps:

- a. Click the down arrow.
- b. Select **Stand by** from the list.
- c. Click **OK**.

To exit Standby:

- ▲ Press the power button.

When the computer exits Standby, the power lights turn on and your work returns to the screen where you stopped working.

 **NOTE:** If you have set a password to be required when the computer exits Standby, you must enter your Windows password before your work will return to the screen.

Initiating and exiting Hibernation

The system is set at the factory to initiate Hibernation after 30 minutes of inactivity when running on battery power or when the battery reaches a critical battery level.

 **NOTE:** The system will not initiate Hibernation when running on external power.

Power settings and timeouts can be changed using Power Options in Windows Control Panel.

To initiate Hibernation:

1. Select **Start > Turn Off Computer**.
2. Hold down the **shift** key and select **Hibernate**.

If Hibernate is not displayed, follow these steps:

- a. Click the down arrow.
- b. Select **Hibernate** from the list.
- c. Click **OK**.

To exit Hibernation:

- ▲ Press the power button.

The power lights turn on and your work returns to the screen where you stopped working.

 **NOTE:** If you have set a password to be required when the computer exits Hibernation, you must enter your Windows password before your work will return to the screen.

Using the Power Meter

The Power Meter is located in the notification area, at the far right of the taskbar. The Power Meter allows you to quickly access power settings and view the remaining battery charge.

- To access Power Options, right-click the **Power Meter** icon and select **Adjust Power Properties**.
- To display the percentage of remaining battery charge, double-click the **Power Meter** icon.

Different battery meter icons indicate whether the computer is running on battery or external power.

To remove the Power Meter icon from the notification area, follow these steps:

1. Right-click the **Power Meter** icon in the notification area, and then click **Adjust Power Properties**.
2. Click the **Advanced** tab.
3. Clear the **Always show icon on the taskbar** check box.
4. Click **Apply**, and then click **OK**.

To show the Power Meter icon in the notification area, follow these steps:

1. Select **Start > Control Panel > Performance and Maintenance > Power Options**.
2. Click the **Advanced** tab.
3. Select the **Always show icon on the taskbar** check box.
4. Click **Apply**, and then click **OK**.

 **NOTE:** If you cannot see an icon you have placed in the notification area, click the **Show Hidden Icons** icon (< or <<) in the notification area.

Using power schemes

A power scheme is a collection of system settings that manages how the computer uses power. Power schemes can help you conserve power and maximize computer performance.

The following power schemes are available:

- Portable/Laptop (recommended)
- Home/Office Desk
- Presentation
- Always On
- Minimal Power Management
- Max Battery

You can change the settings of these power plans through Power Options.

Viewing the current scheme

▲ Click the **Power Meter** icon in the notification area, at the far right of the taskbar.

– or –

Select **Start > Control Panel > Performance and Maintenance > Power Options**.

Selecting a different power scheme

▲ Click the **Power Meter** icon in the notification area, at the far right of the taskbar, and then select a power scheme from the list.

– or –

- a. Select **Start > Control Panel > Performance and Maintenance > Power Options**.
- b. Select a power scheme from the **Power schemes** list.
- c. Click **OK**.

Customizing power schemes

1. Select **Start > Control Panel > Performance and Maintenance > Power Options**.
2. Select a power scheme from the **Power schemes** list.
3. Modify the **Plugged in** and **Running on batteries settings** as needed.
4. Click **OK**.

Setting password protection upon exiting Standby

To set the computer to prompt for a password when the computer exits Standby, follow these steps:

1. Right-click the **Power Meter** icon in the notification area, and then click **Adjust Power Properties**.
2. Click the **Advanced** tab.
3. Select the **Prompt for password when computer resumes from standby** check box.
4. Click **Apply**.

4 Using battery power

When a charged battery is in the computer and the computer is not plugged into external power, the computer runs on battery power. When the computer is plugged into external AC power, the computer runs on AC power.

If the computer contains a charged battery and is running on external AC power supplied through the AC adapter, the computer switches to battery power if the AC adapter is disconnected from the computer.

 **NOTE:** The display brightness is decreased to save battery life when you disconnect AC power. To increase display brightness, use the **fn+f10** hotkey or reconnect the AC adapter.

You can keep a battery in the computer or in storage, depending on how you work. Keeping the battery in the computer whenever the computer is plugged into AC power charges the battery and also protects your work in case of a power outage. However, a battery in the computer slowly discharges when the computer is off and unplugged from external power.

 **WARNING!** To reduce potential safety issues, use only the battery provided with the computer, a replacement battery provided by HP, or a compatible battery purchased from HP.

Computer battery life varies, depending on power management settings, programs running on the computer, display brightness, external devices connected to the computer, and other factors.

Finding battery information in Help and Support

To locate battery information for your computer, select **Start > Help and Support > Learn More About Your PC**.

Displaying the remaining battery charge

- ▲ Double-click the **Power Meter** icon in the notification area, at the far right of the taskbar.

– or –

Select **Start > Control Panel > Performance and Maintenance > Power Options > Power Meter** tab.

Most charge indicators report battery status as both a percentage and as the number of minutes of charge remaining:

- The percentage indicates the approximate amount of charge remaining in the battery.
- The time indicates the approximate running time remaining on the battery *if the battery continues to provide power at the current level*. For example, the time remaining will decrease when a DVD is playing and will increase when a DVD stops playing.

When a battery is charging, a lightning bolt icon may be superimposed over the battery icon on the Power Meter screen.

Inserting or removing the battery

△ **CAUTION:** Removing a battery that is the sole power source can cause loss of information. To prevent loss of information, initiate Hibernation or shut down the computer through Windows before removing the battery.

To insert the battery:

1. Turn the computer upside down on a flat surface, with the battery bay toward you.
2. Insert the battery into the battery bay (1) until it is seated.

The battery release latch (2) automatically locks the battery into place.

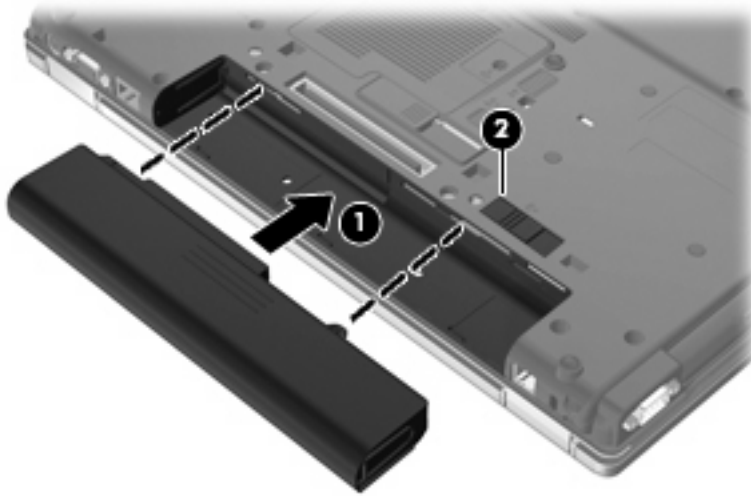

To remove the battery:

1. Turn the computer upside down on a flat surface, with the battery bay toward you.
2. Slide the battery release latch (1) to release the battery.
3. Remove the battery (2).

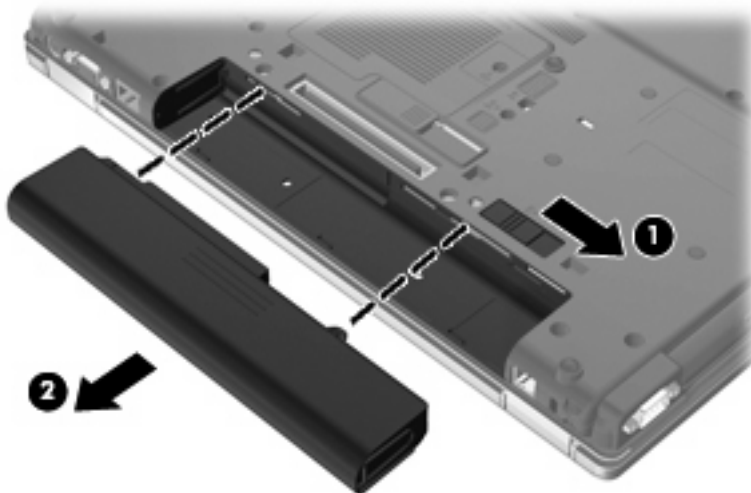

Charging a battery

 **WARNING!** Do not charge the computer battery while you are onboard aircraft.

The battery charges whenever the computer is plugged into external power through an AC adapter, an optional power adapter, an optional expansion product, or an optional docking device.

The battery charges whether the computer is off or in use, but it charges faster when the computer is off.

Charging may take longer if a battery is new, has been unused for 2 weeks or more, or is much warmer or cooler than room temperature.

To prolong battery life and optimize the accuracy of battery charge displays, follow these recommendations:

- If you are charging a new battery, charge it fully before turning on the computer.
- Charge the battery until the battery light turns off.

 **NOTE:** If the computer is on while the battery is charging, the battery meter in the notification area may show 100 percent charge before the battery is fully charged.

- Allow the battery to discharge below 5 percent of a full charge through normal use before charging it.
- If the battery has been unused for one month or more, calibrate the battery instead of simply charging it.

The battery light displays charge status:

- Amber: A battery is charging.
- Turquoise: A battery is close to full charge capacity.
- Blinking Amber: A battery that is the only available power source has reached a low battery level. When the battery reaches a critical battery level, the battery light begins blinking rapidly.
- Off: If the computer is plugged into an external power source, the light turns off when all batteries in the computer are fully charged. If the computer is not plugged into an external power source the light stays off until the battery reaches a low battery level.

Managing low battery levels

The information in this section describes the alerts and system responses set at the factory. Some low-battery alerts and system responses can be changed using Power Options in Windows Control Panel (**Start > Control Panel > Performance and Maintenance > Power options**). Preferences set using Power Options do not affect lights.

Identifying low battery levels

When a battery that is the sole power source for the computer reaches a low battery level, the battery light blinks.

If a low battery level is not resolved, the computer enters a critical battery level, and the battery light begins blinking rapidly.

- If Hibernation is enabled and the computer is on or in Standby, the computer initiates Hibernation.
- If Hibernation is disabled and the computer is on or in Standby, the computer remains briefly in Standby, and then shuts down and loses any unsaved information.

Resolving a low battery level

- △ **CAUTION:** To reduce the risk of losing information when the computer reaches a critical battery level and has initiated Hibernation, do not restore power until the power lights turn off.
-

Resolving a low battery level when external power is available

- ▲ Connect one of the following devices:
 - AC adapter
 - Optional expansion product or docking device
 - Optional power adapter

Resolving a low battery level when a charged battery is available

1. Turn off the computer or initiate Hibernation.
2. Remove the discharged battery, and then insert a charged battery.
3. Turn on the computer.

Resolving a low battery level when no power source is available

- ▲ Initiate Hibernation.
 - or –
 - Save your work and shut down the computer.

Resolving a low battery level when the computer cannot exit Hibernation

When the computer lacks sufficient power to exit Hibernation, follow these steps:

1. Insert a charged battery or plug the computer into external power.
2. Exit Hibernation by pressing the power button.

Calibrating a battery

Calibrate a battery under the following conditions:

- When battery charge displays seem inaccurate
- When you observe a significant change in battery run time

Even if a battery is heavily used, it should not need to be calibrated more than once a month. It is also not necessary to calibrate a new battery.

Step 1: Fully charge the battery

 **WARNING!** Do not charge the computer battery while you are onboard aircraft.

 **NOTE:** The battery charges whether the computer is off or in use, but it charges faster when the computer is off.

To fully charge the battery:

1. Insert the battery into the computer.
2. Connect the computer to an AC adapter, optional power adapter, optional expansion product, or optional docking device, and then plug the adapter or device into external power.

The battery light on the computer turns on.

3. Leave the computer plugged into external power until the battery is fully charged.

The battery light on the computer turns off.

Step 2: Disable Hibernation and Standby

1. Right-click the **Power Meter** icon in the notification area, at the far right of the taskbar, and then click **Adjust Power Properties**.

– or –

Select **Start > Control Panel > Performance and Maintenance > Power Options**.

2. Record the 4 settings listed in the **Running on batteries** and **Plugged in** columns so that you can reset them after the calibration.
3. Set the 4 options to **Never**.
4. Click **OK**.

Step 3: Discharge the battery

The computer must remain on while the battery is being discharged. The battery can discharge whether or not you are using the computer, but the battery will discharge faster while you are using it.

- If you plan to leave the computer unattended during the discharge, save your information before beginning the discharge procedure.
- If you use the computer occasionally during the discharge procedure and have set energy-saving timeouts, expect the following performance from the system during the discharge process:
 - The monitor will not turn off automatically.
 - Hard drive speed will not decrease automatically when the computer is idle.
 - System-initiated Hibernation will not occur.

To discharge a battery:

1. Unplug the computer from its external power source, but do *not* turn off the computer.
2. Run the computer on battery power until the battery is discharged. The battery light begins to blink when the battery has discharged to a low battery level. When the battery is discharged, the battery light turns off and the computer shuts down.

Step 4: Fully recharge the battery

To recharge the battery:

1. Plug the computer into external power and maintain external power until the battery is fully recharged. When the battery is recharged, the battery light on the computer turns off.

You can use the computer while the battery is recharging, but the battery will charge faster if the computer is off.

2. If the computer is off, turn it on when the battery is fully charged and the battery light has turned off.

Step 5: Reenable Hibernation and Standby

△ **CAUTION:** Failure to reenable Hibernation after calibration may result in a full battery discharge and information loss if the computer reaches a critical battery level.

1. Select **Start > Control Panel > Performance and Maintenance > Power Options**.
2. Reenter the settings that you recorded for the items in the **Plugged in** column and the **Running on batteries** column.
3. Click **OK**.

Conserving battery power

- Select low power-use settings through Power Options in Windows Control Panel.
- Turn off wireless and local area network (LAN) connections and exit modem applications when you are not using them.
- Disconnect external devices that are not plugged into an external power source, when you are not using them.
- Stop, disable, or remove any external media cards that you are not using.
- Use the **fn+f9** and **fn+f10** hotkeys to adjust screen brightness as needed.
- If you leave your work, initiate Standby or Hibernation, or shut down the computer.
- Remove the battery from the computer when it is not being used or charged.
- Purchase another battery to extend overall battery operating time.
- Store the battery in a cool, dry location.

Storing a battery

△ **CAUTION:** To prevent damage to a battery, do not expose it to high temperatures for extended periods of time.

If a computer will be unused and unplugged from external power for more than 2 weeks, remove the battery and store it separately.

To prolong the charge of a stored battery, place it in a cool, dry place.

📝 **NOTE:** A stored battery will slowly discharge and should be charged every 6 months.

Calibrate a battery before using it if it has been stored for one month or more.

Disposing of a used battery

⚠ **WARNING!** To reduce the risk of fire or burns, do not disassemble, crush, or puncture a battery; short the external contacts on a battery; or dispose of a battery in fire or water. Do not expose a battery to temperatures above 60°C (140°F). Replace the battery only with a battery approved for this computer.

Refer to the *Regulatory, Safety and Environmental Notices* for battery disposal information.

5 Using external AC power

External AC power is supplied through one of the following devices:

⚠ WARNING! To reduce potential safety issues, use only the AC adapter provided with the computer, a replacement AC adapter provided by HP, or a compatible AC adapter purchased from HP.

- Approved AC adapter
- Optional docking device or expansion product

Connect the computer to external AC power under any of the following conditions:

⚠ WARNING! Do not charge the computer battery while you are onboard aircraft.

- When you are charging or calibrating a battery
- When you are installing or modifying system software
- When you are writing information to a CD or DVD

When you connect the computer to external AC power, the following events occur:

- The battery begins to charge.
- If the computer is turned on, the battery meter icon in the notification area changes appearance.

When you disconnect external AC power, the following events occur:

- The computer switches to battery power.
- The display brightness is automatically decreased to save battery life. To increase display brightness, press the **fn+f10** hotkey or reconnect the AC adapter.

Connecting the AC adapter

⚠ **WARNING!** To reduce the risk of electric shock or damage to the equipment:

Plug the power cord into an AC outlet that is easily accessible at all times.

Disconnect power from the computer by unplugging the power cord from the AC outlet (not by unplugging the power cord from the computer).

If provided with a 3-pin attachment plug on the power cord, plug the cord into a grounded (earthed) 3-pin outlet. Do not disable the power cord grounding pin, for example, by attaching a 2-pin adapter. The grounding pin is an important safety feature.

To connect the computer to external AC power:

1. Plug the AC adapter into the power connector **(1)** on the computer.
2. Plug the power cord into the AC adapter **(2)**.
3. Plug the other end of the power cord into an AC outlet **(3)**.



Index

A

AC adapter, connecting 23

B

battery

- calibrating 16
- charging 13, 16
- conserving power 19
- disposing 21
- inserting 12
- low battery levels 14
- recharging 18
- removing 12
- storing 20

battery light 1, 13, 14

battery power 9

battery release latch 12

battery temperature 20

button, power 2

C

calibrating battery 16

charging batteries 13, 16

connection, external power 23

conservation, power 19

D

drive media 4

F

fn+f3 key, identifying 2

H

Hibernation

exiting 5

initiating 5

L

lights

battery 1

power 1

low battery level 14

O

operating system 3

P

power

connecting 23

conserving 19

control and light locations 1

power button, identifying 2

power lights, identifying 1

R

readable media 4

release latch, battery 12

S

shutdown 3

shutting down 3

Standby

exiting 4

initiating 4

storing battery 20

T

temperature 20

traveling with the computer 20

turning off the computer 3

U

unresponsive system 3

W

writable media 4

