

HP Designjet Z3200 Photo Printer

Using your printer



Legal notices

© 2008 Hewlett-Packard Development Company, L.P.

The information contained herein is subject to change without notice.

The only warranties for HP Products and services are set forth in the express warranty statement accompanying such products and services. Nothing herein should be construed as constituting an additional warranty. HP shall not be liable for technical or editorial errors or omissions contained herein.



USB 2.0 high-speed certified.

Trademarks

Adobe®, Acrobat®, Adobe Photoshop® and Adobe® PostScript® 3™ are trademarks of Adobe Systems Incorporated.

Corel® is a trademark or registered trademark of Corel Corporation or Corel Corporation Limited.

Energy Star® is a U.S. registered mark of the United States Environmental Protection Agency.

Microsoft® and Windows® are U.S. registered trademarks of Microsoft Corporation.

PANTONE® is Pantone, Inc.'s check-standard trademark for color.

Table of contents

1 Introduction

Safety precautions	2
HP Start-Up Kit	2
Your printer's documentation	2
Using this guide	2
Introduction	2
Use and maintenance	3
Troubleshooting	3
Support, accessories and specifications	3
Glossary	3
Index	3
Warnings and Cautions	3
The printer's main features	4
The printer's main components	4
Front view	5
Rear view	5
The front panel	6
Printer software	7
The printer's internal prints	7

2 Installing the software

Choose which connection method to use	10
Connect to a network (Windows)	10
Connect directly to a computer (Windows)	11
Printer sharing considerations	11
Uninstall the printer software (Windows)	12
Connect to a network (Mac OS)	12
Bonjour/Rendezvous connection	12
TCP/IP connection	14
Connect directly to a computer (Mac OS)	15
Sharing the printer	16
Uninstall the printer software (Mac OS)	16

3 Personalizing the printer

Turn printer on and off	18
Change the language of the front-panel display	19
Access the HP Printer Utility	19

Access the Embedded Web Server	19
Change the language of the HP Printer Utility	20
Change the language of the Embedded Web Server	20
Change the sleep mode setting	20
Turn the buzzer on and off	20
Change the front-panel display contrast	21
Change the units of measurement	21
Configure network settings	21

4 Paper handling

General advice	23
Load a roll onto the spindle	23
Load a roll into the printer	25
Easy loading procedure	26
Paper menu procedure	28
Unload a roll	29
Unload paper key procedure with paper on the roll	29
Paper menu procedure with paper on the roll	29
Roll out of paper procedure	30
Load a single sheet	30
Easy loading procedure	30
Paper menu procedure	32
Unload a single sheet	33
Unload paper key procedure	33
Paper menu procedure	34
View information about the paper	34
Paper presets	35
To install a downloaded paper preset	35
To create your own paper preset	36
Advanced paper preset creation	37
Print on loaded paper	39
Move the paper	39
Maintain the paper	39
Change the drying time	40
Turn the automatic cutter on and off	40
Feed and cut the paper	40

5 Printing

Select print quality	43
Select paper size	43
Custom paper sizes	43
Select margins options	44
Print with shortcuts	44
Rescale a print	45
Preview a print	46
Print a draft	47

High-quality printing	47
If you have a high-resolution image	48
If you have printhead problems	48
If you are printing on photo paper	48
If you are printing on satin photo paper	48
Print in gray shades	49
Print with no margins	49
Reprint an old job	49
Rotate an image	50
Autorotate	51
Print with crop lines	51
Print on sheet paper	51
Use paper economically	51
Use ink economically	52

6 Color management

What is color?	54
The problem: color in the computer world	54
The solution: color management	56
Color and your printer	58
HP Embedded Spectrophotometer	58
A summary of the color management process	59
Color calibration	60
Check calibration status	60
Calibrate	60
Calibration from Photoshop	61
Color profiling	61
Create your own profile	62
Color measurement	63
Install a profile	64
Export a profile	64
Restore an original profile	64
Profile your monitor	64
Advanced profiling	65
Color management options	65
Color management example with Photoshop	66
Synchronized color management with Photoshop	66
Color adjustment options	66
Printing in color	66
Printing in grayscale	67
Color management scenarios	67
Print a color photo for an exhibition (Photoshop, Mac OS)	68
Print a black-and-white photo for an exhibition (Photoshop, Mac OS)	70
Print a digital album (Aperture, Mac OS)	74

7 Retrieving printer usage information

Get printer accounting information	79
Check printer usage statistics	79
Printer statistics with the HP Printer Utility	79
Printer statistics with the Embedded Web Server	79
Check ink and paper usage for a job	79
Ink and paper statistics with the HP Printer Utility	79
Printer statistics with the Embedded Web Server	79
Cost accounting	80
Request accounting data by E-mail	80

8 Handling ink cartridges and printheads

About the ink cartridges	82
Check ink cartridge status	82
Ink menu procedure	82
HP Printer Utility procedures	82
Remove an ink cartridge	82
Insert an ink cartridge	84
About the printheads	85
Check printhead status	86
Remove a printhead	86
Insert a printhead	88

9 Maintaining the printer

Check printer status	93
Clean the exterior of the printer	93
Replace the cutter	93
Maintain the ink cartridges	97
Move or store the printer	97
Update the firmware	98
Update the software	99
Change the battery	99
Printer maintenance kits	99
Secure Disk Erase	99

10 Accessories

How to order supplies and accessories	102
Order ink supplies	102
Order paper	103
Non-recommended paper types	108
Order accessories	108
Introduction to the accessories	109
Stand	109
HP Advanced Profiling Solution	109
Key features	109

11 Troubleshooting paper issues

The paper cannot be loaded successfully	112
Unsuccessful roll load	112
Unsuccessful sheet load	112
Paper loading error messages	113
The paper type is not in the driver	113
Black ink is easily removed when touched	114
After printing, the paper has wrinkles or there is too much ink	114
The paper has jammed	115
Prints do not fall neatly into the basket	117
The sheet stays in the printer when the print has been completed	117
The paper is cut when the print has been completed	117
The cutter does not cut well	117
The roll is loose on the spindle	118
A strip stays on the output tray and generates jams	118
Recalibrate the paper advance	118
Recalibrating the paper advance procedure	119
Return to default calibration	119

12 Troubleshooting print-quality issues

General advice	121
Print quality troubleshooting wizard	121
Horizontal lines across the image (banding)	122
The whole image is blurry or grainy	123
The paper is not flat	123
The print is scuffed or scratched	124
Ink marks on the paper	124
Horizontal smears on the front of coated paper	124
Ink marks on the back of the paper	125
Vertical dotted or dashed lines on the print	125
Vertical continuous lines on the print	126
Edges of objects are stepped or not sharp	126
Edges of objects are darker than expected	126
Bronzing	127
Horizontal lines at the end of a cut sheet print	127
Vertical lines of different colors	127
White spots on the print	127
Colors are inaccurate	128
Color accuracy using EPS or PDF images in page layout applications	128
The image is incomplete (clipped at the bottom)	129
The image is clipped	129
Some objects are missing from the printed image	130
Lines are too thick, too thin or missing	130
Lines appear stepped or jagged	131
Lines print double or in the wrong colors	131
Lines are discontinuous	132
Lines are blurred	133
The Image Diagnostics Print	133

Corrective action	135
If you still have a problem	136

13 Troubleshooting ink cartridge and printhead issues

Cannot insert an ink cartridge	138
Ink cartridge status messages	138
Cannot insert a printhead	138
The front-panel display recommends reseating or replacing a printhead	139
Clean the printheads	139
Clean the printhead drop detector	140
Align the printheads	142
Reinsert printheads procedure	143
Image Quality Maintenance menu procedure	143
Scanning errors during alignment	144
Printhead status messages	144

14 Troubleshooting general printer issues

The printer does not print	146
The printer seems slow	146
Communication failures between computer and printer	146
Cannot access the HP Printer Utility	147
Some Color Center options are unavailable	147
Cannot access the Embedded Web Server	147
Automatic file system check	148
No output when printing from Microsoft Visio 2003	148
Unavailable driver features when printing from QuarkXPress	148
Printer alerts	149

15 Front-panel error messages

16 HP Customer Care

Introduction	153
HP Professional Graphics Services	153
Knowledge Center	153
HP Start-Up Kit	153
HP Care Packs and Warranty Extensions	153
HP Installation	154
HP Proactive Support	154
Contact HP Support	154
Telephone number	155

17 Printer specifications

Functional specifications	157
Physical specifications	158
Memory specifications	158
Power specifications	158

Ecological specifications	158
Environmental specifications	159
Acoustic specifications	159
Glossary	160
Index	162

1 Introduction

- [Safety precautions](#)
- [HP Start-Up Kit](#)
- [Your printer's documentation](#)
- [Using this guide](#)
- [The printer's main features](#)
- [The printer's main components](#)
- [The front panel](#)
- [Printer software](#)
- [The printer's internal prints](#)

Safety precautions

The following precautions ensure the proper use of the printer and prevent the printer from being damaged. Follow these precautions at all times.

- Use the power supply voltage specified on the nameplate. Avoid overloading the printer's electrical outlet with multiple devices.
- Ensure the printer is well-grounded. Failure to ground the printer may result in electrical shock, fire and susceptibility to electromagnetic interference.
- Do not disassemble or repair the printer yourself. Contact your local HP Service Representative for service, see [Contact HP Support on page 154](#).
- Use only the electrical cord supplied by HP with the printer. Do not damage, cut or repair the power cord. A damaged power cord has risk of fire and electric shock. Replace a damaged power cord with an HP-approved power cord.
- Do not allow metal or liquids (except those used in HP Cleaning Kits) to touch the internal parts of the printer. Doing so may cause fire, electric shock or other serious hazards.
- Power off the printer and unplug the power cable from the power outlet in any of the following cases:
 - When placing your hands inside the printer
 - If there is smoke or an unusual smell coming from the printer
 - If the printer is making an unusual noise not heard during normal operation
 - A piece of metal or a liquid (not part of cleaning and maintenance routines) touches internal parts of the printer
 - During a thunderstorm
 - During a power failure

HP Start-Up Kit

The HP Start-Up Kit is the CD that comes with your printer; it contains the printer's software.

Your printer's documentation

You can read about how to use your printer in *Using your printer* and the *Quick reference guide*. The most complete source of information is *Using your printer*, which is available from <http://www.hp.com/go/z3200/manuals/>. The *Quick reference guide* contains the most commonly-needed information, and is provided as a printed manual with your printer.

Using this guide

Using your printer is organized into the following chapters.

Introduction

This chapter provides a brief introduction to the printer and its documentation for new users.

Use and maintenance

These chapters help you carry out normal printer procedures and include the following topics.

- [Installing the software on page 9](#)
- [Personalizing the printer on page 17](#)
- [Paper handling on page 22](#)
- [Printing on page 42](#)
- [Color management on page 53](#)
- [Retrieving printer usage information on page 78](#)
- [Handling ink cartridges and printheads on page 81](#)
- [Maintaining the printer on page 92](#)

Troubleshooting

These chapters help you solve problems that may occur while printing and include the following topics.

- [Troubleshooting paper issues on page 111](#)
- [Troubleshooting print-quality issues on page 120](#)
- [Troubleshooting ink cartridge and printhead issues on page 137](#)
- [Troubleshooting general printer issues on page 145](#)
- [Front-panel error messages on page 150](#)

Support, accessories and specifications

These chapters contain reference information, including HP customer care, the specifications of the printer and the part numbers of paper types, ink supplies and accessories.

Glossary

This chapter contains definitions of printing and HP terms used in this documentation.

Index

In addition to the table of contents, there is an alphabetical index to help you to find topics quickly.

Warnings and Cautions

The following symbols are used in this manual to ensure the proper use of the printer and to prevent the printer from being damaged. Follow the instructions marked with these symbols.

-
- △ **WARNING!** Failure to follow the guidelines marked with this symbol could result in serious personal injury or death.
 - △ **CAUTION:** Failure to follow the guidelines marked with this symbol could result in minor personal injury or damage to the product.
-

The printer's main features

Your printer is a color inkjet printer designed for printing high-quality images on paper up to 44 in (1.12 m) wide. Some major features of the printer are shown below:

- Print resolution of up to 2400 × 1200 optimized dpi, from a 600 × 600 dpi input, using the **Best** print-quality option, the **Maximum Detail** option and photo paper
- The HP Printer Utility, see [Access the HP Printer Utility on page 19](#), provides an easy-to-use interface including:
 - A single point for color control
 - Import, creation and management of paper presets
 - Calibration of printer and display
 - Access to the online HP Printing Knowledge Center
- Accurate and consistent color reproduction with automatic color calibration and profiling
- Twelve-ink system providing a wide color range on matte fine art papers and glossy photo papers for photographic and graphic arts prints and complete coverage of ISO and SWOP gamuts for color accuracy in pre-press applications
- Embedded Spectrophotometer for consistent and accurate color, even with paper and environment changes, and easy creation of paper presets, see [HP Embedded Spectrophotometer on page 58](#)
- Ink and paper usage information available from the Web from the Embedded Web Server, see [Access the Embedded Web Server on page 19](#)
- Paper flexibility and automatic easy load, see [Paper handling on page 22](#), with information and paper presets accessible from the front panel and from the HP Printer Utility

The printer's main components

The following front and rear views of the printer illustrate the main components.

Front view

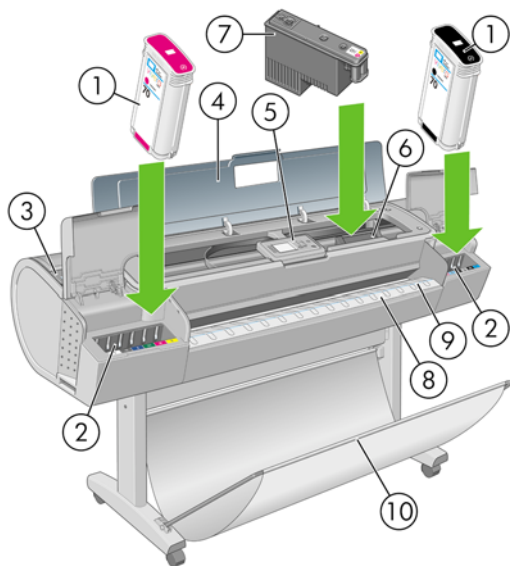

1. Ink cartridge
2. Ink cartridge slots
3. Blue lever
4. Transparent window
5. Front panel
6. Printhead carriage
7. Printhead
8. Output tray
9. Paper alignment lines
10. Basket

Rear view

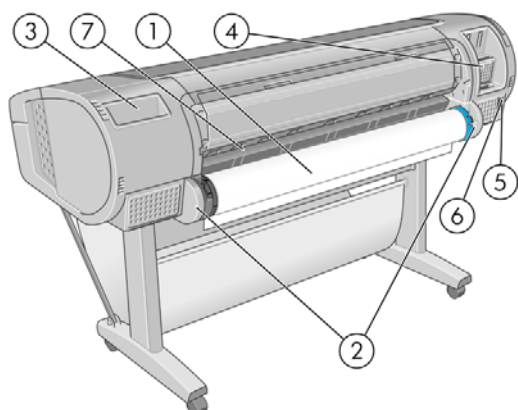

1. Spindle
2. Spindle holders
3. Quick Reference Guide holder
4. Sockets for communication cables and optional accessories

5. Hard power switch
6. Power cord plug in
7. Paper feeder

The front panel

Your printer's front panel is located on the front of the printer, in the center. It has the following important functions:

- Assists you in troubleshooting issues
- Is used to perform certain procedures, such as cutting and unloading paper
- Displays helpful animations to guide you through procedures
- Displays up-to-date information about the status of the printer, such as the ink cartridges, the printheads, the paper and the print jobs
- Displays warning and error messages, when appropriate, along with audio alerts to call attention to a warning or message
- Can be used to change the values of printer settings and thus change the operation of the printer. However, settings in the front panel are overridden by settings in the printer drivers, see [Installing the software on page 9](#).

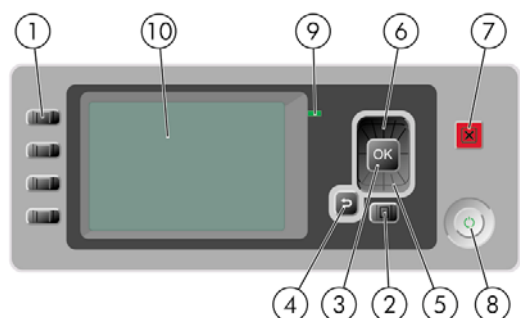

The front panel has the following components:

1. **Direct access keys:**
 - First key: View ink levels, see [Check ink cartridge status on page 82](#)
 - Second key: View loaded paper, see [View information about the paper on page 34](#)
 - Third key: Unload paper, see [Unload a roll on page 29](#) and [Unload a single sheet on page 33](#)
 - Fourth key: Form feed and cut, see [Feed and cut the paper on page 40](#)
2. **Menu key** - Press to return to the main menu of the front-panel display. If you are already on the main menu it will display the status screen.
3. **OK key** - To confirm an action while in a procedure or interaction. To enter in a submenu in the menu. To select a value when given an option.
4. **Back key** - To go to the previous step in a procedure or interaction. To go to the upper level, or leave the option in the menu, or when given an option.
5. **Down key** - To go down in a menu or option, or to decrease a value, for example when configuring the front-panel display contrast or the IP address.

6. **Up** key - To go up in a menu or option, or to increase a value, for example when configuring the front-panel display contrast or the IP address.
7. **Cancel** key - To abort a procedure or interaction.
8. **Power** key - To turn the printer off or on, it also has a light to indicate the printer's status. If the power key light is off the device is off. If the power key light is blinking green, the device is starting up. If the power key light is green on, the device is on. If the power key light is amber on, the device is in standby. If the power key light is blinking amber, the device needs attention.
9. **LED** light - Indicates the printer's status. If the LED light is solid green, the device is ready. If it is flashing green, the device is busy. If it is solid amber, there is a system error. If it is flashing amber, the printer needs attention.
10. **Front-panel display** - Displays error, warnings and information on using your printer.

To **highlight** an item in the front-panel display, press the **Up** or **Down** key until the item is highlighted.

To **select** an item in the front-panel display, first highlight it and then press the **OK** key.

When this guide shows a series of front-panel display items like this: **Item1** > **Item2** > **Item3**, it means that you should select **Item1**, then select **Item2**, then select **Item3**.

Information about specific uses of the front panel can be found throughout this guide.

Printer software

The following software is provided with your printer:

- The PCL3 raster printer driver
- The HP Printer Utility, see [Access the HP Printer Utility on page 19](#), allows you to:
 - Manage the printer including color with the HP Color Center
 - View the status of the ink cartridges, the printheads and the paper
 - View job accounting information, see [Retrieving printer usage information on page 78](#)
 - Update the printer's firmware, see [Update the firmware on page 98](#)
 - Access the HP Knowledge Center
 - Change various printer settings (in the Settings tab)
 - Perform calibrations and troubleshooting
- The Embedded Web Server runs in the printer and enables you to use a Web browser on any computer to check ink levels and printer status, see [Access the Embedded Web Server on page 19](#)

The printer's internal prints

The internal prints give various kinds of information about your printer. They can be requested from the front panel without using a computer.

Before requesting any internal print, make sure that paper is loaded (roll or sheet) and that the front panel displays the **Ready** message. The loaded paper should be at least A3 landscape (16.53 in or 42 cm wide); otherwise the print may be clipped.

To print any internal print, select the Internal Prints menu icon , then select the internal print you want. The following internal prints are available.

- Menu map: shows details of all the front-panel display menus
- Configuration: shows all the current front-panel display settings
- Usage report: shows estimates of the total number of prints, number of prints by paper type, number of prints by print-quality option and total amount of ink used per color (the accuracy of these estimates is not guaranteed)
- Service information: provides information needed by service engineers

2 Installing the software

- [Choose which connection method to use](#)
- [Connect to a network \(Windows\)](#)
- [Connect directly to a computer \(Windows\)](#)
- [Uninstall the printer software \(Windows\)](#)
- [Connect to a network \(Mac OS\)](#)
- [Connect directly to a computer \(Mac OS\)](#)
- [Uninstall the printer software \(Mac OS\)](#)

Choose which connection method to use

The following methods can be used to connect your printer.

Connection type	Speed	Cable length	Other factors
Fast Ethernet	Fast; varies according to network traffic	Long (100 m=328 ft)	Requires extra equipment (switches)
Jetdirect print server (optional accessory)	Moderate; varies according to network traffic	Long (100 m=328 ft)	Requires extra equipment (switches) Provides additional features See http://www.hp.com/go/jetdirect/ for more details
USB 2.0	Very fast	Short (5 m=16 ft)	

NOTE: The speed of any network connection depends on all components used in the network, which can include network interface cards, hubs, routers, switches and cables. If any one of these components cannot operate at high speed, you will have a low-speed connection. The speed of your network connection can also be affected by the total amount of traffic from other devices on the network.

Connect to a network (Windows)

Before you begin, check your equipment:

- The printer should be set up and on.
- The Ethernet hub or router should be on and functioning correctly.
- All computers on the network should be on and connected to the network.
- The printer should be connected to the network.

Now you can proceed to install the printer software and connect your printer:

1. Make a note of the IP address from the status screen on the printer's front panel (192.168.1.1 in this example):

Ready for paper

http://XXXX11
http://192.168.1.1

Press  to enter menu



2. Insert the *HP Start-Up Kit* CD into your computer. If the CD does not start automatically, run the **autorun.exe** program in the root folder of the CD.
3. Click **Express Network Install**. The printer driver and the HP Printer Utility will be installed.
4. Follow the instructions on your screen to set up the printer.

The configuration program looks for printers connected to your network. When the search is complete, a list of printers appears. Identify your printer by its IP address and select it from the list.

If your computer fails to find any printers on the network, the **Printer Not Found** window is displayed, which helps you to try to find your printer. If you have a firewall in operation; you may have to disable it temporarily in order to find the printer. You also have the options of searching for the printer by its URL, IP address or MAC address.

 **NOTE:** Although IPv6 is supported, automatic installation of the printer driver is not guaranteed to work with it, so you may need to use the standard Windows Add Printer Wizard to install the driver.

Connect directly to a computer (Windows)

You can connect your printer directly to a computer without going through a network, by using the printer's built-in USB 2.0 socket.

 **TIP:** A USB connection may be faster than a network connection, but the cable is limited in length and it is more difficult to share the printer.

1. **Do not connect the computer to the printer yet.** You must first install the printer driver software on the computer, as follows.
2. Insert the *HP Start-Up Kit* CD into your CD drive. If the CD does not start automatically, run the **autorun.exe** program in the root folder of the CD.
3. Click **Custom Install**. The printer driver and the HP Printer Utility will be installed.
4. You may see a message warning that the installer will have to communicate through the Windows Firewall to search for printers on the network. As you intend to set up a USB connection, select **Continue installation without searching the network** and click **Next**.
5. Follow the instructions on your screen to set up the printer. The following notes help you to understand the screens and make appropriate choices.
 - When asked how the printer is connected, select **USB cable**.
 - If you would like to share the printer with other people connected to your network, press the **Printer Properties** button in the **Ready to Install** window, set **Printer Name** to the name under which the printer will be shared, then set **Shared** to **Yes**.
 - When prompted to do so, connect your computer to the printer with a certified USB cable. Ensure that the printer is turned on.

 **NOTE:** The use of non-certified USB cables can lead to connectivity problems. Only cables certified by the USB Implementor's Forum (<http://www.usb.org/>) should be used with this printer.

Printer sharing considerations

- The HP Printer Utility must be installed on a computer before it can be used from that computer.
- Any other people sharing your directly connected printer will be able to send print jobs, but will not be able to receive information from the printer—which affects printer alerts, printer status reports, paper management, printer administration and troubleshooting.
- Any other people sharing your directly connected printer will be unable to use the printer's own print preview facility, although the application's print preview will still be available. See [Preview a print on page 46](#).

 **TIP:** The best way to share the printer over a network is to connect the printer not to any computer, but to the network. See [Connect to a network \(Windows\) on page 10](#).

Uninstall the printer software (Windows)

1. Insert the *HP Start-Up Kit* CD into your CD drive. If the CD does not start automatically, run the **autorun.exe** program in the root folder of the CD.
2. Select **Modify Installation** and follow the instructions on your screen to uninstall the printer software.

Connect to a network (Mac OS)

You can connect your printer to a network under Mac OS X by using the following methods:

- Bonjour/Rendezvous
- TCP/IP

 **NOTE:** The printer does not support AppleTalk.

Before you begin, check your equipment:

- The printer should be set up and on.
- The Ethernet hub or router should be on and functioning correctly.
- All computers on the network should be on and connected to the network.
- The printer should be connected to the network.

Now you can proceed to install the printer software and connect your printer.

Bonjour/Rendezvous connection

1. Go to your printer's front panel and select the Connectivity menu icon , then **Fast Ethernet** > **View configuration**. Note the mDNS service name of your printer.
2. Insert the *HP Start-Up Kit* CD into your CD drive.
3. Open the CD icon on your desktop.



4. Open the **Mac OS X HP Designjet Installer** icon.
5. Follow the instructions on your screen. You are recommended to use the **Easy Install** option.

6. The printer software is installed, including the printer driver and the HP Printer Utility.
7. When the software has been installed, the HP Printer Setup Assistant starts automatically, to set up a connection to your printer. Follow the instructions on your screen.
8. When you reach the Select Printer screen, look for your printer's mDNS service name (which you noted in step 1) in the Printer Name column.

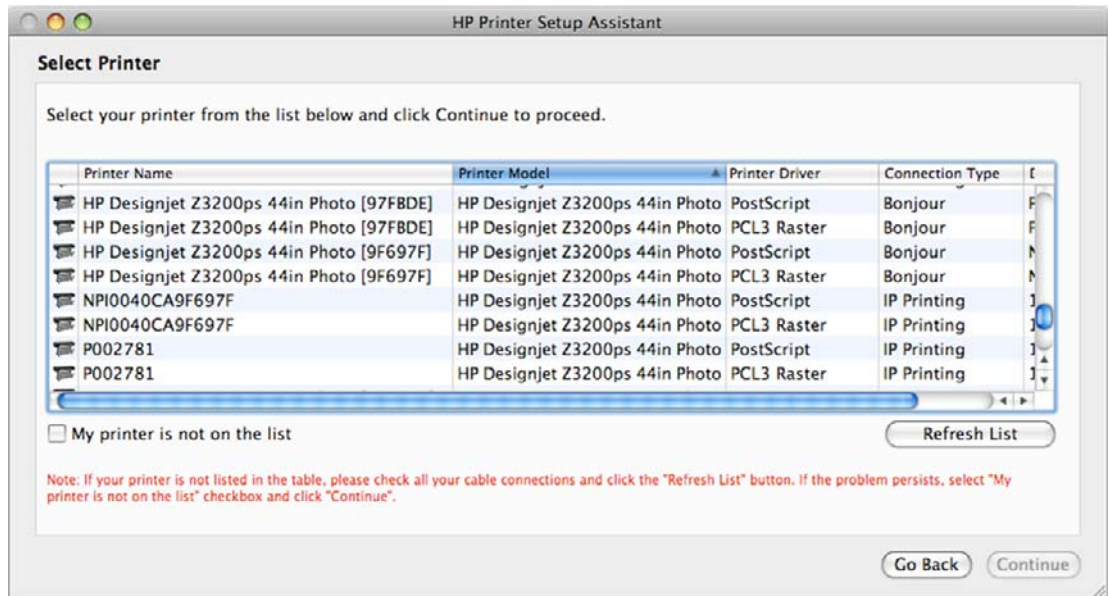

- If you find the right printer name, scroll sideways to see the Connection Type column, and check that it shows **Bonjour/Rendezvous**. Then highlight that line. Otherwise, continue searching further down the list.
- If you cannot find your printer name with a **Bonjour/Rendezvous** connection type, check the box **My printer is not in the list**.

Click **Continue**.

9. Continue following the instructions on the screen. When you reach the Printer Queue Created screen, click **Quit** to exit, or **Create New Queue** if you want to connect another printer to the network.
10. When the HP Printer Setup Assistant has finished, you can remove the CD from the CD drive.

If the printer driver is already installed, the HP Printer Setup Assistant can be run at any time from the CD.

TCP/IP connection

1. Go to your printer's front panel and press the **Menu** key until you see the status screen.

Ready for paper

http://XXXX11
http://192.168.1.1

Press  to enter menu



Note the URL of your printer (http://XXXX11 in this example).

2. Insert the *HP Start-Up Kit* CD into your CD drive.
3. Open the CD icon on your desktop.



4. Open the **Mac OS X HP Designjet Installer** icon.
5. Follow the instructions on your screen. You are recommended to use the **Easy Install** option.
6. The printer software is installed, including the printer driver and the HP Printer Utility.
7. When the software has been installed, the HP Printer Setup Assistant starts automatically, to set up a connection to your printer. Follow the instructions on your screen.
8. When you reach the Select Printer screen, look for your printer's URL (which you noted in step 1) in the Printer Name column.
 - If you find the right printer name, scroll sideways to see the Connection Type column, and check that it shows **IP Printing**. Then highlight that line. Otherwise, continue searching further down the list.
 - If you cannot find your printer name with an **IP Printing** connection type, check the box **My printer is not in the list**.

Click **Continue**.

- Continue following the instructions on the screen. When you reach the Printer Queue Created screen, click **Quit** to exit, or **Create New Queue** if you want to connect another printer to the network.
- When the HP Printer Setup Assistant has finished, you can remove the CD from the CD drive.

If the printer driver is already installed, the HP Printer Setup Assistant can be run at any time from the CD.

Connect directly to a computer (Mac OS)

You can connect your printer directly to a computer without going through a network, by using the printer's built-in USB 2.0 socket.

- Make sure the printer is either turned off or disconnected from the computer.
- Insert the *HP Start-Up Kit* CD into your CD drive.
- Open the CD icon on your desktop.



- Open the **Mac OS X HP Designjet Installer** icon.
- Follow the instructions on your screen. You are recommended to use the **Easy Install** option.
- The printer software is installed, including the printer driver and the HP Printer Utility.
- When the software has been installed, the HP Printer Setup Assistant starts automatically, to set up a connection to your printer.
- Make sure that the printer is turned on and connected to the computer with a certified USB cable.
NOTE: The use of non-certified USB cables can lead to connectivity problems. Only cables certified by the USB Implementor's Forum (<http://www.usb.org/>) should be used with this printer.
- In the HP Printer Setup Assistant, click **Continue**.
- In the list of printers that appears, select the entry that uses the connection type USB, and click **Continue**.
- The following screen displays information about your printer's installation, where the name of the printer can be modified. Make any changes you wish to make, and click **Continue**.

12. Your printer is now connected. In the Printer Queue Created screen, click **Quit** to exit, or **Create New Queue** if you want to connect another printer.
13. When the HP Printer Setup Assistant has finished, you can remove the CD from the CD drive.

If the printer driver is already installed, the HP Printer Setup Assistant can be run at any time from the CD.

Sharing the printer

If your computer is connected to a network, you can make your directly connected printer available to other computers on the same network.

1. Double-click the System Preferences icon on the Dock menu bar on your desktop.
2. Enable printer sharing by going to **Sharing > Services > Printer Sharing**.
3. Your printer now automatically appears in the list of shared printers displayed by any other computer running Mac OS and connected to your local network.

Any other people wishing to share your printer must install the printer software on their own computers.

Anyone sharing your printer will be able to send print jobs, but will not be able to receive information from the printer—which affects printer alerts, printer status reports, paper management, printer administration and troubleshooting.

You may find that sharing your directly connected printer with other users will slow down your computer unacceptably.

 **TIP:** The best way to share the printer over a network is to connect the printer not to any computer, but to the network. See [Connect to a network \(Mac OS\) on page 12](#).

Uninstall the printer software (Mac OS)

1. Insert the *HP Start-Up Kit* CD into your CD drive.
2. Open the CD icon on your desktop.
3. Open the **Mac OS X HP Designjet Installer** icon.
4. Select **Uninstall**, and follow the instructions on your screen to uninstall the printer software.

To delete the print queue:

- Under Mac OS X 10.5: from the system preferences, select the **Print & Fax** dialog. Select the name of the printer and click the – button.
- Under Mac OS X 10.4 there are two ways of deleting the print queue:
 - from the system preferences, select the **Printing** pane of the **Print & Fax** dialog. Select the name of the printer and click the – button.
 - from the Print Setup utility, select the name of the printer and click the **Delete** icon.

3 Personalizing the printer

- [Turn printer on and off](#)
- [Change the language of the front-panel display](#)
- [Access the HP Printer Utility](#)
- [Access the Embedded Web Server](#)
- [Change the language of the HP Printer Utility](#)
- [Change the language of the Embedded Web Server](#)
- [Change the sleep mode setting](#)
- [Turn the buzzer on and off](#)
- [Change the front-panel display contrast](#)
- [Change the units of measurement](#)
- [Configure network settings](#)

Turn printer on and off

TIP: The printer can be left powered on without wasting energy. Leaving it on improves response time and overall system reliability. When the printer has not been used for a certain period of time (the default time is determined by Energy Star), it saves power by going into sleep mode. However, any interaction with the printer's front-panel display returns it to active mode, and it can resume printing immediately. To change the sleep mode time, see [Change the sleep mode setting on page 20](#).

NOTE: In sleep mode, the printer wakes up from time to time to do maintenance service to the printheads. This avoids the need of doing long preparation after long idle periods.

The printer has three levels of power consumption.

- Plugged in: the power cord is plugged into the back of the printer
- Switched on: the switch at the back of the printer is in the on position
- Powered on: the **Power** key on the front panel shows a green light

If you wish to turn the printer on or off or reset the printer, the normal and recommended method is to use the **Power** key on the front panel.



However, if you plan to store the printer indefinitely or the **Power** key does not seem to work, you are recommended to power it off using the **Power** key, and then also switch off the power switch at the rear.

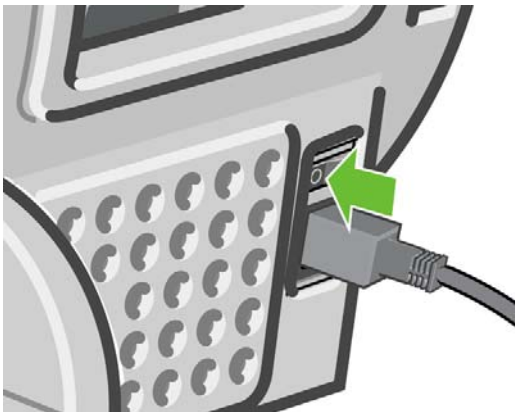

To turn it back on, use the power switch at the rear.

When the printer is powered back on, it takes about three minutes to initialize and check and prepare the printheads. Preparing the printheads takes about one minute and 15 seconds. However, if the printer has been off for six weeks or more, preparing the printheads could take up to 60 minutes.

TIP: It is strongly recommended to leave the printer powered on or in sleep mode to avoid wasting ink and time.

Change the language of the front-panel display

There are two possible ways to change the language of the front-panel menus and messages.

- If you can understand the current front-panel display language, select the Setup menu icon , then **Front panel options** > **Select language**.
- If you cannot understand the current front-panel display language, start with the printer powered off. At the front panel, press the **OK** key and hold it down. While holding the **OK** key down, press the **Power** key and hold it down. Continue to hold down both keys until the green light on the right side of the front-panel display starts flashing, and then release both keys. You can expect a delay of about one second. If the green light starts flashing without any delay, you may need to start again.

Whichever method you used, the language selection menu should now appear on the front-panel display. Highlight your preferred language with the **Up** and **Down** keys, then press the **OK** key.

When you have selected your preferred language, turn off the printer with the **Power** key and then turn it on again. The front panel will appear in the selected language.

Access the HP Printer Utility

The HP Printer Utility enables you to manage your printer from a computer with a USB connection and TCP/IP.

- Under Windows, start the HP Printer Utility from your desktop shortcut or from **Start** > **All Programs** > **Hewlett-Packard** > **HP Printer Utility** > **HP Printer Utility**. This launches the HP Printer Utility showing the printers installed in the Printers and Faxes window.
- Under Mac OS, launch the HP Printer Utility from your dock shortcut or by selecting **STARTUP_DISK** > **Library** > **Printers** > **hp** > **Utilities** > **HP Printer Utility**. This launches the HP Printer Utility Printer Selector, showing the printers installed in the Printer Setup Utility (Mac OS X 10.4) or **Print & Fax** (Mac OS X 10.5 or later).

Select your printer and click **Select**. This launches the HP Printer Utility.

If you have followed these instructions but failed to get through to the HP Printer Utility, see [Cannot access the HP Printer Utility on page 147](#).

Access the Embedded Web Server

The Embedded Web Server enables you to manage your printer remotely using an ordinary Web browser running on any computer.

 **NOTE:** To use the Embedded Web Server, you must have a TCP/IP connection to your printer.

The following browsers are known to be compatible with the Embedded Web Server:

- Internet Explorer 6 or later for Windows
- Netscape Navigator 6.01 or later
- Mozilla 1.5 or later
- Mozilla Firefox 1.0 or later
- Safari 2 or later for Mac OS

To access the Embedded Web Server on any computer, open your Web browser and give the address of your printer. You can find out the address of your printer (starting with **http:**) from the front-panel display, by looking at the status screen.

Ready for paper

http://XXXX11
http://192.168.1.1

Press  to enter
menu



If you have followed these instructions but failed to get through to the Embedded Web Server, see [Cannot access the Embedded Web Server on page 147](#).

Change the language of the HP Printer Utility

The HP Printer Utility can work in the following languages: English, Portuguese, Spanish, Catalan, French, Italian, German, Russian, Simplified Chinese, Traditional Chinese, Korean and Japanese.

- Under Windows, select **Tools > Set Language** and select a language from the list.
- Under Mac OS, the language is changed as for any other application. In **System Preferences** select **International** and re-launch the application.

Change the language of the Embedded Web Server

The Embedded Web Server can work in the following languages: English, Portuguese, Spanish, Catalan, French, Italian, German, Russian, Simplified Chinese, Traditional Chinese, Korean and Japanese. It uses whichever language you have specified in your Web browser's options. If you have specified a language that it cannot support, it works in English.

To change the language, you must change your Web browser's language setting. For example, in Internet Explorer version 6, go to the **Tools** menu and select **Internet Options, Languages**. Then ensure that the language you want is at the top of the list in the dialog box.

To complete the change, you must close and reopen your Web browser.

Change the sleep mode setting

If the printer is left switched on but unused for a certain period of time, it goes automatically into sleep mode to save power. To change the time the printer waits before it goes into sleep mode, go to the front

panel and select the Setup menu icon , then **Advanced > Sleep mode wait time**. Highlight the wait time you want and then press the **OK** key. You can set the time to 30, 60, 120, 150, 180, 210 or 240 minutes.

Turn the buzzer on and off

To turn the printer's buzzer on or off, go to the front panel and select the Setup menu icon , then **Front panel options > Enable buzzer**, highlight on or off and press the **OK** key. The default buzzer is set to on.

Change the front-panel display contrast

To change the contrast of the front-panel display, go to the front panel and select the Setup menu icon , then **Front panel options** > **Select display contrast**, and enter a value using the **Up** or **Down** key. Press the **OK** key to set the value. The default contrast is set to 50.

Change the units of measurement

To change the units of measurement in the front-panel display, go to the front panel and select the Setup menu icon , then **Advanced** > **Select units**, and select **English** or **Metric**. By default the units are set to metric.

Configure network settings

To configure the network settings from the HP Printer Utility for Windows, select **Settings tab** > **Network Settings**. From the HP Printer Utility for Mac OS, select **Network Settings** in the Configuration group. You can view and configure the following network settings.

- **IP Configuration method:** specify the way to set an IP address between BOOTP, DHCP, Auto IP and Manual
- **Host name:** specify an IP name for the network device, the name may contain up to 32 ASCII characters
- **IP address:** specify the IP address on the print server, duplicate IP addresses on a TCP/IP network are not allowed

 **NOTE:** If you change the current IP address and click Apply, the browser loses the current connection to the print server because it is pointing to the old address. To reconnect, browse to the new IP address.

- **Subnet mask:** specify a subnet mask, which is a 32-bit number applied to an IP address to determine which bits specify the network and subnet and which bits uniquely specify the node
- **Default gateway:** specify the IP address of a router or computer that is used to connect to other networks or sub-networks, if none exist, use the IP address of the computer or the IP address of the print server
- **Domain name:** specify the name of the DNS domain that the print server resides in, for example, support.hp.com, note that it does not include the host name; it is not the fully qualified domain name, such as printer1.support.hp.com
- **Idle timeout:** specify the number of seconds that an idle connection is allowed to remain open, 270 is the default value, if set to zero, the timeout is disabled and TCP/IP connections remain open until closed by the other node (such as a workstation) on the network
- **Default IP:** specify the IP address to use when the print server is unable to obtain an IP address from the network when powered on or when reconfigured to use BOOTP or DHCP
- **Send DHCP requests:** specify whether DHCP requests are transmitted when a legacy default IP address or a default Auto IP is assigned

To configure the same network settings from the front panel, select the Connectivity menu icon , then **Fast Ethernet** > **Modify configuration**.

4 Paper handling

- [General advice](#)
- [Load a roll onto the spindle](#)
- [Load a roll into the printer](#)
- [Unload a roll](#)
- [Load a single sheet](#)
- [Unload a single sheet](#)
- [View information about the paper](#)
- [Paper presets](#)
- [Print on loaded paper](#)
- [Move the paper](#)
- [Maintain the paper](#)
- [Change the drying time](#)
- [Turn the automatic cutter on and off](#)
- [Feed and cut the paper](#)

General advice

- 💡 **TIP:** Before starting a paper loading process, make sure you have enough room around the printer, both in front and behind.

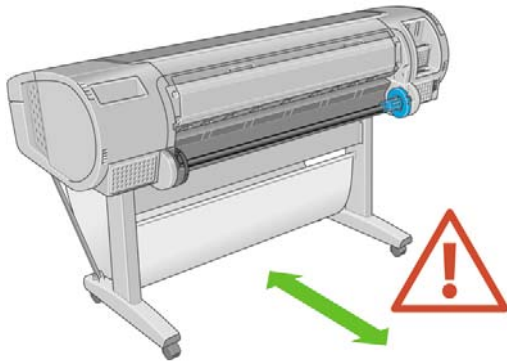

- ⚠ **CAUTION:** Make sure the printer wheels are locked (the brake lever is pressed down) to prevent the printer from moving.

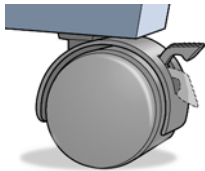

- 📄 **NOTE:** All paper must be 11 inches (28 cm) or longer. A4 and US Letter paper cannot be loaded landscape.

- 💡 **TIP:** For photo paper wear cotton gloves to avoid transferring oils onto the paper.

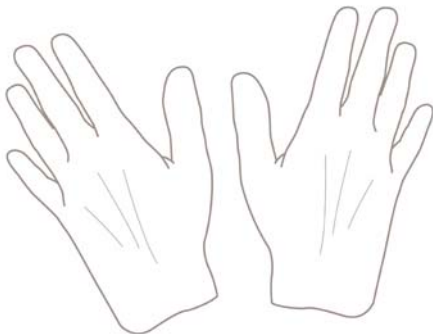

- ⚠ **CAUTION:** Keep the basket closed throughout the loading process.

Load a roll onto the spindle

- ⚠ **CAUTION:** Ensure the sheet tray is closed.

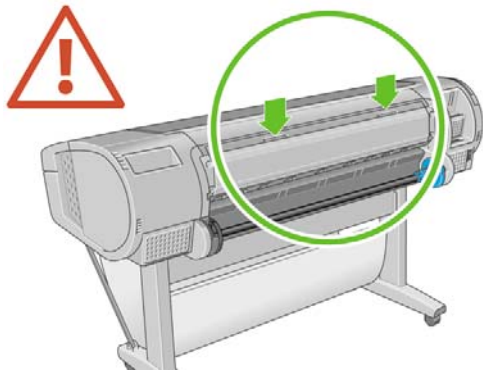

1. Remove the right-hand end of the spindle from the printer, then the other end.

⚠ **WARNING!** Do not insert your fingers into the spindle supports during the removal process.

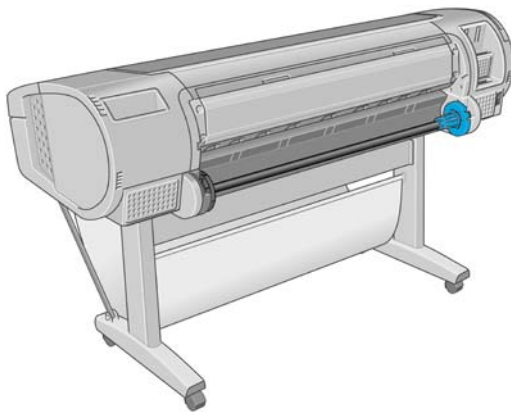

2. The spindle has a stop at each end to keep the roll in position. The blue stop can be removed to mount a new roll; it slides along the spindle to hold rolls of different widths. Remove the blue paper stop from the end of the spindle.



3. If your roll has a three-inch cardboard core, ensure that the core adaptors supplied with the printer have been installed.

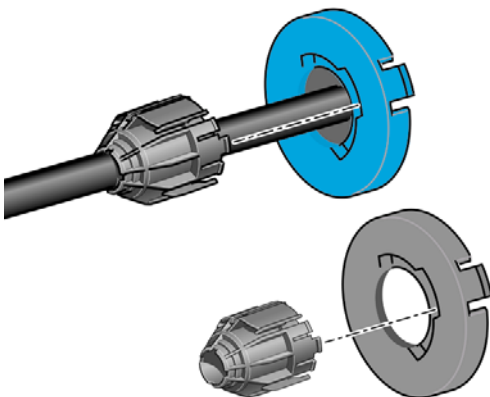

4. If the roll is long, rest the spindle horizontally on a table and load the roll on the table.

 **TIP:** You may need two people to handle a large roll.

5. Slide the new roll onto the spindle. Make sure the paper type is oriented as shown. If it is not, remove the roll, turn it 180 degrees and slide it back on to the spindle. There are labels on the spindle showing the correct orientation.

 **NOTE:** From the back of the printer, the blue stop is fitted onto the right-hand end of the spindle.

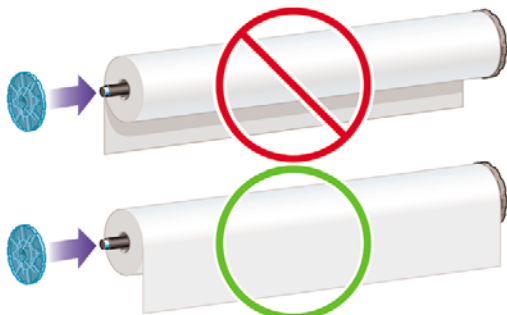

Ensure both ends of the roll are as close to the spindle stops as possible.

6. Put the blue paper stop onto the open end of the spindle, and push it towards the end of the roll.

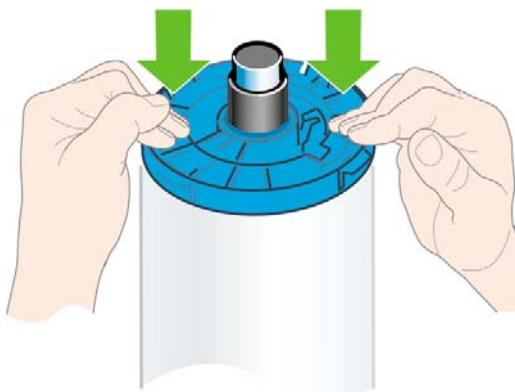

7. Ensure the blue paper stop is pushed in as far as it goes, until both ends are against the stops.

If you are a regular user of different paper types, you can change rolls more quickly if you preload rolls of different paper types on different spindles. Extra spindles are available for purchase, see [Accessories on page 101](#).

Load a roll into the printer

There are two ways to load a roll. The easy loading procedure is recommended.

To start these procedures you must have a roll loaded on the spindle. See [Load a roll onto the spindle on page 23](#).

Easy loading procedure

1. Standing behind the printer, rest the spindle's black end on the left side roll holder. Do not put the end completely into the roll holder.

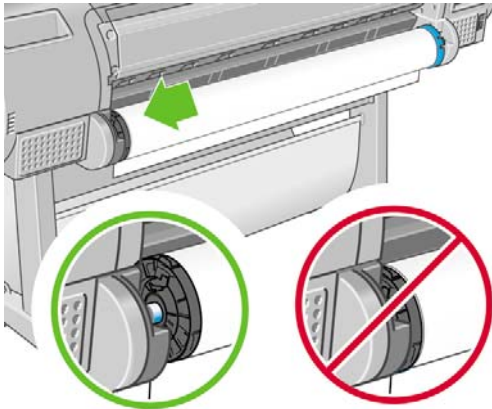

2. Rest the blue end of the spindle on the right side roll holder.

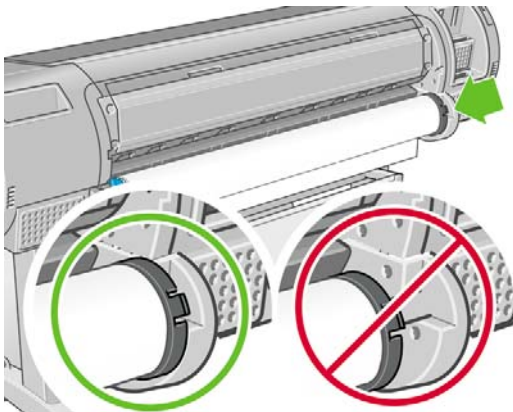

3. With both hands, push the spindle into both roll holders at the same time. The spindle snaps in place.

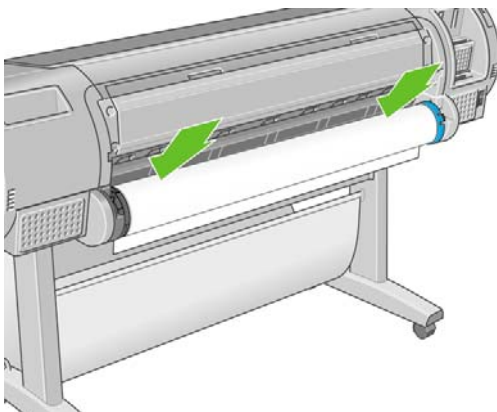

4. If the edge of the roll is torn (sometimes due to tape used to hold the end of the roll) or not straight, pull the paper slightly beyond the cutting groove and use a cutter to cut a straight edge.

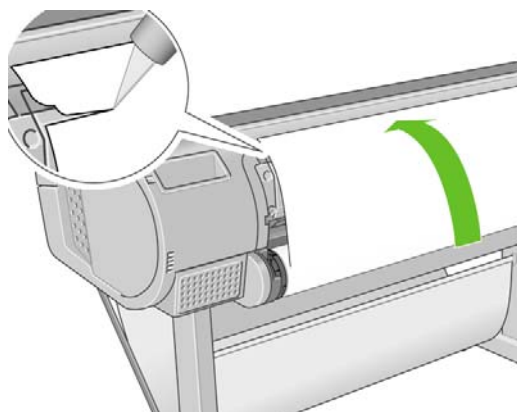

 **TIP:** Cut the paper as straight as possible, as uneven paper does not load correctly.

5. Insert the edge of the paper into the feeder.

 **CAUTION:** Do not push your fingers inside the printer's paper path.

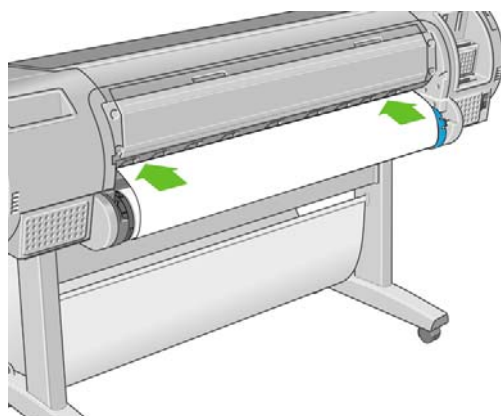

6. Roll the spindle into the feeder until you feel resistance. The printer detects the paper and feeds it automatically into the printer.

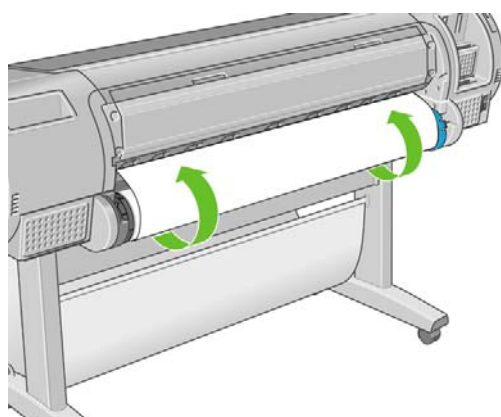

7. Once the paper is fed into the printer, the front-panel display asks whether you are loading a roll or a sheet. Select **Roll** with the **Up** and **Down** keys and press **OK**.

8. Select your paper category and type.

Select paper category

Bond and Coated Paper

Photo Paper

Proofing Paper

Fine Art Material

Film

Technical Paper

 **TIP:** If you have loaded a paper type whose name does not appear in the paper list, see [The paper type is not in the driver on page 113](#).

9. The printer checks the alignment and measures the width. It cuts a strip off the leading edge of glossy or satin paper to ensure perfect quality; other paper types are not cut.
10. Look at the front panel; you may find some instructions there.
11. When the roll is aligned, the front panel displays the **Ready** message and the printer is ready to print. If the roll is not aligned, follow the instructions on the front-panel display.
12. If the paper is loose on the roll, lightly rewind from the end of the spindle until tight.

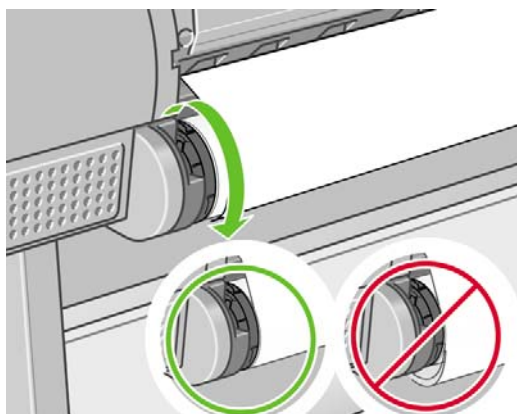

 **NOTE:** If you have an unexpected issue at any stage of the paper loading process, see [The paper cannot be loaded successfully on page 112](#).

 **TIP:** When prints fall into the basket, they can be torn or marked by ink from other prints. To avoid this, catch your prints as they are cut from the roll and do not stack prints in the basket. Alternatively, turn off the automatic cutter, see [Turn the automatic cutter on and off on page 40](#), and use the **Form feed and cut** key to release your print.

Paper menu procedure

As an alternative you can use the paper menu to start the paper loading process.

1. Follow steps one through five of the [Easy loading procedure on page 26](#).

2. From the front panel, select the Paper menu icon .

3. Select **Paper load**.

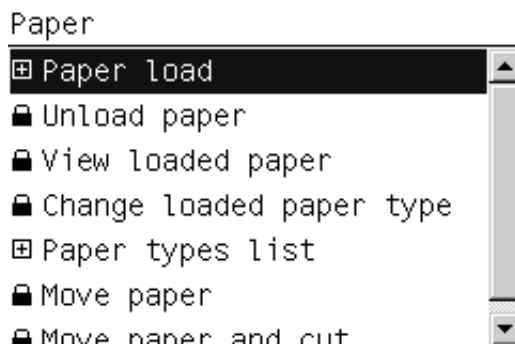

4. Select **Load roll**.

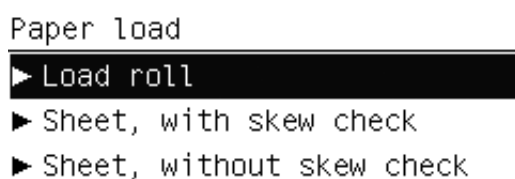

5. Continue with step 9 of the easy loading process (see [Select your paper category and type on page 28](#)).

Unload a roll

Before unloading a roll, check whether there is paper on the roll or whether the end of the paper is no longer attached to the roll, and follow the appropriate procedure as described below.

 **TIP:** Do not touch the paper while the printer is printing, as it will cause image quality defects.

Unload paper key procedure with paper on the roll

If there is paper on the roll, use the following procedure.

1. Press the **Unload paper** key on the front panel.
2. When prompted by the front-panel display, lift the blue lever on the left.
3. When prompted by the front-panel display, lightly rewind the paper from the end of the spindle until removed from the printer.
4. When prompted by the front-panel display, lower the blue lever.

Paper menu procedure with paper on the roll

If there is paper on the roll, you can also start the process from the front panel.

1. Select the Paper menu icon .

2. Select **Unload paper**.

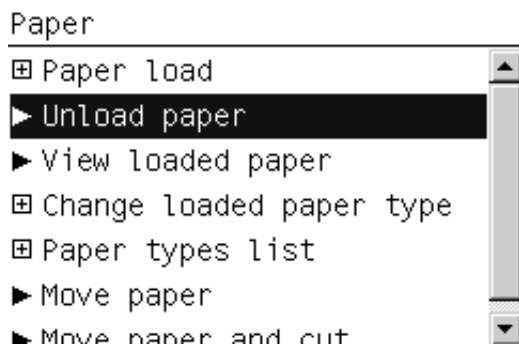

3. Continue from step two of the **Unload paper** key process.

Roll out of paper procedure

If the end of the paper is no longer attached to the roll, use the following procedure.

1. If you have already started the unload process, press the **Cancel** key on the front panel to cancel that procedure.
2. Lift the blue lever on the left. If the front panel displays a warning about the lever, ignore it.
3. Pull out the paper from the printer. Pull from wherever the paper is accessible; the back of the printer is recommended.
4. Lower the blue lever.
5. If the front panel displays a warning message, press the **OK** key to clear it.

Load a single sheet

There are two ways to load a sheet. The easy loading procedure is recommended.

Any loaded roll or sheet must be unloaded before loading a sheet, see [Unload a roll on page 29](#) or [Unload a single sheet on page 33](#).

 **NOTE:** For sheets thicker than 0.5mm, you must have space behind the printer equal to the length of the sheet.

Easy loading procedure

1. Standing in front of the printer, open the sheet tray.

 **TIP:** If the tray is difficult to open, try opening from behind the printer.



2. Insert the sheet into the feeder. Load your sheet aligned with the load line and insert until the paper will not continue, with thicker sheets you feel resistance. The printer detects the sheet in three seconds. A countdown begins on the front-panel display.

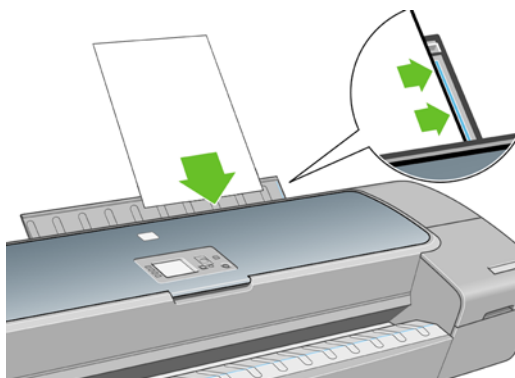

△ **CAUTION:** Do not push your fingers inside the printer's paper path.

3. After the countdown, the paper feeds into the printer. Guide the sheet into the printer; this is especially important with thicker papers.
4. The front-panel display asks whether you are loading a roll, a sheet with skew check, or a sheet without skew check. Select **Sheet, with skew check** or **Sheet, without skew check** with the **Up** and **Down** keys.

📄 **NOTE:** The recommended option is **Sheet, with skew check**.

NOTE: If you load without a skew check, print previews may not work properly. See [Preview a print on page 46](#).

5. Select your paper category and type.

Select paper category

⊕ Bond and Coated Paper

⊕ Photo Paper

⊕ Proofing Paper

⊕ Fine Art Material

⊕ Film

⊕ Technical Paper

💡 **TIP:** If you have loaded a paper type whose name does not appear in the paper list, see [The paper type is not in the driver on page 113](#).

6. If you selected **Sheet** in the **Paper Load** menu, the printer checks the alignment and measures the sheet.

 **NOTE:** Depending on the length of the sheet, it feeds out the front of the printer.

If you selected **Sheet, without skew check**, you will need to align the sheet manually.

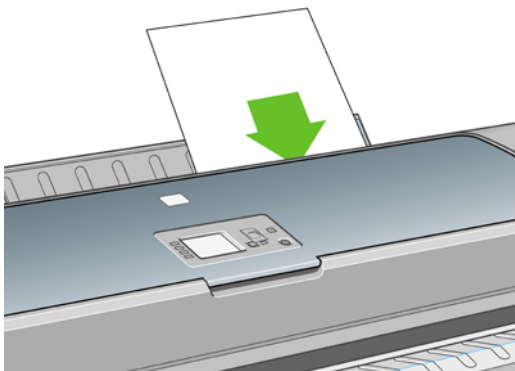

7. If the paper has been loaded successfully, the front panel displays the **Ready** message and the printer ready to print. If the paper is not straight, follow the instructions on the front-panel display.

 **NOTE:** When correctly loaded, the sheet is in the back of the printer.

NOTE: If you have an unexpected problem at any stage of the paper loading process, see [The paper cannot be loaded successfully on page 112](#).

Paper menu procedure

As an alternative you can use the front panel to start the paper loading process

1. Perform step one of the easy loading procedure.

2. Select the Paper menu icon .

Main Menu



3. Select **Paper load**.

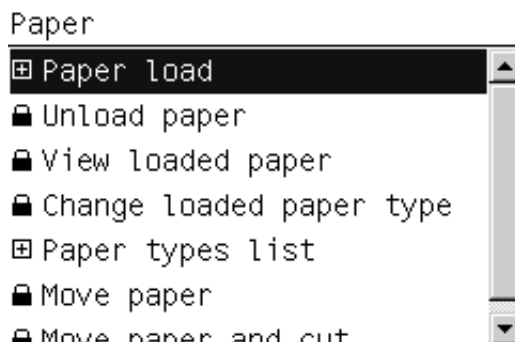

4. Select **Sheet, with skew check** or **Sheet, without skew check**.

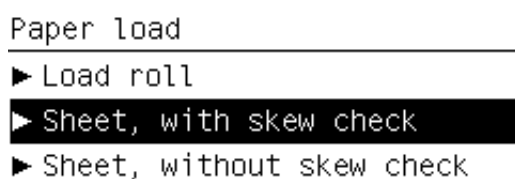

 **NOTE:** The recommended option is **Sheet, with skew check**.

NOTE: If you load without a skew check, print previews may not work properly. See [Preview a print on page 46](#).

5. Continue with step 5 of the easy loading procedure (see [Select your paper category and type on page 31](#)).

Unload a single sheet

To unload a sheet without printing, use the **Unload paper** key or the paper menu procedure.

 **NOTE:** To unload a single sheet after printing, you can simply pull the sheet free from the front of the printer.

 **TIP:** Do not touch the paper while the printer is printing, as it will cause image quality defects.

Unload paper key procedure

1. Press the **Unload paper** key on the front panel.
2. The sheet unloads out the front of the printer, either catch it manually or allow it to fall into the basket.

Paper menu procedure

You can also unload a sheet from the Paper menu.

1. Select the Paper menu icon .



2. Select **Unload paper**. The sheet unloads out of the front of the printer, either catch it manually or allow it to fall into the basket.

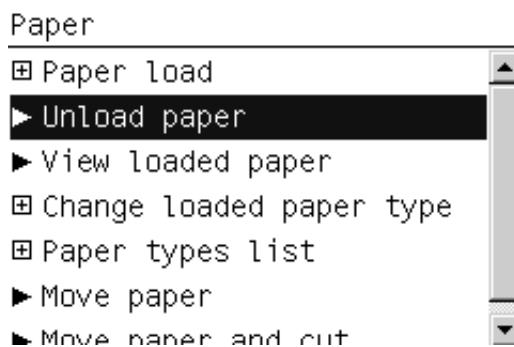

View information about the paper

To view the loaded paper information, press the **View loaded paper** key on the front panel.

You can also select the Paper menu icon  and then **View loaded paper**.

The following information is displayed on the front panel:

- Roll or sheet status
- Paper type you have selected
- Width of the paper (estimated)
- Length of the sheet (estimated)
- Color calibration status
- Paper advance calibration status

 **NOTE:** If you loaded a cut sheet with no skew check, the estimated length should be disregarded because the printer cannot estimate it accurately.

If no paper is loaded, the message **Out of paper** is displayed.

The same information (apart from the color and paper advance calibration status) is displayed in the HP Printer Utility, on the Supplies page.

 **NOTE:** Photo and coated paper requires careful handling, see [The print is scuffed or scratched on page 124](#).

Paper presets

Each supported paper type has its own characteristics. For optimum print quality, the printer changes the way it prints on each different paper type. For example, some may need more ink and some may require a longer drying time. So the printer must be given a description of the requirements of each paper type. This description is called the paper preset. The paper preset contains the ICC profile, which describes the color characteristics of the paper; it also contains information on other characteristics and requirements of the paper that are not directly related to color. Existing paper presets for your printer are already installed in the printer's software.

However, as it is inconvenient to scroll through a list of all paper types available, your printer contains paper presets only for the most commonly used paper types. If you have a paper type for which your printer has no preset, you cannot select that paper type in the front-panel display.

There are three ways to assign a preset for a new paper type.

- Import a paper preset that you have downloaded from the Web. See [To install a downloaded paper preset on page 35](#).
- Create your own paper preset using the HP Color Center. See [To create your own paper preset on page 36](#).
- Advanced users can create and adjust paper presets using the HP Color Center. See [Advanced paper preset creation on page 37](#).

 **NOTE:** You can use a maximum of 30 custom and additional paper types. To delete a custom or additional paper preset, go to the Color Center and select **Paper Preset Management > Delete Paper Preset**. Paper presets provided with your printer cannot be deleted.

To install a downloaded paper preset

1. After finding the right paper preset at <http://www.hp.com/go/z3200/paperpresets/> or at the paper manufacturer's Web site, click the **Download Now** button and save the paper preset (".oms" file) on your computer.

 **NOTE:** If you do not find the paper preset you want on the Web, you may find that it has been added to the latest firmware for your printer. You can check the firmware release notes for information, see [Update the firmware on page 98](#).

2. Before starting to install the new preset, make sure that the printer is idle and the print queue is stopped. Installing a new paper preset will interrupt any printing that is in progress.
3. Start the HP Printer Utility or the Embedded Web Server.
 - In the HP Printer Utility, select the **Color Center** and then **Import Paper Preset**.
 - In the Embedded Web Server, select the **Setup** tab, then **Paper preset management**, then the **Import** tab.
4. On the Import page, select the paper preset file that you downloaded in step 1.
5. Click the **Update** button and wait for the update process to finish. It may take some time. The printer will automatically restart when the update is complete; wait until it has restarted and the front panel indicates that it is ready.

6. Check that the new paper type appears in the **Additional paper** or **Custom paper** category in your printer's front panel.
7. Synchronize the new paper type with the driver by opening the HP Printer Utility. Select your printer, then the **Color Center** tab, then **Paper Preset Management** and **Synchronize Paper Presets** ( button under Mac OS).

Now that you have imported the paper preset, you can select the paper type from the front panel and from the driver. The ICC profile for the new paper type is ready to use by your application.

To create your own paper preset

Before using a custom paper type with your printer, you should add a paper preset for the new paper. You can create a new paper preset using the HP Color Center in the HP Printer Utility.

The paper preset name will appear in the printer driver and the front panel.

To create a paper preset, you can follow this simple procedure:

1. Go to the **Color Center** tab in the HP Printer Utility for Windows, or to the HP Color Center group in the HP Printer Utility for Mac OS.
2. Select **Create New Paper Preset**.
3. Enter your paper's name.

 **TIP:** The paper's commercial name is likely to be the most understandable for other users of the printer.

4. Select a paper category from the drop-down menu. The paper category determines the amount of ink used and other basic printing parameters. For more information, see the online help  in the Color Center, and <http://www.hp.com/go/Z3200/paperpresets/>. The available categories are:
 - **Bond and Coated Paper:** Fiber-based, thin papers with a matte surface. These papers use matte black ink, no gloss enhancer, relatively low ink limits and high carriage position.
 - **Photo Paper:** Photo-base, relatively thick papers with a variety of finishing from matte to satin to glossy. These papers use photo black ink and gloss enhancer, with the exception of Photo Matte Papers, relatively high ink limits and low carriage position, with the exception of Baryte and Photo Matte Papers. Generally they will print with the starwheels up.
 - **Proofing Paper:** A variety of papers from matte to satin and glossy used to simulate commercial printing with high color accuracy requirements.
 - **Fine Art Material:** Canvas, matte and paper-base photo materials used for high-quality fine art printing. These papers use matte black ink and no gloss enhancer, with the exception of Canvas Satin and Pearl papers, which use photo black and gloss enhancer. They all use high carriage position with high ink limits.
 - **Film:** Synthetic film-base materials that generally use photo black and no gloss enhancer, with relatively low ink limits and high carriage position.
 - **Backlit:** Synthetic translucent materials that use photo black and no gloss enhancer with high ink limits, high carriage position and starwheels up.
5. Click **Next** under Windows, **Continue** under Mac OS.
6. Load your custom paper, see [Load a roll into the printer on page 25](#) or [Load a single sheet on page 30](#). You will find the paper name in the **Custom paper** category in the front panel.
7. Choose the ICC profile name in the Color Center. This is the name you will use to select the profile in your application.

8. Click **Next** under Windows, **Continue** under Mac OS.
9. If the paper type permits, the printer performs a color calibration (about 10 minutes) and creates the ICC profile (about 20 minutes).

Now that you have created the paper preset, you will be able to select the paper type from the front panel and from the driver under the **Custom paper** category. The ICC profile for the new paper type will be ready to use by your application.

You can export the new paper preset to your computer and use it on other HP Designjet Z3200 series printers. In the Color Center, select **Paper Preset Management > Export Paper Preset**, then follow the instructions on the screen. To install the preset on another printer, see [To install a downloaded paper preset on page 35](#).

Advanced paper preset creation

Advanced paper preset creation involves a process of trial and error, in which you modify the printing properties of your new preset to obtain the best print quality.

1. Go to the **Color Center** tab in the HP Printer Utility for Windows, or to the HP Color Center group in the HP Printer Utility for Mac OS.
2. Select **Paper Preset Management**.
3. Under Windows, select **Create Paper Preset**. Under Mac OS, click **+**.
4. Enter your paper's name.

 **TIP:** The paper's commercial name is likely to be the most understandable for other users of the printer.

5. Select a paper category from the drop-down menu. The paper category determines the amount of ink used and other basic printing parameters. For more information, see the online help  in the Color Center, and <http://www.hp.com/go/Z3200/paperpresets/>. The available categories are:
 - **Bond and Coated Paper:** Fiber-based, thin papers with a matte surface. These papers use matte black ink, no gloss enhancer, relatively low ink limits and high carriage position.
 - **Photo Paper:** Photo-base, relatively thick papers with a variety of finishing from matte to satin to glossy. These papers use photo black ink and gloss enhancer, with the exception of Photo Matte Papers, relatively high ink limits and low carriage position, with the exception of Baryte and Photo Matte Papers. Generally they will print with the starwheels up.
 - **Proofing Paper:** A variety of papers from matte to satin and glossy used to simulate commercial printing with high color accuracy requirements.
 - **Fine Art Material:** Canvas, matte and paper-base photo materials used for high-quality fine art printing. These papers use matte black ink and no gloss enhancer, with the exception of Canvas Satin and Pearl papers, which use photo black and gloss enhancer. They all use high carriage position with high ink limits.
 - **Film:** Synthetic film-base materials that generally use photo black and no gloss enhancer, with relatively low ink limits and high carriage position.
 - **Backlit:** Synthetic translucent materials that use photo black and no gloss enhancer with high ink limits, high carriage position and starwheels up.

6. If you wish, use the **Change Printing Properties** button to change the following properties:
 - **Paper Thickness:** This is relevant to carriage height or platen gap. You should choose **High** if your paper weighs over 250 g/m² or if it does not have a plastic coating.
 - **Dry Time:** The recommendation is to use **Automatic** by default and move to **Extended** if needed.
 - **Starwheels:** Print with the starwheels up or down.
 - **Cutter:** Enable or disable the cutter.
 - **Global Ink Limit:** Initially it can be left as it is and modified later on, based on printing results.
 - **Gloss Enhancer Amount:** Initially it can be left as it is and modified later on, based on printing results.

 **NOTE:** When an option is grayed out, that means that it is not available for the selected paper type.

Some paper types are available with different ink limits (less/normal/more ink). Ink limits are generally proportional to color gamut volume, but a higher ink limit can cause printing artifacts (bleed, coalescence, etc.) in some cases. HP papers have fine-tuned ink limits while other papers use generic ink limits.

7. Click **Next** under Windows, **Continue** under Mac OS.
8. Load your custom paper, see [Load a roll into the printer on page 25](#) or [Load a single sheet on page 30](#). You will find the paper name in the **Custom paper** category in the front panel.
9. Under Windows, select **yes** when asked to calibrate paper. Under Mac OS, select **Paper Preset Management > Calibrate Paper**. For more information on color calibration, see [Color calibration on page 60](#).
10. You can print an image of your choice to check for color gamut, coalescence, mottle, bronzing and gloss uniformity. If the results are not satisfactory, you can change printing properties and launch another calibration. For instance:
 - For better color gamut, increase the ink limit **or** select a "more ink" variant of the same paper type if available.
 - To reduce coalescence, decrease the ink limit and/or the amount of gloss enhancer **or** select a "less ink" variant of the same paper if available.
 - To reduce bronzing or improve gloss uniformity, adjust the amount of gloss enhancer.

For more information, see the online help  in the Color Center.

11. With your final printing properties, you can now create an ICC profile for the paper using one of the following three options:
 - The standard process with the Color Center (see [Color profiling on page 61](#)).
 - The HP Advanced Profiling Solution (supplied with your printer). For more information on the HP Advanced Profiling Solution, see its own documentation and also <http://www.hp.com/go/z3200/solutions/>.
 - A third-party profiling program (see [Color measurement on page 63](#)).
12. Once you have created and adjusted the ICC profile for your paper, you can link this profile to the paper preset with the Color Center: select **Paper Preset Management > Install Profile**. If you have used the standard Color Center profiling process, this step is not necessary because the profile is linked automatically to the paper preset.

For more information on the processes available in the Color Center, see [A summary of the color management process on page 59](#).

Now that you have created the paper preset, you will be able to select the paper type from the front panel and from the driver under the **Custom paper** category. The ICC profile for the new paper type will be ready to use by your application.

You can export the new paper preset to your computer and use it on other HP Designjet Z3200 series printers. In the Color Center, select **Paper Preset Management > Export Paper Preset**, then follow the instructions on the screen. To install the preset on another printer, see [To install a downloaded paper preset on page 35](#).

Print on loaded paper

To print a job on whichever paper is loaded in the printer, select **Any** in the Paper Type option of your printer driver.

- **In the Windows driver dialog:** select the Paper/Quality tab, then select **Any** in the Paper Type drop-down list.
- **In the Mac OS Print dialog:** select the Paper Type/Quality panel, then select **Any** in the Paper Type drop-down list.

 **NOTE:** **Any** is the default Paper Type selection.

Move the paper

If the printer is idle (ready to print), you can move the paper forwards or backwards from the front panel. You may want to do this in order to have more or less white space between the last print and the next one.

To move the paper, select the Paper menu icon  and then **Move paper**.

Move paper

Press ▲ to rewind paper.

Press ▼ to advance paper.

Press OK to continue.

You can move the paper forwards by pressing the **Up** key on the front panel, or backwards by pressing the **Down** key. When the paper is positioned as you want it, press the **OK** key.

Maintain the paper

To maintain paper quality, follow the recommendations below.

- Store rolls covered by another piece of paper or cloth.
- Store cut sheets covered and clean or brush them before loading them in the printer.
- Clean input and output platens and cut sheet tray.
- Always keep the transparent window of your printer closed.

 **NOTE:** Photo and coated paper requires careful handling, see [The print is scuffed or scratched on page 124](#).

Change the drying time

You may wish to change the drying time setting to suit special printing conditions such as multiple prints where time is of higher importance or when you need to be sure ink is dry before handling.

 **NOTE:** Most paper types require no drying time.

Select the Setup menu icon , then **Print retrieval > Select drying time**. You can select:

- Extended, to set a longer than recommended time to ensure ink is completely dry
- Optimal, to set the default and recommended time for your selected paper
- Reduced, to set a shorter than recommended time when quality is of lower importance
- None, to disable the drying time and remove your print as soon as it finishes printing

 **TIP:** If the ink is not dry when the print is removed it could leave ink in the output tray and marks on the print.

 **NOTE:** If you cancel the drying time during a print, the printer may not feed and cut the paper right away due to the printhead maintenance, which runs in parallel. If the dry time is zero, the printer cuts the paper and then performs the printhead maintenance. However, if the dry time is greater than zero, the printer does not cut the paper until after the printhead maintenance has completed, even if the **Form feed and cut** key has been pressed.

Turn the automatic cutter on and off

To turn the printer's paper cutter on or off:

- From the HP Printer Utility for Windows, select the **Settings** tab and change the **Cutter** option in **Printer Settings > Advanced**.
- From the HP Printer Utility for Mac OS, in the Configuration group, select **Printer Settings > Configure Printer Settings** and change the **Cutter** option in **Printer Settings > Advanced**.
- From the Embedded Web Server, select the **Setup** tab, then **Printer Settings**, and change the **Cutter** option in **Printer Settings > Advanced**.
- From the front panel, select the Setup menu icon , and then **Print retrieval > Enable cutter**.

 **NOTE:** To cut rolled paper while the automatic cutter is disabled, see [Feed and cut the paper on page 40](#).

Feed and cut the paper

To feed and cut the paper when the automatic cutter has been disabled, or when the front edge of the paper is not straight, press the **Form feed and cut** key on the front panel. The paper advances and a message is displayed on the front panel:

Select the cutting position by pressing the arrow keys backward and forward

If you immediately press the **OK** key, the printer will make a straight cut removing a 4-inch strip from the front edge of the paper.

Alternatively, you can use the **Up** and **Down** keys to remove more or less of the paper (minimum 2 inches). Open the window to see where the cut will be made, indicated by a scissors label at the side of the carriage. The window can remain open while you are moving the paper. When you have finished moving the paper, close the window and press the **OK** key.

 **NOTE:** The printer may not cut the paper immediately, as the printheads are serviced after each print and the paper cannot be cut until that process is complete.

When the paper has been cut, remove the cut piece from the output tray.

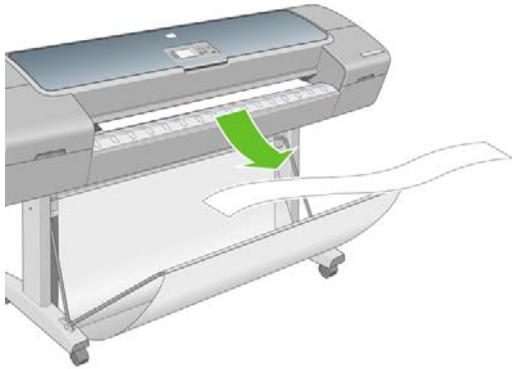

 **TIP:** If strips or short prints are left in the output tray the printer could jam.

TIP: Photo and coated paper requires careful handling, see [The print is scuffed or scratched on page 124](#).

5 Printing

- [Select print quality](#)
- [Select paper size](#)
- [Select margins options](#)
- [Print with shortcuts](#)
- [Rescale a print](#)
- [Preview a print](#)
- [Print a draft](#)
- [High-quality printing](#)
- [Print in gray shades](#)
- [Print with no margins](#)
- [Reprint an old job](#)
- [Rotate an image](#)
- [Print with crop lines](#)
- [Print on sheet paper](#)
- [Use paper economically](#)
- [Use ink economically](#)

Select print quality

The printer has various print-quality options because best-quality printing requires some loss of speed, while fast printing implies some reduction in print quality.

Therefore, the standard print-quality selector is a slider that allows you to choose between quality and speed.

Alternatively, you can select from the custom options: **Best**, **Normal** and **Fast**. There are also three supplementary custom options that may have an effect on print quality: **Maximum detail**, **More passes** and **Gloss enhancer**. See [High-quality printing on page 47](#).

 **NOTE:** In the Windows driver dialog, the rendering and printing resolutions for your job are displayed in the **Paper/Quality** tab. In the Mac OS Print dialog, they are displayed in the **Summary** panel.

You can select print-quality options in the following ways:

- **In the Windows driver dialog:** go to the **Paper/Quality** tab and look at the Print Quality section. If you select **Standard Options**, you will see a simple slider with which you can select speed or quality. If you select **Custom Options**, you will see the more specific options described above.
- **In the Mac OS Print dialog:** go to the **Paper Type/Quality** panel and select **Paper**. If you select **Standard** quality options, you will see a simple slider with which you can select speed or quality. If you select **Custom** quality options, you will see the more specific options described above.

 **NOTE:** You cannot change the print quality of pages that the printer is already receiving or has already received (even if they have not started to print yet).

Select paper size

The paper size can be specified in the following ways.

 **NOTE:** The paper size specified here should be the paper size in which the document was created. It is possible to rescale the document to a different size for printing. See [Rescale a print on page 45](#).

- **In the Windows driver dialog:** select the **Paper/Quality** tab, then select your paper size from the Document Size list.
- **In the Mac OS Page Setup dialog:** select your printer in the **Format for** popup menu, then **Paper Size**.

 **TIP:** If your document is 13 × 19 in (33 × 48.3 cm), designed to fit on sheet paper of the same size, select the document size **Super B/A3**.

Custom paper sizes

To choose a non-standard paper size not shown in the list of paper sizes:

- **Under Windows**, there are two different ways:
 - In the driver dialog, press the **Custom** button in the **Paper/Quality** tab, then specify the name and the dimensions of your new paper size, then click **Save** to save your new paper size.
-  **NOTE:** The driver will not allow you to create a paper size whose width exceeds its length.
- From the **Start** menu, select **Printers and Faxes**, then from the **File** menu select **Server Properties**. In the **Forms** tab, check the **Create a new form** box, specify the name and dimensions of the new form, then click **Save Form**.
- **In the Mac OS Page Setup dialog**, select **Paper Size > Manage Custom Sizes**.

Select margins options

By default, the printer leaves a 5 mm margin between the edges of your image and the edges of the paper (17 mm at the foot of a sheet of paper). However, you can change this behavior in several ways.

- **In the Windows driver dialog:** select the **Paper/Quality** tab and then the **Margins/Layout** button.
- **In the Mac OS Print dialog:** select the **Paper Type/Quality** panel and then **Layout**.

You will then see at least some of the following options.

 **NOTE:** Under Mac OS, the available margins options depend on the paper size selected in the Page Setup dialog. For instance, for borderless printing you must select a paper size name that includes the words “no margins”.

- **Standard.** Your image will be printed on a page of the size you have selected, with a narrow margin between the edges of the image and the edges of the paper. The image should be small enough to fit between the margins.
- **Oversize.** Your image will be printed on a page slightly larger than the size you have selected. If you cut off the margins, you will be left with a page of the size you selected, with no margins remaining between your image and the edges of the paper.
- **Clip Contents By Margins.** Use this option when your image has white borders and a size equal to that of the paper you have selected. The printer will use the white border for its margins and you will get a page of size equal to that which is selected in the driver.
- **Borderless.** Your image will be printed on a page of the size you have selected, with no margins. The image is slightly enlarged to ensure that no margin is left between the edges of the image and the edges of the paper. If you select **Automatically by Printer**, this enlargement is done automatically. If you select **Manually in Application**, you should ensure that the image size in your application is slightly larger than the paper size. See also [Print with no margins on page 49](#).

Print with shortcuts

The printer driver provides many options that can be set to different values when printing a particular job. A printing shortcut stores the values of all these options that are appropriate for a particular kind of job, so that you can set them all with a single click. Some settings (such as paper size, paper source and orientation) may be overridden by the values provided by your application.

To use a shortcut, select the **Printing Shortcuts** tab in the Windows driver dialog.

 **NOTE:** Shortcuts are available only under Windows.

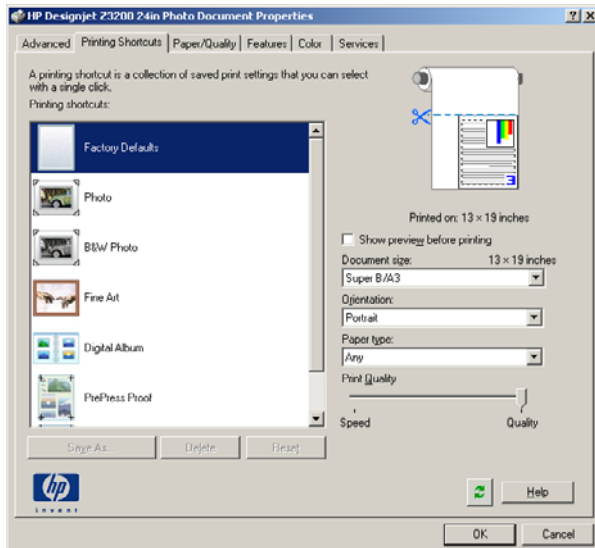

You can see a list of available shortcuts; select the one that matches the kind of job you want to print.

The driver options are now adjusted to suit your job. You can either print immediately, or examine the settings to check that you agree with them. If you like, you can select a shortcut and then change some of its settings manually.

 **TIP:** Check at least the settings that you can see in the **Printing Shortcuts** tab: the document size, orientation, etc.

The Factory Defaults shortcut contains the printer's default settings. When you click it, it sets all options to their default values.

Printing shortcuts can be customized to your particular needs. To create your own shortcut:

1. Select the shortcut that comes closest to satisfying your requirements.
2. Change any value in the **Printing Shortcuts** tab and/or other tabs.
3. Save the new printing shortcut.

If you decide later that you no longer want a shortcut, you can delete it.

Rescale a print

You can send an image to the printer at a certain size but tell the printer to rescale it to a different size (normally larger). This may be useful if your software does not support large prints.

You can rescale an image in the following ways:

- **In the Windows driver dialog:** go to the **Features** tab and look at the Resizing Options section.
 - The **Print document on** option adjusts the image size to the paper size you have selected. For example, if you have selected ISO A2 as the paper size and you print an A4-size image, it is enlarged to fit the A2 paper. If the ISO A3 paper size is selected, the printer reduces a larger image to fit the A3 size.
 - The **% of actual size** option enlarges the printable area of the original paper size (the page minus the margins) by the percentage indicated, then adds the margins to create the output paper size.
- **In the Mac OS Print dialog:** select the **Paper Handling** panel, then **Scale to fit paper size**, and select the paper size to which you want to scale the image. If you want to increase the size of the image, make sure that the **Scale down only** box is unchecked.

If you are printing to a single sheet, you must ensure that the image can actually fit onto the sheet, otherwise the image will be clipped.

Preview a print

Previewing a print on the screen allows you to check the layout of the print before printing, which may help you to avoid wasting paper and ink on a bad print.

 **NOTE:** If you load sheet paper without a skew check, the printer does not measure the length of the sheet, so the print preview will not be a reliable guide to the final printout.

- To preview a print under Windows, you have two options:
 - Use your application's print preview option.
 - Check the **Show preview before printing** option, which you can find in the driver's **Printing Shortcuts** tab, **Paper/Quality** tab and **Features** tab. The preview is shown before printing; you can check the print settings and the layout of the image, and then click **Print** to proceed with printing or **Cancel** to cancel the job.

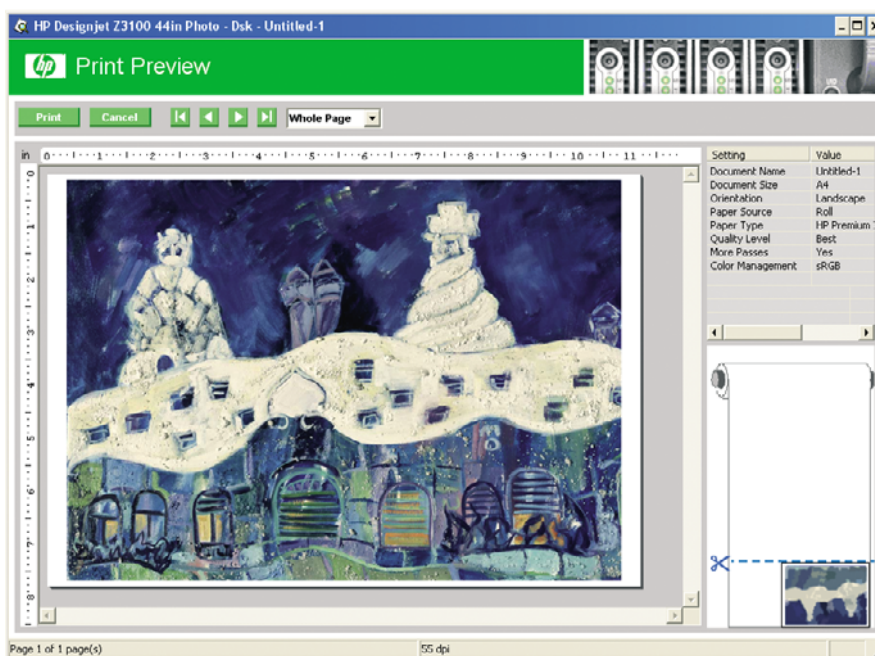

- To preview a print under Mac OS, you have three options:
 - Use your application's print preview option.
 - Click the **Preview** button at the bottom of the Print dialog box. This is the basic print preview provided by Mac OS.

- Click the **PDF** button at the bottom of the Print dialog box, then click **HP Print Preview**. This provides a preview with more features, such as the ability to change paper size, paper type and print quality, and to rotate the image. See below:

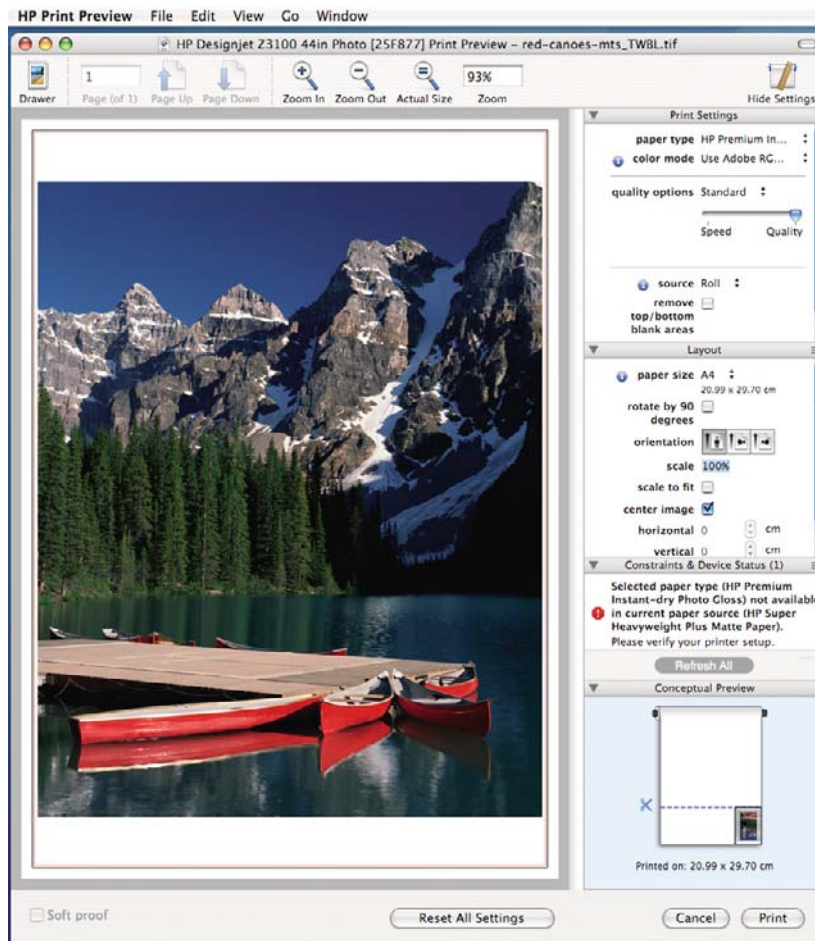

 **NOTE:** HP Print Preview is not available if you are using Adobe InDesign, Adobe Illustrator, Adobe Reader or Apple Aperture.

Print a draft

You can specify fast draft-quality printing in the following ways:

- **In the Windows driver dialog:** go to the **Paper/Quality** tab and look at the Print Quality section. Move the print-quality slider to the extreme left ('Speed').
- **In the Mac OS Print dialog:** go to the **Paper Type/Quality** panel and select **Paper**, then move the print-quality slider to the extreme left ('Speed').

High-quality printing

You can specify high-quality printing in the following ways:

- **In the Windows driver dialog:** go to the **Paper/Quality** tab and look at the Print Quality section. Move the print-quality slider to the extreme right ('Quality').
- **In the Mac OS Print dialog:** go to the **Paper Type/Quality** panel and select **Paper**, then move the print-quality slider to the extreme right ('Quality').

If you have a high-resolution image

If your image has a resolution greater than the rendering resolution (which you can see in the driver's **Paper/Quality** tab under Windows), print sharpness may be improved by selecting the **Maximum Detail** option.

- In the driver dialog (Mac OS Print dialog): select custom instead of standard print-quality options, then check the **Maximum Detail** box.

 **NOTE:** The **Maximum Detail** option results in slower printing with photo papers, but it does not increase the amount of ink used.

If you have printhead problems

If your printheads have an excessive number of clogged nozzles (which may cause banding or white streaks on your prints), print quality can be improved by selecting the **More Passes** option.

- In the driver dialog (Mac OS Print dialog): select custom instead of standard print-quality options, then check the **More Passes** box.

 **NOTE:** The **More Passes** option results in slower printing, but it does not increase the amount of ink used.

 **TIP:** Instead of using this option, consider using the Image Diagnostics Print to identify the printhead or printheads that are causing the problem, and then clean or replace them. See [The Image Diagnostics Print on page 133](#).

If you are printing on photo paper

If you are printing on photo paper, you have the option of using the gloss enhancer, which improves overall gloss quality and reduces or eliminates bronzing. There are three settings:

- **Off:** the gloss enhancer is not used.
- **Economode:** the gloss enhancer is used in inked areas of the image, but not in ink-free (white) areas.
- **Whole page:** the gloss enhancer is used over the whole area of the defined page, including ink-free areas.

If the print quality slider is set to Quality, the **Gloss enhancer** option is automatically set to **Whole page**. To change this setting:

- In the driver dialog (Mac OS Print dialog): select custom instead of standard print-quality options, then the **Gloss enhancer** option.

When **Gloss enhancer** is set to **Whole page**, you can further reduce bronzing, if necessary, by increasing the amount of gloss enhancer used. This can be done from the HP Printer Utility: select **Color Center > Paper preset management > Change printing properties**. The **Gloss enhancer amount** can be adjusted to use more or less gloss enhancer. Using more gloss enhancer will reduce bronzing and make the gloss more even across the page; however, it may cause blurriness or graininess.

If you are printing on satin photo paper

If you are printing on satin photo paper, consider using HP Professional Satin Photo Paper, which can offer:

- A wider color gamut
- Better black optical density

- Better PANTONE coverage
- A smoother surface
- Greater robustness

Print in gray shades

You can convert all colors in your image to shades of gray in the following ways:

- **In your application program:** many programs provide this option.
- **In the Windows driver dialog:** go to the **Color** tab and look at the Color Options section. Select **Print in Grayscale**.
- **In the Mac OS Print dialog:** go to the **Paper Type/Quality** panel and select **Color**, then select **Print In Grayscale**.

See also [Print a black-and-white photo for an exhibition \(Photoshop, Mac OS\) on page 70](#).

Print with no margins

Printing with no margins (to the edges of the paper) is known as borderless printing. This can be done only on rolls of glossy or satin paper.

In order to be sure of leaving no margins, the printer prints slightly past the edges of the paper. Any ink deposited outside the paper is absorbed by the sponge situated in the platen.

 **NOTE:** If you wish to print with no margins, you must ensure that your image will fill the page. If your image is smaller than the page, it will not be automatically stretched.

You can request printing with no margins in the following ways:

- **In the Windows driver dialog:** select the **Paper/Quality** tab and press the **Margins/Layout** button. Then select **Borderless**.
- **In the Mac OS Page Setup dialog:** select a paper size name that includes the words “no margins”. Then, in the Print dialog, select **Paper Type/Quality > Layout > Borderless**.

When you select **Borderless**, you must also select one of the following Image Enlargement options:

- **Automatically by Printer** means that the printer automatically enlarges your image slightly (normally by a few millimeters in each direction) in order to print over the edges of the paper.
- **Manually in Application** means that you must enlarge the image yourself in your application to a size slightly larger than the actual paper size.

 **NOTE:** If the first print job after loading paper is a borderless job, the printer may trim the leading edge of the paper before printing.

At the end of a borderless print, the printer normally cuts the print slightly inside the image area to ensure that the print is borderless. It then cuts the paper again so that no residual part of the image is included in the next print. However, if the job is cancelled, or if there is white space at the bottom of the image, only a single cut is made.

Reprint an old job

You can reprint the last job from the front panel: select the Job Management menu icon , then **Reprint last job**.

In addition, you may be able to use your operating system's printer spooler to reprint old jobs, if you have already told the spooler to save old jobs. This facility depends on your operating system.

Rotate an image

By default, images are printed with their shorter sides parallel to the leading edge of the paper, like this:

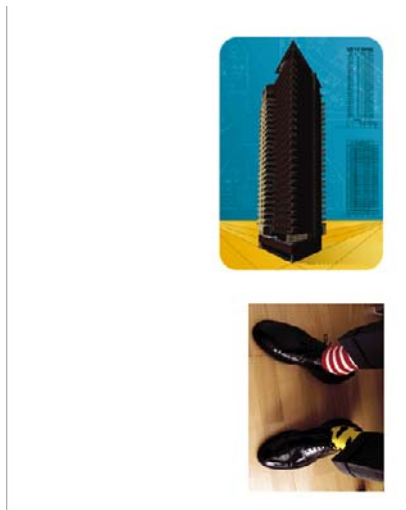

You may wish to rotate your images by 90 degrees in order to save paper, like this:

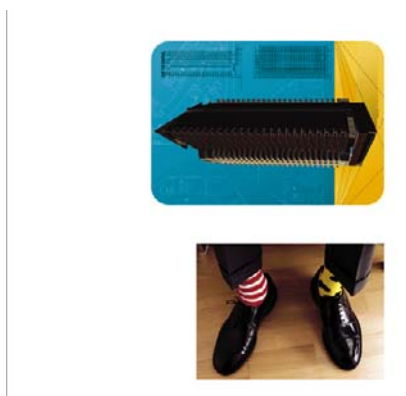

You can do this in the following ways:

- **In the Windows driver dialog:** select the **Features** tab, then **Rotate by 90 degrees**.
- **In the Mac OS Print dialog:** select the **HP Print Preview** and then **Rotate by 90 degrees**.
- **In the front panel:** select the Setup menu icon , then **Printing preferences > Paper > Rotate**.

 **NOTE:** If rotation is set from your computer, it overrides the setting in the front panel.

NOTE: When you rotate a job, the page length may be increased to avoid clipping, because the top and bottom margins are usually larger than the side margins.

NOTE: With either rolls or sheets, if you rotate an image to landscape whose original orientation was portrait, the paper may not be wide enough for the image. For example, rotating a portrait D/A1-size image on D/A1-size paper by 90 degrees will probably exceed the width of the paper. If you are using the Embedded Web Server, the preview screen will confirm this with a warning triangle.

Autorotate

With some printer drivers, you can also select the **Autorotate** option, which will automatically rotate by 90 degrees any oversized portrait images in order to save paper.

Print with crop lines

Crop lines indicate where the paper should be cut to reduce it to your selected page size. You can print crop lines automatically with individual jobs in the following ways:

- **In the Windows driver dialog:** select the **Features** tab, then **Enable crop lines**.
- **In the Mac OS Print dialog:** go to the **Paper Type/Quality** panel and select **Paper**, then select **Enable crop lines**.
- **Using the front panel:** select the Setup menu icon , then **Printing preferences > Paper > Enable crop lines > On**.

Print on sheet paper

To print on cut-sheet paper, first load the sheet of paper (see [Load a single sheet on page 30](#)). Then:

- **Under Mac OS:** select a paper size described as “for sheet paper”, then select **Manual Feed** as the **Paper Source**.
- **Under Windows:** select **Manual Feed** as the **Paper Source**.

Use paper economically

Here are some recommendations for making economical use of paper:

- If you are printing relatively small images, you can print up to 16 of them on one sheet of paper. Use the **Pages per sheet** option in the **Features** tab (Windows driver) or the **Layout** panel (Mac OS driver).

 **NOTE:** This works for multipage documents only.

- You may be able to save some roll paper by using the following options:
 - **In the Windows driver dialog:** select the **Features** tab and then **Remove Top/Bottom Blank Areas** and/or **Rotate by 90 degrees** or **Autorotate**.
 - **In the Mac OS Print dialog:** select the **Paper Type/Quality** panel, then **Paper**, then **Remove Top/Bottom Blank Areas**; and/or select **HP Print Preview**, then **Rotate by 90 degrees**.
- If you check the print preview on your computer before printing, you can sometimes avoid wasting paper on prints containing obvious mistakes. See [Preview a print on page 46](#).

Use ink economically

Here are some recommendations for making economical use of ink.

- Clean the printheads only when needed, and clean only those printheads that need cleaning. Cleaning the printheads can be useful, but it uses ink.
- Leave the printer permanently turned on so that it can maintain the printheads in good condition automatically. This regular printhead maintenance uses a small amount of ink. However, if it is not done, the printer may need to use much more ink later to restore the health of the printheads.
- Wide prints make more efficient use of ink than narrow prints, because printhead maintenance uses some ink, and its frequency is related to the number of passes made by the printheads.

6 Color management

- [What is color?](#)
- [The problem: color in the computer world](#)
- [The solution: color management](#)
- [Color and your printer](#)
- [A summary of the color management process](#)
- [Color calibration](#)
- [Color profiling](#)
- [Color management options](#)
- [Color adjustment options](#)
- [Color management scenarios](#)

What is color?

We see the world around us as steeped in color, where color is in the first instance simply an aspect of how we experience our environment. Color is therefore subjective. Upon further inspection we find that our color experiences are closely related to brain activity that is triggered by signals sent to it by our eyes. These signals undergo a complex and highly interlinked sequence of processing stages that make the relationship between what our eyes emit and what we experience anything but direct. The signals sent by the eye depend on the light-sensitive cells that line the back of our eyes, and they belong to three types, each sensitive to electromagnetic radiation of different physical properties (wavelengths). Such electromagnetic radiation is called light and objects appear to have certain colors because of how they interact with light (by emission, reflection, absorption, transmission, scattering, etc.).

Our individual experiences of color are also affected by our previous experiences and memories and by the way in which we put our experiences into language. Finally, environmental factors such as changes in lighting, scene content or the proximity of other colors also have an effect, which makes the way in which we view a given display or print an essential part of the colors we will see. Differences in all these aspects (from physiological differences between people, to differences in their past experiences, memories and linguistic tendencies) can result in people talking about colors differently even in response to the same light reflected from an single object. Nonetheless there are also many similarities between how individuals experience color and it is possible to make very specific judgments about it that others will also agree with when care is taken in the process. In conclusion we can say that color results from the interaction between light, objects and a viewer, which makes it a very complex and to a large degree subjective phenomenon.

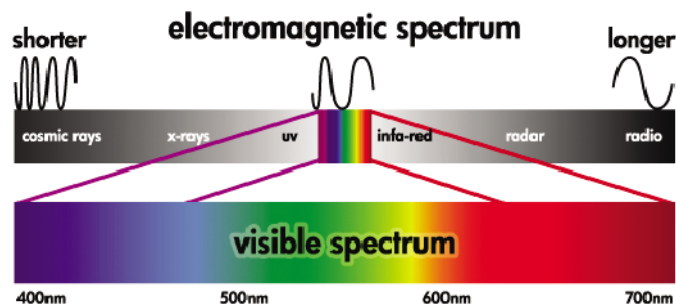

The problem: color in the computer world

Color imaging devices such as printers, displays, projectors and televisions create colors by different means and by using different materials (colorants). Displays, for instance, use colorants that emit red (long wavelength), green (medium wavelength) and blue (short wavelength) light, where outputting a white color requires the full use of all three colorants and black requires that none of them be used (i.e. that no light be emitted). Devices that use light emitting colorants are called additive, because the light from them is added together before it enters a viewer's eyes. Printers, on the other hand, use materials that absorb parts of the light that shines on them and because of this absorption, they are called subtractive. Typical prints use cyan (red absorbing), magenta (green absorbing) and yellow (blue absorbing) inks as well as an additional black ink that absorbs light at all wavelengths. To get white using a printer requires not absorbing any of the light that illuminates a piece of paper and to get black, all of the inks need to be used to absorb all of the light that is present.

To control the output of color imaging devices, the following color spaces are normally used:

- **RGB (Red, Green and Blue)** is the color space typically used for additive devices. A color is represented as a combination of specific quantities of red, green and blue colorants and all such combinations address the range of colors (color gamut) of the chosen device.

 **NOTE:** Subtractive devices can also be controlled using RGB data and, especially when you do not require control over how you want to use your printer's black ink, this is an efficient option.

- **CMYK (Cyan, Magenta, Yellow and Black)** is the color space for subtractive devices, such as printers or presses. A color is represented as a combination of cyan, magenta, yellow and black (K) inks and all such combinations let you address the entire range of colors of the chosen device.

Both of these color spaces are only ways of controlling different color imaging devices and their values do not describe colors directly. The same CMYK values, for example, will give different colors when sent to different printers that use different inks and paper types. For example, consider a printer that can use indoor inks or outdoor inks. The printer (hardware) is the same, but it has two different color gamuts due to the different chemistry of the inks (dye-based versus pigmented). Furthermore, they need to work with different paper types, as ink interaction with the paper depends on its chemistry. Thus, the colors resulting from given CMYK values depend on the types of inks and papers that you use with a printer. If this is the case using the same printer, you can easily imagine how different results can be obtained with printers using different technologies and therefore using different ink chemistry.

The same happens with RGB-controlled devices. For example, imagine that two different monitors from the same manufacturer have their white points at 9600 K and 6500 K respectively. Their colors are going to be different because they will be related to a different white point reference. The situation is even worse when comparing monitors from different manufacturers. As a recommendation, set the white point of your monitor to 5000 K (also called D50), since this is the standard color temperature for the graphic arts industries. If you dislike the appearance of D50 (you may find it too yellowish), the second choice is to set the display to 6500 K (D65).

 **NOTE:** The white point is the brightest neutral color that a device can reproduce or that is present in an image. The human visual system automatically adapts to the content of an image with respect to its white point.

Furthermore, an RGB image, such as an image obtained from a digital camera and edited on a monitor, needs to be first converted to CMYK for a specific printer before printing. Unfortunately different devices do not give access to the same color gamuts: there are some colors that can be shown on a display that cannot be matched in print and vice versa. The following graphic illustrates how colors visible to the human eye are greater than those reproduced by a typical display or printer using a specific paper type and also how the color gamuts accessible using these two color imaging devices do not match each other.

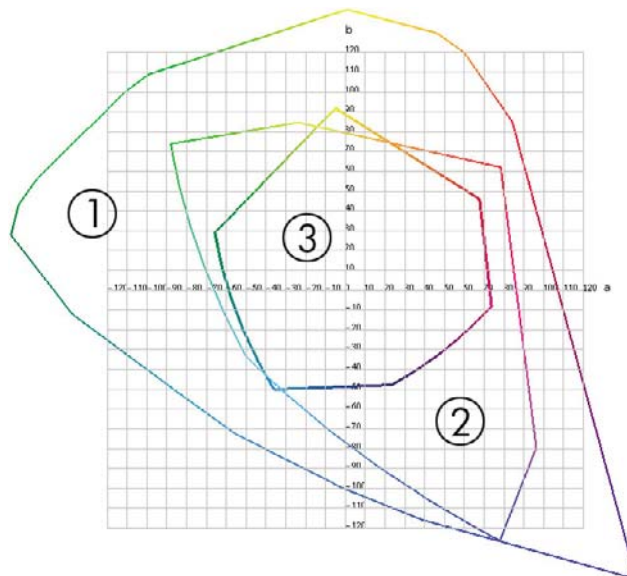

1. All colors
2. Computer monitor gamut
3. CMYK press gamut

Finally, there are some color spaces that are not device-dependent, but instead represent how a viewer sees colors, such as CIE Lab or CIECAM02 defined by the CIE (Commission Internationale de l'Éclairage). The advantage of these spaces is that, unlike CMYK or RGB, if two objects have the same CIE Lab values then they will look the same when viewed under the same conditions. Values in these spaces can be obtained from measuring the light emitted or reflected by an object.

The solution: color management

There are many colors from an RGB-controlled device that can no be reproduced in a CMYK-controlled device and vice versa. These colors are called “out-of-gamut” colors. The industry uses two steps to reduce color differences as much as possible:

- Describe the color behavior of each device as accurately as possible
- Convert one color gamut to another as effectively as possible

The solution:

1. **Describe the color behavior of a device as accurately as possible using an ICC profile.** By taking various RGB or CMYK combinations, sending them to a device, measuring the resulting output and expressing it in a device-independent color space (e.g. CIE Lab), the color behavior of a device can be described. The resulting relationship is stored in an ICC profile, which is a standard file that acts as a dictionary to translate the device's color space (CMYK or RGB) to a device-independent color space (e.g. CIE Lab). The process of generating an ICC profile is called profiling.
2. **Convert colors as effectively as possible using a Color Management System (CMS).** A CMS is software that uses information from ICC profiles to transform one device's color space (defined by a source profile) into the color space of another device (defined by a destination profile). The difficult part of the job is with those colors that exist in one device's gamut but not in the other. We will explore this in more detail later on.

Briefly, we can describe any CMS by the following 4 settings:

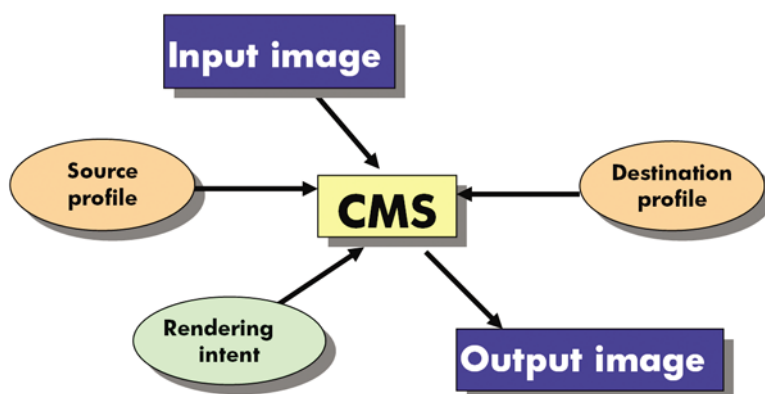

- **CMS:** CMS stands for Color Management System. It is the application that converts the color information stored in the input image, which has the color space defined by a source profile, into an output image that has the color space specified by a destination profile. There are many different CMSs on the market: there are CMSs in applications, in operating systems and in printing software provided by printer manufacturers (in our case the HP Designjet Z3200 internal RIP).
- **Source profile:** a description of the color behavior of the input device.
- **Destination profile:** a description of the color behavior of the output device.
- **Rendering intent:** the most difficult challenge in color management is when a color in the source gamut does not correspond directly to a color in the destination gamut. As a perfect match is not possible, there are different types of choices that can be made about how to treat gamut differences and these are called rendering intent. There are four different possibilities depending on the final output you want to achieve.
 - Use **Perceptual** for the most pleasing final output from your original RGB image. It is suitable for photographic content.
 - Use **Saturation** for vivid final output. It is suitable for business graphics (charts, presentations, etc.), but is not recommended for color matching.
 - Use **Relative Colorimetric** for press proofing. This rendering intent provides a match for colors that are inside both the source and destination gamuts and minimizes differences when a match is not possible.
 - Use **Absolute Colorimetric** for press proofing (like Relative Colorimetric), when you also want to simulate the color of the source's paper.

💡 **TIP:** You can use "soft proofing" options in your application (such as Photoshop and InDesign) to view the result of each rendering intent.

The most commonly used device color spaces and, therefore, profiles are:

- RGB mode:
 - **sRGB (sRGB IEC61966-2.1):** for images originating typically from consumer digital cameras and scanners and in general from the Web
 - **Adobe RGB (1998):** for images originating typically from professional digital cameras
 - **Specific RGB device space:** for images coming from or going to a specific RGB device that has been profiled. The HP Designjet Z3200 has the capability to measure itself and generate

an RGB ICC profile, describing its color behavior for the paper that was loaded at the time of measuring.

- CMYK mode:
 - **SWOP:** abbreviation of “Specifications for Web Offset Publications”, a set of press standards defined for a typical US press and for different types of paper
 - **ISO 12647-2:** a set of press standards defined by the International Standards Organization for different types of paper (Coated, Uncoated, ...)
 - **Other regional standards:** Euroscale, JMPA, Japan Color
 - **Specific CMYK device space:** for images coming from or going to a specific CMYK device that has been profiled

Color and your printer

As a creative professional, predictable and dependable results from your printer are essential to getting your job done. Predictability is a key element of an efficient color workflow. You need prints that match your expectations with neutral grays and correct colors on your selected paper. Your prints should be produced consistently print-to-print and printer-to-printer. Dependability ensures that every print is free of print-quality defects and ready to use or send to your customer. You save time and effort and avoid wasting ink and paper, and you can meet demanding production schedules by printing overnight with confidence.

HP Designjet Z3200 printers have been engineered with advanced hardware and driver features to ensure predictable and dependable results, and offer dramatic improvements in efficiency and control for your color workflow.

HP Embedded Spectrophotometer

HP Designjet Z3200 printers revolutionize professional color workflows by using a built-in spectrophotometer for color calibration and profiling.

A spectrophotometer is a precision instrument that can determine the exact composition of light reflected from a color patch. It splits the reflected light into different wavelength components, just as Newton’s prism splits white light into the colors of the rainbow, and measures the strength of each component. The HP Embedded Spectrophotometer is mounted on the printhead carriage.

The spectrophotometer allows HP Designjet Z3200 printers to generate custom ICC profiles automatically for your preferred paper types and calibrate the printers to deliver print-to-print and printer-to-printer repeatability with less than half the color error of earlier HP Designjets, under all environmental conditions, and even on unknown (not factory-profiled) paper types. A built-in white calibration tile, protected by an automatic shutter, ensures reliable measurements that meet international standards.

The printer, color imaging pipeline and professional-quality spectrophotometer with GretagMacbeth i1 color technology are integrated with the HP Color Center software for the HP Designjet Z3200. Giving the calibration and profiling processes direct access to the writing system allows precise control of ink levels and color separations for each printed color patch. The automated measurement process eliminates handling the test print, provides repeatable drying times and allows fast measurements with precise electromechanical positioning of the spectrophotometer over the color patch. This provides unprecedented ease of use and matches or exceeds the performance of more expensive off-line, handheld profiling systems.

A summary of the color management process

To get the accurate and consistent colors that you want, you should follow these steps for each paper type that you use.

1. If your paper type is not already known to the printer, add it to the printer's list of known papers. See [To create your own paper preset on page 36](#). Typical users may add a few custom paper types every year.
2. Color-calibrate the paper type, for consistent colors. Calibration should be repeated every now and then, when recommended by a printer alert (typically, every few weeks for each paper type you use). In addition, you may wish to calibrate immediately before a particularly important print job for which color consistency is vital.
3. Color-profile the paper type, for accurate colors. Profiling does not normally need to be repeated: once you have a profile for a particular paper type, you can continue to use it. However, re-profiling does no harm, and some users repeat the profiling process every month to ensure that the profile is up to date.
4. When printing, select the correct color profile for the paper type you are using.

If you use a paper type already defined in the printer, it has a color profile already, but you should at least calibrate it before using it.

If you define a new paper type, you are automatically led through the steps of calibration and profiling.

The following diagram shows the operations handled by the HP Color Center, in the correct order.

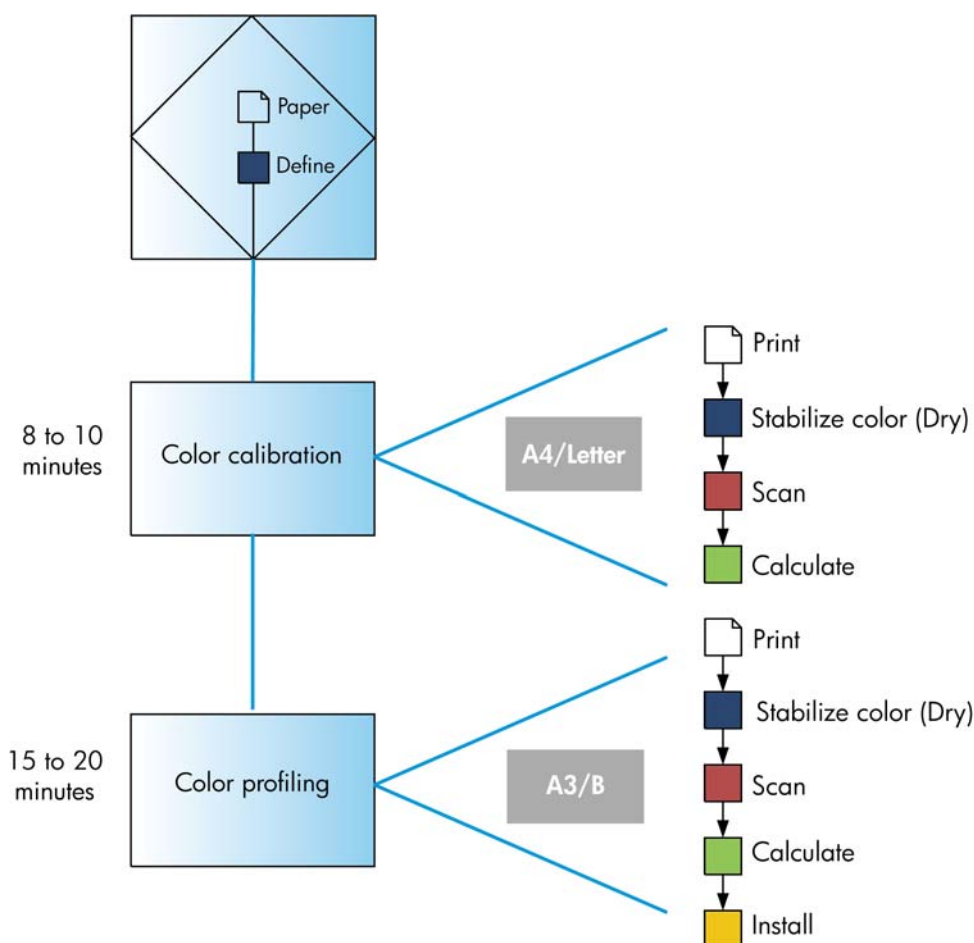

NOTE: You can perform all three operations in sequence as shown, but you can also choose to start with or stop after any of the three operations. With one exception: color calibration is performed automatically after adding a new paper type.

Color calibration

Color calibration enables your printer to produce consistent colors with the particular printheads, inks and paper type that you are using, and under your particular environmental conditions. After color calibration, you can expect to get identical prints from any two different printers situated in different geographical locations.

Calibration should be done in any of the following circumstances:

- Whenever a printhead is replaced
- Whenever a new paper type is introduced that has not yet been calibrated with the current set of printheads
- Whenever a certain amount of printing has been done since the last calibration
- Whenever the printer has been turned off for a long period of time
- Whenever the environmental conditions (temperature and humidity) change significantly

The printer driver usually reminds you with an alert whenever you need to perform color calibration, unless you have disabled the alerts. However, there will be no alert if the environmental conditions change.

You should calibrate a paper type before creating its color profile; however, you can later recalibrate without needing to recreate the color profile.

You can turn off color calibration from the front panel: select the Image Quality Maintenance menu icon



, then set **Enable color calibration** to **OFF**. In this case, the printer will use a default calibration set in the factory for all paper types. If you later turn color calibration back on, it will still remember any calibrations that you performed earlier.

Check calibration status

You can check the color calibration status of the currently loaded paper at any time by pressing the **View loaded paper** key on the front panel. The status may be one of the following:

- **PENDING:** the paper has not been calibrated.



NOTE: Whenever you update the printer's firmware, the color calibration status of all papers is reset to **PENDING**. See [Update the firmware on page 98](#).

- **OBSOLETE:** the paper has been calibrated, but the calibration is now out of date for one of the reasons mentioned above, and should be repeated.
- **OK:** the paper has been calibrated, and the calibration is up to date.
- **N/A:** this paper cannot be calibrated. The following paper types cannot be calibrated: plain paper, transparent materials, and textured glossy paper (such as HP Collector Satin Canvas). They can, however, be profiled.

Calibrate

You can start color calibration in the following ways:

- From the printer driver alert that recommends calibration.
- From the HP Color Center: select **Paper Preset Management > Calibrate Paper**.
- From the front panel: select the Image Quality Maintenance menu icon , then **Calibrate color**.

The calibration process is fully automatic and can be performed unattended after you have loaded paper of the type you wish to calibrate—which should be A4, Letter or any larger size.

The process takes about 8–10 minutes and consists of the following steps.

1. A calibration test chart is printed, which contains patches of each ink used in your printer.



2. The chart is allowed to dry for a period of time that depends on the paper type, so that the colors have time to stabilize.
3. The chart is scanned and measured using the HP Embedded Spectrophotometer.
4. From the measurements made by the spectrophotometer, the printer calculates the necessary correction factors to apply for consistent color printing on that paper type. It also calculates the maximum amount of each ink that can be applied to the paper.

TIP: If color calibration fails, check whether a color is missing from the chart. A missing color may be caused by a printhead problem: see [Troubleshooting ink cartridge and printhead issues on page 137](#).

NOTE: Matte black is not used on glossy or satin papers, so that column of the chart is not printed when calibrating those paper types.

Calibration from Photoshop

When you use Adobe Photoshop CS3 (or later version) for Windows, the Print window can warn you if the paper needs color calibration, and can provide an icon  to launch the HP Printer Utility to perform the calibration.

To enable this capability under Windows XP, you must download and install the following free software packages from Microsoft's Web site:

- Microsoft Core XML Services (MSXML) 6.0
- Microsoft XML Paper Specification Essentials Pack 1.0

Color profiling

Color calibration provides consistent colors, but consistent colors are not necessarily accurate. For instance, if your printer prints all colors as black, its colors may be consistent but they are not accurate.

In order to print accurate colors, it is necessary to convert the color values in your files to the color values that will produce the correct colors from your printer, your inks and your paper. An ICC color profile is a description of a printer, ink and paper combination that contains all the information needed for these color conversions.

When you have defined and calibrated a new paper type, the printer is ready to create a ICC profile for use with your paper, which will allow you to print on it with the best possible color accuracy. Alternatively, if your paper type is already known to the printer, you already have an appropriate ICC profile for use with it.

Create your own profile

You can create a color profile easily by using the HP Color Center: select **Paper Preset Management > Profile Paper**. The printer helps you by prompting for information about the paper, then creates and installs the new profile automatically.

The process takes about 15–20 minutes and consists of the following steps.

1. A profiling chart is printed, which contains patches of each ink used in your printer. Unlike a calibration chart, most of the patches contain combinations of more than one ink.

The printer chooses automatically between two profile charts:

- An A3 or B format for cut sheets



- A roll-paper format that minimizes paper use by printing across the full width of the roll



2. The chart is allowed to dry for a period of time that depends on the paper type, so that the colors have time to stabilize.

 **NOTE:** If you would like to use a longer drying time, you can ask the HP Color Center to create the chart without going on to create a profile (Windows: **Print target only**; Mac OS: **Print ICC profiling chart**). Then, later, when the chart is completely dry, you can restart the HP Color Center and ask it to create a profile using the chart you have already created (Windows: **Create ICC profile from a target that has already been printed**; Mac OS: **Scan ICC profiling chart and create ICC profile**). In this case the spectrophotometer takes a while to warm up before it is ready to scan.

3. The chart is scanned and measured using the HP Embedded Spectrophotometer.

 **NOTE:** Chart measurement may not be successful if you load the chart as a single sheet without skew check.

4. From the measurements made by the spectrophotometer, the printer calculates the ICC profile for your printer, inks and paper type.
5. The new ICC profile is stored in the correct system folder on your computer, where your application programs can find it.

The profile is also stored in the printer, so that other computers connected to the same printer can copy it. The HP Printer Utility will notify you if your printer has profiles that are not yet stored on your computer.

 **NOTE:** Some applications may need to be closed and restarted in order to use a profile that has just been created.

You can profile a photo paper with the gloss enhancer on or off. The two profiles will be different, so you are recommended to save them under different names.

Color measurement

You can also create a color profile by using a third-party profiling program and the Color Measurement facility. To begin Color Measurement:

- Using the HP Printer Utility for Windows, select **Color Center > Paper Preset Management > Color Measurement**.
- Using the HP Printer Utility for Mac OS, select **HP Color Center > Paper Preset Management**. Select the paper type, then press the  button and select **Color Measurement** from the popup menu.

Continue with the following steps.

1. Choose the workflow that you want to use from the following options:
 - **Print and measure a color chart** performs printing and measurement in a single process. You can choose whether to use gloss enhancer and how much drying time to allow.
 - **Print a color chart for later measurement** assumes that you will measure the printed chart at some later time to complete the process. You can choose whether to use gloss enhancer.
 - **Measure a previously printed color chart** completes the process if you have a color chart ready for measurement. Load the chart in the correct direction as indicated by the arrows, loading multiple pages in the correct order, and do not cut the paper.
 - **Export a color chart as a TIFF for printing externally** allows you to use a different program (a RIP, for example) to print the color chart. Do not modify the TIFF file in any way before printing it. The printed chart should be exactly the correct size; the simplest way to achieve this is to print it on a paper size larger than the chart and then cut the paper after printing as indicated by the crop marks.
2. If printing a chart, select one of the available charts.
3. If measuring a chart, select the characteristics of the measurements file: what sort of information it should contain (CGATS and MonacoPROFILER formats are supported), and where the file should be saved.

 **NOTE:** Chart measurement may not be successful if you load the chart as a single sheet without skew check.

4. Open the measurements file with your profiling program.

 **NOTE:** The printer's spectrophotometer measures from 400 to 700 nm in steps of 20 nm. All other measurement types are interpolated.

Install a profile

If you have obtained an ICC profile through other means than using the printer's built-in profiling software, for instance from the Internet or from a third-party profiling software package, you can still install it for use with your printer and paper.

1. Go to the HP Color Center in the HP Printer Utility. Select **Paper Preset Management > Install Profile**.
2. Select the paper type that you will use with the ICC profile, and select the file containing the ICC profile.

 **NOTE:** ICC profile file names have the extensions ".icc" (for International Color Consortium) or ".icm" (for Image Color Matching).

3. Check the ICC profile name and settings that will be installed. Click **Next**.
4. The ICC profile is installed in your computer and will be available to use in your applications.

Export a profile

An ICC profile associated with a paper type can be exported, enabling it to be used on a different printer or with a different paper preset.

1. Go to the HP Color Center in the HP Printer Utility. Select **Paper Preset Management > Export ICC Profile**.
2. Select the paper type and the ICC profile to be exported.
3. Choose the pathname of the folder where the ICC profile will be saved in your computer.
4. The ICC profile file is saved in the specified folder.

Restore an original profile

The ICC profile settings in a paper preset can be restored to their original values. This will remove any ICC profile that you have associated with the selected paper and restore the default ICC profile provided by HP.

1. Go to the HP Color Center in the HP Printer Utility. Select **Paper Preset Management > Restore Factory ICC Profile**.
2. Select the paper type whose ICC profile you want to restore. Click **Restore**.

Profile your monitor

You are also recommended to calibrate and profile your monitor (display device), so that the colors you see on the screen are more closely related to those you see on your prints. There are two ways to do this:

- Use the facilities provided with your operating system. From the HP Color Center, select **How To Calibrate Your Display** for further information.
- Use the HP Advanced Profiling Solution, which will give more accurate results. See [HP Advanced Profiling Solution on page 109](#).

Advanced profiling

To meet advanced color profiling needs, HP offers an optional Advanced Profiling Solution with software and monitor-calibration hardware at much lower cost than competing solutions. See [HP Advanced Profiling Solution on page 109](#).

Color management options

The aim of color management is to reproduce colors as accurately as possible on all devices: so that, when you print an image, you see very similar colors as when you view the same image on your monitor.

There are two basic approaches to color management for your printer:

- **Application-Managed Colors:** in this case your application program must convert the colors of your image to the color space of your printer and paper type, using the ICC profile embedded in the image and the ICC profile of your printer and paper type.
- **Printer-Managed Colors:** in this case your application program sends your image to the printer without any color conversion, and the printer converts the colors to its own color space using a set of stored ICC profiles. This method is somewhat less versatile and adaptable than Application-Managed Colors, but it is a little simpler and faster, and can produce good results with standard HP paper types.

There are only two color spaces that the printer can convert to its own color space using the stored profiles: Adobe RGB and sRGB if you are using Windows, Adobe RGB if you are using Mac OS. In addition, you can use ColorSync.

ColorSync is the Mac OS built-in Color Management System; so, when you select ColorSync, color management is performed by Mac OS, and it is done based on the ICC profiles of the specified paper type. ColorSync is available with the PCL3 driver only.

ColorSync can be selected under Mac OS X 10.4 from the **Paper Type/Quality** panel: select the **Color** tab, then select **Use Embedded (ICC/ColorSync)** from the **Source Profile** drop-down list. Under Mac OS X 10.5, ColorSync can be selected from the **Color Matching** panel.

You are recommended to consult the Knowledge Center at <http://www.hp.com/go/z3200/knowledgecenter/> to see how to use the color management options of your particular application.

To choose between **Application-Managed Colors** and **Printer-Managed Colors**:

- **In the Windows driver dialog:** select the **Color** tab.
- **In the Mac OS Print dialog:** select the **Paper Type/Quality** panel, then **Color**.
- **In some applications:** you can make this choice in the application.

Color management example with Photoshop

In this example, you have an Adobe RGB image that you want to print from Photoshop. There are three ways of doing it.

- Select **Let Photoshop determine colors** in Photoshop. Select **Application-Managed Colors** in the printer driver. Color management is done in Photoshop. This is the recommended way.
- Select **Let printer determine colors** in Photoshop. Select **Printer-Managed Colors** and the sRGB profile in the printer driver. Photoshop converts the image from Adobe RGB to sRGB and sends it to the printer. Color management is done in the printer. Unfortunately, conversion to sRGB results in a loss of gamut, but Photoshop cannot be prevented from converting to sRGB when **Let printer determine colors** is selected.
- Select **No color management** in Photoshop. Select **Printer-Managed Colors** and the AdobeRGB profile in the printer driver. Photoshop does not perform any conversion, there is no loss of gamut, and color management is done in the printer. However, this method will not work if you are using synchronized color management in Photoshop (see below).

Synchronized color management with Photoshop

If you are using Adobe Photoshop CS2 for Mac OS, or Adobe Photoshop CS3 for Windows, or later versions, the color management options can be automatically synchronized between Photoshop and the driver.

- If you select **Let Photoshop determine colors** or **No color management** in Photoshop, **Application-Managed Colors** is automatically selected in the driver.
- If you select **Let printer determine colors** in Photoshop, **Printer-Managed Colors** is automatically selected in the driver.

To enable this Photoshop synchronization under Windows XP, you must download and install the following free software packages from Microsoft's Web site:

- Microsoft Core XML Services (MSXML) 6.0
- Microsoft XML Paper Specification Essentials Pack 1.0

Color adjustment options

The aim of color management is to print accurate colors. If you perform color management correctly, then you should be able to print accurate colors with no need of any manual color adjustments.

However, manual adjustments may be useful in the following situations:

- If your color management is not working correctly for some reason
- If you want colors that are subjectively pleasing rather than accurate

The printer driver provides different adjustment facilities depending on whether you are printing in color or in grayscale.

Printing in color

You can adjust the colors of your print in similar ways under Windows and Mac OS:

- **In the Windows driver dialog:** select the **Color** tab, ensure that the **Advanced color adjustments** box is checked, then press the **Settings** button beside it.
- **In the Mac OS Print dialog:** select the **Paper Type/Quality** panel, then **Lightness and Hue**.

Under either operating system, you will then be able to make adjustments using a lightness slider and three color sliders.

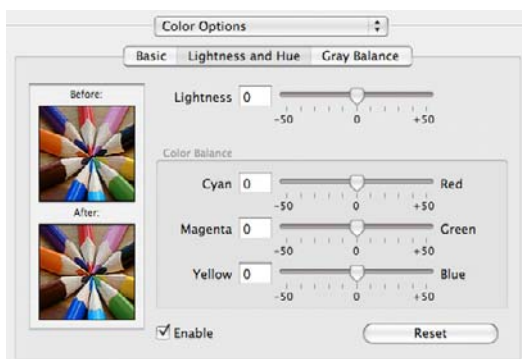

- The lightness slider simply makes the whole print lighter or darker.
- The color sliders can be used to fade or emphasize each of the primary colors in the print. The primary colors may be red, green and blue; or cyan, magenta and yellow; depending on the color model used in the image.

The **Reset** button restores each slider to its default central position.

Printing in grayscale

You can adjust the gray balance of your print in similar ways under Windows and Mac OS:

- **In the Windows driver dialog:** select the **Color** tab, ensure that the **Advanced color adjustments** box is checked, then press the **Settings** button beside it.
- **In the Mac OS Print dialog:** select the **Paper Type/Quality** panel, then **Gray balance**.

Under either operating system, you will then be able to make adjustments using separate controls for highlights, midtones and shadows.

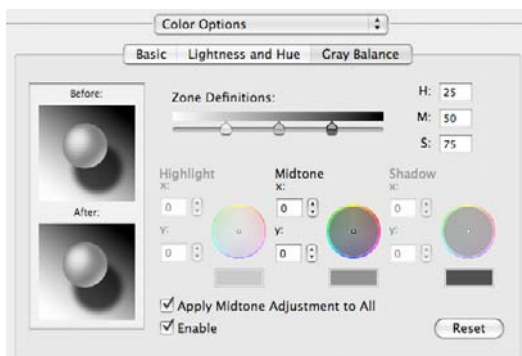

- The lightness slider simply makes the whole print lighter or darker. This slider is available under Windows in the same window as the other grayscale controls; it is available under Mac OS by selecting **Lightness and Hue**.
- The zone definition sliders can be used to define what you mean by highlight, midtone and shadow.
- The other controls for highlight, midtone and shadow can be used to adjust the gray balance of highlights, midtones and shadows respectively.

The **Reset** button restores each control to its default setting.

Color management scenarios

The following step-by-step instructions for specific printing jobs using specific software are similar to those you can find in HP's Knowledge Center on the Web. You are recommended to consult the

Knowledge Center at <http://www.hp.com/go/z3200/knowledgecenter/> for further examples and for the most up-to-date information.

Print a color photo for an exhibition (Photoshop, Mac OS)

This example uses Adobe Photoshop CS2 under Mac OS X and the color management is done by Photoshop.

1. Initial recommendations:
 - Choose an appropriate paper type for the purpose.
 - The paper type should be calibrated and profiled with the printer and the print-quality level that you intend to use. See [Color calibration on page 60](#) and [Color profiling on page 61](#).
 - For a correct preview of the printed image, the monitor should also be profiled.
2. Open Adobe Photoshop CS2.
3. From the **Edit** menu, select **Color Settings**.
 - Make sure that **More Options** are displayed.
 - **Color Management Policies**: select **Preserve Embedded Profiles**.
 - **Profile Mismatches**: check **Ask When Opening** and **Ask When Pasting**.
 - **Missing Profiles**: check **Ask When Opening**.
 - **Conversion Options** > **Intent**: select **Perceptual**.

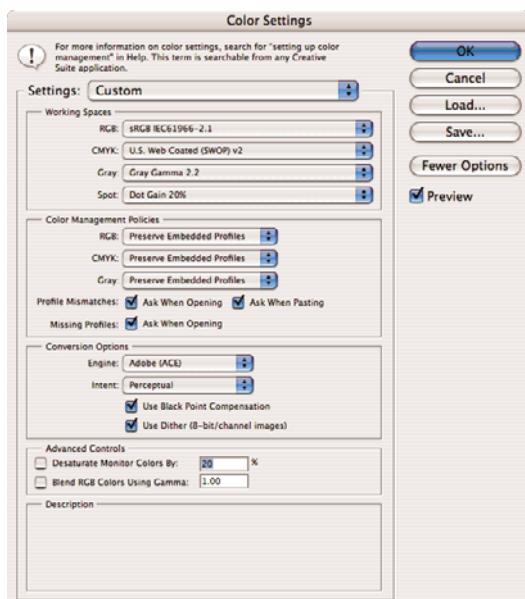

- Click **OK**.

4. From the **File** menu, select **Open** to open the image.
 - If the document has an embedded color profile that does not match the current working space, select **Use the embedded profile**. Otherwise, select **Assign working space**; in this case, if the displayed image does not look correct, try assigning it to other color spaces with **Edit > Assign Profile** (try **sRGB**, **Adobe RGB**, **ColorMatch RGB** and others) until you are satisfied.

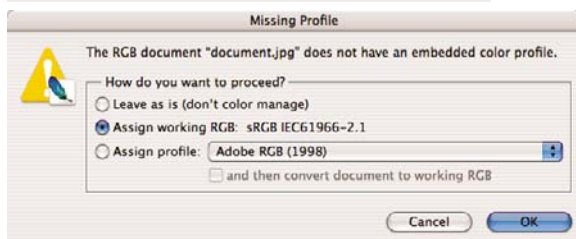
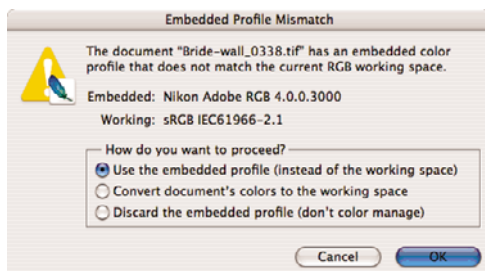

- Click **OK**.
5. From the **File** menu, select **Print with Preview**.
 - Select **Page Setup**.
 - **Format for**: select the printer (for example, **HP Designjet Z3200 Photo 24in**).
 - **Paper Size**: select the size of the paper that is currently loaded into the printer.
 - **Orientation**: select the orientation of your image on the paper.
 - Click **OK**.
 - Set the **Position** and the **Scaled Print Size** you need.
 - Make sure that **More Options** are displayed.
 - Select the **Color Management** tab.
 - **Print**: select **Document**.
 - **Options > Color Handling**: select **Let Photoshop Determine Colors**.
 - **Options > Printer Profile**: select the right profile for your printer and paper type.

- Options > Rendering Intent: select **Perceptual**.

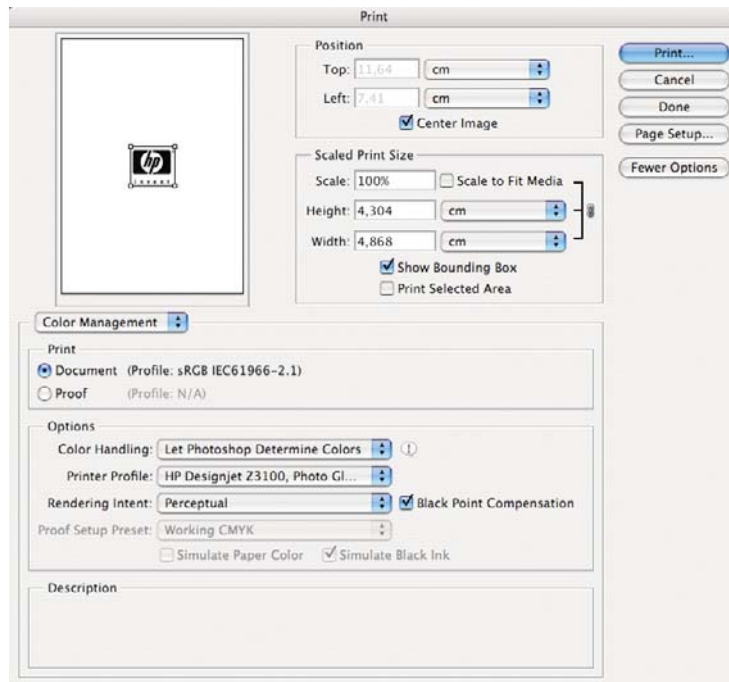

- Click **Print**.
6. Choose driver settings.
- Printer:** select the printer (for example, **HP Designjet Z3200 Photo 24in**).
 - Select **Paper Type/Quality** from the drop-down menu, then select the **Paper** tab.
 - Paper Type:** select the paper type that is currently loaded into the printer.
 - Quality Options:** select **Standard** and drag the slider to **Quality**.

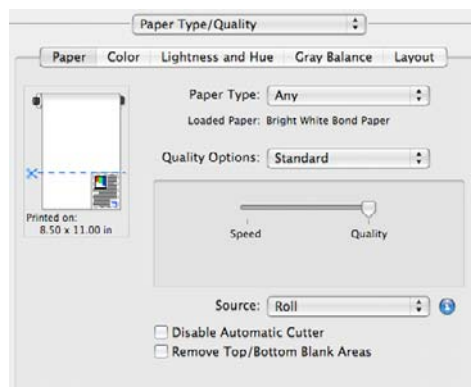

- Click **Print**.

Print a black-and-white photo for an exhibition (Photoshop, Mac OS)

This example uses Adobe Photoshop CS2 under Mac OS X and the color management is done by the printer.

-  **NOTE:** Application-managed colors could be used in this example, exactly as in the previous example. However, printer-managed colors will be used this time, in order to illustrate both methods of color management.

The recommended approach to creating a black-and-white image is to take a color image and convert it to grayscale in an image editing program such as Photoshop. In this scenario, however, this conversion will take place in the printer. If you want to convert a color image to black-and-white in Photoshop CS2, you have to go through the optional step 5.

1. Initial recommendations:
 - Choose an appropriate paper type for the purpose.
 - The paper type should be calibrated with the printer and the print-quality level that you intend to use. See [Color calibration on page 60](#).
 - For a correct preview of the printed image, the monitor should also be profiled.
2. Open Adobe Photoshop CS2.
3. From the **Edit** menu, select **Color Settings**.
 - Make sure that **More Options** are displayed.
 - **Color Management Policies**: select **Preserve Embedded Profiles**.
 - **Profile Mismatches**: check **Ask When Opening** and **Ask When Pasting**.
 - **Missing Profiles**: check **Ask When Opening**.
 - **Conversion Options > Intent**: select **Perceptual**.

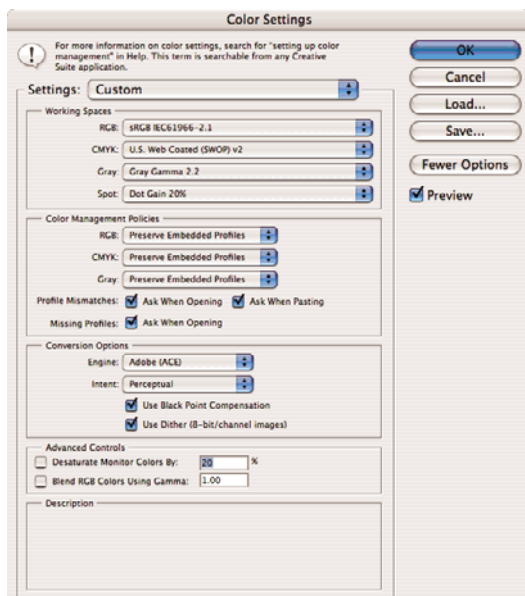

- Click **OK**.

4. From the **File** menu, select **Open** to open the image.
 - If the document has an embedded color profile that does not match the current working space, select **Use the embedded profile**. Otherwise, select **Assign working space**; in this case, if the displayed image does not look correct, try assigning it to other color spaces with **Edit > Assign Profile** (try **sRGB**, **Adobe RGB**, **ColorMatch RGB** and others) until you are satisfied.

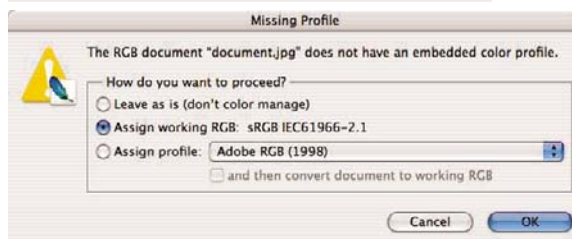
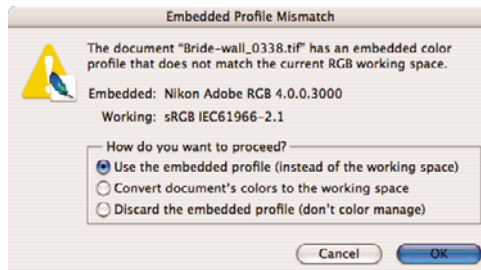

- Click **OK**.
5. (Optional) Use Photoshop to convert the image to grayscale. The simple way is to go to the **Image** menu and select **Mode > Grayscale**.

Alternatively, you can go to the **Image** menu and select **Adjustments > Channel Mixer**, to choose the percentage contribution of each color channel to the grayscale image, as follows:

- a. Check **Monochrome**.
- b. Drag any source channel's slider to the left to decrease the channel's contribution to the output channel or to the right to increase it, or enter a value between -200% and +200% in the text box (for example: 30% Red, 59% Green, 11% Blue). Using a negative value inverts the source channel before adding it to the output channel.
- c. Drag the slider or enter a value for the **Constant** option. This option adds a black or white channel of varying opacity: negative values act as a black channel, positive values act as a white channel.

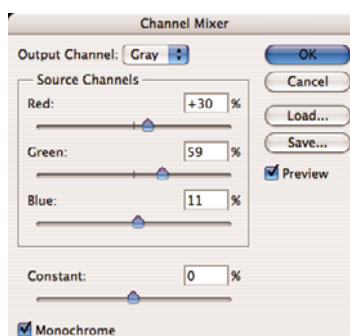

- d. Click **OK**.

6. From the **File** menu, select **Print with Preview**.
 - Select **Page Setup**.
 - **Format for:** select the printer (for example, **HP Designjet Z3200 Photo 24in**).
 - **Paper Size:** select the size of the paper that is currently loaded into the printer.
 - **Orientation:** select the orientation of your image on the paper.
 - Click **OK**.
 - Set the **Position** and the **Scaled Print Size** you need.
 - Make sure that **More Options** are displayed.
 - Select the **Color Management** tab.
 - **Print:** select **Document**.
 - **Options > Color Handling:** select **Let Printer Determine Colors**.
 - **Options > Rendering Intent:** select **Perceptual**.

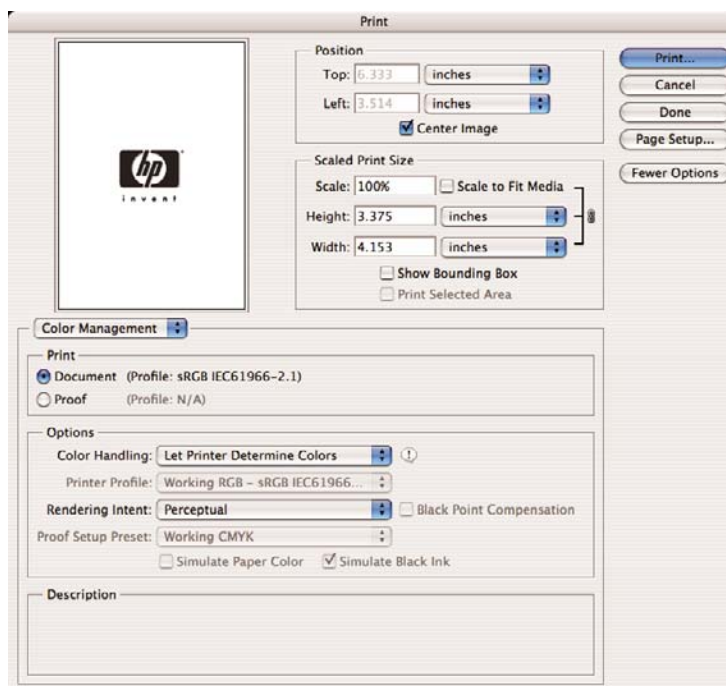

- Click **Print**.
7. Choose driver settings.
 - **Printer:** select the printer (for example, **HP Designjet Z3200 Photo 24in**).
 - Select **Paper Type/Quality** from the drop-down menu, then select the **Paper** tab.
 - **Paper Type:** select the paper type that is currently loaded into the printer.

- **Quality Options:** select **Standard** and drag the slider to **Quality**.

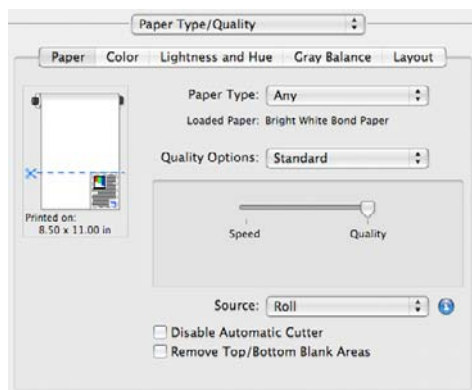

- Select the **Color** tab.
 - Select **Print in Grayscale**.
- 💡 **TIP:** If you experience bronzing with these options, see [Bronzing on page 127](#).
- Under Color Management, select **Printer Managed Colors**, and then select **Use Adobe RGB (1998)** from the source profile list.

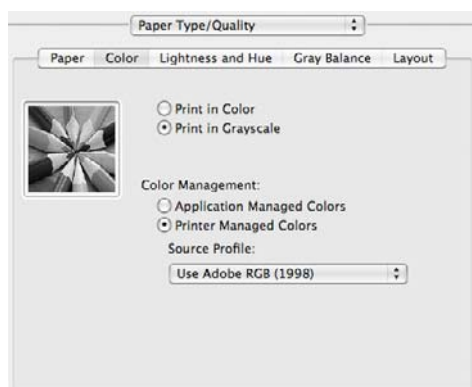

- Click **Print**.

Print a digital album (Aperture, Mac OS)

This example uses Apple Aperture under Mac OS X and the color management is done by Aperture.

1. Initial recommendations:
 - Choose an appropriate paper type for the purpose.
 - The paper type should be calibrated and profiled with the printer and the print-quality level that you intend to use. See [Color calibration on page 60](#) and [Color profiling on page 61](#).
 - For a correct preview of the printed image, the monitor should also be profiled.
2. Open Apple Aperture.
3. If you haven't already created a project for this album, go to the **File** menu and select **New Project**, then name the project. Select the new project in the projects menu (on the left), then go to the **File** menu and select **Import > Folders into a Project**.

4. Select the images you want to use, then go to the **File** menu and select **New From Selection > Book**.
 - **Theme list:** select a theme in the list to see a preview of its design on the right.
 - **Book Size** popup menu: select the physical size of the book.



- Click **Choose Theme**, and rename the book album.
5. If you like, change the page layout and customize it. You can add photo and text boxes, modify the box positions and the text styles.
 6. You can let Aperture place your images into the book automatically (select **Autoflow Unplaced Images** from the **Book Actions** menu ) , or you can place them manually by drag and drop. Furthermore:
 - You can scale, crop and pan the image.
 - You can set an image as page background and apply wash.



7. Print your book, using the **Print** button in the Book Layout Editor.
 - **Presets Name** list: select your book preset.
 - Select **Copies** and **Pages** to print.
 - **Paper Size:** select the paper size on which you want to print the job.

- **Orientation:** select the orientation of your image on the paper.
- **ColorSync Profile:** select the correct color profile for the printer and paper that you will use.
- Select **Black Point Compensation**.
- **Gamma:** Because computer displays are illuminated, images displayed on computers tend to look more luminous than when printed. Increasing the Gamma from the default of 1.0 can compensate for this. Usually, a setting 1.1 to 1.2 is adequate.

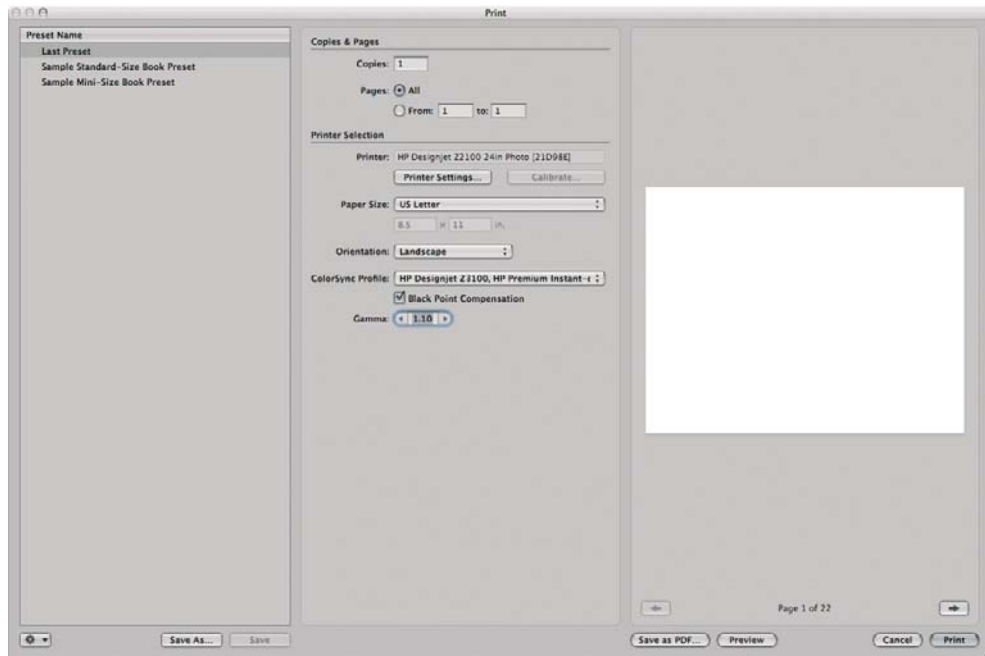

8. Click the **Printer Settings** button.

- **Printer:** select the printer (for example, **HP Designjet Z3200 Photo 24in**).
- Select **Paper Type/Quality** from the drop-down menu, then select the **Paper** tab.
 - **Paper Type:** select the paper type that is currently loaded into the printer.
 - **Quality Options:** select **Standard** and drag the slider to **Quality**.

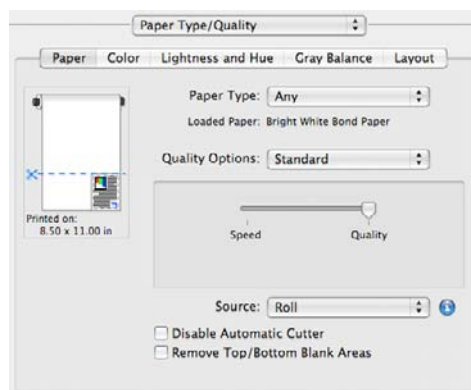

- Select the **Color** tab.
 - Select **Print in Color**.

- Under Color Management, select **Application Managed Colors**.

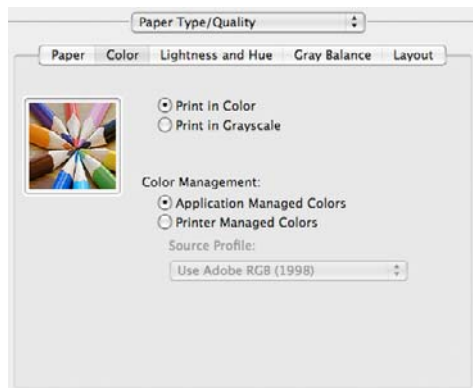

- Click **Print**.

7 Retrieving printer usage information

- [Get printer accounting information](#)
- [Check printer usage statistics](#)
- [Check ink and paper usage for a job](#)
- [Cost accounting](#)
- [Request accounting data by E-mail](#)

Get printer accounting information

There are various different ways of getting accounting information from your printer.

- View printer usage statistics for the whole lifetime of the printer, see [Check printer usage statistics on page 79](#).
- View ink and paper usage for each of your recent jobs by using the HP Printer Utility or the front panel, see [Check ink and paper usage for a job on page 79](#). If the HP Printer Utility is not available, see [Access the HP Printer Utility on page 19](#).
- Use a third-party application to request printer status, printer usage or job accounting data from the printer through the Internet. The printer provides data in XML to the application whenever requested. HP provides a Software Development Kit to facilitate the development of such applications.

Check printer usage statistics

There are two ways to check your printer's usage statistics.

 **NOTE:** The accuracy of the usage statistics is not guaranteed.

Printer statistics with the HP Printer Utility

1. Start the HP Printer Utility, see [Access the HP Printer Utility on page 19](#).
2. Go to the **Usage** window to view the total printer usage.
 - Under Windows, go to the **Overview** tab and click **Printer usage**.
 - Under Mac OS, select **Information** > **Printer Usage** and click the **Start** button.

Printer statistics with the Embedded Web Server

1. Access the Embedded Web Server, see [Access the Embedded Web Server on page 19](#).
2. Go to the **Main** tab and select **Usage**

Check ink and paper usage for a job

There are two ways to check ink and paper usage for a job.

 **NOTE:** The accuracy of the usage statistics is not guaranteed.

Ink and paper statistics with the HP Printer Utility

1. Start the HP Printer Utility, see [Access the HP Printer Utility on page 19](#).
2. Go to the **Accounting** window to view information regarding the most recent jobs.
 - Under Windows, go to the **Job Accounting** tab.
 - Under Mac OS, select **Information** > **Job Accounting** and click the **Look Up** button.

Printer statistics with the Embedded Web Server

1. Access the Embedded Web Server, see [Access the Embedded Web Server on page 19](#).
2. Go to the **Main** tab and select **Accounting**.

Cost accounting

The usage statistics tell you the quantities of supplies that have been used. If you would like to assign a cost per unit to each item, your statistical report can include costs as well as quantities.

1. Access the Embedded Web Server, see [Access the Embedded Web Server on page 19](#).
2. Go to the **Main** tab.
3. Select **Accounting > Cost assignments**.

Request accounting data by E-mail

1. In the Embedded Web Server's **Setup** tab, select **E-mail server**. Enter the address of the SMTP server that will be used to send e-mail messages, and e-mail address of the printer. The latter is a fake address that is required only so that the receiver of the messages can recognize where they are coming from.
2. Also in the **Setup** tab, select **Printer settings** and open the **Accounting** section. You must enter an E-mail address to which accounting files will be sent, and the frequency with which they will be sent (specified as a number of days or as a number of prints).
3. When you have completed the above steps, the printer will send accounting data by E-mail with the frequency that you specified. The data are provided in XML and can easily be interpreted by a third-party program. The data provided on each job include the job name, the account ID if any, the user name, when the job was submitted, when the job was printed, the printing time, the type of image, the number of pages, the number of copies, the paper type and size, the amount of each color of ink used, and various other attributes of the job.

You can download an Excel template from HP Designjet Online (<http://www.hp.com/go/graphic-arts/>) that will enable you to display the XML data more readably in the form of a spreadsheet.

Analysis of the accounting data will enable you to bill customers precisely and flexibly for the use of your printer. You can, for instance:

- Bill each customer for the total amount of ink and paper used by that customer over a particular period.
- Bill each customer separately per job.
- Bill each customer separately for each project, broken down by job.

8 Handling ink cartridges and printheads

- [About the ink cartridges](#)
- [Check ink cartridge status](#)
- [Remove an ink cartridge](#)
- [Insert an ink cartridge](#)
- [About the printheads](#)
- [Check printhead status](#)
- [Remove a printhead](#)
- [Insert a printhead](#)

About the ink cartridges

Ink cartridges store the ink and are connected to the printheads, which distribute the ink on the paper. You can purchase 130 ml ink cartridges for your printer, see [Accessories on page 101](#).

- △ **CAUTION:** Observe precautions when handling ink cartridges because they are ESD-sensitive devices (see the [Glossary on page 160](#)). Avoid touching pins, leads and circuitry.

Check ink cartridge status

To view the ink levels of your ink cartridges, press the **View ink level** key on the front panel.

To get more information on your ink cartridges, you can use the front panel ink menu or the HP Printer Utility.

For an explanation of the ink cartridge status messages, see [Ink cartridge status messages on page 138](#).

Ink menu procedure

1. From the front panel, select the Ink menu icon , then **Ink cartridge information**.
2. Select the cartridge on which you want information.
3. The front panel displays information about that cartridge.

HP Printer Utility procedures

- In the HP Printer Utility for Windows, go to the **Overview** tab, each cartridge's status is under **Supply Status > Cartridges**.
- In the HP Printer Utility for Mac OS, select **Printer Status** in the Information group.

Remove an ink cartridge

There are three occasions when you need to remove an ink cartridge.

- The ink level in the cartridge is very low and you want to replace it with a full cartridge for unattended printing (you can use up the remaining ink in the first cartridge at a more convenient time).
- The ink cartridge is empty or faulty, and you must replace it to continue printing.
- The ink cartridge has expired.

- 💡 **TIP:** Remove an ink cartridge only if you are ready to insert another one.

- △ **CAUTION:** Do not try to remove an ink cartridge while printing.

CAUTION: Make sure the printer wheels are locked (the brake lever is pressed down) to prevent the printer from moving.

1. From the front panel, select the Ink menu icon , then **Replace ink cartridges**.

Ink menu

- ▶ View ink levels
- ▶ **Replace ink cartridges**
- ▶ Replace printheads
- ⊕ Ink cartridge information
- ⊕ Printhead information

2. Open the ink cartridge cover completely. Gloss enhancer, gray, blue, green, magenta and yellow are in the left side, while light magenta, light cyan, photo black, light gray, matte black and red are in the right side.



3. Grip the cartridge you wish to remove.

4. Pull the cartridge straight up.

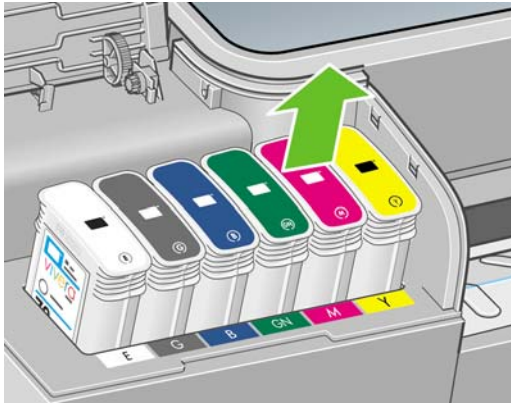

 **NOTE:** Avoid touching the end of the cartridge that is inserted into the printer, as there may be ink on the connection.

NOTE: Avoid storing partially used ink cartridges.

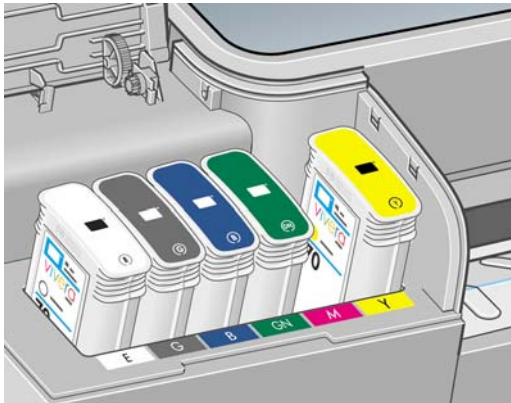

5. The front-panel display identifies the missing ink cartridge.

Insert an ink cartridge

1. Before removing the cartridge from its wrapping, shake it vigorously.
2. Unwrap the new ink cartridge, find the label identifying the ink color. Check that the letter or letters (in these illustrations, M for magenta) marking the empty slot, matches the letter or letters on the cartridge label.

3. Insert the ink cartridge into its slot.



4. Push the cartridge into the slot until it snaps into position. You should hear a beep and see confirmation that the cartridge has been inserted.

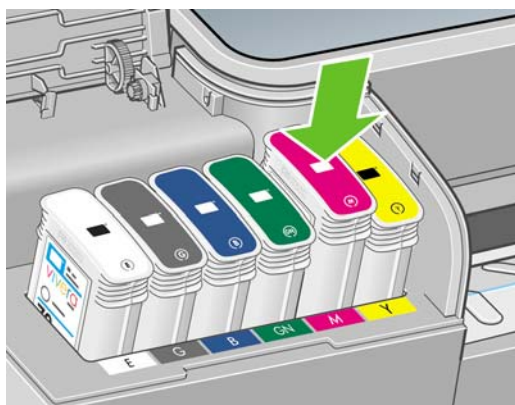

If you have difficulty, see [Cannot insert an ink cartridge on page 138](#).

5. When all cartridges have been inserted, close the cover.



6. The front-panel display confirms that all cartridges have been correctly inserted, press the **OK** key on the front panel.

About the printheads

The printhead are connected to the ink cartridges and jet ink onto the paper.

△ **CAUTION:** Observe precautions when handling printheads because they are ESD-sensitive devices (see the [Glossary on page 160](#)). Avoid touching pins, leads and circuitry.

Check printhead status

The printer automatically checks and services the printheads after each print. Follow the steps below to get more information on your printheads.

1. From the front panel, select the Ink menu icon , then **Printhead information**.
2. Select the printhead on which you want information.
3. The front panel displays information about that printhead.

You can also get most of this information without leaving your computer by using the HP Printer Utility.

For an explanation of the printhead status messages, see [Printhead status messages on page 144](#).

 **NOTE:** If the warranty status is **See warranty note**, this indicates that non-HP ink is being used. Printer service or repairs required as a result of using "non-HP" ink are not covered under warranty. See the *Legal Information* document for detailed warranty implications.

Remove a printhead

△ **CAUTION:** Make sure the printer wheels are locked (the brake lever is pressed down) to prevent the printer from moving.

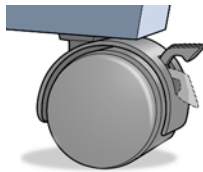

△ **CAUTION:** Printhead replacement must be performed with the printer powered on.

1. From the front panel, select the Ink menu icon , then **Replace printheads**.

Ink menu

- ▶ View ink levels
- ▶ Replace ink cartridges
- ▶ **Replace printheads**
- ⊞ Ink cartridge information
- ⊞ Printhead information

2. The printer moves the carriage into the correct position.

△ **CAUTION:** If the carriage is left in the removal position for more than three minutes without inserting or removing any printheads, it tries to move back to its normal position in the right-hand end.

3. When the carriage has stopped moving, the front-panel display asks you to open the window.

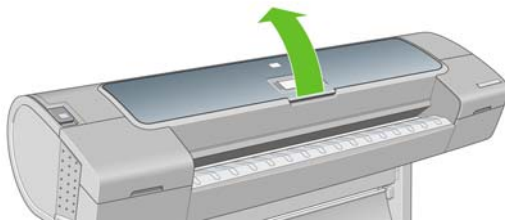

4. Locate the carriage on the right side of the printer.
5. To Pull the handle up and toward you to release the wire loop.

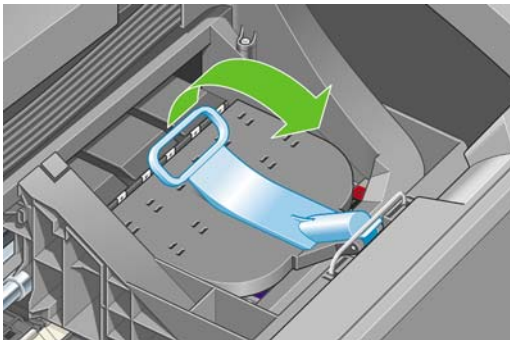

6. Push the handle back to raise the carriage lid.

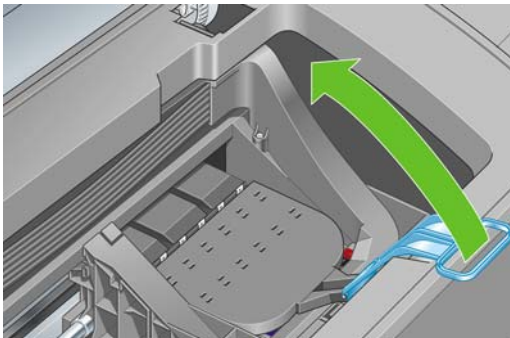

7. This gives you access to the printheads.

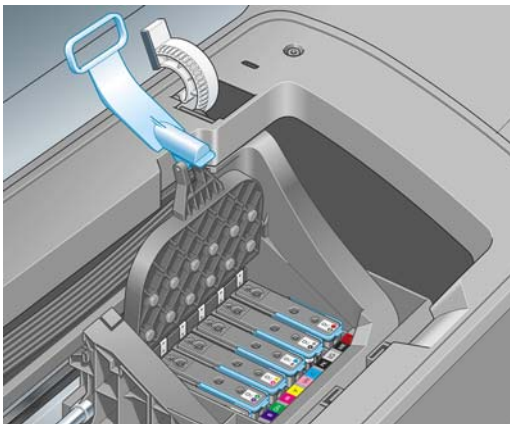

8. To remove a printhead, lift up the blue handle.

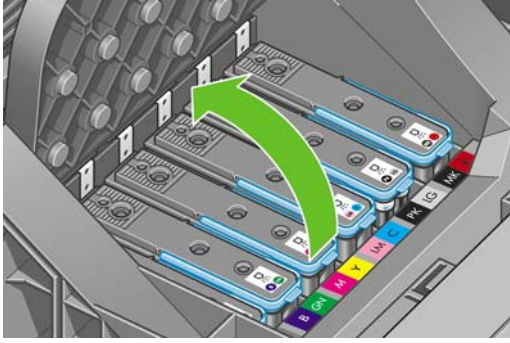

9. Using the blue handle, use steady force to disengage the printhead.

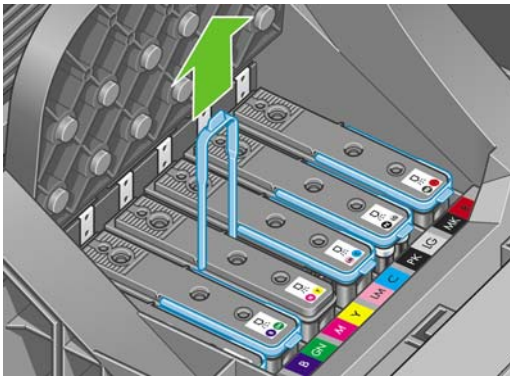

10. Pull the blue handle upward until the printhead is released from the carriage.

△ **CAUTION:** Do not pull abruptly because this can damage the printhead.

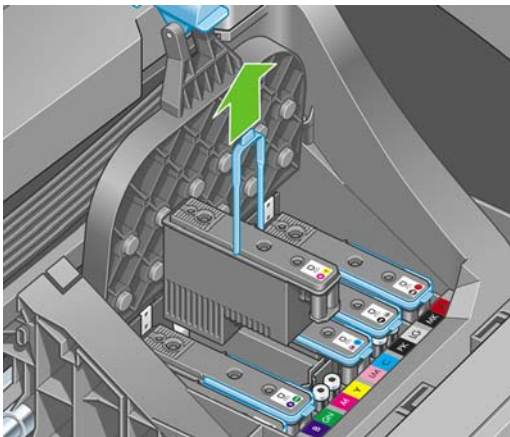

11. The front-panel display identifies the missing printhead.

Insert a printhead

1. If the printhead is new, shake the printhead vigorously before removing the protective caps.

2. Remove the orange protective caps by pulling them down.

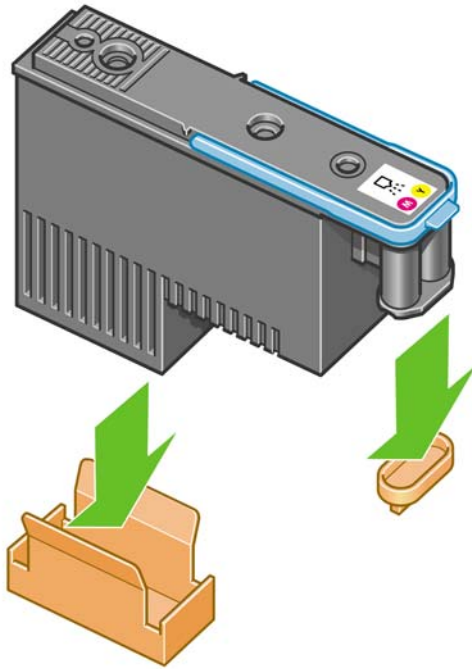

3. The printhead is designed to prevent you from accidentally inserting it into the wrong slot. Check that the colored label on the printhead matches the colored label of the carriage slot into which the printhead is to be inserted.
4. Insert the new printhead into its correct slot in the carriage.

△ **CAUTION:** Insert the printhead slowly and vertically, straight down. It may be damaged if you insert it too fast, or at an angle, or if you rotate it as you insert it.

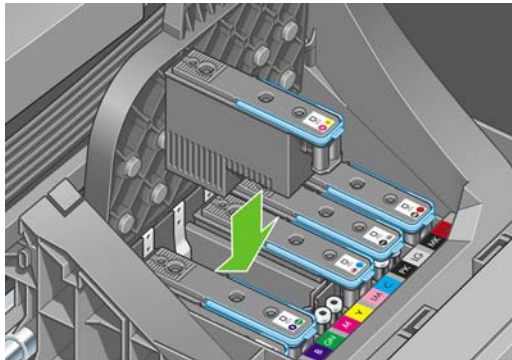

5. Push down as indicated by the arrow shown below.

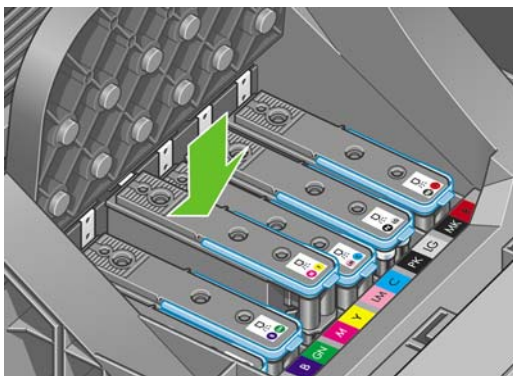

△ **CAUTION:** When installing the new printhead there may be some resistance, so you need to press it down firmly but smoothly. You should hear a beep and see confirmation on the front-panel display that the printhead has been inserted. If you have difficulty, see [Cannot insert a printhead on page 138](#).

6. Insert any other printheads, that need to be installed, with the same procedure, then close the carriage lid.

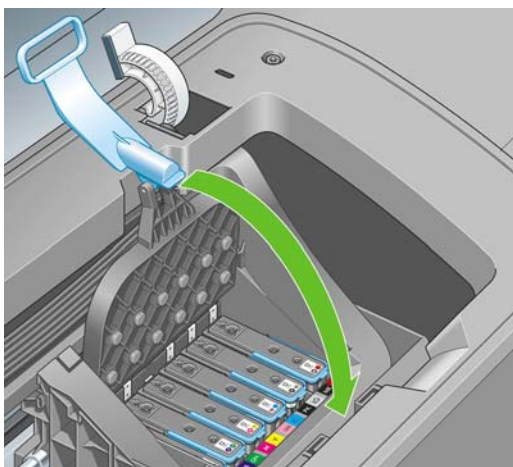

7. Ensure the end of the blue handle catches the wire loop on the near side of the carriage.

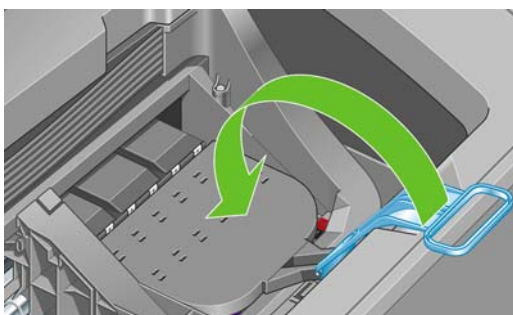

8. Lower the handle to rest on the carriage lid.

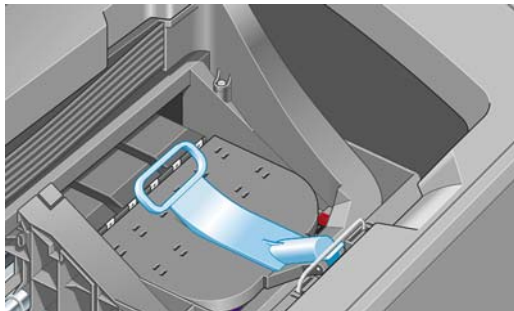

When all the printheads have been inserted correctly and are accepted by the printer, the printer beeps.

 **NOTE:** If the printer does not beep when you insert the printhead and the **Replace** message appears on the front-panel display, the printhead may need to be reinserted.

9. Close the window.

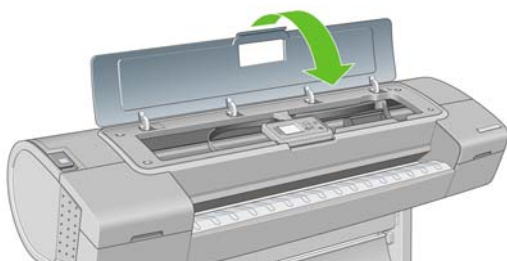



10. The front-panel display confirms that all printheads are correctly inserted. The printer starts checking and preparing the printheads. The default routine process, when all printheads are changed, takes 35 minutes. If the printer finds problems in preparing the printheads, it takes longer, up to 80 minutes. For a single printhead insertion, the times vary between 25 and 45 minutes. After all printheads are checked and prepared, the printhead realignment procedure runs automatically if paper is loaded, see [Align the printheads on page 142](#).

9 Maintaining the printer

- [Check printer status](#)
- [Clean the exterior of the printer](#)
- [Replace the cutter](#)
- [Maintain the ink cartridges](#)
- [Move or store the printer](#)
- [Update the firmware](#)
- [Update the software](#)
- [Change the battery](#)
- [Printer maintenance kits](#)
- [Secure Disk Erase](#)

Check printer status

You can check the current status of the printer in various ways:

- If you start the HP Printer Utility and select your printer, you see a page of information describing the status of the printer and its paper and ink supplies.
- If you access the Embedded Web Server, you see information about the general status of the printer. The Supplies page in the **Main** tab describes the status of the paper and ink supplies.
- The status screen of the printer's front panel notifies you of any current problems affecting the printer as a whole. You can also request information about:
 - The currently loaded paper, with the **View loaded paper** key
 - The ink levels, with the **View ink levels** key
 - The ink cartridges, by selecting the Ink menu icon  and then **Ink cartridge information**
 - The printheads, by selecting the Ink menu icon  and then **Printhead information**

Clean the exterior of the printer

Clean the outside of the printer and all other parts of the printer that you regularly touch as part of normal operation with a damp sponge or a soft cloth and a mild household cleaner such as non-abrasive liquid soap.

- ⚠ **WARNING!** To avoid an electric shock, make sure that the printer is turned off and unplugged before you clean it. Do not let water get inside the printer.
- ⚠ **CAUTION:** Do not use abrasive cleaners on the printer.

Replace the cutter

The cutter may need to be replaced once or twice during the life of the printer, depending on the total amount and thickness of paper used. The front panel advises when replacement is due. If you do not replace the cutter immediately, the printer continues working normally, but the front panel continues to remind you about the cutter.

To replace the cutter:

1. If there is paper loaded in the printer, unload it.
2. At the front panel, select the Setup menu icon , then **Advanced > Resets > Reset cutter life counter**.
3. After a brief pause, the printer turns itself off. The printhead carriage is parked on the right-hand side of the printer, and the cutter on the left-hand side.

- ⚠ **WARNING!** There is a risk of electric shock if you attempt to replace the cutter with the printer turned on.

4. Lift the ink cartridge cover on the left-hand side of the printer.



5. Press the button behind the ink cartridges to release the cover of the left-hand end of the printer.

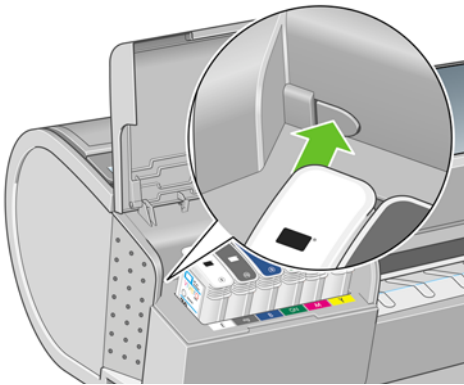

6. Remove the left end cover.

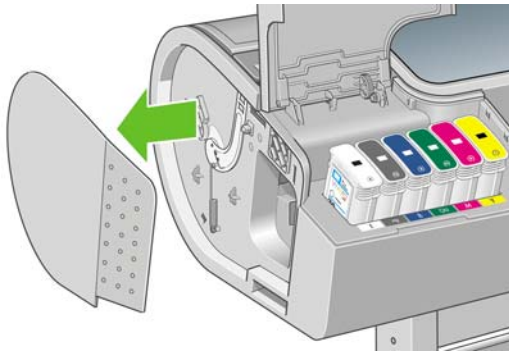

7. Unscrew and remove the cutter stop using the TORX PLUS screwdriver provided with the new cutter. The screw is captive and will not fall out.

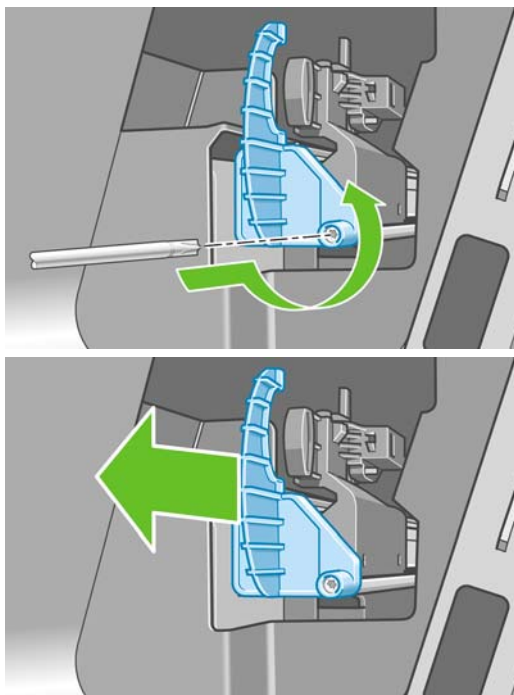

8. Remove the old cutter.

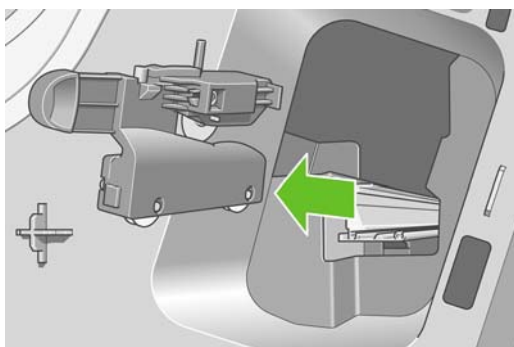

9. Take the new cutter from the maintenance kit and move the plunger at the top slowly back and forth within its housing to check that it moves freely.

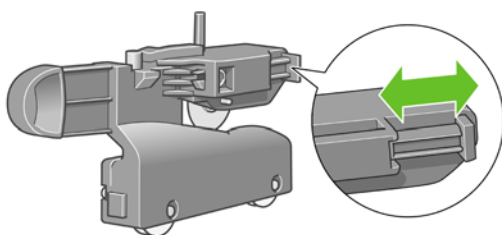

10. Slide the new cutter into position on the cutter rail.

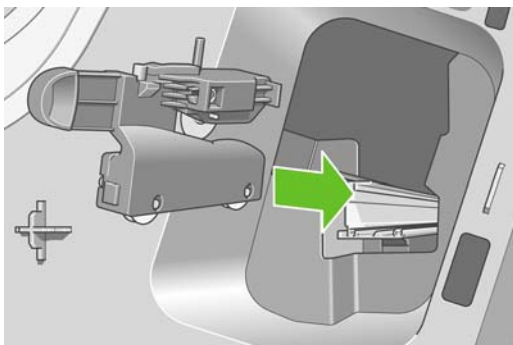

The two wheels on the bottom of the cutter should engage the central ridge on the cutter rail, and the two bushing guides should fit into the groove in the upper part of the cutter rail.

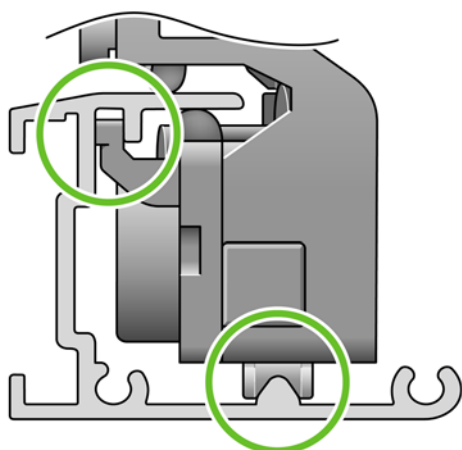

Check that the cutter runs smoothly up and down the rail. You can leave it anywhere on the rail; the printer will park it correctly later.

11. Fit the cutter stop onto the end of the cutter rail, holding it there with one hand while you tighten the screw with the screwdriver in your other hand.

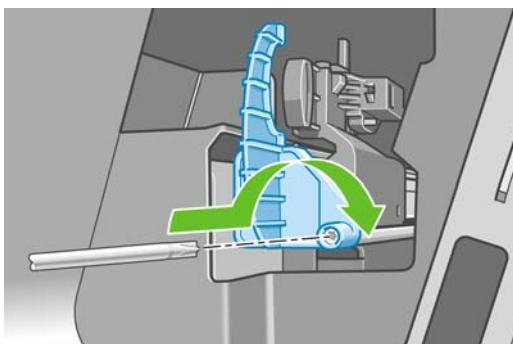
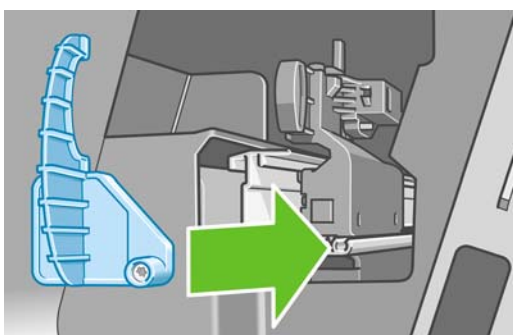

- Put the left end cover back on the printer, aligning the protrusions with the holes in the printer.

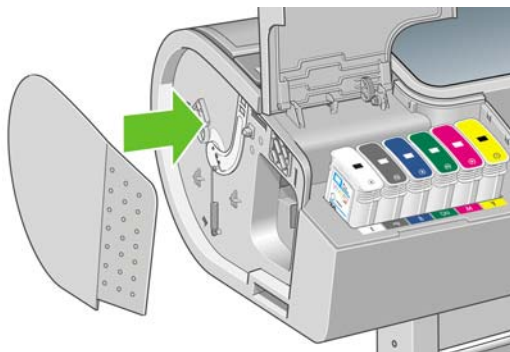

- Close the ink cartridge cover.



- At the front panel, turn the printer back on. The printer checks that the cutter has been correctly installed. Look at the front panel and follow its instructions if there is any problem.

Maintain the ink cartridges

During the normal lifetime of a cartridge, no specific maintenance is required. However, in order to maintain the best print quality, replace a cartridge when it reaches its expiration date. The printer's front panel notifies you when any cartridge reaches its expiration date.

You can also check a cartridge's expiration date at any time: see [Check printer status on page 93](#).

See also [Handling ink cartridges and printheads on page 81](#).

Move or store the printer

If you need to move or store the printer, prepare it correctly to avoid possible damage to it. To prepare the printer, follow the instructions below.

- Do not remove the ink cartridges or printheads.
- Make sure that no paper is loaded.
- Make sure that the printer is idle.
- Disconnect any cables connecting the printer to a network or a computer.

5. Before transporting the printer, secure the rear tray in the closed position with tape. Otherwise, the tray could open and perhaps break and fall out of the printer.

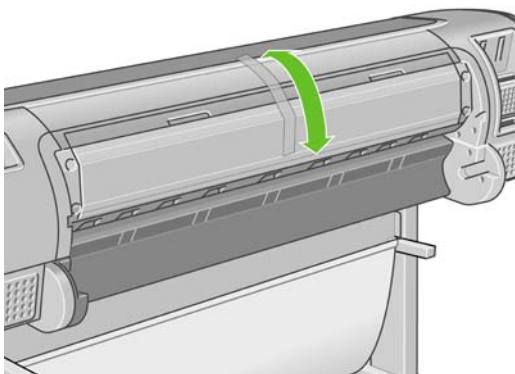

If you need to leave the printer turned off for a long time, follow the additional steps below.

1. Turn off the power using the **Power** key on the front panel.
2. Also turn off the power switch at the rear of the printer.
3. Disconnect the printer's power cable.

△ **CAUTION:** If you turn the printer upside down, ink could escape into the printer and cause serious damage.

When the printer is turned back on, it takes about three minutes to initialize itself and to check and prepare the printheads. Preparing the printheads normally takes just over a minute. However, if the printer has been off for a six weeks or more, preparing the printheads could take up to an hour.

If the printer remains off for a long period of time, the printheads may become unusable. In this case, you need to replace the printheads with new ones.

Update the firmware

The printer's various functions are controlled by software that resides in the printer, otherwise known as firmware.

From time to time firmware updates will be available from Hewlett-Packard. These updates increase the printer's functionality and enhance its features.

Firmware updates can be downloaded from the Internet and installed in your printer in the following ways; you can choose whichever you find most convenient.

- Using the HP Printer Utility for Windows, select your printer, the **Support** tab, and then **Firmware Update**.
- Using the HP Printer Utility for Mac OS, select **Firmware Update** in the Support group.
- Using your printer's Embedded Web Server, select the **Setup** tab and then **Firmware update**.

In each case, follow the instructions on your screen to download the firmware file and store it on your hard disk. Then select the downloaded file and click **Update**.

If you experience very slow progress while uploading the firmware file to the printer, the reason could be that you are using a proxy server. In that case, try bypassing the proxy server and accessing the Embedded Web Server directly.

- In Internet Explorer 6 for Windows, go to **Tools > Internet Options > Connections > LAN Settings**, and check the **Bypass proxy server for local addresses** box. Alternatively, for more precise control, click the **Advanced** button and add the printer's IP address to the list of exceptions, for which the proxy server is not used.
- In Safari for Mac OS, go to **Safari > Preferences > Advanced** and click the **Proxies: Change Settings** button. Add the printer's IP address or its domain name to the list of exceptions, for which the proxy server is not used.

The firmware includes a set of the most commonly used paper presets. Extra paper presets can be downloaded separately; see [Paper presets on page 35](#).

Update the software

You are recommended to use HP Proactive Support (see [HP Proactive Support on page 154](#)) to keep your printer driver and other printer software up to date. Alternatively, go to <http://www.hp.com/go/z3200/drivers/>.

Change the battery

When the front panel announces that the real-time clock is not working, you must change the battery. You need a lithium battery, model CR2032. To replace the battery, follow these steps.

1. Turn the printer off and unplug the cable. Unplug any network or USB cables.
2. Loosen the screws that attach the formatter to the printer with your fingers, or with the help of a flat screwdriver.
3. Locate the round, flat battery in the formatter.
4. Push the battery slightly to one side and then pull it up. A little force may be required.
5. Insert the new battery by pressing it down.
6. Insert the formatter into the printer by pressing it down, and tighten the screws.
7. Reconnect the cables and turn the printer on.

Printer maintenance kits

Three maintenance kits are available for your printer, containing components that may need to be replaced after long use. When one of them is needed, a message is displayed on the front panel and by the HP Printer Utility.

When you see the message, you should contact HP Support (see [Contact HP Support on page 154](#)) and request the maintenance kit. Two of the kits are installed by service engineers only; the third consists of a replacement cutter, which you can install yourself (see [Replace the cutter on page 93](#)).

Secure Disk Erase

The printer's hard disk is used as a temporary storage area for print jobs. The Secure Disk Erase facility can completely erase your information from the hard disk to protect it from unauthorized access. You can choose to erase particular files, or the whole hard disk.

Secure Disk Erase provides three different levels of security:

- **Non-Secure Fast Erase:** all pointers to the information are erased. The information itself remains on the hard disk until the disk space it occupies is needed for other purposes, and it is then overwritten. While it remains on the disk, it is difficult for most people to access, but may be accessed using software designed for the purpose. This is the normal method in which files are erased on most computer systems; it is the fastest method but the least secure.
- **Secure Fast Erase:** all pointers to the information are erased, and the information itself is also overwritten with a fixed character pattern. This method is slower than Non-Secure Fast Erase, but more secure. It may still be possible to access fragments of the erased information by using special tools to detect residual magnetic traces.



- **Secure Sanitizing Erase:** all pointers to the information are erased, and the information itself is repetitively overwritten using an algorithm designed to eliminate any residual traces. This is the slowest method, but the most secure. Secure Sanitizing Erase meets the US Department of Defense 5220-22.m requirements for clearing and sanitization of disk media. This is the default security level when using Secure Disk Erase.



Secure Disk Erase is one of the facilities provided by Web JetAdmin, which is HP's free Web-based print management software: see <http://www.hp.com/go/webjetadmin/>.

If you have difficulty in using Secure Disk Erase from Web JetAdmin, please contact HP Support: see [Contact HP Support on page 154](#).

Before choosing to erase the whole hard disk, you should be aware of the following considerations:

- You may be asked to restart the printer several times during the process, which will take about 6 hours with Secure Disk Erase or 24 hours with Secure Sanitizing Erase.
- The demo prints available from the front panel will be deleted and not restored.

10 Accessories

- [How to order supplies and accessories](#)
- [Introduction to the accessories](#)

How to order supplies and accessories

There are two alternative ways to order supplies or accessories for your printer:

- Visit <http://www.hp.com/go/z3200/supplies/> or <http://www.hp.com/go/z3200/accessories/> on the Web.
- Contact your local dealer.

The rest of this chapter lists the available supplies and accessories, and their part numbers.

Order ink supplies

The following ink supplies can be ordered for your printer.

Table 10-1 Ink cartridges

Cartridge	Part number
HP 70 Matte Black 130 ml Ink Cartridge	C9448A
HP 70 Photo Black 130 ml Ink Cartridge	C9449A
HP 70 Gray 130 ml Ink Cartridge	C9450A
HP 70 Light Gray 130 ml Ink Cartridge	C9451A
HP 70 Magenta 130 ml Ink Cartridge	C9453A
HP 70 Yellow 130 ml Ink Cartridge	C9454A
HP 70 Light Magenta 130 ml Ink Cartridge	C9455A
HP 73 Chromatic Red 130 ml Ink Cartridge	CD951A
HP 70 Green 130 ml Ink Cartridge	C9457A
HP 70 Blue 130 ml Ink Cartridge	C9458A
HP 70 Gloss Enhancer 130 ml Ink Cartridge	C9459A
HP 70 Light Cyan 130 ml Ink Cartridge	C9390A
HP 70 Matte Black 130 ml Ink Cartridge Twin Pack	CB339A
HP 70 Photo Black 130 ml Ink Cartridge Twin Pack	CB340A
HP 70 Gray 130 ml Ink Cartridge Twin Pack	CB341A
HP 70 Light Gray 130 ml Ink Cartridge Twin Pack	CB342A
HP 70 Magenta 130 ml Ink Cartridge Twin Pack	CB344A
HP 70 Yellow 130 ml Ink Cartridge Twin Pack	CB345A
HP 70 Light Magenta 130 ml Ink Cartridge Twin Pack	CB346A
HP 73 Chromatic Red 130 ml Ink Cartridge Twin Pack	CD952A
HP 70 Green 130 ml Ink Cartridge Twin Pack	CB348A
HP 70 Blue 130 ml Ink Cartridge Twin Pack	CB349A
HP 70 Gloss Enhancer 130 ml Ink Cartridge Twin Pack	CB350A
HP 70 Light Cyan 130 ml Ink Cartridge Twin Pack	CB351A

Table 10-2 Printheads

Printhead	Part number
HP 70 Light Magenta & Light Cyan Printhead	C9405A
HP 70 Magenta & Yellow Printhead	C9406A
HP 70 Photo Black & Light Gray Printhead	C9407A
HP 70 Blue & Green Printhead	C9408A
HP 73 Matte Black & Chromatic Red Printhead	CD949A
HP 70 Gloss Enhancer & Gray Printhead	C9410A

Order paper

HP currently provides the following paper types for use with your printer.

 **NOTE:** This list is likely to change over the course of time. For the latest information, see <http://www.hp.com/go/z3200/supplies/>. For further background information, see <http://www.hp.com/go/z3200/paperpresets/>.

Key to availability:

- (A) indicates papers available in Asia (excluding Japan)
- (E) indicates papers available in Europe, the Middle East and Africa
- (J) indicates papers available in Japan
- (L) indicates papers available in Latin America
- (N) indicates papers available in North America

If the part number is not followed by parentheses, the paper is available in all regions.

Table 10-3 Roll paper

Paper type	g/m ²	Length	Width	Part numbers
Bond and Coated Paper				
Super Heavyweight Plus Matte Paper	210	100 ft = 30.5 m	24 in = 610 mm	Q6626A (AEJLN)
			36 in = 914 mm	Q6627A (AEJLN)
			42 in = 1067 mm	Q6628A (AEJLN)
Heavyweight Coated Paper	131	100 ft = 30.5 m	24 in = 610 mm	C6029C (AEJN)
			36 in = 914 mm	C6030C
			42 in = 1067 mm	C6569C
			225 ft = 67.5 m	42 in = 1067 mm
Universal Heavyweight Coated Paper	120	100 ft = 30.5 m	24 in = 610 mm	Q1412A (AEJN)
			36 in = 914 mm	Q1413A
			42 in = 1067 mm	Q1414A (AEJN)

Table 10-3 Roll paper (continued)

Paper type	g/m ²	Length	Width	Part numbers
Coated Paper	90	150 ft = 45.7 m	16.54 in = 420 mm	Q1443A (J)
			23.39 in = 594 mm	Q1442A (EJ)
			24 in = 610 mm	C6019B
			33.11 in = 841 mm	Q1441A (EJ)
			36 in = 914 mm	C6020B
			42 in = 1067 mm	C6567B
			300 ft = 91.4 m	36 in = 914 mm
Inkjet Coated Paper	90	150 ft = 45.7 m	18 in = 458 mm	Q7897A (ELN)
Universal Coated Paper	95	150 ft = 45.7 m	24 in = 610 mm	Q1404A (AEJN)
			36 in = 914 mm	Q1405A (AEJN)
			42 in = 1067 mm	Q1406A
Bright White Inkjet Bond Paper	90	150 ft = 45.7 m	16.54 in = 420 mm	Q1446A (J)
			23.39 in = 594 mm	Q1445A (EJ)
			24 in = 610 mm	C1860A (LN), C6035A (AEJ)
			33.11 in = 841 mm	Q1444A (EJ)
			36 in = 914 mm	C1861A (LN), C6036A (AEJ)
		300 ft = 91.4 m	36 in = 914 mm	C6810A
Universal Bond Paper	80	150 ft = 45.7 m	23.39 in = 594 mm	Q8003A (AJ)
			24 in = 610 mm	Q1396A
			36 in = 914 mm	Q1397A
			42 in = 1067 mm	Q1398A
Fluorescent Yellow Coloured Paper	100	150 ft = 45.7 m	36 in = 914 mm	Q1757A (E)
Yellow Coloured Paper	92	150 ft = 45.7 m	23.39 in = 594 mm	Q6596A (E)
			36 in = 914 mm	Q1760A (EN)
Technical Paper				
Natural Tracing Paper	90	150 ft = 45.7 m	16.54 in = 420 mm	Q1440A (J)
			23.39 in = 594 mm	Q1439A (J)
			24 in = 610 mm	C3869A
			33.11 in = 841 mm	Q1438A (J)
			36 in = 914 mm	C3868A
Translucent Bond Paper	67	150 ft = 45.7 m	24 in = 610 mm	C3860A (AJN)
			36 in = 914 mm	C3859A (LN)
Vellum Paper	75	150 ft = 45.7 m	24 in = 610 mm	C3862A (N)
			36 in = 914 mm	C3861A (LN)
Film (Technical and Graphic)				

Table 10-3 Roll paper (continued)

Paper type	g/m ²	Length	Width	Part numbers	
Clear Film	174	75 ft = 22.9 m	24 in = 610 mm	C3876A (AEJN)	
			36 in = 914 mm	C3875A	
Matte Film	160	125 ft = 38.1 m	24 in = 610 mm	51642A (AEJN)	
			36 in = 914 mm	51642B	
High Gloss Polyester Film					
White Matte Polyester Film	167	50 ft = 15.2 m	36 in = 914 mm	Q1736A (AEN)	
Photographic Paper					
Professional Satin Photo Paper	300	50 ft = 15.2 m	24 in = 610 mm	Q8759A	
			44 in = 1118 mm	Q8840A	
Premium Instant-dry Gloss Photo Paper	260	50 ft = 15.2 m	18 in = 458 mm	Q7990A	
			75 ft = 22.9 m	24 in = 610 mm	Q7991A
			100 ft = 30.5 m	36 in = 914 mm	Q7993A
				42 in = 1067 mm	Q7995A
Premium Instant-dry Satin Photo Paper	260	50 ft = 15.2 m	18 in = 458 mm	Q8001A (ELN)	
			75 ft = 22.9 m	24 in = 610 mm	Q7992A
			100 ft = 30.5 m	36 in = 914 mm	Q7994A
				42 in = 1067 mm	Q7996A
Universal Instant-dry Gloss Photo Paper	190	100 ft = 30.5 m	24 in = 610 mm	Q6574A	
			36 in = 914 mm	Q6575A	
			42 in = 1067 mm	Q6576A	
			200 ft = 61m	42 in = 1067 mm	Q8754A (ELN)
				42 in = 1067 mm	Q8755A
Universal Instant-dry Semi-Gloss Photo Paper	190	100 ft = 30.5 m	24 in = 610 mm	Q6579A	
			36 in = 914 mm	Q6580A	
			42 in = 1067 mm	Q6581A	
			200 ft = 61m	42 in = 1067 mm	Q8755A
Everyday Pigment Ink Gloss Photo Paper	235	100 ft = 30.5 m	24 in = 610 mm	Q8916A	
			36 in = 914 mm	Q8917A	
			42 in = 1067 mm	Q8918A	
Everyday Pigment Ink Satin Photo Paper	235	100 ft = 30.5 m	24 in = 610 mm	Q8920A	
			36 in = 914 mm	Q8921A	
			42 in = 1067 mm	Q8922A	
Premium Matte Photo Paper	210	100 ft = 30.5 m	24 in = 610 mm	CG459A	
			36 in = 914 mm	CG460A	
Proofing Paper					
Professional High-gloss Contract Proofing Paper	200	100 ft = 30.5 m	18 in = 458 mm	Q8664A (EN)	
			24 in = 610 mm	Q8663A (EN)	

Table 10-3 Roll paper (continued)

Paper type	g/m ²	Length	Width	Part numbers
Professional Semi-gloss Contract Proofing Paper	235	100 ft = 30.5 m	18 in = 458 mm	Q8049A (EN)
			24 in = 610 mm	Q7971A (EN)
			36 in = 914 mm	Q8909A (EN)
			42 in = 1067 mm	Q8910A (EN)
Premium Semi-gloss Proofing Paper	240	100 ft = 30.5 m	18 in = 458 mm	CG462A (E)
			24 in = 610 mm	CG463A (E)
			42 in = 1067 mm	CG490A (E)
Matte Proofing Paper	146	100 ft = 30.5 m	18 in = 458 mm	Q7896A (EJN)
			24 in = 610 mm	Q1968A (AEJN)
Backlit Material				
Premium Vivid Color Backlit Film	285	100 ft = 30.5 m	36 in = 914 mm	Q8747A
			42 in = 1067 mm	Q8748A
Self-adhesive Material				
Self-adhesive Indoor Paper	170	75 ft = 22.9 m	36 in = 914 mm	Q1733A (EJN)
Universal Adhesive Vinyl	290	66 ft = 20.1 m	36 in = 914 mm	Q8676A (EN)
			42 in = 1067 mm	Q8677A (EN)
Matte Adhesive-back Polypropylene	225	70 ft = 21.3 m	36 in = 914 mm	Q1908A (AEN)
Colorfast Adhesive Vinyl	328	40 ft = 12.2 m	36 in = 914 mm	C6775A
Banner and Sign Material				
Durable Display Film	205	50 ft = 15.2 m	36 in = 914 mm	Q6620A (EN)
Instant-dry Gloss Indoor Banner	195	50 ft = 15.2 m	36 in = 914 mm	Q5482A (N)
			42 in = 1067 mm	Q5483A (N)
Opaque Scrim	460	50 ft = 15.2 m	24 in = 610 mm	Q8675A (N)
			36 in = 914 mm	Q1898B (AEN)
			42 in = 1067 mm	Q1899B (AEN)
Matte Polypropylene	130	75 ft = 22.9 m	36 in = 914 mm	Q1903A (AEN)
			42 in = 1067 mm	Q1904A (AEN)
Banners with Tyvek®	140	50 ft = 15.2 m	36 in = 914 mm	C6787A (AJN)
Outdoor Paper	145	100 ft = 30.5 m	36 in = 914 mm	Q1730A (EN)
Blue Back Outdoor Billboard Paper	140	100 ft = 30.5 m	36 in = 914 mm	C7949A (EN)
PVC-free Banner	410	100 ft = 30.5 m	36 in = 914 mm	CG815A (EN)
			42 in = 1067 mm	CG816A (EN)
Fabric/Textile Material				
Durable Flag Fabric	110	33 ft = 10.1 m	36 in = 914 mm	Q6624A (EN)
Paper-backed Polyester Fabric	110	33 ft = 10.1 m	36 in = 914 mm	Q1745A (E)
Paper-backed Satin Fabric Silk	63.5	100 ft = 30.5 m	36 in = 914 mm	Q1748A (EN)
(with backing)	160			

Table 10-3 Roll paper (continued)

Paper type	g/m ²	Length	Width	Part numbers
Fine Art Printing Material				
Hahnemühle Smooth Fine Art Paper	265	35 ft = 10.7 m	24 in = 610 mm	Q8732A (EN)
			36 in = 914 mm	Q8745A (EN)
			42 in = 1067 mm	Q8733A (EN)
	310	35 ft = 10.7 m	24 in = 610 mm	Q8734A (EN)
			42 in = 1067 mm	Q8735A (EN)
Hahnemühle Textured Fine Art Paper	265	35 ft = 10.7 m	24 in = 610 mm	Q8736A (EN)
			36 in = 914 mm	Q8737A (EN)
			42 in = 1067 mm	Q8738A (EN)
	310	35 ft = 10.7 m	24 in = 610 mm	Q8739A (EN)
			42 in = 1067 mm	Q8740A (EN)
Hahnemühle Watercolor Paper	210	38 ft = 11.6 m	36 in = 914 mm	Q1984A (EN)
Baryte Satin Art Paper	290	50 ft = 15.2 m	24 in = 610 mm	CG803A (EN)
			44 in = 1118 mm	CG804A (EN)
Aquarella Art Paper	240	35 ft = 10.7 m	24 in = 610 mm	Q8741A (EN)
			36 in = 914 mm	Q8746A (EN)
Matte Litho-realistic Paper	270	100 ft = 30.5 m	24 in = 610 mm	Q7972A (ELN)
			36 in = 914 mm	Q7973A (ELN)
Canvas Paper	180	35 ft = 10.7 m	36 in = 914 mm	Q1724A (AEN)
Professional Matte Canvas	430	20 ft = 6.1 m	24 in = 610 mm	Q8673A (ELN)
		50 ft = 15.2 m	36 in = 914 mm	Q8761A (ELN)
			42 in = 1067 mm	Q8674A (ELN)
Collector Satin Canvas	400	20 ft = 6.1 m	24 in = 610 mm	Q8708A
		50 ft = 15.2 m	36 in = 914 mm	Q8709A
			42 in = 1067 mm	Q8710A
Artist Matte Canvas	380	20 ft = 6.1 m	24 in = 610 mm	Q8704A
		50 ft = 15.2 m	36 in = 914 mm	Q8705A
			42 in = 1067 mm	Q8706A
Universal Matte Canvas	350	20 ft = 6.1 m	24 in = 610 mm	Q8712A
		50 ft = 15.2 m	36 in = 914 mm	Q8713A
			42 in = 1067 mm	Q8714A

Table 10-4 Sheet paper

Paper type	g/m ²	Length	Width	Part numbers
Bond and Coated Paper				
Inkjet Coated Paper	90	24 in = 610 mm	18 in = 457 mm	Q1961A (AJEN)
		36 in = 914 mm	24 in = 610 mm	Q1962A (AJEN)

Table 10-4 Sheet paper (continued)

Paper type	g/m ²	Length	Width	Part numbers
Photographic Paper				
Professional Satin Photo Paper	300	19 in = 483 mm	13 in = 330 mm	Q8839A
Matte Photo Paper	196	19 in = 483 mm	13 in = 330 mm	Q5492A
Proofing Paper				
Professional High-gloss Contract Proofing Paper	200	19 in = 483 mm	13 in = 330 mm	Q8662A (EN)
Professional Semi-gloss Contract Proofing Paper	235	19 in = 483 mm	13 in = 330 mm	Q7970A (EJN)
Premium Semi-gloss Proofing Paper	240	19 in = 483 mm	13 in = 330 mm	CG461A (E)
Matte Proofing Paper	146	19 in = 483 mm	13 in = 330 mm	Q1967A (AEN)
Fine Art Printing Material				
Hahnemühle Smooth Fine Art Paper	265	19 in = 483 mm	13 in = 330 mm	Q8728A
Hahnemühle Watercolor Paper	210	19 in = 483 mm	13 in = 330 mm	Q8729A
Aquarella Art Paper	240	19 in = 483 mm	13 in = 330 mm	Q8730A
Artist Matte Canvas	380	19 in = 483 mm	13 in = 330 mm	Q8731A

Non-recommended paper types

In many cases, paper types that HP does not support may nevertheless be compatible with your printer. However, the following paper types are unlikely to give satisfactory results:

- Photo paper that swells
- Brochure paper

Order accessories

The following accessories can be ordered for your printer.

Name	Product number
HP Designjet Z2100/Z3200 24 inch Stand (Asia only)	Q6663A
HP Designjet Z2100/Z3200 24 inch Spindle	Q6700A
HP Designjet Z2100/Z3200 44 inch Spindle	Q6699A
HP Advanced Profiling Solution International	Q6695A
HP Advanced Profiling Solution Asia Pacific	Q6701A
HP Jetdirect 630n IPv6 Gigabit Print Server	J7997G
HP Jetdirect 635n IPv6/IPsec Print Server	J7961A, J7961G

Introduction to the accessories

Stand

The printer stand is used to support the printer and the basket, which collects prints as they emerge from the printer. The main alternative to the stand is to put the printer on a desk.

The stand is normally provided with the HP Designjet Z3200. However, the HP Designjet Z3200 24in is sold in Asian countries without the stand, and so the stand for this printer is also available separately as an accessory.

The height of the stand is 668 mm.

The weight of the stand is 12.22 kg (44 inch) or 10.12 kg (24 inch).

HP Advanced Profiling Solution

HP and GretagMacbeth have worked together to develop the HP Advanced Profiling Solution, powered by GretagMacbeth™ technology, which takes advantage of the spectrophotometer built into the printer to provide a revolutionary end-to-end calibrated ICC color workflow.

The HP Advanced Profiling Solution, tailored for HP printers, offers a powerful and automated, yet cost-effective color management system with a fully streamlined workflow that allows you to avoid the cost, hassle and delay of offline measurement devices. Together, GretagMacbeth and HP provide a new experience to designers, photographers and other creative professionals, whereby they can generate proofs and photo quality prints accurately and consistently.

The Advanced Profiling Solution includes:

- The HP Colorimeter monitor calibrator, with which you can accurately calibrate and profile all of your monitors: LCD, CRT and laptop
- An ICC profiling and editing software application providing additional features and functionality beyond those included in the HP Color Center

Using the Advanced Profiling Solution, you can:

- See matching colors on your screen and printed paper
- Generate color profiles for all your paper types, in RGB or CMYK

 **NOTE:** CMYK profiles can be used only with RIP software that works in CMYK

- Edit your color profiles visually for maximum control
- Perform all operations easily using a step-by-step software interface—no extra manuals needed

The HP Advanced Profiling Solution is fully supported by HP, so you do not need to deal with various support organizations from different companies.

For more information, see <http://www.hp.com/go/z3200/solutions/>.

Key features

The HP Advanced Profiling Solution lets you take control of your colors:

- Calibrate and profile all of your monitors—LCD, CRT and laptop
- Automated RGB profiling with HP software drivers to ensure accurate printing (photos, designs, etc.)

- Automated CMYK profiling when your printer is driven by a Raster Image Processor (RIP) for accurate digital prints and proofs
- Easily and visually edit your profiles for ultimate color control

11 Troubleshooting paper issues

- The paper cannot be loaded successfully
- The paper type is not in the driver
- The paper has jammed
- Prints do not fall neatly into the basket
- The sheet stays in the printer when the print has been completed
- The paper is cut when the print has been completed
- The cutter does not cut well
- The roll is loose on the spindle
- A strip stays on the output tray and generates jams
- Recalibrate the paper advance

The paper cannot be loaded successfully

- Ensure no paper is loaded.
- Ensure the paper is far enough inside the printer; you should feel the printer grab the paper.
- Do not attempt to straighten the paper during the aligning process, unless instructed to do so by the front-panel display. The printer automatically attempts to straighten the paper.
- The paper may be crumpled, or warped, or may have irregular edges.

Unsuccessful roll load

- If the paper does not load, the leading edge of the paper may not be straight or clean, and needs to be trimmed. Remove the initial 2 cm (1 in) from the roll and try again. This may be necessary even with a new roll of paper.
- Ensure the roll ends are tight against the spindle ends.
- Check that the spindle is correctly inserted.
- Check that the paper is correctly loaded on the spindle, and that it loads over the roll into the printer.
- Check that all roll stops have been removed.
- Check that the paper is wound tightly on the roll.
- Do not touch the roll or paper at during the alignment process.

If the paper has not been inserted straight, the front panel displays the following instructions.

1. When prompted by the front-panel display, lift the blue lever on the left. The printer attempts to straighten the roll.
2. When prompted by the front-panel display, lower the blue lever. The printer checks the alignment. If the roll is aligned, the printer measures the width and you are now ready to print.
If the roll is still not aligned, the front panel displays an error and instructions.
3. When prompted by the front-panel display, lift the blue lever on the left.
4. Rewind the roll from the end of the spindle until the edge is on the blue line.
5. Press **OK**, on the front panel.
6. When prompted by the front-panel display, lower the lever. The printer checks the alignment. If the roll is aligned, the printer measures the width and you are now ready to print.

If the roll is still not aligned, the front panel displays an error and instructions to start again at step three.

If you would like to start the load process again, cancel the process on the front panel and rewind the roll from the end of the spindle until the edge is removed from the printer.

Unsuccessful sheet load

- Guide the sheet, especially thick papers, when the printer initially feeds the sheet.
- Do not attempt to straighten the sheet during the loading process, unless instructed to by the front-panel display. The printer automatically attempts to straighten the sheet.
- Preferably avoid using hand-cut sheets; if you need to use them, load them with the option **Sheet, without skew check**.

If the sheet is not caught by the printer, the front-panel display asks to push paper further into the printer, and tries to feed the paper again.

If the sheet is caught by the printer but is not inserted straight, the front panel displays the following instructions.

1. When prompted by the front-panel display, lift the blue lever on the left.
2. Adjust the sheet to align with the front and right side blue lines.
3. Once the sheet is aligned, press **OK** on the front panel.
4. When prompted by the front-panel display, lower the blue lever. The printer checks the alignment. If the sheet is aligned, the printer measures the sheet and feeds it out the back into the roll feed. You are now ready to print.

If the sheet is still not aligned, the front panel displays an error and instructions to start again.

If you would like to start the load process again, cancel the process on the front panel and the printer ejects the sheet out the front.

Paper loading error messages

Here is a list of front-panel display messages related to paper loading, with the suggested corrective action.

front-panel display message	Suggested action
Paper incorrectly loaded.	The paper has not been loaded correctly; the edge was not aligned with the load guide. Lift the blue lever, remove paper, and lower lever.
Paper not found.	During the paper load process the printer did not detect any paper. Ensure the paper is fully inserted.
Paper loaded with too much skew.	During the paper load process the printer detected that the paper had too much skew. Follow the instructions on the front-panel display.
Paper too small.	During the load process the printer detected that the paper is too narrow or too short to be loaded in the printer. Press the Cancel key to stop the load process. See Functional specifications on page 157 .
Paper too big	During the load process the printer has detected that the paper is either too wide or too long (sheet only) to be loaded correctly. Press the Cancel key to stop the load process. See Functional specifications on page 157 .
Lever lifted.	During the load process the blue lever was lifted. This prevents the printer from loading the paper. Follow the instructions on the front-panel display.

The paper type is not in the driver

 **TIP:** First check that your driver is up to date (see [Update the software on page 99](#)). The latest driver may offer a longer list of paper types.

To work with a paper not in the driver, you can add new paper type to your driver, see [To create your own paper preset on page 36](#). Adding your paper type to the driver is recommended as it allows you to store custom parameters, such as a profile, for your paper.

Your new paper type must be based on an existing paper category. The available categories are:

- **Bond and Coated Paper:** Fiber-based, thin papers with a matte surface. These papers use matte black ink, no gloss enhancer, relatively low ink limits and high carriage position.
- **Photo Paper:** Photo-base, relatively thick papers with variety of finishing from matte to satin to glossy. These papers use photo black ink and gloss enhancer, with the exception of Photo Matte Papers, relatively high ink limits and low carriage position, with the exception of Baryte and Photo Matte Papers. Generally they will print with the starwheels up.
- **Proofing Paper:** A variety of papers from matte to satin and glossy used to simulate commercial printing with high color accuracy requirements.
- **Fine Art Material:** Canvas, matte and paper-base photo materials used for high-quality fine art printing. These papers use matte black ink and no gloss enhancer, with the exception of Canvas Satin and Pearl papers, which use photo black and gloss enhancer. They all use high carriage position with high ink limits.
- **Film:** Synthetic film-base materials that generally use photo black and no gloss enhancer, with relatively low ink limits and high carriage position.
- **Backlit:** Synthetic translucent materials that use photo black and no gloss enhancer with high ink limits, high carriage position and starwheels up.

Black ink is easily removed when touched

 **TIP:** Handle prints with care, especially when they have just emerged from the printer.

It may be that your paper is incompatible with matte black ink. To use non-matte black ink, select paper type **Photo Paper > Gloss Photo Paper**.

 **NOTE:** When you select a different paper type, the colors of your print could change visibly.

After printing, the paper has wrinkles or there is too much ink

This happens when too much ink is used. To use less ink, select a thinner category. Matte paper categories from thinnest to thickest are:

- Plain Paper
- Coated Paper
- Heavyweight Coated Paper
- Fine Art Paper
- Super Heavyweight Coated Paper
- Thick Fine Art Paper (>250 g/m²)

For other image quality problems, see [Troubleshooting print-quality issues on page 120](#).

The paper has jammed

When a paper jam occurs, you normally see the **Possible paper jam** message in the front-panel display.

1. Power off the printer at the front panel and also switch it off at the rear.

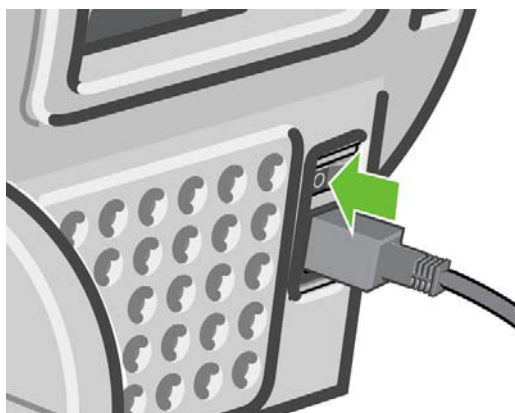

2. Open the window.

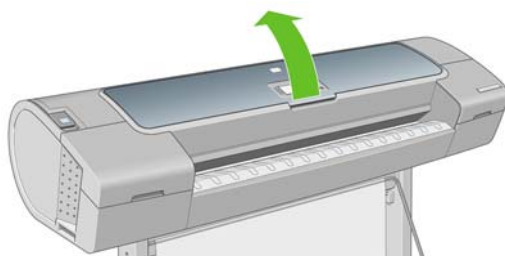

3. Try to move the printhead carriage out of the way.

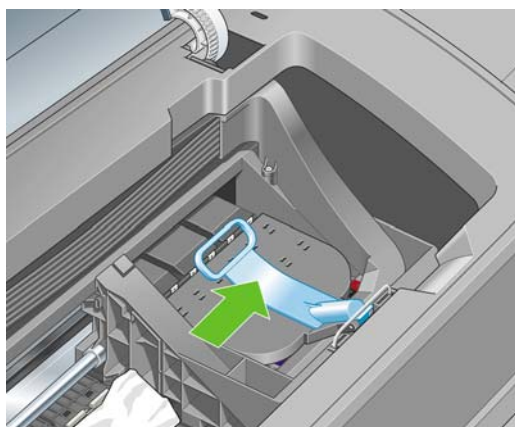

4. Lift the blue lever as far up as it will go.

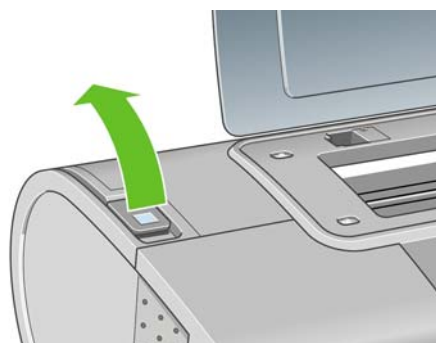

- Carefully remove any of the jammed paper that you can lift up and out from the top of the printer.

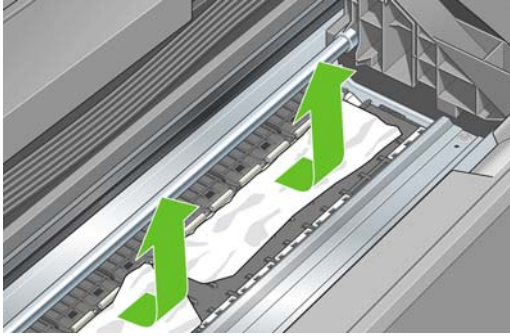

- Standing behind the printer, rewind the roll or pull the cut sheet from the printer. If you cannot see the paper, return to the front of the printer and remove it from the output tray.

△ **CAUTION:** Do not move the paper sideways, as it could damage the printer.



- Carefully remove all small pieces of paper.

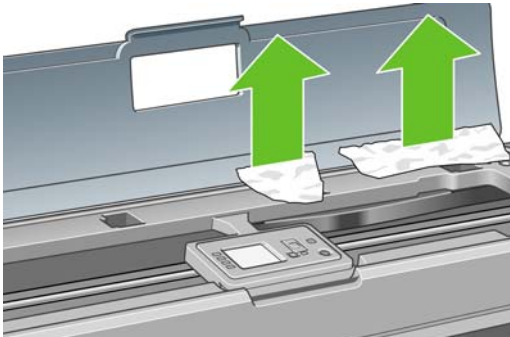

- Lower the blue lever.

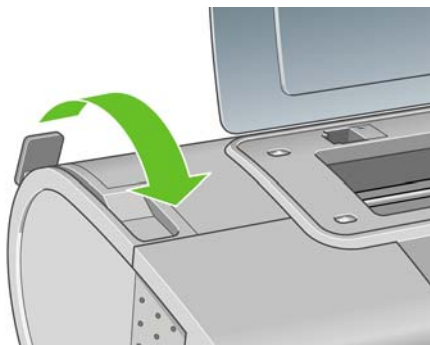

9. Close transparent window.

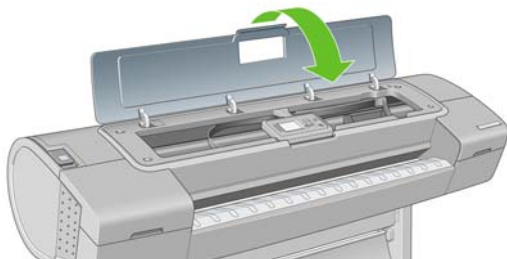

10. Switch on the printer.
11. Reload the roll, or load a new sheet. See [Load a roll into the printer on page 25](#) or [Load a single sheet on page 30](#).

 **NOTE:** If you find that there is still some paper causing an obstruction within the printer, restart the procedure and carefully remove all pieces of paper.

Prints do not fall neatly into the basket

- Ensure the basket is correctly installed.
- Ensure the basket is open.
- Ensure the basket not full.
- Paper often tends to curl near the end of a roll, which can cause output problems. Load a new roll, or remove prints manually as they are completed.

The sheet stays in the printer when the print has been completed

The printer holds the paper to allow the print to dry after printing, see [Change the drying time on page 40](#). If the paper is only partially ejected after the drying time, gently pull the sheet out of the printer. If the automatic cutter is disabled, use the **Form feed and cut** key on the front panel, see [Feed and cut the paper on page 40](#).

The paper is cut when the print has been completed

By default the printer cuts the paper after the drying time has been completed, see [Change the drying time on page 40](#). You can disable the cutter, see [Turn the automatic cutter on and off on page 40](#).

The cutter does not cut well

By default the printer is set to cut the paper automatically after the drying time has been completed.

If the cutter is turned on but not cutting correctly, check that the cutter rail is clean and clear of any obstacles.

If the cutter is turned off, the **Form feed and cut** key only advances the paper. Use this key to move the print far enough out of the front of the printer, until it is convenient to manually cut with a straight edge or scissors.

The roll is loose on the spindle

The roll may need to be replaced or reloaded. If your roll has a three-inch cardboard core, ensure the core adaptors supplied with the printer have been installed, see [Load a roll onto the spindle on page 23](#).

A strip stays on the output tray and generates jams

If a small piece of paper (200 mm or smaller) has been cut, such as before (if new roll) and after a full-bleed print or after the **Form feed and cut** key has been pressed, the cut strip remains in the output tray. Only when the printer is not working, reach in the tray and remove the strip.

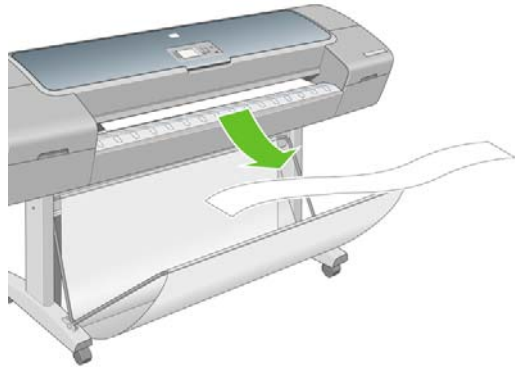

Recalibrate the paper advance

Accurate paper advance is important to image quality because it is part of controlling the proper placement of dots on the paper. If the paper is not advanced the proper distance between printhead passes, light or dark bands appear in the print and image grain may increase.

The printer is calibrated to advance correctly with all the papers appearing in the front panel. When you select the type of loaded paper, the printer adjusts the rate at which to advance the paper while printing. However, if you are using custom paper or not satisfied with the default calibration of your paper, you may need to recalibrate the rate at which the paper advances. See [Troubleshooting print-quality issues on page 120](#) for steps to determine if paper advance calibration will solve your issue.

You can check the paper advance calibration status of the currently loaded paper at any time by pressing the **View loaded paper** key on the front panel. The status may be one of the following.

- **DEFAULT:** This status appears when loading an HP paper. HP papers in the Front Panel have been optimized by default and unless you experience image quality problems in your printed image such as banding or graininess it is not recommended to recalibrate the paper advance.
- **RECOMMENDED:** This status appears when a new paper is created. The paper advance values for this paper are inherited from the family type. In these cases it is recommended you perform a paper advance calibration to optimize the values.
- **OK:** This status indicates that the loaded paper has been calibrated before. However you may need to repeat the calibration if you experience image quality problems such as banding or graininess in your printed image.

 **NOTE:** Whenever you update the printer's firmware, the paper advance calibration values are reset to the factory default, see [Update the firmware on page 98](#).

Recalibrating the paper advance procedure

If you are using a transparent paper type, omit the first two steps below and advance to step 3.

1. From the front panel, select the Image Quality Maintenance menu icon , then **Calibrate paper advance**. The printer automatically recalibrates the paper advance and prints a paper advance calibration image.
2. Wait until the front panel displays the status screen and re-print your print.

 **NOTE:** The recalibration procedure takes approximately three minutes. Do not worry about the paper advance calibration image. The front-panel display shows any errors in the process.

If you are satisfied with your print continue using this calibration for your paper type. If you see improvement in your print, continue with step 3. If you are dissatisfied with the recalibration, return to the default calibration, see [Return to default calibration on page 119](#).

3. If you would like to fine-tune the calibration or are using a transparent paper type, select the Image Quality Maintenance menu icon , then **Paper advance calibration > Adjust paper advance**.
4. Select the percentage of change from -100% to 100%. To correct light banding (light-colored horizontal lines), decrease the percentage. To correct dark banding (dark-colored horizontal lines), increase the percentage.
5. Press the **OK** key on the front panel, to save the value.
6. Wait until the front panel displays the status screen and re-print your print.

Return to default calibration

Returning to the default calibration sets all the corrections made by the paper advance calibration to zero. To return to the default paper advance calibration value, you must reset the calibration.

1. From the front panel, select the Image Quality Maintenance menu icon , then **Paper advance calibration > Reset paper advance**
2. Wait until the front panel reports that the operation has completed successfully before pressing the **Back** key to return to the main menu.

12 Troubleshooting print-quality issues

- [General advice](#)
- [Print quality troubleshooting wizard](#)
- [Horizontal lines across the image \(banding\)](#)
- [The whole image is blurry or grainy](#)
- [The paper is not flat](#)
- [The print is scuffed or scratched](#)
- [Ink marks on the paper](#)
- [Vertical dotted or dashed lines on the print](#)
- [Vertical continuous lines on the print](#)
- [Edges of objects are stepped or not sharp](#)
- [Edges of objects are darker than expected](#)
- [Bronzing](#)
- [Horizontal lines at the end of a cut sheet print](#)
- [Vertical lines of different colors](#)
- [White spots on the print](#)
- [Colors are inaccurate](#)
- [The image is incomplete \(clipped at the bottom\)](#)
- [The image is clipped](#)
- [Some objects are missing from the printed image](#)
- [Lines are too thick, too thin or missing](#)
- [Lines appear stepped or jagged](#)
- [Lines print double or in the wrong colors](#)
- [Lines are discontinuous](#)
- [Lines are blurred](#)
- [The Image Diagnostics Print](#)
- [If you still have a problem](#)

General advice

When you have any print-quality problem:

- To achieve the best performance from your printer, use only genuine manufacturer's supplies and accessories, whose reliability and performance have been thoroughly tested to give trouble-free performance and best-quality prints. For details of recommended papers, see [Order paper on page 103](#).
 - Make sure that the paper type selected in the front panel is the same as the paper type loaded into the printer. To check this, use the [View loaded paper](#) key on the front panel. At the same time, check that the paper type has been calibrated. Also make sure that the paper type selected in your software is the same as the paper type loaded into the printer.
-
- △ **CAUTION:** If you have the wrong paper type selected, you could experience poor print quality and incorrect colors, and perhaps even damage to the printheads.
-
- Check that you are using the most appropriate print-quality settings for your purposes (see [Printing on page 42](#)). You are likely to see lower print quality if you have moved the print-quality slider to the 'Speed' end of the scale, or set the custom quality level to **Fast**.
 - Check that your environmental conditions (temperature, humidity) are in the recommended range. See [Environmental specifications on page 159](#).
 - Check that your ink cartridges and printheads have not passed their expiration dates: see [Maintain the ink cartridges on page 97](#).
 - Avoid touching the paper while printing is in progress.

Print quality troubleshooting wizard

The Print Quality Troubleshooting Wizard can help with the following problems:

- Horizontal lines across the image (banding)
- The whole image is blurry or grainy
- Lines are too thick, too thin or missing
- Colors are inaccurate

To start the wizard:

- **From the HP Printer Utility for Windows:** go to the **Support** tab, and select **Print quality troubleshooting**.
- **From the HP Printer Utility for Mac OS:** select **Print quality troubleshooting** in the Support group.
- **From the Mac OS Print dialog:** go to the **Services** panel, select **Device Maintenance**, then select **Print quality troubleshooting** from the list of maintenance tasks.
- **From the Embedded Web Server:** go to the **Support** tab, select **Troubleshooting**, then select **Print quality troubleshooting**.

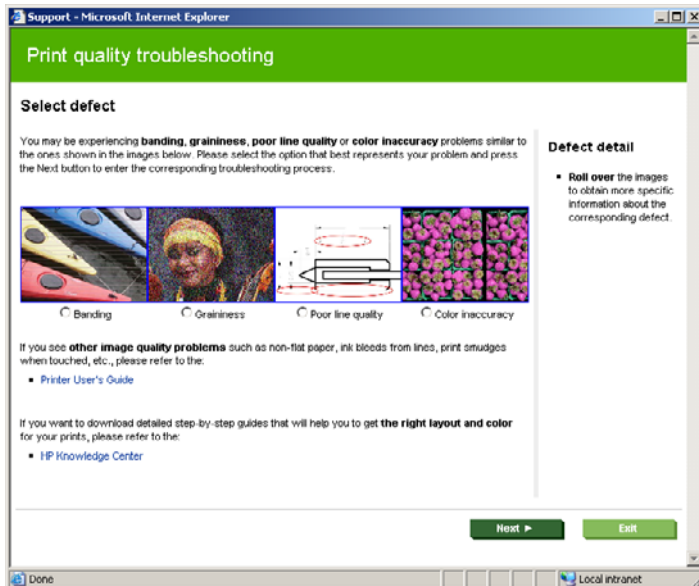

Alternatively, or if you have other print quality problems, you can continue reading this chapter.

Horizontal lines across the image (banding)

If your printed image suffers from added horizontal lines as shown (the color may vary):



1. Check that the paper type you have loaded corresponds to the paper type selected in the front panel and in your software. To check on the front panel, use the **View loaded paper** key.
2. Check that you are using appropriate print-quality settings for your purposes (see [Printing on page 42](#)). In some cases, you can overcome a print-quality problem merely by selecting a higher print-quality level. For instance, if you have set the Print Quality slider to **Speed**, try setting it to **Quality**; if you have already set it to **Quality**, try selecting custom options and then **More Passes**. If you change the print-quality settings, you may wish to reprint your job at this point in case the problem has been solved.
3. Print the Image Diagnostics Print. See [The Image Diagnostics Print on page 133](#).
4. If the printheads are working correctly, go to the front panel and press the **View loaded paper** key to see the paper advance calibration status. If the status is RECOMMENDED, you should perform paper advance calibration: see [Recalibrate the paper advance on page 118](#).

If the problem persists despite all the above actions, contact your customer service representative for further support.

The whole image is blurry or grainy



1. Check that the paper type you have loaded corresponds to the paper type selected in the front panel and in your software. To check on the front panel, use the [View loaded paper](#) key.
2. Check that you are printing on the correct side of the paper.
3. Check that you are using appropriate print-quality settings (see [Printing on page 42](#)). In some cases, you can overcome a print-quality problem merely by selecting a higher print-quality level. For instance, if you have set the Print Quality slider to **Speed**, try setting it to **Quality**; if you have already set it to **Quality**, try selecting custom options and then **More Passes**. If you change the print-quality settings, you may wish to reprint your job at this point in case the problem has been solved.
4. If you are using gloss enhancer, you can reduce grain by turning off or reducing the amount of gloss enhancer; see [If you are printing on photo paper on page 48](#). This can reduce the gloss quality of the image; if you notice any problem, see [Bronzing on page 127](#).
5. Try aligning the printheads. See [Align the printheads on page 142](#). After alignment, you may wish to reprint your job in case the problem has been solved.
6. Go to the front panel and press the [View loaded paper](#) key to see the paper advance calibration status. If the status is RECOMMENDED, you should perform paper advance calibration: see [Recalibrate the paper advance on page 118](#).

If the problem persists despite all the above actions, contact your customer service representative for further support.

The paper is not flat

If the paper does not lie flat when it comes out of the printer, but has shallow waves in it, you are likely to see defects in the printed image, such as vertical stripes. This can happen when you use thin paper that becomes saturated with ink.



1. Check that the paper type you have loaded corresponds to the paper type selected in the front panel and in your software. To check on the front panel, use the [View loaded paper](#) key.
2. Try changing to a thicker paper type, such as HP Heavyweight Coated Paper, HP Super Heavyweight Coated Paper or thicker Digital Fine Art papers.

The print is scuffed or scratched

The black ink pigment can be scuffed or scratched when touched by a finger, a pen or some other object. This is particularly noticeable on coated paper, matte proofing paper and fine art material.

Glossy paper may be extremely sensitive to the basket or to anything else that it contacts soon after printing, depending on the amount of ink used and the environmental conditions at the time of printing.

To reduce the risk of scuffs and scratches:

- Handle prints carefully.
- Avoid stacking prints on top of each other.
- Disable the automatic cutter before printing, so that the print will not fall into the basket. See [Turn the automatic cutter on and off on page 40](#). Alternatively, leave a sheet of paper in the basket so that freshly printed sheets do not make direct contact with the basket.

Ink marks on the paper

This problem can occur for several different reasons.

Horizontal smears on the front of coated paper

If a lot of ink is used on plain or coated paper, the paper absorbs the ink quickly and expands. As the printheads move over the paper, the printheads may come into contact with the paper and smear the printed image. This problem is normally seen only on cut sheets of paper (not on roll paper).

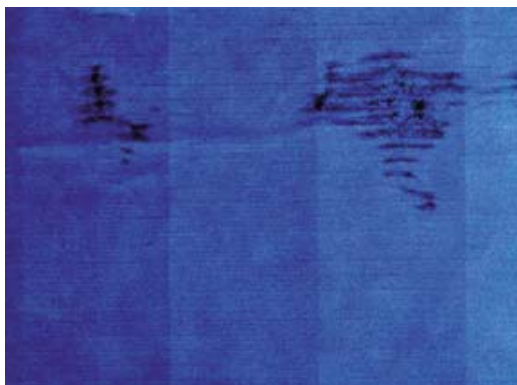

Whenever you notice this problem, cancel the printing job immediately. Press the **Cancel** key and also cancel the job from your computer application. Soaked paper can damage the printheads.

Try the following suggestions to avoid this problem:

1. Check that the paper type you have loaded corresponds to the paper type selected in the front panel and in your software. To check on the front panel, use the **View loaded paper** key.
2. Use a recommended paper type (see [Order paper on page 103](#)) and the correct print settings.
3. If using sheet paper, try rotating the sheet 90 degrees. The orientation of the paper fibers may affect performance.
4. Try changing to a thicker paper type, such as HP Heavyweight Coated Paper, HP Super Heavyweight Coated Paper or thicker Digital Fine Art papers.
5. Try to increase the margins by relocating the image to the center of the page using your software application.
6. If you are using a glossy or satin paper type, try changing the definition of the thickness of the paper. In the HP Printer Utility, go to the **Color Center > Paper preset management > Change printing properties**. For custom papers that have been created with glossy or satin papers as a base, it is possible to change the **Paper thickness** to **Thick**.

Ink marks on the back of the paper

This can happen after a lot of borderless printing, especially with non-standard paper sizes. Ink residues on the platen are likely to mark the back of the paper.

Clean the platen with a soft cloth. Clean each rib separately without touching the foam between the ribs.

Vertical dotted or dashed lines on the print

The starwheels that assist in moving the paper may in some cases leave small, regularly spaced marks on the print.

First check that the paper type you have loaded corresponds to the paper type selected in the front panel and in your software. To check on the front panel, use the **View loaded paper** key.

- Using the HP Printer Utility for Windows, select **Color Center > Paper Preset Management > Change Printing Properties**.
- Using the HP Printer Utility for Mac OS, select **HP Color Center > Paper Preset Management**. Select the paper type, then press the  button and select **Change Printing Properties** from the popup menu.

Change the starwheels position from **Down** to **Up**. If the starwheels position was already **Up**, as it normally is by default for glossy papers, try using a different paper type.

 **NOTE:** We recommend keeping the starwheels in the **Down** position by default for all non-glossy paper types, for better print quality and paper control; change to the **Up** position only if this problem occurs.

Vertical continuous lines on the print

When loading a thick single sheet using the rear tray, the plastic rollers may in some cases leave regular thick stripes on the print.

To avoid this, try loading this kind of sheet using the roll load path instead of the rear tray. You can align the sheet with the help of the black hub of the spindle. Remember to specify that you are loading a single sheet even if you are using the roll load path.

Edges of objects are stepped or not sharp



If edges of objects or lines appear to be poorly defined or lighter in density, and you have already set the print-quality slider to **Quality** in the driver dialog (Mac OS Print dialog), select the custom print-quality options, and make sure that the **More Passes** and **Maximum Detail** options are turned off. See [Printing on page 42](#).

Edges of objects are darker than expected



If edges of objects seem darker than expected, and you have already set the print-quality slider to **Quality** in the driver dialog (Mac OS Print dialog), select the custom print-quality options, and make sure that the **More Passes** and **Maximum Detail** options are turned off. See [Printing on page 42](#).

Bronzing

If you are printing on photo paper in grayscale, and you experience a gloss differential problem when fluorescent light is directly reflected towards you from the print, producing 'bronzed' reflections from the ink, try one of the following:

- If using standard print quality options, ensure that the slider is set to **Quality** (see [Select print quality on page 43](#))
- If using custom print quality options, ensure that the **Gloss enhancer** option is set to **Whole page** (see [If you are printing on photo paper on page 48](#))
- Increase the amount of gloss enhancer used (see [If you are printing on photo paper on page 48](#))
- Display the print vertically or behind glass

Horizontal lines at the end of a cut sheet print

This type of defect affects only the end of a print, within approximately 30 mm of the trailing edge of the paper. You may see some very thin horizontal lines across the print.

To avoid this problem:

1. Print the Image Diagnostics Print. See [The Image Diagnostics Print on page 133](#).
2. Consider printing with roll paper.
3. Consider using larger margins around your image.

Vertical lines of different colors

If your print has vertical bands of different colors along it:

1. Try using thicker paper, choosing from the recommended paper types such as HP Heavyweight Coated Paper and HP Super Heavyweight Paper. See [Order paper on page 103](#).
2. Try using higher print-quality settings (see [Printing on page 42](#)). For instance, if you have set the Print Quality slider to **Speed**, try setting it to **Quality**; if you have already set it to **Quality**, try selecting custom options and then **More Passes**.

White spots on the print

You may notice white spots on the print. This is probably due to paper fibers, dust or loose coating material. To avoid this problem:

1. Try cleaning the paper manually with a brush before printing, to remove any loose fibers or particles.
2. Always keep the cover of your printer closed.
3. Protect your paper rolls and sheets by storing them in bags or boxes.

Colors are inaccurate



If the colors of your print do not match your expectations, try the following:

1. Check that the paper type you have loaded corresponds to the paper type selected in the front panel and in your software. To check on the front panel, use the [View loaded paper](#) key. At the same time, check the color calibration status. If the status is PENDING or OBSOLETE, you should perform color calibration: see [Color calibration on page 60](#). If you have made any changes, you may wish to reprint your job in case the problem has been solved.
2. Check that you are printing on the correct side of the paper.
3. Check that you are using appropriate print-quality settings (see [Printing on page 42](#)). If you have selected the **Speed** or **Fast** options, you may not get the most accurate colors. If you change the print-quality settings, you may wish to reprint your job at this point in case the problem has been solved.
4. If you are using application-managed colors, check that the color profile you are using corresponds to the selected paper type. If you have doubts about which color settings to use, see [Color management on page 53](#). If you need to create a color profile, see [Color profiling on page 61](#).
5. If you select application-managed colors in your application and printer-managed colors in the printer driver, your results will be wrong. You should manage colors in the application or in the printer, but not in both.
6. If the problem consists of color differences between your print and your monitor, please follow the instructions in the “How to calibrate your monitor” section of the HP Color Center. At this point, you may wish to reprint your job in case the problem has been solved.
7. Print the Image Diagnostics Print. See [The Image Diagnostics Print on page 133](#).

If the problem persists despite all the above actions, contact your customer service representative for further support.

Color accuracy using EPS or PDF images in page layout applications

Page layout applications such as Adobe InDesign and QuarkXPress do not support color management of EPS, PDF or grayscale files.

If you have to use such files, try to ensure that the EPS, PDF or grayscale images are already in the same color space that you intend to use later on in Adobe InDesign or QuarkXPress. For instance, if your final goal is to print the job in a press that follows the SWOP standard, convert the image into SWOP when you create it.

The image is incomplete (clipped at the bottom)

- Did you press **Cancel** before all the data were received by the printer? If so, you have ended the data transmission and will have to print the page again.
- The **I/O timeout** setting may be too short. This setting determines how long the printer waits for the computer to send more data, before deciding that the job is finished. From the front panel, increase the **I/O timeout** setting to a longer period and then send the print again. From the Connectivity menu , select **Advanced > Select I/O timeout**.
- There may be a communications problem between your computer and the printer. Check your USB or network cable.
- Check to make sure that your software settings are correct for your current page size (for example, long-axis prints).
- If you are using network software, make sure it has not timed out.

The image is clipped

Clipping normally indicates a discrepancy between the actual printable area on the loaded paper and the printable area as understood by your software. You can often identify this kind of problem before printing by previewing your print (see [Preview a print on page 46](#)).

- Check the actual printable area for the paper size you have loaded.
printable area = paper size – margins
- Check what your software understands to be the printable area (which it may call "printing area" or "imageable area"). For example, some software applications assume standard printable areas that are larger than those used in this printer.
- If you have defined a custom page size with very narrow margins, the printer may impose its own minimal margins, clipping your image slightly. You may want to consider using a larger paper size, or borderless printing (see [Select margins options on page 44](#)).
- If your image contains its own margins, you may be able to print it successfully by using the **Clip Contents by Margins** option (see [Select margins options on page 44](#)).
- If you are trying to print a very long image on a roll, check that your software is capable of printing an image of that size.
- You may have asked to rotate the page from portrait to landscape on a paper size that is not wide enough.
- If necessary, reduce the size of the image or document in your software application, so it fits between the margins.

There is another possible explanation for a clipped image. Some applications, such as Adobe Photoshop, Adobe Illustrator and CorelDRAW, use an internal 16-bit coordinate system which means that they cannot handle an image of more than 32,768 pixels.

 **NOTE:** An image 32,768 pixels long would print at a length of 54.61 in or 1.39 m if you select Best or Quality in the driver, 109.23 in or 2.78 m if you select Fast, Normal or Speed in the driver.

If you try to print an image larger than this from these applications, the bottom of the image may be clipped. To print the whole image, try these suggestions:

- The Windows PCL3 driver dialog includes an option called **Max. application resolution**, which enables you to print successfully in this situation. You will not normally need to change the default setting, which is **Auto**. However, you can find the option in the **Advanced** tab, under **Document Options > Printer Features**.
- Save the file in another format, such as TIFF or EPS, and open it with another application.
- Use a RIP to print the file.

Some objects are missing from the printed image

Large quantities of data may be necessary to print a high-quality large-format print job, and in some specific workflows there may be issues that can lead to some objects missing from the output. Here are some suggestions to help you to avoid this problem.

- Select a smaller page size and scale to the desired final page size in the driver or in the front panel.
- Save the file in another format, such as TIFF or EPS, and open it with another application.
- Use a RIP to print the file.
- Reduce the resolution of bitmap images in your application software.
- Select a lower print quality in order to reduce the resolution of the printed image.
- In the **Advanced** tab of the Windows driver dialog, select **Document options**, **Printer features**, then set **Max. application resolution** to 300.

 **NOTE:** The above settings are mentioned for troubleshooting purposes and may adversely affect the final output quality or the time necessary to generate the print job. Therefore, they should be restored to their default values if they do not help to solve the problem.

Lines are too thick, too thin or missing

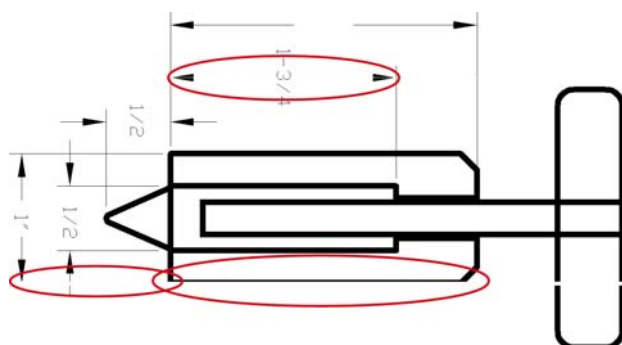

1. Check that the paper type you have loaded corresponds to the paper type selected in the front panel and in your software. To check on the front panel, use the **View loaded paper** key.
2. Check that you are using appropriate print-quality settings for your purposes (see [Printing on page 42](#)). Select the custom print-quality options in the driver dialog (Mac OS Print dialog), and try turning on the **Maximum detail** option. You may wish to reprint your job at this point in case the problem has been solved.
3. If lines are too thin or missing, print the Image Diagnostics Print. See [The Image Diagnostics Print on page 133](#).

4. Try aligning the printheads. See [Align the printheads on page 142](#). After alignment, you may wish to reprint your job in case the problem has been solved.
5. Go to the front panel and press the **View loaded paper** key to see the paper advance calibration status. If the status is RECOMMENDED, you should perform paper advance calibration: see [Recalibrate the paper advance on page 118](#).

If the problem persists despite all the above actions, contact your customer service representative for further support.

Lines appear stepped or jagged

If lines in your image appear stepped or jagged when printed:

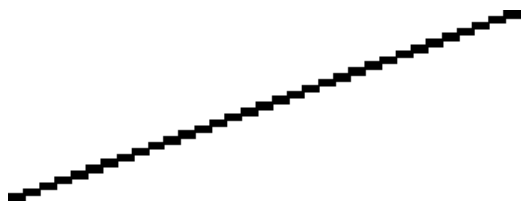

1. The problem may be inherent in the image. Try to improve the image with the application you are using to edit it.
2. Check that you are using appropriate print-quality settings. See [Printing on page 42](#).
3. Select the custom print-quality options in the driver dialog (Mac OS Print dialog), and turn on the **Maximum detail** option.
4. Change your image rendering resolution to 300 ppi or 600 ppi depending on your printing needs. You can find the **Max. application resolution** option in the Windows driver dialog's **Advanced** tab, under **Document Options > Printer Features**.

Lines print double or in the wrong colors

This problem can have various visible symptoms:

- Colored lines are printed double, in different colors.

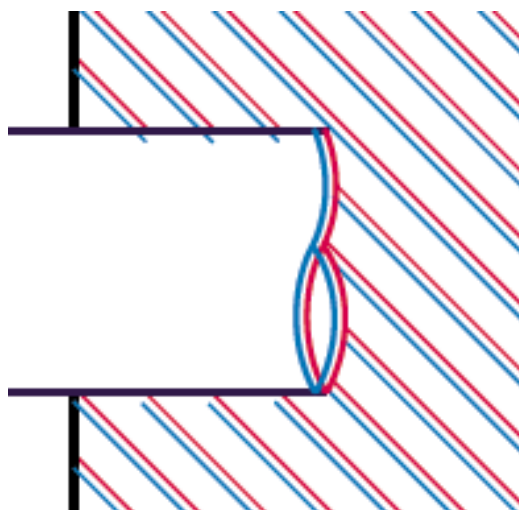

- The borders of colored blocks are wrongly colored.

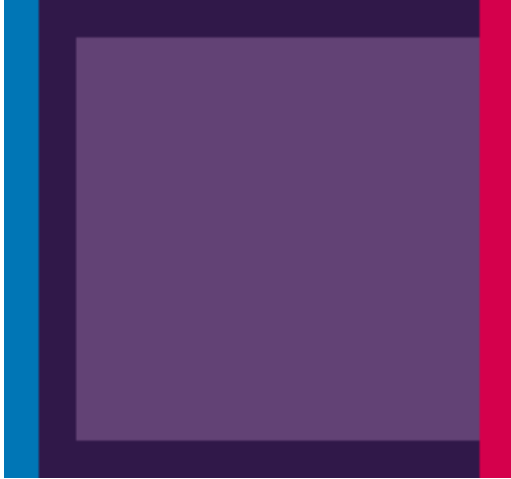

To correct this kind of problem:

1. Reseat the printheads by removing them and then reinserting them. See [Remove a printhead on page 86](#) and [Insert a printhead on page 88](#).
2. Align the printheads. See [Align the printheads on page 142](#).

Lines are discontinuous

If your lines are broken in the following way:



1. Check that you are using appropriate print-quality settings. See [Printing on page 42](#).
2. Reseat the printheads by removing them and then reinserting them. See [Remove a printhead on page 86](#) and [Insert a printhead on page 88](#).
3. Align the printheads. See [Align the printheads on page 142](#).

Lines are blurred



Humidity can cause ink to soak into the paper, making the lines blurred and fuzzy. Try the following:

1. Check that your environmental conditions (temperature, humidity) are suitable for high-quality printing. See [Environmental specifications on page 159](#).
2. Check that the paper type you have loaded corresponds to the paper type selected in the front panel and in your software. To check on the front panel, use the [View loaded paper](#) key.
3. Try changing to a heavier paper type, such as HP Heavyweight Coated Paper, HP Super Heavyweight Coated Paper or Digital Fine Art paper.
4. If you are using glossy paper, try changing to a different type of glossy paper.
5. Select the custom print-quality options in the driver dialog (Mac OS Print dialog), and turn on the **More passes** option.
6. Align the printheads. See [Align the printheads on page 142](#).

The Image Diagnostics Print

The Image Diagnostics Print consists of patterns designed to highlight printhead reliability problems. It helps you to check the performance of the printheads that are currently installed in your printer, and whether any printhead suffers from clogging or other problems.

To print the Image Diagnostics Print:

1. Use the same paper type that you were using when you detected a problem.
2. Use the [View loaded paper](#) key on the front panel to check that the selected paper type is the same as the paper type loaded into the printer.
3. At the printer's front panel, select the Image Quality Maintenance menu icon , then **Print diagnostic image**.

It takes about two minutes to print the Image Diagnostics Print.

The print is divided into two parts, both of which test printhead performance.

- Part 1 (top) consists of rectangles of pure colors, one for each printhead. This part represents the print quality that you will get from each color.
- Part 2 (bottom) consists of small dashes, one for each nozzle on each printhead. This part complements the first, and aims more specifically to detect how many faulty nozzles each printhead has.

Please look carefully at the print. The names of the colors are shown above the rectangles and in the center of the patterns of dashes.

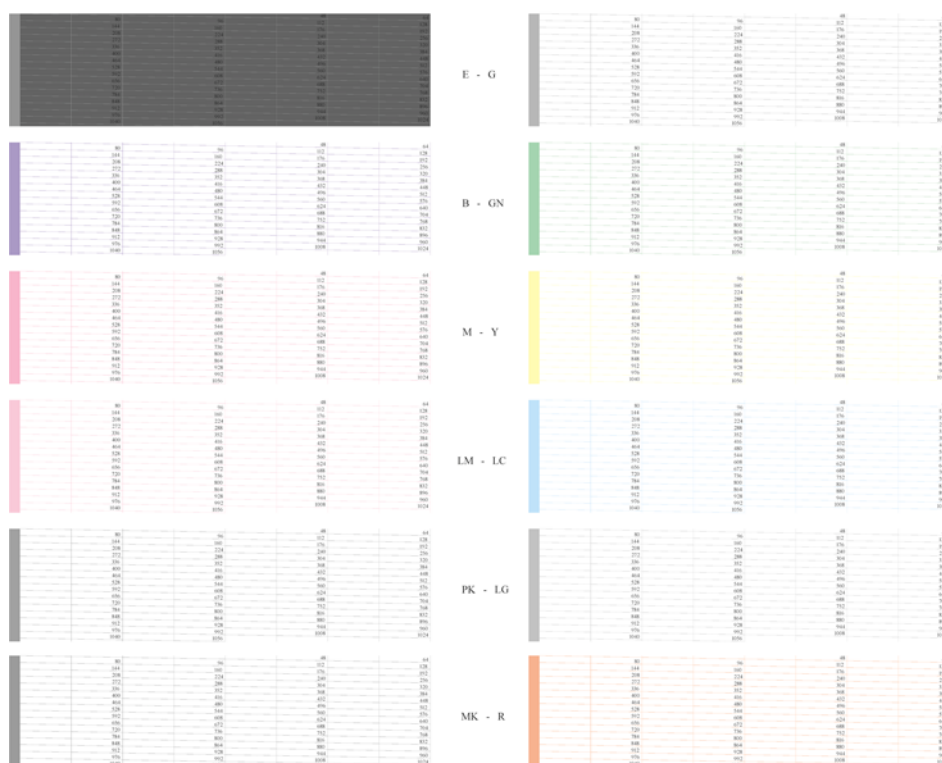
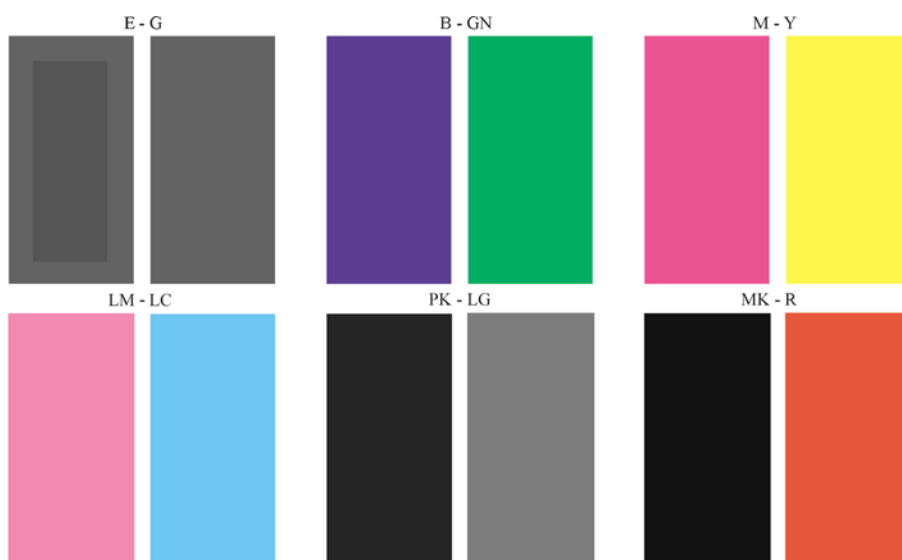

First look at the upper part of the print (part 1). Each colored rectangle should be a uniform color without any horizontal lines across it.

Then look at the bottom part of the print (part 2). For each individual colored pattern, check that most of the dashes are present.

If you see horizontal lines in part 1 and also missing dashes in part 2 for the same color, the printhead responsible needs cleaning. However, if the rectangles look solid, do not worry about just a few missing dashes in part 2; these are acceptable because the printer can compensate for a few clogged nozzles.

Here is an example of a light gray printhead in a good state:

LG

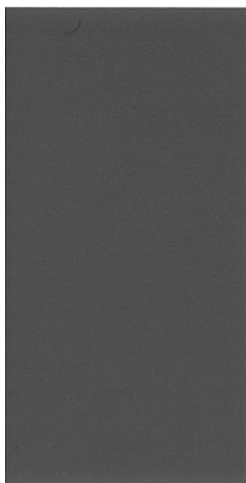

And here is an example of the same printhead in a bad state:

LG

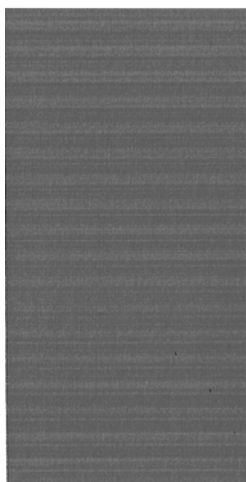

The gloss enhancer (E) cannot be seen when printed on its own, because it is a clear fluid. To make it visible in the Image Diagnostics Print, it is printed over gray ink (G).

- In part 1 (top), the gloss enhancer is seen as a slightly different gray inner section of a gray rectangle. On some papers the inner section may look darker, on other papers it may look lighter.
- In part 2 (bottom), the small dashes of gloss enhancer, one for each nozzle of the printhead, are seen as small lighter gray dashes on top of a gray area.

On most plain and coated papers the gloss enhancer can barely be seen, so such papers are not suitable for troubleshooting the gloss enhancer.

Corrective action

1. Clean any faulty printheads (see [Clean the printheads on page 139](#)). Then reprint the Image Diagnostics Print to see whether the problem has been solved.
2. If the problem remains, clean the printheads again, and reprint the Image Diagnostics Print to see whether the problem has been solved.
3. If the problem remains, consider cleaning your printheads manually (see [Clean the printheads on page 139](#)). You could also try reprinting your current print job, in case it now prints satisfactorily.

4. If the problem remains, try cleaning the printhead drop detector. The printer normally notifies you when this is necessary, but it may be worth trying even if the printer has not suggested it. See [Clean the printhead drop detector on page 140](#).
5. If the problem still remains, replace any persistently faulty printheads (see [Handling ink cartridges and printheads on page 81](#)), or contact HP Support (see [Contact HP Support on page 154](#)).

If you still have a problem

If you still experience print-quality problems after applying the advice in this chapter, here are some further things that you can do:

- Try using a higher print-quality option. See [Printing on page 42](#).
- Check the driver you are using to print with. If it is a non-HP driver, consult the driver vendor about the problem. You could also try using the correct HP driver, if feasible. The latest HP drivers can be downloaded from <http://www.hp.com/go/z3200/drivers/>.
- If you are using a non-HP RIP, its settings may be incorrect. See the documentation that came with the RIP.
- Check that your printer's firmware is up to date. See [Update the firmware on page 98](#).
- Check that you have the right settings in your software application.

13 Troubleshooting ink cartridge and printhead issues

- [Cannot insert an ink cartridge](#)
- [Ink cartridge status messages](#)
- [Cannot insert a printhead](#)
- [The front-panel display recommends reseating or replacing a printhead](#)
- [Clean the printheads](#)
- [Clean the printhead drop detector](#)
- [Align the printheads](#)
- [Printhead status messages](#)

Cannot insert an ink cartridge

1. Check that you have the correct type of cartridge (model number).
2. Check that the colored label on the cartridge is the same color as the label on the slot.
3. Check that the cartridge is correctly oriented, with the letter or letters marking the cartridge label right-side up and readable.

△ **CAUTION:** Never clean inside the ink cartridge slots.

Ink cartridge status messages

These are the possible ink cartridge status messages:

- **OK:** The cartridge is working normally, with no known problems.
- **Missing:** There is no cartridge present, or it is not correctly connected to the printer.
- **Low:** The ink level is low.
- **Very low:** The ink level is very low.
- **Empty:** The cartridge is empty.
- **Reseat:** You are recommended to remove the cartridge and then reinsert it.
- **Replace:** You are recommended to replace the cartridge with a new cartridge of the correct type for your printer.
- **Altered:** There is something unexpected about the cartridge's status.
- **Expired:** It is past the cartridge's expiration date.

Cannot insert a printhead

1. Check that you have the correct type of printhead (model number).
2. Check that you have removed the two orange protective caps from the printhead.
3. Check that the colored label on the printhead is the same color as the label on the slot.
4. Check that the printhead is correctly oriented (compare with the others).

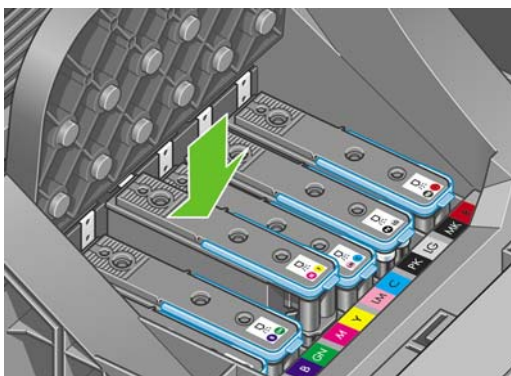

5. Check that you have correctly closed and latched the carriage lid, see [Insert a printhead on page 88](#).

The front-panel display recommends reseating or replacing a printhead

1. From the front panel, turn the power off then on.
2. Check the front-panel display message, if it shows the ready message, the printer is ready to print. If the problem remains continue with the next step.
3. Remove the printhead, see [Remove a printhead on page 86](#).
4. Clean the electrical connections on the backside of the printhead with a lint-free cloth. You can carefully use de-ionized or distilled water if moisture is needed to remove residue. Do not use water.

△ **CAUTION:** This is a delicate process and may damage the printhead. Do not touch the nozzles on the bottom side of the printhead.

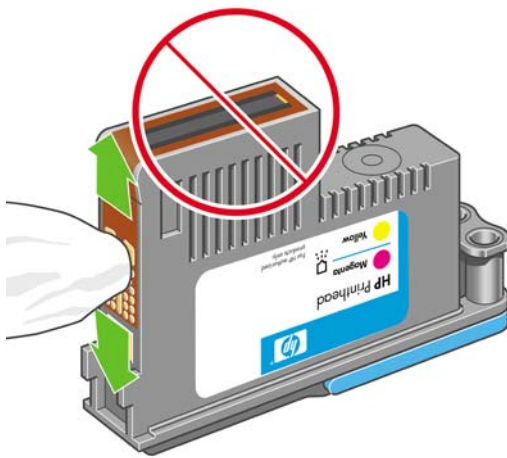

5. Reinsert the printhead, see [Insert a printhead on page 88](#).
6. Check the front-panel display message. If the problem remains, try a new printhead.

Clean the printheads

As long as the printer is kept turned on, an automatic cleaning is performed periodically. This ensures there is fresh ink in the nozzles and prevents nozzle clogs, which ensures color accuracy. If you have not already done so, please see [The Image Diagnostics Print on page 133](#) before proceeding.

To clean the printheads, go to the front panel and select the Image Quality Maintenance menu icon



, then **Clean printheads**. If you have gone through the Image Quality Diagnostic print process, you know which colors are failing. Select to the pair of printheads which contain the failing colors. If you are not sure which colors to clean, you can also select to clean all printheads. Cleaning all printheads takes about 12 minutes. Cleaning a single pair of printheads takes about six minutes.

📄 **NOTE:** Cleaning all printheads uses more ink than cleaning a single pair.

If you have cleaned the printheads using the **Clean printheads** procedure from the front panel and are still experiencing image quality problems, you can try cleaning the printhead nozzles manually using the following procedure.

△ **CAUTION:** This is a delicate process and may damage the printhead. Do not touch the electrical connections on the backside of the printhead.

First, remove the printhead (see [Remove a printhead on page 86](#)) and then use a lint-free cloth to clean the bottom of the printhead until the residue is removed.

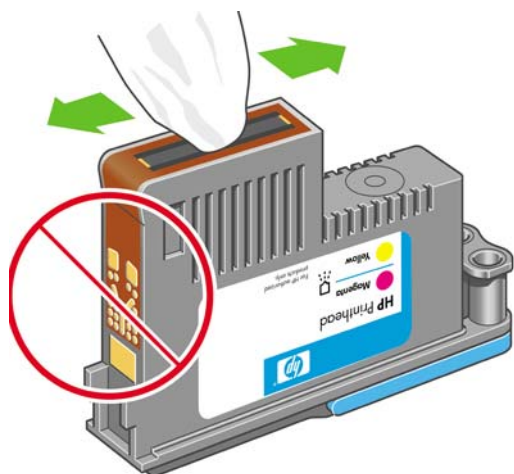

Clean the printhead drop detector

The printhead drop detector is a sensor that detects which nozzles on the printheads are not printing in order to substitute them for good printing nozzles. If particles, such as fibers, hair or paper pieces, block the sensor print quality is affected.

When the front panel displays a warning message that the clean process is needed, you are recommended to clean the printhead drop detector. If you do not clean the printhead drop detector immediately, the printer continues working normally, however, the front panel display continues to show the warning.

 **TIP:** Wear gloves to avoid getting ink on your hands.

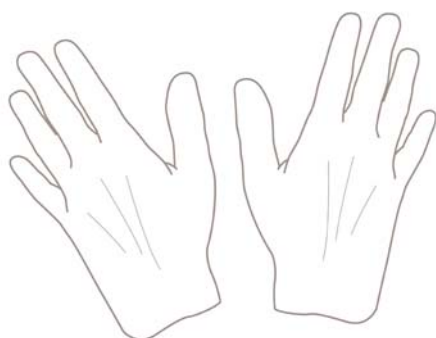

1. Turn off the printer at the front panel.



2. To avoid an electric shock, switch the printer off and unplugged it.

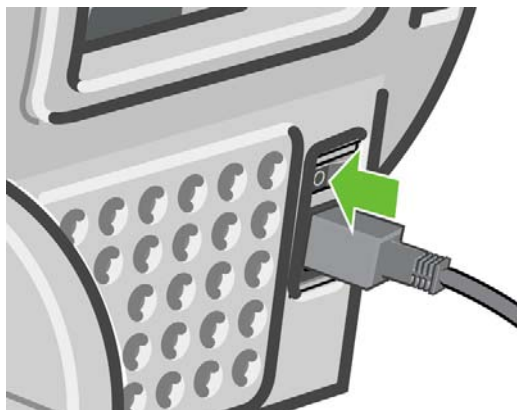

3. Open the transparent window.

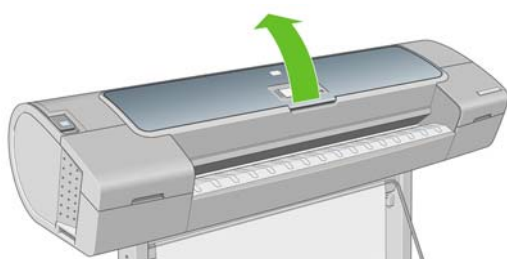

4. Find the printhead drop detector beside the stored printhead carriage.

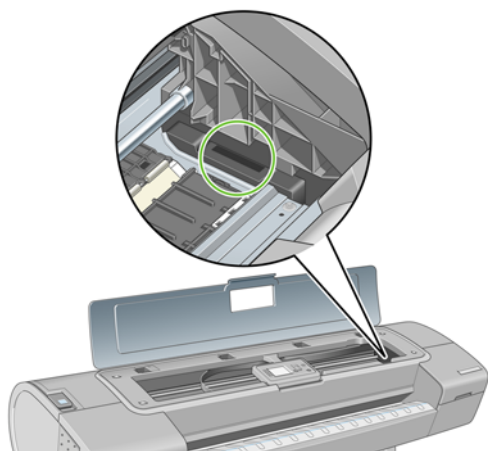

5. Remove any debris blocking the printhead drop detector.

6. With a dry lint-free cloth, wipe the surface of the drop detector to remove any non-visible debris.

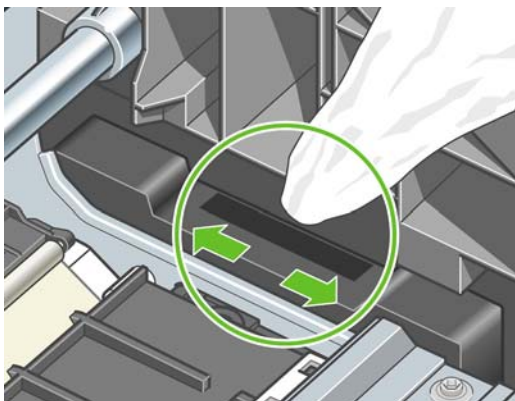

7. Close the window.

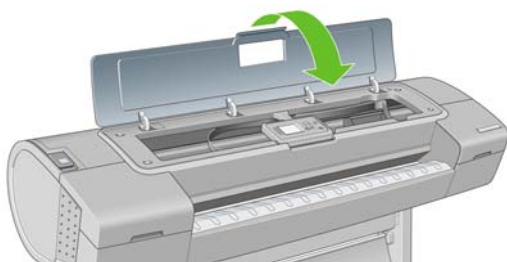

8. Plug in and switch on the printer.

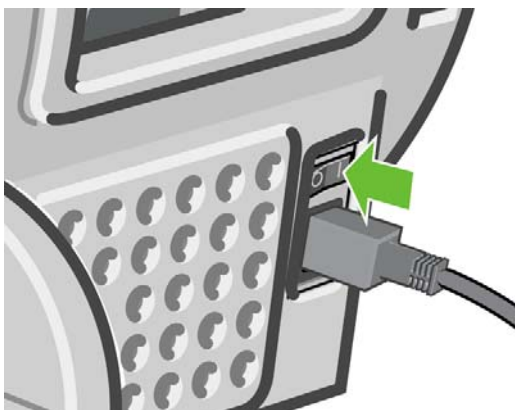



9. Power the printer on at the front panel.



Align the printheads

Precise alignment between printheads is essential for accurate colors, smooth color transitions and sharp edges in graphical elements. Your printer has an automatic printhead alignment process which runs whenever a printhead has been accessed or replaced.

In cases where the paper has jammed, you have used a custom paper or are experiencing problems with color accuracy (see [Color management on page 53](#)); you may need to align the printheads.

 **NOTE:** If the paper has jammed, it is recommended that you reinsert the printheads and initiate the realignment procedure with the Image Quality Maintenance menu .

 **TIP:** Photo paper is recommended for the best quality; plain, bond and thin coated papers provide acceptable but marginal results.

Do not use transparent or semi-transparent paper to align the printheads.

Reinsert printheads procedure

1. If the realignment process is running and the wrong paper is loaded, press the **Cancel** key on the front panel.

Do not print if the realignment process has been canceled. You can restart the alignment with the Image Quality Maintenance menu procedure.

2. Load the paper you wish to use, see [Paper handling on page 22](#). You can use a roll or cut sheet, however, it must be A3 landscape or larger (420 by 297 mm). Photo paper is recommended for the best results.

 **NOTE:** If you are using an A3 cut sheet, ensure it is loaded so the larger side feeds into the printer.

Do not use transparent or semi-transparent paper to align the printheads.

3. Remove and re-insert all the printheads, see [Remove a printhead on page 86](#) and [Insert a printhead on page 88](#). This starts the printhead alignment procedure.
4. Ensure the transparent window is closed, as a strong light source near the printer during printhead realignment can affect alignment.

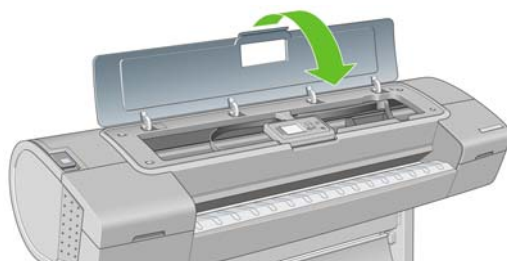

5. The process takes about six minutes. Wait until the front-panel display shows the process complete before using the printer.



 **NOTE:** The printer prints a calibration image. Do not worry about the image. The front-panel display shows any errors in the process.

Image Quality Maintenance menu procedure

1. Load the paper you wish to use, see [Paper handling on page 22](#). You can use a roll or cut sheet, however, it must be A3 landscape or larger (420 by 297 mm). Photo paper is recommended for the best results; plain, bond and thin coated papers provide acceptable but marginal results.

 **NOTE:** If you are using an A3 cut sheet, ensure it is loaded so the larger side feeds into the printer.

Do not use transparent or semi-transparent paper to align the printheads.

2. From the front panel, select the Image Quality Maintenance menu icon , then **Align printheads**. The printer checks to see if it has enough paper to run the realignment.

3. If the loaded paper is satisfactory, the printer runs the realignment and prints a realignment pattern. Ensure the transparent window is closed, as a strong light source near the printer during printhead realignment can affect alignment.

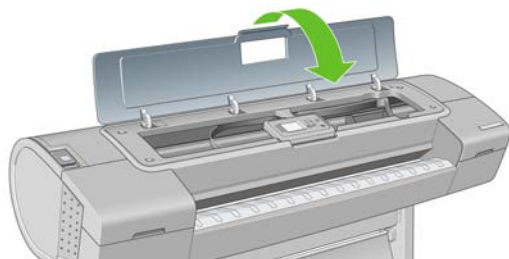

4. The process takes about six minutes. Wait until the front-panel display shows the process complete before using the printer.

Scanning errors during alignment

If the alignment process fails, a 'Scanning problems' message appears on the front panel. This means that the alignment has not completed successfully. Therefore the printer is not aligned and the alignment should be repeated before printing with good image quality. The problem may be due to:

- The paper used was not valid, repeat the alignment with valid paper
- Printhead health problems, clean printheads, see [Clean the printheads on page 139](#)
- The alignment was done with the transparent window open, repeat the alignment with the window closed

If the problem persists after using valid paper, cleaning the printheads and keeping the window closed, there may be a failure in the scanning system needing reparation or the printheads, although clean, may not work and need to be replaced.

Printhead status messages

These are the possible printhead status messages:

- **OK:** The printhead is working normally, with no known problems
- **Missing:** There is no printhead present, or it is not correctly installed in the printer.
- **Test printhead separately:** You are recommended to test the printheads individually to find the failing printhead. Remove all the printheads and insert them alone one by one, closing the latch and the carriage lid after every insertion. The front-panel display indicates the failing one showing the reset or replace message.
- **Reseat:** You are recommended to remove the printhead and then reinsert it. If that fails, clean the electrical connections, see [The front-panel display recommends reseating or replacing a printhead on page 139](#). If that fails, replace the printhead with a new printhead, see [Remove a printhead on page 86](#) and [Insert a printhead on page 88](#).
- **Replace:** The printhead is failing. Replace the printhead with a working printhead of the correct type for your printer, see [Remove a printhead on page 86](#) and [Insert a printhead on page 88](#).
- **Replacement incomplete:** A printhead replacement process has not completed successfully, re-launch the replacement process and let it finish completely (it is not needed to change the printheads).
- **Remove:** The printhead is not a suitable type for use in printing.

14 Troubleshooting general printer issues

- [The printer does not print](#)
- [The printer seems slow](#)
- [Communication failures between computer and printer](#)
- [Cannot access the HP Printer Utility](#)
- [Some Color Center options are unavailable](#)
- [Cannot access the Embedded Web Server](#)
- [Automatic file system check](#)
- [No output when printing from Microsoft Visio 2003](#)
- [Unavailable driver features when printing from QuarkXPress](#)
- [Printer alerts](#)

The printer does not print

If all is in order (paper loaded, all ink components installed and no file errors), there are still reasons why a file you have sent from your computer may not start printing when expected:

- You may have an electrical power problem. If there is no activity at all from the printer, and the front panel does not respond, check that the power cable is connected correctly and that there is power available at the socket.
- You may be experiencing unusual electromagnetic phenomena, such as strong electromagnetic fields or severe electrical disturbances, which can cause the printer to behave strangely or even stop working. In this case, turn off the printer using the **Power** key on the front panel and unplug the power cord, wait until the electromagnetic environment has returned to normal, then turn it on again. If you still experience problems, please contact your customer service representative.
- You may not have installed in your computer the correct driver for your printer; see the *Assembly instructions*.
- If you are printing on a sheet, you should specify sheet as the paper source.
- You may have requested a print preview from your printer driver. This is a function you can use to check that the image is the one you want. In this case, the preview is displayed on your screen, and you must click the **Print** button to start printing.

The printer seems slow

Here are some possible explanations.

- Did you set the print quality to Best or Max Detail? Best-quality and maximum detail prints take longer as they require more passes.
- Did you specify the correct paper type when loading the paper? Photo and coated papers require more drying time between passes. To find out the printer's current paper type setting, see [View information about the paper on page 34](#). Some paper types require more time for printing.
- Do you have a network connection to your printer? Check that all components used in the network (network interface cards, hubs, routers, switches, cables) are capable of high-speed operation. Is there a lot of traffic from other devices on the network?
- Did you specify Extended drying time in the front panel? Try changing the drying time to Optimal.

Communication failures between computer and printer

Some symptoms are:

- The front-panel display does not show the **Receiving** message when you have sent an image to the printer.
- Your computer displays an error message when you are trying to print.
- Your computer or printer hangs (stays idle), while communication is taking place.
- Your printed output shows random or inexplicable errors (misplaced lines, partial graphics, etc.).



To solve a communication problem:

- Ensure that you have selected the correct printer in your application, see [Printing on page 42](#).
- Ensure that the printer works correctly when printing from other applications.
- Remember that very large prints may take some time to receive, process and print.

- If the printer is connected to a network, try using it when connected directly to your computer through a USB cable.
- If your printer is connected to your computer through any other intermediate devices, such as switch boxes, buffer boxes, cable adapters, cable converters, etc., try using it when connected directly to your computer.
- Try another interface cable.
- If the printer is connected with a USB, try to disconnect and reconnect the USB cable with the computer. Check that the USB cable is of good quality.

Cannot access the HP Printer Utility

If you have not done so already, please read [Access the HP Printer Utility on page 19](#).

1. From the front panel, select the Connectivity menu icon .
2. Select **Advanced > Web Services > Printer Utility Software > Enable**.
3. If you have a TCP/IP connection to your printer, select the Connectivity menu icon  again.
4. Select the type of connection you are using.
5. Select **View Information** and check that the printer has IP enabled and a valid IP address.

If you still cannot connect, switch the printer off and back on with the **Power** key on the front panel.

Some Color Center options are unavailable



If you see that some options are unavailable in the Color Center under Mac OS, this could be because you did not install the printer queue to print to that printer, but searched for the printer directly in the HP Printer Utility Printer Selector Screen, by going to **More Printers** or **Add Manually**.

If this is the case, you will see a green circle in the Printer Selector beside the name of your printer. If you see a green small house, then the printer is correctly configured to print and all options will be available.

Cannot access the Embedded Web Server

If you have not done so already, please read [Access the Embedded Web Server on page 19](#).

 **NOTE:** If you connect directly to your printer with a USB cable, use the HP Printer Utility.

1. From the front panel, select the Connectivity menu icon .
2. Select **Advanced > Allow EWS > On**.
3. If you have a TCP/IP connection to your printer, select the Connectivity menu icon  again.
4. Select the type of connection you are using.
5. Select **View Information**.
6. Ensure that you see IP enabled. If not, you may need to use a different connection.

If you are using a proxy server, try bypassing the server and accessing the Web server directly.

- In Internet Explorer 6 for Windows, go to **Tools > Internet Options > Connections > LAN Settings**, and check the **Bypass proxy server for local addresses** box. Alternatively, for more precise control, click the **Advanced** button and add the printer's IP address to the list of exceptions, for which the proxy server is not used.
- In Safari for Mac OS, go to **Safari > Preferences > Advanced** and click the **Proxies: Change Settings** button. Add the printer's IP address or its domain name to the list of exceptions, for which the proxy server is not used.

If you still cannot connect, switch the printer off and back on with the **Power** key on the front panel.

Automatic file system check

When you turn on the printer, you will occasionally see a front panel display similar to the one shown below.

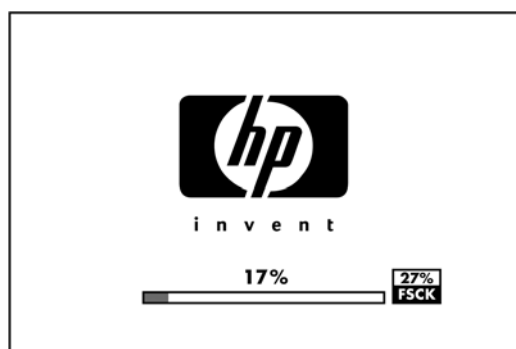

A file system check is taking place; it can take up to 40 minutes. Please wait until it finishes.

- △ **CAUTION:** If you turn the printer off before the file system check has finished, the file system could be seriously damaged, making the printer's hard disk unusable. In any case, the file system check will restart from the beginning whenever you turn the printer on again.

A file system check is scheduled every 90 days, in order to maintain the hard disk's file system integrity.

No output when printing from Microsoft Visio 2003

For more information about problems when printing large images (more than 129 inches long) from Microsoft Visio 2003, see Microsoft's online knowledge base (<http://support.microsoft.com/search/>).

To avoid these problems, it is possible to scale the image down in Visio to a size shorter than 129 inches and then to scale the drawing up in the driver by using the **Scale to** options in the Effects tab of the Windows driver. If the down-scaling in the application and the up-scaling in the driver match, the result is as originally intended.

Unavailable driver features when printing from QuarkXPress

When you print from QuarkXPress, the following driver features are not available.

- Print Preview
- Rotation
- Scaling

- Office features or paper saving options
- Back to front printing

To get the same results, use the equivalent features available in QuarkXPress.

Printer alerts

Your printer can communicate are two types of alerts:

- **Errors:** Mainly alerting you to the fact that the printer is unable to print. However, in the driver, errors can also alert you to conditions that could ruin the print, such as clipping, even if the printer is able to print.
- **Warnings:** Alert you when the printer needs attention either for an adjustment, such a calibration or for a possible unprintable situation, such a preventive maintenance or low ink.

There are three different alerts communicators within your printer's system.

- **Embedded Web Server:** The upper-right corner of the EWS screen shows the Printer status. If there is an alert in the printer, the status shows the alert text. Both the front-panel display and the EWS show the same alert.
- **Driver:** The driver shows alerts. The driver warns about job configuration settings that may produce a problem in the final output. If the printer is not ready to print, it displays a warning.
- **HP Printer Utility:** In the HP Printer Utility for Windows, alerts are displayed in the **Items needing attention** pane in the **Overview** tab. In the HP Printer Utility for Mac OS, alerts are displayed at the bottom of the **HP Printer Monitor** panel. In these areas you can find the following:
 - Printer status
 - Alerts when the printer cannot print a job
 - Print-quality and general troubleshooting links
 - Firmware update notices
 - Maintenance tools, like color calibration
 - Access to the job accounting and printer usage information
 - Access to some printer settings as well as the network settings.

By default alerts are only displayed when you are printing and there are printing problems. For example: cartridge low or out of ink or printer out of paper. If alerts are enabled and there is a problem that prevents printing, you see a pop-up window, which explains why the printer is not going to print. Follow the on-screen instructions to achieve your required result.

You can configure these alerts as desktop alerts as well.

- Using the HP Printer Utility for Windows, alert settings can be accessed from the **Overview** tab, from the **Support** tab and from **Tools**. There is also an **Alert Settings** link in each alert dialog box. Alerts can be completely disabled by setting them to **Off** in the Alert Settings window. You can choose to receive alerts only when printing to the printer (default) or any time a problem occurs. You can also set the alert method: pop-up dialog (default) or desktop alert.
- Using the HP Printer Utility for Mac OS, alert settings can be accessed by selecting **HP Printer Monitor > Preferences > Notification**.

15 Front-panel error messages

Occasionally you may see one of the following messages appear on the front-panel display. If so, please follow the advice in the Recommendation column.

If you see an error message that does not appear here, and you feel in doubt about the correct response, contact HP Support. See [Contact HP Support on page 154](#).

Table 15-1 Text messages

Message	Recommendation
[Color] cartridge has expired	Replace the cartridge. See Handling ink cartridges and printheads on page 81 .
[Color] cartridge is missing	Insert a cartridge of the correct color. See Handling ink cartridges and printheads on page 81 .
[Color] cartridge is out of ink	Replace the cartridge. See Handling ink cartridges and printheads on page 81 .
[Color] printhead #[n] error: not present	Insert the correct printhead. See Handling ink cartridges and printheads on page 81 .
[Color] printhead #[n] error: please remove	Remove the incorrect printhead and insert a new printhead of the correct type (color and number). See Handling ink cartridges and printheads on page 81 .
[Color] printhead #[n] error: replace	Remove the non-functional printhead and insert a new printhead. See Handling ink cartridges and printheads on page 81 .
[Color] printhead #[n] error: reseal	Remove and reinsert the same printhead, or try cleaning the electrical connections. If necessary, insert a new printhead. See The front-panel display recommends reseating or replacing a printhead on page 139 .
[Color] printhead #[n] out of warranty	The printhead's warranty has ended, because of the length of time it has been in operation or because of the volume of ink used. See <i>Legal Information</i> .
[Color] printhead #[n] warranty warning	The printhead's warranty may be invalidated by the use of the wrong kind of ink. See <i>Legal Information</i> .
IO error	Restart the printer. If the problem persists, contact HP Support. See Contact HP Support on page 154 .
IO warning	Try again; if the problem persists, contact HP Support. See Contact HP Support on page 154 .
Paper advance calibration pending	Perform paper advance calibration. See Recalibrate the paper advance on page 118 .
Paper too small to print paper advance calibration	Unload paper and load larger paper.
Paper too small to scan paper advance calibration	Unload paper and load larger paper.
Printhead alignment error: paper too small	Unload paper and load larger paper.

Table 15-1 Text messages (continued)

Message	Recommendation
Replace [color] cartridge	Replace the cartridge. See Handling ink cartridges and printheads on page 81 .
Reseat [color] cartridge	Remove and reinsert the same cartridge. See Handling ink cartridges and printheads on page 81 .
Update: failed. Invalid file	Make sure that you have selected the correct firmware update file. Then try again to perform the update.

Table 15-2 Numerical error codes

Error code	Recommendation
52:01	The printer needs internal cleaning. See Clean the printhead drop detector on page 140 . If the problem persists, contact HP Support. See Contact HP Support on page 154 .
61:01	The file format is wrong and the printer cannot process the job. The printer expects jobs to be sent in PCL3 format.
62, 63, 64, 65, 67	Check that the printer cables are well connected and the USB cable is of good quality. Try again to print the same file. Make sure you are using the correct driver for your printer. Update your printer's firmware. See Update the firmware on page 98 .
74.1	Try the firmware update again. If possible, try to update over a network if the USB update failed. Do not try to use your computer while the update is in progress. If the problem persists, contact HP Support. See Contact HP Support on page 154 .
75	A printer maintenance kit is required. See Printer maintenance kits on page 99 .
78	You may be trying to print borderless on a paper type that does not support it. See Print with no margins on page 49 .
79	Restart the printer. If the problem persists, update your printer's firmware. See Update the firmware on page 98 . If the problem still persists, contact HP Support. See Contact HP Support on page 154 .
81, 86, 87	There may be a paper jam. See The paper has jammed on page 115 . If the problem persists, contact HP Support. See Contact HP Support on page 154 .
94, 94.1	Restart color calibration. See Color calibration on page 60 .
98	There may be a printhead problem. See Troubleshooting ink cartridge and printhead issues on page 137 .
any other codes	Restart the printer. If the problem persists, contact HP Support. See Contact HP Support on page 154 .

16 HP Customer Care

- [Introduction](#)
- [HP Professional Graphics Services](#)
- [HP Proactive Support](#)
- [Contact HP Support](#)

Introduction

HP Customer Care offers award-winning support to ensure you get the most from your HP Designjet, providing comprehensive, proven support expertise and new technologies to give you unique end-to-end support. Services include setup and installation, troubleshooting tools, warranty upgrades, repair and exchange services, phone and Web support, software updates and self-maintenance services. To find out more about HP Customer Care, please visit us at:

<http://www.hp.com/go/graphic-arts/>

or call us on the telephone (see [Contact HP Support on page 154](#)). To register your warranty:

<http://register.hp.com/>

HP Professional Graphics Services

For further information on all the services described in this section, please visit <http://www.hp.com/go/pgs/>.

Knowledge Center

Enjoy a world of dedicated services and resources to ensure you always get the best performance from your HP Designjet products and solutions.

Join the HP community at the Knowledge Center, your large-format printing community at <http://www.hp.com/go/z3200/knowledgecenter/> for 24×7 access to:

- Multimedia tutorials
- Step-by-step how-to guides
- Downloads — the latest printer firmware, drivers, software, paper presets, etc.
- Technical support — online troubleshooting, customer care contacts and more
- Workflows and detailed advice for completing various printing tasks from particular software applications
- Forums for direct contact with the experts, both HP and your colleagues
- Warranty tracking online, for your peace of mind
- Latest product information — printers, supplies, accessories, software, etc.
- Supplies Center for all you need to know about ink and paper

By customizing your registration for the products you have purchased and your type of business, and by setting your communication preferences, you decide the information you need.

HP Start-Up Kit

The HP Start-Up Kit is the CD that comes with your printer; it contains the printer's software.

HP Care Packs and Warranty Extensions

If you would like to extend your printer's warranty beyond the standard period, two methods are available.

- An HP Care Pack provides support for a three-year period. You can buy it when you buy the printer, or for a short time afterwards.
- A one-year Warranty Extension can be bought at any time.

HP Care Packs and Warranty Extensions include remote support. On-site service is also provided if necessary, with two alternative response-time options.

- Next business day
- Same business day, within four hours (may not be available in all countries)

For more information on HP Care Packs, please visit <http://www.hp.com/go/lookuptool/>.

HP Installation

The HP Installation service unpacks, sets up and connects the printer for you.

This is one of the HP Care Pack services; for more information, please visit <http://www.hp.com/go/lookuptool/>.

HP Proactive Support

HP Proactive Support helps reduce costly printer downtime by preemptively identifying, diagnosing and resolving printer issues before they become problems for you. HP's Proactive Support tool is designed to help businesses of all sizes reduce support costs and maximize productivity—all with the click of a mouse.

A component of the HP Imaging and Printing suite of services, Proactive Support helps you gain control of your printing environment—with a clear focus on maximizing the value of your investment, increasing printer uptime and reducing printer management costs.

HP recommends that you enable Proactive Support right away to save you time and prevent problems before they occur, reducing costly downtime. Proactive Support runs diagnostics and checks for software and firmware updates.

You can enable Proactive Support in the HP Printer Utility, where you can specify the frequency of connections between your computer and HP's Web server, and the frequency of diagnostic checks. You can also choose to run the diagnostic checks at any time.

- Under Windows, there are two ways of accessing HP Proactive Support from the HP Printer Utility.
 - Select **Tools > HP Proactive Support**.
 - Click near the bottom of the window where you see the text **HP Proactive Support is disabled on your system**.
- Under Mac OS, select **Information > Printer Status > Printer Details**. The HP Printer Monitor will open. Select **Preferences > Monitoring > HP Proactive Support**.

If Proactive Support finds any potential problem, it notifies you with an alert, which will explain the problem and recommend a solution. In some cases, the solution may be applied automatically; in other cases, you may be asked to perform some procedure to solve the problem.

See also [Access the HP Printer Utility on page 19](#).

Contact HP Support

HP Support is available to you by telephone. What to do before you call:

- Review the troubleshooting suggestions in this guide.
- Review the relevant driver documentation.

- If you have installed third-party software drivers and RIPs, see their documentation.
- If you call one of the Hewlett-Packard offices, please have the following information available to help us answer your questions more quickly:
 - The printer you are using (the product number and the serial number, found on the label at the back of the printer)
 - If there is an error code on the front panel, note it down; see [Front-panel error messages on page 150](#)
 - The printer's Service ID: at the front panel, select the Information menu icon , then **View printer information**
 - The computer you are using
 - Any special equipment or software you are using (for example, spoolers, networks, switch-boxes, modems or special software drivers)
 - The cable you are using (by part number) and where you purchased it
 - The type of interface used on your printer (USB or network)
 - The software name and version you are currently using
 - If possible, print out the following reports; you may be asked to fax them to the support center helping you: Configuration, Usage Report and "all pages above" from Service Information (see [The printer's internal prints on page 7](#))

Telephone number

Your HP Support telephone number is available on the Web: please visit http://welcome.hp.com/country/us/en/wwcontact_us.html.

17 Printer specifications

- [Functional specifications](#)
- [Physical specifications](#)
- [Memory specifications](#)
- [Power specifications](#)
- [Ecological specifications](#)
- [Environmental specifications](#)
- [Acoustic specifications](#)

Functional specifications

Table 17-1 HP 70 ink supplies

Printheads	Two inks in each printhead: gloss enhancer and gray, blue and green, magenta and yellow, light magenta and light cyan, photo black and light gray, and matte black and red
Ink cartridges	Cartridges containing 130 ml of ink: gloss enhancer, gray, blue, green, magenta, yellow, light magenta, light cyan, photo black, light gray, matte black, and red

Table 17-2 Paper sizes

	Minimum	Maximum
Roll width	11 inches (279 mm)	24-inch printer: 24 inches (609 mm) 44-inch printer: 44 inches (1118 mm)
Roll length		300 feet (91.4 m)
Sheet width	8.3 inches (210 mm, A4 Portrait)	24-inch printer: 24 inches (609 mm) 44-inch printer: 44 inches (1118 mm)
Sheet length	11 inches (279 mm, Letter Portrait)	24-inch printer: 36 inches (915 mm) 44-inch printer: 66 inches (1676 mm)

Table 17-3 Printing resolutions

Print quality	Maximum detail	Extra passes	Rendering resolution (ppi)	Printing resolution (dpi)
Best	On	On	600 × 600	2400 × 1200 (glossy & satin paper only)
	On	Off	600 × 600	1200 × 1200
	Off	On	600 × 600	1200 × 1200
	Off	Off	600 × 600	1200 × 1200
Normal	On		600 × 600	1200 × 1200
	Off		600 × 600	1200 × 1200
	Off		300 × 300	1200 × 1200
Fast	On		600 × 600	1200 × 1200
	Off		600 × 600	1200 × 1200
	Off		300 × 300	1200 × 1200

Table 17-4 Margins

Top right and left margins	5 mm = 0.2 inches
Bottom margin (trailing edge)	5 mm = 0.2 inches (roll) 17 mm = 0.67 inches (sheet)

 **NOTE:** Printing without margins is possible with glossy and satin paper types.

Table 17-5 Mechanical accuracy

±0.2% of the specified vector length or ±0.3 mm (whichever is greater) at 23°C (73°F), 50-60% relative humidity, on E/A0 printing material in Best or Normal mode with HP Matte Film roll feed.

Table 17-6 Graphic languages supported

HP Designjet Z3200 Photo Printer	HP-PCL3 GUI
----------------------------------	-------------

Table 17-7 Operating systems supported

Apple Mac OS X	10.4 and later versions
Microsoft Windows	XP and later versions

Physical specifications

Table 17-8 Printer physical specifications

	24 inch printer	24 inch printer (without stand)	44 inch printer
Weight	143 lb (65 kg)	103.6 lb (47 kg)	189 lb (86 kg)
Width	49.7 inches (1262 mm)	49.7 inches (1262 mm)	69.7 inches (1770 mm)
Depth	Minimum: 26 inches (661 mm) Maximum: 28.8 inches (732 mm)	Minimum: 26 inches (661 mm) Maximum: 28.8 inches (732 mm)	Minimum: 26 inches (661 mm) Maximum: 28.8 inches (732 mm)
Height	41.2 inches (1047 mm)	15.4 inches (391 mm)	41.2 inches (1047 mm)

Memory specifications

Table 17-9 Memory specifications

Memory (DRAM) supplied	256 MB
Hard disk	80 GB

Power specifications

Table 17-10 Printer power specifications

Source	100–240 V ac ±10%, auto-ranging
Frequency	50–60 Hz
Current	< 2 A
Consumption	< 200 W

Ecological specifications

For the up-to-date ecological specifications of your printer, please go to <http://www.hp.com/> and search for “ecological specifications”.

Environmental specifications

Table 17-11 Printer environmental specifications

	Temperature range	Humidity range
Operating for optimal print quality	22°C to 26°C (72°F to 79°F)	30% to 60%
Operating for standard printing	15°C to 35°C (59°F to 95°F)	20% to 80%
Printer without consumables	5°C to 40°C (41°F to 104°F)	
Non-operating packed consumables and printer:	-40°C to 60°C (-40°F to 140°F)	

Acoustic specifications

Printer acoustic specifications (declared according to ISO 9296).

Table 17-12 Printer acoustic specifications

Idle sound power level	4.4 B (A)
Operating sound power level	6.5 B (A)
Idle sound pressure at bystander position	29 dB (A)
Operating sound pressure at bystander position	49 dB (A)

Glossary

AppleTalk A suite of protocols that Apple Computer developed in 1984 for computer networking, not supported by this printer. Apple now recommends TCP/IP networking instead.

Bonjour Apple Computer's trade name for its implementation of the IETF Zeroconf specification framework, a computer network technology used in Apple's Mac OS X from version 10.2 onwards. It is used to discover services available on a local area network. It was originally known as Rendezvous.

Color accuracy The ability to print colors that match the original image as closely as possible, bearing in mind that all devices have a limited color gamut and may not be physically capable of matching certain colors precisely.

Color consistency The ability to print the same colors from a particular print job from print to print and from printer to printer.

Color model A system of representing colors by numbers, such as RGB or CMYK.

Color space A color model in which each color is represented by a specific set of numbers. Many different color spaces can use the same color model: for instance, monitors generally use the RGB color model, but they have different color spaces, because a particular set of RGB numbers results in different colors on different monitors.

Cutter A printer component that slides back and forth across the platen to cut the paper.

ESD ElectroStatic Discharge. Static electricity is common in daily life. It is the spark when touching the car door, or the cling of clothing. Although controlled static electricity has some useful applications, uncontrolled electrostatic discharges are one of the main hazards to the electronics products. Therefore, to prevent damage some precautions are needed when setting up the product, or handling ESD sensitive devices. This type of damage may reduce the life expectancy of the device. One way to minimize uncontrolled ESDs, and therefore reduce this type of damage is by touching any exposed grounded part of the product (mainly metal parts) before handling ESD sensitive devices (such as the printheads or ink cartridges). Additionally, to reduce the generation of electrostatic charge in your body try to avoid working in a carpeted area, and keep your body movements to a minimum when handling ESD sensitive devices. Also, avoid working in low humidity environments.

Ethernet A popular computer networking technology for local area networks.

Firmware Software that controls your printer's functionality and is stored semi-permanently in the printer (it can be updated).

Gamut The range of colors and density values reproducible on an output device, such as a printer or monitor.

Gloss enhancer A clear fluid that improves gloss uniformity and eliminates bronzing as an image quality issue on photo papers. It is not used on matte papers.

I/O Input/Output: this term describes the passing of data between one device and another.

ICC The International Color Consortium, a group of companies that have agreed on a common standard for color profiles.

Ink cartridge A removable printer component that stores ink of a particular color and provides it to the printhead.

IP address A unique identifier that identifies a particular node on a TCP/IP network. It consists of four integers separated by dots.

Jetdirect HP's brand name for its series of print servers that allow a printer to be connected directly to a local area network.

LED Light-Emitting Diode: a semiconductor device that emits light when electrically stimulated.

MAC address Media Access Control address: a unique identifier used to identify a particular device on a network. It is a lower-level identifier than the IP address. Thus, a device has both a MAC address and an IP address.

Nozzle One of many tiny holes in a printhead through which ink is deposited onto the paper.

Paper A thin, flat material made to be written or printed on; most commonly made from fibers of some kind which are pulped, dried and pressed.

Paper preset A specification of the characteristics and requirements of a particular paper type.

Platen The flat surface within the printer over which the paper passes while it is being printed on.

Printer driver Software that converts a print job in a generalized format into data suitable for a particular printer.

Printhead A removable printer component that takes ink of one or more colors from the corresponding ink cartridge(s) and deposits it on the paper, through a cluster of nozzles. In the HP Designjet Z3200, each printhead prints two different colors.

Rendezvous Apple Computer's original name for its networking software later known as Bonjour.

Spindle A rod that supports a roll of paper while it is being used for printing.

TCP/IP Transmission Control Protocol/Internet Protocol: the communications protocols on which the Internet is based.

USB Universal Serial Bus: a standard serial bus designed to connect devices to computers.

Index

- A**
 - accessories
 - order 108
 - accounting
 - with costs 80
 - accounting data by E-mail 80
 - acoustic specifications 159
 - alerts 149
- B**
 - banding problems 118
 - basket
 - output problems 117
 - battery change 99
 - black and white 49
 - blurred lines 133
 - buzzer on/off 20
- C**
 - calibration
 - color 60
 - change printing properties 37
 - clean the platen 125
 - clean the printer 93
 - clipped at bottom 129
 - clipped image 129
 - color
 - calibration 60
 - color management options 65
 - color management process 59
 - color management scenarios 67
 - color profiling 61
 - colors inaccurate 128
 - communication problems 146
 - components of printer 4
 - configure 21
 - connect the printer
 - choose a method 10
 - Mac OS direct 15
 - Mac OS network 12
 - Windows direct 11
 - Windows network 10
 - contrast in front panel 21
 - core adaptors 24
 - cost accounting 80
 - create paper preset 36
 - create paper preset (advanced) 37
 - crop lines 51
 - Customer Care 153
 - cutter
 - on/off 40
 - problems 117
 - cutter, replace 93
- D**
 - delete paper preset 35
 - disk erase, secure 99
 - documentation 2
 - draft printing 47
 - Driver features
 - QuarkXPress 148
 - drying time
 - change 40
- E**
 - ecological specifications 158
 - economize on ink 52
 - economize on paper 51
 - Embedded Web Server
 - access 19
 - cannot access 147
 - ink and paper usage 79
 - language 20
 - printer usage statistics 79
 - environmental specifications 159
 - erase hard disk securely 99
 - error messages, front panel 150
- F**
 - features of printer 4
 - file system check 148
 - firmware update 98
 - front panel
 - contrast 21
 - language 19
 - units 21
 - front panel option
 - adjust paper advance 119
 - align printheads 143
 - allow EWS 147
 - calibrate color 60
 - calibrate paper advance 119
 - clean printheads 139
 - enable buzzer 20
 - enable color calibration 60
 - enable crop lines 51
 - enable cutter 40
 - ink cartridge information 82
 - internal prints 8
 - load roll 28
 - load sheet 32
 - modify configuration 21
 - move paper 39
 - print diagnostic image 133
 - printer utility software 147
 - printhead information 86
 - replace ink cartridges 83
 - replace printheads 86
 - reprint last job 49
 - reset cutter life counter 93
 - reset paper advance 119
 - rotate 50
 - select display contrast 21
 - select drying time 40
 - select I/O timeout 129
 - select language 19
 - select paper type 114
 - select units 21
 - sleep mode wait time 20
 - unload paper 29, 34
 - view configuration 12
 - view connectivity information 147
 - view loaded paper 34
 - view printer information 155
 - functional specifications 157

- G**
 - gloss enhancer 48
 - graininess 123
 - graphic languages 158
 - gray shades 49
- H**
 - hard disk specification 158
 - HP Advanced Profiling Solution 109
 - HP Care Packs 153
 - HP Customer Care 153
 - HP Installation 154
 - HP Proactive Support 154
 - HP Start-Up Kit 153
 - HP Start-Up Kit CD 2
 - HP Support 154
- I**
 - image diagnostics print 133
 - image problems
 - clipped at bottom 129
 - clipped image 129
 - missing objects 130
 - Visio 2003 148
 - import paper preset 35
 - ink cartridge
 - about 82
 - cannot insert 138
 - insert 84
 - maintenance 97
 - order 102
 - remove 82
 - specification 157
 - status 82
 - ink usage, economize 52
 - internal prints 7
- K**
 - Knowledge Center 153
- L**
 - language 19
 - line thickness 130
 - load paper
 - cannot load 112
 - general advice 23
 - roll into the printer 25
 - roll onto the spindle 23
 - sheet 30
- M**
 - maintenance kits 99
- margins
 - none 49
 - specification 157
- maximum detail 48
- mechanical accuracy 158
- memory specifications 158
- misaligned colors 131
- more passes 48
- move the printer 97
- N**
 - Network settings 21
- O**
 - operating systems 158
 - order
 - accessories 108
 - ink cartridges 102
 - paper 103
 - printheads 103
- P**
 - page size 43
 - paper
 - advance calibration 118
 - advanced preset creation 37
 - cannot load 112
 - change drying time 40
 - cut by printer 117
 - cutter on/off 40
 - cutter problems 117
 - delete preset 35
 - download presets 35
 - feed and cut 40
 - jammed 115
 - load onto the spindle 23
 - load roll into printer 25
 - load sheet 30
 - loading advice 23
 - maintenance 39
 - movement 39
 - not shown in driver 113
 - order 103
 - output problems in basket 117
 - preset creation 36
 - presets 35
 - print on loaded paper 39
 - remove cut strips 118
 - roll loose on spindle 118
 - select type 39
 - sheet stays in printer 117
 - size 43
 - types 103
 - unload roll 29
 - unload sheet 33
 - view information 34
 - paper not flat 123
 - paper sizes (max and min) 157
 - paper usage, economize 51
 - physical specifications 158
 - platen cleaning 125
 - power specifications 158
 - preview a print 46
 - print job
 - ink usage 79
 - paper usage 79
 - print preview 46
 - print quality
 - select 43
 - print with shortcuts 44
 - print-quality problems
 - banding 122
 - blurred lines 133
 - bottom of print 127
 - bronzing 127
 - discontinuous lines 132
 - edges darker than expected 126
 - edges stepped or not sharp 126
 - general 121
 - graininess 123
 - horizontal lines 122
 - ink marks 124
 - line thickness 130
 - misaligned colors 131
 - paper not flat 123
 - scratching 124
 - scuffing 124
 - stepped lines 131
 - vertical continuous lines 126
 - vertical dotted lines 125
 - vertical lines of different colors 127
 - white spots 127
 - wizard 121
 - printer does not print 146
 - printer software
 - Mac OS uninstall 16
 - Windows uninstall 12
 - printer stand 109
 - printer status 93
 - Printer Utility
 - access 19
 - cannot access 147
 - language 20
 - printer's main components 4
 - printer's main features 4

- printhead
 - about 85
 - align 142
 - cannot insert 138
 - clean; purge 139
 - insert 88
 - order 103
 - remove 86
 - replace, reseal 139
 - specification 157
 - status 86
- printhead cleaner
 - specification 157
- printhead drop detector
 - clean 140
- printing resolutions 157
- Proactive Support 154
- profiling, accessory 109

Q

- quality, high 47
- QuarkXPress, unavailable driver
 - features 148

R

- reprint a job 49
- rescale a print 45
- roll paper
 - load into the printer 25
 - load onto the spindle 23
 - unload 29
- rotating an image 50

S

- safety precautions 2
- satin photo paper 48
- scale a print 45
- scratched prints 124
- scuffed prints 124
- secure disk erase 99
- sheet paper
 - load 30
 - unload 33
- shortcuts 44
- sleep mode wait time 20
- slow printing 146
- software 7
- software update 99
- specifications
 - acoustic 159
 - ecological 158
 - environmental 159
 - functional 157
 - graphic languages 158

- hard disk 158
- ink supplies 157
- margins 157
- mechanical accuracy 158
- memory 158
- operating systems 158
- paper size 157
- physical 158
- power 158
- printing resolutions 157
- spectrophotometer 58
- stand 109
- statistics
 - cost assignment 80
 - ink cartridge 82
 - printer usage 79
- stepped lines 131
- store the printer 97
- support services
 - HP Care Packs 153
 - HP Customer Care 153
 - HP Proactive Support 154
 - HP Start-Up Kit 153
 - HP Support 154
 - Knowledge Center 153
 - printer installation 154
 - warranty extensions 153
- switch the printer on/off 18

T

- telephone number 155

U

- unload paper
 - roll out of the printer 29
 - sheet 33
- using this guide 2

V

- Visio 2003, no output 148

W

- warranty extensions 153