

Flat: 14 x 8.5
Folded: 4.666 x 8.5
Acordion fold



HP Bluetooth Laser Mobile Mouse Quick Start Guide

Mouse Bergerak Laser Bluetooth HP
Panduan Mulai Cepat

HP Bluetooth-Laser-Maus für Notebooks
Kurzanleitung zur Installation

Mouse móvil láser HP Bluetooth
Guía de inicio rápido

Souris sans fil laser HP Bluetooth
Guide de démarrage rapide

Mouse HP Bluetooth Laser Mobile
Guida introduttiva

HP Bluetooth-lasermuis
Handleiding Snel aan de slag

© Copyright 2007, 2008 Hewlett-Packard Development Company, L.P.

Printed in China
Imprimé en Chine
Stampato in Cina
Impreso en China

Impresso na China
中国印刷
중국에서 인쇄



455801-B23



 **Note:** Your mouse may look different from the illustration.

 **Catatan:** Tetikus Anda mungkin tampak berbeda dari ilustrasinya.

 **Hinweis:** Möglicherweise unterscheidet sich Ihre Maus optisch von der Abbildung.

 **Nota:** Su mouse puede parecer diferente de la ilustración.

 **Remarque:** Votre souris peut être légèrement différente du modèle représenté dans l'illustration.

 **Nota:** il mouse potrebbe risultare diverso da quanto illustrato.

 **Opmerking:** uw muis kan er anders uitzien dan de afgebeelde muis.

1

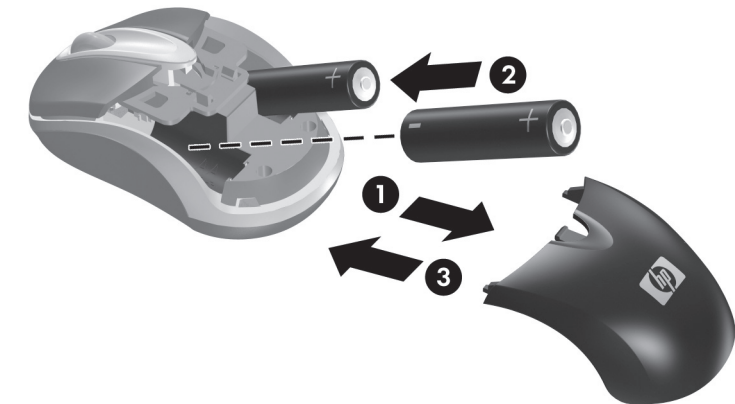



2



3

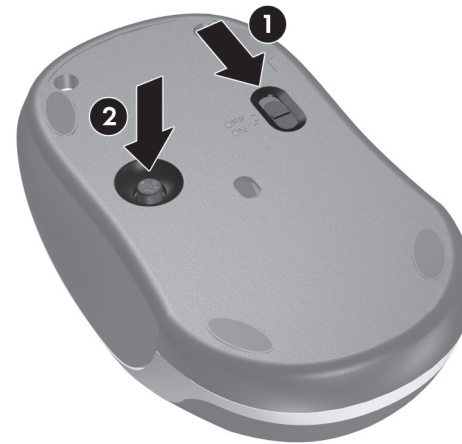

4

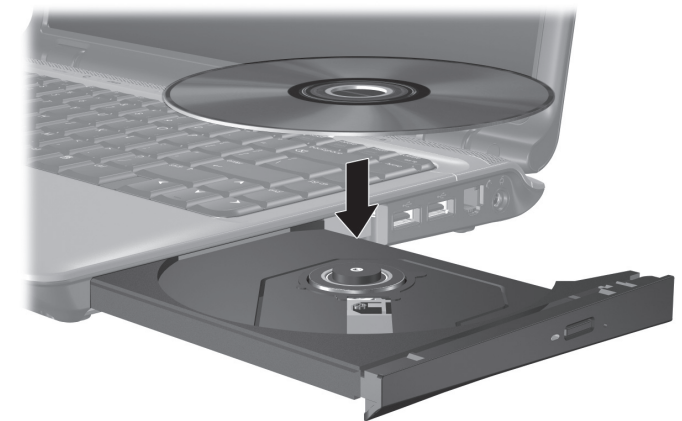

Follow the instructions displayed on the screen.

 **Note:** If you encounter any problems, refer to the user guide on the disc provided in this kit for more information.

Ikuti petunjuk yang ditampilkan pada layar.

 **Ingat:** Jika Anda mengalami masalah, lihat panduan pengguna pada cakram yang menyertai perangkat ini untuk informasi lebih lanjut.

Folgen Sie den Anleitungen auf dem Bildschirm.

 **Hinweis:** Sollten Probleme auftreten, finden Sie weitere Informationen im Benutzerhandbuch auf der Disc in diesem Kit.

Siga las instrucciones que aparecen en pantalla.

 **Nota:** Si usted encuentra algún problema, consulte la guía del usuario en el disco que se suministra en este kit para obtener más información.

Suivez les instructions affichées à l'écran.

 **Remarque:** En cas de problème, reportez-vous au manuel de l'utilisateur sur le disque fourni dans ce kit afin d'obtenir de plus amples informations.

Seguire le istruzioni visualizzate sullo schermo.

 **Nota:** Se si riscontrano problemi, per ulteriori informazioni, consultare la guida per l'utente nel disco fornito in questo kit.

Volg de instructies op het scherm.

 **Opmerking:** Raadpleeg in geval van problemen de gebruikershandleiding op de bij deze set geleverde schijf voor meer informatie.

