

HP 2133 Mini-Note PC and HP 2140 Mini-Note
PC
Maintenance and Service Guide



© Copyright 2008, 2009 Hewlett-Packard
Development Company, L.P.

Intel and Atom are trademarks of Intel Corporation in the U.S. and other countries. Bluetooth is a trademark owned by its proprietor and used by Hewlett-Packard Company under license. Microsoft, Windows, and Windows Vista are U.S. registered trademarks of Microsoft Corporation. SD Logo is a trademark of its proprietor.

The information contained herein is subject to change without notice. The only warranties for HP products and services are set forth in the express warranty statements accompanying such products and services. Nothing herein should be construed as constituting an additional warranty. HP shall not be liable for technical or editorial errors or omissions contained herein.

Third Edition: January 2009

First Edition: April 2008

Document Part Number: 465236-003

Safety warning notice

-
- ⚠ **WARNING!** To reduce the possibility of heat-related injuries or of overheating the computer, do not place the computer directly on your lap or obstruct the computer air vents. Use the computer only on a hard, flat surface. Do not allow another hard surface, such as an adjoining optional printer, or a soft surface, such as pillows or rugs or clothing, to block airflow. Also, do not allow the AC adapter to contact the skin or a soft surface, such as pillows or rugs or clothing, during operation. The computer and the AC adapter comply with the user-accessible surface temperature limits defined by the International Standard for Safety of Information Technology Equipment (IEC 60950).
-

Table of contents

1 Product description

2 External component identification

Model 2133	5
Top components	5
Display	5
Keys	6
TouchPad	7
Front components	8
Right-side components	9
Left-side components	10
Bottom components	11
Wireless antennas (select models only)	12
Model 2140	13
Top components	13
Display	13
Keys	14
TouchPad	15
Front components	16
Right-side components	17
Left-side components	18
Bottom components	19
Wireless antennas	20

3 Illustrated parts catalog

Serial number location	21
Computer major components	22
Bracket Kit	28
Plastics/Cable Kit	29
Miscellaneous parts	29
Sequential part number listing	30

4 Removal and replacement procedures

Preliminary replacement requirements	36
Tools required	36
Service considerations	36
Plastic parts	36
Cables and connectors	37
Drive handling	37
Grounding guidelines	38
Electrostatic discharge damage	38
Packaging and transporting guidelines	39
Workstation guidelines	39
Equipment guidelines	40
Unknown user password	41
Component replacement procedures	42
Serial number	42
Computer feet	43
Battery	44
Keyboard	45
Memory module	48
Mass storage device	49
Top cover	52
Audio board (Model 2133 only)	55
Bluetooth module	57
System board	59
WLAN module	63
RTC battery	66
Fan/heat sink	68
Display assembly	71

5 Computer Setup

Starting Computer Setup	74
Using Computer Setup	75
Navigating and selecting in Computer Setup	75
Restoring factory settings in Computer Setup	75
Computer Setup menus	76
File menu	76
Security menu	76
Diagnostics menu	77
System Configuration menu	77

6 Specifications

Computer specifications, model 2133	79
Computer specifications, model 2140	80

10.1-inch, SD display specifications	80
10.1-inch, HD display specifications	81
8.9-inch, WXGA display specifications	81
8.9-inch, WSVGA display specifications	83
Hard drive specifications	84
System DMA specifications	85
System interrupt specifications	86
System I/O address specifications	87
System memory map specifications	89

7 Screw listing

Phillips PM2.0×3.0 screw	90
Phillips PM2.0×5.0 screw	91
Phillips PM3.0×3.0 screw	92
Phillips PM2.0×7.0 screw	93
Phillips PM4.5×8.0 screw	94
Phillips PM2.0×8.0 screw	95
Torx8 T8M2.0×6.0 screw	96
Torx8 T8M2.5×5.0 screw	98
Torx8 T8M2.5×10.0 screw	101
Torx8 T8M2.0×4.0 screw	102

8 Backup and recovery

Backup and recovery in Windows Vista	103
Backing up and recovering	103
Backing up	103
Recovering	104
Backup and recovery in Windows XP	105
Backing up and recovering	105
Backing up	105
Recovering	105
Backup and recovery in SUSE Linux Enterprise Desktop	106
Performing a recovery	106

9 Connector pin assignments

Audio-out (headphone)	107
Audio-in (microphone)	107
External monitor	108
RJ-45 (network)	109
Universal Serial Bus	109

10 Power cord set requirements

Requirements for all countries and regions	110
--	-----

Requirements for specific countries and regions	111
11 Recycling	
Battery	112
Display	112
Index	118

1 Product description

Category	Description	Model 2133	Model 2140
Product Name	HP 2133 Mini-Note PC	√	
	HP 2140 Mini-Note PC		√
Processors	VIA Technology C7-M Ultra Low Voltage (ULV) processors	√	
	<ul style="list-style-type: none"> VIA C7-M ULV 1.6-GHz processor, 800-MHz front-side bus (FSB), 8-W thermal design power (TDP) 	√	
	<ul style="list-style-type: none"> VIA C7-M ULV 1.2-GHz processor, 800-MHz FSB, 5-W TDP 	√	
	<ul style="list-style-type: none"> VIA C7-M ULV 1.0-GHz processor, 400-MHz FSB, 3.5-W TDP 	√	
	Intel® Atom™ processor		√
<ul style="list-style-type: none"> Atom N270 1.60-GHz processor, 533-MHz 		√	
Chipset	Northbridge: VIA CN896	√	
	Southbridge: VIA 8237s	√	
	Northbridge: Intel 945GSE		√
	Southbridge: Intel ICH7M		√
Graphics	VIA Universal Memory Architecture (UMA) graphics subsystem	√	
Panels	All display assemblies include 2 microphones, 2 speakers, and 2 WLAN antenna transceivers and cables	√	
	<ul style="list-style-type: none"> 8.9-inch WXGA (1280 × 768) with camera 	√	
	<ul style="list-style-type: none"> 8.9-inch WXGA (1280 × 768) without camera 	√	
	<ul style="list-style-type: none"> 8.9-inch WSVGA (1024 × 600) with camera 	√	
	<ul style="list-style-type: none"> 8.9-inch WSVGA (1024 × 600) without camera 	√	
	<ul style="list-style-type: none"> 10.1-inch WSVGA (1024 × 576) with camera 		√
<ul style="list-style-type: none"> 10.1-inch WSVGA (1366 × 768) with camera 		√	
Memory	One customer-accessible/upgradable memory module slot	√	√
	Supports up to 2 GB of system RAM	√	√
	PC2-5300, 667-MHz, DDR2	√	√
	Supports the following configurations:		

Category	Description	Model 2133	Model 2140
	<ul style="list-style-type: none"> 2048-MB total system memory (2048 × 1) 	√	√
	<ul style="list-style-type: none"> 1024-MB total system memory (1024 × 1) 	√	√
	<ul style="list-style-type: none"> 512-MB total system memory (512 × 1) 	√	
Mass storage device	Supports 9.5-mm (2.5-inch) serial ATA (SATA) hard drives	√	√
	Supports the following SATA hard drives:		
	<ul style="list-style-type: none"> 160-GB, 7200-rpm 	√	√
	<ul style="list-style-type: none"> 160-GB, 5400-rpm 	√	√
	<ul style="list-style-type: none"> 120-GB, 7200-rpm 	√	
	<ul style="list-style-type: none"> 120-GB, 5400-rpm 	√	
	80-GB solid state drive	√	√
	4-GB solid state drive	√	
	Supports 9.5-mm (2.5-inch) SATA 4-GB flash storage drive	√	√
Optical drive	Supports external USB optical drive only	√	√
Diskette drive	Supports external USB diskette drive only	√	√
Audio	HD audio - AD1984	√	√
	Stereo speakers (2)	√	√
	Intergrated stereo microphones (2)	√	√
Webcam	Optional integrated VGA webcam	√	√
Modem	Supports external USB modem only	√	√
Ethernet	Broadcom 5788 10/100/1000 LAN	√	√
	S3/S4/S5 wake on LAN: DC - no	√	√
	S3/S4/S5 wake on LAN: AC - yes	√	√
Wireless	Integrated WLAN options by way of wireless module:		
	2 WLAN antennas built into display assembly	√	√
	Support for no-WLAN option	√	√
	Support for the following WLAN formats:		
	<ul style="list-style-type: none"> Broadcom 4311AG 802.11a/b/g WLAN module 	√	
	<ul style="list-style-type: none"> Broadcom BCM4312 802.11b/g WLAN module 	√	
	<ul style="list-style-type: none"> Broadcom 4322 802.11a/b/g/n module 		√
	Integrated personal area network (PAN) options by way of Bluetooth® module:	√	√
	Support for no-WPAN option	√	√
	Broadcom Bluetooth 2.0+EDR	√	√
External media card	One ExpressCard/54 slot	√	√

Category	Description	Model 2133	Model 2140
	SD/MMC Card Reader supporting Secure Digital (SD) Memory Card and MultiMediaCard (MMC)	√	√
Ports	Audio-in (stereo microphone)	√	√
	Audio-out (stereo headphone)	√	√
	RJ-45 (Ethernet, includes link and activity lights)	√	√
	USB (non-powered)	√	√
	USB (powered)	√	√
	VGA (Dsub 15-pin) supporting 1920 × 1440 external resolution at 75-GHz (hot plug/unplug with auto-detect)	√	√
	2-pin AC power	√	√
Keyboard/pointing devices	25.4-cm (10.0-inch) keyboard with embedded numeric keypad	√	√
	Windows Vista® Start button	√	√
	TouchPad, with 2 TouchPad buttons and vertical scrolling (taps enabled as default)	√	√
Power requirements	65-W AC adapter with localized cable plug support (3-wire plug, supports 2-pin DC connector)	√	√
	6-cell, 55-Wh Li-ion battery	√	√
	3-cell, 28-Wh Li-ion battery	√	√
Security	Supports Kensington security lock	√	√
	HP 3D DriveGuard	√	√
Operating system	Preinstalled:	√	√
	Windows Vista® Basic 32 with Office 2007 Ready	√	√
	Windows Vista Business 32 with Office 2007 Ready	√	√
	Windows® XP Professional	√	√
	Windows XP Home	√	√
	SUSE Linux Enterprise Desktop	√	√
	Restore media:	√	√
	DR DVD Windows Vista Home Basic	√	√
	OS DVD Windows Vista Business	√	√
	DR DVD/OS DVD Windows XP Pro	√	√
	SUSE Linux Enterprise Desktop	√	√
	Serviceability	End-user replaceable parts:	√
AC adapter		√	√
Battery (system)		√	√

Category	Description	Model 2133	Model 2140
	Hard drive	√	√
	Memory module	√	√

2 External component identification

Model 2133

Top components

Display

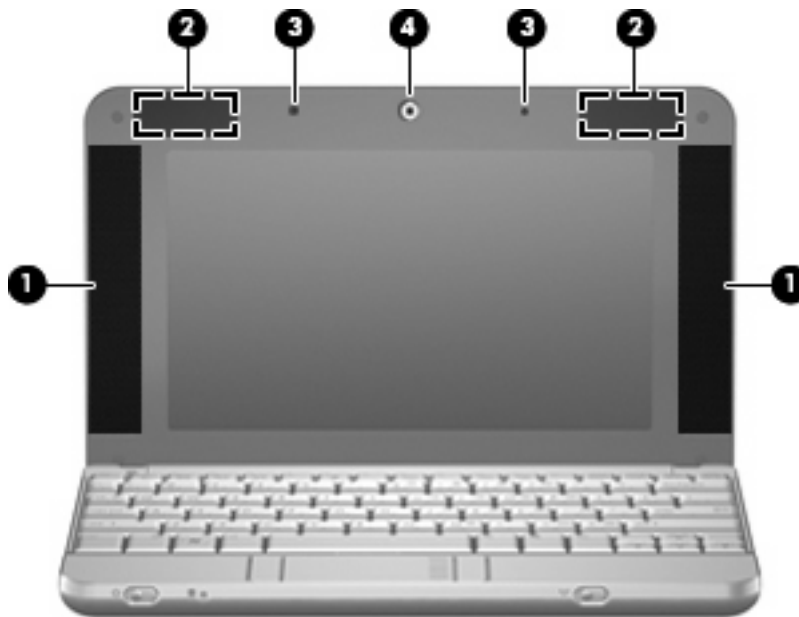

Item	Component	Function
(1)	Speakers (2)	Produce sound.
(2)	Wireless antennas (2)	Send and receive signals from one or more wireless devices.

NOTE: The antennas are not visible from the outside of the computer.

Item	Component	Function
(3)	Internal microphones (2)	Record sound. NOTE: If there is a microphone icon next to each microphone opening, your computer has internal microphones.
(4)	Webcam (select models only)	<ul style="list-style-type: none"> Records and plays back webcam video. Includes streaming video options and special effects for adding frames, filters, and emoticons to snapshots and video. Captures single frame or burst webcam snapshots. Connects to e-mail photos and video.

Keys

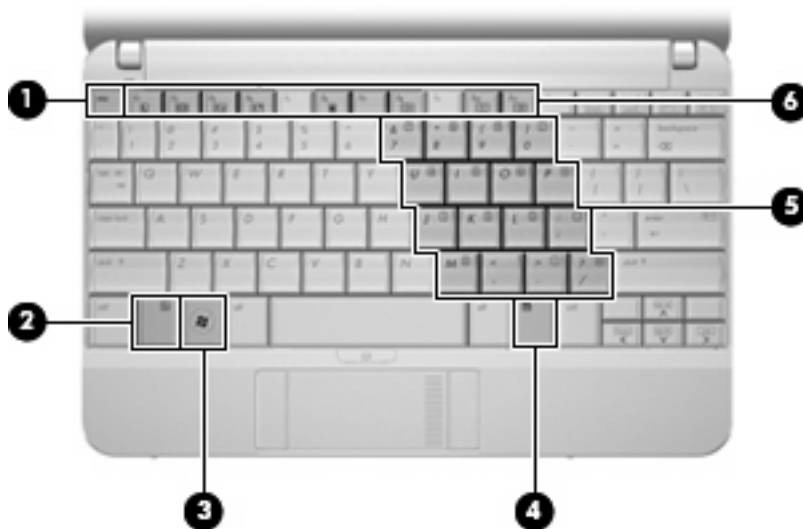

Item	Component	Function
(1)	<code>esc</code> key	Displays system information when pressed in combination with the <code>fn</code> key.
(2)	<code>fn</code> key	Executes frequently used system functions when pressed in combination with a function key or the <code>esc</code> key.
(3)	Windows logo key	Displays the Windows Start menu.
(4)	Windows applications key	Displays a shortcut menu for items beneath the pointer.
(5)	Embedded numeric keypad keys	Can be used like the keys on an external numeric keypad.
(6)	Function keys	Execute frequently used system functions when pressed in combination with the <code>fn</code> key.

TouchPad

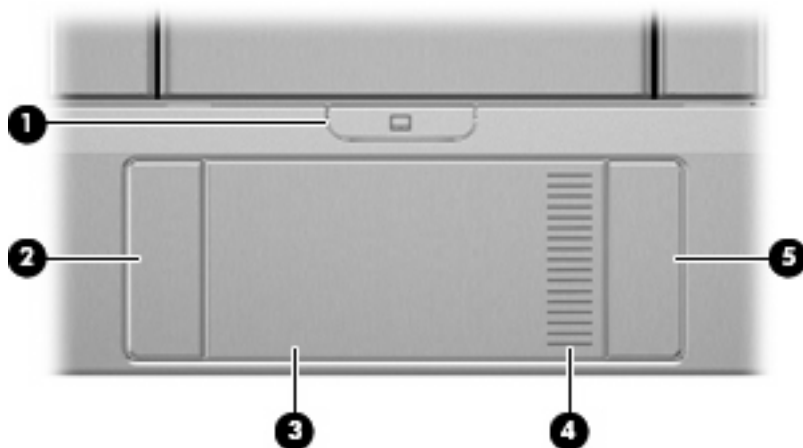

Item	Component	Function
(1)	TouchPad on/off button	Enables/disables the TouchPad.
(2)	Left TouchPad button*	Functions like the left button on an external mouse.
(3)	TouchPad*	Moves the pointer and selects or activates items on the screen.
(4)	TouchPad scroll zone	Scrolls up or down.
(5)	Right TouchPad button*	Functions like the right button on an external mouse.

*This table describes factory settings. To view or change pointing device preferences, select **Start > Control Panel > Hardware and Sound > Mouse**.

Front components



Item	Component	Function
(1)	Power light	<ul style="list-style-type: none"> • Blue: The computer is on. • Blinking: The computer is in the Sleep state. • Off: The computer is off or in Hibernation.
(2)	Power switch	<ul style="list-style-type: none"> • When the computer is off, slide the switch to turn on the computer. • When the computer is on, slide the switch briefly to initiate Hibernation. • When the computer is in the Sleep state, slide the switch briefly to exit Sleep. • When the computer is in Hibernation, slide the switch briefly to exit Hibernation. <p>If the computer has stopped responding and Windows® shutdown procedures are ineffective, slide and hold the power switch for at least 5 seconds to turn off the computer.</p> <p>To learn more about your power settings, select Start > Control Panel > System and Maintenance > Power Options.</p>
(3)	Drive light	Blinking: The hard drive is being accessed.
(4)	Wireless light	<ul style="list-style-type: none"> • Blue: An integrated wireless device, such as a wireless local area network (WLAN) device, the HP Broadband Wireless Module, and/or a Bluetooth® device, is on. • Amber: All wireless devices are off. <p>NOTE: The wireless light turns amber when the computer turns on, but all wireless devices are off.</p>
(5)	Wireless switch	<p>Turns the wireless feature on or off, but does not create a wireless connection.</p> <p>NOTE: To establish a wireless connection, a wireless network must already be set up.</p>

Right-side components

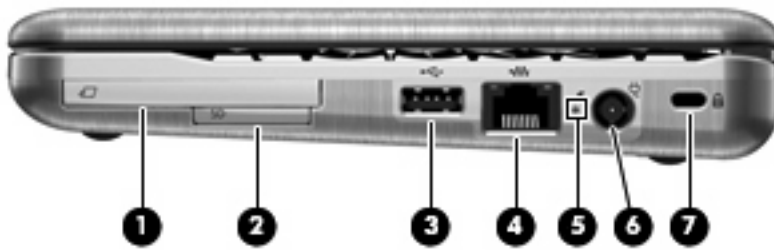

Item	Component	Function
(1)	ExpressCard slot	Supports optional ExpressCards 54.
(2)	SD Card Reader	Supports the following optional digital card formats: <ul style="list-style-type: none"> Secure Digital (SD) Memory Card MultiMediaCard (MMC)
(3)	USB port	Connects an optional USB device.
(4)	RJ-45 (network) jack	Connects a network cable.
(5)	Battery light	<ul style="list-style-type: none"> Amber: A battery is charging. Blue: A battery is close to full charge capacity. Blinking amber: A battery that is the only available power source has reached a low battery level. If the computer is plugged into an external power source, the light turns off when all batteries in the computer are fully charged. If the computer is not plugged into an external power source, the light stays off until the battery reaches a low battery level.
(6)	Power connector	Connects an AC adapter.
(7)	Security cable slot	Attaches an optional security cable to the computer.

NOTE: The security cable is designed to act as a deterrent, but it may not prevent the computer from being mishandled or stolen.

Left-side components

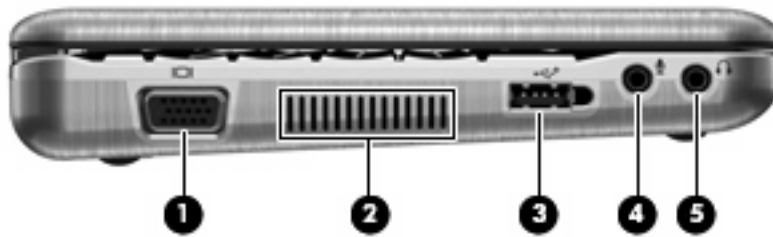

Item	Component	Function
(1)	External monitor port	Connects an external VGA monitor or projector.
(2)	Vent	Enables airflow to cool internal components. NOTE: The computer fan starts up automatically to cool internal components and prevent overheating. It is normal for the internal fan to cycle on and off during routine operation.
(3)	Powered USB port	Provides power to a USB device, such as an optional external MultiBay or an optional external optical drive, if used with a powered USB cable.
(4)	Audio-in (microphone) jack	Connects an optional computer headset microphone, stereo array microphone, or monaural microphone.
(5)	Audio-out (headphone) jack	Produces sound when connected to optional powered stereo speakers, headphones, ear buds, a headset, or television audio.

Bottom components

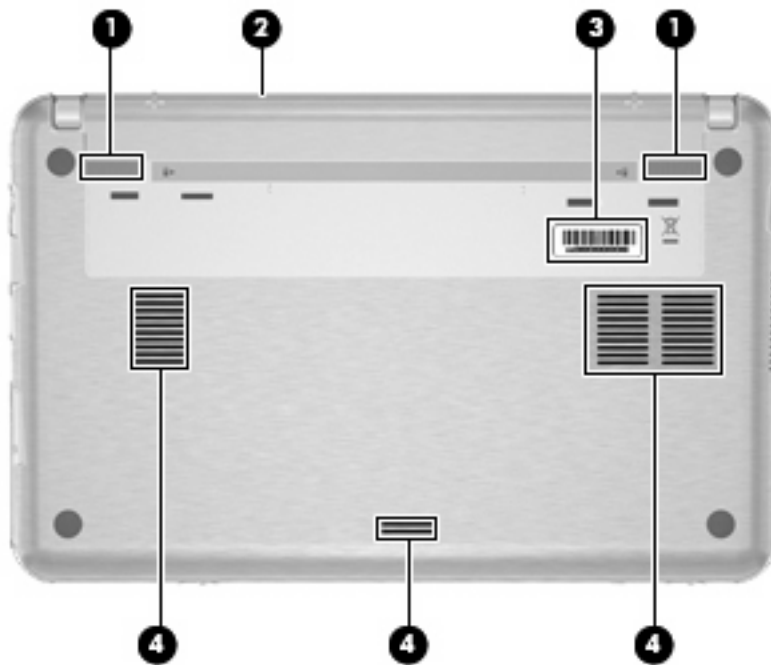

Item	Component	Function
(1)	Battery release latches (2)	Release the battery from the battery bay.
(2)	Battery bay	Holds the battery.
(3)	Service tag	Provides the product brand and series name, serial number (s/n), and product number (p/n) of your computer. Have this information available when you contact technical support.
(4)	Vents (3)	Enable airflow to cool internal components.

NOTE: The computer fan starts up automatically to cool internal components and prevent overheating. It is normal for the internal fan to cycle on and off during routine operation.

Wireless antennas (select models only)

On select computer models, at least 2 antennas send and receive signals from one or more wireless devices. These antennas are not visible from the outside of the computer.



 **NOTE:** For optimal transmission, keep the areas immediately around the antennas free from obstructions.

To see wireless regulatory notices, refer to the section of the *Regulatory, Safety and Environmental Notices* that applies to your country or region. These notices are located in Help and Support.

Model 2140

Top components

Display



Component	Description
(1) Speakers (2)	Produce sound.
(2) Internal microphones (2)	Record sound. NOTE: If there is a microphone icon next to each microphone opening, your computer has internal microphones.
(3) Webcam	Records audio and video, and captures still photographs.

Keys

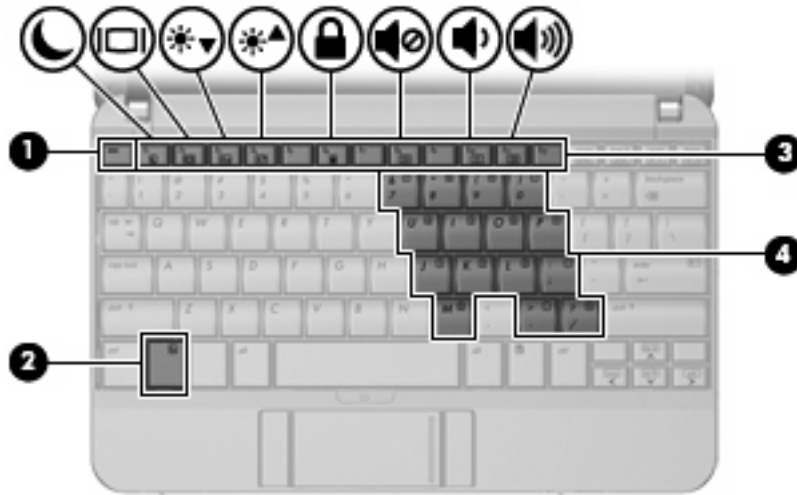

Component	Description
(1) <code>esc</code> key	Displays system information when pressed in combination with the <code>fn</code> key.
(2) <code>fn</code> key	Executes frequently used system functions when pressed in combination with a function key or the <code>esc</code> key.
(3) Function keys	Execute frequently used system functions when pressed in combination with the <code>fn</code> key.
(4) Embedded numeric keypad keys	Can be used like the keys on an external numeric keypad.

TouchPad

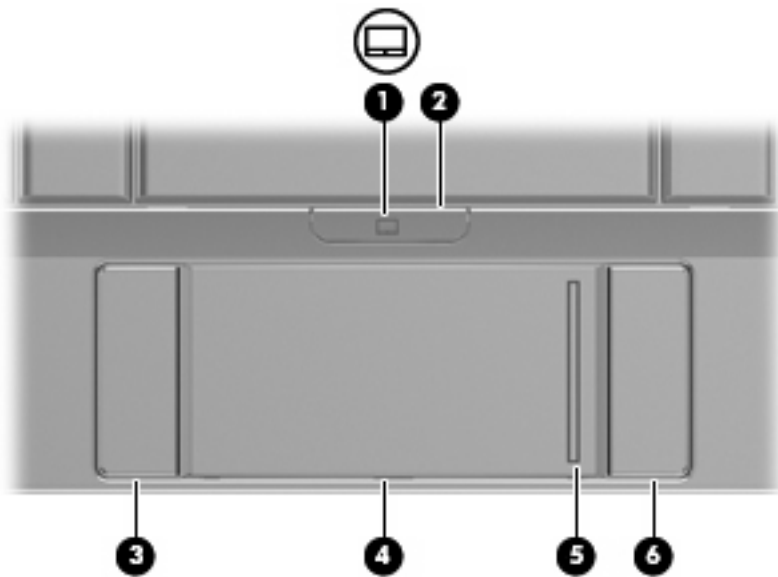

Component	Description
(1) TouchPad light	<ul style="list-style-type: none">• White: TouchPad is enabled.• Amber: TouchPad is disabled.
(2) TouchPad on/off button	Enables/disables the TouchPad.
(3) Left TouchPad button	Functions like the left button on an external mouse.
(4) TouchPad	Moves the pointer and selects or activates items on the screen.
(5) TouchPad scroll zone	Scrolls up or down.
(6) Right TouchPad button	Functions like the right button on an external mouse.

Front components



Component	Description
(1) Power light	<ul style="list-style-type: none">Blue: The computer is on.Blinking: The computer is in the Sleep state.Off: The computer is off or in Hibernation.
(2) Power switch	<ul style="list-style-type: none">When the computer is off, slide the switch to turn on the computer.When the computer is on, slide the switch briefly to initiate Hibernation.When the computer is in the Sleep state, slide the switch briefly to exit Sleep.When the computer is in Hibernation, slide the switch briefly to exit Hibernation. <p>If the computer has stopped responding and operating system shutdown procedures are ineffective, slide and hold the power switch for at least 5 seconds to turn off the computer.</p>
(3) Drive light	Blinking: The hard drive is being accessed.
(4) Wireless light	<ul style="list-style-type: none">Blue: An integrated wireless device, such as a wireless local area network (WLAN) device and/or a Bluetooth® device, is on.Amber: All wireless devices are off. <p>NOTE: The wireless light turns amber when the computer turns on, but all wireless devices are off.</p>
(5) Wireless switch	Turns the wireless feature on or off, but does not create a wireless connection.

Right-side components

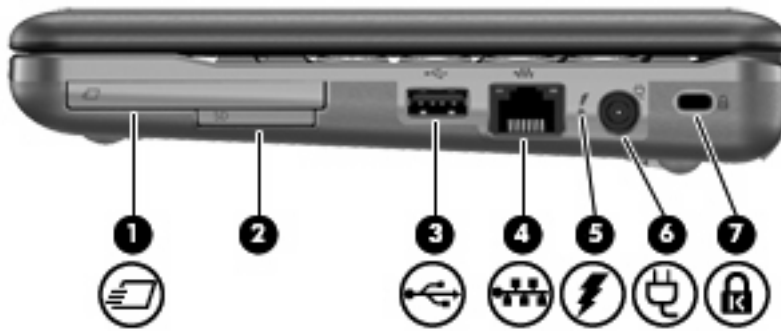

Component	Description
(1) ExpressCard slot	Supports optional ExpressCards 54.
(2) SD Card Reader	Supports the following optional digital card formats: <ul style="list-style-type: none">• MultiMediaCard (MMC)• Secure Digital (SD) Memory Card
(3) USB port	Connects an optional USB device.
(4) RJ-45 (network) jack	Connects a network cable.
(5) Battery light	<ul style="list-style-type: none">• Amber: A battery is charging.• Blue: A battery is close to full charge capacity.• Blinking amber: A battery that is the only available power source has reached a low battery level. When the battery reaches a critical battery level, the battery light begins blinking rapidly.• Off: If the computer is plugged into an external power source, the light turns off when all batteries in the computer are fully charged. If the computer is not plugged into an external power source, the light stays off until the battery reaches a low battery level.
(6) Power connector	Connects an AC adapter.
(7) Security cable slot	Attaches an optional security cable to the computer.

NOTE: The security cable is designed to act as a deterrent, but it may not prevent the computer from being mishandled or stolen.

Left-side components

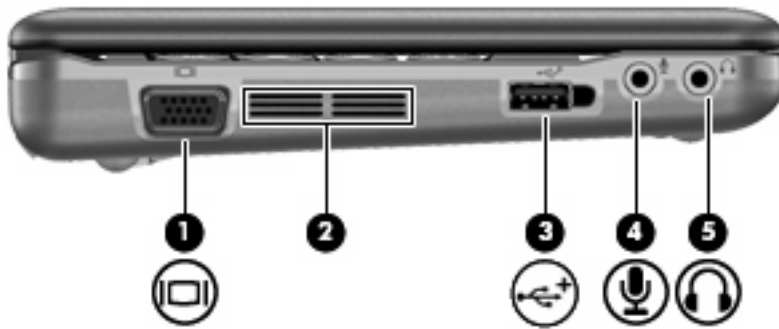

Component	Description
(1) External monitor port	Connects an external VGA monitor or projector.
(2) Vent	Enables airflow to cool internal components. NOTE: The computer fan starts up automatically to cool internal components and prevent overheating. It is normal for the internal fan to cycle on and off during routine operation.
(3) Powered USB port	Provides power to a USB device, such as an optional external MultiBay or an optional external optical drive, if used with a powered USB cable.
(4) Audio-in (microphone) jack	Connects an optional computer headset microphone, stereo array microphone, or monaural microphone.
(5) Audio-out (headphone) jack	Produces sound when connected to optional powered stereo speakers, headphones, ear buds, a headset, or television audio. WARNING! To reduce the risk of personal injury, adjust the volume before putting on headphones, earbuds, or a headset. For additional safety information, refer to the Regulatory, Safety and Environmental Notices. NOTE: When a device is connected to the headphone jack, the computer speakers are disabled.

Bottom components

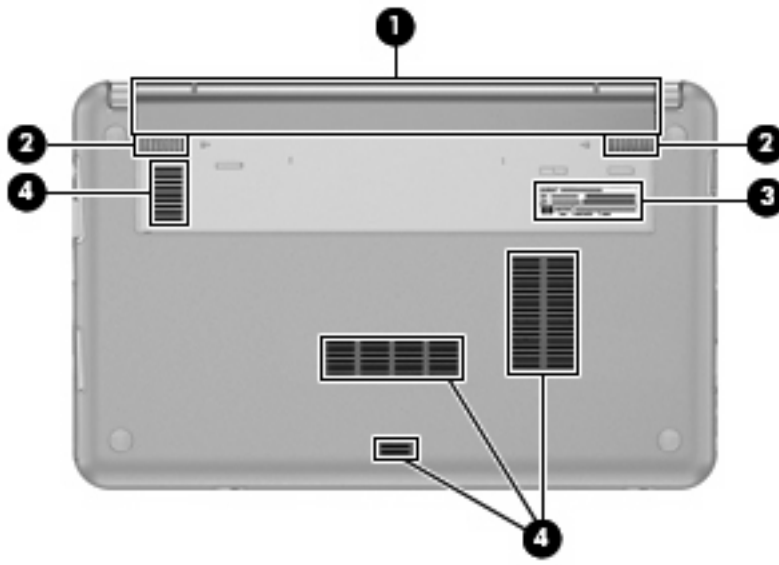

Component	Description
(1) Battery bay	Holds the battery.
(2) Battery release latches (2)	Release the battery from the battery bay.
(3) Service tag	Provides the product brand and series name, serial number (s/n), and product number (p/n) of your computer. Have this information available when you contact technical support.
(4) Vents (4)	Enable airflow to cool internal components. NOTE: The computer fan starts up automatically to cool internal components and prevent overheating. It is normal for the internal fan to cycle on and off during routine operation.

Wireless antennas

On select computer models, at least 2 antennas send and receive signals from one or more wireless devices. These antennas are not visible from the outside of the computer.



 **NOTE:** For optimal transmission, keep the areas immediately around the antennas free from obstructions.

To see wireless regulatory notices, refer to the section of the *Regulatory, Safety and Environmental Notices* that applies to your country or region. These notices are located in Help and Support.

3 Illustrated parts catalog

Serial number location

When ordering parts or requesting information, provide the computer serial number and model number located on the bottom of the computer.



Computer major components

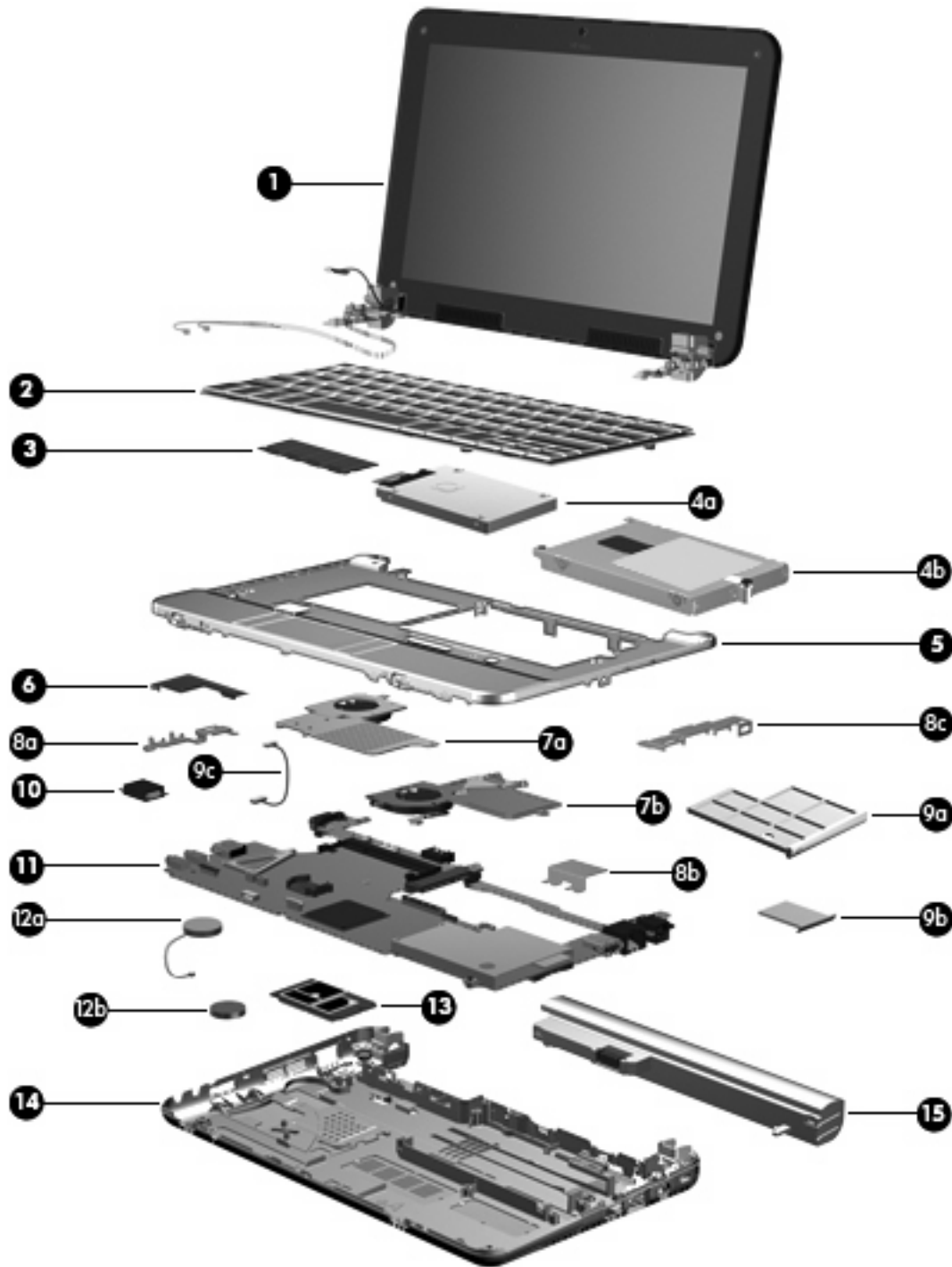

Item	Description	Spare part number
(1)	8.9-inch, WXGA display assemblies for use with model 2133 (include 2 microphones, 2 speakers, and 2 WLAN antenna transceivers and cables)	
	For use only with computer models equipped with a camera module	483384-001
	For use only with computer models not equipped with a camera module	482278-001

Item	Description	Spare part number
	10.1-inch WXGA display assemblies for use with model 2140 (include 2 microphones, 2 speakers, and 2 WLAN antenna transceivers and cables)	
	For use in SD computer models with camera module	511743-001
	For use in HD computer models with camera module	511744-001
	8.9-inch, WSVGA display assemblies (include 2 microphones, 2 speakers, and 2 WLAN antenna transceivers and cables)	
	For use only with computer models equipped with camera module and system boards with the following spare part numbers: 498308-001, 500754-001, and 500755-001	498309-001
	For use only with computer models not equipped with camera module and system boards with the following spare part numbers: 498308-001, 500754-001, and 500755-001	500459-001
(2)	Keyboards	
	For use in Brazil	482280-201
	For use in the Czech Republic	482280-221
	For use in Denmark	482280-081
	For use in Europe	482280-181
	For use in France	482280-051
	For use in French Canada	482280-121
	For use in Germany	482280-041
	For use in Greece	482280-DJ1
	For use in Hungary	482280-211
	For use in Iceland	482280-DD1
	For use internationally	482280-B31
	For use in Israel	482280-BB1
	For use in Italy	482280-061
	For use in Japan	482280-291
	For use in Latin America	482280-161
	For use in Norway	482280-091
	For use in Portugal	482280-131
	For use in Saudi Arabia	482280-171
	For use in Slovakia	482280-231
	For use in Slovenia	482280-BA1
	For use in South Korea	482280-AD1
	For use in Spain	482280-071
	For use in Sweden and Finland	482280-B71
	For use in Switzerland	482280-BG1
	For use in Taiwan	482280-AB1

Item	Description	Spare part number
	For use in Thailand	482280-281
	For use in Turkey	482280-141
	For use in the United Kingdom	482280-031
	For use in the United States	482280-001
(3)	Memory modules (PC2-5300, 667-MHz, DDR2)	
	For use only in model 2133:	
	• 2048-MB	417506-001
	• 1024-MB	414046-001
	• 512-MB	414045-001
	For use only in model 2140:	
	• 2048-MB	511755-001
	• 1024-MB	511754-001
	Mass storage devices	
	Hard drives (include bracket and SATA connector)	
(4a)	For use in model 2133:	
	• 160-GB, 7200-rpm	482271-001
	• 160-GB, 5400-rpm	482269-001
	• 120-GB, 7200-rpm	482268-001
	• 120-GB, 5400-rpm	482267-001
	• 80-GB solid-state drive (includes bracket and SATA connector)	502600-001
	• 4-GB solid-state drive (includes bracket and SATA connector)	482272-001
(4b)	For use in model 2140:	
	• 160-GB, 7200-rpm	511904-001
	• 160-GB, 5400-rpm	511903-001
	• 80-GB solid-state drive (includes bracket and SATA connector)	511901-001
(5)	Top cover (includes power on switch board and cable, TouchPad board and cable, and wireless on/off switch board and cable)	
	For use only in model 2133	482265-001
	For use only in model 2140	511749-001
(6)	Audio board	505907-001
	For use only in computer models with WXGA displays	482274-001
	Fan/heat sink (includes replacement thermal material)	
(7a)	For use only in model 2133	482279-001
(7b)	For use only in model 2140	511750-001

Item	Description	Spare part number
	Bracket Kit for use only in model 2133 (see Bracket Kit on page 28 for more Bracket Kit spare part number information)	482266-001
	NOTE: Model 2140 uses only the bracket shown by 8b.	
(8a)	Audio/USB connector bracket	
(8b)	ExpressCard assembly bracket	
(8c)	USB/RJ-45 connector bracket	
	Plastics/Cable Kit for use only in model 2133 (see Plastics/Cable Kit on page 29 for more Plastics/Cable Kit spare part number information)	483381-001
	Plastics/Cable Kit for use only in model 2140 (see Plastics/Cable Kit on page 29 for more Plastics/Cable Kit spare part number information)	511751-001
(9a)	ExpressCard slot bezel	
(9b)	SD Card slot bezel	
(9c)	Bluetooth module cable	
	ExpressCard assembly bracket (model 2140 only; not illustrated)	
	Hinge bracket (model 2140 only; not illustrated)	
(10)	Broadcom Bluetooth modules (embedded)	
	NOTE: The Bluetooth module spare part kits do not include a Bluetooth module cable. The Bluetooth module cable is included in the Plastics/Cable Kit, spare part number 483381-001 for model 2133, 511751-001 for model 2140. See Plastics/Cable Kit on page 29 for more Plastics/Cable Kit spare part number information.	
	For use in all countries and regions except Japan and Asia Pacific countries and regions	398393-002
	For use only in Japan and Asia Pacific countries and regions	450066-001
(11)	System boards (include ExpressCard assembly, fan/heat sink, processor, RTC battery, and replacement thermal material) (model 2133 shown)	
	For use only in model 2133:	
	• Equipped with 1.6-GHz processor and only for use with WXGA displays	482277-001
	• Equipped with 1.2-GHz processor and only for use with WXGA displays	482276-001
	• Equipped with 1.0-GHz processor and only for use with WXGA displays	482275-001
	• Equipped with 1.6-GHz processor	500755-001
	• Equipped with 1.2-GHz processor	498308-001
	• Equipped with 1.0-GHz processor	500754-001
	For use only in model 2140:	
	• Equipped with 1.6-GHz processor	511745-001
	RTC battery	
(12a)	For use only in model 2133	468824-001
(12b)	For use only in model 2140	449137-001
(13)	WLAN modules	
	Broadcom 4311AG 802.11a/b/g WLAN modules:	

Item	Description	Spare part number
•	For use in Canada, the Cayman Islands, Guam, Puerto Rico, the U.S. Virgin Islands, and the United States	441075-001
•	For use in Afghanistan, Albania, Algeria, Andorra, Angola, Antigua and Barbuda, Argentina, Armenia, Aruba, Australia, Austria, Azerbaijan, the Bahamas, Bahrain, Bangladesh, Barbados, Belarus, Belgium, Belize, Benin, Bermuda, Bhutan, Bolivia, Bosnia and Herzegovina, Botswana, Brazil, the British Virgin Islands, Brunei, Bulgaria, Burkina Faso, Burundi, Cameroon, Cape Verde, the Central African Republic, Chad, Chile, the People's Republic of China, Colombia, Comoros, the Congo, Costa Rica, Croatia, Cyprus, the Czech Republic, Denmark, Djibouti, Dominica, the Dominican Republic, East Timor, Ecuador, Egypt, El Salvador, Equatorial Guinea, Eritrea, Estonia, Ethiopia, Fiji, Finland, France, French Guiana, Gabon, Gambia, Georgia, Germany, Ghana, Gibraltar, Greece, Grenada, Guadeloupe, Guatemala, Guinea, Guinea-Bissau, Guyana, Haiti, Honduras, Hong Kong, Hungary, Iceland, India, Ireland, Israel, Italy, the Ivory Coast, Jamaica, Jordan, Kazakhstan, Kenya, Kiribati, Kyrgyzstan, Laos, Latvia, Lebanon, Lesotho, Liberia, Liechtenstein, Lithuania, Luxembourg, Macedonia, Madagascar, Malawi, Malaysia, the Maldives, Mali, Malta, the Marshall Islands, Martinique, Mauritania, Mauritius, Mexico, Micronesia, Monaco, Mongolia, Montenegro, Morocco, Mozambique, Namibia, Nauru, Nepal, the Nether Antilles, the Netherlands, New Zealand, Nicaragua, Niger, Nigeria, Norway, Oman, Pakistan, Palau, Panama, Papua New Guinea, Paraguay, Peru, the Philippines, Poland, Portugal, the Republic of Moldova, Romania, Russia, Rwanda, Samoa, San Marino, Sao Tome and Principe, Saudi Arabia, Senegal, Serbia, the Seychelles, Sierra Leone, Singapore, Slovakia, Slovenia, the Solomon Islands, Somalia, South Africa, South Korea, Spain, Sri Lanka, St. Kitts and Nevis, St. Lucia, St. Vincent and the Grenadines, Suriname, Swaziland, Sweden, Switzerland, Taiwan, Tajikistan, Tanzania, Togo, Tonga, Trinidad and Tobago, Tunisia, Turkey, Turkmenistan, Tuvalu, Uganda, Ukraine, the United Arab Emirates, the United Kingdom, Uruguay, Uzbekistan, Vanuatu, Venezuela, Vietnam, Yemen, Zaire, Zambia, and Zimbabwe	441075-002
•	For use in Japan	441075-291
Broadcom BCM4312 802.11b/g WLAN modules:		
•	For use in Canada, the Cayman Islands, Guam, Puerto Rico, the U.S. Virgin Islands, and the United States	459263-001
•	For use in Afghanistan, Albania, Algeria, Andorra, Angola, Antigua and Barbuda, Argentina, Armenia, Aruba, Australia, Austria, Azerbaijan, the Bahamas, Bahrain, Bangladesh, Barbados, Belarus, Belgium, Belize, Benin, Bermuda, Bhutan, Bolivia, Bosnia and Herzegovina, Botswana, Brazil, the British Virgin Islands, Brunei, Bulgaria, Burkina Faso, Burundi, Cameroon, Cape Verde, the Central African Republic, Chad, Chile, the People's Republic of China, Colombia, Comoros, the Congo, Costa Rica, Croatia, Cyprus, the Czech Republic, Denmark, Djibouti, Dominica, the Dominican Republic, East Timor, Ecuador, Egypt, El Salvador, Equatorial Guinea, Eritrea, Estonia, Ethiopia, Fiji, Finland, France, French Guiana, Gabon, Gambia, Georgia, Germany, Ghana, Gibraltar, Greece, Grenada, Guadeloupe, Guatemala, Guinea, Guinea-Bissau, Guyana, Haiti, Honduras, Hong Kong, Hungary, Iceland, India, Ireland, Israel, Italy, the Ivory Coast, Jamaica, Jordan, Kazakhstan, Kenya, Kiribati, Kyrgyzstan, Laos, Latvia, Lebanon, Lesotho, Liberia, Liechtenstein, Lithuania, Luxembourg, Macedonia, Madagascar, Malawi, Malaysia, the Maldives, Mali, Malta, the Marshall Islands, Martinique, Mauritania, Mauritius, Mexico, Micronesia, Monaco, Mongolia, Montenegro, Morocco, Mozambique, Namibia, Nauru, Nepal, the Nether Antilles, the Netherlands, New Zealand, Nicaragua, Niger, Nigeria, Norway, Oman, Pakistan, Palau, Panama, Papua New Guinea, Paraguay, Peru, the Philippines, Poland, Portugal, the Republic of Moldova, Romania, Russia, Rwanda, Samoa, San Marino, Sao Tome and Principe, Saudi Arabia, Senegal, Serbia, the Seychelles, Sierra Leone, Singapore, Slovakia, Slovenia, the Solomon Islands, Somalia, South Africa, South Korea, Spain, Sri Lanka, St. Kitts and Nevis, St. Lucia, St. Vincent and the Grenadines, Suriname, Swaziland, Sweden, Switzerland, Taiwan, Tajikistan, Tanzania, Togo, Tonga, Trinidad and Tobago, Tunisia, Turkey, Turkmenistan, Tuvalu, Uganda, Ukraine, the United Arab Emirates, the United Kingdom, Uruguay, Uzbekistan, Vanuatu, Venezuela, Vietnam, Yemen, Zaire, Zambia, and Zimbabwe	459263-002

Item	Description	Spare part number
	Broadcom 4322 802.11a/b/g/n WLAN module	
	For use in Antigua and Barbuda, Barbados, Belize, Canada, the Cayman Islands, Guam, Puerto Rico, Trinidad and Tobago, the U.S. Virgin Islands, and the United States	487330-001
	For use in Afghanistan, Albania, Algeria, Andorra, Angola, Antigua and Barbuda, Argentina, Armenia, Aruba, Australia, Austria, Azerbaijan, the Bahamas, Bahrain, Bangladesh, Barbados, Belarus, Belgium, Belize, Benin, Bermuda, Bhutan, Bolivia, Bosnia and Herzegovina, Botswana, Brazil, the British Virgin Islands, Brunei, Bulgaria, Burkina Faso, Burundi, Cameroon, Cape Verde, the Central African Republic, Chad, Chile, the People's Republic of China, Colombia, Comoros, the Congo, Costa Rica, Croatia, Cyprus, the Czech Republic, Denmark, Djibouti, Dominica, the Dominican Republic, East Timor, Ecuador, Egypt, El Salvador, Equatorial Guinea, Eritrea, Estonia, Ethiopia, Fiji, Finland, France, French Guiana, Gabon, Gambia, Georgia, Germany, Ghana, Gibraltar, Greece, Grenada, Guadeloupe, Guatemala, Guinea, Guinea-Bissau, Guyana, Haiti, Honduras, Hong Kong, Hungary, Iceland, India, Ireland, Israel, Italy, the Ivory Coast, Jamaica, Jordan, Kazakhstan, Kenya, Kiribati, Kyrgyzstan, Laos, Latvia, Lebanon, Lesotho, Liberia, Liechtenstein, Lithuania, Luxembourg, Macedonia, Madagascar, Malawi, Malaysia, the Maldives, Mali, Malta, the Marshall Islands, Martinique, Mauritania, Mauritius, Mexico, Micronesia, Monaco, Mongolia, Montenegro, Morocco, Mozambique, Namibia, Nauru, Nepal, the Nether Antilles, the Netherlands, New Zealand, Nicaragua, Niger, Nigeria, Norway, Oman, Pakistan, Palau, Panama, Papua New Guinea, Paraguay, Peru, the Philippines, Poland, Portugal, the Republic of Moldova, Romania, Russia, Rwanda, Samoa, San Marino, Sao Tome and Principe, Saudi Arabia, Senegal, Serbia, the Seychelles, Sierra Leone, Singapore, Slovakia, Slovenia, the Solomon Islands, Somalia, South Africa, South Korea, Spain, Sri Lanka, St. Kitts and Nevis, St. Lucia, St. Vincent and the Grenadines, Suriname, Swaziland, Sweden, Switzerland, Taiwan, Tajikistan, Tanzania, Togo, Tonga, Trinidad and Tobago, Tunisia, Turkey, Turkmenistan, Tuvalu, Uganda, Ukraine, the United Arab Emirates, the United Kingdom, Uruguay, Uzbekistan, Vanuatu, Venezuela, Vietnam, Yemen, Zaire, Zambia, and Zimbabwe	487330-002
(14)	Base enclosure (includes 4 rubber feet)	
	For use in model 2133	482264-001
	For use in model 2140	511748-001
	Rubber Kit (not illustrated, contains 4 computer feet)	
	For use only in model 2133	483382-001
	For use only in model 2140	511752-001
(15)	Batteries	
	For use only in model 2133:	
	• 6-cell, 55-Wh Li-ion battery	482263-001
	• 3-cell, 28-Wh Li-ion battery	482262-001
	For use only in model 2140:	
	• 6-cell, 55-Wh Li-ion battery	511747-001
	• 3-cell, 28-Wh Li-ion battery	511746-001

Bracket Kit

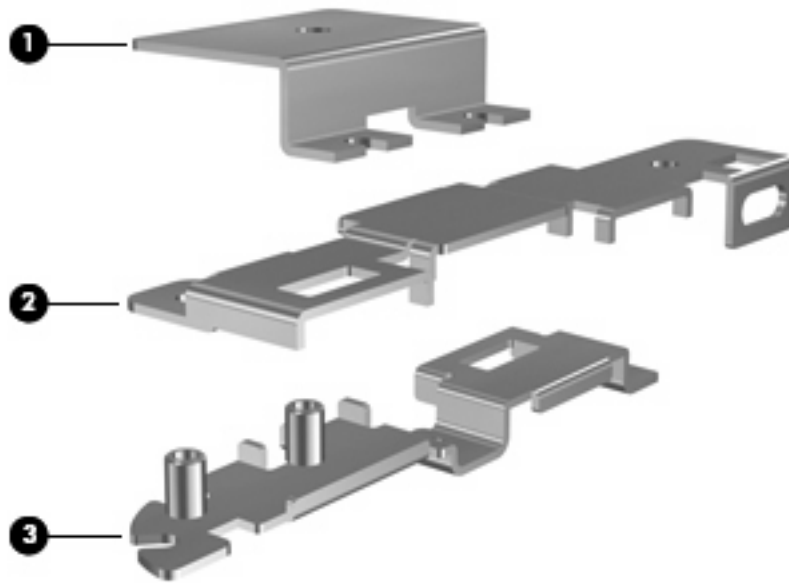

Item	Description	Spare part number
	Bracket Kit for use only in model 2133:	482266-001
(1)	ExpressCard assembly bracket	
(2)	USB/RJ-45 connector bracket	
(3)	Audio/USB connector bracket	

Plastics/Cable Kit

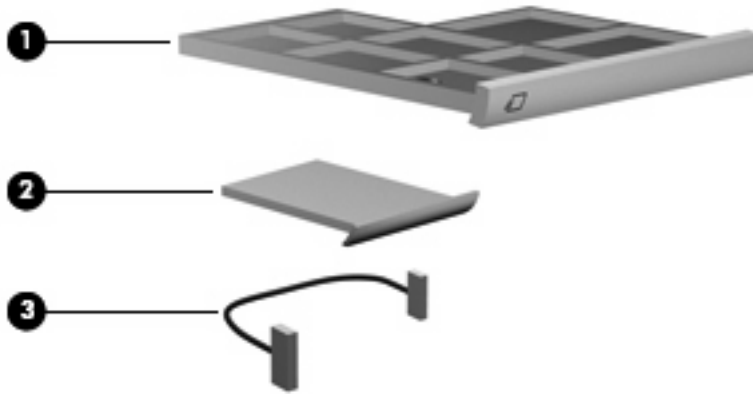

Item	Description	Spare part number
	Plastics/Cable Kit for use only in model 2133	483381-001
	Plastics/Cable Kit for use only in model 2140	511751-001
(1)	ExpressCard slot bezel	
(2)	SD Card slot bezel	
(3)	Bluetooth module cable	
	ExpressCard bracket (model 2140 only; not illustrated)	
	Hinge bracket (model 2140 only; not illustrated)	

Miscellaneous parts

Description	Spare part number
65-W HP Smart AC adapter	463958-001
Power cords:	
For use in Australia	246959-011
For use in Brazil	246959-201
For use in Denmark	246959-081
For use in Europe, the Middle East, and Africa	246959-021
For use in Israel	246959-BB1
For use in Italy	246959-061
For use in Japan	246959-291
For use in South Korea	246959-AD1
For use in Switzerland	246959-AG1
For use in Taiwan	394279-AB1
For use in the United Kingdom	246959-031

Description	Spare part number
For use the United States	246959-001
Screw Kit for use in model 2133	483383-001
<ul style="list-style-type: none"> • Phillips PM2.0×3.0 screw • Torx8 T8M2.5×10.0 screw • Torx8 T8M2.5×5.0 screw • Torx8 T8M2.0×6.0 screw • Torx8 T8M2.0×4.0 screw 	
Screw kit for use only in model 2140	511753-001
<ul style="list-style-type: none"> • Phillips PM2.0×3.0 screw • Phillips PM2.5×3.0 screw • Phillips PM2.5×7.0 screw • Phillips PM2.0×3.0 screw • Phillips PM2.0×3.5 screw • Phillips PM2.0×7.0 screw 	

Sequential part number listing

Spare part number	Description
246959-001	Power cord for use in the United States
246959-011	Power cord for use in Australia and New Zealand
246959-021	Power cord for use in Europe, the Middle East, and Africa
246959-031	Power cord for use in the United Kingdom
246959-061	Power cord for use in Italy
246959-081	Power cord for use in Denmark
246959-201	Power cord for use in Brazil
246959-291	Power cord for use in Japan
246959-AD1	Power cord for use in South Korea
246959-AG1	Power cord for use in Switzerland
246959-BB1	Power cord for use in Israel
394279-AB1	Power cord for use in Taiwan
398393-002	Bluetooth module for use in all countries and regions except Japan and Asia Pacific countries and regions
	<p>NOTE: The Bluetooth module spare part kits do not include a Bluetooth module cable. The Bluetooth module cable is included in the Plastics/Cable Kit, spare part number 483381-001 for model 2133, 511751-001 for model 2140. See Plastics/Cable Kit on page 29 for more Plastics/Cable Kit spare part number information.</p>

Spare part number	Description
414045-001	512-MB memory module for use in model 2133 (PC2-5300, 667-MHz, DDR2)
414046-001	1024-MB memory module for use in model 2133 (PC2-5300, 667-MHz, DDR2)
417506-001	2048-MB memory module for use in model 2133 (PC2-5300, 667-MHz, DDR2)
441075-001	Broadcom 4311AG 802.11a/b/g WLAN module for use in Canada, the Cayman Islands, Guam, Puerto Rico, the U.S. Virgin Islands, and the United States
441075-002	Broadcom 4311AG 802.11a/b/g WLAN module for use in Afghanistan, Albania, Algeria, Andorra, Angola, Antigua and Barbuda, Argentina, Armenia, Aruba, Australia, Austria, Azerbaijan, the Bahamas, Bahrain, Bangladesh, Barbados, Belarus, Belgium, Belize, Benin, Bermuda, Bhutan, Bolivia, Bosnia and Herzegovina, Botswana, Brazil, the British Virgin Islands, Brunei, Bulgaria, Burkina Faso, Burundi, Cameroon, Cape Verde, the Central African Republic, Chad, Chile, the People's Republic of China, Colombia, Comoros, the Congo, Costa Rica, Croatia, Cyprus, the Czech Republic, Denmark, Djibouti, Dominica, the Dominican Republic, East Timor, Ecuador, Egypt, El Salvador, Equatorial Guinea, Eritrea, Estonia, Ethiopia, Fiji, Finland, France, French Guiana, Gabon, Gambia, Georgia, Germany, Ghana, Gibraltar, Greece, Grenada, Guadeloupe, Guatemala, Guinea, Guinea-Bissau, Guyana, Haiti, Honduras, Hong Kong, Hungary, Iceland, India, Ireland, Israel, Italy, the Ivory Coast, Jamaica, Jordan, Kazakhstan, Kenya, Kiribati, Kyrgyzstan, Laos, Latvia, Lebanon, Lesotho, Liberia, Liechtenstein, Lithuania, Luxembourg, Macedonia, Madagascar, Malawi, Malaysia, the Maldives, Mali, Malta, the Marshall Islands, Martinique, Mauritania, Mauritius, Mexico, Micronesia, Monaco, Mongolia, Montenegro, Morocco, Mozambique, Namibia, Nauru, Nepal, the Nether Antilles, the Netherlands, New Zealand, Nicaragua, Niger, Nigeria, Norway, Oman, Pakistan, Palau, Panama, Papua New Guinea, Paraguay, Peru, the Philippines, Poland, Portugal, the Republic of Moldova, Romania, Russia, Rwanda, Samoa, San Marino, Sao Tome and Principe, Saudi Arabia, Senegal, Serbia, the Seychelles, Sierra Leone, Singapore, Slovakia, Slovenia, the Solomon Islands, Somalia, South Africa, South Korea, Spain, Sri Lanka, St. Kitts and Nevis, St. Lucia, St. Vincent and the Grenadines, Suriname, Swaziland, Sweden, Switzerland, Taiwan, Tajikistan, Tanzania, Togo, Tonga, Trinidad and Tobago, Tunisia, Turkey, Turkmenistan, Tuvalu, Uganda, Ukraine, the United Arab Emirates, the United Kingdom, Uruguay, Uzbekistan, Vanuatu, Venezuela, Vietnam, Yemen, Zaire, Zambia, and Zimbabwe
441075-291	Broadcom 4311AG 802.11a/b/g WLAN module for use in Japan
449137-001	RTC battery for use only in model 2140
450066-001	Bluetooth module for use only in Japan and Asia Pacific countries and regions NOTE: The Bluetooth module spare part kits do not include a Bluetooth module cable. The Bluetooth module cable is included in the Plastics/Cable Kit, spare part number 483381-001 for model 2133, 511751-001 for model 2140. See Plastics/Cable Kit on page 29 for more Plastics/Cable Kit spare part number information.
459263-001	Broadcom BCM4312 802.11b/g WLAN module for use in Canada, the Cayman Islands, Guam, Puerto Rico, the U.S. Virgin Islands, and the United States

Spare part number	Description
459263-002	Broadcom BCM4312 802.11b/g WLAN module for use in Afghanistan, Albania, Algeria, Andorra, Angola, Antigua and Barbuda, Argentina, Armenia, Aruba, Australia, Austria, Azerbaijan, the Bahamas, Bahrain, Bangladesh, Barbados, Belarus, Belgium, Belize, Benin, Bermuda, Bhutan, Bolivia, Bosnia and Herzegovina, Botswana, Brazil, the British Virgin Islands, Brunei, Bulgaria, Burkina Faso, Burundi, Cameroon, Cape Verde, the Central African Republic, Chad, Chile, the People's Republic of China, Colombia, Comoros, the Congo, Costa Rica, Croatia, Cyprus, the Czech Republic, Denmark, Djibouti, Dominica, the Dominican Republic, East Timor, Ecuador, Egypt, El Salvador, Equatorial Guinea, Eritrea, Estonia, Ethiopia, Fiji, Finland, France, French Guiana, Gabon, Gambia, Georgia, Germany, Ghana, Gibraltar, Greece, Grenada, Guadeloupe, Guatemala, Guinea, Guinea-Bissau, Guyana, Haiti, Honduras, Hong Kong, Hungary, Iceland, India, Ireland, Israel, Italy, the Ivory Coast, Jamaica, Jordan, Kazakhstan, Kenya, Kiribati, Kyrgyzstan, Laos, Latvia, Lebanon, Lesotho, Liberia, Liechtenstein, Lithuania, Luxembourg, Macedonia, Madagascar, Malawi, Malaysia, the Maldives, Mali, Malta, the Marshall Islands, Martinique, Mauritania, Mauritius, Mexico, Micronesia, Monaco, Mongolia, Montenegro, Morocco, Mozambique, Namibia, Nauru, Nepal, the Nether Antilles, the Netherlands, New Zealand, Nicaragua, Niger, Nigeria, Norway, Oman, Pakistan, Palau, Panama, Papua New Guinea, Paraguay, Peru, the Philippines, Poland, Portugal, the Republic of Moldova, Romania, Russia, Rwanda, Samoa, San Marino, Sao Tome and Principe, Saudi Arabia, Senegal, Serbia, the Seychelles, Sierra Leone, Singapore, Slovakia, Slovenia, the Solomon Islands, Somalia, South Africa, South Korea, Spain, Sri Lanka, St. Kitts and Nevis, St. Lucia, St. Vincent and the Grenadines, Suriname, Swaziland, Sweden, Switzerland, Taiwan, Tajikistan, Tanzania, Togo, Tonga, Trinidad and Tobago, Tunisia, Turkey, Turkmenistan, Tuvalu, Uganda, Ukraine, the United Arab Emirates, the United Kingdom, Uruguay, Uzbekistan, Vanuatu, Venezuela, Vietnam, Yemen, Zaire, Zambia, and Zimbabwe
463958-001	65-W HP Smart AC adapter
468824-001	RTC battery for use only in model 2133
482262-001	3-cell, 28-Wh Li-ion battery for use only in model 2133
482263-001	6-cell, 55-Wh Li-ion battery for use only in model 2133
482264-001	Base enclosure for use only in model 2133 (includes 4 rubber feet)
482265-001	Top cover for use only in model 2133 (includes power on switch board and cable, TouchPad board and cable, and wireless on/off switch board and cable)
482266-001	Bracket Kit for use only in model 2133 (see Bracket Kit on page 28 for more Bracket Kit spare part number information)
482267-001	120-GB, 5400-rpm hard drive for use in model 2133 (includes bracket and SATA connector)
482268-001	120-GB, 7200-rpm hard drive for use in model 2133 (includes bracket and SATA connector)
482269-001	160-GB, 5400-rpm hard drive for use in model 2133 (includes bracket and SATA connector)
482271-001	160-GB, 7200-rpm hard drive for use in model 2133 (includes bracket and SATA connector)
482272-001	4-GB solid-state drive for use in model 2133 (includes bracket and SATA connector)
482274-001	Audio board for use only in computer models with WXGA displays
482275-001	System board equipped with 1.0-GHz processor and only for use with WXGA displays in model 2133 (includes ExpressCard assembly, fan/heat sink, processor, RTC battery, and replacement thermal material)
482276-001	System board equipped with 1.2-GHz processor and only for use with WXGA displays in model 2133 (includes ExpressCard assembly, fan/heat sink, processor, RTC battery, and replacement thermal material)
482277-001	System board equipped with 1.6-GHz processor and only for use with WXGA displays in model 2133 (includes ExpressCard assembly, fan/heat sink, processor, RTC battery, and replacement thermal material)
482278-001	8.9-inch, WXGA display assembly for use only with 2133 computer models not equipped camera module (includes 2 microphones, 2 speakers, and 2 WLAN antenna transceivers and cables)
482279-001	Fan/heat sink for use only in model 2133 (includes replacement thermal material)

Spare part number	Description
482280-001	Keyboard for use in the United States
482280-031	Keyboard for use in the United Kingdom
482280-041	Keyboard for use in Germany
482280-051	Keyboard for use in France
482280-061	Keyboard for use in Italy
482280-071	Keyboard for use in Spain
482280-081	Keyboard for use in Denmark
482280-091	Keyboard for use in Norway
482280-121	Keyboard for use in French Canada
482280-131	Keyboard for use in Portugal
482280-141	Keyboard for use in Turkey
482280-161	Keyboard for use in Latin America
482280-171	Keyboard for use in Saudi Arabia
482280-181	Keyboard for use in Europe
482280-201	Keyboard for use in Brazil
482280-211	Keyboard for use in Hungary
482280-221	Keyboard for use in Czechoslovakia
482280-231	Keyboard for use in Slovakia
482280-251	Keyboard for use in Russia
482280-281	Keyboard for use in Thailand
482280-291	Keyboard for use in Japan
482280-AB1	Keyboard for use in Taiwan
482280-AD1	Keyboard for use in South Korea
482280-B31	Keyboard for use internationally
482280-B71	Keyboard for use in Sweden and Finland
482280-BA1	Keyboard for use in Slovenia
482280-BB1	Keyboard for use in Israel
482280-BG1	Keyboard for use in Switzerland
482280-DD1	Keyboard for use in Iceland
482280-DJ1	Keyboard for use in Greece
483381-001	Plastics/Cable Kit for use only in model 2133 (see Plastics/Cable Kit on page 29 for more Plastics/Cable Kit spare part number information)
483382-001	Rubber Kit for use only in model 2133 (contains 4 computer feet)
483383-001	Screw Kit for use only in model 2133

Spare part number	Description
483384-001	8.9-inch, WXGA display assembly for use only with 2133 computer models not equipped camera module (includes 2 microphones, 2 speakers, and 2 WLAN antenna transceivers and cables)
487330-001	Broadcom 4322 802.11a/b/g/n WLAN module for use in Antigua and Barbuda, Barbados, Belize, Canada, the Cayman Islands, Guam, Puerto Rico, Trinidad and Tobago, the U.S. Virgin Islands, and the United States
487330-002	Broadcom 4322 802.11a/b/g/n WLAN module for use in Afghanistan, Albania, Algeria, Andorra, Angola, Antigua and Barbuda, Argentina, Armenia, Aruba, Australia, Austria, Azerbaijan, the Bahamas, Bahrain, Bangladesh, Barbados, Belarus, Belgium, Belize, Benin, Bermuda, Bhutan, Bolivia, Bosnia and Herzegovina, Botswana, Brazil, the British Virgin Islands, Brunei, Bulgaria, Burkina Faso, Burundi, Cameroon, Cape Verde, the Central African Republic, Chad, Chile, the People's Republic of China, Colombia, Comoros, the Congo, Costa Rica, Croatia, Cyprus, the Czech Republic, Denmark, Djibouti, Dominica, the Dominican Republic, East Timor, Ecuador, Egypt, El Salvador, Equatorial Guinea, Eritrea, Estonia, Ethiopia, Fiji, Finland, France, French Guiana, Gabon, Gambia, Georgia, Germany, Ghana, Gibraltar, Greece, Grenada, Guadeloupe, Guatemala, Guinea, Guinea-Bissau, Guyana, Haiti, Honduras, Hong Kong, Hungary, Iceland, India, Ireland, Israel, Italy, the Ivory Coast, Jamaica, Jordan, Kazakhstan, Kenya, Kiribati, Kyrgyzstan, Laos, Latvia, Lebanon, Lesotho, Liberia, Liechtenstein, Lithuania, Luxembourg, Macedonia, Madagascar, Malawi, Malaysia, the Maldives, Mali, Malta, the Marshall Islands, Martinique, Mauritania, Mauritius, Mexico, Micronesia, Monaco, Mongolia, Montenegro, Morocco, Mozambique, Namibia, Nauru, Nepal, the Nether Antilles, the Netherlands, New Zealand, Nicaragua, Niger, Nigeria, Norway, Oman, Pakistan, Palau, Panama, Papua New Guinea, Paraguay, Peru, the Philippines, Poland, Portugal, the Republic of Moldova, Romania, Russia, Rwanda, Samoa, San Marino, Sao Tome and Principe, Saudi Arabia, Senegal, Serbia, the Seychelles, Sierra Leone, Singapore, Slovakia, Slovenia, the Solomon Islands, Somalia, South Africa, South Korea, Spain, Sri Lanka, St. Kitts and Nevis, St. Lucia, St. Vincent and the Grenadines, Suriname, Swaziland, Sweden, Switzerland, Taiwan, Tajikistan, Tanzania, Togo, Tonga, Trinidad and Tobago, Tunisia, Turkey, Turkmenistan, Tuvalu, Uganda, Ukraine, the United Arab Emirates, the United Kingdom, Uruguay, Uzbekistan, Vanuatu, Venezuela, Vietnam, Yemen, Zaire, Zambia, and Zimbabwe
498308-001	System board equipped with 1.2-GHz processor only for use in model 2133 (includes ExpressCard assembly, fan/heat sink, processor, RTC battery, and replacement thermal material)
498309-001	8.9-inch, WSVGA display assembly for use only with computer model 2133 equipped with a camera module and system boards with the following spare part numbers: 498308-001, 500754-001, and 500755-001 (includes 2 microphones, 2 speakers, and 2 WLAN antenna transceivers and cables)
500459-001	8.9-inch, WSVGA display assembly for use only with computer model 2133 not equipped with a camera module and system boards with the following spare part numbers: 498308-001, 500754-001, and 500755-001 (includes 2 microphones, 2 speakers, and 2 WLAN antenna transceivers and cables)
500754-001	System board equipped with 1.0-GHz processor only for use in model 2133 (includes ExpressCard assembly, fan/heat sink, processor, RTC battery, and replacement thermal material)
500755-001	System board equipped with 1.6-GHz processor only for use in model 2133 (includes ExpressCard assembly, fan/heat sink, processor, RTC battery, and replacement thermal material)
502600-001	80-GB solid-state drive for use in model 2133 (includes bracket and SATA connector)
505907-001	Audio board
511743-001	10.1-inch, WXGA display assembly for use only with SD computer models equipped camera module (includes 2 microphones, 2 speakers, and 2 WLAN antenna transceivers and cables)
511744-001	10.1-inch, WXGA display assembly for use only with HD computer models equipped camera module (includes 2 microphones, 2 speakers, and 2 WLAN antenna transceivers and cables)
511745-001	System board equipped with 1.6-GHz processor only for use in model 2140 (includes ExpressCard assembly, fan/heat sink, processor, RTC battery, and replacement thermal material)
511746-001	3-cell, 28-Wh Li-ion battery for use only in model 2140
511747-001	6-cell, 55-Wh Li-ion battery for use only in model 2140
511748-001	Base enclosure for use only in model 2140 (includes 4 rubber feet)

Spare part number	Description
511749-001	Top cover for use only in model 2140 (includes power on switch board and cable, TouchPad board and cable, and wireless on/off switch board and cable)
511750-001	Fan/heat sink for use only in model 2140 (includes replacement thermal material)
511751-001	Plastics/Cable Kit for use only in model 2140 (see Plastics/Cable Kit on page 29 for more Plastics/Cable Kit spare part number information)
511752-001	Rubber Kit for use only in model 2140 (contains 4 computer feet)
511753-001	Screw Kit for use only in model 2140
511754-001	1024-MB memory module for use in model 2140 (PC2-5300, 667-MHz, DDR2)
511755-001	2048-MB memory module for use in model 2140 (PC2-5300, 667-MHz, DDR2)
511901-001	80-GB solid state drive for use in model 2140 (includes bracket and SATA connector)
511903-001	160-GB, 5400-rpm hard drive for use in model 2140 (includes bracket and SATA connector)
511904-001	160-GB, 7200-rpm hard drive for use in model 2140 (includes bracket and SATA connector)

4 Removal and replacement procedures

Preliminary replacement requirements

Tools required

You will need the following tools to complete the removal and replacement procedures:

- Flat-bladed screwdriver
- Magnetic screwdriver
- Phillips P0 and P1 screwdrivers
- Torx8 T8 screwdriver

Service considerations

The following sections include some of the considerations that you must keep in mind during disassembly and assembly procedures.

 **NOTE:** As you remove each subassembly from the computer, place the subassembly (and all accompanying screws) away from the work area to prevent damage.

Plastic parts

 **CAUTION:** Using excessive force during disassembly and reassembly can damage plastic parts. Use care when handling the plastic parts. Apply pressure only at the points designated in the maintenance instructions.

Cables and connectors

-
- △ **CAUTION:** When servicing the computer, be sure that cables are placed in their proper locations during the reassembly process. Improper cable placement can damage the computer.
-

Cables must be handled with extreme care to avoid damage. Apply only the tension required to unseat or seat the cables during removal and insertion. Handle cables by the connector whenever possible. In all cases, avoid bending, twisting, or tearing cables. Be sure that cables are routed in such a way that they cannot be caught or snagged by parts being removed or replaced. Handle flex cables with extreme care; these cables tear easily.

Drive handling

-
- △ **CAUTION:** Drives are fragile components that must be handled with care. To prevent damage to the computer, damage to a drive, or loss of information, observe these precautions:
-

Before removing or inserting a hard drive, shut down the computer. If you are unsure whether the computer is off or in Hibernation, turn the computer on, and then shut it down through the operating system.

Before handling a drive, be sure that you are discharged of static electricity. While handling a drive, avoid touching the connector.

Before removing a diskette drive or optical drive, be sure that a diskette or disc is not in the drive and be sure that the optical drive tray is closed.

Handle drives on surfaces covered with at least one inch of shock-proof foam.

Avoid dropping drives from any height onto any surface.

After removing a hard drive, an optical drive, or a diskette drive, place it in a static-proof bag.

Avoid exposing a hard drive to products that have magnetic fields, such as monitors or speakers.

Avoid exposing a drive to temperature extremes or liquids.

If a drive must be mailed, place the drive in a bubble pack mailer or other suitable form of protective packaging and label the package "FRAGILE."

Grounding guidelines

Electrostatic discharge damage

Electronic components are sensitive to electrostatic discharge (ESD). Circuitry design and structure determine the degree of sensitivity. Networks built into many integrated circuits provide some protection, but in many cases, ESD contains enough power to alter device parameters or melt silicon junctions.

A discharge of static electricity from a finger or other conductor can destroy static-sensitive devices or microcircuitry. Even if the spark is neither felt nor heard, damage may have occurred.

An electronic device exposed to ESD may not be affected at all and can work perfectly throughout a normal cycle. Or the device may function normally for a while, then degrade in the internal layers, reducing its life expectancy.

- △ **CAUTION:** To prevent damage to the computer when you are removing or installing internal components, observe these precautions:

Keep components in their electrostatic-safe containers until you are ready to install them.

Use nonmagnetic tools.

Before touching an electronic component, discharge static electricity by using the guidelines described in this section.

Avoid touching pins, leads, and circuitry. Handle electronic components as little as possible.

If you remove a component, place it in an electrostatic-safe container.

The following table shows how humidity affects the electrostatic voltage levels generated by different activities.

- △ **CAUTION:** A product can be degraded by as little as 700 V.

Typical electrostatic voltage levels			
Event	Relative humidity		
	10%	40%	55%
Walking across carpet	35,000 V	15,000 V	7,500 V
Walking across vinyl floor	12,000 V	5,000 V	3,000 V
Motions of bench worker	6,000 V	800 V	400 V
Removing DIPS from plastic tube	2,000 V	700 V	400 V
Removing DIPS from vinyl tray	11,500 V	4,000 V	2,000 V
Removing DIPS from Styrofoam	14,500 V	5,000 V	3,500 V
Removing bubble pack from PCB	26,500 V	20,000 V	7,000 V
Packing PCBs in foam-lined box	21,000 V	11,000 V	5,000 V

Packaging and transporting guidelines

Follow these grounding guidelines when packaging and transporting equipment:

- To avoid hand contact, transport products in static-safe tubes, bags, or boxes.
- Protect ESD-sensitive parts and assemblies with conductive or approved containers or packaging.
- Keep ESD-sensitive parts in their containers until the parts arrive at static-free workstations.
- Place items on a grounded surface before removing items from their containers.
- Always be properly grounded when touching a component or assembly.
- Store reusable ESD-sensitive parts from assemblies in protective packaging or nonconductive foam.
- Use transporters and conveyors made of antistatic belts and roller bushings. Be sure that mechanized equipment used for moving materials is wired to ground and that proper materials are selected to avoid static charging. When grounding is not possible, use an ionizer to dissipate electric charges.

Workstation guidelines

Follow these grounding workstation guidelines:

- Cover the workstation with approved static-shielding material.
- Use a wrist strap connected to a properly grounded work surface and use properly grounded tools and equipment.
- Use conductive field service tools, such as cutters, screwdrivers, and vacuums.
- When fixtures must directly contact dissipative surfaces, use fixtures made only of static-safe materials.
- Keep the work area free of nonconductive materials, such as ordinary plastic assembly aids and Styrofoam.
- Handle ESD-sensitive components, parts, and assemblies by the case or PCM laminate. Handle these items only at static-free workstations.
- Avoid contact with pins, leads, or circuitry.
- Turn off power and input signals before inserting or removing connectors or test equipment.

Equipment guidelines

Grounding equipment must include either a wrist strap or a foot strap at a grounded workstation.

- When seated, wear a wrist strap connected to a grounded system. Wrist straps are flexible straps with a minimum of one megohm $\pm 10\%$ resistance in the ground cords. To provide proper ground, wear a strap snugly against the skin at all times. On grounded mats with banana-plug connectors, use alligator clips to connect a wrist strap.
- When standing, use foot straps and a grounded floor mat. Foot straps (heel, toe, or boot straps) can be used at standing workstations and are compatible with most types of shoes or boots. On conductive floors or dissipative floor mats, use foot straps on both feet with a minimum of one megohm resistance between the operator and ground. To be effective, the conductive strips must be worn in contact with the skin.

The following grounding equipment is recommended to prevent electrostatic damage:

- Antistatic tape
- Antistatic smocks, aprons, and sleeve protectors
- Conductive bins and other assembly or soldering aids
- Nonconductive foam
- Conductive tabletop workstations with ground cords of one megohm resistance
- Static-dissipative tables or floor mats with hard ties to the ground
- Field service kits
- Static awareness labels
- Material-handling packages
- Nonconductive plastic bags, tubes, or boxes
- Metal tote boxes
- Electrostatic voltage levels and protective materials

The following table lists the shielding protection provided by antistatic bags and floor mats.

Material	Use	Voltage protection level
Antistatic plastic	Bags	1,500 V
Carbon-loaded plastic	Floor mats	7,500 V
Metallized laminate	Floor mats	5,000 V

Unknown user password

If the computer you are servicing has an unknown user password, follow these steps to clear the password:



NOTE: These steps also clear CMOS.

1. Shut down the computer. If you are unsure whether the computer is off or in Hibernation, turn the computer on, and then shut it down through the operating system.
2. Disconnect all external devices connected to the computer.
3. Disconnect the power from the computer by first unplugging the power cord from the AC outlet and then unplugging the AC adapter from the computer.
4. Remove the battery (see [Battery on page 44](#)).
5. Remove the real-time clock (RTC) battery (see [RTC battery on page 66](#)).
6. Wait approximately 5 minutes.
7. Replace the RTC battery and reassemble the computer.
8. Connect AC power to the computer. Do not reinsert any batteries at this time.
9. Turn on the computer.

All passwords and all CMOS settings have been cleared.

Component replacement procedures

This chapter provides removal and replacement procedures.

There are as many as 31 screws, in 5 different sizes, that must be removed or replaced when servicing the computer. Make special note of each screw size and location during removal and replacement.

Serial number

Report the computer serial number to HP when requesting information or ordering spare parts. The serial number is located on the bottom of the computer.

Model 2133:



Model 2140:



Computer feet

The computer feet are adhesive-backed rubber pads. The feet are included in the Rubber Kit, spare part number 483382-001 for model 2133, 511752-001 for model 2140. There are 4 rubber feet that are installed on the base enclosure in the locations illustrated below. On model 2133, the rubber feet are attached to the base enclosure by tethers.

Model 2133:

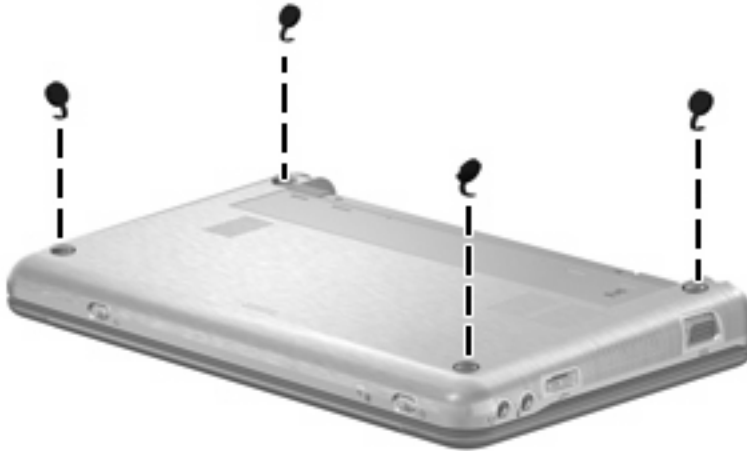

Model 2140:



Battery

Description	Spare part number
For use only in model 2133:	
6-cell, 55-Wh Li-ion battery	482262-001
3-cell, 28-Wh Li-ion battery	482263-001
For use only in model 2140:	
6-cell, 55-Wh Li-ion battery	511747-001
3-cell, 28-Wh Li-ion battery	511746-001

Before disassembling the computer, follow these steps:

1. Shut down the computer. If you are unsure whether the computer is off or in Hibernation, turn the computer on, and then shut it down through the operating system.
2. Disconnect all external devices connected to the computer.
3. Disconnect the power from the computer by first unplugging the power cord from the AC outlet and then unplugging the AC adapter from the computer.

Remove the battery:

1. Turn the computer upside down on a flat surface, with the battery bay toward you.
2. Slide the battery release latches (1) to release the battery.
3. Remove the battery (2) from the computer.

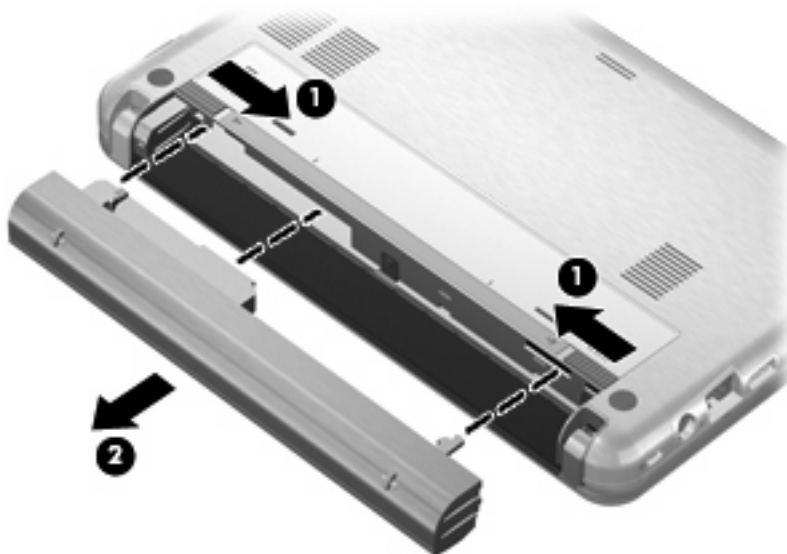

Install the battery by inserting it into the battery bay until you hear a click.

Keyboard

Keyboards for use in the following countries or regions:

Country or region:	Spare part number	Country or region:	Spare part number
Brazil	482280-201	Norway	482280-091
Czechoslovakia	482280-221	Portugal	482280-131
Denmark	482280-081	Russia	482280-251
Europe	482280-181	Saudi Arabia	482280-171
France	482280-051	Slovakia	482280-231
French Canada	482280-121	Slovenia	482280-BA1
Germany	482280-041	South Korea	482280-AD1
Greece	482280-DJ1	Spain	482280-071
Hungary	482280-211	Sweden and Finland	482280-B71
Iceland	482280-DD1	Switzerland	482280-BG1
International	482280-B31	Taiwan	482280-AB1
Israel	482280-BB1	Thailand	482280-281
Italy	482280-061	Turkey	482280-141
Japan	482280-291	The United Kingdom	482280-031
Latin America	482280-161	The United States	482280-001

Before removing the keyboard, follow these steps:

1. Shut down the computer. If you are unsure whether the computer is off or in Hibernation, turn the computer on, and then shut it down through the operating system.
2. Disconnect all external devices connected to the computer.
3. Disconnect the power from the computer by first unplugging the power cord from the AC outlet and then unplugging the AC adapter from the computer.
4. Remove the battery (see [Battery on page 44](#)).

Remove the keyboard:

1. Remove the three Phillips PM2.0×3.0 screws that secure the keyboard to the computer.



2. Turn the computer display-side up, with the front toward you.
3. Open the computer as far as possible.
4. Lift the rear edge of the keyboard (1) until it rests at an angle, and then slide it back (2) until it rests on the display assembly.



5. Release the zero insertion force (ZIF) connector (1) to which the keyboard cable is attached, and disconnect the keyboard cable (2) from the system board.

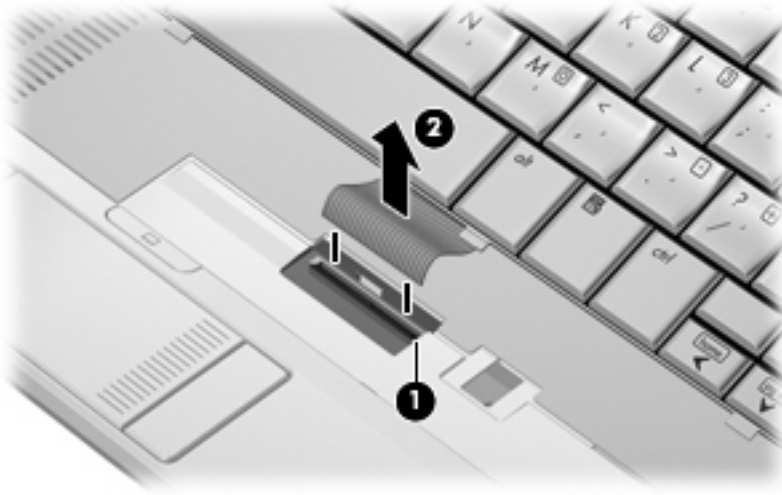

6. Remove the keyboard.

Reverse this procedure to install the keyboard.

Memory module

Description	Spare part number
For use in model 2133:	
2048-MB (PC2-5300, 667-MHz, DDR2)	417506-001
1024-MB (PC2-5300, 667-MHz, DDR2)	414046-001
512-MB (PC2-5300, 667-MHz, DDR2)	414045-001
For use in model 2140:	
2048-MB (PC2-5300, 667-MHz, DDR2)	511755-001
1024-MB (PC2-5300, 667-MHz, DDR2)	511754-001

Before removing the memory module, follow these steps:

1. Shut down the computer. If you are unsure whether the computer is off or in Hibernation, turn the computer on, and then shut it down through the operating system.
2. Disconnect all external devices connected to the computer.
3. Disconnect the power from the computer by first unplugging the power cord from the AC outlet and then unplugging the AC adapter from the computer.
4. Remove the battery (see [Battery on page 44](#)).
5. Remove the keyboard (see [Keyboard on page 45](#)).

Remove the memory module:

1. Spread the retaining tabs **(1)** on each side of the memory module slot to release the memory module. (The edge of the module opposite the slot rises away from the computer.)
2. Remove the memory module **(2)** by pulling the module away from the slot at an angle.

 **NOTE:** Memory modules are designed with a notch **(3)** to prevent incorrect insertion into the memory module slot.

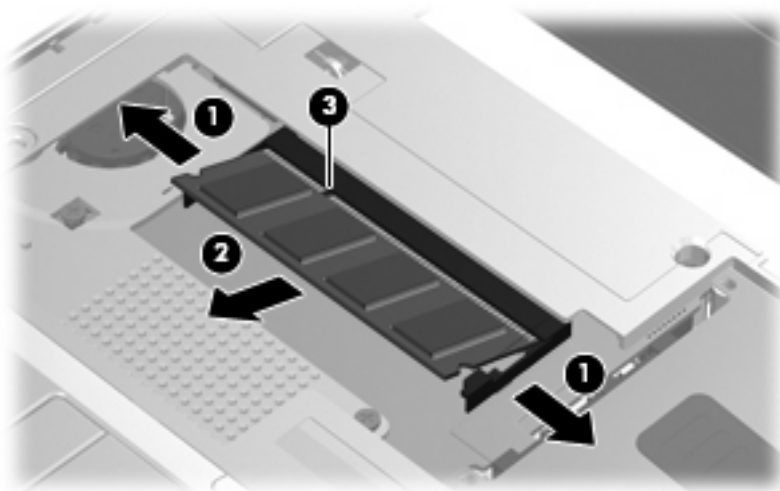

Reverse this procedure to install a memory module.

Mass storage device

 **NOTE:** All hard drive and solid-state drive spare part kits include a bracket and SATA adapter.

Description	Spare part number
For use only in model 2133:	
160-GB, 7200-rpm hard drive	482271-001
160-GB, 5400-rpm hard drive	482269-001
120-GB, 7200-rpm hard drive	482268-001
120-GB, 5400-rpm hard drive	482267-001
80-GB solid state drive	502600-001
4-GB solid state drive	482272-001
For use only in model 2140:	
160-GB, 7200-rpm hard drive	511904-001
160-GB, 5400-rpm hard drive	511903-001
80-GB solid state drive	511901-001

Before removing the hard drive or solid-state drive, follow these steps:

1. Shut down the computer. If you are unsure whether the computer is off or in Hibernation, turn the computer on, and then shut it down through the operating system.
2. Disconnect all external devices connected to the computer.
3. Disconnect the power from the computer by first unplugging the power cord from the AC outlet and then unplugging the AC adapter from the computer.
4. Remove the battery (see [Battery on page 44](#)).
5. Remove the keyboard (see [Keyboard on page 45](#)).

If you have model 2133, remove the hard drive or solid-state drive:

1. Disconnect the drive cable (1) from the connector on the system board (2).

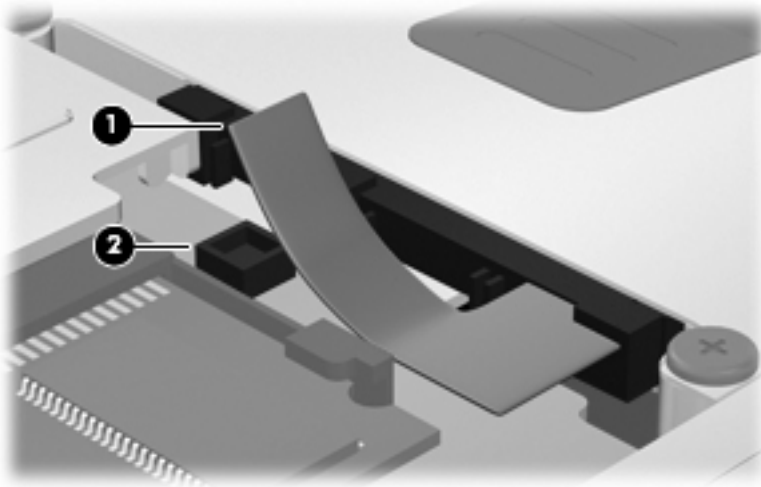

2. Remove the Phillips PM2.0×5.0 screw (1) and the two PM2.0×5.0 screws (2) that secure the drive to the computer.



NOTE: The screw highlighted by callout (1) is captive in hard drives, non-captive in solid state drives.

3. Grasp the Mylar tab (3) on the drive and slide the drive (4) to the left to release it from the drive bay.
4. Remove the drive (5) from the drive bay.

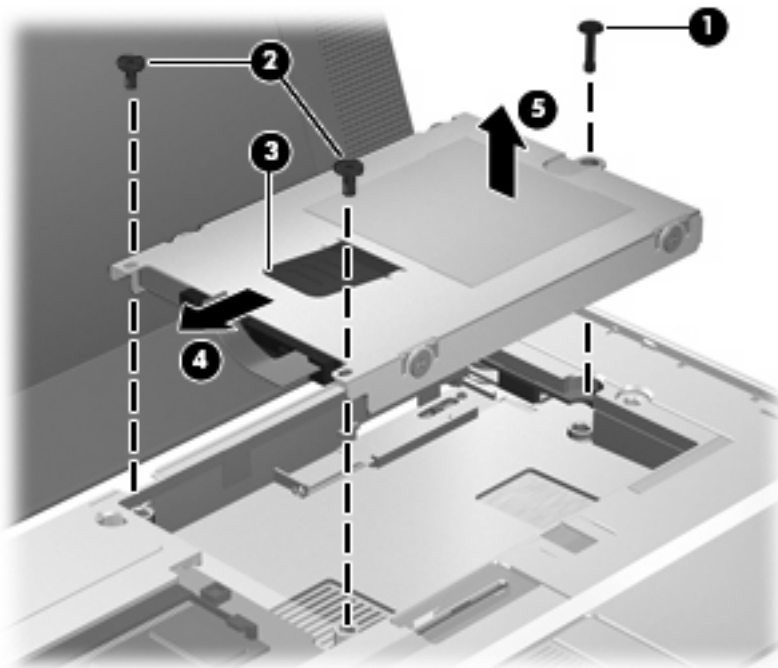

If you have model 2140, remove the hard drive or solid-state drive:

1. Disconnect the drive cable (1) from the connector on the system board (2).

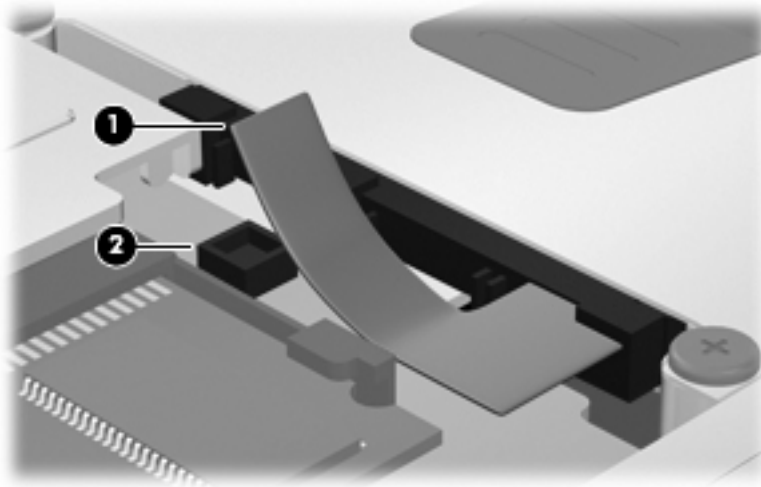

2. Remove the two PM2.0×5.0 screws (1) that secure the rear of the drive to the computer.
3. Loosen the captive PM2.0×5.0 screw (2) that secures the front of the drive to the computer.
4. Grasp the Mylar tab (3) on the drive and slide the drive (4) to the right to release it from the drive bay.
5. Remove the drive (5) from the drive bay.

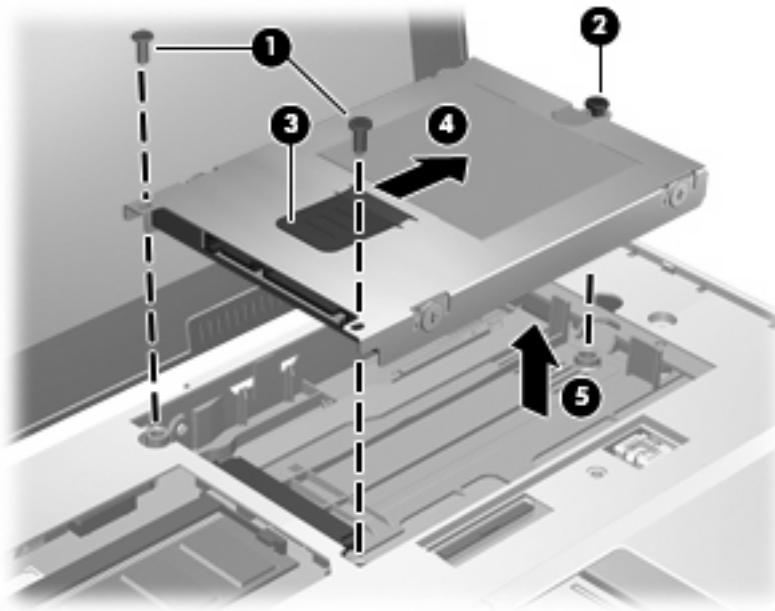

Reverse this procedure to install the hard drive or solid-state drive.

Top cover

Description	Spare part number
Top cover for use only in model 2133	482265-001
Top cover for use only in model 2140	511749-001

Before removing the top cover, follow these steps:

1. Shut down the computer. If you are unsure whether the computer is off or in Hibernation, turn the computer on, and then shut it down through the operating system.
2. Disconnect all external devices connected to the computer.
3. Disconnect the power from the computer by first unplugging the power cord from the AC outlet and then unplugging the AC adapter from the computer.
4. Remove the battery (see [Battery on page 44](#)).
5. Remove the keyboard (see [Keyboard on page 45](#)).
6. Remove the hard drive or solid-state drive (see [Mass storage device on page 49](#)).

Remove the top cover:

1. Turn the computer upside down, with the front toward you.
 2. Use a thin, flat tool to release the four rubber feet **(1)**.
- △ **CAUTION:** On model 2133, the rubber feet are attached to the base enclosure by tethers. Exercise caution when releasing the rubber feet to prevent damaging the feet.
3. On model 2133, remove the three Torx8 T8M2.5×10.0 screws **(2)** and the Torx8 T8M2.0×4.0 screw **(3)** that secure the top cover to the base enclosure.

On model 2140, remove the three Phillips PM2.0×7.0 screws **(2)** and the Phillips PM3.0×3.0 screw **(3)** that secure the top cover to the base enclosure.

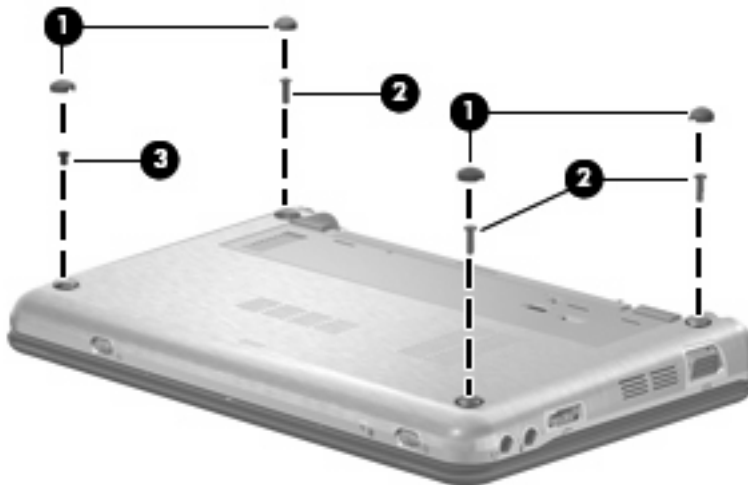

 **NOTE:** Model 2140 is illustrated. Model 2133 uses tethered feet and slightly different screw sizes.

4. Turn the computer right-side up, with the front toward you.
5. Open the computer as far as possible.
6. On model 2133, remove the Torx8 T8M2.5×10.0 screw (1) that secures the top cover to the base enclosure, and then lift the rear edge of the top cover (2) and swing it up and forward until it rests upside down in front of the computer.

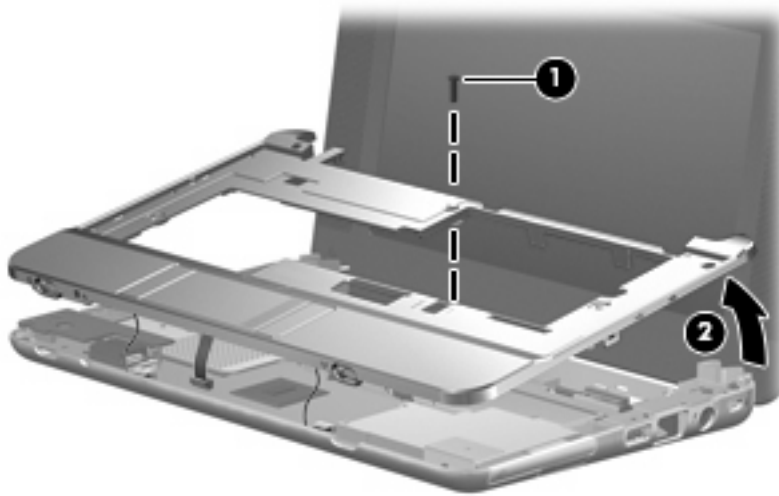

On model 2140, remove the four Phillips PM2.0×7.0 screws (1) that secure the top cover to the base enclosure, and then lift the rear edge of the top cover (2) and swing it up and forward until it rests upside down in front of the computer.

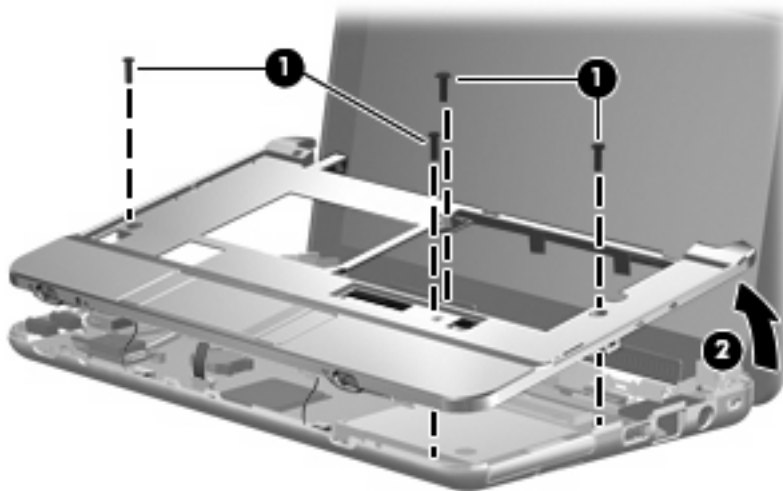

7. Disconnect the power switch board cable (1) from the system board.
8. Release the ZIF connector (2) to which the TouchPad cable is connected and disconnect the TouchPad cable (3) from the system board.

9. Disconnect the wireless on/off switch board cable (4) from the system board.

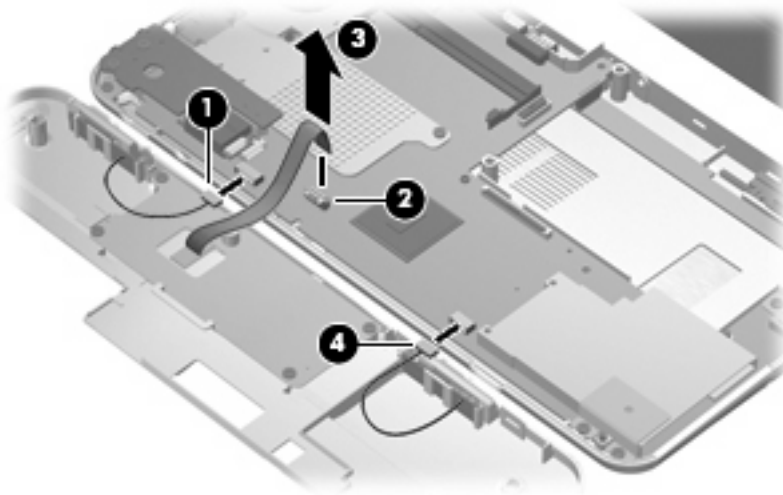

10. Remove the top cover.

Reverse this procedure to install the top cover.

Audio board (Model 2133 only)

 **NOTE:** The audio board is available only for model 2133. Audio is integrated into the model 2140 system board.

Description	Spare part number
Audio board for use only in computer models with WXGA displays	482274-001
Audio board	505907-001

Before removing the audio board, follow these steps:

1. Shut down the computer. If you are unsure whether the computer is off or in Hibernation, turn the computer on, and then shut it down through the operating system.
2. Disconnect all external devices connected to the computer.
3. Disconnect the power from the computer by first unplugging the power cord from the AC outlet and then unplugging the AC adapter from the computer.
4. Remove the battery (see [Battery on page 44](#)).
5. Remove the following components:
 - a. Keyboard (see [Keyboard on page 45](#))
 - b. Hard drive or solid-state drive (see [Mass storage device on page 49](#))
 - c. Top cover (see [Top cover on page 52](#))

Remove the audio board:

1. Remove the Torx8 T8M2.0×6.0 screw that secures the audio board to the computer.

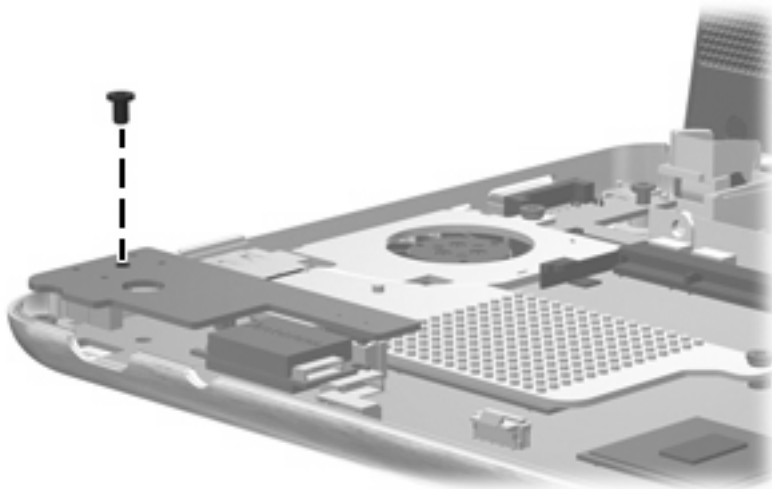

2. Lift the audio board (1) to disconnect the audio board connector (2) from the system board.

3. Disconnect the audio board cables (3) from the audio board.

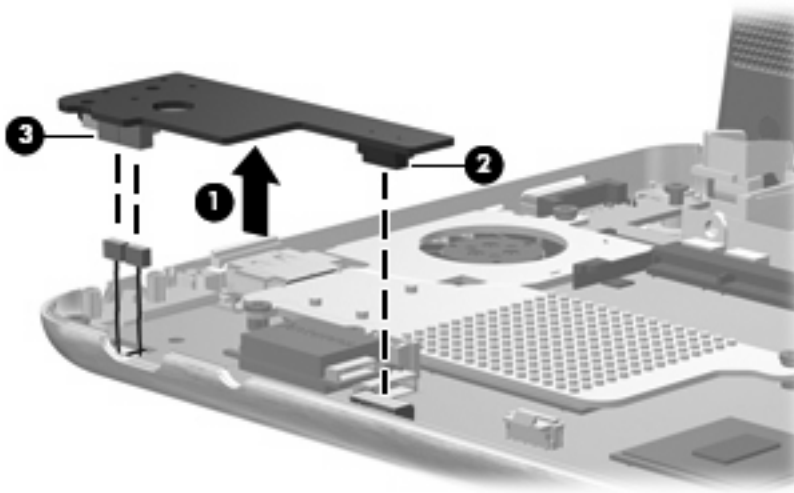

4. Remove the audio board.

Reverse this procedure to install the audio board.

Bluetooth module

 **NOTE:** The Bluetooth module spare part kits do not include a Bluetooth module cable. The Bluetooth module cable is included in the Plastics/Cable Kit, spare part number 483381-001 for model 2133, 511751-001 for model 2140. See [Plastics/Cable Kit on page 29](#) for more Plastics/Cable Kit spare part number information.

Description	Spare part number
For use in all countries and regions except Japan and Asia Pacific countries and regions	398393-002
For use only Japan and Asia Pacific countries and regions	450066-001

Before removing the Bluetooth module, follow these steps:

1. Shut down the computer. If you are unsure whether the computer is off or in Hibernation, turn the computer on, and then shut it down through the operating system.
2. Disconnect all external devices connected to the computer.
3. Disconnect the power from the computer by first unplugging the power cord from the AC outlet and then unplugging the AC adapter from the computer.
4. Remove the battery (see [Battery on page 44](#)).
5. Remove the following components:
 - a. Keyboard (see [Keyboard on page 45](#))
 - b. Hard drive or solid-state drive (see [Mass storage device on page 49](#))
 - c. Top cover (see [Top cover on page 52](#))
 - d. Audio board (see [Audio board \(Model 2133 only\) on page 55](#))

Remove the Bluetooth module:

1. Detach the Bluetooth module **(1)** from the system board.

 **NOTE:** The Bluetooth module is attached to the system board by double-sided tape.

2. Disconnect the Bluetooth module cable (2) from the Bluetooth module.

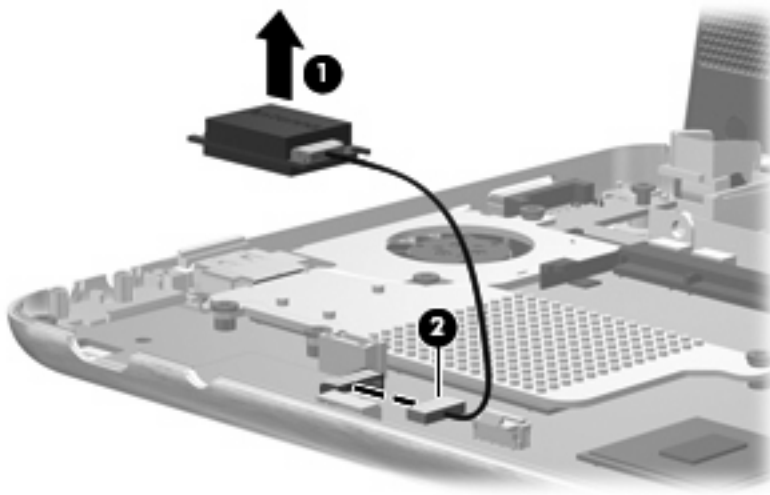

3. Remove the Bluetooth module.

Reverse this procedure to install the Bluetooth module.

System board

 **NOTE:** All system board spare part kits include an ExpressCard assembly, fan/heat sink, processor, RTC battery, and replacement thermal material).

Description	Spare part number
For use only in model 2133:	
Equipped with 1.6-GHz processor and only for use with WXGA displays	482277-001
Equipped with 1.2-GHz processor and only for use with WXGA displays	482276-001
Equipped with 1.0-GHz processor and only for use with WXGA displays	482275-001
Equipped with 1.6-GHz processor	500755-001
Equipped with 1.2-GHz processor	398308-001
Equipped with 1.0-GHz processor	500754-001
For use only in model 2140:	
Equipped with 1.6-GHz processor	511745-001

Before removing the system board, follow these steps:

1. Shut down the computer. If you are unsure whether the computer is off or in Hibernation, turn the computer on, and then shut it down through the operating system.
2. Disconnect all external devices connected to the computer.
3. Disconnect the power from the computer by first unplugging the power cord from the AC outlet and then unplugging the AC adapter from the computer.
4. Remove the battery (see [Battery on page 44](#)).
5. Remove the following components:
 - a. Keyboard (see [Keyboard on page 45](#))
 - b. Hard drive (see [Mass storage device on page 49](#))
 - c. Top cover (see [Top cover on page 52](#))
 - d. Audio board (see [Audio board \(Model 2133 only\) on page 55](#))

When replacing the system board, be sure that the following components are removed from the defective system board and installed on the replacement system board:

- Memory module (see [Memory module on page 48](#))
- WLAN module (see [WLAN module on page 63](#))

Remove the system board:

1. Disconnect the following cables from the system board:
 - (1) Display panel cable
 - (2) Microphone cable
 - (3) Camera module cable (only on computer models equipped with webcam)

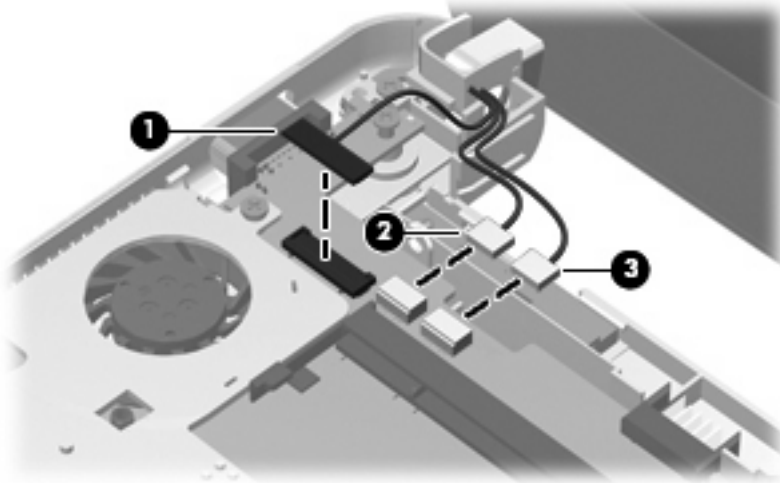

2. Remove the wireless antenna cables from the clips built onto the system board.

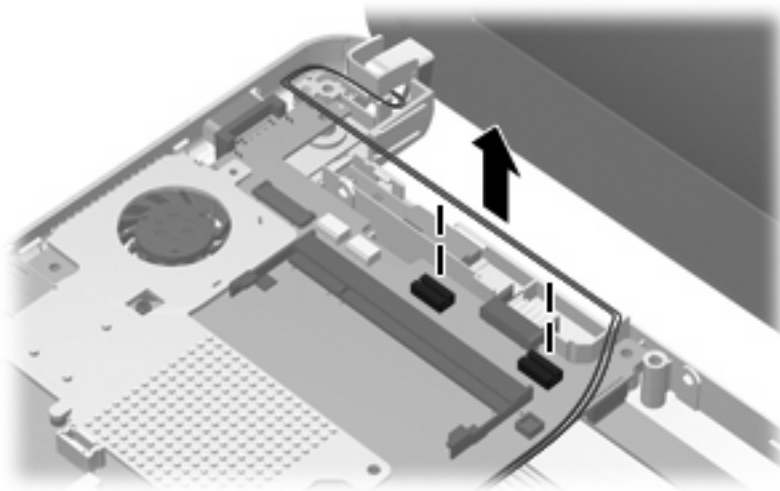

3. If you have model 2140, go to step 5. For model 2133, remove the seven Torx8 T8M2.0×6.0 screws (1) that secure the system board and the three system board brackets to the base enclosure.

4. Remove the following brackets:
 - (2) (Model 2133 only) Audio/USB connector bracket
 - (3) (Model 2133 and 2140) ExpressCard assembly bracket
 - (4) (Model 2133 only) USB/RJ-45 connector bracket

 **NOTE:** For model 2133 only, the audio/USB connector bracket, ExpressCard assembly bracket, and USB/RJ-45 connector bracket are included in the Bracket Kit, spare part number 482266-001.

NOTE: For model 2140, the ExpressCard assembly bracket is included in the Plastics Kit, spare part number 511751-001.

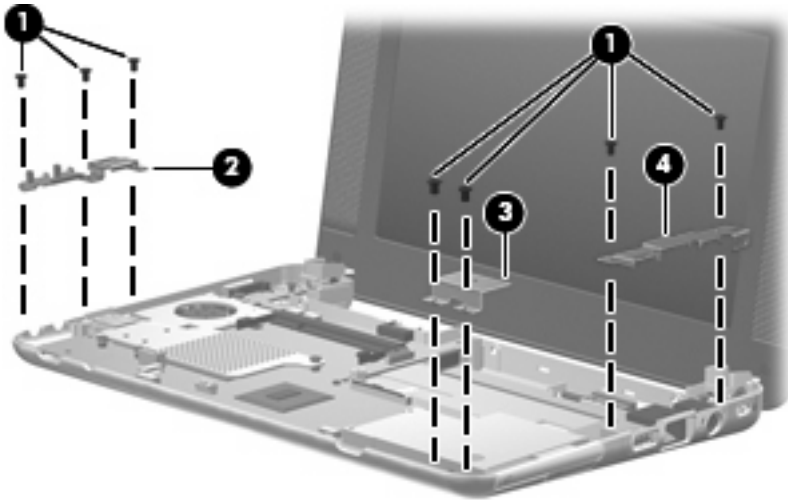

5. If you have model 2133, go to step 6. For model 2140, remove the two Torx8 T8M2.0×6.0 screws that secure the system board and the ExpressCard assembly bracket to the base enclosure.



6. Flex the right side of the base enclosure (1) until the USB connector and RJ-45 jack (2) are clear of the base enclosure.

7. Lift the right side of the system board (3), and then swing it up and to the left until it rests upside down on the left side of the computer.

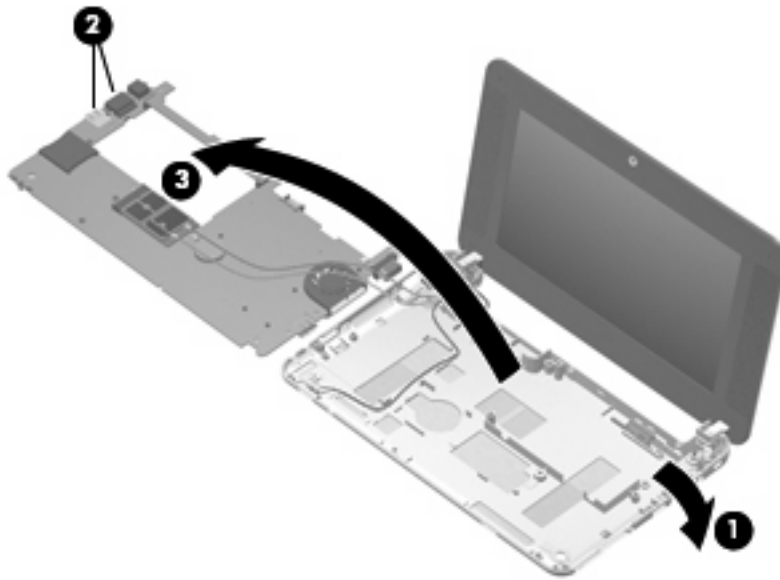

8. Disconnect the WLAN antenna cables from the terminals on the WLAN module.

 **NOTE:** The black WLAN antenna cable is connected to the WLAN module “Main” terminal. The white WLAN antenna cable is connected to the WLAN module “Aux” terminal.

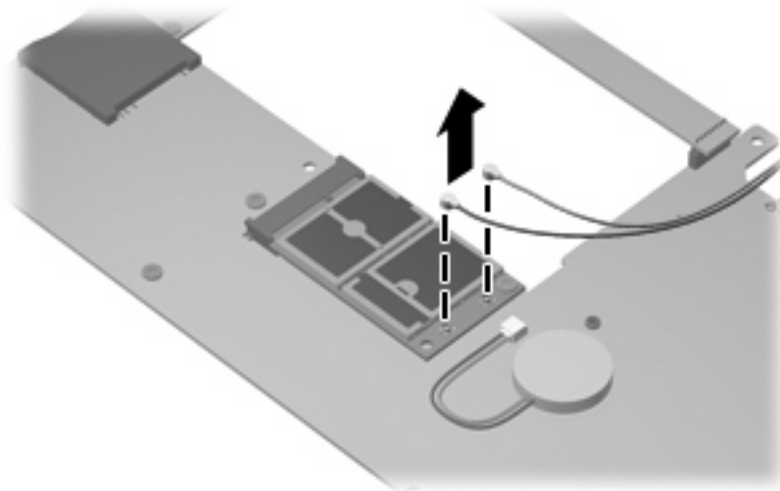

9. Remove the system board.

Reverse the preceding procedure to install the system board.

WLAN module

Description	Spare part number
Broadcom 4311AG 802.11a/b/g WLAN modules:	
<ul style="list-style-type: none"> For use in Canada, the Cayman Islands, Guam, Puerto Rico, the U.S. Virgin Islands, and the United States 	441075-001
<ul style="list-style-type: none"> For use in Afghanistan, Albania, Algeria, Andorra, Angola, Antigua and Barbuda, Argentina, Armenia, Aruba, Australia, Austria, Azerbaijan, the Bahamas, Bahrain, Bangladesh, Barbados, Belarus, Belgium, Belize, Benin, Bermuda, Bhutan, Bolivia, Bosnia and Herzegovina, Botswana, Brazil, the British Virgin Islands, Brunei, Bulgaria, Burkina Faso, Burundi, Cameroon, Cape Verde, the Central African Republic, Chad, Chile, the People's Republic of China, Colombia, Comoros, the Congo, Costa Rica, Croatia, Cyprus, the Czech Republic, Denmark, Djibouti, Dominica, the Dominican Republic, East Timor, Ecuador, Egypt, El Salvador, Equatorial Guinea, Eritrea, Estonia, Ethiopia, Fiji, Finland, France, French Guiana, Gabon, Gambia, Georgia, Germany, Ghana, Gibraltar, Greece, Grenada, Guadeloupe, Guatemala, Guinea, Guinea-Bissau, Guyana, Haiti, Honduras, Hong Kong, Hungary, Iceland, India, Ireland, Israel, Italy, the Ivory Coast, Jamaica, Jordan, Kazakhstan, Kenya, Kiribati, Kyrgyzstan, Laos, Latvia, Lebanon, Lesotho, Liberia, Liechtenstein, Lithuania, Luxembourg, Macedonia, Madagascar, Malawi, Malaysia, the Maldives, Mali, Malta, the Marshall Islands, Martinique, Mauritania, Mauritius, Mexico, Micronesia, Monaco, Mongolia, Montenegro, Morocco, Mozambique, Namibia, Nauru, Nepal, the Nether Antilles, the Netherlands, New Zealand, Nicaragua, Niger, Nigeria, Norway, Oman, Pakistan, Palau, Panama, Papua New Guinea, Paraguay, Peru, the Philippines, Poland, Portugal, the Republic of Moldova, Romania, Russia, Rwanda, Samoa, San Marino, Sao Tome and Principe, Saudi Arabia, Senegal, Serbia, the Seychelles, Sierra Leone, Singapore, Slovakia, Slovenia, the Solomon Islands, Somalia, South Africa, South Korea, Spain, Sri Lanka, St. Kitts and Nevis, St. Lucia, St. Vincent and the Grenadines, Suriname, Swaziland, Sweden, Switzerland, Taiwan, Tajikistan, Tanzania, Togo, Tonga, Trinidad and Tobago, Tunisia, Turkey, Turkmenistan, Tuvalu, Uganda, Ukraine, the United Arab Emirates, the United Kingdom, Uruguay, Uzbekistan, Vanuatu, Venezuela, Vietnam, Yemen, Zaire, Zambia, and Zimbabwe 	441075-002
<ul style="list-style-type: none"> For use in Japan 	441075-291
Broadcom BCM4312 802.11b/g WLAN modules:	
<ul style="list-style-type: none"> For use in Canada, the Cayman Islands, Guam, Puerto Rico, the U.S. Virgin Islands, and the United States 	459263-001

Description	Spare part number
<ul style="list-style-type: none"> For use in Afghanistan, Albania, Algeria, Andorra, Angola, Antigua and Barbuda, Argentina, Armenia, Aruba, Australia, Austria, Azerbaijan, the Bahamas, Bahrain, Bangladesh, Barbados, Belarus, Belgium, Belize, Benin, Bermuda, Bhutan, Bolivia, Bosnia and Herzegovina, Botswana, Brazil, the British Virgin Islands, Brunei, Bulgaria, Burkina Faso, Burundi, Cameroon, Cape Verde, the Central African Republic, Chad, Chile, the People's Republic of China, Colombia, Comoros, the Congo, Costa Rica, Croatia, Cyprus, the Czech Republic, Denmark, Djibouti, Dominica, the Dominican Republic, East Timor, Ecuador, Egypt, El Salvador, Equatorial Guinea, Eritrea, Estonia, Ethiopia, Fiji, Finland, France, French Guiana, Gabon, Gambia, Georgia, Germany, Ghana, Gibraltar, Greece, Grenada, Guadeloupe, Guatemala, Guinea, Guinea-Bissau, Guyana, Haiti, Honduras, Hong Kong, Hungary, Iceland, India, Ireland, Israel, Italy, the Ivory Coast, Jamaica, Jordan, Kazakhstan, Kenya, Kiribati, Kyrgyzstan, Laos, Latvia, Lebanon, Lesotho, Liberia, Liechtenstein, Lithuania, Luxembourg, Macedonia, Madagascar, Malawi, Malaysia, the Maldives, Mali, Malta, the Marshall Islands, Martinique, Mauritania, Mauritius, Mexico, Micronesia, Monaco, Mongolia, Montenegro, Morocco, Mozambique, Namibia, Nauru, Nepal, the Nether Antilles, the Netherlands, New Zealand, Nicaragua, Niger, Nigeria, Norway, Oman, Pakistan, Palau, Panama, Papua New Guinea, Paraguay, Peru, the Philippines, Poland, Portugal, the Republic of Moldova, Romania, Russia, Rwanda, Samoa, San Marino, Sao Tome and Principe, Saudi Arabia, Senegal, Serbia, the Seychelles, Sierra Leone, Singapore, Slovakia, Slovenia, the Solomon Islands, Somalia, South Africa, South Korea, Spain, Sri Lanka, St. Kitts and Nevis, St. Lucia, St. Vincent and the Grenadines, Suriname, Swaziland, Sweden, Switzerland, Taiwan, Tajikistan, Tanzania, Togo, Tonga, Trinidad and Tobago, Tunisia, Turkey, Turkmenistan, Tuvalu, Uganda, Ukraine, the United Arab Emirates, the United Kingdom, Uruguay, Uzbekistan, Vanuatu, Venezuela, Vietnam, Yemen, Zaire, Zambia, and Zimbabwe 	459263-002
Broadcom 4322 802.11a/b/g/n WLAN module	
For use in Antigua and Barbuda, Barbados, Belize, Canada, the Cayman Islands, Guam, Puerto Rico, Trinidad and Tobago, the U.S. Virgin Islands, and the United States	487330-001
For use in Afghanistan, Albania, Algeria, Andorra, Angola, Antigua and Barbuda, Argentina, Armenia, Aruba, Australia, Austria, Azerbaijan, the Bahamas, Bahrain, Bangladesh, Barbados, Belarus, Belgium, Belize, Benin, Bermuda, Bhutan, Bolivia, Bosnia and Herzegovina, Botswana, Brazil, the British Virgin Islands, Brunei, Bulgaria, Burkina Faso, Burundi, Cameroon, Cape Verde, the Central African Republic, Chad, Chile, the People's Republic of China, Colombia, Comoros, the Congo, Costa Rica, Croatia, Cyprus, the Czech Republic, Denmark, Djibouti, Dominica, the Dominican Republic, East Timor, Ecuador, Egypt, El Salvador, Equatorial Guinea, Eritrea, Estonia, Ethiopia, Fiji, Finland, France, French Guiana, Gabon, Gambia, Georgia, Germany, Ghana, Gibraltar, Greece, Grenada, Guadeloupe, Guatemala, Guinea, Guinea-Bissau, Guyana, Haiti, Honduras, Hong Kong, Hungary, Iceland, India, Ireland, Israel, Italy, the Ivory Coast, Jamaica, Jordan, Kazakhstan, Kenya, Kiribati, Kyrgyzstan, Laos, Latvia, Lebanon, Lesotho, Liberia, Liechtenstein, Lithuania, Luxembourg, Macedonia, Madagascar, Malawi, Malaysia, the Maldives, Mali, Malta, the Marshall Islands, Martinique, Mauritania, Mauritius, Mexico, Micronesia, Monaco, Mongolia, Montenegro, Morocco, Mozambique, Namibia, Nauru, Nepal, the Nether Antilles, the Netherlands, New Zealand, Nicaragua, Niger, Nigeria, Norway, Oman, Pakistan, Palau, Panama, Papua New Guinea, Paraguay, Peru, the Philippines, Poland, Portugal, the Republic of Moldova, Romania, Russia, Rwanda, Samoa, San Marino, Sao Tome and Principe, Saudi Arabia, Senegal, Serbia, the Seychelles, Sierra Leone, Singapore, Slovakia, Slovenia, the Solomon Islands, Somalia, South Africa, South Korea, Spain, Sri Lanka, St. Kitts and Nevis, St. Lucia, St. Vincent and the Grenadines, Suriname, Swaziland, Sweden, Switzerland, Taiwan, Tajikistan, Tanzania, Togo, Tonga, Trinidad and Tobago, Tunisia, Turkey, Turkmenistan, Tuvalu, Uganda, Ukraine, the United Arab Emirates, the United Kingdom, Uruguay, Uzbekistan, Vanuatu, Venezuela, Vietnam, Yemen, Zaire, Zambia, and Zimbabwe	487330-002

Before removing the WLAN module, follow these steps:

1. Shut down the computer. If you are unsure whether the computer is off or in Hibernation, turn the computer on, and then shut it down through the operating system.
2. Disconnect all external devices connected to the computer.

3. Disconnect the power from the computer by first unplugging the power cord from the AC outlet and then unplugging the AC adapter from the computer.
4. Remove the battery (see [Battery on page 44](#)).
5. Remove the following components:
 - a. Keyboard (see [Keyboard on page 45](#))
 - b. Hard drive or solid-state drive (see [Mass storage device on page 49](#))
 - c. Top cover (see [Top cover on page 52](#))
 - d. Audio board (see [Audio board \(Model 2133 only\) on page 55](#))
 - e. System board (see [System board on page 59](#))

Remove the WLAN module:

△ **CAUTION:** To prevent an unresponsive system, replace the wireless module only with a wireless module authorized for use in the computer by the governmental agency that regulates wireless devices in your country or region. If you replace the module and then receive a warning message, remove the module to restore computer functionality, and then contact technical support through Help and Support.

1. Turn the system board upside down, with the front toward you.
2. Remove the Torx8 T8M2.5×5.0 screw (1) that secures the WLAN module to the system board. (The edge of the module opposite the slot rises away from the computer.)
3. Remove the WLAN module (2) by pulling the module away from the slot at an angle.

📝 **NOTE:** WLAN modules are designed with a notch (3) to prevent incorrect insertion.

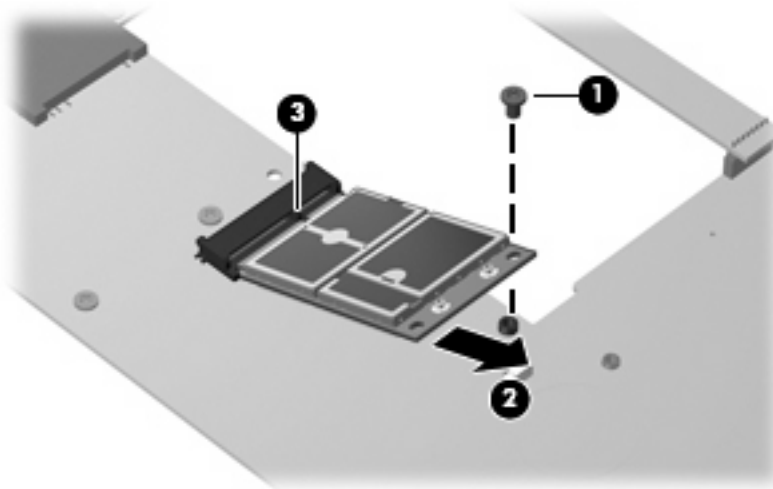

Reverse this procedure to install the WLAN module.

RTC battery

 **NOTE:** Removing the RTC battery and leaving it uninstalled for 5 or more minutes causes all passwords and CMOS settings to be cleared.

Description	Spare part number
RTC battery for use only in model 2133	468824-001
RTC battery for use only in model 2140	449137-001

Before removing the RTC battery, follow these steps:

1. Shut down the computer. If you are unsure whether the computer is off or in Hibernation, turn the computer on, and then shut it down through the operating system.
2. Disconnect all external devices connected to the computer.
3. Disconnect the power from the computer by first unplugging the power cord from the AC outlet and then unplugging the AC adapter from the computer.
4. Remove the battery (see [Battery on page 44](#)).
5. Remove the following components:
 - a. Keyboard (see [Keyboard on page 45](#))
 - b. Hard drive or solid-state drive (see [Mass storage device on page 49](#))
 - c. Top cover (see [Top cover on page 52](#))
 - d. Audio board (see [Audio board \(Model 2133 only\) on page 55](#))
 - e. System board (see [System board on page 59](#))

Remove the RTC battery:

1. Turn the system board upside down, with the front toward you.
2. If you have model 2140, go to step 4. Disconnect the RTC battery cable **(1)** from the system board.

3. Detach the RTC battery (2) from the system board and remove it from the computer.

 **NOTE:** The RTC battery is attached to the system board with double-sided tape.

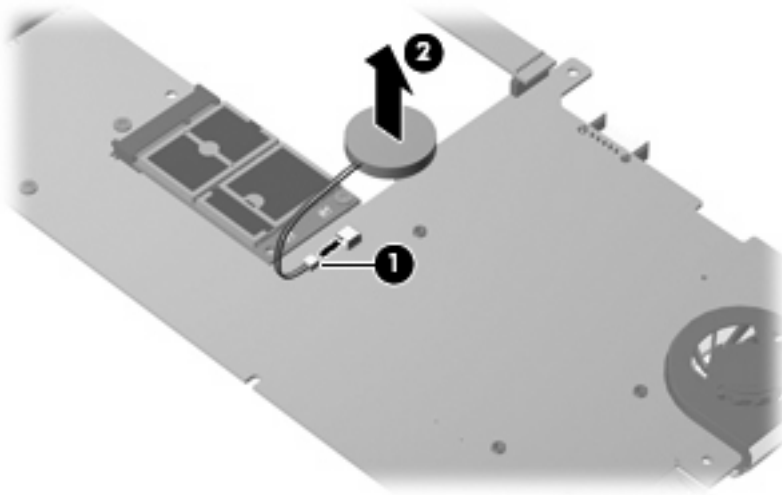

4. If you have model 2140, remove the RTC battery from the socket on the system board.

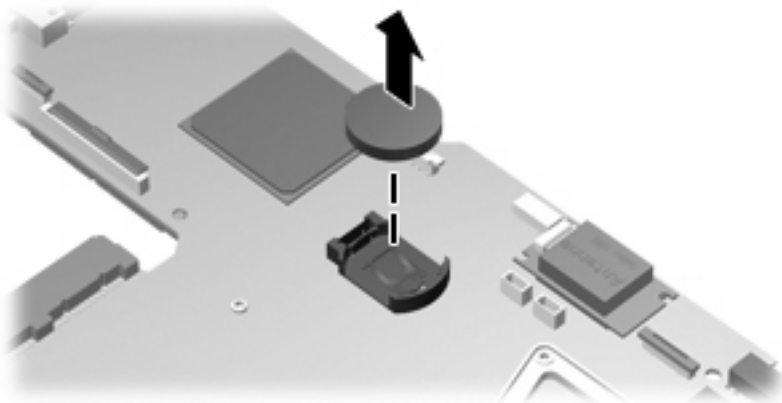

Reverse this procedure to install the RTC battery.

Fan/heat sink

Description	Spare part number
Fan/heat sink for use only in model 2133	482279-001
Fan/heat sink for use only in model 2140	511750-001

Before removing the fan/heat sink, follow these steps:

1. Shut down the computer. If you are unsure whether the computer is off or in Hibernation, turn the computer on, and then shut it down through the operating system.
2. Disconnect all external devices connected to the computer.
3. Disconnect the power from the computer by first unplugging the power cord from the AC outlet and then unplugging the AC adapter from the computer.
4. Remove the battery (see [Battery on page 44](#)).
5. Remove the following components:
 - a. Keyboard (see [Keyboard on page 45](#))
 - b. Hard drive or solid-state drive (see [Mass storage device on page 49](#))
 - c. Top cover (see [Top cover on page 52](#))
 - d. Audio board (see [Audio board \(Model 2133 only\) on page 55](#))
 - e. System board (see [System board on page 59](#))

If you have model 2133, remove the fan/heat sink:

1. Following the 1, 2, 3, 4, 5 sequence stamped into the fan/heat sink, remove the five Torx8 T8M2.0×6.0 screws (**1**) that secure the fan/heat sink to the system board.

2. Remove the fan/heat sink (2).

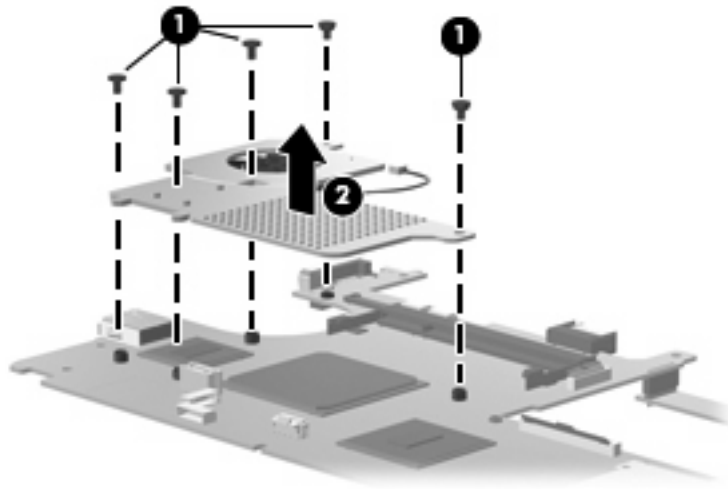

NOTE: The thermal material must be thoroughly cleaned from the surfaces of the fan/heat sink and system board components. Thermal grease is used on the video chip (1) and the surface of the fan/heat sink (1) that contacts the video chip. Thermal tape is used on the processor (2) and the surface of the fan/heat sink (2) that contacts the processor. Replacement thermal material is included with all fan/heat sink and system board spare part kits.

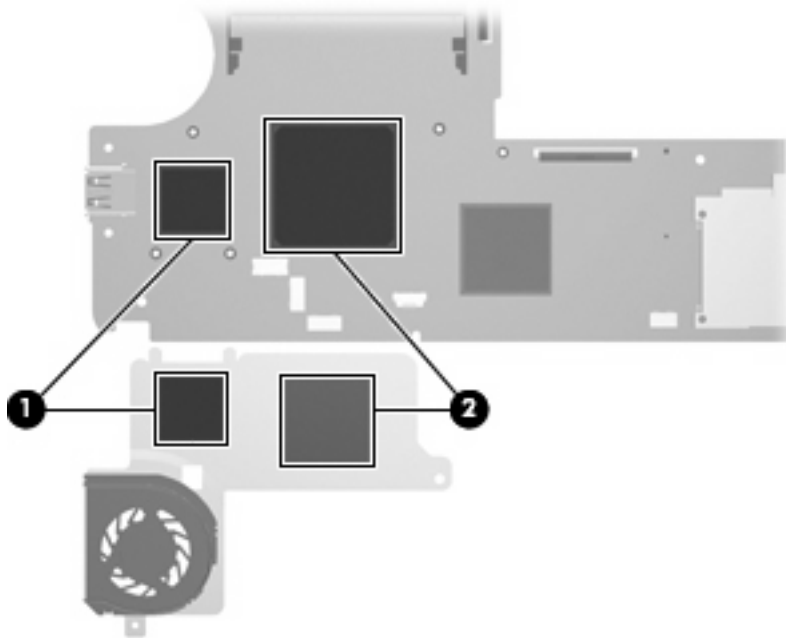

If you have model 2140, remove the fan/heat sink:

1. Remove the three Torx8 T8M2.0×6.0 screws (1) that secure the fan/heat sink to the system board.

2. Remove the fan/heat sink (2).

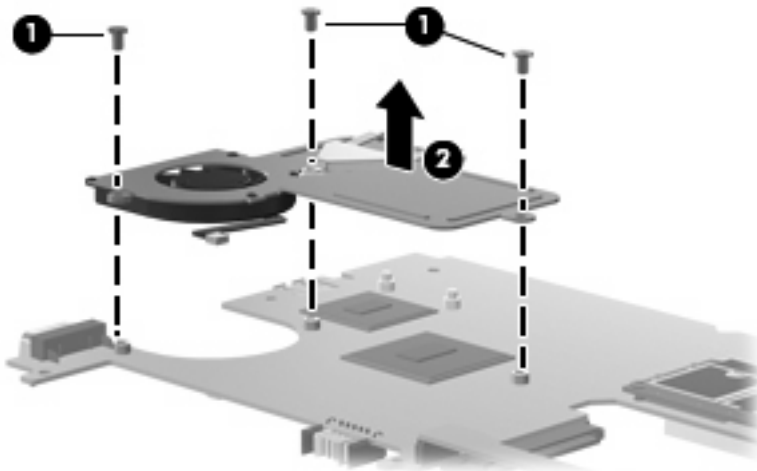

 **NOTE:** The thermal material must be thoroughly cleaned from the surfaces of the fan/heat sink and system board components. Thermal grease is used on the video chip (1) and the surface of the fan/heat sink (1) that contacts the video chip. Thermal tape is used on the processor (2) and the surface of the fan/heat sink (2) that contacts the processor. Replacement thermal material is included with all fan/heat sink and system board spare part kits.

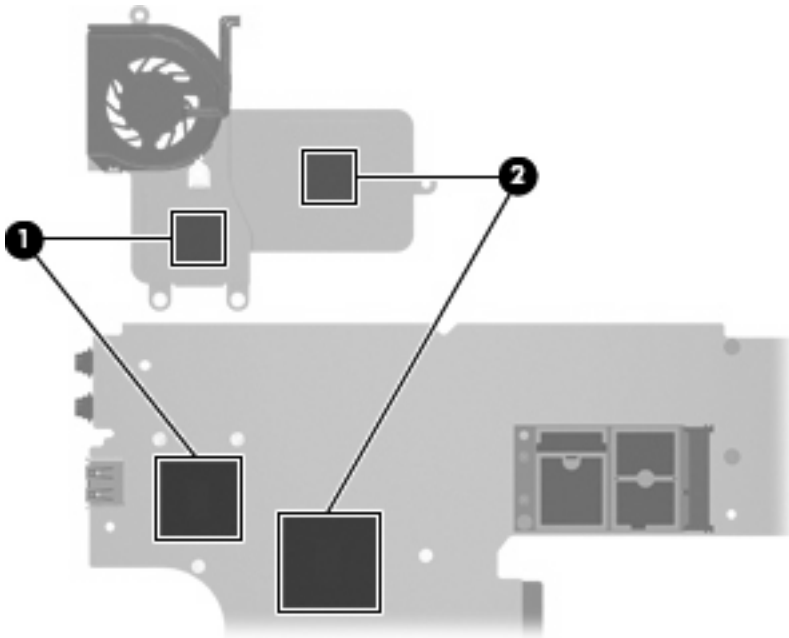

Reverse this procedure to install the fan/heat sink.

 **NOTE:** To properly ventilate the computer, allow at least a 7.6-cm (3-inch) clearance on the left side of the computer.

The computer uses an electric fan for ventilation. The fan is controlled by a temperature sensor and is designed to turn on automatically when high temperature conditions exist. These conditions are affected by high external temperatures, system power consumption, power management/battery conservation configurations, battery fast charging, and software requirements. Exhaust air is displaced through the ventilation grill located on the left side of the computer.

Display assembly

 **NOTE:** All display assembly spare part kits include 2 microphones, 2 speakers, and 2 WLAN antenna transceivers and cables.

Description	Spare part number
For use in model 2133:	
8.9-inch, WXGA display assembly for use only with computer models equipped with camera module	483384-001
8.9-inch, WXGA display assembly for use only with computer models not equipped with camera module	482278-001
8.9-inch, WSVGA display assembly for use only with computer models equipped with camera module and system boards with the following spare part numbers: 498308-001, 500754-001, and 500755-001	498309-001
8.9-inch, WSVGA display assembly for use only with computer models not equipped with camera module and system boards with the following spare part numbers: 498308-001, 500754-001, and 500755-001	502600-001
For use in model 2140:	
10.1-inch, WXGA display assembly for use only with SD computer models equipped with camera module	511743-001
10.1-inch, WXGA display assembly for use only with HD computer models equipped with camera module	511744-001

Before removing the display assembly, follow these steps:

1. Shut down the computer. If you are unsure whether the computer is off or in Hibernation, turn the computer on, and then shut it down through the operating system.
2. Disconnect all external devices connected to the computer.
3. Disconnect the power from the computer by first unplugging the power cord from the AC outlet and then unplugging the AC adapter from the computer.
4. Remove the battery (see [Battery on page 44](#)).
5. Remove the following components:
 - a. Keyboard (see [Keyboard on page 45](#))
 - b. Hard drive or solid-state drive (see [Mass storage device on page 49](#))
 - c. Top cover (see [Top cover on page 52](#))
 - d. Audio board (see [Audio board \(Model 2133 only\) on page 55](#))
 - e. System board (see [System board on page 59](#))
6. Disconnect the wireless antenna cables from the WLAN module (see [WLAN module on page 63](#)).

To remove the display assembly for model 2133:

1. Remove the wireless antenna cables (1) from the clips and routing channels built into the base enclosure.
-
- △ **CAUTION:** The display assembly will be unsupported when the following screws are removed. To prevent damage to the display assembly, support it before removing the screws.
2. Remove the two T8M2.5×5.0 screws (2) and the four Torx8 T8M2.5×10.0 screws (3) that secure the display assembly to the computer.
 3. Lift the display assembly (4) straight up and remove it.

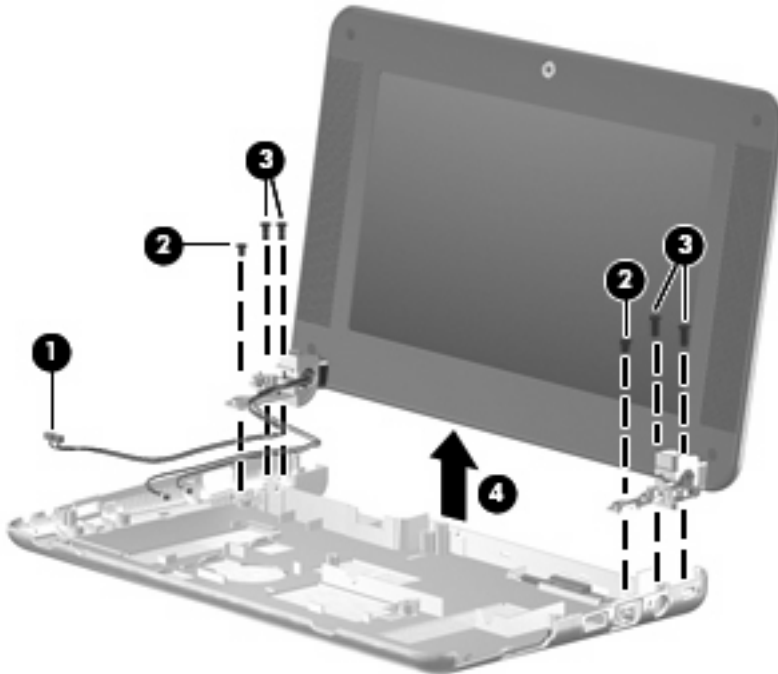

To remove the display assembly for model 2140:

1. Remove the wireless antenna cables (1) from the clips and routing channels built into the base enclosure.
-
- △ **CAUTION:** The display assembly will be unsupported when the following screws are removed. To prevent damage to the display assembly, support it before removing the screws.
2. Remove the four silver Phillips PM3.0×3.0 screws (2), the silver Phillips PM 4.5×8.0 screw (3), and the black Phillips PM 2.0×8.0 screw (4) that secures the display assembly to the computer.

3. Lift the display assembly (5) straight up and remove it.

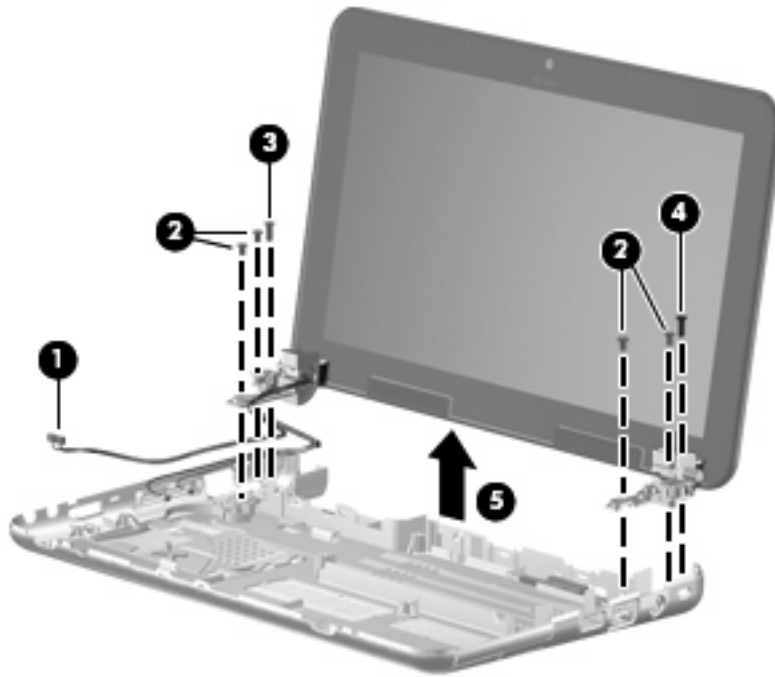

Reverse this procedure to reassemble and install the display assembly.

5 Computer Setup

Starting Computer Setup

Computer Setup is a preinstalled, ROM-based utility that can be used even when the operating system is not working or will not load.

 **NOTE:** Some of the Computer Setup menu items listed in this guide may not be supported by your computer.

NOTE: Pointing devices are not supported in Computer Setup. You must use the keyboard to navigate and make selections.

NOTE: An external keyboard connected by USB can be used with Computer Setup only if USB legacy support is enabled.

To start Computer Setup, follow these steps:

1. Turn on or restart the computer.
2. Before your operating system opens and while the “F10=ROM Based Setup” message is displayed in the lower-left corner of the screen, press **f10**.

Using Computer Setup

Navigating and selecting in Computer Setup

The information and settings in Computer Setup are accessed from the File, Security, Diagnostics, and System Configuration menus.

1. Open Computer Setup by turning on or restarting the computer, and then pressing **f10** while the "F10 = ROM Based Setup" message is displayed in the lower-left corner of the screen.

Because Computer Setup is not operating system based, it does not support the TouchPad. Navigation and selection are by keystroke:

- To choose a menu or a menu item, use the arrow keys.
 - To select an item, press **enter**.
 - To close open dialog boxes and return to the main Computer Setup screen, press **esc**.
 - To view navigation information, press **f1**.
 - To change the language, press **f2**.
2. Select the **File**, **Security**, **Diagnostics**, or **System Configuration** menu.
 3. To exit Computer Setup, choose one of the following methods:
 - To exit Computer Setup without saving your preferences, use the arrow keys to select **File > Ignore changes and exit**. Then follow the instructions on the screen.
 - To save your preferences and exit Computer Setup, use the arrow keys to select **File > Save changes and exit**. Then follow the instructions on the screen.

Your preferences go into effect when the computer restarts.

Restoring factory settings in Computer Setup

To return all settings in Computer Setup to the values that were set at the factory, follow these steps:

1. Open Computer Setup by turning on or restarting the computer, and then pressing **f10** while the "F10 = ROM Based Setup" message is displayed in the lower-left corner of the screen.
2. Use the arrow keys to select **File > Restore defaults**, and then press **enter**.
3. When the confirmation dialog box opens, press **f10**.
4. To save your preferences and exit Computer Setup, use the arrow keys to select **File > Save changes and exit**. Then follow the instructions on the screen.

Your preferences go into effect when the computer restarts.

 **NOTE:** Your password settings and security settings are not changed when you restore the factory settings.

Computer Setup menus

The menu tables in this section provide an overview of the Computer Setup options.

 **NOTE:** Some of the Computer Setup menu items listed in this chapter may not be supported by your computer.

File menu

Select	To do this
System information	<ul style="list-style-type: none">• View identification information for the computer.• View specification information for the processor, cache and memory size, and system ROM.
Restore defaults	Replace the configuration settings in Computer Setup with the original factory settings. (Password settings and security settings are not changed when you restore the factory settings.)
Ignore changes and exit	Cancel any changes entered during the current session. Then exit and restart the computer.
Save changes and exit	Save any changes entered during the current session. Then exit and restart the computer. Your changes go into effect when the computer restarts.

Security menu

 **NOTE:** Some of the menu items listed in this section may not be supported by your computer.

Select	To do this
Setup password (Windows only) or Administrator password (Linux only)	Enter, change, or delete a setup password.
Power-on password (Windows only)	Enter, change, or delete a power-on password.
Change administrator password	Enter, change, or delete an Administrator password.
Password check (Linux only)	<ul style="list-style-type: none">• Enable/disable Always to always check for a password.• Enable Setup to set the password.
Password options	<ul style="list-style-type: none">• Enable/disable stringent security.• Enable/disable the password requirement on computer restart.
DriveLock passwords	<ul style="list-style-type: none">• Enable, change, or disable DriveLock on any computer hard drive.• Enter, change, or disable DriveLock on an optional MultiBay hard drive. <p>NOTE: DriveLock settings are accessible only when you enter Computer Setup by turning on (not restarting) the computer.</p>

Select	To do this
System IDs (Windows only)	Enter a user-defined computer asset tracking number and ownership tag.
Disk Sanitizer (Windows only)	<p>Run Disk Sanitizer to destroy all existing data on the primary hard drive. The following options are available:</p> <ul style="list-style-type: none"> Fast: Runs the Disk Sanitizer erase cycle once. Optimum: Runs the Disk Sanitizer erase cycle 3 times. Custom: Allows you to select the desired number of Disk Sanitizer erase cycles from a list. <p>CAUTION: If you run Disk Sanitizer, the data on the primary hard drive is destroyed permanently.</p>
Notebook hard drive password status (Linux only)	Enable/disable hard drive password status visibility.

Diagnostics menu

Select	To do this
HDD Self-Test Options	Run a comprehensive self-test on any hard drive in the system or on any optional MultiBay hard drive.
Memory Check	Run a comprehensive check on system memory.

System Configuration menu

 **NOTE:** Some of the listed System Configuration options may not be supported by your computer.

Select	To do this
Language (Windows only)	Change the Computer Setup language.
Boot options	<ul style="list-style-type: none"> Set an f9, f10, and f12 delay when starting up. Enable/disable CD-ROM boot. Enable/disable floppy boot. Enable/disable internal network adapter boot. Enable/disable MultiBoot, which sets a boot order that can include most boot devices in the system. Set the Express Boot Popup delay in seconds. Set the boot order. <ul style="list-style-type: none"> 1st boot device: USB CD-ROM 2nd boot device: USB floppy 3rd boot device: USB SuperDisk 4th boot device: Notebook hard drive 5th boot device: USB hard disk

Select	To do this
	<ul style="list-style-type: none"> ◦ 6th boot device: Network controller
Device configurations	<ul style="list-style-type: none"> • Swap the functions of the fn key and left ctrl key. • Enable/disable USB legacy support. When enabled, USB legacy support allows the following: <ul style="list-style-type: none"> ◦ Use of a USB keyboard in Computer Setup even when a your operating system is not running. ◦ Startup from bootable USB devices, including a hard drive, diskette drive, or optical drive connected by a USB port to the computer. • Enable/disable BIOS DMA data transfers. • Enable/disable fan always on while connected to an AC outlet. • Enable/disable data execution prevention. • Enable/disable LAN power saving mode. • Enable/disable SATA Native Mode. • Enable/disable Dual Core CPU. • Enable/disable HDD translation mode.
Built-in device options	<ul style="list-style-type: none"> • Enable/disable embedded WLAN Device Radio. • Enable/disable embedded Bluetooth Device Radio. • Enable/disable Network Interface Controller (LAN) • Enable/disable LAN/WLAN Switching. • Enable/disable Wake on LAN. • Enable/disable the integrated camera (webcam)
Port options (Windows only)	<ul style="list-style-type: none"> • Enable/disable USB port. • Enable/disable ExpressCard slot.

6 Specifications

Computer specifications, model 2133

	Metric	U.S.
Dimensions		
Depth	16.51 cm	6.50 in
Width	25.50 cm	10.04 in
Height (front to back)	2.67 to 3.30 cm	1.05 to 1.30 in
Weight		
Equipped with a 3-cell battery, 120-GB hard drive, 1-GB memory, WLAN module, and 2 wireless antennas	1.27 kg	2.80 lbs
Equipped with a 3-cell battery, 4-GB solid-state drive, 1-GB memory, WLAN module, and 2 wireless antennas	1.19 kg	2.63 lbs
Input power		
Operating voltage	18.5 V dc @ 3.5 A – 65 W	
Operating current	3.5 A	
Temperature		
Operating	0°C to 35°C	32°F to 95°F
Nonoperating	-20°C to 60°C	-4°F to 140°F
Relative humidity (noncondensing)		
Operating	10% to 90%	
Nonoperating	5% to 95%	
Maximum altitude (unpressurized)		
Operating	-15 m to 3,048 m	-50 ft to 10,000 ft
Nonoperating	-15 m to 12,192 m	-50 ft to 40,000 ft
NOTE: Applicable product safety standards specify thermal limits for plastic surfaces. The computer operates well within this range of temperatures.		

Computer specifications, model 2140

	Metric	U.S.
Dimensions		
Depth	16.60 cm	6.54 in
Width	26.10 cm	10.28 in
Height (front to back)	2.66 to 3.20 cm	1.05 to 1.26 in
Weight		
Equipped with a 6-cell battery, hard drive	1.35 kg	2.97 lbs
Equipped with a 3-cell battery, hard drive	1.19 kg	2.62 lbs
Input power		
Operating voltage	18.5 V dc @ 3.5 A – 65 W	
Operating current	3.5 A	
Temperature		
Operating	0°C to 35°C	32°F to 95°F
Nonoperating	-20°C to 60°C	-4°F to 140°F
Relative humidity (noncondensing)		
Operating	10% to 90%	
Nonoperating	5% to 95%	
Maximum altitude (unpressurized)		
Operating	-15 m to 3,048 m	-50 ft to 10,000 ft
Nonoperating	-15 m to 12,192 m	-50 ft to 40,000 ft
NOTE: Applicable product safety standards specify thermal limits for plastic surfaces. The computer operates well within this range of temperatures.		

10.1-inch, SD display specifications

	Metric	U.S.
Dimensions		
Height	12.5 cm	4.9 in
Width	22.3 cm	8.8 in
Diagonal	25.7 cm	10.1 in
Surface Treatment	Anti-glare	
Contrast ratio	400:1 (typical)	
Refresh Rate	60 Hz	
Brightness	200 nits (typical)	

	Metric	U.S.
Pixel resolution		
Pitch	0.217 mm	
Format	1024 × 576	
PPI	117	
Backlight	LED	
Viewing angle	±30° horizontal, ±10° vertical (typical)	

10.1-inch, HD display specifications

	Metric	U.S.
Dimensions		
Height	12.5 cm	4.93 in
Width	22.3 cm	8.77 in
Diagonal	25.7 cm	10.1 in
Surface Treatment	Anti-glare	
Contrast ratio	400:1 (typical)	
Refresh Rate	60 Hz	
Brightness	200 nits (typical)	
Pixel resolution		
Pitch	0.164 mm	
Format	1366 × 768	
PPI	155	
Backlight	LED	
Viewing angle	±30° horizontal, ±10° vertical (typical)	

8.9-inch, WXGA display specifications

	Metric	U.S.
Dimensions		
Height	11.7 cm	4.61 in
Width	19.5 cm	7.68 in
Diagonal	22.7 cm	8.94 in
Number of colors	Up to 16.8 million	
Contrast ratio	250:1 (typical)	

	Metric	U.S.
Brightness	200 nits (typical)	
Pixel resolution		
Pitch	0.279 × 0.279 mm	
Format	1280 × 768	
Configuration	RGB vertical stripe	
Backlight	Edge lit	
Character display	80 × 25	
Total power consumption	4.0 W	
Viewing angle	±40 horizontal, +20/−40° vertical (typical)	

8.9-inch, WSVGA display specifications

	Metric	U.S.
Dimensions		
Height	11.3 cm	4.45 in
Width	19.5 cm	7.68 in
Diagonal	22.6 cm	8.90 in
Number of colors	6-bit, 262,144	
Contrast ratio	300:1 (typical)	
Brightness	200 nits (typical)	
Pixel resolution		
Pitch	0.1905 × 0.189 mm	
Format	1024 × 600	
Configuration	RGB vertical stripe	
Backlight	Integral LED	
Total power consumption	3.0 W	
Viewing angle	+20/-40 horizontal, +40/-40° vertical (typical)	

Hard drive specifications

	160-GB*	120-GB*
Dimensions		
Height	9.5 mm	9.5 mm
Width	70 mm	70 mm
Weight	101 g	101 g
Interface type		
	SATA	SATA
Transfer rate		
	100 MB/sec	100 MB/sec
Security		
	ATA security	ATA security
Seek times (typical read, including setting)		
Single track	3 ms	3 ms
Average	13 ms	13 ms
Maximum	24 ms	24 ms
Logical blocks		
	312,560,640	234,420,480
Disc rotational speed		
	7200 and 5400 rpm	7200 and 5400 rpm
Operating temperature		
	5°C to 55°C (41°F to 131°F)	
*1 GB = 1 billion bytes when referring to hard drive storage capacity. Actual accessible capacity is less. Actual drive specifications may differ slightly.		
NOTE: Certain restrictions and exclusions apply. Contact technical support for details.		

System DMA specifications

Hardware DMA	System function
DMA0	Not applicable
DMA1*	Not applicable
DMA2*	Not applicable
DMA3	Not applicable
DMA4	Direct memory access controller
DMA5*	Available for ExpressCard
DMA6	Not assigned
DMA7	Not assigned

*ExpressCard controller can use DMA 1, 2, or 5.

System interrupt specifications

Hardware IRQ	System function
IRQ0	System timer
IRQ1	Standard 101-/102-Key or Microsoft® Natural Keyboard
IRQ2	Cascaded
IRQ3	Intel 82801DB/DBM USB2 Enhanced Host Controller—24CD
IRQ4	COM1
IRQ5*	Conexant AC—Link Audio Intel 82801DB/DBM SMBus Controller—24C3 Data Fax Modem with SmartCP
IRQ6	Diskette drive
IRQ7*	Parallel port
IRQ8	System CMOS/real-time clock
IRQ9*	Microsoft ACPI-compliant system
IRQ10*	Intel USB UHCI controller—24C2 Intel 82852/82855 GM/GME Graphic Controller Realtek RTL8139 Family PCI Fast Ethernet Controller
IRQ11	Intel USB EHCI controller—24CD Intel USB UHCI controller—24C4 Intel USB UHCI controller—24C7 Intel Pro/Wireless 2200BG TI OHCI 1394 host controller TI PCI1410 CardBus controller
IRQ12	Synaptics PS/2 TouchPad
IRQ13	Numeric data processor
IRQ14	Primary IDE channel
IRQ15	Secondary IDE channel

*Default configuration; audio possible configurations are IRQ5, IRQ7, IRQ9, IRQ10, or none.

NOTE: ExpressCards may assert IRQ3, IRQ4, IRQ5, IRQ7, IRQ9, IRQ10, IRQ11, or IRQ15. Either the infrared or the serial port may assert IRQ3 or IRQ4.

System I/O address specifications

I/O address (hex)	System function (shipping configuration)
000 - 00F	DMA controller no. 1
010 - 01F	Unused
020 - 021	Interrupt controller no. 1
022 - 024	Opti chipset configuration registers
025 - 03F	Unused
02E - 02F	87334 "Super I/O" configuration for CPU
040 - 05F	Counter/timer registers
044 - 05F	Unused
060	Keyboard controller
061	Port B
062 - 063	Unused
064	Keyboard controller
065 - 06F	Unused
070 - 071	NMI enable/RTC
072 - 07F	Unused
080 - 08F	DMA page registers
090 - 091	Unused
092	Port A
093 - 09F	Unused
0A0 - 0A1	Interrupt controller no. 2
I/O Address (hex)	System Function (shipping configuration)
0A2 - 0BF	Unused
0C0 - 0DF	DMA controller no. 2
0E0 - 0EF	Unused
0F0 - 0F1	Coprocessor busy clear/reset
0F2 - 0FF	Unused
100 - 16F	Unused
170 - 177	Secondary fixed disk controller
178 - 1EF	Unused
1F0 - 1F7	Primary fixed disk controller
1F8 - 200	Unused
201	JoyStick (decoded in ESS1688)
202 - 21F	Unused

I/O address (hex)	System function (shipping configuration)
220 - 22F	Entertainment audio
230 - 26D	Unused
26E - 26	Unused
278 - 27F	Unused
280 - 2AB	Unused
2A0 - 2A7	Unused
2A8 - 2E7	Unused
2E8 - 2EF	Reserved serial port
2F0 - 2F7	Unused
2F8 - 2FF	Infrared port
300 - 31F	Unused
320 - 36F	Unused
370 - 377	Secondary diskette drive controller
378 - 37F	Parallel port (LPT1/default)
380 - 387	Unused
388 - 38B	FM synthesizer—OPL3
38C - 3AF	Unused
3B0 - 3BB	VGA
3BC - 3BF	Reserved (parallel port/no EPP support)
3C0 - 3DF	VGA
3E0 - 3E1	ExpressCard controller in CPU
3E2 - 3E3	Unused
3E8 - 3EF	Internal modem
3F0 - 3F7	“A” diskette controller
3F8 - 3FF	Serial port (COM1/default)
CF8 - CFB	PCI configuration index register (PCIDIVO-1)
CFC - CFF	PCI configuration data register (PCIDIVO-1)

System memory map specifications

Size	Memory address	System function
640 KB	00000000-0009FFFF	Base memory
128 KB	000A0000-000BFFFF	Video memory
48 KB	000C0000-000CBFFF	Video BIOS
160 KB	000C8000-000E7FFF	Unused
64 KB	000E8000-000FFFFFF	System BIOS
15 MB	00100000-00FFFFFF	Extended memory
58 MB	04800000-07FFFFFF	Super extended memory
58 MB	04800000-07FFFFFF	Unused
2 MB	08000000-080FFFFFF	Video memory (direct access)
4 GB	08200000-FFFEFFFF	Unused
64 KB	FFFF0000-FFFFFFFF	System BIOS

7 Screw listing

This section provides specification and reference information for the screws and screw locks used in the computer. All screws listed in this section are available in the Screw Kit, spare part number 483383-001 for model 2133, 511753-001 for model 2140.

Phillips PM2.0×3.0 screw

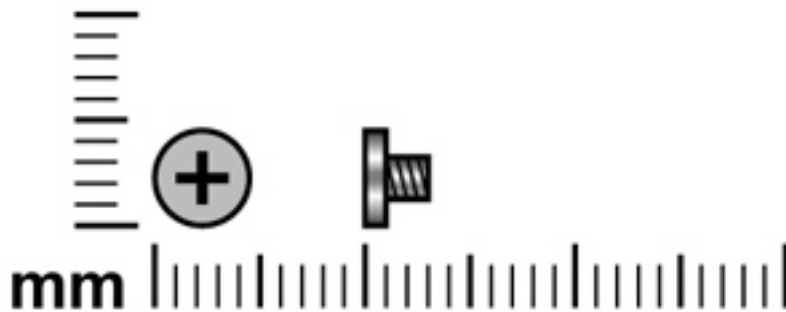

Color	Quantity	Length	Thread	Head diameter
Silver	3	3.0 mm	2.0 mm	4.5 mm



Where used: 3 screws that secure the keyboard to the computer

Phillips PM2.0×5.0 screw

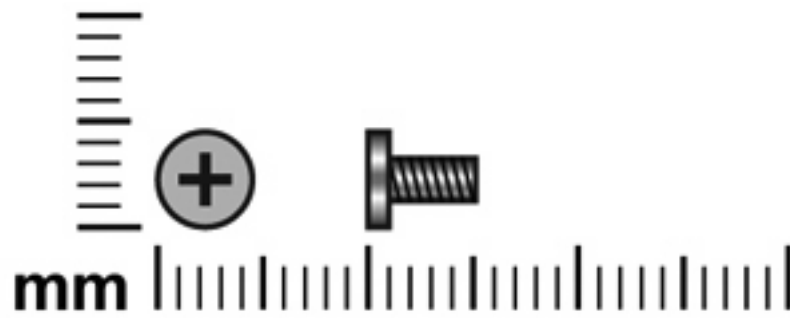

Color	Quantity	Length	Thread	Head diameter
Black	2	5.0 mm	2.0 mm	5.0 mm

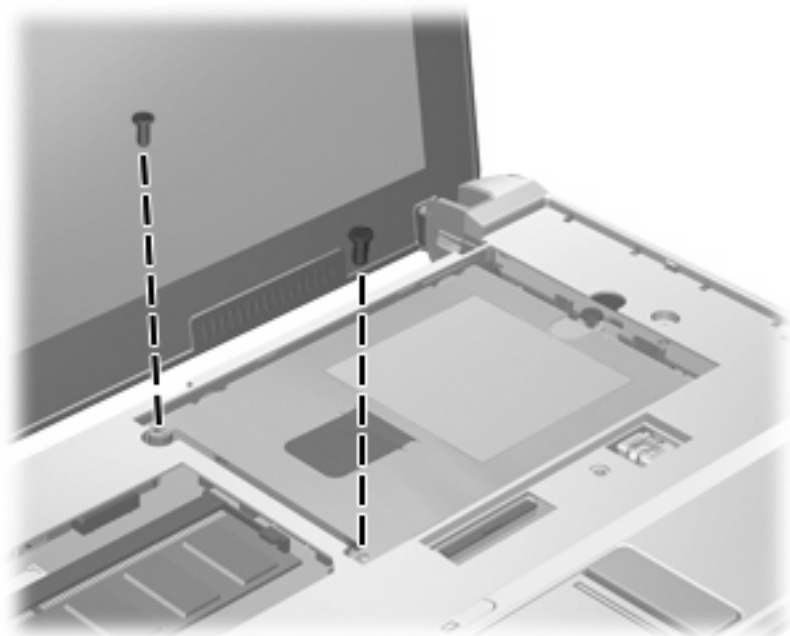

Where used: 2 screws that secure the mass storage device to the computer (model 2133 is shown)

Phillips PM3.0×3.0 screw

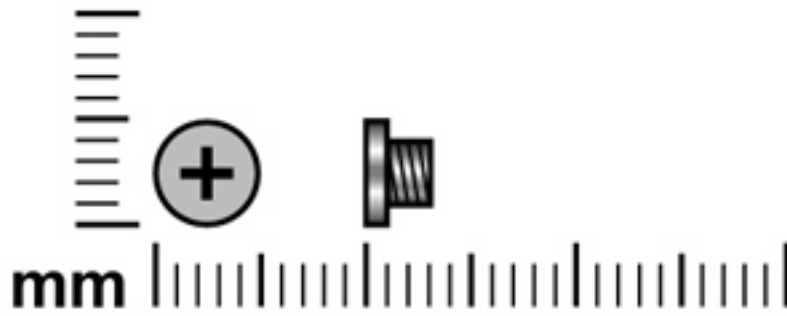

Color	Quantity	Length	Thread	Head diameter
Black	5	3.0 mm	3.0 mm	3.0 mm

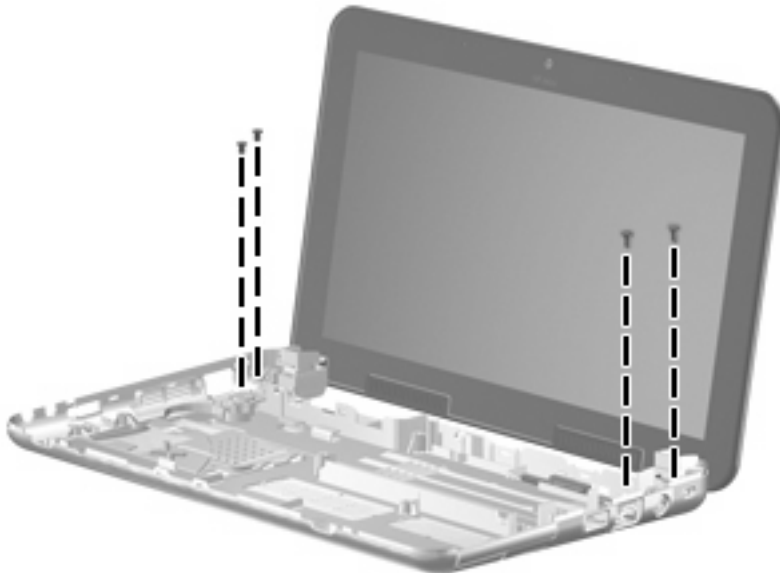

Where used (model 2140): 4 screws that secure the display assembly to the base enclosure



Where used (model 2140): One screw that secures the top cover to the computer

Phillips PM2.0×7.0 screw

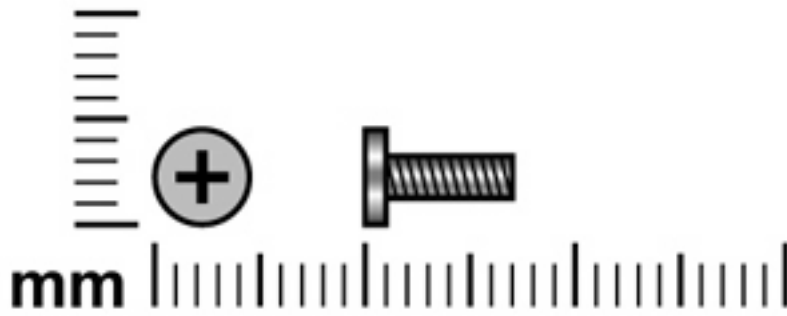

Color	Quantity	Length	Thread	Head diameter
Black	7	7.0 mm	2.0 mm	5.0 mm



Where used (model 2140): 3 screws that secure the top cover to the computer

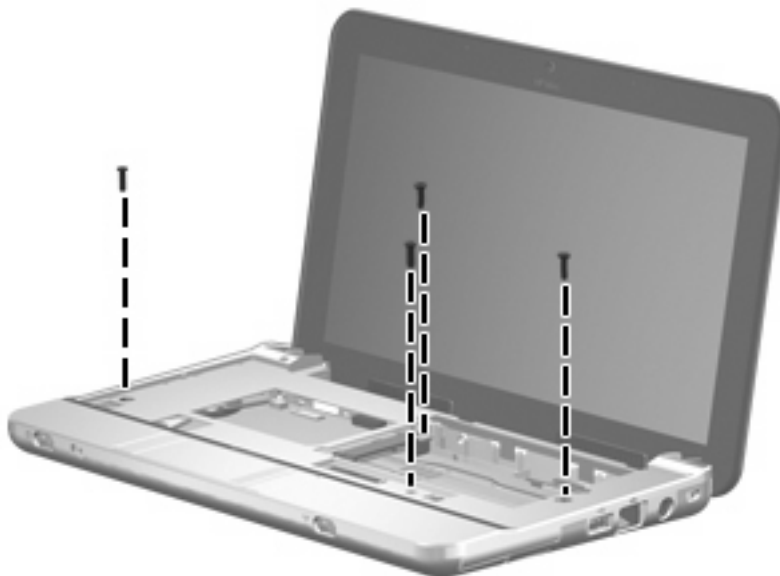

Where used (model 2140): 4 screws that secure the top cover to the computer

Phillips PM4.5×8.0 screw

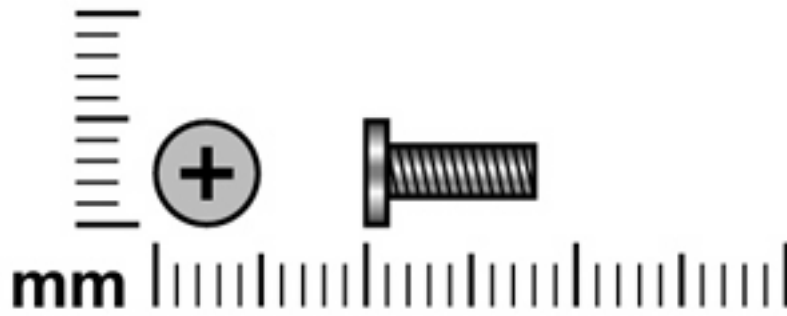

Color	Quantity	Length	Thread	Head diameter
Silver	1	8.0 mm	4.5 mm	5.0 mm



Where used (model 2140): One screw that secures the display assembly to the base enclosure

Phillips PM2.0×8.0 screw

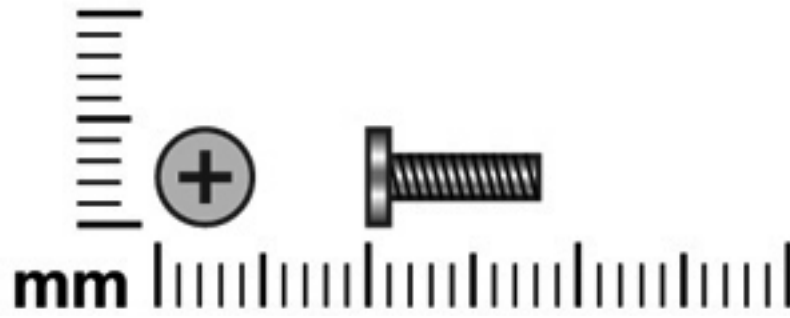

Color	Quantity	Length	Thread	Head diameter
Black	1	8.0 mm	2.0 mm	5.0 mm



Where used (model 2140): One screw that secures the display assembly to the base enclosure

Torx8 T8M2.0×6.0 screw

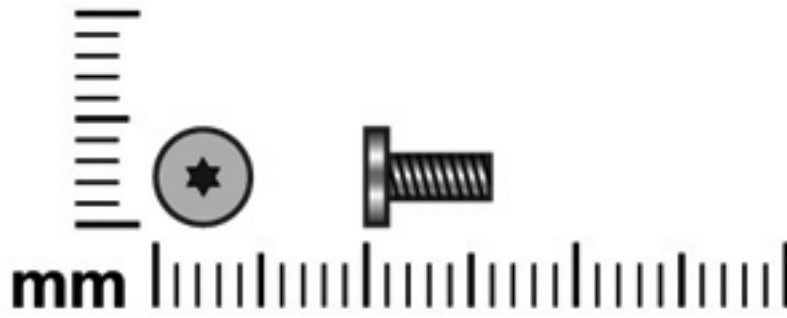

Color	Quantity	Length	Thread	Head diameter
Silver	13 (model 2133)	6.0 mm	2.0 mm	4.5 mm
	5 (model 2140)			

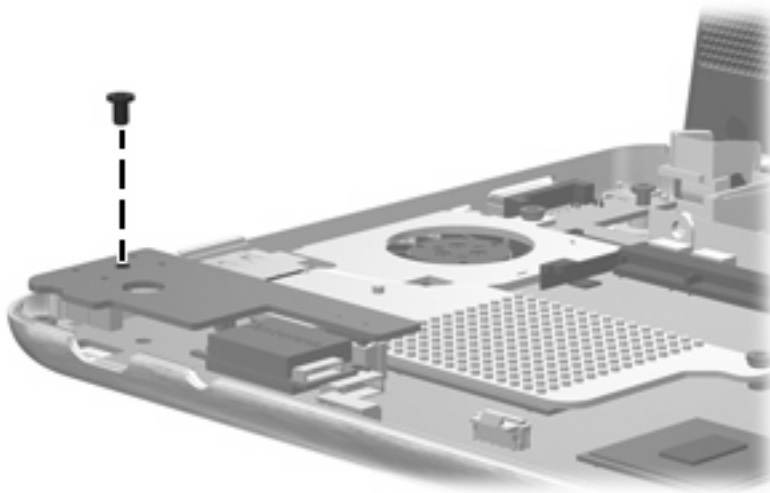

Where used (model 2133): One screw that secures the audio board to the system board

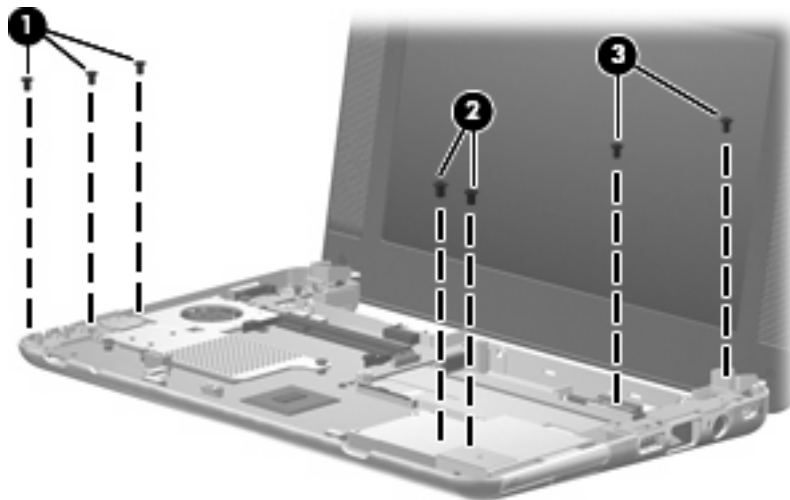

Where used: (model 2133)

- (1) Three screws that secure the audio/USB connector bracket to the system board
- (2) Two screws that secure the ExpressCard assembly bracket to the system board
- (3) Two screws that secure the USB/RJ-45 connector bracket to the system board



Where used (model 2140): 2 screws that secure the ExpressCard assembly bracket to the system board

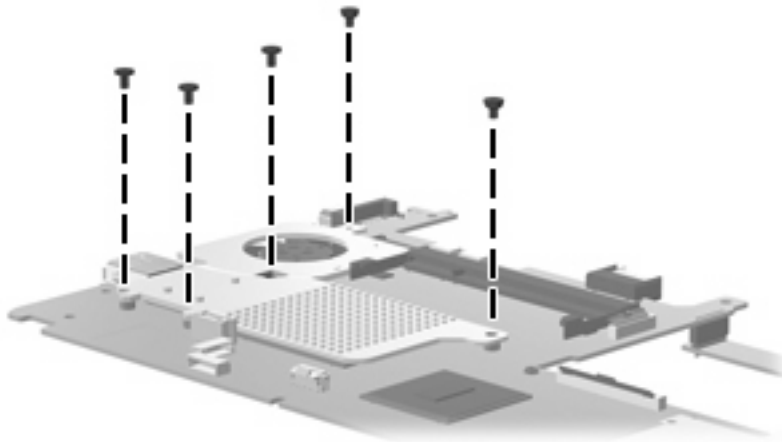

Where used (model 2133): 5 screws that secure the fan/heat sink to the system board

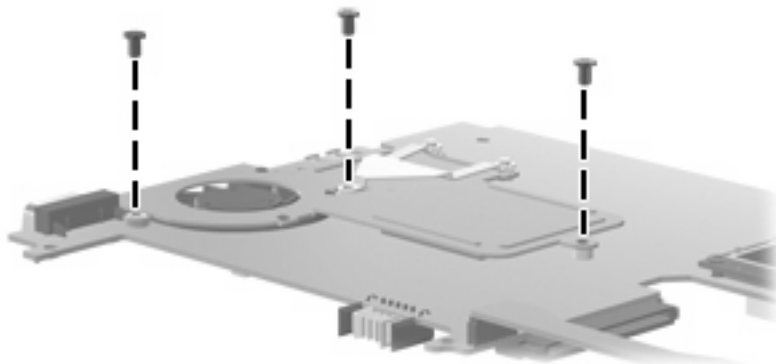

Where used (model 2140): 3 screws that secure the fan/heat sink to the system board

Torx8 T8M2.5×5.0 screw

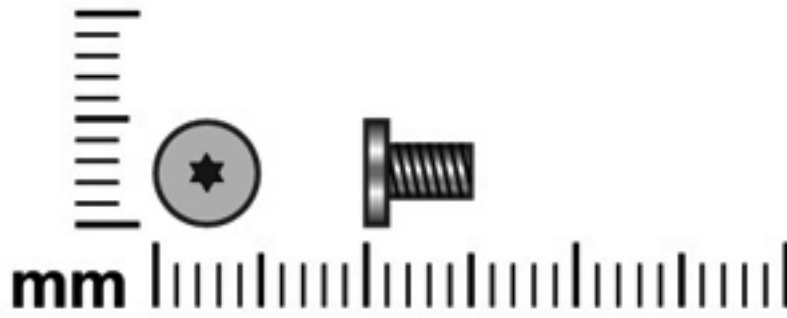

Color	Quantity	Length	Thread	Head diameter
Black	4 (model 2133)	5.0 mm	2.5 mm	5.0 mm
	2 (model 2140)			

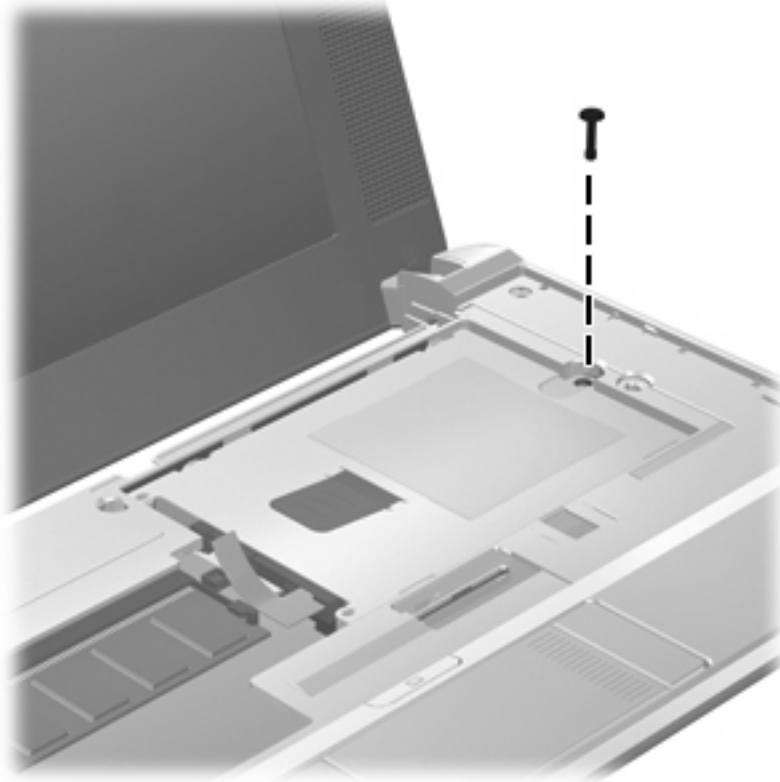

Where used (model 2133): One screw that secures the mass storage device to the computer

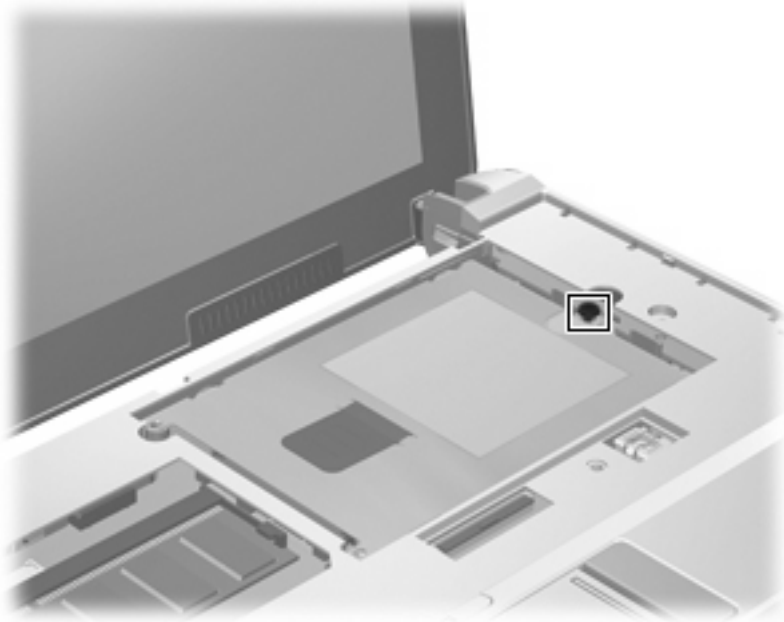

Where used (model 2140): One captive screw that secures the mass storage device to the computer

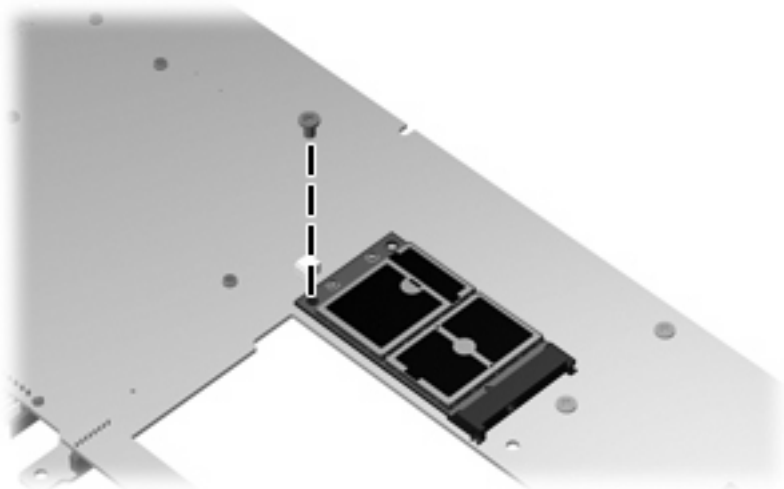

Where used: One screw that secures the WLAN module to the system board

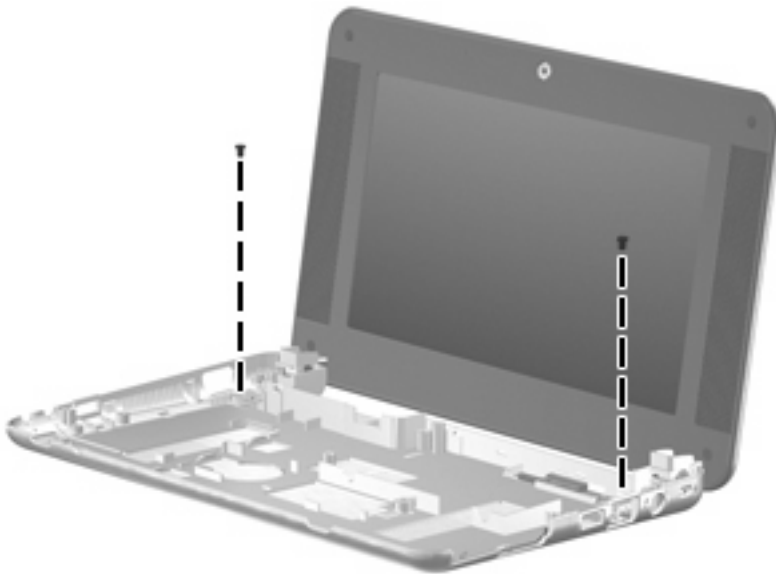

Where used (model 2133): 2 screws that secure the display assembly to the base enclosure

Torx8 T8M2.5×10.0 screw

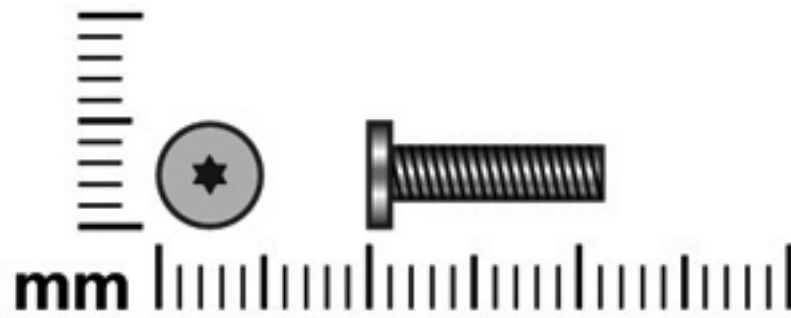

Color	Quantity	Length	Thread	Head diameter
Silver	8	10.0 mm	2.5 mm	5.0 mm

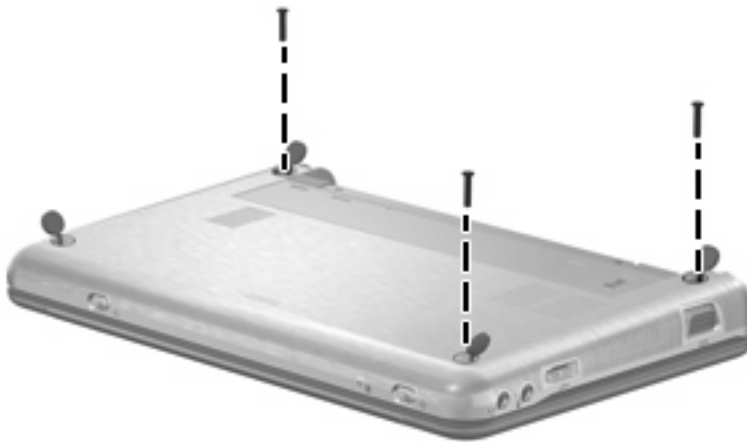

Where used (model 2133): 3 screws that secure the top cover to the computer



Where used (model 2133): One screw that secures the top cover to the computer



Where used (model 2133): 4 screws that secure the display assembly to the base enclosure

Torx8 T8M2.0×4.0 screw

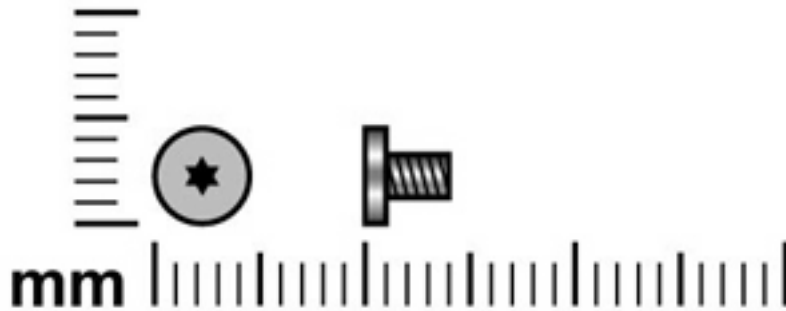

Color	Quantity	Length	Thread	Head diameter
Silver	1	4.0 mm	2.0 mm	4.5 mm



Where used (model 2133): One screw that secures the top cover to the computer

8 Backup and recovery

Backup and recovery in Windows Vista

Backing up and recovering

To protect your information, use the Backup and Restore Center to back up individual files and folders, back up your entire hard drive (select models only), or create system restore points. In case of system failure, you can use the backup files to restore the contents of your computer.

Windows Vista provides the following advanced backup and recovery options:

- Backing up individual files and folders
- Backing up the entire hard drive (select models only)
- Scheduling automatic backups (select models only)
- Creating system restore points
- Recovering individual files
- Restoring the computer to a previous state
- Recovering information using recovery tools

 **NOTE:** For instructions on these procedures, go to Help and Support.

Backing up

Recovery after a system failure is as complete as your most current backup. You should create your initial backup immediately after software setup. As you add new software and data files, you should continue to back up your system on a regular basis to maintain a reasonably current backup.

Note the following when backing up:

- Store personal files in the Documents folder, and back it up regularly.
- Back up templates that are stored in their associated programs.
- Save customized settings that appear in a window, toolbar, or menu bar by taking a screen shot of your settings. The screen shot can be a time-saver if you have to reset your preferences.
- When backing up to discs, use any of the following types of discs (purchased separately): CD-R, CD-RW, DVD+R, DVD+R DL, DVD-R, DVD-R DL, or DVD±RW. The discs you use will depend on the type of optional external optical drive you use.

 **NOTE:** DVDs and DVDs with double-layer (DL) support store more information than CDs, so using them for backup reduces the number of recovery discs required.

- When backing up to discs, number each disc before inserting it into the optional external optical drive.

To create a backup using Backup and Restore Center, follow these steps:

 **NOTE:** Be sure that the computer is connected to AC power before you start the backup process.

NOTE: The backup process may take over an hour, depending on file size and the speed of the computer.

1. Click **Start**, click **All Programs**, click **Maintenance**, and then click **Backup and Restore Center**.
2. Follow the on-screen instructions to back up your entire computer (select models only) or your files.

Recovering

In case of system failure, use the **f11** recovery tool to recover your original hard drive image.

 **NOTE:** The image includes the Windows operating system and software programs installed at the factory.

 **CAUTION:** Using **f11** completely erases hard drive contents and reformats the hard drive. All files you have created and any software installed on the computer are permanently removed. The **f11** recovery tool reinstalls the operating system and HP programs and drivers that were installed at the factory. Software not installed at the factory must be reinstalled. Personal files must be restored from a backup.

1. If possible, back up all personal files.
2. If possible, check for the presence of the HP Recovery partition. To find the partition, click **Start**, and then click **Computer**.

 **NOTE:** If the HP Recovery partition has been deleted, you will need to recover your operating system and programs using the *Windows Vista Operating System* and the *Driver Recovery* discs (purchased separately). For additional information, contact technical support.

3. Turn on or restart the computer, and then press **esc** while the “Press the ESC key for Startup Menu” message is displayed at the bottom of the screen.
4. Press **f11** while the “Press <F11> for recovery” message is displayed on the screen.
5. Follow the on-screen instructions.

 **NOTE:** Windows Vista provides additional recovery tools through the operating system. For additional information, go to Help and Support.

NOTE: If you are unable to boot (start up) your computer, you must purchase a *Windows Vista Operating System DVD* to reboot the computer and repair the operating system. For additional information, contact technical support.

Backup and recovery in Windows XP

Backing up and recovering

To protect your information, use the Windows® Backup utility to back up files and folders or create recovery points. In case of system failure, you can use the backup files to restore your computer.

 **NOTE:** Windows Backup utility is available only on the notebooks with the Windows XP Professional operating system. If your notebook has Windows XP Home, you can back up your personal files to a USB external hard drive (purchased separately).

Windows XP Professional provides the following advanced backup and recovery options:

- Backing up individual files and folders
- Backing up all files and folders
- Scheduling automatic backups
- Creating recovery points
- Recovering information

 **NOTE:** For instructions on these procedures, go to Help and Support.

Backing up

Recovery after a system failure is as complete as your most current backup. You should create your initial backup immediately after software setup. As you add new software and data files, you should continue to back up your system on a regular basis to maintain a reasonably current backup.

In Windows XP Professional, use the Windows Backup utility to create a backup. Click **Start**, click **All Programs**, click **Accessories**, click **System Tools**, and then click **Backup**. Follow the on-screen instructions to back up your files.

In Windows XP Home, copy data files to a USB external hard drive (purchased separately).

Recovering

In case of system failure or instability, use the *Operating System* disc and the *Driver Recovery* discs that are included with the computer to recover your operating system and programs.

 **CAUTION:** The recovery process reformats and completely erases the hard drive. All files you have created and any software installed on the computer are permanently removed. The recovery process reinstalls the original operating system as well as software and drivers. Software, drivers, and updates not installed by HP must be manually reinstalled. Personal files must be restored from a backup.

1. If possible, back up all personal files.
2. Shut down the computer.
3. Insert the *Operating System* disc into an optional external optical drive.
4. Turn on the computer.
5. Follow the on-screen instructions to install the operating system.

6. After the operating system is installed, remove the *Operating System* disc and insert the Driver Recovery disc.
7. Follow the on-screen instructions to install the drivers and programs.

 **NOTE:** For additional information about recovery tools, go to Help and Support.

Backup and recovery in SUSE Linux Enterprise Desktop

Performing a recovery

△ **CAUTION:** Using **f11** completely erases hard drive contents and reformats the hard drive. All files you have created and any software installed on the computer are permanently removed. The **f11** recovery tool reinstalls the operating system and HP programs and drivers that were installed at the factory. Software not installed at the factory must be reinstalled.

To recover the original hard drive image using **f11**, follow these steps:

1. If possible, back up all personal files.
2. Press **f11** while the "Press <F11> for recovery" message is displayed on the screen.
3. Follow the on-screen instructions.

9 Connector pin assignments

Audio-out (headphone)

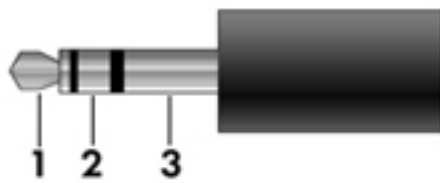

Pin	Signal
1	Audio out, left channel
2	Audio out, right channel
3	Ground

Audio-in (microphone)

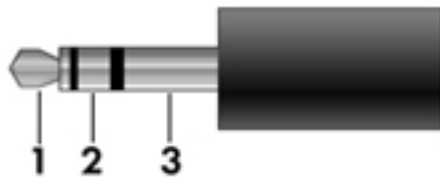

Pin	Signal
1	Audio signal in
2	Audio signal in
3	Ground

External monitor

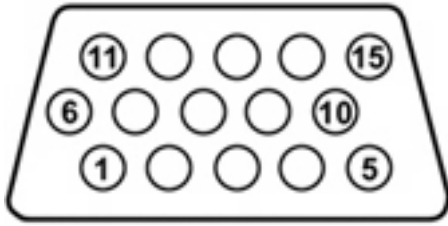

Pin	Signal
1	Red analog
2	Green analog
3	Blue analog
4	Not connected
5	Ground
6	Ground analog
7	Ground analog
8	Ground analog
9	+5 VDC
10	Ground
11	Monitor detect
12	DDC 2B data
13	Horizontal sync
14	Vertical sync
15	DDC 2B clock

RJ-45 (network)

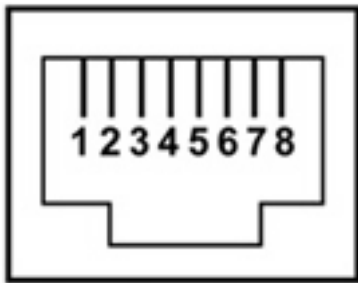

Pin	Signal
1	Transmit +
2	Transmit -
3	Receive +
4	Unused
5	Unused
6	Receive -
7	Unused
8	Unused

Universal Serial Bus

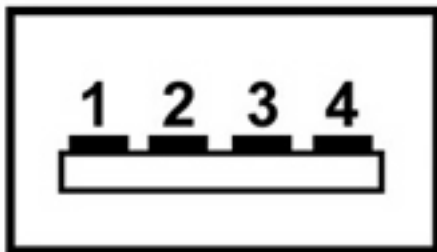

Pin	Signal
1	+5 VDC
2	Data -
3	Data +
4	Ground

10 Power cord set requirements

The wide range input feature of the computer permits it to operate from any line voltage from 100 to 120 volts AC or from 220 to 240 volts AC.

The 3-conductor power cord set included with the computer meets the requirements for use in the country or region where the equipment is purchased.

Power cord sets for use in other countries and regions must meet the requirements of the country or region where the computer is used.

Requirements for all countries and regions

The requirements listed below are applicable to all countries and regions:

- The length of the power cord set must be at least 1.5 m (5.0 ft) and no more than 2.0 m (6.5 ft).
- All power cord sets must be approved by an acceptable accredited agency responsible for evaluation in the country or region where the power cord set will be used.
- The power cord sets must have a minimum current capacity of 10 amps and a nominal voltage rating of 125 or 250 V AC, as required by the power system of each country or region.
- The appliance coupler must meet the mechanical configuration of an EN 60 320/IEC 320 Standard Sheet C13 connector for mating with the appliance inlet on the back of the computer.

Requirements for specific countries and regions

Country/region	Accredited agency	Applicable note number
Australia	EANSW	1
Austria	OVE	1
Belgium	CEBC	1
Canada	CSA	2
Denmark	DEMKO	1
Finland	FIMKO	1
France	UTE	1
Germany	VDE	1
Italy	IMQ	1
Japan	METI	3
Korea	EK	4
The Netherlands	KEMA	1
Norway	NEMKO	1
The People's Republic of China	CCC	5
Sweden	SEMKO	1
Switzerland	SEV	1
Taiwan	BSMI	4
The United Kingdom	BSI	1
The United States	UL	2

1. The flexible cord must be Type HO5VV-F, 3-conductor, 1.0-mm² conductor size. Power cord set fittings (appliance coupler and wall plug) must bear the certification mark of the agency responsible for evaluation in the country or region where it will be used.
2. The flexible cord must be Type SPT-3 or equivalent, No. 18 AWG, 3-conductor. The wall plug must be a two-pole grounding type with a NEMA 5-15P (15 A, 125 V) or NEMA 6-15P (15 A, 250 V) configuration.
3. The appliance coupler, flexible cord, and wall plug must bear a "T" mark and registration number in accordance with the Japanese Dentori Law. The flexible cord must be Type VCT or VCTF, 3-conductor, 1.00-mm² conductor size. The wall plug must be a two-pole grounding type with a Japanese Industrial Standard C8303 (7 A, 125 V) configuration.
4. The flexible cord must be Type RVV, 3-conductor, 0.75-mm² conductor size. Power cord set fittings (appliance coupler and wall plug) must bear the certification mark of the agency responsible for evaluation in the country or region where it will be used.
5. The flexible cord must be Type VCTF, 3-conductor, 0.75-mm² conductor size. Power cord set fittings (appliance coupler and wall plug) must bear the certification mark of the agency responsible for evaluation in the country or region where it will be used.

11 Recycling

Battery

When a battery has reached the end of its useful life, do not dispose of the battery in general household waste. Follow the local laws and regulations in your area for computer battery disposal.

Display

-
- ⚠ **WARNING!** The backlight contains mercury. Exercise caution when removing and handling the backlight to avoid damaging this component and causing exposure to the mercury.
 - ⚠ **CAUTION:** The procedures in this appendix can result in damage to display components. The only components intended for recycling purposes are the liquid crystal display (LCD) panel and the backlight. Careful handling must be exercised when removing these components. When you remove these components, handle them carefully.
 - 📄 **NOTE: Materials Disposal.** This HP product contains mercury in the backlight in the display assembly that might require special handling at end-of-life. Disposal of mercury may be regulated because of environmental considerations. For disposal or recycling information, contact your local authorities, or see the Electronic Industries Alliance (EIA) Web site at <http://www.eiae.org>.
-

This section provides disassembly instructions for the display assembly. The display assembly must be disassembled to gain access to the backlight **(1)** and the liquid crystal display (LCD) panel **(2)**.



-
- 📄 **NOTE:** The procedures provided in this appendix are general disassembly instructions. Specific details, such as screw sizes, quantities, and locations, and component shapes and sizes, can vary from one computer model to another.
-

Perform the following steps to disassemble the display assembly:

1. Remove all screw covers (1) and screws (2) that secure the display bezel to the display assembly.

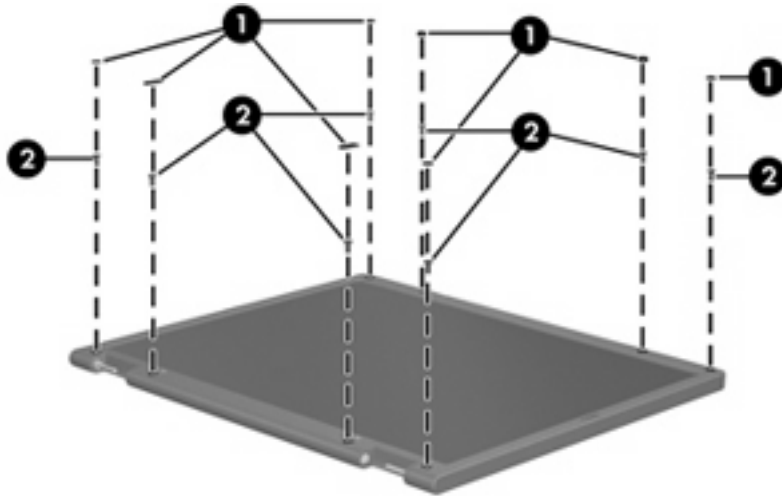

2. Lift up and out on the left and right inside edges (1) and the top and bottom inside edges (2) of the display bezel until the bezel disengages from the display assembly.

3. Remove the display bezel (3).

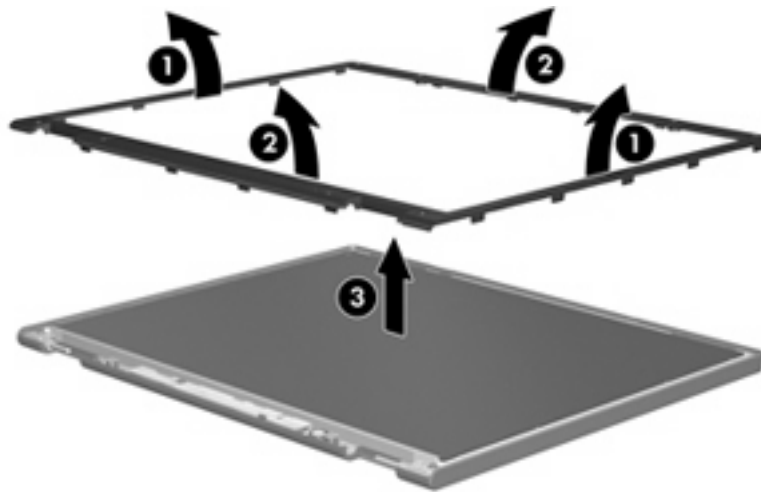

4. Disconnect all display panel cables (1) from the display inverter and remove the inverter (2).

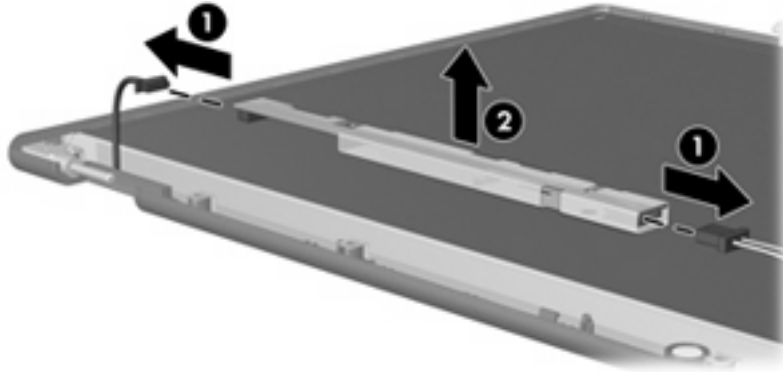

5. Remove all screws (1) that secure the display panel assembly to the display enclosure.
6. Remove the display panel assembly (2) from the display enclosure.

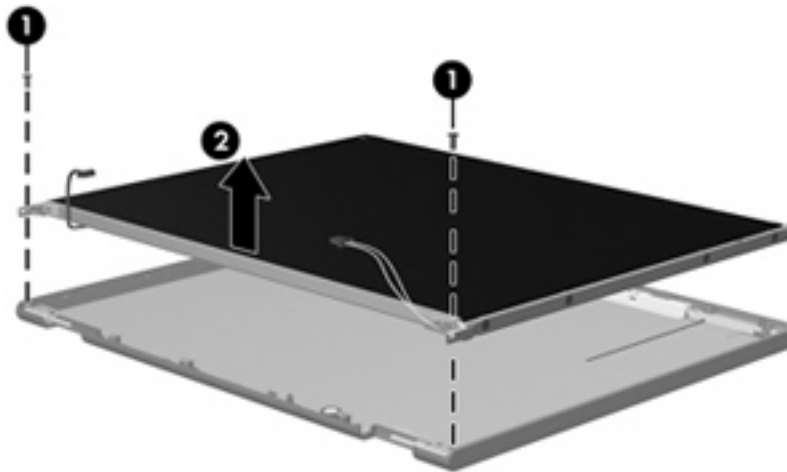

7. Turn the display panel assembly upside down.
8. Remove all screws that secure the display panel frame to the display panel.

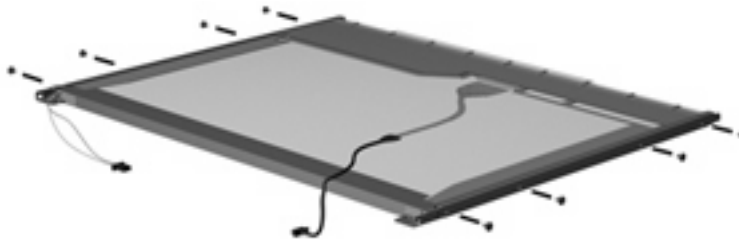

9. Use a sharp-edged tool to cut the tape (1) that secures the sides of the display panel to the display panel frame.

10. Remove the display panel frame (2) from the display panel.

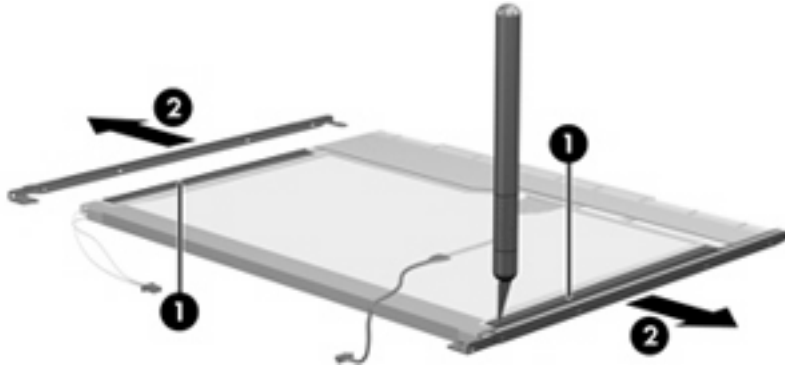

11. Remove the screws (1) that secure the backlight cover to the display panel.
12. Lift the top edge of the backlight cover (2) and swing it outward.

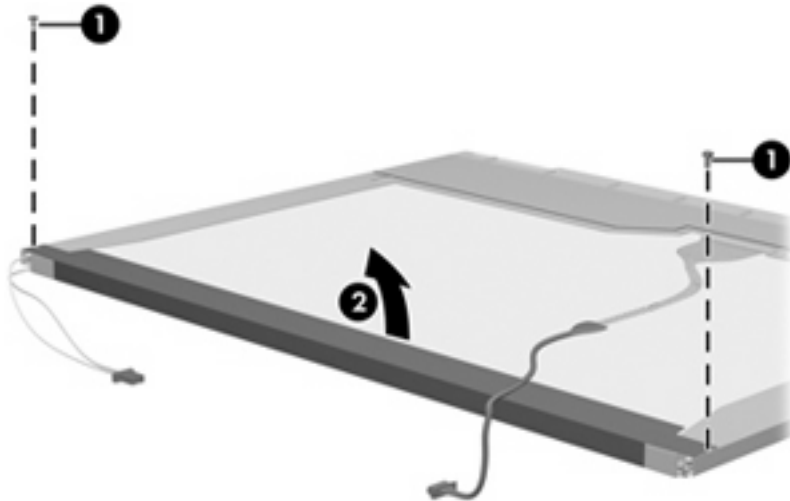

13. Remove the backlight cover.
14. Turn the display panel right-side up.

15. Remove the backlight cables (1) from the clip (2) in the display panel.

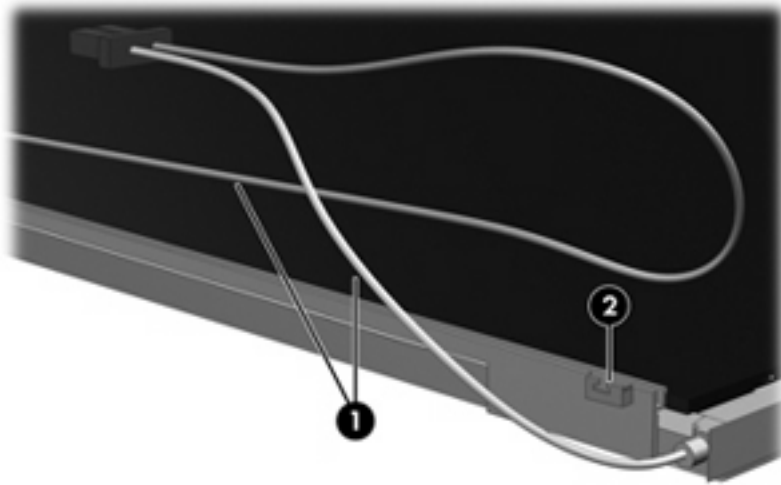

16. Turn the display panel upside down.

⚠ WARNING! The backlight contains mercury. Exercise caution when removing and handling the backlight to avoid damaging this component and causing exposure to the mercury.

17. Remove the backlight frame from the display panel.

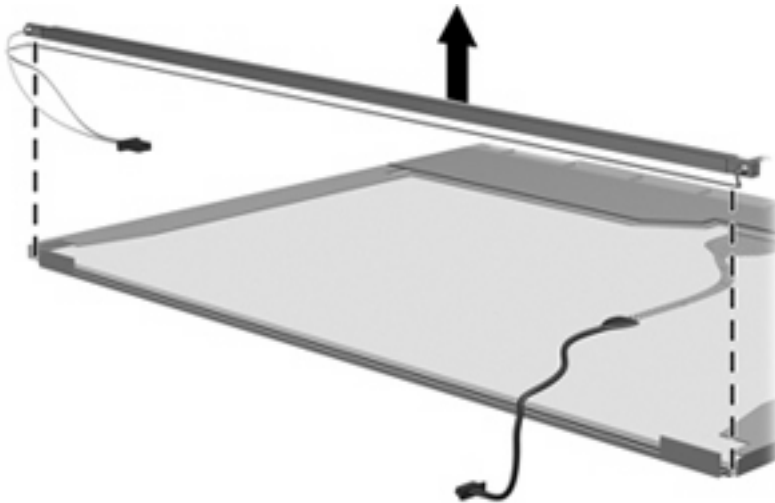

18. Remove the backlight from the backlight frame.

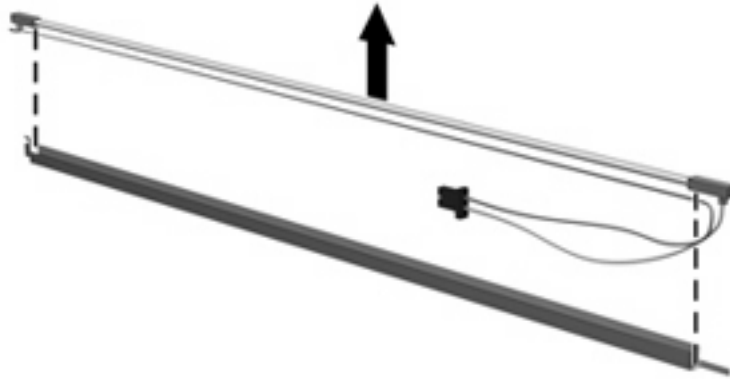

19. Disconnect the display panel cable (1) from the LCD panel.
20. Remove the screws (2) that secure the LCD panel to the display rear panel.
21. Release the LCD panel (3) from the display rear panel.
22. Release the tape (4) that secures the LCD panel to the display rear panel.

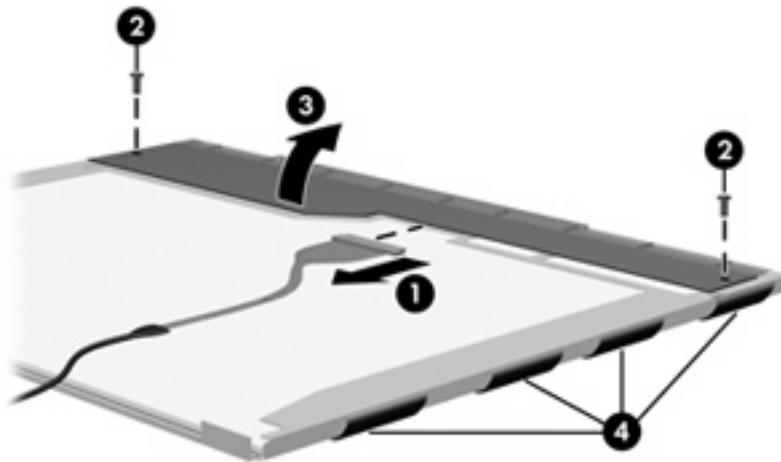

23. Remove the LCD panel.

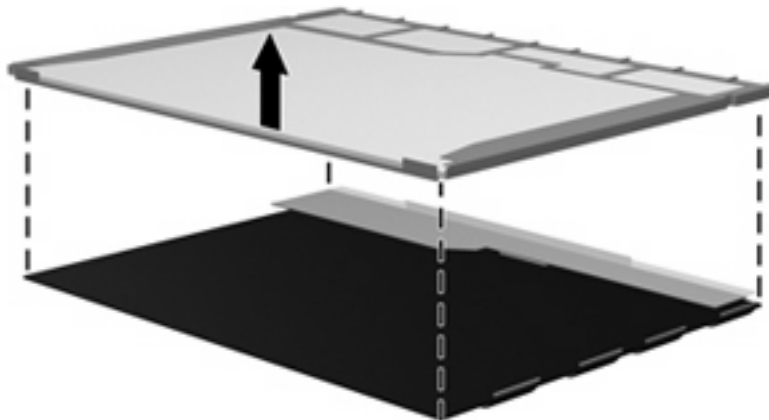

24. Recycle the LCD panel and backlight.

Index

- A**
 - AC adapter, spare part
 - number 29, 32
 - antenna
 - disconnecting 62
 - locations 5
 - antennas, model 2133 12
 - antennas, model 2140 20
 - audio board
 - removal 55
 - spare part number 24, 32, 34, 55
 - audio, product description 2
 - audio-in jack
 - location 10
 - pin assignments 107
 - audio-out jack
 - location 10
 - pin assignments 107
 - audio/USB connector bracket
 - illustrated 28
 - removal 61
 - B**
 - backing up 103
 - base enclosure, spare part
 - number 27, 32, 34
 - battery
 - location 11
 - removal 44
 - spare part numbers 27, 32, 44
 - battery bay 11, 19
 - battery latches 11
 - battery light 9
 - battery light, identifying 17
 - battery release latches, identifying 19
 - Bluetooth module
 - removal 57
 - spare part numbers 25, 30, 31, 57
 - Bluetooth module cable 29
 - boot options 77
 - boot order 77
 - bottom components, model 2133 11
 - bottom components, model 2140 19
 - Bracket Kit
 - contents 28
 - spare part number 25, 28, 32
 - buttons
 - TouchPad 15
 - buttons, TouchPad 7
- C**
 - cables, service considerations 37
 - chipset, product description 1
 - CMOS clearing 41
 - components
 - bottom, model 2133 11
 - bottom, model 2140 19
 - display, model 2133 5
 - display, model 2140 13
 - front, model 2133 8
 - front, model 2140 16
 - keys, model 2133 6
 - keys, model 2140 14
 - left-side, model 2133 10
 - left-side, model 2140 18
 - pointing devices, model 2133 7
 - pointing devices, model 2140 15
 - right-side, model 2133 9
 - right-side, model 2140 17
 - top 5
 - TouchPad, model 2133 7
 - TouchPad, model 2140 15
 - computer feet
 - locations 43
 - spare part number 43
 - Computer Setup
 - Diagnostics menu 77
 - File menu 76
 - navigating and selecting 75
 - restoring factory settings 75
 - Security menu 76
 - System Configuration menu 77
 - computer specifications 79
 - connector, power 17
 - connectors
 - power 9
 - service considerations 37
- D**
 - Diagnostics menu 77
 - diskette drive
 - precautions 37
 - product description 2
 - display assembly
 - removal 71
 - spare part numbers 22, 23, 32, 34, 71
 - display component recycling 112
 - display components, model 2133 5
 - display components, model 2140 13
 - display specifications 80, 81
 - drive light 8, 16
 - drives
 - preventing damage 37
 - drives, boot order 77

E

electrostatic discharge 38
embedded numeric keypad keys,
 identifying 14
esc key 6
esc key, identifying 14
Ethernet, product description 2
ExpressCard assembly bracket
 illustrated 28
 removal 61
ExpressCard slot 9
ExpressCard slot bezel 29
ExpressCard slot, identifying 17
external media cards, product
 description 2
external monitor port
 location 10
 pin assignments 108
external monitor port,
 identifying 18

F

fan/heat sink
 removal 68
 spare part number 24, 32,
 35, 68
feet
 locations 43
 spare part number 43
File menu 76
flash storage drive, product
 description 2
fn key 6
fn key, identifying 14
front components, model 2133 8
front components, model
 2140 16
function keys 6
function keys, identifying 14

G

graphics, product description 1
grounding equipment and
 methods 40

H

hard drive
 precautions 37
 product description 2
 removal 49

 spare part numbers 24, 32,
 49
 specifications 84
headphone jack
 location 10
 pin assignments 107

I

I/O address specifications 87
individual file recovery 103
internal microphones,
 identifying 13
interrupt specifications 86

J

jacks
 audio-in 10, 18
 audio-out 10, 18
 headphone 10
 microphone 10
 network 9
 RJ-45 9
 RJ-45 (network) 17

K

key components, model 2133 6
key components, model 2140 14
keyboard
 product description 3
 removal 45
 spare part numbers 23, 33,
 45
keypad keys 6
keys
 esc 6, 14
 fn 6, 14
 function 6, 14
 keypad 6, 14
 Windows applications 6
 Windows logo 6

L

labels
 service tag 19
latches, battery release 19
left-side components, model
 2133 10
left-side components, model
 2140 18
legacy support, USB 74, 78

lights

 battery 9, 17
 drive 8, 16
 power 8, 16
 TouchPad 15
 wireless 8, 16

M

mass storage device
 product description 2
 removal 49
 spare part numbers 24, 49
memory map specifications 89
memory module
 product description 1
 removal 48
 spare part numbers 24, 31,
 48
microphone jack
 location 10
 pin assignments 107
microphones 6
microphones, internal 13
model name 1
modem, product description 2
monitor port
 location 10
 pin assignments 108
monitor port, external 18

N

network jack
 location 9
 pin assignments 109

O

operating system, product
 description 3
optical drive, product
 description 2

P

packing guidelines 39
panels, product description 1
password clearing 41
passwords 76
pin assignments
 audio-in jack 107
 audio-out jack 107
 external monitor port 108
 headphone jack 107

- microphone jack 107
- monitor port 108
- network jack 109
- RJ-45 jack 109
- Universal Serial Bus (USB)
 - port 109
- plastic parts 36
- Plastics/Cable Kit
 - contents 29
 - spare part number 25, 29, 33, 35
- pointing device
 - components, model 2133 7
 - components, model 2140 15
 - illustrated 7, 15
- pointing device components
 - TouchPad 7
 - TouchPad buttons 7
 - TouchPad on/off button 7
 - TouchPad scroll zone 7
- pointing devices, product
 - description 3
- ports
 - external monitor 10, 18
 - monitor 10
 - power USB 10
 - product description 3
 - Universal Serial Bus (USB) 9
 - USB 10, 17, 18
- power connector 9
- power connector, identifying 17
- power cord
 - set requirements 110
 - spare part numbers 29, 30
- power light 8, 16
- power requirements, product
 - description 3
- power switch 8, 16
- powered USB port 10
- processor, product description 1
- product description
 - audio 2
 - chipset 1
 - diskette drive 2
 - Ethernet 2
 - external media cards 2
 - flash storage drive 2
 - graphics 1
 - hard drive 2
 - keyboard 3
 - mass storage devices 2
 - memory module 1
 - modem 2
 - operating system 3
 - optical drive 2
 - panels 1
 - pointing devices 3
 - ports 3
 - power requirements 3
 - processors 1
 - product name 1
 - security 3
 - serviceability 3
 - solid-state drive 2
 - webcam 2
 - wireless 2
- product name 1
- product name and number,
 - computer 19
- R**
 - recovery partition 103
 - release latches, battery 19
 - removal/replacement
 - preliminaries 36
 - procedures 42
 - right-side components, model
 - 2133 9
 - right-side components, model
 - 2140 17
 - RJ-45 (network) jack,
 - identifying 17
 - RJ-45 jack
 - location 9
 - pin assignments 109
 - RTC battery
 - removal 66
 - spare part number 25, 31, 32, 66
 - Rubber Kit, spare part
 - number 33, 35
- S**
 - Screw Kit
 - contents 90
 - spare part number 30, 33, 35
 - screw listing 90
 - scrolling regions, TouchPad 15
 - SD Card Reader 9, 17
 - SD Card slot bezel 29
 - security cable slot 9
 - security cable slot, identifying 17
 - Security menu 76
 - security, product description 3
 - serial number 21, 42
 - serial number, computer 19
 - service considerations 36
 - service tag 11, 19
 - serviceability, product
 - description 3
 - setup utility
 - Diagnostics menu 77
 - File menu 76
 - navigating and selecting 75
 - restoring factory settings 75
 - Security menu 76
 - System Configuration
 - menu 77
 - slots
 - ExpressCard 17
 - security cable 17
 - solid-state drive
 - product description 2
 - removal 49
 - spare part number 24, 32, 34, 49
 - speakers 5
 - speakers, identifying 13
 - specifications
 - computer 79
 - display 80, 81
 - hard drive 84
 - I/O addresses 87
 - interrupts 86
 - memory map 89
 - system DMA 85
 - static-shielding materials 40
 - stringent security 76
 - switches
 - power 8, 16
 - wireless 8, 16
 - system board
 - removal 59
 - spare part numbers 25, 32, 34, 59
 - System Configuration menu 77
 - system DMA 85
 - system failure or instability 103
 - system fan 78

- system information 76
- system memory map 89
- system restore points 103

T

- thermal material, replacement 69
- tools required 36
- top components 5
- top cover
 - removal 52
 - spare part number 24, 32, 35, 52
- TouchPad
 - buttons 15
 - identifying 15
 - scrolling regions 15
- TouchPad buttons 7
- TouchPad components, model 2133 7
- TouchPad components, model 2140 15
- TouchPad on/off button 7
- TouchPad scroll zone 7
- transporting guidelines 39

U

- unknown password 41
- USB legacy support 74, 78
- USB port
 - location 9
 - pin assignments 109
- USB ports, identifying 17, 18
- USB/RJ-45 connector bracket
 - illustrated 28
 - removal 61

V

- vents 10, 11
- vents, identifying 18, 19
- video, recording 13

W

- webcam 6, 13
- webcam, product description 2
- Windows applications key 6
- Windows logo key 6
- wireless antenna
 - disconnecting 62
 - locations 5
- wireless antennas, model 2133 12
- wireless antennas, model 2140 20
- wireless light 8, 16
- wireless switch 8, 16
- wireless, product description 2
- WLAN module
 - removal 63
 - spare part numbers 25, 31, 63
- workstation guidelines 39

