



OFFICEJET PRO 8000

www.hp.com/support



A809

Start Démarrage Inicio Início

Lea esto primero

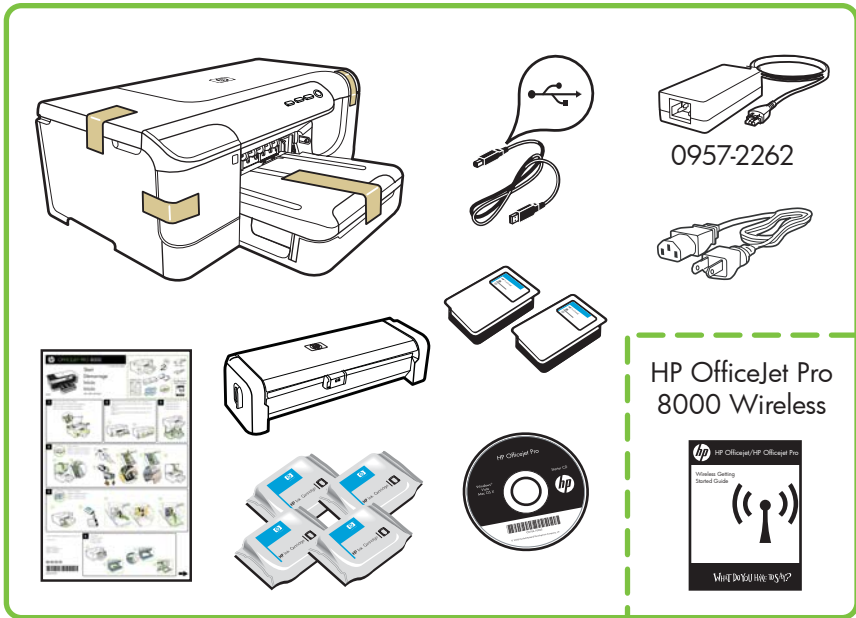

0957-2262

HP OfficeJet Pro
8000 Wireless



1

Remove tape and packing materials.
Enlevez le ruban et les matériaux d'emballage.
Retire la cinta y los materiales de embalaje.
Remova as fitas e o material de embalagem.

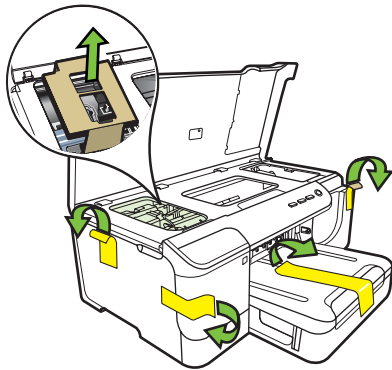

2

Install HP automatic two-sided printing accessory (duplexer).
Installez l'accessoire d'impression recto verso automatique HP.
Instale el accesorio (duplexor) de impresión automática a doble cara HP.
Instale o acessório de impressão dupla-face automático HP (duplexador).

2a

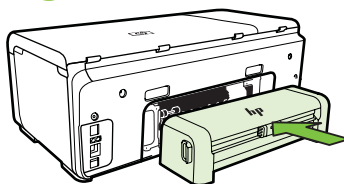

2b

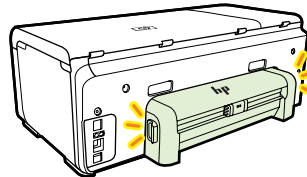

3

Install optional tray 2.
Installez le bac 2 (en option).
Instale la bandeja opcional 2.
Instale a bandeja 2 (opcional).

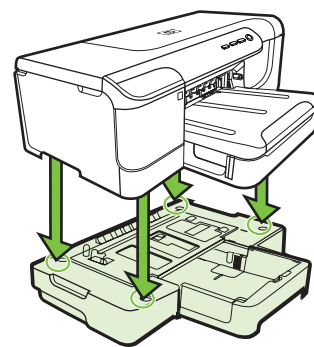

4

Install printheads.
Installez les têtes d'impression.
Instale los cabezales de impresión.
Instale os cabeçotes de impressão.

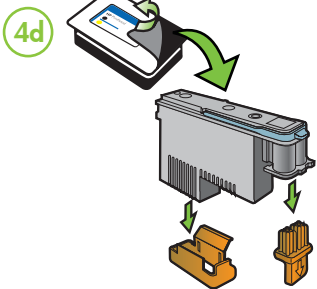
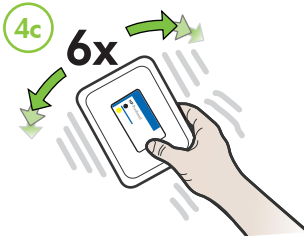

4e

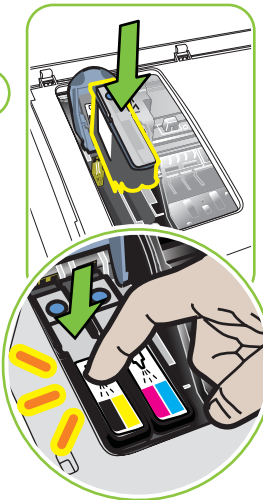

4f

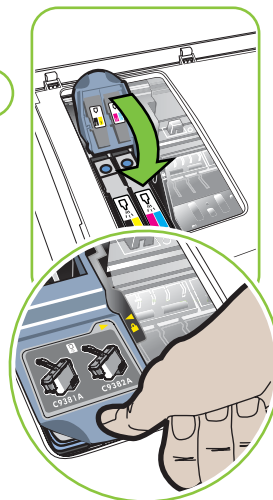

4g

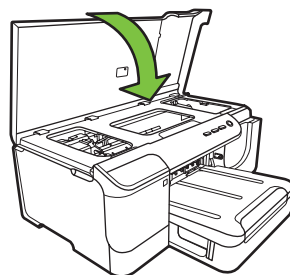

4a

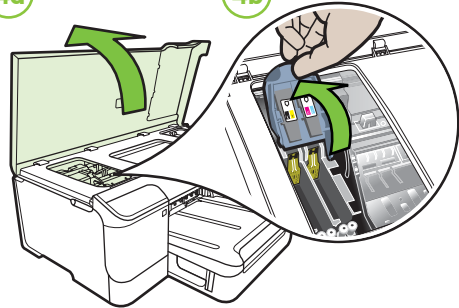

4b

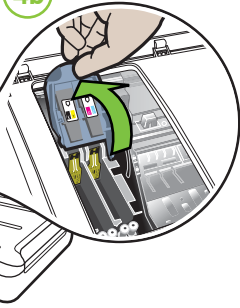

5

Install printheads.
Installez les têtes d'impression.
Instale los cabezales de impresión.
Instale os cabeçotes de impressão.



5a

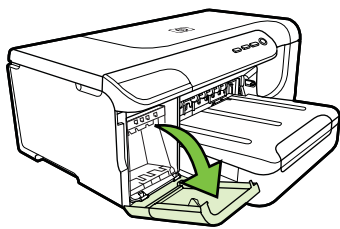

5b

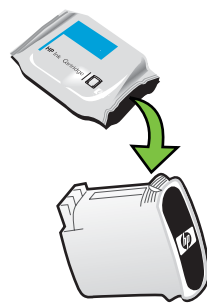

5c

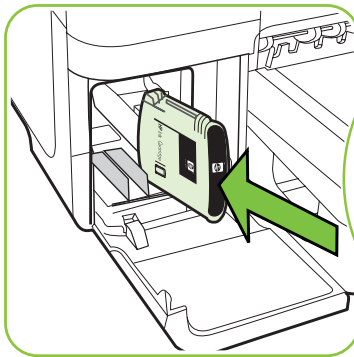

5d

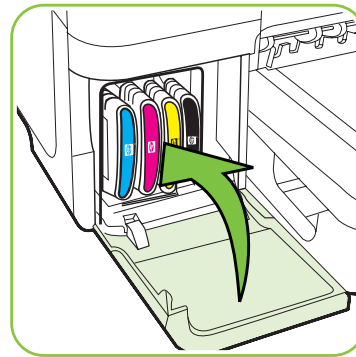

6

Load paper.
Chargez le papier.
Cargue el papel.
Carregue o papel.

6a

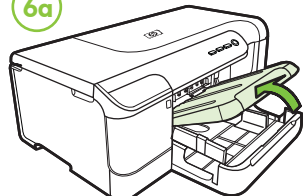

6b

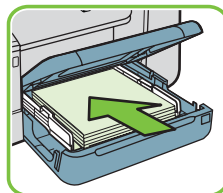

6c

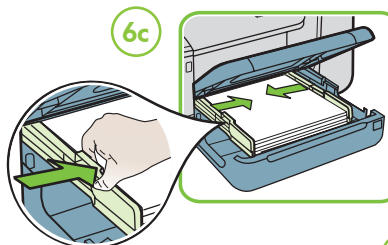

6d

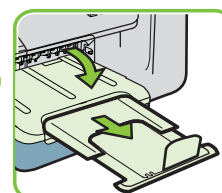

© 2009 Hewlett-Packard Development Company, L.P.

www.hp.com

Printed in Malaysia
Imprimé en Malaisie
马来西亚印刷
말레이시아에서 인쇄

EN FR ES PT



C9297-90001

7

7

Connect power cord and adapter, turn on all-in-one, and wait for alignment page to print.

Branchez le cordon d'alimentation et l'adaptateur de secteur, allumez le tout-en-une et attendez l'impression de la page d'alignement.

Conecte el cable de alimentación y el adaptador, encienda el todo en uno y espere que se imprima la página de alineación.

Conecte o cabo de alimentação e o adaptador, ligue a unidade all-in-one e aguarde a página de alinhamento ser impressa.

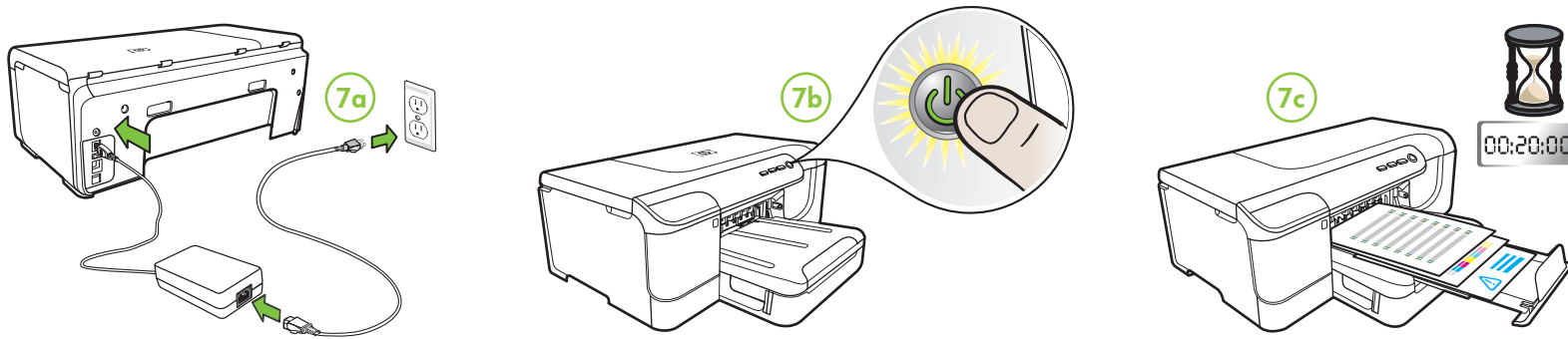

8



USB



Wireless (802.11)

EN Windows: Install software first. Do NOT connect the USB cable until prompted.
Mac OS X: Connect the USB cable, and then install the software.

FR Windows: Installez d'abord le logiciel. Ne branchez PAS le câble USB avant d'être invité.
Mac OS X: Branchez le câble USB, puis installez le logiciel.

ES Windows: Instale el software primero. NO conecte el cable USB hasta que se le solicite.
Mac OS X: Conecte el cable USB y luego instale el software.

PT NO Windows: Primeiro instale o software. Não conecte o cabo USB antes de solicitado.
NO Mac OS X: Conecte o cabo USB e, em seguida, instale o software.

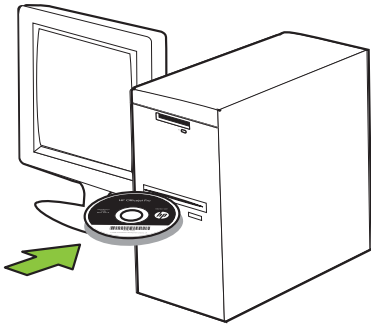

EN Note: For information about connecting the product using wireless (802.11), see the Wireless Getting Started Guide.

FR Remarque : Pour plus d'informations sur la connexion du périphérique en mode sans fil (802.11), consultez le Guide de mise en route sans fil.

ES Nota: para obtener información sobre la conexión del equipo mediante red inalámbrica (802.11), consulte la Guía de inicio del sistema inalámbrico.

PT Observação: Para obter informações sobre como conectar o produto de modo sem fio (802.11), consulte o Guia de Introdução a Dispositivos Sem Fio.



Ethernet

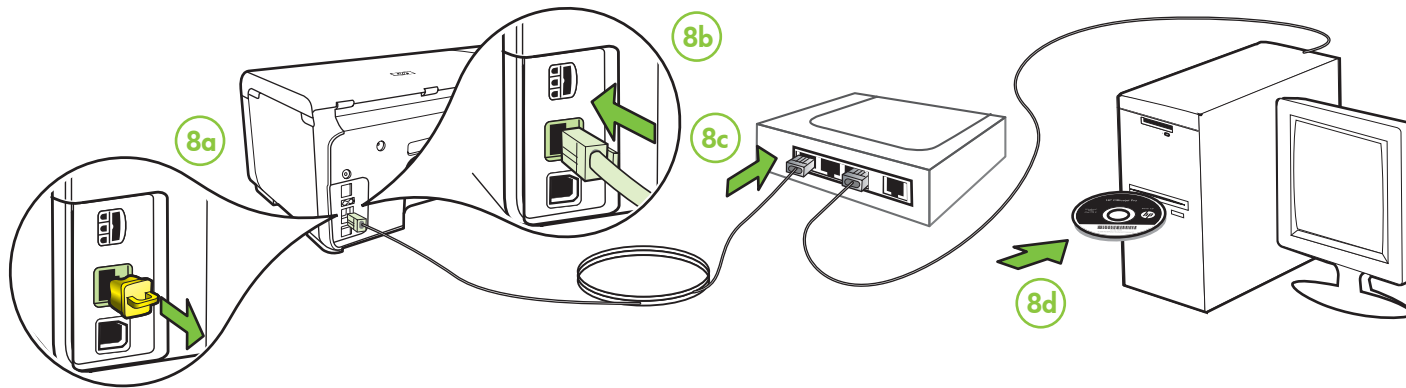

EN Obtain IP address, hardware (MAC) address, and mDNS (Bonjour) name.

The configuration page contains network settings and other information for the printer. To print this page, press or on the control panel.

FR Obtenez une adresse IP, une adresse matérielle (MAC) et un nom mDNS (Bonjour).

La page de configuration contient des paramètres réseau et d'autres informations pour l'imprimante. Pour imprimer cette page, appuyez sur / sur le panneau de commande.

ES Obtenga la dirección IP, la dirección (MAC) del hardware y el nombre de mDNS (Bonjour).

La página de configuración contiene los ajustes de red y otra información para la impresora. Para imprimir esta página, presione / en el panel de control.

PT Obtenha endereço IP, endereço de hardware (MAC) e nome mDNS (Bonjour).

A página de configuração contém definições de rede e outras informações da impressora. Para imprimir esta página, pressione / no painel de controle.



www.hp.com/support

EN Learn More!

An electronic User Guide is available on your computer after you install the software—either from the HP Solution Center Software (Windows) or the Help Viewer (Mac OS X). This guide provides information on the following topics:

- Troubleshooting information
- Important safety notices and regulatory information
- Information about supported printing supplies
- Detailed user instructions

You can also find more information at HP's support website (www.hp.com/support).

For more information and support using this product with Linux, visit <http://www.hp.com/go/linuxprinting>.

Note: Ink from the cartridges is used in the printing process in a number of different ways, including in the initialization process, which prepares the device and cartridges for printing, and in printhead servicing, which keeps print nozzles clear and ink flowing smoothly. In addition, some residual ink is left in the cartridge after it is used. For more information see www.hp.com/go/inkusage.

FR Informations supplémentaires

Un Guide de l'utilisateur est disponible sur votre ordinateur après avoir installé le logiciel - à partir du centre de distribution de logiciels HP (Windows) ou à partir de l'afficheur d'aide (Mac OS X). Ce guide propose des informations sur les sujets suivants :

- Informations de dépannage
- Informations importantes sur la sécurité et informations réglementaires
- Informations sur les fournitures d'impression prises en charge
- Instructions détaillées à l'intention de l'utilisateur

Vous trouverez également des informations complémentaires sur le site d'assistance HP (www.hp.com/support).

Pour plus d'informations et pour obtenir une assistance sur l'utilisation de ce produit avec Linux, accédez à l'adresse <http://www.hp.com/go/linuxprinting>.

Remarque : L'encre des cartouches est utilisée dans le processus d'impression de différentes manières, notamment lors de la phase d'initialisation, qui prépare l'appareil et les cartouches pour l'impression, et lors de l'entretien de la tête d'impression, qui maintient les buses dégagées et garantit une libre circulation de l'encre. Notez également qu'il reste de l'encre dans la cartouche après son utilisation. Pour plus d'informations, reportez-vous à la page Web www.hp.com/go/inkusage.

ES ¡Sepa más!

Habrá una Guía del usuario electrónica disponible en su equipo después de instalar el software, ya sea en el software de Centro de soluciones HP (Windows) o el Visor de ayuda (Mac OS X). Esta guía proporciona información sobre los temas siguientes:

- Información sobre solución de problemas
- Avisos de seguridad importantes e información regulatoria
- Información acerca de los suministros de impresión admitidos
- Instrucciones detalladas para el usuario

Puede obtener más información en el sitio Web de asistencia de HP (www.hp.com/support).

Para obtener más información y soporte usando este producto con Linux, visite <http://www.hp.com/go/linuxprinting>.

Nota: La tinta de los cartuchos se usa en el proceso de impresión de diversas formas, que incluyen el proceso de inicialización, donde se prepara el dispositivo y los cartuchos para la impresión y el servicio de los cabezales de impresión, que mantiene los inyectores de tinta despejados y permite que la tinta fluya sin problemas. Además, se deja un poco de tinta residual en el cartucho después de su uso. Para obtener más información, consulte la página Web www.hp.com/go/inkusage.

PT Para aprender mais

Um Guia do Usuário eletrônico estará disponível em seu computador depois de instalar o software a partir do software Central de Soluções HP (Windows) ou do Visualizador de Ajuda (MacOS). Esse guia fornece informações sobre os seguintes tópicos:

- Informações sobre resolução de problemas
- Avisos importantes sobre segurança e informações regulamentares
- Para obter informações sobre acessórios de impressão permitidos:
- Instruções detalhadas para o usuário

Você também pode encontrar mais informações no site de suporte técnico da HP (www.hp.com/support).

Para obter mais informações e suporte para usar este produto com Linux, visite <http://www.hp.com/go/linuxprinting>.

Observação: A tinta dos cartuchos é usada no processo de impressão de várias maneiras, incluindo o processo de inicialização que prepara o dispositivo e os cartuchos para impressão, e o serviço de manutenção do cabeçote de impressão, que mantém os bicos de impressão limpos e a tinta fluindo normalmente. Além disso, sempre fica um pouco de tinta no cartucho após seu uso. Para obter mais informações, consulte www.hp.com/go/inkusage.