

Power Management User Guide

© Copyright 2009 Hewlett-Packard
Development Company, L.P.

Windows is a U.S. registered trademark of
Microsoft Corporation.

The information contained herein is subject
to change without notice. The only
warranties for HP products and services are
set forth in the express warranty statements
accompanying such products and services.
Nothing herein should be construed as
constituting an additional warranty. HP shall
not be liable for technical or editorial errors
or omissions contained herein.

First Edition: February 2009

Document Part Number: 512511-001

Product notice

This user guide describes features that are
common to most models. Some features
may not be available on your computer.

Table of contents

1 Setting power options

Using power-saving states	1
Initiating and exiting Sleep	1
Initiating and exiting Hibernation	2
Using the battery meter	3
Using power plans	4
Viewing the current power plan	4
Selecting a different power plan	4
Customizing power plans	4
Setting password protection on wakeup	5

2 Using external AC power

Connecting the AC adapter	7
---------------------------------	---

3 Using battery power

Finding battery information in Help and Support	9
Using Battery Check	10
Displaying the remaining battery charge	11
Inserting or removing the battery	12
Charging a battery	13
Maximizing battery discharge time	14
Managing low battery levels	15
Identifying low battery levels	15
Resolving a low battery level	15
Resolving a low battery level when external power is available	15
Resolving a low battery level when a charged battery is available	15
Resolving a low battery level when no power source is available	15
Resolving a low battery level when the computer cannot exit Hibernation	16
Calibrating a battery	17
Step 1: Fully charge the battery	17
Step 2: Disable Hibernation and Sleep	17
Step 3: Discharge the battery	18
Step 4: Fully recharge the battery	18
Step 5: Reenable Hibernation and Sleep	18

Conserving battery power	20
Storing a battery	20
Disposing of a used battery	21
Replacing the battery	21

4 Shutting down the computer

Index	23
--------------------	-----------

1 Setting power options

Using power-saving states

The computer has two power-saving states enabled at the factory: Sleep and Hibernation.

When Sleep is initiated, the power lights blink and the screen clears. Your work is saved to memory, letting you exit Sleep faster than exiting Hibernation. If the computer is in the Sleep state for an extended period or if the battery reaches a critical battery level while in the Sleep state, the computer initiates Hibernation.

When Hibernation is initiated, your work is saved to a hibernation file on the hard drive and the computer turns off.

△ **CAUTION:** To prevent possible audio and video degradation, loss of audio or video playback functionality, or loss of information, do not initiate Sleep or Hibernation while reading from or writing to a disc or an external media card.

📝 **NOTE:** You cannot initiate any type of networking connection or perform any computer functions while the computer is in the Sleep state or in Hibernation.

Initiating and exiting Sleep

The system is set at the factory to initiate Sleep after 10 minutes of inactivity when running on battery power and 25 minutes of inactivity when running on external power.

Power settings and timeouts can be changed using Power Options in Windows® Control Panel.

With the computer on, you can initiate Sleep in any of the following ways:

- Briefly press the power button.
- Close the display.
- Click **Start**, click the arrow next to the Lock button, and then click **Sleep**.

You can exit Sleep in any of the following ways:

- Briefly press the power button.
- If the display is closed, open the display.
- Press a key on the keyboard or button on the remote control (select models only).
- Activate the TouchPad.

When the computer exits Sleep, the power lights turn on and your work returns to the screen where you stopped working.

 **NOTE:** If you have set a password to be required on wakeup, you must enter your Windows password before your work will return to the screen.

Initiating and exiting Hibernation

The system is set at the factory to initiate Hibernation after 120 minutes (2 hours) of inactivity when running on battery power, 1,080 minutes (18 hours) of inactivity when running on external power, or when the battery reaches a critical battery level.

Power settings and timeouts can be changed using Power Options in Windows Control Panel.

To initiate Hibernation:

▲ Press **fn+f5**.

– or –

Click **Start**, click the arrow next to the Lock button, and then click **Hibernate**.

To exit Hibernation:

▲ Briefly press the power button.

The power lights turn on and your work returns to the screen where you stopped working.

 **NOTE:** If you have set a password to be required on wakeup, you must enter your Windows password before your work will return to the screen.

Using the battery meter

The battery meter is located in the notification area, at the far right of the taskbar. The battery meter allows you to quickly access power settings, view remaining battery charge, and select a different power plan.

- To display the percentage of remaining battery charge and the current power plan, move the pointer over the battery meter icon.
- To access Power Options, or to change the power plan, click the battery meter icon and select an item from the list.

Different battery meter icons indicate whether the computer is running on battery or external power. The icon also displays a message if the battery has reached a critical battery level.

To hide or display the battery meter icon:

1. Right-click the taskbar, and then click **Properties**.
2. Click the **Notification Area** tab.
3. Under **System icons**, clear the **Power** check box to hide the battery meter icon, or select the **Power** check box to display the battery meter icon.
4. Click **OK**.

Using power plans

A power plan is a collection of system settings that manages how the computer uses power. Power plans can help you conserve power or maximize performance.

You can change power plan settings or create your own power plan.

Viewing the current power plan

- ▲ Move the pointer over the battery meter icon in the notification area, at the far right of the taskbar.

– or –

Select **Start > Control Panel > System and Maintenance > Power Options**.

Selecting a different power plan

- ▲ Click the battery meter icon in the notification area, and then select a power plan from the list.

– or –

Select **Start > Control Panel > System and Maintenance > Power Options**, and then select a power plan from the list.

Customizing power plans

1. Click the battery meter icon in the notification area and then click **More power options**.

– or –

Select **Start > Control Panel > System and Maintenance > Power Options**.

2. Select a power plan, and then click **Change plan settings**.
3. Change the **Turn off the display** and **Put the computer to sleep** timeout settings, as needed.
4. To change additional settings, click **Change advanced power settings** and make your changes.

Setting password protection on wakeup

To set the computer to prompt for a password when the computer exits Sleep or Hibernation, follow these steps:

1. Select **Start > Control Panel > System and Maintenance > Power Options**.
2. In the left pane, click **Require a password on wakeup**.
3. Click **Change Settings that are currently unavailable**.

 **NOTE:** If prompted by User Account Control, click **Continue**.

4. Click **Require a password (recommended)**.
5. Click **Save changes**.

2 Using external AC power

External AC power is supplied through one of the following devices:

⚠ **WARNING!** To reduce potential safety issues, use only the AC adapter provided with the computer, a replacement AC adapter provided by HP, or a compatible AC adapter purchased from HP.

- Approved AC adapter
- Optional docking device or expansion product

Connect the computer to external AC power under any of the following conditions:

⚠ **WARNING!** Do not charge the computer battery while you are onboard aircraft.

- When you are charging or calibrating a battery
- When you are installing or modifying system software
- When you are writing information to a CD or DVD

When you connect the computer to external AC power, the following events occur:

- The battery begins to charge.
- If the computer is turned on, the battery meter icon in the notification area changes appearance.

When you disconnect external AC power, the following events occur:

- The computer switches to battery power.
- The display brightness is automatically decreased to save battery life. To increase display brightness, press the **fn+f8** hotkey or reconnect the AC adapter.

Connecting the AC adapter

⚠ **WARNING!** To reduce the risk of electric shock or damage to the equipment:

Plug the power cord into an AC outlet that is easily accessible at all times.

Disconnect power from the computer by unplugging the power cord from the AC outlet (not by unplugging the power cord from the computer).

If provided with a 3-pin attachment plug on the power cord, plug the cord into a grounded (earthed) 3-pin outlet. Do not disable the power cord grounding pin, for example, by attaching a 2-pin adapter. The grounding pin is an important safety feature.

To connect the computer to external AC power:

1. Plug the AC adapter into the power connector **(1)** on the computer.
2. Plug the power cord into the AC adapter **(2)**.
3. Plug the other end of the power cord into an AC outlet **(3)**.

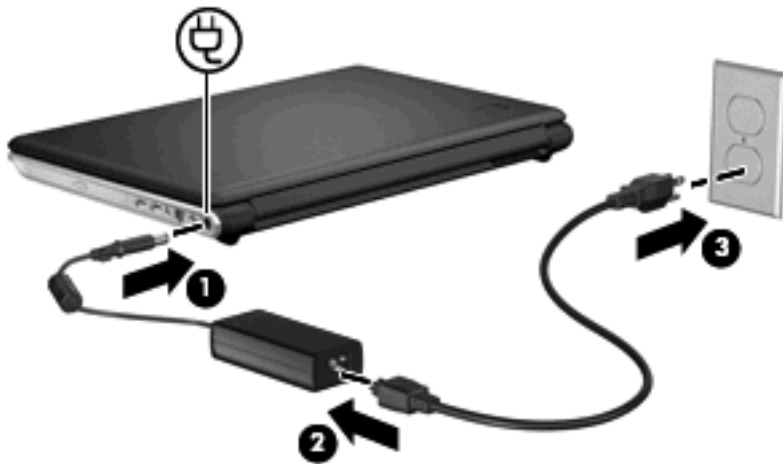

3 Using battery power

When a charged battery is in the computer and the computer is not plugged into external power, the computer runs on battery power. When the computer is plugged into external AC power, the computer runs on AC power.

If the computer contains a charged battery and is running on external AC power supplied through the AC adapter, the computer switches to battery power if the AC adapter is disconnected from the computer.

 **NOTE:** The display brightness is decreased to save battery life when you disconnect AC power. To increase display brightness, use the **fn+f8** hotkey or reconnect the AC adapter.

You can keep a battery in the computer or in storage, depending on how you work. Keeping the battery in the computer whenever the computer is plugged into AC power charges the battery and also protects your work in case of a power outage. However, a battery in the computer slowly discharges when the computer is off and unplugged from external power.

 **WARNING!** To reduce potential safety issues, use only the battery provided with the computer, a replacement battery provided by HP, or a compatible battery purchased from HP.

Computer battery life varies, depending on power management settings, programs running on the computer, display brightness, external devices connected to the computer, and other factors.

Finding battery information in Help and Support

The Battery information section of the Help and Support Learning Center provides the following tools and information:

- Battery Check tool to test battery performance
- Information on calibration, power management, and proper care and storage to maximize battery life
- Information on battery types, specifications, life cycles, and capacity

To access Battery information:

- ▲ Select **Start > Help and Support > Learning Center > HP Power and Battery Learning Center**.

Using Battery Check

Battery Check, a part of the Total Care Advisor, provides information on the status of the battery installed in the computer.

To run Battery Check:

1. Connect the AC adapter to the computer.



NOTE: The computer must be connected to external power for Battery Check to function properly.

2. Select **Start > Help and Support > Troubleshooting tools > Battery Check**.

Battery Check examines the battery and its cells to see if they are functioning properly, and then reports the results of the examination.

Displaying the remaining battery charge

- ▲ Move the pointer over the battery meter icon in the notification area, at the far right of the taskbar.

– or –

View the estimated number of minutes of battery charge remaining in Windows Mobility Center:

- ▲ Click the battery meter icon, and then click **Windows Mobility Center**.

– or –

Select **Start > Control Panel > Mobile PC > Windows Mobility Center**.

The time shown indicates the approximate running time remaining on the battery *if the battery continues to provide power at the current level*. For example, the time remaining will decrease when a DVD is playing and will increase when a DVD stops playing.

Inserting or removing the battery

△ **CAUTION:** Removing a battery that is the sole power source can cause loss of information. To prevent loss of information, initiate Hibernation or shut down the computer through Windows before removing the battery.

To insert the battery:

1. Turn the computer upside down on a flat surface.
2. Insert the battery into the battery bay (1) and rotate it downward until it is seated (2).

The battery release latch (3) automatically locks the battery into place.

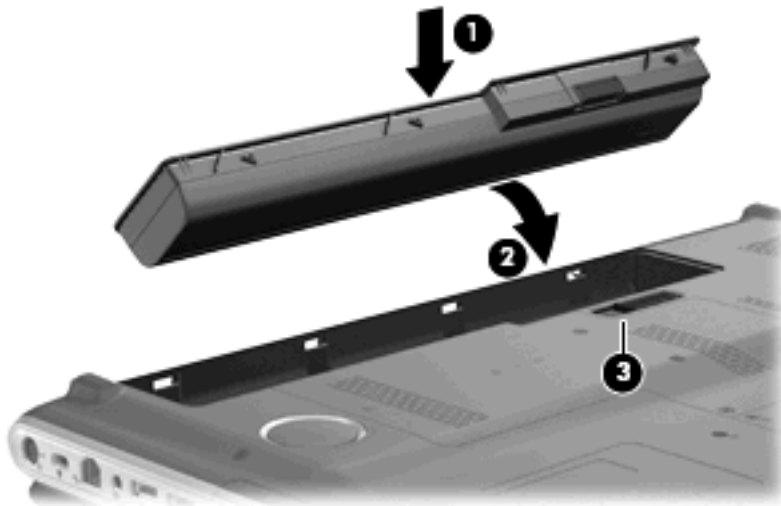

To remove the battery:

1. Turn the computer upside down on a flat surface.
2. Slide the battery release latch (1) to release the battery.
3. Pivot the battery (2) upward and remove the battery from the computer (3).

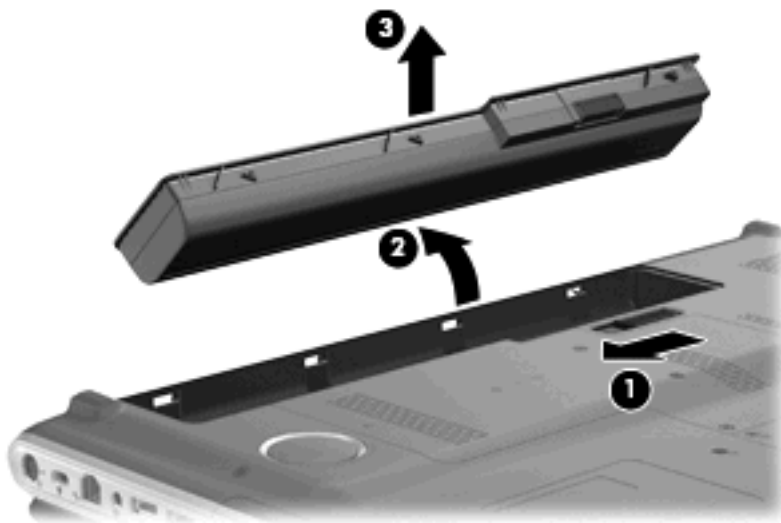

Charging a battery

 **WARNING!** Do not charge the computer battery while you are onboard aircraft.

The battery charges whenever the computer is plugged into external power through an AC adapter, an optional power adapter, an optional expansion product, or an optional docking device.

The battery charges whether the computer is off or in use, but it charges faster when the computer is off.

Charging may take longer if a battery is new, has been unused for 2 weeks or more, or is much warmer or cooler than room temperature.

To prolong battery life and optimize the accuracy of battery charge displays, follow these recommendations:

- If you are charging a new battery, charge it fully before turning on the computer.
- Charge the battery until the battery light turns off.

 **NOTE:** If the computer is on while the battery is charging, the battery meter in the notification area may show 100 percent charge before the battery is fully charged.

- Allow the battery to discharge below 5 percent of a full charge through normal use before charging it.
- If the battery has been unused for one month or more, calibrate the battery instead of simply charging it.

The battery light displays charge status:

- On: The battery is charging.
- Blinking: The battery has reached a low battery level or critical battery level and is not charging.
- Off: The battery is fully charged, in use, or not installed.

Maximizing battery discharge time

Battery discharge time varies depending on the features you use while on battery power. Maximum discharge time gradually shortens, as the battery storage capacity naturally degrades.

Tips for maximizing battery discharge time:

- Lower the brightness on the display.
- Check the **Power saver** setting in Power Options.
- Remove the battery from the computer when it is not being used or charged.
- Store the battery in a cool, dry location.

Managing low battery levels

The information in this section describes the alerts and system responses set at the factory. Some low-battery alerts and system responses can be changed using Power Options in Windows Control Panel. Preferences set using Power Options do not affect lights.

Identifying low battery levels

When a battery that is the sole power source for the computer reaches a low battery level, the battery light blinks.

If a low battery level is not resolved, the computer enters a critical battery level, and the battery light begins blinking rapidly.

The computer takes the following actions for a critical battery level:

- If Hibernation is enabled and the computer is on or in the Sleep state, the computer initiates Hibernation.
- If Hibernation is disabled and the computer is on or in the Sleep state, the computer remains briefly in the Sleep state, and then shuts down and loses any unsaved information.

Resolving a low battery level

CAUTION: To reduce the risk of losing information when the computer reaches a critical battery level and has initiated Hibernation, do not restore power until the power lights turn off.

Resolving a low battery level when external power is available

- ▲ Connect one of the following devices:
 - AC adapter
 - Optional expansion product or docking device
 - Optional power adapter

Resolving a low battery level when a charged battery is available

1. Turn off the computer or initiate Hibernation.
2. Remove the discharged battery, and then insert a charged battery.
3. Turn on the computer.

Resolving a low battery level when no power source is available

- ▲ Initiate Hibernation.
– or –
Save your work and shut down the computer.

Resolving a low battery level when the computer cannot exit Hibernation

When the computer lacks sufficient power to exit Hibernation, follow these steps:

1. Insert a charged battery or plug the computer into external power.
2. Exit Hibernation by pressing the power button.

Calibrating a battery

Calibrate a battery under the following conditions:

- When battery charge displays seem inaccurate
- When you observe a significant change in battery run time

Even if a battery is heavily used, it should not need to be calibrated more than once a month. It is also not necessary to calibrate a new battery.

Step 1: Fully charge the battery

 **WARNING!** Do not charge the computer battery while you are onboard aircraft.

 **NOTE:** The battery charges whether the computer is off or in use, but it charges faster when the computer is off.

To fully charge the battery:

1. Insert the battery into the computer.
2. Connect the computer to an AC adapter, optional power adapter, optional expansion product, or optional docking device, and then plug the adapter or device into external power.

The battery light on the computer turns on.

3. Leave the computer plugged into external power until the battery is fully charged.

The battery light on the computer turns off.

Step 2: Disable Hibernation and Sleep

1. Click the battery meter icon in the notification area, and then click **More power options**.

– or –

Select **Start > Control Panel > System and Maintenance > Power Options**.

2. Under the current power plan, click **Change plan settings**.
3. Record the **Turn off the display** and **Put the computer to sleep** settings listed in the **On battery** column so that you can reset them after the calibration.
4. Change the **Turn off the display** and **Put the computer to sleep** settings to **Never**.
5. Click **Change advanced power settings**.
6. Click the plus sign next to **Sleep**, and then click the plus sign next to **Hibernate after**.
7. Record the **On battery** setting under **Hibernate after** so that you can reset it after the calibration.
8. Change the **On battery** setting to **Never**.
9. Click **OK**.
10. Click **Save changes**.

Step 3: Discharge the battery

The computer must remain on while the battery is being discharged. The battery can discharge whether or not you are using the computer, but the battery will discharge faster while you are using it.

- If you plan to leave the computer unattended during the discharge, save your information before beginning the discharge procedure.
- If you use the computer occasionally during the discharge procedure and have set energy-saving timeouts, expect the following performance from the system during the discharge process:
 - The monitor will not turn off automatically.
 - Hard drive speed will not decrease automatically when the computer is idle.
 - System-initiated Hibernation will not occur.

To discharge a battery:

1. Unplug the computer from its external power source, but do *not* turn off the computer.
2. Run the computer on battery power until the battery is discharged. The battery light begins to blink when the battery has discharged to a low battery level. When the battery is discharged, the battery light turns off and the computer shuts down.

Step 4: Fully recharge the battery

To recharge the battery:

1. Plug the computer into external power and maintain external power until the battery is fully recharged. When the battery is recharged, the battery light on the computer turns off.

You can use the computer while the battery is recharging, but the battery will charge faster if the computer is off.

2. If the computer is off, turn it on when the battery is fully charged and the battery light has turned off.

Step 5: Reenable Hibernation and Sleep

△ **CAUTION:** Failure to reenable Hibernation after calibration may result in a full battery discharge and information loss if the computer reaches a critical battery level.

1. Click the battery meter icon in the notification area, and then click **More power options**.
– or –
Select **Start > Control Panel > System and Maintenance > Power Options**.
2. Under the current power plan, click **Change plan settings**.
3. Reenter the settings that you recorded for the items in the **On battery** column.
4. Click **Change advanced power settings**.
5. Click the plus sign next to **Sleep**, and then click the plus sign next to **Hibernate after**.
6. Reenter the setting that you recorded for **On battery**.

7. Click **OK**.
8. Click **Save changes**.

Conserving battery power

- Select low power-use settings through Power Options in Windows Control Panel.
- Turn off wireless and local area network (LAN) connections and exit modem applications when you are not using them.
- Disconnect external devices that are not plugged into an external power source, when you are not using them.
- Stop, disable, or remove any external media cards that you are not using.
- Use the **fn+f7** and **fn+f8** hotkeys to adjust screen brightness as needed.
- If you leave your work, initiate Sleep or Hibernation, or shut down the computer.

Storing a battery

△ **CAUTION:** To prevent damage to a battery, do not expose it to high temperatures for extended periods of time.

If a computer will be unused and unplugged from external power for more than 2 weeks, remove the battery and store it separately.

To prolong the charge of a stored battery, place it in a cool, dry place.

Calibrate a battery before using it if it has been stored for one month or more.

Disposing of a used battery

 **WARNING!** To reduce the risk of fire or burns, do not disassemble, crush, or puncture; do not short external contacts; do not dispose of in fire or water.

Refer to the *Regulatory, Safety and Environmental Notices* for battery disposal information.

Replacing the battery

Computer battery life varies, depending on power management settings, programs running on the computer, display brightness, external devices connected to the computer, and other factors.

Battery Check notifies you to replace the battery when an internal cell is not charging properly, or when the battery storage capacity has reached a “weak” condition. A message refers you to the HP Web site for more information about ordering a replacement battery. If the battery is possibly covered by an HP warranty, instructions include a warranty ID.

 **NOTE:** To ensure that you always have battery power when you need it, HP recommends purchasing a new battery when the storage capacity indicator turns green-yellow.

4 Shutting down the computer

△ **CAUTION:** Unsaved information will be lost when the computer is shut down.

The Shut Down command closes all open programs, including the operating system, and then turns off the display and computer.

Shut down the computer under any of the following conditions:

- When you need to replace the battery or access components inside the computer
- When you are connecting an external hardware device that does not connect to a USB port
- When the computer will be unused and disconnected from external power for an extended period

To shut down the computer:

 **NOTE:** If the computer is in the Sleep state or in Hibernation, you must first exit Sleep or Hibernation before shutdown is possible.

1. Save your work and close all open programs.
2. Click **Start**, and then click the arrow next to the Lock button.
3. Click **Shut Down**.

If the computer is unresponsive and you are unable to use the preceding shutdown procedures, try the following emergency procedures in the sequence provided:

- Press **ctrl+alt+delete**, and then click the **Power** button.
- Press and hold the power button for at least 5 seconds.
- Disconnect the computer from external power and remove the battery.

Index

A

AC adapter, connecting 7

B

battery

- calibrating 17
- charging 13, 17
- conserving power 20
- discharging 14
- disposing 21
- inserting 12
- low battery levels 15
- recharging 18
- removing 12
- replacing 21
- storing 20

Battery Check 10

battery light 13, 15

battery power 8

battery release latch 12

battery temperature 20

C

calibrating battery 17

charging batteries 13, 17

connection, external power 7

conservation, power 20

critical battery level 15

D

drive media 1

H

Hibernation

- exiting 2
- initiated during critical battery level 15
- initiating 2

L

low battery level 15

O

operating system 22

P

power

- connecting 7
- conserving 20

R

readable media 1

S

shutdown 22

shutting down 22

Sleep

- exiting 1
- initiating 1

storing battery 20

T

temperature 20

traveling with the computer 20

turning off the computer 22

U

unresponsive system 22

W

writable media 1

