



OFFICEJET 6000

User Guide



E609

WHAT DO YOU HAVE TO SAY?

HP Officejet 6000 (E609) Printer Series

User Guide



Copyright information

© 2009 Copyright Hewlett-Packard
Development Company, L.P.
Edition 1, 6/2009

Hewlett-Packard Company notices

The information contained in this document is subject to change without notice.

All rights reserved. Reproduction, adaptation, or translation of this material is prohibited without prior written permission of Hewlett-Packard, except as allowed under copyright laws.

The only warranties for HP products and services are set forth in the express warranty statements accompanying such products and services. Nothing herein should be construed as constituting an additional warranty. HP shall not be liable for technical or editorial errors or omissions contained herein.

Acknowledgements

Windows and Windows XP are U.S. registered trademarks of Microsoft Corporation. Windows Vista is either a registered trademark or trademark of Microsoft Corporation in the United States and/or other countries.

ENERGY STAR is a registered mark owned by the U.S. government.

Safety information



Always follow basic safety precautions when using this product to reduce risk of injury from fire or electric shock.

1. Read and understand all instructions in the documentation that comes with the device.
2. Observe all warnings and instructions marked on the product.
3. Unplug this product from wall outlets before cleaning.
4. Do not install or use this product near water, or when you are wet.
5. Install the product securely on a stable surface.
6. Install the product in a protected location where no one can step on or trip over the line cord, and the line cord cannot be damaged.
7. If the product does not operate normally, see [Maintain and troubleshoot](#).
8. There are no user-serviceable parts inside. Refer servicing to qualified service personnel.
9. Use only the external power adaptor/battery provided with the device.

Contents

1 Get started	
Find other resources for the product	8
Find the device model number.....	9
Accessibility.....	10
Understand the device parts.....	10
Front view.....	10
Control panel.....	11
Back view.....	12
Connection information.....	12
Turn off the device.....	13
Eco-Tips.....	13
2 Install the accessories	
Install the duplexer (available on some models).....	14
Turn on accessories.....	14
Activate and deactivate the duplexer on the device.....	14
To turn accessories on or off on Windows computers.....	15
To turn on accessories on Macintosh computers.....	15
3 Use the device	
Select print media.....	16
Recommended papers for printing.....	16
Recommended papers for photo printing.....	18
Tips for selecting and using print media.....	18
Understand specifications for supported media.....	19
Understand supported sizes.....	20
Understand supported media types and weights.....	22
Set minimum margins.....	23
Load media.....	24
Change print settings.....	25
To change settings from an application for current jobs (Windows).....	25
To change default settings for all future jobs (Windows).....	26
To change settings (Mac OS X).....	26
Print on both sides (duplexing).....	26
Guidelines for printing on both sides of a page.....	26
Perform duplexing.....	27
Print on special and custom-sized media.....	27
Print borderless.....	28
To print a borderless document (Windows).....	29
To print a borderless document (Mac OS X).....	29
Print a Web page (Windows only).....	30
Cancel a print job.....	30

4	Configure and manage	
	Manage the device.....	31
	Monitor the device.....	32
	Administer the device.....	32
	Use device management tools.....	33
	Embedded Web server.....	34
	To open the embedded Web server.....	34
	Embedded Web server pages.....	35
	Toolbox (Windows).....	35
	Open the Toolbox.....	36
	Toolbox tabs.....	36
	Network Toolbox.....	37
	Use the HP Solution Center (Windows).....	37
	HP Printer Utility (Mac OS X).....	37
	Open the HP Printer Utility.....	38
	HP Printer Utility panels.....	38
	Use the HP Device Manager (Mac OS X).....	39
	Understand the printer status page.....	39
	Understand the network configuration or wireless status report.....	41
	Configure the device (Windows).....	42
	Direct connection.....	42
	To install the software before connecting the device (recommended).....	42
	To connect the device before installing the software.....	43
	To share the device on a locally shared network.....	43
	Network connection.....	44
	Install the device on a network.....	44
	Install the device software on client computers.....	44
	Install the printer driver using Add Printer.....	45
	Configure the device (Mac OS X).....	45
	To install the software for network or direct connection.....	45
	To share the device on a locally shared network.....	46
	Set up the device for wireless communication.....	46
	Understand 802.11 wireless network settings.....	47
	To set up wireless communication using the installer (Windows).....	48
	To set up the device on a wireless communication using the installer (Mac OS X).....	49
	Connect the device using an ad hoc wireless network connection.....	49
	To turn off wireless communication.....	49
	Configure your firewall to work with HP devices.....	49
	Change the connection method.....	50
	Guidelines for ensuring wireless network security.....	51
	To add hardware addresses to a wireless access point.....	51
	Other guidelines.....	51
	Uninstall and reinstall the software.....	52
5	Maintain and troubleshoot	
	Work with ink cartridges.....	55
	Information on ink cartridges and the printhead.....	55
	Check the estimated ink levels.....	56
	Replace the ink cartridges.....	57
	Usage information collection.....	59

Contents

Print and evaluate a print quality report.....	60
To print a print quality report.....	60
To evaluate the Print Quality Diagnostic Page.....	61
Ink Levels.....	61
Good color bars.....	61
Ragged, irregularly streaked, or faded bars.....	62
Regular white streaks in the bars.....	63
Bar colors are not uniform.....	63
Large Black Font Text.....	64
Alignment Patterns.....	65
If you see no defects.....	65
Troubleshooting tips and resources.....	65
Solve printing problems.....	66
The device shuts down unexpectedly.....	66
Device takes a long time to print.....	66
Blank or partial page printed.....	67
Something on the page is missing or incorrect.....	67
Placement of the text or graphics is wrong.....	68
Print troubleshooting.....	69
Envelopes print incorrectly.....	69
The product is not responding.....	70
The product prints meaningless characters.....	73
Nothing happens when I try to print.....	73
The margins are not printing as expected.....	76
Text or graphics are cut off at the edge of the page.....	77
A blank page came out while printing.....	79
Print quality troubleshooting.....	80
Wrong, inaccurate, or bleeding colors.....	80
Ink is not filling the text or graphics completely.....	83
The printout has a horizontal band of distortion near the bottom of a borderless print.....	85
Printouts have horizontal streaks or lines.....	86
Printouts are faded or have dull colors.....	88
Printouts seem blurry or fuzzy.....	90
Printouts are slanted or skewed.....	91
Ink streaks on the back of the paper.....	92
Paper is not picked up from the input tray.....	93
Poor black text.....	94
The product prints slowly.....	96
Advanced printhead maintenance.....	96
Clean the printhead.....	97
Align the printhead.....	98
Solve paper-feed problems.....	99
Solve device management problems.....	100
Embedded Web server cannot be opened.....	100
Solve network problems.....	101

- Solve wireless problems.....102
 - Basic wireless troubleshooting.....102
 - Advanced wireless troubleshooting.....103
 - Make sure your computer is connected to your network.....103
 - Make sure that the HP device is connected to your network.....105
 - Check to see if the firewall software is blocking communication.....105
 - Make sure the HP device is online and ready.....106
 - Your wireless router is using a hidden SSID.....106
 - Make sure the wireless version of the HP device is set as the default printer driver (Windows only).....106
 - Make sure the HP Network Devices Support service is running (Windows only).....107
 - Add hardware addresses to a wireless access point (WAP).....107
- Troubleshoot installation issues.....108
 - Hardware installation suggestions.....108
 - Software installation suggestions.....109
 - Solve network problems.....110

Contents

Clear jams.....	111
Clear a jam in the device.....	111
Tips for avoiding jams.....	112
Errors (Windows).....	112
Printhead Problem - The printhead appears to be missing or damaged.....	113
Incompatible Printhead.....	113
Printhead problem and advanced printhead maintenance.....	113
Printhead problem - The following printhead has a problem.....	113
Advanced printhead maintenance.....	113
Device Disconnected.....	118
Ink Alert.....	118
HP recommends you have a replacement available for when print quality becomes no longer acceptable.....	119
The amount of ink in the following cartridge may be low enough to cause poor print quality and cartridge changes may be required soon. HP recommends you have replacement cartridges available to install when print quality is no longer acceptable.....	119
Ink system failure.....	119
Cartridge Problem.....	120
The following cartridge appears to be missing or damaged.....	120
Cartridge(s) in Wrong Slot - The following cartridges are in the wrong slots.....	120
Cartridge Problem.....	120
Paper Mismatch.....	120
The cartridge cradle cannot move.....	120
Paper Jam.....	121
The printer is out of paper.....	121
Incompatible Cartridge(s).....	121
The following cartridge is not intended for use in this printer.....	121
The following cartridges are not intended for use in this printer as it is currently configured.....	121
Printer Offline.....	121
Printer Paused.....	122
Document failed to print.....	122
Previously used genuine HP cartridge.....	122
Ink Service Capacity Warning.....	122
General printer error.....	122
6 Control-panel lights reference	
Interpreting control-panel lights.....	124
A HP supplies and accessories	
Order printing supplies online.....	131
Accessories.....	131
Supplies.....	131
Ink cartridges.....	132
HP media.....	132
B Support and warranty	
Obtain electronic support.....	133

Obtain HP telephone support.....	134
Before you call.....	134
Support process.....	134
HP support by phone.....	135
Phone support period.....	135
Telephone support numbers.....	136
Placing a call.....	137
After the phone support period.....	137
Additional warranty options.....	137
HP Quick Exchange Service (Japan).....	137
HP Korea customer support.....	138
Hewlett-Packard limited warranty statement.....	139
Ink cartridge warranty information.....	140
Prepare the device for shipment.....	140
Remove the rear access panel or duplexer.....	140
Remove the output tray.....	140
Pack the device.....	141
C Device specifications	
Physical specifications.....	142
Product features and capacities.....	142
Processor and memory specifications.....	142
System requirements.....	143
Network protocol specifications.....	144
Embedded Web server specifications.....	144
Print resolution.....	144
Environmental specifications.....	145
Electrical specifications.....	145
Acoustic emission specifications (print in Draft mode, noise levels per ISO 7779).....	145
D Regulatory information	
FCC statement.....	146
Notice to users in Korea.....	147
VCCI (Class B) compliance statement for users in Japan.....	147
Notice to users in Japan about the power cord.....	147
Toxic and hazardous substance table.....	147
LED indicator statement.....	148
Regulatory information for wireless products.....	148
Exposure to radio frequency radiation.....	148
Notice to users in Brazil.....	148
Notice to users in Canada.....	148
Notice to users in Taiwan.....	149
European Union regulatory notice.....	149
Regulatory model number.....	150
Declaration of conformity.....	150

Contents

Environmental product stewardship program.....	152
Paper use.....	152
Plastics.....	152
Material safety data sheets.....	152
Recycling program.....	152
HP inkjet supplies recycling program.....	152
Disposal of waste equipment by users in private households in the European Union.....	153
Power consumption.....	153
Third-party license agreements.....	154
Expat.....	154
OpenSSL.....	154
SHA2.....	156
Index.....	158

1 Get started

This guide provides details about how to use the device and to resolve problems.

- [Find other resources for the product](#)
- [Find the device model number](#)
- [Accessibility](#)
- [Understand the device parts](#)
- [Connection information](#)
- [Turn off the device](#)
- [Eco-Tips](#)

Find other resources for the product

You can obtain product information and further troubleshooting resources that are not included in this guide from the following resources:

Resource	Description	Location
Readme file and release notes	Provide late-breaking information and troubleshooting tips.	Included on the Starter CD.
Wireless Getting Started Guide (some models only)	Provides instructions for setting up the device's wireless function.	A printed version of the document is provided with the device.
Device management tools (network connection)	Allows you to view status information, change settings, and manage the device. For more information, see Embedded Web server .	Available from a connected computer.
Toolbox (Microsoft® Windows®)	Provides information about printhead health and access to maintenance services. For more information, see Toolbox (Windows) .	Typically installed with the device software.
HP Printer Utility (Mac OS X)	Contains tools to configure print settings, calibrate the device, clean the printhead, print the configuration page, and find support information from the Web site. For more information, see HP Printer Utility (Mac OS X) .	Typically installed with the device software.
Control panel	Provides status, error, and warning information about operations.	For more information, see Control panel .

(continued)

Resource	Description	Location
Logs and reports	Provides information about events that have occurred.	For more information, see Monitor the device .
Printer status report	<ul style="list-style-type: none">• Device information:<ul style="list-style-type: none">◦ Product name◦ Model number◦ Serial number◦ Firmware version number• Accessories installed (for example, duplexer)• Number of pages printed from the tray and accessories• Printing supply status	For more information, see Understand the printer status page .
Print quality diagnostic page	Diagnoses issues affecting print quality and helps you decide whether to run any maintenance services to improve the print quality of your printouts.	For more information, see Print and evaluate a print quality report .
HP Web sites	Provide the latest printer software, and product and support information.	www.hp.com/support www.hp.com
HP telephone support	Lists information to contact HP.	For more information, see Obtain HP telephone support .
HP Solution Center (Windows)	Allows you to change device settings, order supplies, start, and access the onscreen Help. Depending on the devices you have installed, the HP Solution Center provides additional features, such as access to the HP photo and imaging software. For more information, see Use the HP Solution Center (Windows) .	Typically installed with the device software.

Find the device model number

In addition to the model name that appears on the front of the device, this device has a specific model number. You can use this number to help determine which supplies or accessories are available for your product, as well as when obtaining support.

The model number is printed on a label located inside the device, near the ink cartridges area.

Accessibility

The device provides a number of features that make it accessible for people with disabilities.

Visual

The device software is accessible for users with visual impairments or low vision through the use of your operating system's accessibility options and features. It also supports most assistive technology such as screen readers, Braille readers, and voice-to-text applications. For users who are color blind, colored buttons and tabs used in the software and on the control panel have simple text or icon labels that convey the appropriate action.

Mobility

For users with mobility impairments, the device software functions can be executed through keyboard commands. The software also supports Windows accessibility options such as StickyKeys, ToggleKeys, FilterKeys, and MouseKeys. The device doors, buttons, paper trays, and paper guides can be operated by users with limited strength and reach.

Support

For more details about the accessibility of this product and HP's commitment to product accessibility, visit HP's Web site at www.hp.com/accessibility.

For accessibility information for Mac OS X, visit the Apple Web site at www.apple.com/accessibility.

Understand the device parts

- [Front view](#)
- [Control panel](#)
- [Back view](#)

Front view

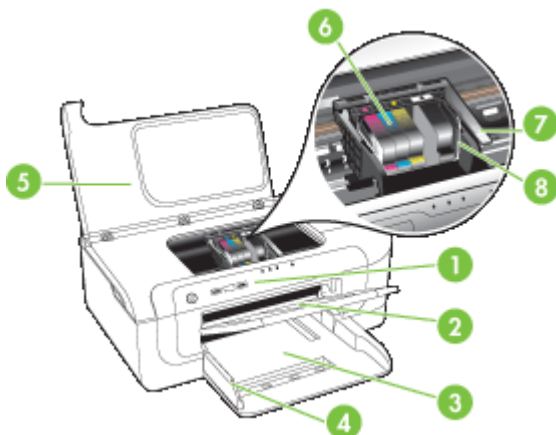



1	Control panel
2	Output tray
3	Tray 1
4	Width guides
5	Top cover
6	Ink cartridges
7	Printhead latch
8	Printhead

Control panel

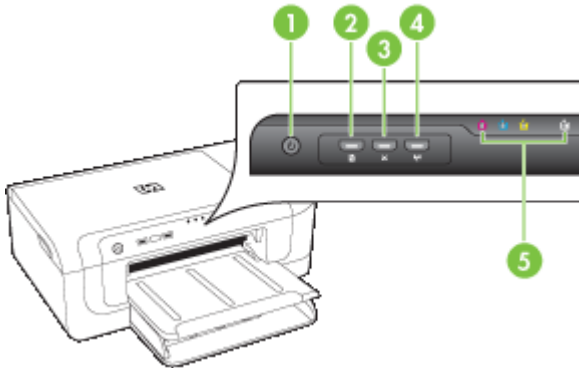
For more information about interpreting control-panel lights, see [Control-panel lights reference](#).



1	Power button and light
2	Resume button and light
3	Cancel button
4	Network button  (available with some models) Wireless button  (available with some models)
5	Ink cartridge lights

Back view

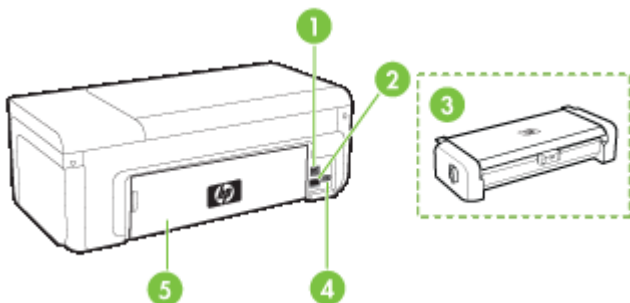

1	Rear universal serial bus (USB) port
2	Ethernet network port
3	Automatic two-sided printing accessory (duplexer) (some models only)
4	Power input
5	Rear access panel

Connection information

Description	Recommended number of connected computers for best performance	Supported software features	Setup instructions
USB connection	One computer connected with a USB cable to the rear USB 2.0 high-speed port on the device.	All features are supported.	See Configure the device (Windows) or Configure the device (Mac OS X) .
Ethernet (wired) connection	Up to five computers connected to the device using a hub or router.	All features are supported.	Follow the instructions in To share the device on a locally shared network in this guide for further instructions.
Printer sharing	Up to five computers. The host computer must be turned on at all times, or the other computers cannot print to the device.	All features resident on the host computer are supported. Only print is supported from the other computers.	Follow the instructions in To share the device on a locally shared network .
802.11 wireless (some models only)	Up to five computers connected to the device using a hub or router.	All features are supported.	Follow the instructions in the wireless getting started guide or see Set up the device for wireless communication .

Turn off the device

Turn off the HP product by pressing the **Power** button located on the product. Wait until the **Power** light turns off before unplugging the power cord or turning off a power source. If you improperly turn off the HP product, the print carriage might not return to the correct position, which might cause problems with the printhead and print quality issues.

Eco-Tips

HP is committed to helping customers reduce their environmental footprint. HP has provided the Eco-Tips below to help you focus on ways to assess and reduce the impact of your printing choices. In addition to specific features in this product, please visit the HP Eco Solutions Web site for more information on HP's environmental initiatives.

www.hp.com/hpinfo/globalcitizenship/environment/

- **Duplex printing:** Use **Paper-saving Printing** to print two-sided documents with multiple pages on the same sheet to reduce paper usage. For more information, see [Print on both sides \(duplexing\)](#).
- **Smart Web printing:** The HP Smart Web Printing interface includes a **Clip Book** and **Edit Clips** window where you can store, organize, or print clips you have gathered from the Web. For more information, see [Print a Web page \(Windows only\)](#).
- **Energy savings information:** To determine the ENERGY STAR® qualification status for this product, see [Power consumption](#).
- **Recycled materials:** For more information regarding recycling of HP products, please visit:
www.hp.com/hpinfo/globalcitizenship/environment/recycle/

2 Install the accessories

This section contains the following topics:

- [Install the duplexer \(available on some models\)](#)
- [Turn on accessories](#)

Install the duplexer (available on some models)

You can print on both sides of a sheet of paper automatically when the optional automatic two-sided printing accessory (duplexer) is installed. For information on using the duplexer, see [Print on both sides \(duplexing\)](#).

Install the duplexer

1. Push the buttons on the rear access panel and remove the panel from the device.
2. Slide the duplexer into the device until the unit locks into place. Do not press the buttons on either side of the duplexer when installing the unit; use them only for removing the unit from the device.

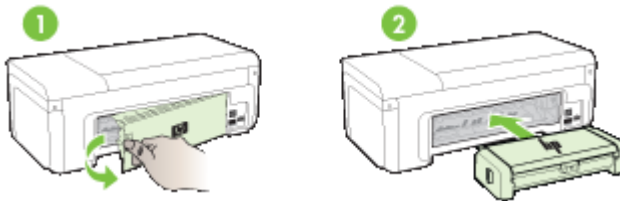

Turn on accessories

This section contains the following topics:

- [Activate and deactivate the duplexer on the device](#)
- [To turn accessories on or off on Windows computers](#)
- [To turn on accessories on Macintosh computers](#)

Activate and deactivate the duplexer on the device

When you install or remove the duplexer, you need to activate or deactivate the accessory on the device control panel.

To activate or deactivate the duplexer

- ▲ Press and hold **Cancel** button and **Network** button for five seconds. After you release the buttons, the device will print a report letting you know that the duplexer has been activated.

To turn accessories on or off on Windows computers

1. Click on the **Start** button on the desktop.
2. Select **Printers and Faxes**, right-click on your device, and then select **Properties**.
3. Click the **Device Settings** tab, and then click **Installed** or **Not Installed** to turn the duplexer on or off.

To turn on accessories on Macintosh computers

1. From the desktop, click **System Preferences** under the Apple menu.
2. Click **Print & Fax**.
3. Select the device, and then click **Printer Setup** (Mac OS X 10.4) or **Options & Supplies...** (Mac OS X 10.5).
4. Do one of the following:
 - a. **Mac OS X (10.4)**: Select **Installable Options** from the drop-down menu.
 - b. **Mac OS X (10.5)** Select the **Driver** tab.
5. Select the check box next to **HP Two-sided Printing Accessory (Duplexer)** to turn on the duplexer. Clear the check box to turn off the duplexer.

3 Use the device

This section contains the following topics:

- [Select print media](#)
- [Load media](#)
- [Change print settings](#)
- [Print on both sides \(duplexing\)](#)
- [Print on special and custom-sized media](#)
- [Print borderless](#)
- [Print a Web page \(Windows only\)](#)
- [Cancel a print job](#)

Select print media

The device is designed to work well with most types of office media. It is best to test a variety of print media types before buying large quantities. Use HP media for optimum print quality. Visit the HP Web site at www.hp.com for more information about HP media.



HP recommends plain papers with the ColorLok logo for printing everyday documents. All papers with the ColorLok logo are independently tested to meet high standards of reliability and print quality, and produce documents with crisp, vivid color, bolder blacks & dry faster than ordinary plain papers. Look for papers with the ColorLok logo in a variety of weights and sizes from major paper manufacturers.

This section contains the following topics:

- [Recommended papers for printing](#)
- [Recommended papers for photo printing](#)
- [Tips for selecting and using print media](#)
- [Understand specifications for supported media](#)
- [Set minimum margins](#)

Recommended papers for printing

If you want the best print quality, HP recommends using HP papers that are specifically designed for the type of project you are printing.

Depending on your country/region, some of these papers might not be available.

HP Brochure Paper HP Superior Inkjet Paper	These papers are glossy-coated or matte-coated on both sides for two-sided use. They are the perfect choice for near-photographic reproductions and business graphics for report covers, special presentations, brochures, mailers, and calendars.
HP Bright White Inkjet Paper	HP Bright White Inkjet Paper delivers high-contrast colors and sharp text. It is opaque enough for two-sided color usage with no show-through, which makes it ideal for newsletters, reports, and flyers. It

(continued)

	features ColorLok Technology for less smearing, bolder blacks and vivid colors.
HP Printing Paper	HP Printing Paper is a high-quality multifunction paper. It produces documents that look and feel more substantial than documents printed on standard multipurpose or copy paper. It features ColorLok Technology for less smearing, bolder blacks and vivid colors. It is acid-free for longer lasting documents.
HP Office Paper	HP Office Paper is a high-quality multifunction paper. It is suitable for copies, drafts, memos and other everyday documents. It features ColorLok Technology for less smearing, bolder blacks and vivid colors. It is acid-free for longer lasting documents
HP Office Recycled Paper	HP Office Recycled Paper is a high-quality multifunction paper made with 30% recycled fiber. It features ColorLok Technology for less smearing, bolder blacks and vivid colors. It is acid-free for longer lasting documents.
HP Premium Presentation Paper HP Professional Paper	These papers are heavy two-sided matte papers perfect for presentation, proposals, reports and newsletters. They are heavyweight for an impressive look and feel.
HP Premium Inkjet Transparency Film	HP Premium Inkjet Transparency Film makes your color presentations vivid and even more impressive. This film is easy to use and handle and dries quickly without smudging.
HP Advanced Photo Paper	This thick photo paper features an instant-dry finish for easy handling without smudging. It resists water, smears, fingerprints, and humidity. Your prints have a look and feel comparable to a store processed photo. It is available in several sizes, including A4, 8.5 x 11 inch, 10 x 15 cm (4 x 6 inch), 13 x 18 cm (5 x 7 inch) and two finishes – glossy or soft gloss (satin matte). It is acid-free for longer lasting documents.
HP Everyday Photo Paper	Print colorful, everyday snapshots at a low cost, using paper designed for casual photo printing. This affordable, photo paper dries quickly for easy handling. Get sharp, crisp images when you use this paper with any inkjet printer. Available in semi-gloss finish in 8.5 x 11 inch, A4, 10 x 15 cm,(4 x 6 inch). It is acid-free for longer lasting documents.
HP Iron-On Transfers	HP Iron-on Transfers (for color fabrics or for light or white fabrics) are the ideal solution for creating custom T-shirts from your digital photos.

To order HP papers and other supplies, go to www.hp.com/buy/supplies. If prompted, choose your country/region, follow the prompts to select your product, and then click one of the shopping links on the page.

 **NOTE:** At this time, some portions of the HP Web site are available in English only.

HP Photo Value Packs:

HP Photo Value Packs conveniently package Original HP ink cartridges and HP Advanced Photo Paper to save you time and take the guesswork out of printing affordable professional photos with your HP printer. Original HP inks and HP Advanced Photo Paper have been designed to work together so your photos are long lasting and vivid, print after print. Great for printing out an entire vacation's worth of photos or multiple prints to share.

Recommended papers for photo printing

If you want the best print quality, HP recommends using HP papers that are specifically designed for the type of project you are printing.

Depending on your country/region, some of these papers might not be available.

HP Advanced Photo Paper

This thick photo paper features an instant-dry finish for easy handling without smudging. It resists water, smears, fingerprints, and humidity. Your prints have a look and feel comparable to a store processed photo. It is available in several sizes, including A4, 8.5 x 11 inch, 10 x 15 cm (4 x 6 inch), 13 x 18 cm (5 x 7 inch) and two finishes – glossy or soft gloss (satin matte). It is acid-free for longer lasting documents.

HP Everyday Photo Paper

Print colorful, everyday snapshots at a low cost, using paper designed for casual photo printing. This affordable, photo paper dries quickly for easy handling. Get sharp, crisp images when you use this paper with any inkjet printer. Available in semi-gloss finish in 8.5 x 11 inch, A4, 10 x 15 cm. (4 x 6 inch). It is acid-free for longer lasting documents.

HP Photo Value Packs:

HP Photo Value Packs conveniently package Original HP ink cartridges and HP Advanced Photo Paper to save you time and take the guesswork out of printing affordable professional photos with your HP printer. Original HP inks and HP Advanced Photo Paper have been designed to work together so your photos are long lasting and vivid, print after print. Great for printing out an entire vacation's worth of photos or multiple prints to share.

To order HP papers and other supplies, go to www.hp.com/buy/supplies. If prompted, choose your country/region, follow the prompts to select your product, and then click one of the shopping links on the page.



NOTE: At this time, some portions of the HP Web site are available in English only.

Tips for selecting and using print media

- Always use media that conforms to the device specifications. For more information, see [Understand specifications for supported media](#).
- Load only one type of media at a time into a tray. If you place a special media on top of a plain media, you may end up with a paper jam or an incorrect print.
- Load media print-side down, aligned against the back of the tray. Align the media to the right side of the input tray and adjust the paper-width guide. For more information, see [Load media](#).
- Do not overload the trays. For more information, see [Understand specifications for supported media](#). HP recommends loading special media no higher than 3/4 full.
- To prevent jams, poor print quality, and other printing problems, avoid the following media:
 - Multipart forms
 - Media that is damaged, curled, or wrinkled
 - Media with cutouts or perforations

- Media that is heavily textured, embossed, or does not accept ink well
- Media that is too lightweight or stretches easily

Cards and envelopes

- Avoid envelopes that have a very slick finish, self-stick adhesives, clasps, or windows. Also avoid cards and envelopes with thick, irregular, or curled edges, or areas that are wrinkled, torn, or otherwise damaged.
- Use tightly constructed envelopes, and make sure the folds are sharply creased.
- Load envelopes aligned according to the graphic.

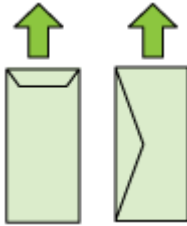

Photo media

- Use the **Best** mode to print photographs. Note that in this mode, printing takes longer and more memory is required from your computer.
- Remove each sheet as it prints and set it aside to dry. Allowing wet media to stack up may cause smearing.

Transparencies

- Insert transparencies with the rough side down and the adhesive strip pointing towards the back of the device.
- Remove each sheet as it prints and set it aside to dry. Allowing wet media to stack up may cause smearing.

Custom-sized media

- Use only custom-sized media that is supported by the device.
- If your application supports custom-sized media, set the media size in the application before printing the document. If not, set the size in the printer driver. You might need to reformat existing documents to print them correctly on custom-sized media.

Understand specifications for supported media

Use the [Understand supported sizes](#) and [Understand supported media types and weights](#) tables to determine the correct media to use with your device and determine the features that will work with your media.

Always use the correct media-type setting in the printer driver, and configure the trays for the correct media type. HP recommends testing any paper before buying it in large quantities.

- [Understand supported sizes](#)
- [Understand supported media types and weights](#)

Understand supported sizes

Media size	Input tray	Duplexer (some models)
Standard media sizes		
U.S. Letter (216 x 279 mm; 8.5 x 11 inches)	✓	✓
U.S. Legal (216 x 356 mm; 8.5 x 14 inches)	✓	
A4 (210 x 297 mm; 8.3 x 11.7 inches)	✓	✓
U.S. Executive (184 x 267 mm; 7.25 x 10.5 inches)	✓	✓
B5 (JIS) (182 x 257 mm; 7.17 x 10.12 inches)	✓	✓
B5 (ISO) (176 x 250 mm; 6.9 x 9.8 inches)	✓	✓
B7 (88 x 125 mm; 3.5 x 4.9 inches)	✓	
A5 (148 x 210 mm; 5.8 x 8.3 inches)	✓	✓
Borderless A4 (210 x 297 mm; 8.3 x 11.7 inches)	✓	
Borderless A5 (148 x 210 mm; 5.8 x 8.3 inches)	✓	
Borderless B5 (182 x 257 mm; 7.17 x 10.12 inches)	✓	
HV (101 x 180 mm; 4.0 x 7.1 inches)	✓	
Cabinet size (120 x 165 mm; 4.7 x 6.5 inches)	✓	
13 x 18 cm (5 x 7 inches)	✓	
Borderless cabinet (120 x 165 mm; 4.7 x 6.5 inches)	✓	
Borderless 13 x 18 cm (5 x 7 inches)	✓	
Envelopes		
U.S. #10 Envelope (105 x 241 mm; 4.12 x 9.5 inches)	✓	
C6 Envelope (114 x 162 mm; 4.5 x 6.4 inches)	✓	
Japanese Envelope Chou #3 (120 x 235 mm; 4.7 x 9.3 inches)	✓	
Japanese Envelope Chou #4 (90 x 205 mm; 3.5 x 8.1 inches)	✓	
Monarch Envelope	✓	
Card Envelope (111 x 162 mm; 4.4 x 6 inches)	✓	
No. 6 3/4 Envelope (91 x 165 mm; 3.6 x 6.5 inches)	✓	

(continued)

Media size	Input tray	Duplexer (some models)
Cards		
Index card (76.2 x 127 mm; 3 x 5 inches)	✓	
Index card (102 x 152 mm; 4 x 6 inches)	✓	
Index card (127 x 203 mm; 5 x 8 inches)	✓	
A6 card (105 x 148.5 mm; 4.13 x 5.83 inches)	✓	
Borderless A6 card (105 x 148.5 mm; 4.13 x 5.83 inches)	✓	
Hagaki** (100 x 148 mm; 3.9 x 5.8 inches)	✓	
Ofuku hagaki**	✓	
Borderless hagaki (100 x 148 mm; 3.9 x 5.8 inches) **	✓	
Photo media		
Photo media (102 x 152 mm; 4 x 6 inches)	✓	
Photo media (5 x 7 inches)	✓	
Photo media (8 x 10 inches)	✓	
Photo media (10 x 15 cm)	✓	
Photo L (89 x 127 mm; 3.5 x 5 inches)	✓	
2L (178 x 127 mm; 7.0 x 5.0 inches)	✓	
Borderless photo media (102 x 152 mm; 4 x 6 inches)	✓	
Borderless photo media (5 x 7 inches)	✓	
Borderless photo media (8 x 10 inches)	✓	
Borderless photo media (8.5 x 11 inches)	✓	
Borderless photo media (10 x 15 cm)	✓	
Borderless Photo L (89 x 127 mm; 3.5 x 5 inches)	✓	
Borderless 2L (178 x 127 mm; 7.0 x 5.0 inches)	✓	
Borderless B5 (182 x 257 mm; 7.2 x 10.1 inches)	✓	
Borderless B7 (88 x 125 mm; 3.5 x 4.9 inches)	✓	
Borderless 4 x 6 tab (102 x 152 mm; 4 x 6 inches)	✓	

(continued)

Media size	Input tray	Duplexer (some models)
Borderless 10 x 15 cm tab	✓	
Borderless 4 x 8 tab (10 x 20 cm)	✓	
Borderless HV (101 x 180 mm; 4.0 x 7.1 inches)	✓	
Borderless double A4 (210 x 594 mm; 8.3 x 23.4 inches)	✓	
4 x 6 tab (102 x 152 mm; 4 x 6 inches)	✓	
10 x 15 cm tab	✓	
4 x 8 tab / 10 x 20 cm tab	✓	
Other media		
Custom-sized media between 76.2 to 216 mm wide and 101 to 762 mm long (3 to 8.5 inches wide and 4 to 30 inches long)	✓	
Panorama (4 x 10 inches, 4 x 11 inches, and 4 x 12 inches)	✓	
Borderless panorama (4 x 10 inches, 4 x 11 inches, and 4 x 12 inches)	✓	

** The device is compatible with plain and inkjet hagaki from Japan Post only. It is not compatible with photo hagaki from Japan Post.

Understand supported media types and weights

Tray	Type	Weight	Capacity
Input tray	Paper	60 to 105 g/m ² (16 to 28 lb bond)	Up to 250 sheets of plain paper (25 mm or 1 inch stacked)
	Transparencies		Up to 70 sheets (17 mm or 0.67 inch stacked)
	Photo media	280 g/m ² (75 lb bond)	Up to 100 sheets (17 mm or 0.67 inch stacked)
	Labels		Up to 100 sheets (17 mm or 0.67 inch stacked)
	Envelopes	75 to 90 g/m ² (20 to 24 lb bond envelope)	Up to 30 sheets (17 mm or 0.67 inch stacked)

(continued)

Tray	Type	Weight	Capacity
	Cards	Up to 200 g/m ² (110 lb index)	Up to 80 cards
Duplexer (available on some models)	Paper	60 to 105 g/m ² (16 to 28 lb bond)	Not applicable
Output tray	All supported media		Up to 50 sheets of plain paper (text printing)

Set minimum margins

The document margins must match (or exceed) these margin settings in portrait orientation.

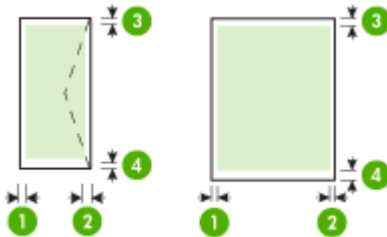

Media	(1) Left margin	(2) Right margin	(3) Top margin	(4) Bottom margin
U.S. Letter	3.3 mm (0.13 inch)	3.3 mm (0.13 inch)	3.3 mm (0.13 inch)	3.3 mm (0.13 inch)
U.S. Legal				3.3 mm (0.13 inch)
A4				
U.S. Executive				
B5				
A5				
Cards				
Custom-sized media				
Photo media				
Envelopes				3.3 mm (0.13 inch)

 **NOTE:** If you are using the duplexer to print on both sides of the paper, the minimum top and bottom margins must match or exceed 14.9 mm (0.59 inch).

NOTE: For Mac OS X, the minimum bottom margin for all the media (except envelope, Hagaki, and Ofuku Hagaki) is 15 mm (0.586 inch).

Load media

This section provides instructions for loading media into the device.

Load Tray 1 (main tray)

1. Lift the output tray.



2. Slide the media guide out to the widest setting.
3. Insert the media print-side down along the right of the tray. Make sure the stack of media aligns with the right and back edges of the tray and does not exceed the line marking in the tray.



NOTE: Do not load paper while the device is printing.

4. Slide the media guide in the tray to adjust it for the media size that you have loaded, and then lower the output tray.



5. Pull out the extension on the output tray.



 **NOTE:** For media longer than 279 mm (11 inches), pull the extension out to the maximum extended position. Make sure the flap at the end of the extension tray is not lifted, otherwise it will interfere with the paper being ejected.

Change print settings

You can change print settings (such as paper size or type) from an application or the printer driver. Changes made from an application take precedence over changes made from the printer driver. However, after the application is closed, the settings return to the defaults configured in the driver.

 **NOTE:** To set print settings for all print jobs, make the changes in the printer driver. For more information about the features of the Windows printer driver, see the online help for the driver. For more information about printing from a specific application, see the documentation that came with the application.

- [To change settings from an application for current jobs \(Windows\)](#)
- [To change default settings for all future jobs \(Windows\)](#)
- [To change settings \(Mac OS X\)](#)

To change settings from an application for current jobs (Windows)

1. Open the document that you want to print.
2. On the **File** menu, click **Print**, and then click **Setup**, **Properties**, or **Preferences**. (Specific options may vary depending on the application that you are using.)
3. Choose the printing shortcut that you want, and then click **OK**, **Print**, or a similar command.

To change default settings for all future jobs (Windows)

1. Click **Start**, point to **Settings**, and then click **Printers** or **Printers and Faxes**.
- Or -
Click **Start**, click **Control Panel**, and then double-click **Printers**.



NOTE: If prompted, enter the computer administrator's password.

2. Right-click the printer icon, and then click **Properties**, **Document Defaults**, or **Printing Preferences**.
3. Change the settings that you want, and then click **OK**.

To change settings (Mac OS X)

1. On the **File** menu, click **Page Setup**.



NOTE: In Mac OS X (v10.5), some applications do not have a **Page Setup** menu, it is part of the **Print** menu.

2. Change the settings that you want (such as paper size), and then click **OK**.
3. On the **File** menu, click **Print** to open the printer driver.
4. Change the settings that you want (such as media type), and then click **OK** or **Print**.

Print on both sides (duplexing)

You can print on both sides of a sheet of media, either automatically by using the automatic two-sided printing accessory (duplexer), or manually by turning the media over and feeding it into the device again.

- [Guidelines for printing on both sides of a page](#)
- [Perform duplexing](#)

Guidelines for printing on both sides of a page

- Always use media that conforms to the device specifications. For more information, see [Understand specifications for supported media](#).
- Specify duplex options in your application or in the printer driver.
- Do not print on both sides of transparencies, envelopes, photo paper, glossy media, or paper lighter than 60 g/m² bond (16 lb) or heavier than 105 g/m² bond (28 lb). Jams might occur with these media types.
- Several kinds of media require a specific orientation when you print on both sides of a page, such as letterhead, preprinted paper, and paper with watermarks and prepunched holes. When you print from a computer running Windows, the device prints the first side of the media first. When you print from a computer using Mac OS X, the device prints the second side first.

- For auto-duplexing, when printing finishes on one side of the media, the device holds the media and pauses while the ink dries. Then the media is pulled back into the device and the second side is printed. When printing is complete, the media is dropped onto the output tray. Do not grab it before printing is complete.
- You can print on both sides of supported custom-sized media by turning the media over and feeding it into the device again. For more information, see [Understand specifications for supported media](#).

Perform duplexing

 **NOTE:** You can perform manual duplexing by first printing only the odd pages, flipping the pages over, and then printing only the even pages.

To print automatically on both sides of a page (Windows)

1. Load the appropriate media. For more information, see [Guidelines for printing on both sides of a page](#) and [Load media](#).
2. Make sure the duplexer is properly installed. For more information, see [Install the duplexer \(available on some models\)](#).
3. With a document open, click **Print** on the **File** menu, and then select a printing shortcut.
4. Change any other settings, and then click **OK**.
5. Print your document.

To print automatically on both sides of a page (Mac OS X)

1. Load the appropriate media. For more information, see [Guidelines for printing on both sides of a page](#) and [Load media](#).
2. Make sure the duplexer is properly installed. For more information, see [Install the duplexer \(available on some models\)](#).
3. Verify that you are using the correct printer and page size in the **Page Setup**.
4. On the **File** menu, click **Print**.
5. Select **Copies and Pages** from the drop-down list.
6. Select the **Two-sided Printing** option.
7. Select the binding orientation by clicking the appropriate icon.
8. Change any other settings, and then click **Print**.

Print on special and custom-sized media

To print on special or custom-sized media (Windows)

1. Load the appropriate media. For more information, see [Load media](#).
2. With a document open, click **Print** on the **File** menu, and then click **Setup**, **Properties**, or **Preferences**.
3. Click the **Features** tab.

4. Select the media size from the **Size** drop-down list. If you do not see the media size, create a custom media size.
 - a. Select **Custom** from the drop-down list.
 - b. Type a name for the new custom size.
 - c. In the **Width** and **Height** boxes, type the dimensions, and then click **Save**.
 - d. Click **OK** twice to close the **Properties** or **Preferences** dialog box. Open the dialog box again.
 - e. Select the new custom size.
5. Select the paper type in the **Paper type** drop-down list.
6. Select the media source from the **Paper source** drop-down list.
7. Change any other settings, and then click **OK**.
8. Print your document.

To print on special or custom-sized media (Mac OS X)

1. Load the appropriate media. For more information, see [Load media](#).
2. On the **File** menu, click **Page Setup**.

 **NOTE:** Some Mac OS X 10.5 applications do not have a **Page Setup** menu, it is included in the **Print** menu.

3. Verify that you have selected the HP device.
4. Select the media size.
5. To set a custom media size:
 - a. Click **Manage Custom Sizes** in the **Paper Size** pull-down menu.
 - b. Click **New** and type a name for the size in the **Paper Size Name** box.
 - c. (Optional) In the **Width** and **Height** boxes, type the dimensions and set the margins, if desired.
 - d. Click **Done** or **OK**, and then click **Save**.
6. On the **File** menu, click **Page Setup**, and then select the new custom size.

 **NOTE:** Some Mac OS X (v10.5) applications do not have a **Page Setup** menu, it is included in the **Print** menu.

7. Click **OK**.
8. On the **File** menu, click **Print**.
9. Open the **Paper Handling** panel.
10. Under **Destination Paper Size**, click the **Scale to fit paper size** tab, and then select the customized paper size.
11. Change any other settings, and then click **OK** or **Print**.

Print borderless

Borderless printing lets you print to the edges of certain photo media types and a range of standard media sizes.

 **NOTE:** Open the file in a software application and assign the image size. Make sure the size corresponds to the media size on which you are printing the image.

You can also gain access to this feature from the **Printing Shortcuts** tab (Windows only). Open the printer driver, select the **Printing Shortcuts** tab, and select the printing shortcut for this print job from the drop-down list.

NOTE: Not all applications support borderless printing.

- [To print a borderless document \(Windows\)](#)
- [To print a borderless document \(Mac OS X\)](#)

To print a borderless document (Windows)

1. Load the appropriate media. For more information, see [Load media](#).
2. Open the file that you want to print.
3. From the application, open the printer driver:
 - a. Click **File**, and then click **Print**.
 - b. Click **Properties, Setup**, or **Preferences**.
4. Select the print settings shortcut you want to use.
5. Change any other print settings, and then click **OK**.
6. Print the document.
7. If you printed on photo media with a tear-off tab, remove the tab to make the document completely borderless.

To print a borderless document (Mac OS X)

1. Load the appropriate media. For more information, see [Load media](#).
2. Open the file that you want to print.
3. Click **File**, and then click **Page Setup**.

 **NOTE:** Some Mac OS X (v10.5) applications do not have a **Page Setup** menu, it is included in the **Print** menu.

4. Select the borderless media size, and then click **OK**.
5. Click **File**, and then click **Print**.
6. Open the **Paper Type/Quality** panel.
7. Click the **Paper tab**, and then select the media type from the **Paper type** drop-down list.
8. Check the **Borderless Printing** tab and make sure **Borderless** is selected, and change the **Borderless Expansion** if you want.
9. If you are printing photos, select **Best** from the **Quality** drop-down list. Alternatively, select **Maximum** dpi, which provides up to 4800 x 1200 optimized dpi. For color printing and 1200 input dpi. This setting might temporarily use a large amount of hard disk space (400 MB or more) and will print more slowly.
10. Select the media source.
11. Change any other print settings, and then click **Print**.
12. If you printed on photo media with a tear-off tab, remove the tab to make the document completely borderless.

Print a Web page (Windows only)

You can print a Web page from your Web browser on the HP Printer.

If you use Internet Explorer 6.0 or higher for Web browsing, you can use **HP Smart Web Printing** to ensure simple, predictable Web printing with control over what you want and how you want it printed. You can access **HP Smart Web Printing** from the toolbar in Internet Explorer. For more information about **HP Smart Web Printing**, see the help file provided with it.

To print a Web page

1. Make sure that you have paper loaded in the main input tray.
2. On the **File** menu in your Web browser, click **Print**.

 **TIP:** For best results, select **HP Smart Web Printing** from the **File** menu. A check mark appears when it is selected.

The **Print** dialog box appears.

3. Make sure that the product is the selected printer.
4. If your Web browser supports it, select the items on the Web page that you want to include in the printout.
For example, in Internet Explorer, click the **Options** tab to select options such as **As laid out on screen**, **Only the selected frame**, and **Print all linked documents**.
5. Click **Print** or **OK** to print the Web page.

 **TIP:** To print Web pages correctly, you might need to set your print orientation to **Landscape**.

Cancel a print job

You can cancel a print job using one of the following methods:

Control panel: Press the **X Cancel** button. This clears the job that the device is currently processing. It does not affect jobs waiting to be processed.

Windows: Double-click the printer icon that appears in the lower-right corner of the computer screen. Select the print job, and then press the **Delete** key on the keyboard.

Mac OS X: Click the printer icon in the Dock, select the document, and then click **Delete**.

4 Configure and manage

This information is intended for the administrator or individual who is responsible for managing the device. This section contains information about the following topics:

- [Manage the device](#)
- [Use device management tools](#)
- [Understand the printer status page](#)
- [Understand the network configuration or wireless status report](#)
- [Configure the device \(Windows\)](#)
- [Configure the device \(Mac OS X\)](#)
- [Set up the device for wireless communication](#)
- [Uninstall and reinstall the software](#)

Manage the device

The following common tools can be used to manage the device. For information about accessing and using the tools, see [Use device management tools](#).



NOTE: Specific procedures might include other methods.

Windows

- Device control panel
- Printer driver
- Toolbox
- Network Toolbox
- Embedded Web server

Mac OS X

- Device control panel
- HP Printer Utility
- Embedded Web server

This section contains the following topics:

- [Monitor the device](#)
- [Administer the device](#)





Monitor the device

Use this tool...	to obtain the following information...
Device control panel	Obtain information about the status of jobs that are being processed, the operating status of the device, and the status of ink cartridges.
Embedded Web server	<ul style="list-style-type: none"> • Printer status information: Click the Information tab, and then click a selection in the left pane. • Accumulated ink and media usage: Click the Information tab, and then click Usage Report in the left pane.
Toolbox (Windows)	Ink cartridge information: Click the Estimated Ink Levels tab to view the ink-level information, and then scroll to display the Cartridge Details button. Click the this button to view information about replacement print cartridges.*
HP Printer Utility (Mac OS X)	Ink cartridge information: Open the Information and Support panel and click Supplies Status . *
HP Solution Center	Provides current status of the device.

* Ink level alerts and indicators provide estimates for planning purposes only. When you receive a low-ink alert, consider having a replacement cartridge available to avoid possible printing delays. You do not need to replace the ink cartridges until print quality becomes unacceptable.

Administer the device

This section provides information about administering the device and modifying settings.

Use this tool...	to do the following...
Control panel	Reset the administrator password and network settings: Press and hold the  Power button, press  Network button, (on some models, press the Wireless button ) , two times, press the  Cancel button three times, and release the Power button. For more information, see Troubleshooting tips and resources .
Embedded Web server	<ul style="list-style-type: none"> • Set embedded Web server password: Click the Settings tab, and then click Security in the left pane. • Perform device maintenance tasks: Click the Settings tab, and then click Device Services in the left pane. • Language or country/region: Click the Settings tab, and then click International in the left pane.

(continued)

Use this tool...	to do the following...
	<ul style="list-style-type: none">• Configure network settings: Click the Networking tab, and then click an option in the left pane.• Order supplies: On any tab, click the Order Supplies button, and then follow the onscreen instructions.• Support: On any tab, click the Support button, and then select a support option.
Toolbox (Windows)	<ul style="list-style-type: none">• Perform device maintenance tasks: Click the Device Services tab.• Configure network settings: Click the Network Settings tab, and then click Change Settings to launch the Network Toolbox.
Network Toolbox	<p>View and change network settings. From the Toolbox, click the Network Settings tab.</p> <ul style="list-style-type: none">• Change settings: click the Change Settings button.• Run a network diagnostic (to check the network printer connection):<ul style="list-style-type: none">◦ If the printer is not connected, click Change Settings, and then click Run Network Diagnostic.◦ If the printer is connected, when the toolbox opens, click the Utilities tab, and then click Run Network Diagnostic.• Change the printer's IP address: In the Network Settings tab, click Wired or Wireless tab, depending on the connection, edit the IP Settings, and then click OK.• Change the printer's DNS setting: In the Network Settings tab, click Wired or Wireless tab, depending on the connection, edit the DNS Settings, and then click OK.• Print Wireless Network Test Report: In the Network Settings tab, click the Utilities tab, and then click Print Wireless Network Test Report.
HP Printer Utility (Mac OS X)	<p>Perform device maintenance tasks: Open the Information and Support panel, and then click the option for the task that you want to perform.</p>

Use device management tools

The following lists common tools that can be used to manage the device.

- [Embedded Web server](#)
- [Toolbox \(Windows\)](#)
- [Use the HP Solution Center \(Windows\)](#)
- [HP Printer Utility \(Mac OS X\)](#)
- [Use the HP Device Manager \(Mac OS X\)](#)

Embedded Web server

When the device is connected to a network, you can use the embedded Web server to view status information, change settings, and manage it from your computer.

 **NOTE:** For a list of system requirements for the embedded Web server, see [Embedded Web server specifications](#).

Some settings might be restricted by the requirement for a password.

You can open and use the embedded Web server without being connected to the Internet; however, some features will not be available.

The embedded Web server (EWS) places very small text files (cookies) on your hard drive when you are browsing. These files let the EWS recognize your computer the next time you visit. For example, if you have configured the EWS language, a cookie helps remember which language you've selected so that the next time you open the EWS, the pages are displayed in that language. Though some cookies are cleared at the end of each session (such as the cookie that stores the selected language), others (such as the cookie that stores customer-specific preferences) are stored on the computer until you clear them manually.

You can configure your browser to accept all cookies, or you can configure it to alert you every time a cookie is offered, which allows you to decide which cookies to accept or refuse. You can also use your browser to remove unwanted cookies.

 **NOTE:** Depending on your device, if you chose to disable cookies, you will disable one or more of the following features:

- Automatically refreshing the existing page
- Starting where you left the application (especially useful when using setup wizards)
- Preventing other users from modifying the same settings while you are making changes
- Remembering the EWS browser language setting

For information about how to change your privacy and cookie settings and how to view or delete cookies, see the documentation available with your Web browser.

- [To open the embedded Web server](#)
- [Embedded Web server pages](#)

To open the embedded Web server

 **NOTE:** When you open the embedded Web server, you might receive an invalid certificate message. Accept the link to enter the EWS.

You can open the embedded Web server by using these methods:

- **Web browser:** In a supported Web browser on your computer, type the IP address or hostname that has been assigned to the device.
For example, if the IP address is 123.123.123.123, type the following address into the Web browser: `http://123.123.123.123`.
The IP address and hostname for the device are listed on the wireless status report. For more information, see [Understand the network configuration or wireless status report](#).
After opening the embedded Web server, you can bookmark it so that you can return to it quickly.
- **Windows taskbar:** Right-click the HP Digital Imaging Monitor icon, point to the device you wish to view, and then click **Network Settings (EWS)**.
- **Windows Vista:** In the Network list of devices, right-click the device icon and then select **View device webpage**.

Embedded Web server pages

The embedded Web server contains pages that you can use to view product information and change device settings. The pages also contain links to other e-services.

Pages/buttons	Contents
Information page	Shows status information about the device, its ink supplies and usage, and a log of device events (such as errors). NOTE: Ink level alerts and indicators provide estimates for planning purposes only. When you receive a low-ink alert, consider having a replacement cartridge available to avoid possible printing delays. You do not need to replace the ink cartridges until print quality becomes unacceptable.
Settings page	Shows the settings that have been configured for the device and gives you the ability to change these settings.
Networking page	Shows network status and the network settings that have been configured for the device. These pages only appear if the device is connected to a network.
Support and Order Supplies buttons	Support provides a number of support services. Order Supplies connects you to online ordering of supplies.

Toolbox (Windows)

The Toolbox provides maintenance information about the device.

 **NOTE:** The Toolbox can be installed from the Starter CD by selecting the full installation option if the computer meets the system requirements.

This section contains the following topics:

- [Open the Toolbox](#)
- [Toolbox tabs](#)
- [Network Toolbox](#)

Open the Toolbox

- From the HP Solution Center, click the **Settings** menu, point to **Print Settings**, and then click **Printer Toolbox**.
- Or -
- Right-click the HP Digital Imaging Monitor in the taskbar, point to **Printer Model Name** and then click **Display Printer Toolbox**.

Toolbox tabs

The Toolbox contains the following tabs.

Tabs	Contents
Estimated Ink Level	<ul style="list-style-type: none"> • Ink Level Information: Shows estimated ink level for each cartridge. NOTE: Ink level alerts and indicators provide estimates for planning purposes only. When you receive a low-ink alert, consider having a replacement cartridge available to avoid possible printing delays. You do not need to replace the ink cartridges until print quality becomes unacceptable. • Shop Online: Provides access to a Web site from which you can order printing supplies for the device online. • Order by Phone: Shows telephone numbers that you can call to order supplies for the device. Telephone numbers are not available for all countries/regions. • Cartridge Details: Shows order numbers of the installed ink cartridges.
Device Services	<ul style="list-style-type: none"> • Printer Status Page: Allows you to print the printer status page of the device. This page contains information about the device and the supplies. For more information, see Understand the printer status page. • Print a Print Quality Diagnostic Page: Allows you to print the print-quality diagnostic report of the device. This page contains information about the device and ink cartridges. • Align Printheads: Guides you through aligning the printheads. For more information, see Align the printhead. • Clean Printheads: Guides you through cleaning the printheads. For more information, see Clean the printhead.

(continued)

Tabs	Contents
Network Settings	Gives information on the network settings. Click Change Settings to open the Network Toolbox and change some network settings.

Network Toolbox

The Network Toolbox allows you to view and change some network settings. You can change the IP address, turn the wireless radio on or off, perform tests, and print reports.

To open the Network Toolbox

1. Open the Toolbox
2. Click the **Network Settings** tab.
3. Click the **Change Settings...** button.
4. Do one of the following:
 - To change wired network settings, click **Wired Settings**.
 - To change wireless settings, click **Wireless Settings**.
 - To print reports or run a diagnostic test, click **Utilities**.

Use the HP Solution Center (Windows)

Use the HP Solution Center to change print settings, order supplies, and access the onscreen Help.

The features available in the HP Solution Center vary depending on the devices you have installed. The HP Solution Center is customized to show icons that are associated with the selected device. If the selected device is not equipped with a particular feature, then the icon for that feature does not appear in the HP Solution Center.

To open the HP Solution Center

- ▲ Double-click the HP Digital Imaging Monitor in the taskbar.

HP Printer Utility (Mac OS X)

The HP Printer Utility contains tools to configure print settings, calibrate the device, order supplies online, and find Web site support information.

This section contains the following topics:

- [Open the HP Printer Utility](#)
- [HP Printer Utility panels](#)

Open the HP Printer Utility

To open the HP Printer Utility from the HP Device Manager

1. Click the HP Device Manager icon in the Dock.

 **NOTE:** If the icon does not appear in the Dock, click the Spotlight icon on the right side of the menu bar, type `HP Device Manager` in the box, and then click the **HP Device Manager** entry.

2. Select **Maintain printer**.
3. Select the HP device, and then click **Select**.

HP Printer Utility panels

Information and Support panel

- **Supplies Status:** Shows the information about currently installed ink cartridges.

 **NOTE:** Ink level alerts and indicators provide estimates for planning purposes only. When you receive a low-ink alert, consider having a replacement cartridge available to avoid possible printing delays. You do not need to replace the ink cartridges until print quality becomes unacceptable.

- **Supply Info:** Displays information about the ink cartridges.
- **Device Information:** Displays information about the model and serial number. This page contains information about the device and the supplies.
- **Print Quality Diagnostics:** Prints a Print Quality Diagnostic page.
- **Clean Printheads:** Guides you through cleaning the printhead.
- **Align:** Guides you through aligning the printhead.
- **HP Support:** Gain access to HP Web site where you can find support for the device, register the device, and find information about returning and recycling used printing supplies.
- **Print Status Report:** Prints a printer status report. For more information, see [Understand the printer status page](#)

Use the HP Device Manager (Mac OS X)

To open the HP Device Manager on a Macintosh computer

1. Click the HP Device Manager icon in the Dock.

 **NOTE:** If the icon does not appear in the Dock, click the Spotlight icon on the right side of the menu bar, type `HP Device Manager` in the box, and then click the **HP Device Manager** entry.

2. Select the device from the **Devices** drop-down menu.

From here, you can check for software updates, configure more software options, and perform maintenance procedures such as checking the ink levels for the ink cartridges.

 **NOTE:** On a Macintosh computer, the features available in the HP Device Manager vary depending on the selected device.

Ink level warnings and indicators provide estimates for planning purposes only. When you receive an ink alert message, consider having a replacement cartridge available to avoid possible printing delays. You do not need to replace cartridges until print quality becomes unacceptable.

 **TIP:** When the HP Device Manager is opened, you can gain access to the Dock menu shortcuts by selecting and holding the mouse button over the appropriate icon for the HP Device Manager in the Dock.

Understand the printer status page

Use the Printer Status page to:

- View current device information and ink cartridge status
- Help troubleshoot problems

If you need to call HP, it is often useful to print the Printer Status page before calling.

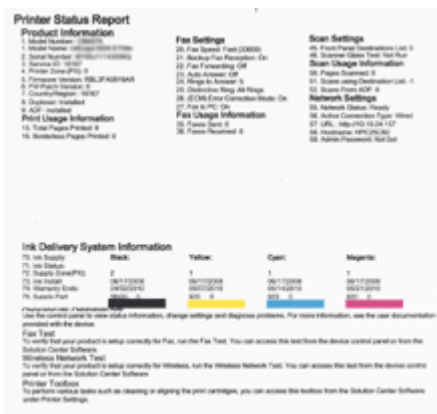

1. **Printer Information:** Shows device information (such as the product name, model number, serial number, and firmware version number), the accessories that are installed (such as the duplexer), and the number of pages printed from the trays and accessories.
2. **Ink Cartridge Status:** Shows the estimated ink levels (represented in graphical form as gauges) and the part numbers and expiration dates of the ink cartridges.



NOTE: Ink level alerts and indicators provide estimates for planning purposes only. When you receive a low-ink alert, consider having a replacement cartridge available to avoid possible printing delays. You do not need to replace the ink cartridges until print quality becomes unacceptable.

3. **Additional Assistance:** Shows the location where you can get assistance printing a Wireless Network Test (some models only) or how to open the HP Solution Center software.

To print the Printer Status page

- **Control panel:** Press and hold the **X Cancel** button for 3 seconds.
- **Toolbox (Windows):** Click the **Device Services** tab, and then click **Print a Test Page**.
- **HP Printer Utility (Mac OS X):** Click **Device Information** from the **Information and Support** panel, and then click **Print Configuration Page**.
- **Embedded Web server:** Click **Settings**, under **Device** in the left pane, click **Device Services**, and select **Printer Status Report** from the drop-down menu under **Reports**, and then click **Print**.

Understand the network configuration or wireless status report

The network configuration or wireless status report shows the network or wireless settings for the device.

The screenshot shows the HP Network Configuration Page with the following sections and settings:

HP Network Configuration Page		
General Information		
Network Status		Ready
Action Connection Type		Wired
URL for Embedded Web Server	http://192.168.1.62/103	
Physical Function		10/100/1000
Hardware		HP1000-1000
Serial Number		MP1000-1000
Address		10/100
802.3 Wired		
Hardware Address (MAC)		02:00:0C:00:00:00
Link Configuration		1000T_Full
IPV4		
IP Address		192.168.1.62/24
Subnet Mask		255.255.255.0
Default Gateway		192.168.1.1
Configuration Source		DHCP
Primary DNS Server		192.168.1.1
Secondary DNS Server		192.168.1.1
TFTP/Trivial File Transfer		192.168.1.1
TFTP/Trivial File Transfer		192
IPV6		
Primary DNS Server		-
Secondary DNS Server		-
Address		-
Prefix Length		64
Configuration		Static
802.11 Wireless		
Hardware Address (MAC)		02:00:0C:00:00:00
Status		Disabled
Port 8100		
Status		Disabled
LPC		
Status		Enabled
WLAN		
Status		Disabled
Device Name		HP1000-1000
SLP		
Status		Enabled
Microsoft Web Services		
WSS Discovery		Enabled
WSS Proxy		Enabled
WMM		
Status		Priority-Based QoS
WMM/Power		Off
WMM/Power		Max Throughput
WMM/Power		Max Throughput
WPS		
Status		Enabled
Primary Server	192.168.1.1	DHCP
Secondary Server	192.168.1.1	DHCP

- 1. General Information:** Shows information about the current status and connection type of the network, and other information, such as the URL of the embedded Web server and the hardware address of the device.

Network Status: This setting can be 'Ready' or 'Offline'. When the setting is 'Offline', it implies either that the IP is being assigned or negotiated by the DHCP server, or that the AutoIP or the network is not available.
- 2. 802.3 Wired (some models):** Shows information about your wired network connection, such as the hostname, IP address, subnet mask, default gateway, and server.

Link Configuration: The possible values are '10T/100T HalfDplx/FullDplx', '10T HalfDplx', '100T FullDplx', and '100T HalfDplx'.

3. **802.11 Wireless (some models):** Shows information about your wireless network connection, such as the hostname, IP address, subnet mask, default gateway, and server.
4. **Miscellaneous:** Shows information, such as the administrator details.
 - **mDNS:** Shows information about the active Multicast Domain Name System (mDNS) connection. mDNS services are typically used on small networks for IP address and name resolution (through UDP port 5353) where a conventional DNS server is not used.
 - **SLP:** Shows information about the current Service Location Protocol (SLP) connection. SLP is used by network management applications for device management. The device supports SNMPv1 protocol on IP networks.

Configure the device (Windows)

You can connect the device directly to a computer, or you can share the device among other users on a network.

 **NOTE:** Microsoft Internet Explorer 6.0 must be installed on the computer system to run the installation program.

Also, you must have administrator privileges to install a printer driver on Windows 2000, Windows XP, or Windows Vista.

When setting up the device, HP recommends that you connect it after you install the software because the installation program is designed to provide you with the easiest setup experience. However, if you have connected the cable first, see [To connect the device before installing the software](#).

Direct connection

You can connect the device directly to your computer using a USB cable.

 **NOTE:** If you install the device software and connect the device to a computer running Windows, you can connect additional devices to the same computer with USB cables without reinstalling the device software.

When setting up the device, HP recommends that you connect the device when prompted by the installation software because the installation program is designed to provide you with the easiest setup experience. However, if you have connected the cable first, see [To connect the device before installing the software](#).

To install the software before connecting the device (recommended)

1. Close any applications that are running.
2. Insert the Starter CD into the CD drive. The CD menu runs automatically. If the CD menu does not start automatically, double-click the setup icon on the Starter CD.
3. On the CD menu, click **Install USB-connected Device** and follow the onscreen instructions.

 **NOTE:** You can also share the device with other computers using a simple form of networking known as locally shared networking. For more information, see [To share the device on a locally shared network](#).

To connect the device before installing the software

If you connected the device to the computer before installing the device software, the **Found New Hardware** wizard displays on the computer screen.

 **NOTE:** If you turned on the device, do not turn it off or unplug the cable from the device while the installation program is running. If you do so, the installation program will not finish.

1. In the **Found New Hardware** dialog box that displays methods for locating the printer driver, select the **Advanced** option, and then click **Next**.

 **NOTE:** Do not allow the **Found New Hardware** wizard to perform an automatic search for the printer driver.

2. Select the check box for specifying the driver location, and ensure that the other check boxes are clear.
3. Insert the Starter CD into the CD drive. If the CD menu appears, close it.
4. Browse to locate the root directory on the Starter CD (for example, D), and then click **OK**.
5. Click **Next** and follow the onscreen instructions.
6. Click **Finish** to close the **Found New Hardware** wizard. The wizard automatically starts the installation program (this might take a short while).
7. Complete the installation process.

 **NOTE:** You can also share the device with other computers using a simple form of networking known as locally shared networking. For more information, see [To share the device on a locally shared network](#).

To share the device on a locally shared network

In a locally shared network, the device is connected directly to the USB connector of a selected computer (known as the server) and is shared by other computers (clients).

 **NOTE:** When sharing a directly connected device, use the computer with the newest operating system as the server.

Use this configuration only in small groups or when usage is low. The connected computer is slowed down when many users print to the device.

1. Click **Start**, point to **Settings**, and then click **Printers** or **Printers and Faxes**.
- Or -
Click **Start**, click **Control Panel**, and then double-click **Printers**.
2. Right-click the device icon, click **Properties**, and then click the **Sharing** tab.
3. Click the option to share the device, and give it a share name.

Network connection

If the device has network capability, it can be shared in a network environment by connecting it directly to the network. This type of connection offers the ability to manage the device using the embedded Web server from any computer on the network.

 **NOTE:** Microsoft Internet Explorer 6.0 must be installed on the computer system to run the installation program.

Choose the installation option for the type of network you have:

- **Client/server network:** If your network has a computer acting as a dedicated print server, install the device software on the server, and then install the device software on the client computers. For more information see [Install the device on a network](#) and [Install the device software on client computers](#). This method does not allow you to share the full functionality of the device. Client computers can only print from the device.
- **Peer-to-peer network:** If you have a peer-to-peer network (a network without a dedicated print server), install the software on the computers that will be using the device. For more information, see [Install the device on a network](#).

In addition, you can connect to a network printer on both types of networks using the **Add Printer** wizard in Windows. For more information, see [Install the printer driver using Add Printer](#).

Install the device on a network

Use the following steps to install the device software in the following networking scenarios:

You have a peer-to-peer network (a network without a dedicated print server)

1. Remove the protective cover from the device's network port and connect the device to the network.
2. Close any third-party firewall and any applications that are running on the computer system that are acting as the print server.
3. Insert the Starter CD into the CD drive. The CD menu starts automatically. If the CD menu does not start automatically, browse to the CD drive of the computer and double-click **Setup.exe**.
4. On the CD menu, click **Install Network/Wireless Device**, and then follow the onscreen instructions.
5. On the **Connection Type** screen, select **Network/Wireless Device**, and then click **Next**.
6. Follow the onscreen instructions to complete the installation.

 **NOTE:** To share the device with Windows client computers, see [Install the device software on client computers](#) and [To share the device on a locally shared network](#).

Install the device software on client computers

After printer drivers are installed on the computer that is acting as the print server, the printing functionality can be shared. Individual Windows users who want to use the network device must install the software on their computers (clients).

A client computer can connect to the device in the following ways:

- In the Printers folder, double-click the **Add Printer** icon and follow the instructions for a network installation. For more information, see [Install the printer driver using Add Printer](#).
- On the network, browse to the device and drag it to your Printers folder.
- Add the device and install the software from the INF file on your network. On the Starter CD, the INF files are stored in the root directory of the CD.

Install the printer driver using Add Printer

1. Click **Start**, point to **Settings**, and then click **Printers** or **Printers and Faxes**.
- Or -
Click **Start**, click **Control Panel**, and then double-click **Printers**.
2. Double-click **Add Printer**, and then click **Next**.
3. Select **Network Printer** or **Network Printer Server**.
4. Click **Next**.
5. Do one of the following:
Type in the network path or queue name of the shared device, and then click **Next**.
Click **Have Disk** when prompted to select the device model.
Click **Next** and locate the device in the list of shared printers.
6. Click **Next** and follow the onscreen instructions to complete the installation.

Configure the device (Mac OS X)

You can use the device with a single Macintosh computer using a USB cable, or you can share it among other users on a network.

This section contains the following topics:

- [To install the software for network or direct connection](#)
- [To share the device on a locally shared network](#)

To install the software for network or direct connection

 **NOTE:** If you are installing the device on a wired network, connect the Ethernet cable before installing the software.

1. Insert the Starter CD into the CD drive. Double-click the **Install HP Software** icon.
2. Click **Install Software** and follow the onscreen instructions.
3. When prompted, connect the device to your computer.
4. If necessary, share the device with other Macintosh computer users.
 - **Direct connection:** Share the device with the other Macintosh computer users. For more information, see [To share the device on a locally shared network](#).
 - **Network connection:** Individual Macintosh computer users who want to use the device on the network must install the device software on their computers.

To share the device on a locally shared network

When you connect the device directly, you can share it with other computers using a simple form of networking known as locally shared networking. Use this configuration only in small groups or when usage is low. The connected computer is slowed down when many users print to the device.

Basic requirements for sharing in Mac OS X environment include the following items:

- The Macintosh computers must be communicating on the network using TCP/IP, and they must have IP addresses. (AppleTalk is not supported.)
- The device that is being shared must be connected to a built-in USB port on the host Macintosh computer.
- Both the host Macintosh computer and the client Macintosh computers that are using the shared device must have device sharing software installed, and the driver or PPD for the device that is installed. (You can run the installation program to install the device sharing software and associated Help files.)

For more information about USB device sharing, see the support information on the Apple Web site (www.apple.com) or the Apple Macintosh Help on the computer.

To share the device among computers

1. Open **System Preferences**, click **Print & Fax**, and then do one of the following, based on the operating system you are using:
 - **Mac OS X (v10.4)**: Click the **Sharing** tab, check the box next to **Share these printers with other computers**, and then select the printer to be shared.
 - **Mac OS X (v10.5)**: Select a printer, and then click **Share this printer**.
2. To print from the other Macintosh computers (the clients) on the network, do the following:
 - a. Click **File**, and then select **Page Setup** in the document you want to print.

 **NOTE:** Some Mac OS X (v10.5) applications do not have a **Page Setup** menu, it is included in the **Print** menu.

 - b. In the drop-down menu next to **Format for**, select **Shared Printers**, and then select your device.
 - c. Select the **Paper Size**, and then click **OK**.
 - d. In the document, click **File**, and then select **Print**.
 - e. From the drop-down menu next to **Printer**, select **Shared Printers**, and then select your device.
 - f. Make additional settings, if necessary, and then click **Print**.

Set up the device for wireless communication

You may set up the device for wireless communication using one of the following ways:

Setup method	Infrastructure wireless communication	Ad hoc wireless communication
USB cable	✓	✓

(continued)

For more information, see [To set up the device on a wireless communication using the installer \(Mac OS X\)](#) or [To set up wireless communication using the installer \(Windows\)](#).

 **NOTE:** If you encounter problems, see [Solve wireless problems](#).

To use the device with any wireless connection, you must run the installation program at least once from the Starter CD and create a wireless connection.

Make sure the device is not connected to the network using a network cable.

The sending device must have built-in 802.11 capabilities or an 802.11 wireless card installed.

The device and the computers that use it must be on the same subnet.

Before installing the device software, you may wish to find out the settings of your network. Obtain the information from your system administrators, or complete the following tasks:

- Obtain your network's network name or Service Set Identifier (SSID) and communication mode (infrastructure or ad hoc) from the configuration utility for the network's wireless access point (WAP) or the computer's network card.
- Find out the type of encryption your network uses, such as Wired Equivalent Privacy (WEP).
- Find out the security password or encryption key of the wireless device.

This section contains the following topics:

- [Understand 802.11 wireless network settings](#)
- [To set up wireless communication using the installer \(Windows\)](#)
- [To set up the device on a wireless communication using the installer \(Mac OS X\)](#)
- [Connect the device using an ad hoc wireless network connection](#)
- [To turn off wireless communication](#)
- [Configure your firewall to work with HP devices](#)
- [Change the connection method](#)
- [Guidelines for ensuring wireless network security](#)

Understand 802.11 wireless network settings

Network name (SSID)

By default, the device looks for the wireless network name or SSID named "hpsetup." Your network may have a different SSID.

Communication mode

There are two communication mode options:

- **Ad hoc:** On an ad hoc network, the device is set to ad hoc communication mode and communicates directly with other wireless devices without the use of a WAP. All devices on the ad hoc network must:
 - Be 802.11 compatible
 - Have ad hoc as the communication mode
 - Have the same network name (SSID)

- Be on the same subnet and same channel
- Have the same 802.11 security settings
- **Infrastructure (recommended):** On an infrastructure network, the device is set to infrastructure communication mode and communicates with other devices on the network, whether the devices are wired or wireless, through a WAP. WAPs commonly act as routers or gateways on small networks.

Security settings

 **NOTE:** For the available settings for the device, see [Understand the network configuration or wireless status report](#).

For more information on wireless security, visit www.wi-fi.org.

- **Network authentication:** The device's factory default setting is 'Open,' which does not require security for authorization or encryption. The other possible values are 'OpenThenShared,' 'Shared,' and 'WPA-PSK' (Wi-Fi® Protected Access Pre-Shared Key).

WPA increases the level of over-the-air data protection and access control on existing and future Wi-Fi networks. It addresses all known weaknesses of WEP, the original native security mechanism in the 802.11 standard.

WPA2 is the second generation of WPA security; it provides enterprise and consumer Wi-Fi users with a high level of assurance that only authorized users can access their wireless networks.

- **Data encryption:**
 - Wired Equivalent Privacy (WEP) provides security by encrypting data sent over radio waves from one wireless device to another wireless device. Devices on a WEP-enabled network use WEP keys to encode data. If your network uses WEP, you must know the WEP key(s) it uses.
 - WPA uses the Temporal Key Integrity Protocol (TKIP).
 - WPA2 provides a new encryption scheme, the Advanced Encryption Standard (AES). AES is defined in counter cipher-block chaining mode (CCM) and supports the Independent Basic Service Set (IBSS) to enable security between client workstations operating in ad hoc mode.

To set up wireless communication using the installer (Windows)

 **NOTE:** For this method, you will need to have a wireless network set up and running. You will also need a USB cable. Do not attach the USB cable until prompted by the installer.

1. Save any open documents. Close any applications that are running on your computer.
2. Insert the Starter CD into the CD drive. The CD menu runs automatically. If the CD menu does not start automatically, double-click the setup icon on the Starter CD.
3. On the CD menu, click **Install Network/Wireless Device**, and then follow the onscreen instructions.

 **NOTE:** If the firewall software on your computer displays any messages during the installation, select the "always permit/allow" option in the messages. Selecting this option allows the software to install successfully on your computer.

4. When prompted, temporarily connect the USB wireless setup cable.
5. Follow the onscreen instructions to complete the installation.
6. Disconnect the USB wireless setup cable when prompted.

To set up the device on a wireless communication using the installer (Mac OS X)



1. Connect a USB wireless setup cable to the port on the back of the HP device and then to any USB port on the computer.
2. Place the Starter CD into the computer.
3. Double-click the HP Installer icon on the Starter CD, and then follow the onscreen instructions.
4. Disconnect the USB wireless setup cable when prompted.

Connect the device using an ad hoc wireless network connection

Method 1

1. Turn on wireless in your computer and in the device.
2. On your computer, connect to the network name (SSID) "hpsetup". (This network name is the default, ad hoc network created by the HP device.)

 **NOTE:** If your HP device was previously configured for a different network, you can restore the network defaults to enable the device to use "hpsetup". To restore the network defaults complete the following steps:

Reset the administrator password and network settings: Press and hold the  **Network** button, (on some models press the **Wireless** button), press the  **Resume** button three times, and release the **Network** or **Wireless** button. For more information, see [Troubleshooting tips and resources](#).

To turn off wireless communication

Press and hold the wireless button on the front of the device for three seconds.

Configure your firewall to work with HP devices

A personal firewall, which is security software running on your computer, can block network communication between your HP device and your computer.

If you are having problems such as:

- Printer not found when installing HP software
- Unable to print, print job stuck in queue or printer goes offline
- Unable to see printer status on your computer

The firewall might be preventing your HP device from notifying computers on your network where it can be found. If the HP software cannot find the HP device during installation

(and you know the HP device is on the network), or you have already successfully installed HP software and experience problems, try the following:

1. If you are using a computer running Windows, in the firewall configuration utility, look for an option to trust computers on the local subnet (sometimes called the “scope” or “zone”). By trusting all computers on the local subnet, computers and devices in your home can communicate with each other while still being protected from the internet. This is the easiest approach to use.
2. If you do not have the option to trust computers on the local subnet, add incoming UDP port 427 to your firewall’s list of allowed ports.

 **NOTE:** Not all firewalls require you to differentiate between incoming and outgoing ports, but some do.

Another common problem is that HP software is not trusted by your firewall to access the network. This can happen if you answered “block” to any firewall dialog boxes that appeared when you installed the HP software.

If this occurs, and if you are using a computer running Windows, check that the following programs are in your firewall’s list of trusted applications; add any that are missing.

- **hpqkygrp.exe**, located in **C:\program files\HP\digital imaging\bin**
- **hpiscnapp.exe**, located in **C:\program files\HP\digital imaging\bin**
- **hpqste08.exe**, located in **C:\program files\HP\digital imaging\bin**
- **hpqtra08.exe**, located in **C:\program files\HP\digital imaging\bin**
- **hpqdirec.exe**, located in **C:\program files\HP\digital imaging\bin**
- **hpqthb08.exe**, located in **C:\program files\HP\digital imaging\bin**

 **NOTE:** Refer to your firewall documentation on how to configure the firewall port settings and how to add HP files to the “trusted” list.

NOTE: Some firewalls continue to cause interference even after you disable them. If you continue to have problems after configuring the firewall as described above and if you are using a computer running Windows, you might need to uninstall the firewall software in order to use the HP device over the network.

Change the connection method

If you have installed the software and connected your HP device using a USB or Ethernet cable, you can change to a wireless connection any time you want.

Change from a USB connection to a wireless connection (Windows)

1. Select **Start, Programs, HP**, select your device, and then select **Reconfigure Wireless Settings**.
2. Press **Add a Device**.
3. Follow the onscreen instructions and remove the USB cable when prompted.

Change from a USB connection to a wireless connection (Mac OS X)

1. Click the **HP Device Manager** icon on the Dock or in the Hewlett Packard folder in the Applications folder.
2. From the **Information and Settings** list, select **Network Printer Setup Utility**.
3. Follow the onscreen instructions to configure the network settings.

Change from an Ethernet connection to a wireless connection

 **NOTE:** For Ethernet-enabled HP devices only.

1. Open the embedded Web server (EWS). For more information, see [Embedded Web server](#).
2. Click the **Networking** tab, and then click **Wireless (802.11)** in the left pane.
3. On the **Wireless Setup** tab, press **Start Wizard**.
4. Follow the onscreen instructions to change from an Ethernet connection to a wireless connection.
5. After you finish changing the settings, disconnect the Ethernet cable.

Guidelines for ensuring wireless network security

This section contains the following topics:

- [To add hardware addresses to a wireless access point](#)
- [Other guidelines](#)

To add hardware addresses to a wireless access point

MAC filtering is a security feature in which a wireless access point, such as a wireless router or Apple AirPort Base Station is configured with a list of MAC addresses (also called "hardware addresses") of devices that are allowed to gain access to the network through the access point.

If the access point does not have the hardware address of a device attempting to access the network, the access point denies the device access to the network.

If the access point filters MAC addresses, then the device's MAC address must be added to the access point's list of accepted MAC addresses.

1. Print the wireless status report. For information on the wireless status report, see [Understand the network configuration or wireless status report](#).
2. Open the wireless access point's configuration utility, and add the HP device's hardware address to the list of accepted MAC addresses.

Other guidelines

To keep the wireless network secure, follow these guidelines:

- Use a password with at least 20 random characters. You can use up to 63 characters in a WPA password.
- Avoid any common words or phrases, easy sequences of characters (such as all 1s), and personally-identifiable information for passwords. Always use random strings composed of uppercase and lowercase letters, numbers, and if allowed, special characters such as punctuation.

- Change the password periodically.
- Change the default password provided by the manufacturer for administrator access to the access point or wireless router. Some routers let you change the administrator name as well.
- Turn off administrative access over wireless if possible. If you do this, you need to connect to the router with a wired Ethernet connection when you want to make configuration changes.
- Turn off remote administrative access over the Internet on your router, if possible. You can use Remote Desktop to make an encrypted connection to a computer running behind your router and make configuration changes from the local computer you are accessing over the Internet.
- To avoid accidentally connecting to another party's wireless network, turn off the setting to automatically connect to non-preferred networks. This is disabled by default in Windows XP.

Uninstall and reinstall the software

If your installation is incomplete, or if you connected the USB cable to the computer before prompted by the software installation screen, you might need to uninstall and then reinstall the software. Do not simply delete the device application files from your computer. Make sure to remove them properly using the uninstall utility provided when you installed the software that came with the device.

There are three methods to uninstall the software on a Windows computer, and two methods to uninstall on a Macintosh computer.

To uninstall from a Windows computer, method 1

1. Disconnect the device from your computer. Do not connect it to your computer until after you have reinstalled the software.
2. Press the **Power** button to turn off the device.
3. On the Windows taskbar, click **Start**, select **Settings**, select **Control Panel**, and then click **Add/Remove Programs**.
- Or -
Click **Start**, click **Control Panel**, and then double-click **Programs and Features**.
4. Select the device you want to uninstall, and then click **Change/Remove** or **Uninstall/Change**.
5. Follow the onscreen instructions.
6. If you are asked whether you would like to remove shared files, click **No**. Other programs that use these files might not work properly if the files are deleted.
7. Restart your computer.
8. To reinstall the software, insert the device Starter CD into your computer's CD-ROM drive, follow the onscreen instructions, and also see [To install the software before connecting the device \(recommended\)](#).
9. After the software is installed, connect the device to your computer.

10. Press the **Power** button to turn the device on.

After connecting and turning on the device, you might have to wait several minutes for all of the Plug and Play events to complete.

11. Follow the onscreen instructions.

When the software installation is complete, the **HP Digital Imaging Monitor** icon appears in the Windows system tray.

To uninstall from a Windows computer, method 2

 **NOTE:** Use this method if **Uninstall** is not available in the Windows Start menu.

1. On the Windows taskbar, click **Start**, select **Settings**, select **Control Panel**, and then click **Add/Remove Programs**.
- Or -
Click **Start**, click **Control Panel**, and then double-click **Programs and Features**.
 2. Select the device you want to uninstall, and then click **Change/Remove** or **Uninstall/Change**.
 3. Disconnect the device from your computer.
 4. Restart your computer.
-

 **NOTE:** It is important that you disconnect the device before restarting your computer. Do not connect the device to your computer until after you have reinstalled the software.

5. Insert the device Starter CD into your computer's CD-ROM drive and then start the Setup program.
6. Follow the onscreen instructions and also see [To install the software before connecting the device \(recommended\)](#).

To uninstall from a Windows computer, method 3

 **NOTE:** Use this method if **Uninstall** is not available in the Windows Start menu.

1. Insert the device Starter CD into your computer's CD-ROM drive, and then start the Setup program.
 2. Disconnect the device from your computer.
 3. Select **Uninstall** and follow the onscreen directions.
 4. Restart your computer.
-

 **NOTE:** It is important that you disconnect the device before restarting your computer. Do not connect the device to your computer until after you have reinstalled the software.

5. Start the Setup program for the device again.
6. Select **Install**.
7. Follow the onscreen instructions and also see [To install the software before connecting the device \(recommended\)](#).

To uninstall from a Macintosh computer, method 1

1. Launch **HP Device Manager**.
2. Click **Information and Settings**.
3. Select **Uninstall HP software** from the pull-down menu.
Follow the onscreen instructions.
4. After the software is uninstalled, restart your computer.
5. To reinstall the software, insert the device Starter CD into your computer's CD-ROM drive.
6. On the desktop, open the CD-ROM, and then double-click **HP Printer Installer**.
7. Follow the onscreen instructions and also see [To install the software before connecting the device \(recommended\)](#).

To uninstall from a Macintosh computer, method 2

1. Open the Finder.
2. Double-click **Applications**.
3. Double-click **Hewlett-Packard**.
4. Double-click **HP Uninstaller**.
5. Select your device, and then double-click **Uninstall**.

5 Maintain and troubleshoot

This section contains the following topics:

- [Work with ink cartridges](#)
- [Print and evaluate a print quality report](#)
- [Troubleshooting tips and resources](#)
- [Solve printing problems](#)
- [Print troubleshooting](#)
- [Print quality troubleshooting](#)
- [Solve paper-feed problems](#)
- [Solve device management problems](#)
- [Solve network problems](#)
- [Solve wireless problems](#)
- [Troubleshoot installation issues](#)
- [Clear jams](#)
- [Errors \(Windows\)](#)

Work with ink cartridges

To ensure the best print quality from the HP Printer, you will need to perform some simple maintenance procedures. This section provides guidelines for handling the ink cartridges, instructions for replacing the ink cartridges, and cleaning the printhead.

This section contains the following topics:

- [Information on ink cartridges and the printhead](#)
- [Check the estimated ink levels](#)
- [Replace the ink cartridges](#)
- [Usage information collection](#)

Information on ink cartridges and the printhead

The following tips help maintain HP ink cartridges and ensure consistent print quality.

- The instructions in this user guide are for replacing ink cartridges, and are not intended for first time installation.
- If you need to replace an ink cartridge, wait until you have the new ink cartridge available to install before removing the old cartridge.

△ **CAUTION:** Wait until you have a new ink cartridge available before removing the old ink cartridge. Do not leave the ink cartridge outside of the product for an extended period of time. This can result in damage to both the product and the ink cartridge.

- Keep all ink cartridges in the original sealed packages until they are needed.
- Store ink cartridges in the same orientation packages hang on store shelves or, if out of box, with label facing down.

- Turn off the HP Printer by pressing the **Power** button located on the product. Wait until the **Power** light turns off before unplugging the power cord or turning off a power strip. If you improperly turn off the HP Printer, the print carriage might not return to the correct position causing problems with the ink cartridges and print quality issues.
- Store ink cartridges at room temperature (15-35° C or 59-95° F).
- You do not need to replace the cartridges until print quality becomes unacceptable, but a significant decrease in print quality may be the result of one or more depleted cartridges. It could also be caused by a clogged printhead. Possible solutions include checking the estimated ink levels remaining in the cartridges, and cleaning the printhead. Cleaning the printhead will use some ink.
- Do not clean the printhead unnecessarily. This wastes ink and shortens the life of the cartridges.
- Handle ink cartridges carefully. Dropping, jarring, or rough handling during installation can cause temporary printing problems.
- If you are transporting the product, do the following to prevent ink leaking from the print carriage or other damage from occurring to the product:
 - Make sure you turn off the product by pressing the **Power** button. The print carriage should be parked on the right side in the service station.
 - Make sure you leave the ink cartridges and printhead installed.
 - Lightly pack the inside of the product with crumpled newspaper to prevent the print carriage from moving during transportation.
 - The product must be transported sitting flat; it should not be placed its side, back, front, or top.

Related topics

- [Check the estimated ink levels](#)
- [Clean the printhead](#)

Check the estimated ink levels

You can check the estimated ink levels from the HP Solution Center, Toolbox (Windows), the HP Printer Utility (Mac OS X), or the embedded Web server. For information about using these tools, see [Use device management tools](#). You can also print the Printer Status page to view this information (see [Understand the printer status page](#)).

 **NOTE:** Ink level alerts and indicators provide estimates for planning purposes only. When you receive a low-ink alert, consider having a replacement cartridge available to avoid possible printing delays. You do not have to replace the cartridges until the print quality is unacceptable.

NOTE: If you have installed a refilled or remanufactured cartridge, or a cartridge that has been used in another printer, the ink level indicator might be inaccurate or unavailable.

NOTE: Ink from the cartridges is used in the printing process in a number of different ways, including in the initialization process, which prepares the product and cartridges for printing, and in printhead servicing, which keeps print nozzles clear and ink flowing smoothly. In addition, some residual ink is left in the cartridge after it is used. For more information, see www.hp.com/go/inkusage.

Replace the ink cartridges

 **NOTE:** For information on recycling used ink supplies, see [HP inkjet supplies recycling program](#).

If you do not already have replacement ink cartridges for the HP Printer, see [Order printing supplies online](#).

 **NOTE:** At this time, some portions of the HP Web site are available in English only.

 **CAUTION:** Wait until you have a new ink cartridge available before removing the old ink cartridge. Do not leave the ink cartridge outside of the product for an extended period of time. This can result in damage to both the product and the ink cartridge.

To replace the ink cartridges

1. Make sure the product is turned on.
2. Open the ink cartridge access door.
The print carriage moves to the center of the product.

 **NOTE:** Wait until the print carriage stops moving before proceeding.

3. Press the tab on the front of the ink cartridge to release it, and then remove it from the slot.

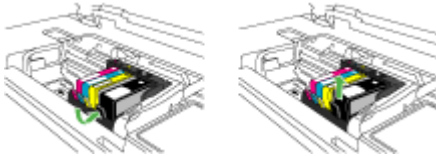

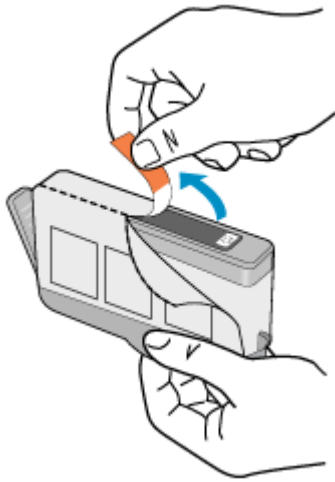

4. Remove the new ink cartridge from its packaging by pulling the orange pull-tab straight back to remove the plastic wrap from the ink cartridge.

 **NOTE:** Make sure you remove the plastic wrap from the ink cartridge before installing it in the product, or printing will fail.

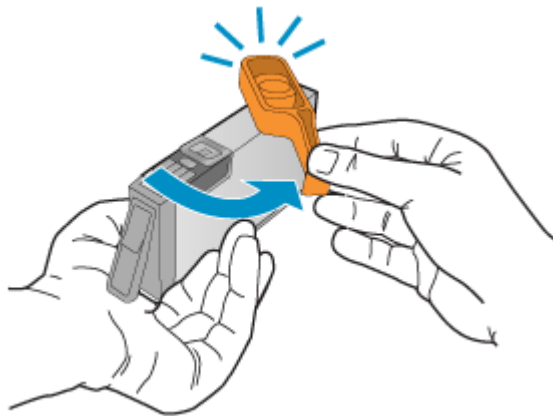

5. Twist the orange cap to snap it off.



 **NOTE:** Make sure the plastic tab is entirely removed and that the label is slightly torn, revealing the vent channel.

6. Using the colored shaped icons for help, slide the ink cartridge into the empty slot until it clicks into place and is seated firmly in the slot.

 **CAUTION:** Do not lift the latch handle on the print carriage to install the ink cartridges. Doing so can result in incorrectly seated ink cartridges and printing problems. The latch must remain down in order to correctly install the ink cartridges.

Make sure that you insert the ink cartridge into the slot that has the same shaped icon and color as the one you are installing.

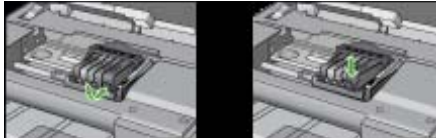

7. Repeat steps 3 through 6 for each ink cartridge you are replacing.
8. Close the ink cartridge door.

Related topics

[Order printing supplies online](#)

Usage information collection

The HP cartridges used with this product contain a memory chip that assists in the operation of the product.

In addition, this memory chip collects a limited set of information about the usage of the product, which might include the following: the date when the cartridge was first installed, the date when the cartridge was last used, the number of pages printed using the cartridge, the page coverage, the printing modes used, any printing errors that might have occurred, and the product model. This information helps HP design future products to meet our customers' printing needs.

The data collected from the cartridge memory chip does not contain information that can be used to identify a customer or user of the cartridge or their product.

HP collects a sampling of the memory chips from cartridges returned to HP's free return and recycling program (HP Planet Partners: www.hp.com/recycle). The memory chips from this sampling are read and studied in order to improve future HP products. HP partners who assist in recycling this cartridge might have access to this data, as well.

Any third party possessing the cartridge might have access to the anonymous information on the memory chip. If you prefer to not allow access to this information, you can render the chip inoperable. However, after you render the memory chip inoperable, the cartridge cannot be used in an HP product.

If you are concerned about providing this anonymous information, you can make this information inaccessible by turning off the memory chip's ability to collect the product's usage information:

To turn off usage information collection

- ▲ On the product control panel, press and hold the **Resume** button and **Network** button (on some models, press the **Wireless** button) until the ink cartridge lights blink, approximately five seconds, and then release the buttons.

 **NOTE:** If you turn off the memory chip's ability to collect the product's usage information, you can still continue to use the cartridge in the HP product.





Print and evaluate a print quality report

Print quality problems can have many causes: software settings, a poor image file, or the printing system itself. If you are unhappy with the quality of your prints, a Print Quality Diagnostic page can help you determine if the printing system is working properly.

This section includes the following topics:

- [To print a print quality report](#)
- [To evaluate the Print Quality Diagnostic Page](#)

To print a print quality report

- **Control panel:** Press and hold the  **Power** button, press the  **Cancel** button seven times, press the  **Resume** button two times, and release the  **Power** button.
- **Embedded Web server:** Click the **Settings** tab, click **Device Services** in the left pane, select **Print PQ (print quality) diagnostic page** from the drop-down list in the **Print Quality** section, and then click **Run Diagnostic**.
- **HP Toolbox (Windows):** Click the **Device Services** tab, and then click **Print PQ (print quality) diagnostic page** and follow the onscreen instructions.
- **HP Printer Utility (Mac OS X):** Click **Print Quality Diagnostics** from the **Information and Support** panel, and then click **Print Page**.



To evaluate the Print Quality Diagnostic Page

This section includes the following topics:

- [Ink Levels](#)
- [Good color bars](#)
- [Ragged, irregularly streaked, or faded bars](#)
- [Regular white streaks in the bars](#)
- [Bar colors are not uniform](#)
- [Large Black Font Text](#)
- [Alignment Patterns](#)
- [If you see no defects](#)

Ink Levels

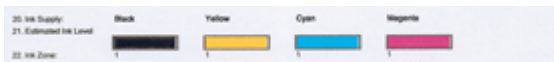

- ▲ Look at the Ink Level indicators in Line 21. If any of the bar level indicators are low, you may need to replace that ink cartridge.



NOTE: Ink level warnings and indicators provide estimates for planning purposes only. When you receive an ink alert message, consider having a replacement cartridge available to avoid possible printing delays. You do not need to replace cartridges until print quality becomes unacceptable.

Good color bars



Example of Good Color Bars

All seven bars are solid, sharp-edged, and extend with uniform color all the way across the page - the printer is operating correctly.

- ▲ Look at the color bars in the middle of the page. There should be seven color bars. The color bars should have sharp edges. They should be solid (not streaked with white or other colors). They should be uniform in color throughout. The bars correspond to the ink cartridges in the printer as follows:

Item	Cartridge color
1	Black Ink Cartridge
2	Cyan Ink Cartridge

Item	Cartridge color
3	Magenta Ink Cartridge
4	Yellow Ink Cartridge

Ragged, irregularly streaked, or faded bars



Example of Bad Color Bars	The top bar is irregularly streaked or fading.
---------------------------	--



Example of Bad Color Bars	The top black bar is ragged on one end.
---------------------------	---

If any of the bars are ragged, irregularly streaked, or faded, follow these steps:

1. Make sure the ink cartridges have ink.
2. Remove the cartridge corresponding to the streaked bar and make sure it is properly vented. For more information, see [Replace the ink cartridges](#).
3. Reinstall the cartridge and make sure all the cartridges are properly latched. For more information, see [Replace the ink cartridges](#)
4. Clean the printhead. For more information, see [Clean the printhead](#)
5. Try another print or reprint the Print Quality Diagnostic report. If the problem still occurs, but cleaning seems to have helped, clean again.
6. If cleaning does not solve the problem, replace the cartridge that corresponds to the ragged bar.
7. If replacing the ink cartridge does not help, contact HP - the printhead may need to be replaced.

Preventing the problem that causes ragged bars on the Print Quality Diagnostic report:

- Avoid leaving opened ink cartridges outside of the printer for an extended period of time.
- Wait until a new cartridge is ready to be installed before removing an old ink cartridge.

Regular white streaks in the bars

If any of the color bars show regular white streaks, follow these steps:

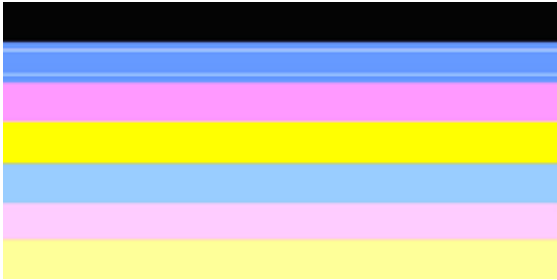

White streaks	The print quality bars have white streaks in them.
---------------	--

1. If item 11 on the Print Quality Diagnostic report reads **PHATTOE = 0**, align the printer. For more information, see [Align the printhead](#).
2. If item 11 is not 0, or aligning does not help, clean the printhead. For more information, see [Clean the printhead](#).
3. Print another Print Quality Diagnostic report. If the streaking is still there, but seems better, try another cleaning. If the streaking gets worse, contact HP - the printhead may need to be replaced.

Bar colors are not uniform

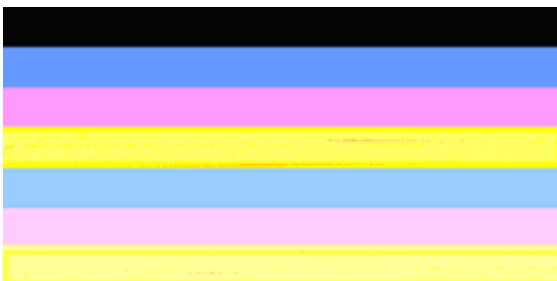

Print quality bars are not uniform	The bars have lighter or darker portions in them.
------------------------------------	---

If the color of any of the bars is not uniform, follow these steps:

1. If the printer was recently transported at a high altitude, try a printhead cleaning.
2. If the printer was not recently transported, try printing another Print Quality Diagnostic report. This will use less ink than a printhead cleaning, but if it is not effective, try a cleaning.
3. Retry the Print Quality Diagnostic report. If the colors seem to be improving, continue cleaning. If the colors get worse, contact HP - the printhead may need to be replaced.

Large Black Font Text

Look at the large-font text above the color blocks. **I ABCDEFG abcdefg** The type should be sharp and clear. If the type is jagged, try aligning the printer. If there are streaks or smears of ink, clean the printhead.

I ABCDEFG abcdefg

Example of good Large-Font Type	The letters are sharp and clear - the printer is operating correctly.
---------------------------------	---

I ABCDEFG abcdefg

Example of bad Large-Font Type	The letters are jagged - align the printer.
--------------------------------	---

I ABCDEFG abcdefg

Example of bad Large-Font Type	The letters are smeared - clean the printhead and check if the paper is curled. To avoid curl, store all paper flat in a resealable bag.
--------------------------------	--

I ABCDEFG abcdefg

Example of bad Large-Font Type	The letters are ragged on one end - clean the printer. If this defect occurs right after a new cartridge is installed, the printer's automatic servicing routines may solve the problem in a day or so, using less ink than a printhead cleaning.
--------------------------------	---

Alignment Patterns

If the color bars and large font text look OK, and the ink cartridges are not empty, look at the alignment pattern directly above the color bars.

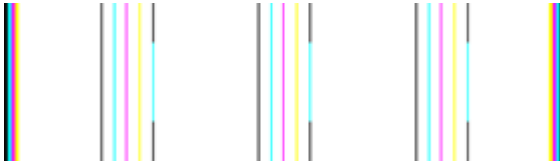

Example of a good alignment pattern	The lines are straight.
-------------------------------------	-------------------------

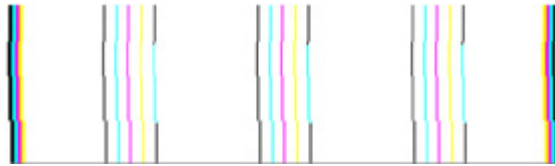

Examples of a bad alignment pattern	The lines are jagged - align the printer. If that does not work, contact HP.
-------------------------------------	--

If you see no defects

If you do not see any defects on the print quality report, then the printing system is working correctly. There is no reason to replace supplies or have the product serviced, because they are functioning properly. If you still have a print quality problem, here are some other things you can check:

- Check the paper.
- Check the print settings.
- Make sure your image has sufficient resolution.
- If the problem seems confined to a band near the edge of your printout, use the software you installed with the product or another software application to rotate the image 180 degrees. The problem might not appear on the other end of the print.

Troubleshooting tips and resources

Use the following tips and resources to resolve printing problems.

- For a paper jam, see [Clear a jam in the device](#).
- For paper-feed problems, such as the paper skew and paper pick, see [Solve paper-feed problems](#).
- Power light is on and not blinking. When the device is turned on for the first time, it takes approximately 12 minutes to initialize.
- Make sure the device is in the ready state. If lights are on or blinking, see [Control-panel lights reference](#).
- No error messages appear on the computer screen.

- Power cord and other cables are working, and are firmly connected to the device. Make sure the device is connected firmly to a functioning alternating current (AC) power outlet, and is turned on. For voltage requirements, see [Electrical specifications](#).
- Media is loaded correctly in the tray and is not jammed in the device.
- Printhead and ink cartridges are properly installed in their correct color-coded slots. Press down firmly on each one to ensure proper contact.
- All latches and covers are closed.
- The rear access panel or optional duplexer is locked into place.
- All packing tapes and materials are removed.
- The device can print a printer status page. For more information, see [Understand the printer status page](#).
- The device is set as the current or default printer. For Windows, set it as the default in the Printers folder. For Mac OS X, set it as the default in the Printer Setup Utility (Mac OS X (v10.4). For Mac OS X (v10.5) open **System Preferences**, select **Print & Fax**, and then select the device from the **Default Printer** drop-down list. See your computer's documentation for more information.
- **Pause Printing** is not selected if you are using a computer running Windows.
- You are not running too many programs when you are performing a task. Close programs that you are not using or restart the computer before attempting the task again.

Some problems can be resolved by resetting the device.

Solve printing problems

This section contains the following topics:

- [The device shuts down unexpectedly](#)
- [Device takes a long time to print](#)
- [Blank or partial page printed](#)
- [Something on the page is missing or incorrect](#)
- [Placement of the text or graphics is wrong](#)

The device shuts down unexpectedly

Check the power and power connections

Make sure the device is connected firmly to a functioning alternating current (AC) power outlet. For voltage requirements, see [Electrical specifications](#).

Device takes a long time to print

Check the system configuration and resources

Make sure the computer meets the minimum system requirements for the device. For more information, see [System requirements](#).

Check the device software settings

Print speed is slower when **Best** or **Maximum dpi** is selected as the print quality. To increase the print speed, select different print settings in the device driver. For more information, see [Change print settings](#).

Low ink levels

Check the estimated ink levels in the ink cartridges.

 **NOTE:** Ink level alerts and indicators provide estimates for planning purposes only. When you receive a low-ink alert, consider having a replacement cartridge available to avoid possible printing delays. You do not need to replace the ink cartridges until print quality becomes unacceptable.

The ink cartridges might have insufficient ink. Insufficient ink may cause the printhead to overheat. When the printhead overheats, the printer slows down to allow it to cool.

Blank or partial page printed

Check the ink levels

The ink cartridges may be running low on ink.

Clean the printhead

Complete the printhead cleaning procedure. For more information, see [Clean the printhead](#). The printhead may need to be cleaned if the printer was turned off improperly.

 **NOTE:** Turn off the HP Printer by pressing the **Power** button located on the product. Wait until the **Power** light turns off before unplugging the power cord or turning off a power strip. If you improperly turn off the HP Printer, the print carriage might not return to the correct position causing problems with the ink cartridges and print quality issues.

Check the media settings

- Make sure you select the correct print quality settings in the printer driver for the media loaded in the trays.
- Make sure the page settings in the printer driver match the page size of media loaded in the tray.

More than one page is being picked

For more information on paper-feed problems, see [Solve paper-feed problems](#).

There is a blank page in the file

Check the file to make sure there is no blank page.

Something on the page is missing or incorrect

Check the ink cartridges

Make sure the correct ink cartridges are installed and the ink cartridges are not low on ink. For more information, see [Manage the device](#) and [Check the estimated ink levels](#).

Check the margin settings

Make sure the margin settings for the document do not exceed the printable area of the device. For more information, see [Set minimum margins](#).

Check the color print settings

Make sure **Print in Grayscale** is not selected in the print driver.

Check the device location and length of USB cable

High electromagnetic fields (such as those generated by USB cables) can sometimes cause slight distortions to printouts. Move the device away from the source of the electromagnetic fields. Also, it is recommended that you use a USB cable that is less than 3 meters (9.8 feet) long to minimize the effects of these electromagnetic fields.

Placement of the text or graphics is wrong

Check how the media is loaded

Make sure the media width and length guides fit snugly against the edges of the stack of media, and make sure the tray is not overloaded. For more information, see [Load media](#).

Check the media size

- Content on a page might be cut off if the document size is larger than the media that you are using.
- Make sure the media size selected in the printer driver match the size of media loaded in the tray.

Check the margin settings

If the text or graphics are cut off at the edges of the page, make sure the margin settings for the document do not exceed the printable area of your device. For more information, see [Set minimum margins](#).

Check the page-orientation setting

Make sure the media size and page orientation selected in the application match the settings in the printer driver. For more information, see [Change print settings](#).

Check the device location and length of USB cable

High electromagnetic fields (such as those generated by USB cables) can sometimes cause slight distortions to printouts. Move the device away from the source of the electromagnetic fields. Also, it is recommended that you use a USB cable that is less than 3 meters (9.8 feet) long to minimize the effects of these electromagnetic fields.

If the above solutions do not work, the problem may be caused by the inability of the application to interpret print settings properly. See the release notes for known software conflicts, refer to the application's documentation, or contact the software manufacturer for specific help.

Print troubleshooting

Use this section to solve these printing problems:

- [Envelopes print incorrectly](#)
- [Borderless printing produces unexpected results](#)
- [The product is not responding](#)
- [The product prints meaningless characters](#)
- [Nothing happens when I try to print](#)
- [The pages in my document came out in the wrong order](#)
- [The margins are not printing as expected](#)
- [Text or graphics are cut off at the edge of the page](#)
- [A blank page came out while printing](#)

Envelopes print incorrectly

Try the following solutions to resolve the issue. Solutions are listed in order, with the most likely solution first. If the first solution does not solve the problem, continue trying the remaining solutions until the issue is resolved.

- [Solution 1: Load the stack of envelopes correctly](#)
- [Solution 2: Check the envelope type](#)
- [Solution 3: Tuck the flaps to avoid paper jams](#)

Solution 1: Load the stack of envelopes correctly

Solution: Load a stack of envelopes in the input tray, with the envelope flaps facing up and to the left.

Make sure that you remove all paper from the input tray before loading the envelopes.

Cause: A stack of envelopes was loaded incorrectly.

If this did not solve the issue, try the next solution.

Solution 2: Check the envelope type

Solution: Do not use shiny or embossed envelopes or envelopes that have clasps or windows.

Cause: The wrong type of envelope was loaded.

If this did not solve the issue, try the next solution.

Solution 3: Tuck the flaps to avoid paper jams

Solution: To avoid paper jams, tuck the flaps inside the envelopes.

Cause: The flaps might get caught in the rollers.

Borderless printing produces unexpected results

Solution: Try printing the image from the photo imaging software that came with the product.

Cause: Printing a borderless image from a non-HP software application produced unexpected results.

The product is not responding

Try the following solutions to resolve the issue. Solutions are listed in order, with the most likely solution first. If the first solution does not solve the problem, continue trying the remaining solutions until the issue is resolved.

- [Solution 1: Turn on the product](#)
- [Solution 2: Load paper in the input tray](#)
- [Solution 3: Select the correct printer](#)
- [Solution 4: Check the printer driver status](#)
- [Solution 5: Wait until the product completes the current operation](#)
- [Solution 6: Remove all cancelled print jobs from the queue](#)
- [Solution 7: Clear the paper jam](#)
- [Solution 8: Make sure the print carriage can move freely](#)
- [Solution 9: Check the connection from the product to your computer](#)
- [Solution 10: Restart the product](#)

Solution 1: Turn on the product

Solution: Look at the **Power** light located on the product. If it is not lit, the product is turned off. Make sure the power cord is firmly connected to the product and plugged into a power outlet. Press the **Power** button to turn on the product.

Cause: The product was turned off.

If this did not solve the issue, try the next solution.

Solution 2: Load paper in the input tray

Solution: Load paper in the input tray.

For more information, see:

[Load media](#)

Cause: The product was out of paper.

If this did not solve the issue, try the next solution.

Solution 3: Select the correct printer

Solution: Make sure you have selected the correct printer in your software application.

 **TIP:** You can set the product as the default printer to ensure that the printer is automatically selected when you select **Print** in the **File** menu of your different software applications.

Cause: The product was not the selected printer.

If this did not solve the issue, try the next solution.

Solution 4: Check the printer driver status

Solution: The printer driver status might have changed to either **offline** or **stop printing**.

To check the printer driver status

▲ In the HP Solution Center, click the **Status** tab.

Cause: The status of the printer driver had changed.

If this did not solve the issue, try the next solution.

Solution 5: Wait until the product completes the current operation

Solution: If the product is performing another task your print job will be delayed until the product completes the current task.

Some documents take a long time to print. If nothing has printed several minutes after you sent a print job to the product, check the control panel to see if there are any errors.

Cause: The product was busy with another task.

If this did not solve the issue, try the next solution.

Solution 6: Remove all cancelled print jobs from the queue

Solution: A print job might remain in the queue after it has been cancelled. The cancelled print job jams the queue and prevents the next print job from printing.

From your computer, open the printer folder and see if the cancelled job remains in the print queue. Try to delete the job from the queue. If the print job remains in the queue, try one or both of the following:

- Disconnect the USB cable from the product, restart the computer, and then reconnect the USB cable to the product.
- Shut down the product, restart the computer, and then restart the product.

Cause: A deleted print job was in the queue.

If this did not solve the issue, try the next solution.

Solution 7: Clear the paper jam

Solution: Clear the paper jam and remove any torn paper that remains in the product.

For more information, see:

[Clear jams](#)

Cause: The product had a paper jam.

If this did not solve the issue, try the next solution.

Solution 8: Make sure the print carriage can move freely

Solution: Unplug the power cable if it is not already unplugged. Check to see if the print carriage will move freely from one side of the printer to the other. Do not try to force it to move if it is hung up on something.

△ **CAUTION:** Be careful not to force the print carriage. If the carriage is stuck, forcing it to move will damage the printer.

Cause: The print carriage had stalled.

If this did not solve the issue, try the next solution.

Solution 9: Check the connection from the product to your computer

Solution: Check the connection from the product to your computer. Verify that the USB cable is securely plugged into the USB port on the back of the product. Make sure the other end of the USB cable is plugged into a USB port on your computer. After the cable is connected properly, turn off the product and then on again. If the product is connected to the computer through a wired, wireless, make sure that the respective connections are active and the product is turned on.

If the connections are secure, and nothing has printed several minutes after you sent a print job to the product, check the status of the product. In the HP Solution Center Software, click **Settings**, and then click **Status**.

Cause: The computer was not communicating with the product.

If this did not solve the issue, try the next solution.

Solution 10: Restart the product

Solution: Turn off the product, and then unplug the power cord. Plug the power cord back in, and then press the **Power** button to turn on the product.

Cause: The product experienced an error.

The product prints meaningless characters

Try the following solutions to resolve the issue. Solutions are listed in order, with the most likely solution first. If the first solution does not solve the problem, continue trying the remaining solutions until the issue is resolved.

- [Solution 1: Restart the product](#)
- [Solution 2: Print a previously saved version of the document](#)

Solution 1: Restart the product

Solution: Turn off the product and your computer for 60 seconds, then turn them both on and try printing again.

Cause: There was no available memory in the product.

If this did not solve the issue, try the next solution.

Solution 2: Print a previously saved version of the document

Solution: Try printing another document from the same software application. If this works, then try printing a previously saved version of the document that is not corrupt.

Cause: The document was corrupt.

Nothing happens when I try to print

Try the following solutions to resolve the issue. Solutions are listed in order, with the most likely solution first. If the first solution does not solve the problem, continue trying the remaining solutions until the issue is resolved.

- [Solution 1: Turn on the product](#)
- [Solution 2: Load paper in the input tray](#)
- [Solution 3: Select the correct printer](#)
- [Solution 4: Check the printer driver status](#)
- [Solution 5: Wait until the product completes the current operation](#)
- [Solution 6: Remove all cancelled print jobs from the queue](#)
- [Solution 7: Clear the paper jam](#)
- [Solution 8: Make sure the print carriage can move freely](#)
- [Solution 9: Check the connection from the product to your computer](#)
- [Solution 10: Restart the product](#)

Solution 1: Turn on the product

Solution: Look at the **Power** light located on the product. If it is not lit, the product is turned off. Make sure the power cord is firmly connected to the product and plugged into a power outlet. Press the **Power** button to turn on the product.

Cause: The product was turned off.

If this did not solve the issue, try the next solution.

Solution 2: Load paper in the input tray

Solution: Load paper in the input tray.

For more information, see:

[Load media](#)

Cause: The product was out of paper.

If this did not solve the issue, try the next solution.

Solution 3: Select the correct printer

Solution: Make sure you have selected the correct printer in your software application.

 **TIP:** You can set the product as the default printer to ensure that the printer is automatically selected when you select **Print** in the **File** menu of your different software applications.

Cause: The product was not the selected printer.

If this did not solve the issue, try the next solution.

Solution 4: Check the printer driver status

Solution: The printer driver status might have changed to either **offline** or **stop printing**.

To check the printer driver status

▲ In the HP Solution Center, click the **Status** tab.

Cause: The status of the printer driver had changed.

If this did not solve the issue, try the next solution.

Solution 5: Wait until the product completes the current operation

Solution: If the product is performing another task your print job will be delayed until the product completes the current task.

Some documents take a long time to print. If nothing has printed several minutes after you sent a print job to the product, check the control panel to see if there are any errors.

Cause: The product was busy with another task.

If this did not solve the issue, try the next solution.

Solution 6: Remove all cancelled print jobs from the queue

Solution: A print job might remain in the queue after it has been cancelled. The cancelled print job jams the queue and prevents the next print job from printing.

From your computer, open the printer folder and see if the cancelled job remains in the print queue. Try to delete the job from the queue. If the print job remains in the queue, try one or both of the following:

- Disconnect the USB cable from the product, restart the computer, and then reconnect the USB cable to the product.
- Shut down the product, restart the computer, and then restart the product.

Cause: A deleted print job was in the queue.

If this did not solve the issue, try the next solution.

Solution 7: Clear the paper jam

Solution: Clear the paper jam and remove any torn paper that remains in the product.

For more information, see:

[Clear jams](#)

Cause: The product had a paper jam.

If this did not solve the issue, try the next solution.

Solution 8: Make sure the print carriage can move freely

Solution: Unplug the power cable if it is not already unplugged. Check to see if the print carriage will move freely from one side of the printer to the other. Do not try to force it to move if it is hung up on something.

 **CAUTION:** Be careful not to force the print carriage. If the carriage is stuck, forcing it to move will damage the printer.

Cause: The print carriage had stalled.

If this did not solve the issue, try the next solution.

Solution 9: Check the connection from the product to your computer

Solution: Check the connection from the product to your computer. Verify that the USB cable is securely plugged into the USB port on the back of the product. Make sure the other end of the USB cable is plugged into a USB port on your computer. After the cable is connected properly, turn off the product and then on again. If the product is connected to the computer through a wired, wireless, make sure that the respective connections are active and the product is turned on.

If the connections are secure, and nothing has printed several minutes after you sent a print job to the product, check the status of the product. In the HP Solution Center software, click **Settings**, and then click **Status**.

Cause: The computer was not communicating with the product.

If this did not solve the issue, try the next solution.

Solution 10: Restart the product

Solution: Turn off the product, and then unplug the power cord. Plug the power cord back in, and then press the **Power** button to turn on the product.

Cause: The product experienced an error.

The pages in my document came out in the wrong order

Solution: Print the document in reverse order. When the document finishes printing, the pages will be in correct order.

Cause: The print settings were set to print the first page of your document first. Because of the way the paper feeds through the product, the first page will be print side up at the bottom of the stack.

The margins are not printing as expected

Try the following solutions to resolve the issue. Solutions are listed in order, with the most likely solution first. If the first solution does not solve the problem, continue trying the remaining solutions until the issue is resolved.

- [Solution 1: Check the printer margins](#)
- [Solution 2: Verify the paper size setting](#)
- [Solution 3: Load the stack of paper correctly](#)

Solution 1: Check the printer margins

Solution: Check the printer margins.

Make sure the margin settings for the document do not exceed the printable area of the product.

To check your margin settings

1. Preview your print job before sending it to the product.
In most software applications, click the **File** menu, and then click **Print Preview**.
2. Check the margins.
The product uses the margins you have set in your software application, as long as they are greater than the minimum margins the product supports. For more information about setting margins in your software application, see the documentation that came with the software.
3. Cancel the print job if the margins are not satisfactory, and then adjust the margins in your software application.

Cause: The margins were not set correctly in your software application.

If this did not solve the issue, try the next solution.

Solution 2: Verify the paper size setting

Solution: Verify that you have selected the proper paper size setting for your project. Make sure that you have loaded the correct paper size in the input tray.

Cause: The paper size setting might not have been set correctly for the project you were printing.

If this did not solve the issue, try the next solution.

Solution 3: Load the stack of paper correctly

Solution: Remove the stack of paper from the input tray, reload the paper, and then slide the paper width guide inward until it stops at the edge of the paper.

For more information, see:

[Load media](#)

Cause: The paper guides were not positioned correctly.

Text or graphics are cut off at the edge of the page

Try the following solutions to resolve the issue. Solutions are listed in order, with the most likely solution first. If the first solution does not solve the problem, continue trying the remaining solutions until the issue is resolved.

- [Solution 1: Check the margin settings](#)
- [Solution 2: Check the layout of the document](#)
- [Solution 3: Load the stack of papers correctly](#)
- [Solution 4: Try printing with borders](#)

Solution 1: Check the margin settings

Solution: Check the printer margins.

Make sure the margin settings for the document do not exceed the printable area of the product.

To check your margin settings

1. Preview your print job before sending it to the product.
In most software applications, click the **File** menu, and then click **Print Preview**.
2. Check the margins.
The product uses the margins you have set in your software application, as long as they are greater than the minimum margins the product supports. For more information about setting margins in your software application, see the documentation that came with the software.
3. Cancel the print job if the margins are not satisfactory, and then adjust the margins in your software application.

Cause: The margins were not set correctly in your software application.

If this did not solve the issue, try the next solution.

Solution 2: Check the layout of the document

Solution: Make sure the layout of the document you are trying to print fits on a paper size supported by the product.

To preview the print layout

1. Load the correct paper size into the input tray.
2. Preview your print job before sending it to the product.
In most software applications, click the **File** menu, and then click **Print Preview**.
3. Check the graphics in the document to make sure that the current size fits within the printable area of the product.
4. Cancel the print job if the graphics do not fit in the printable area of the page.

 **TIP:** Some software applications allow you to scale the document to fit the paper size currently selected. Additionally, you can scale the size of a document from the print **Properties** dialog box.

Cause: The size of the document you were printing was larger than the paper loaded in the input tray.

If this did not solve the issue, try the next solution.

Solution 3: Load the stack of papers correctly

Solution: If the paper is misfeeding, it could cause parts of the document to cut off. Remove the stack of paper from the input tray, and then reload the paper.

For more information, see:

[Load media](#)

Cause: The paper was loaded incorrectly.

If this did not solve the issue, try the next solution.

Solution 4: Try printing with borders

Solution: Try printing with borders by turning off the borderless option.

For more information, see:

[Print borderless](#)

Cause: Borderless printing was enabled. By selecting the **Borderless** option, your printed photo was enlarged and centered to fit the printable area of the page. Depending on the relative sizes of the digital photo and the paper on which you are printing, this could result in some parts of the image being cropped.

A blank page came out while printing

Try the following solutions to resolve the issue. Solutions are listed in order, with the most likely solution first. If the first solution does not solve the problem, continue trying the remaining solutions until the issue is resolved.

- [Solution 1: Remove any extra pages or lines at the end of the document](#)
- [Solution 2: Load paper in the input tray](#)
- [Solution 3: Check the ink levels](#)
- [Solution 4: Clean the printhead](#)
- [Solution 5: Load paper in the input tray](#)

Solution 1: Remove any extra pages or lines at the end of the document

Solution: Open the document file in your software application and remove any extra pages or lines at the end of the document.

Cause: The document you were printing contained an additional blank page.

If this did not solve the issue, try the next solution.

Solution 2: Load paper in the input tray

Solution: If the product has only a few sheets remaining, load more paper in the input tray. If there is plenty of paper in the input tray, remove the paper, tap the stack of paper against a flat surface, and reload the paper into the input tray.

For more information, see:

[Load media](#)

Cause: The product picked up two sheets of paper.

Solution 3: Check the ink levels

Solution: The ink cartridges may be running low on ink.

Cause: Ink levels are too low.

Solution 4: Clean the printhead

Solution: Complete the printhead cleaning procedure. For more information, see [Clean the printhead](#). The printhead may need to be cleaned if the printer was turned off improperly.

 **NOTE:** Turn off the HP Printer by pressing the **Power** button located on the product. Wait until the **Power** light turns off before unplugging the power cord or turning off a power strip. If you improperly turn off the HP Printer, the print carriage might not return to the correct position causing problems with the ink cartridges and print quality issues.

Cause: The printhead was clogged.

Solution 5: Load paper in the input tray

Solution: If the product has only a few sheets remaining, load more paper in the input tray. If there is plenty of paper in the input tray, remove the paper, tap the stack of paper against a flat surface, and reload the paper into the input tray.

For more information, see:

[Load media](#)

Cause: The product picked up two sheets of paper.

Print quality troubleshooting

Use this section to solve these print quality problems:

- [Wrong, inaccurate, or bleeding colors](#)
- [Ink is not filling the text or graphics completely](#)
- [The printout has a horizontal band of distortion near the bottom of a borderless print](#)
- [Printouts have horizontal streaks or lines](#)
- [Printouts are faded or have dull colors](#)
- [Printouts seem blurry or fuzzy](#)
- [Printouts have vertical streaks](#)
- [Printouts are slanted or skewed](#)
- [Ink streaks on the back of the paper](#)
- [Paper is not picked up from the input tray](#)
- [Poor black text](#)
- [The product prints slowly](#)
- [Advanced printhead maintenance](#)

Wrong, inaccurate, or bleeding colors

If your printout has one of the following print quality problems, try the solutions in this section for help.

- Colors look wrong
For example, green was replaced with blue in your printout.
- Colors run into each other, or look like they are smeared on the page. The edges might have a feathering appearance instead of being sharp and defined.

Try the following solutions if the colors appear wrong, inaccurate, or bleed into each other.

- [Solution 1: Make sure you are using genuine HP ink cartridges](#)
- [Solution 2: Check the paper loaded in the input tray](#)
- [Solution 3: Check the paper type](#)
- [Solution 4: Check the ink levels](#)
- [Solution 5: Check the print settings](#)
- [Solution 6: Align the printhead](#)
- [Solution 7: Clean the printhead](#)
- [Solution 8: Contact HP support](#)

Solution 1: Make sure you are using genuine HP ink cartridges

Solution: Check to see if your ink cartridges are genuine HP ink cartridges.

HP recommends that you use genuine HP ink cartridges. Genuine HP ink cartridges are designed and tested with HP printers to help you easily produce great results, time after time.

 **NOTE:** HP cannot guarantee the quality or reliability of non-HP supplies. Product service or repairs required as a result of using a non-HP supply will not be covered under warranty.

If you believe you purchased genuine HP ink cartridges, go to:

www.hp.com/go/anticounterfeit

Cause: Non-HP ink cartridges were being used.

If this did not solve the issue, try the next solution.

Solution 2: Check the paper loaded in the input tray

Solution: Make sure the paper is loaded correctly and that it is not wrinkled or too thick.

- Load paper with the side you want to print on facing down. For example, if you are loading glossy photo paper, load the paper with the glossy side down.
- Make sure the paper lays flat in the input tray and is not wrinkled. If the paper is too close to the printhead during printing, the ink might be smeared. This can happen if the paper is raised, wrinkled, or very thick, such as a mailing envelope.

For more information, see:

[Load media](#)

Cause: The paper was loaded incorrectly, or it was wrinkled or too thick.

If this did not solve the issue, try the next solution.

Solution 3: Check the paper type

Solution: HP recommends that you use HP papers or any other paper type that is appropriate for the product.

Always make sure the paper you are printing on is flat. For best results when printing images, use HP Advanced Photo Paper.

Store specialty media in its original packaging inside a resealable plastic bag on a flat surface in a cool, dry place. When you are ready to print, remove only the paper you plan to use immediately. When you have finished printing, return any unused photo paper to the plastic bag. This will prevent the photo paper from curling.

 **NOTE:** For this issue, there is not a problem with your ink supplies. Therefore, replacing the ink cartridges or printhead is not necessary.

For more information, see:

[Select print media](#)

Cause: The wrong kind of paper was loaded in the input tray.

If this did not solve the issue, try the next solution.

Solution 4: Check the ink levels

Solution: Check the estimated ink levels in the ink cartridges.

 **NOTE:** Ink level alerts and indicators provide estimates for planning purposes only. When you receive a low-ink alerts, consider having a replacement cartridge available to avoid possible printing delays. You do not need to replace the ink cartridges until print quality becomes unacceptable.

For more information, see:

[Check the estimated ink levels](#)

Cause: The ink cartridges might have insufficient ink.

If this did not solve the issue, try the next solution.

Solution 5: Check the print settings

Solution: Check the print settings.

- Check the print settings to see if the color settings are incorrect. For example, check to see if the document is set to print in grayscale. Or, check to see if advanced color settings such as saturation, brightness, or color tone, are set to modify the appearance of colors.
- Check the print quality setting and make sure it matches the type of paper loaded in the product. You might need to choose a lower print quality setting, if colors are running into each other. Or, choose a higher setting if you are printing a high-quality photo, and then make sure photo paper such as HP Advanced Photo Paper, is loaded in the input tray.

 **NOTE:** On some computer screens, colors might appear differently than they do when printed on paper. In this case, there is nothing wrong with the product, print settings, or ink cartridges. No further troubleshooting is required.

For more information, see:

[Select print media](#)

Cause: The print settings were set incorrectly.

If this did not solve the issue, try the next solution.

Solution 6: Align the printhead

Solution: Align the printhead.

Aligning the printer can help ensure excellent print quality.

For more information, see:

[Align the printhead](#)

Cause: The printer needed to be aligned.

If this did not solve the issue, try the next solution.

Solution 7: Clean the printhead

Solution: Check the following potential problems, and then clean the printhead.

- Check the orange pull tab on the ink cartridges. Make sure they were completely removed.
- Make sure all ink cartridges are properly installed.
- Make sure you turn off the device properly, by using the **Power** button. This allows the device to properly protect the printhead.

After cleaning the printhead, print a print quality report. Evaluate the print quality report to see if the print quality problem still exists.

For more information, see:

- [Clean the printhead](#)
- [Print and evaluate a print quality report](#)

Cause: The printhead needed to be cleaned.

If this did not solve the issue, try the next solution.

Solution 8: Contact HP support

Solution: Contact HP support for service.

Go to: www.hp.com/support.

If prompted, choose your country/region, and then click **Contact HP** for information on calling for technical support.

Cause: There was a problem with the printhead.

Ink is not filling the text or graphics completely

Try the following solutions if the ink is not filling the text or image completely so that it appears that parts are missing or blank.

- [Solution 1: Make sure you are using genuine HP ink cartridges](#)
- [Solution 2: Check the ink levels](#)
- [Solution 3: Check the print settings](#)
- [Solution 4: Check the paper type](#)
- [Solution 5: Clean the printhead](#)
- [Solution 6: Contact HP support](#)

Solution 1: Make sure you are using genuine HP ink cartridges

Solution: Check to see if your ink cartridges are genuine HP ink cartridges.

HP recommends that you use genuine HP ink cartridges. Genuine HP ink cartridges are designed and tested with HP printers to help you easily produce great results, time after time.

 **NOTE:** HP cannot guarantee the quality or reliability of non-HP supplies. Product service or repairs required as a result of using a non-HP supply will not be covered under warranty.

If you believe you purchased genuine HP ink cartridges, go to:

www.hp.com/go/anticounterfeit

Cause: Non-HP ink cartridges were being used.

If this did not solve the issue, try the next solution.

Solution 2: Check the ink levels

Solution: Check the estimated ink levels in the ink cartridges.

 **NOTE:** Ink level alerts and indicators provide estimates for planning purposes only. When you receive a low-ink alerts, consider having a replacement cartridge available to avoid possible printing delays. You do not need to replace the ink cartridges until print quality becomes unacceptable.

For more information, see:

[Check the estimated ink levels](#)

Cause: The ink cartridges might have insufficient ink.

If this did not solve the issue, try the next solution.

Solution 3: Check the print settings

Solution: Check the print settings.

- Check the paper type setting to make sure it matches the type of paper loaded in the input tray.
- Check the print quality setting and make sure it is not set too low.
Print the image with a high print quality setting, such as **Best** or **Maximum dpi**.

Cause: The paper type or print quality settings were set incorrectly.

If this did not solve the issue, try the next solution.

Solution 4: Check the paper type

Solution: HP recommends that you use HP papers or any other paper type that is appropriate for the product.

Always make sure the paper you are printing on is flat. For best results when printing images, use HP Advanced Photo Paper.

Store specialty media in its original packaging inside a resealable plastic bag on a flat surface in a cool, dry place. When you are ready to print, remove only the paper you plan to use immediately. When you have finished printing, return any unused photo paper to the plastic bag. This will prevent the photo paper from curling.

 **NOTE:** For this issue, there is not a problem with your ink supplies. Therefore, replacing the ink cartridges or printhead is not necessary.

For more information, see:

[Select print media](#)

Cause: The wrong kind of paper was loaded in the input tray.

If this did not solve the issue, try the next solution.

Solution 5: Clean the printhead

Solution: If the previous solutions did not resolve the issue, try cleaning the printhead.

After cleaning the printhead, print a print quality report. Evaluate the print quality report to see if the print quality problem still exists.

For more information, see:

- [Clean the printhead](#)
- [Print and evaluate a print quality report](#)

Cause: The printhead needed to be cleaned.

If this did not solve the issue, try the next solution.

Solution 6: Contact HP support

Solution: Contact HP support for service.

Go to: www.hp.com/support.

If prompted, choose your country/region, and then click **Contact HP** for information on calling for technical support.

Cause: There was a problem with the printhead.

The printout has a horizontal band of distortion near the bottom of a borderless print

Try the following solutions if your borderless print has a blurry band or line on the bottom of it.

 **NOTE:** For this issue, there is not a problem with your ink supplies. Therefore, replacing the ink cartridges or printhead is not necessary.

- [Solution 1: Check the paper type](#)
- [Solution 2: Use a higher print quality setting](#)
- [Solution 3: Rotate the image](#)

Solution 1: Check the paper type

Solution: HP recommends that you use HP papers or any other paper type that is appropriate for the product.

Always make sure the paper you are printing on is flat. For best results when printing images, use HP Advanced Photo Paper.

Store photo media in its original packaging inside a resealable plastic bag on a flat surface in a cool, dry place. When you are ready to print, remove only the paper you plan to use immediately. When you have finished printing, return any unused photo paper to the plastic bag. This will prevent the photo paper from curling.

For more information, see:

[Select print media](#)

Cause: The wrong kind of paper was loaded in the input tray.

If this did not solve the issue, try the next solution.

Solution 2: Use a higher print quality setting

Solution: Check the print quality setting and make sure it is not set too low.

Print the image with a high print quality setting, such as **Best** or **Maximum dpi**.

Cause: The print quality setting was set too low.

If this did not solve the issue, try the next solution.

Solution 3: Rotate the image

Solution: If the problem persists, use the software you installed with the product or another software application to rotate your image 180 degrees so that the light blue, gray, or brown hues in your image do not print at the bottom of the page.

Cause: The defect is more noticeable in areas of uniform light colors, so rotating the image may help.

Printouts have horizontal streaks or lines

Try the following solutions if your printout has lines, streaks, or marks on it that run across the width of the page.

- [Solution 1: Make sure the paper is loaded correctly](#)
- [Solution 2: Check your print settings](#)

- [Solution 3: Check the ink levels](#)
- [Solution 4: Align the printhead](#)
- [Solution 5: Clean the printhead](#)
- [Solution 6: Contact HP support](#)

Solution 1: Make sure the paper is loaded correctly

Solution: Make sure that the paper is loaded correctly in the input tray.

For more information, see:

[Load media](#)

Cause: The paper was not loaded correctly.

If this did not solve the issue, try the next solution.

Solution 2: Check your print settings

Solution: Check the print quality setting and make sure it is not set too low.

Print the image with a high print quality setting, such as **Best** or **Maximum dpi**.

Check the media settings. Make sure the media selected matches the media loaded in the device.

Cause: The print quality setting on the product was set too low.

If this did not solve the issue, try the next solution.

Solution 3: Check the ink levels

Solution: Check the estimated ink levels in the ink cartridges.

 **NOTE:** Ink level alerts and indicators provide estimates for planning purposes only. When you receive a low-ink alert, consider having a replacement cartridge available to avoid possible printing delays. You do not need to replace the ink cartridges until print quality becomes unacceptable.

For more information, see:

[Check the estimated ink levels](#)

Cause: The ink cartridges might have insufficient ink.

If this did not solve the issue, try the next solution.

Solution 4: Align the printhead

Solution: Align the printhead.

Aligning the printer can help ensure excellent print quality.

For more information, see:

[Align the printhead](#)

Cause: The printer needed to be aligned.

If this did not solve the issue, try the next solution.

Solution 5: Clean the printhead

Solution: Check the following potential problems, and then clean the printhead.

After cleaning the printhead, print a print quality report. Evaluate the print quality report to see if the print quality problem still exists.

For more information, see:

- [Clean the printhead](#)
- [Print and evaluate a print quality report](#)

Cause: The printhead needed to be cleaned.

If this did not solve the issue, try the next solution.

Solution 6: Contact HP support

Solution: Contact HP support for service.

Go to: www.hp.com/support.

If prompted, choose your country/region, and then click **Contact HP** for information on calling for technical support.

Cause: There was a problem with the printhead.

Printouts are faded or have dull colors

Try the following solutions if the colors in your printout are not as bright and intense as you expected.

- [Solution 1: Check the print settings](#)
- [Solution 2: Check the paper type](#)
- [Solution 3: Check the ink levels](#)
- [Solution 4: Clean the printhead](#)
- [Solution 5: Contact HP support](#)

Solution 1: Check the print settings

Solution: Check the print settings.

- Check the paper type setting to make sure it matches the type of paper loaded in the input tray.
- Check the print quality setting and make sure it is not set too low.
Print the image with a high print quality setting, such as **Best** or **Maximum dpi**.

Cause: The paper type or print quality settings were set incorrectly.

If this did not solve the issue, try the next solution.

Solution 2: Check the paper type

Solution: HP recommends that you use HP papers or any other paper type that is appropriate for the product.

Always make sure the paper you are printing on is flat. For best results when printing images, use HP Advanced Photo Paper.

Store specialty media in its original packaging inside a resealable plastic bag on a flat surface in a cool, dry place. When you are ready to print, remove only the paper you plan to use immediately. When you have finished printing, return any unused photo paper to the plastic bag. This will prevent the photo paper from curling.

 **NOTE:** For this issue, there is not a problem with your ink supplies. Therefore, replacing the ink cartridges or printhead is not necessary.

For more information, see:

[Select print media](#)

Cause: The wrong kind of paper was loaded in the input tray.

If this did not solve the issue, try the next solution.

Solution 3: Check the ink levels

Solution: Check the estimated ink levels in the ink cartridges.

 **NOTE:** Ink level alerts and indicators provide estimates for planning purposes only. When you receive a low-ink alert, consider having a replacement cartridge available to avoid possible printing delays. You do not need to replace the ink cartridges until print quality becomes unacceptable.

For more information, see:

[Check the estimated ink levels](#)

Cause: The ink cartridges might have insufficient ink.

If this did not solve the issue, try the next solution.

Solution 4: Clean the printhead

Solution: If the previous solutions did not resolve the issue, try cleaning the printhead.

After cleaning the printhead, print a print quality report. Evaluate the print quality report to see if the print quality problem still exists.

For more information, see:

- [Clean the printhead](#)
- [Print and evaluate a print quality report](#)

Cause: The printhead needed to be cleaned.

If this did not solve the issue, try the next solution.

Solution 5: Contact HP support

Solution: Contact HP support for service.

Go to: www.hp.com/support.

If prompted, choose your country/region, and then click **Contact HP** for information on calling for technical support.

Cause: There was a problem with the printhead.

Printouts seem blurry or fuzzy

Try the following solutions if your printout is not sharp or unclear.

 **NOTE:** For this issue, there is not a problem with your ink supplies. Therefore, replacing the ink cartridges or printhead is not necessary.

 **TIP:** After reviewing the solutions in this section, you can go to HP's Web site to see if there is additional troubleshooting help. For more information, go to: www.hp.com/support.

- [Solution 1: Check the print settings](#)
- [Solution 2: Use a higher quality image](#)
- [Solution 3: Print the image in a smaller size](#)
- [Solution 4: Align the printhead](#)

Solution 1: Check the print settings

Solution: Check the print settings.

- Check the paper type setting to make sure it matches the type of paper loaded in the input tray.
- Check the print quality setting and make sure it is not set too low.
Print the image with a high print quality setting, such as **Best** or **Maximum dpi**.

Cause: The paper type or print quality settings were set incorrectly.

If this did not solve the issue, try the next solution.

Solution 2: Use a higher quality image

Solution: Use a higher resolution image.

If you are printing a photo or graphic, and the resolution is too low, it will be blurry or fuzzy when printed.

If a digital photo or rasterized graphic has been resized, it can be blurry or fuzzy when printed.

Cause: The resolution of the image was low.

If this did not solve the issue, try the next solution.

Solution 3: Print the image in a smaller size

Solution: Reduce the size of the image and then print it.

If you are printing a photo or graphic, and the print size is set too high, it will be blurry or fuzzy when printed.

If a digital photo or rasterized graphic has been resized, it can be blurry or fuzzy when printed.

Cause: The image was printed in a larger size.

If this did not solve the issue, try the next solution.

Solution 4: Align the printhead

Solution: Align the printhead.

Aligning the printer can help ensure excellent print quality.

For more information, see:

[Align the printhead](#)

Cause: The printer needed to be aligned.

Printouts have vertical streaks

Solution: HP recommends that you use HP papers or any other paper type that is appropriate for the product.

Always make sure the paper you are printing on is flat. For best results when printing images, use HP Advanced Photo Paper.

Store specialty media in its original packaging inside a resealable plastic bag on a flat surface in a cool, dry place. When you are ready to print, remove only the paper you plan to use immediately. When you have finished printing, return any unused photo paper to the plastic bag. This will prevent the photo paper from curling.

 **NOTE:** For this issue, there is not a problem with your ink supplies. Therefore, replacing the ink cartridges or printhead is not necessary.

For more information, see:

[Select print media](#)

Cause: The wrong kind of paper was loaded in the input tray.

Printouts are slanted or skewed

Try the following solutions if your printout does not appear straight on the page.

- [Solution 1: Make sure the paper is loaded correctly](#)
- [Solution 2: Make sure only one type of paper is loaded](#)
- [Solution 3: Ensure that the rear access panel or duplexer is securely installed](#)

Solution 1: Make sure the paper is loaded correctly

Solution: Make sure that the paper is loaded correctly in the input tray.

For more information, see:

[Load media](#)

Cause: The paper was not loaded correctly.

If this did not solve the issue, try the next solution.

Solution 2: Make sure only one type of paper is loaded

Solution: Load only one type of paper at a time.

Cause: More than one type of paper was loaded in the input tray.

If this did not solve the issue, try the next solution.

Solution 3: Ensure that the rear access panel or duplexer is securely installed

Solution: Make sure that the rear door is securely installed.

If you removed the rear door to clear a paper jam, replace it. Gently push the door forward until it snaps into place.

Cause: The rear door was not securely installed.

Ink streaks on the back of the paper

Try the following solutions if there is smeared ink on the back of your printout.

- [Solution 1: Print on a page of plain paper](#)
- [Solution 2: Wait while the ink dries](#)

Solution 1: Print on a page of plain paper

Solution: Print one or several pages of plain paper to soak up any excess ink in the product.

To remove excess ink using plain paper

1. Load several sheets of plain paper in the input tray.
2. Wait five minutes.
3. Print a document with little or no text.
4. Check the back of the paper for ink. If there is still ink on the back of the paper, try printing on another page of plain paper.

Cause: Ink accumulated inside the product, where the back of the paper rests during printing.

If this did not solve the issue, try the next solution.

Solution 2: Wait while the ink dries

Solution: Wait at least thirty minutes for the ink inside the product to dry, then try the print job again.

Cause: The excess ink in the product needed to dry out.

Paper is not picked up from the input tray

Try the following solutions to resolve the issue. Solutions are listed in order, with the most likely solution first. If the first solution does not solve the problem, continue trying the remaining solutions until the issue is resolved.

- [Solution 1: Restart the product](#)
- [Solution 2: Make sure the paper is loaded correctly](#)
- [Solution 3: Check the print settings](#)
- [Solution 4: Clean the rollers](#)
- [Solution 5: Check for a paper jam](#)
- [Solution 6: Service the product](#)

Solution 1: Restart the product

Solution: Turn off the product, and then unplug the power cord. Plug the power cord back in, and then press the **Power** button to turn on the product.

Cause: The product experienced an error.

If this did not solve the issue, try the next solution.

Solution 2: Make sure the paper is loaded correctly

Solution: Make sure that the paper is loaded correctly in the input tray.

For more information, see:

[Load media](#)

Cause: The paper was not loaded correctly.

If this did not solve the issue, try the next solution.

Solution 3: Check the print settings

Solution: Check the print settings.

- Check the paper type setting to make sure it matches the type of paper loaded in the input tray.
- Check the print quality setting and make sure it is not set too low.
Print the image with a high print quality setting, such as **Best** or **Maximum dpi**.

Cause: The paper type or print quality settings were set incorrectly.

If this did not solve the issue, try the next solution.

Solution 4: Clean the rollers

Solution: Clean the rollers.

Make sure you have the following materials available:

- A lint-free cloth, or any soft material that will not come apart or leave fibers.
- Distilled, filtered, or bottled water (tap water might contain contaminants that can damage the ink cartridges).

Cause: The rollers were dirty and needed to be cleaned.

If this did not solve the issue, try the next solution.

Solution 5: Check for a paper jam

Solution: Check for paper debris in the front of the device. Remove any debris you find.

△ **CAUTION:** Trying to clear a paper jam from the front of the device can damage the print mechanism. Always access and clear paper jams through the rear access panel or duplexer.

Cause: Paper debris may be present, but not detected by the sensor.

Solution 6: Service the product

Solution: If you have completed all of the steps provided in the previous solutions, contact HP support for service.

Go to: www.hp.com/support.

If prompted, choose your country/region, and then click **Contact HP** for information on calling for technical support.

Cause: Your product needs servicing.

Poor black text

Try the following solutions if the text in your printouts is not sharp and the edges are rough.

 **NOTE:** For this issue, there is not a problem with your ink supplies. Therefore, replacing the ink cartridges or printhead is not necessary.

- [Solution 1: Wait before you attempt to reprint](#)
- [Solution 2: Use TrueType or OpenType fonts](#)
- [Solution 3: Align the printhead](#)
- [Solution 4: Clean the printhead](#)

Solution 1: Wait before you attempt to reprint

Solution: If the black cartridge is new, allow time for automatic servicing to clear up the problem. Black print quality should start to improve in a few hours. If you do

not have time to wait, you can clean the printhead, but this uses more ink, and the poor black text may reoccur until automatic servicing is allowed to complete.

Cause: Many black print quality problems clear up when the automatic services are performed.

Solution 2: Use TrueType or OpenType fonts

Solution: Use TrueType or OpenType fonts to ensure that the product is able to print smooth fonts. When selecting a font, look for the TrueType or OpenType icon.



TrueType icon



OpenType icon

Cause: The font was a custom size.

Some software applications offer custom fonts that have jagged edges when enlarged or printed. Also, if you want to print bitmapped text, it might have jagged edges when enlarged or printed.

If this did not solve the issue, try the next solution.

Solution 3: Align the printhead

Solution: Align the printhead.

Aligning the printer can help ensure excellent print quality.

For more information, see:

[Align the printhead](#)

Cause: The printer needed to be aligned.

If this did not solve the issue, try the next solution.

Solution 4: Clean the printhead

Solution: If the previous solutions did not resolve the issue, try cleaning the printhead.

After cleaning the printhead, print a print quality report. Evaluate the print quality report to see if the print quality problem still exists.

For more information, see:

- [Clean the printhead](#)
- [Print and evaluate a print quality report](#)

Cause: The printhead needed to be cleaned.

The product prints slowly

Try the following solutions if the product is printing very slowly.

- [Solution 1: Use a lower print quality setting](#)
- [Solution 2: Check the ink levels](#)
- [Solution 3: Contact HP support](#)

Solution 1: Use a lower print quality setting

Solution: Check the print quality setting. **Best** and **Maximum dpi** provide the best quality but are slower than **Normal** or **Draft**. **Draft** provides the fastest print speed.

Cause: The print quality was set to a high setting.

If this did not solve the issue, try the next solution.

Solution 2: Check the ink levels

Solution: Check the estimated ink levels in the ink cartridges.

 **NOTE:** Ink level alerts and indicators provide estimates for planning purposes only. When you receive a low-ink alert, consider having a replacement cartridge available to avoid possible printing delays. You do not need to replace the ink cartridges until print quality becomes unacceptable.

For more information, see:

[Check the estimated ink levels](#)

Cause: The ink cartridges might have insufficient ink. Insufficient ink may cause the printhead to overheat. When the printhead overheats, the printer slows down to allow it to cool.

If this did not solve the issue, try the next solution.

Solution 3: Contact HP support

Solution: Contact HP support for service.

Go to: www.hp.com/support.

If prompted, choose your country/region, and then click **Contact HP** for information on calling for technical support.

Cause: There was a problem with the product.

Advanced printhead maintenance

If you are experiencing problems with printing, you might have a problem with the printhead. You should perform the procedures in the following sections only when directed to do so for resolving print quality issues.

Performing the aligning and cleaning procedures unnecessarily can waste ink and shorten the life of the cartridges.

If you receive an error message about the ink cartridges, see [Errors \(Windows\)](#) for more information.

This section contains the following topics:

- [Clean the printhead](#)
- [Align the printhead](#)

Clean the printhead

If your printed output is streaked or has any incorrect or missing colors, the printhead might need to be cleaned.





There are two stages of cleaning. Each stage lasts about two minutes, uses one sheet of paper, and uses an increasing amount of ink. After each stage, review the quality of the printed page. You should only initiate the next phase of cleaning if the print quality is poor.

If print quality still seems poor after you complete both stages of cleaning, try aligning the printer. If print quality problems persist after cleaning and aligning, contact HP support.

 **NOTE:** Cleaning uses ink, so clean the printheads only when necessary. The cleaning process takes a few minutes. Some noise might be generated in the process. Before cleaning the printheads, make sure you load paper. For more information, see [Load media](#).

Not turning the device off properly can cause print quality problems. For more information, see [Turn off the device](#).

To clean the printhead from the control panel

1. Load letter, A4, or legal unused plain white paper into the main input tray.
2. Press and hold  (**Power** button), press  (**Cancel** button) two times, press  (**Resume** button) one time, and release  (**Power** button).

To clean the printhead from the Printer Toolbox (Windows)

1. Load letter, A4, or legal unused plain white paper into the main input tray.
2. In the HP Solution Center, click **Settings**.
3. In the **Print Settings** area, click **Printer Toolbox**.

 **NOTE:** You can also open the **Printer Toolbox** from the **Print Properties** dialog box. In the **Print Properties** dialog box, click the **Features** tab, and then click **Printer Services**.

The **Printer Toolbox** appears.

4. Click the **Device Services** tab.
5. Click **Clean Printhead**.
6. Follow the prompts until you are satisfied with the quality of the output, and then click **Done**.

To clean the printhead from the Toolbox (Mac OS X)

1. Click the **HP Device Manager** icon in the Dock.

 **NOTE:** If HP Device Manager is not in the Dock, click the **Spotlight** icon on the right side of the menu bar, type **HP Device Manager** in the box, and then click the **HP Device Manager** entry.

2. Select **Maintain Printer**.
3. Select the device you want to clean and then click **Select**.
4. Select **Clean Printheads** and then click **Clean**.

To clean the printhead from the embedded Web server



1. Load letter, A4, or legal unused plain white paper into the main input tray.
2. Click the **Settings** tab, click **Device Services** in the left pane, select **Clean Printheads** from the drop-down list in the **Print Quality** section, and then click **Run Diagnostic**.

Align the printhead

The product automatically aligns the printhead during the initial setup.

You might want to use this feature when the printer status page shows streaking or white lines through any of the blocks of color or if you are having print quality issues with your printouts.

To align the printhead from the control panel

1. Load letter, A4, or legal unused plain white paper into the main input tray.
2. **Control panel:** Press and hold  (**Power** button), press  (**Resume** button) three times, and release  (**Power** button).

To align the printer from the Printer Toolbox

1. Load letter, A4, or legal unused plain white paper into the main input tray.
2. In the HP Solution Center, click **Settings**.
3. In the **Print Settings** area, click **Printer Toolbox**.

 **NOTE:** You can also open the **Printer Toolbox** from the **Print Properties** dialog box. In the **Print Properties** dialog box, click the **Features** tab, and then click **Printer Services**.

The **Printer Toolbox** appears.

4. Click the **Device Services** tab.
5. Click **Align the Printer**.
The product prints a test page, aligns the printhead, and calibrates the printer. Recycle or discard the page.

To align the printhead from the Toolbox (Mac OS X)

1. Click the **HP Device Manager** icon in the Dock.

 **NOTE:** If HP Device Manager is not in the Dock, click the **Spotlight** icon on the right side of the menu bar, type **HP Device Manager** in the box, and then click the **HP Device Manager** entry.

2. Select **Maintain Printer**.
3. Select the device you want to clean and then click **Select**.
4. Select **Align** from the menu on the left, and then click **Align**.

To align the printhead from the embedded Web server

1. Load letter, A4, or legal unused plain white paper into the main input tray.
2. Click the **Settings** tab, click **Device Services** in the left pane, select **Align Printer** from the drop-down list in the **Print Quality** section, and then click **Run Diagnostic**.

Solve paper-feed problems

Media is not supported for the printer or tray

Use only media that is supported for the device and the tray being used. For more information, see [Understand specifications for supported media](#).

Media is not picked up from a tray

- Make sure media is loaded in the tray. For more information, see [Load media](#). Fan the media before loading.
- Make sure the paper guides are set to the correct markings in the tray for the media size you are loading. Also make sure the guides are snug, but not tight, against the stack.
- Make sure media in the tray is not curled. Uncurl paper by bending it in the opposite direction of the curl.
- When using thin special media, make sure that the tray is completely loaded. If you are using special media that is only available in small quantities, try placing the special media on top of other paper of the same size to help fill the tray. (Some media is picked up more easily if the tray is full.)

Media is not coming out correctly

- Make sure the output tray extension is extended; otherwise, printed pages may fall off the device.



- Remove excess media from the output tray. There is a limit to the number of sheets the tray can hold.

Pages are skewing

- Make sure the media loaded in the trays is aligned to the paper guides. If needed, pull out the trays from the device and reload the media properly, making sure that the paper guides are properly aligned.
- Make sure the duplexer is properly installed.
- Load media into the device only when it is not printing.

Multiple pages are being picked up

- Fan the media before loading.
- Make sure the paper guides are set to the correct markings in the tray for the media size you are loading. Also make sure the guides are snug, but not tight, against the stack.
- Make sure the tray is not overloaded with paper.
- Use HP media for optimum performance and efficiency.

Solve device management problems

This section provide solutions to common problems that involve managing the device. This section contains the following topic:

- [Embedded Web server cannot be opened](#)

Embedded Web server cannot be opened

Check your network setup

- Make sure you are not using a phone cord or a cross cable to connect the device to the network. For more information, see [Configure the device \(Windows\)](#) or [Configure the device \(Mac OS X\)](#).
- Make sure the network cable is securely connected to the device.
- Make sure the network hub, switch, or router is turned on and working properly.

Check the computer

Make sure the computer that you are using is connected to the network.

Check your Web browser

Make sure the Web browser meets the minimum system requirements. For more information, see [Embedded Web server specifications](#).

Check the device IP address

- To check the IP address of the device from the control panel, print the network configuration page. For more information, see [Understand the network configuration or wireless status report](#).
- Ping the device using the IP address from the command prompt.
For example, if the IP address is 123.123.123.123, type the following at the MS-DOS prompt:

```
C:\>Ping 123.123.123.123
```

If a reply appears, the IP address is correct. If a time-out response appears, the IP address is incorrect.

Solve network problems



NOTE: After correcting any of the following, run the installation program again.

General network troubleshooting

- If you are unable to install the device software, verify that:
 - All cable connections to the computer and the device are secure.
 - The network is operational and the network hub is turned on.
 - All applications, including virus protection programs, spyware protection programs, and firewalls, are closed or disabled for computers running Windows.
 - Make sure the device is installed on the same subnet as the computers that will be using the device.
 - If the installation program cannot discover the device, print the network configuration page, and enter the IP address manually in the installation program. For more information, see [Understand the network configuration or wireless status report](#)
- If you are using a computer running Windows, make sure that the network ports created in the device driver match the device IP address.
 - Print the device's network configuration page.
 - Click **Start**, point to **Settings**, and then click **Printers** or **Printers and Faxes**.
- Or -
Click **Start**, click **Control Panel**, and then double-click **Printers**.
 - Right-click the device icon, click **Properties**, and then click the **Ports** tab.
 - Select the TCP/IP port for the device, and then click **Configure Port**.

- Compare the IP address listed in the dialog box and make sure it matches the IP address listed on the network configuration page. If the IP addresses are different, change the IP address in the dialog box to match the address on the network configuration page.
- Click **OK** twice to save the settings and close the dialog boxes.

Problems connecting to a wired network

- If the Network light on the control panel does not turn on, make sure that all of the “General network troubleshooting” conditions are met.
- Though it is not recommended that you assign the device with a static IP address, you might resolve some installation problems (such as a conflict with a personal firewall) by doing so.

Solve wireless problems

If the device is unable to communicate with the network after completing the wireless setup and software installation, perform one or more of the following tasks in the order shown below.

- [Basic wireless troubleshooting](#)
- [Advanced wireless troubleshooting](#)

Basic wireless troubleshooting

Perform the following steps in the order presented.

 **NOTE:** If this is the first time you are setting up the wireless connection, and you are using the included software, make sure that the USB cable is connected to the device and the computer.

Step 1 - Make sure the wireless (802.11) light is turned on

If the blue light near the HP device's wireless button is not lit, the wireless capabilities might not have been turned on. To turn on wireless, press and hold the **Wireless** button for three seconds, and then release the button.

 **NOTE:** If your HP device supports Ethernet networking, make sure that an Ethernet cable has not been connected to the device. Connecting an Ethernet cable turns off the HP device's wireless capabilities.

Step 2 - Restart components of the wireless network

Turn off the router and the HP device, and then turn them back on in this order: router first, and then the HP device. If you still are unable to connect, turn off the router, HP device, and your computer. Sometimes, turning off the power and then turning it back on will recover a network communication issue.

Step 3 - Run the Wireless Network Test

For wireless networking issues, run the Wireless Network Test. To print a Wireless Network Test page press and hold the **Wireless** button, and then press the **Resume**

button two times. Then release all buttons. If a problem is detected, the printed test report will include recommendations that might help solve the problem.

Advanced wireless troubleshooting

If you have tried the suggestions provided in the Basic troubleshooting section and are still unable to connect to your HP device to the wireless network, try the following suggestions in the order presented:

- [Make sure your computer is connected to your network](#)
- [Make sure that the HP device is connected to your network](#)
- [Check to see if the firewall software is blocking communication](#)
- [Make sure the HP device is online and ready](#)
- [Your wireless router is using a hidden SSID](#)
- [Make sure the wireless version of the HP device is set as the default printer driver \(Windows only\)](#)
- [Make sure the HP Network Devices Support service is running \(Windows only\)](#)
- [Add hardware addresses to a wireless access point \(WAP\)](#)

Make sure your computer is connected to your network

To check a wired (Ethernet) connection

- ▲ Many computers have indicator lights beside the port where the Ethernet cable from the router connects to your computer. Usually there are two indicator lights, one that is on, and another that blinks. If your computer has indicator lights, check to see if the indicator lights are on. If the lights are not on, try reconnecting the Ethernet cable to the computer and the router. If you still do not see lights, there might be a problem with the router, the Ethernet cable, or your computer.

 **NOTE:** Macintosh computers do not have indicator lights. To check the Ethernet connection on a Macintosh computer, click **System Preferences** in the Dock, and then click **Network**. If the Ethernet connection is working correctly, **Built-in Ethernet** appears in the list of connections, along with the IP address and other status information. If **Built-in Ethernet** does not appear in the list, there might be a problem with the router, the Ethernet cable, or your computer. For more information, click the Help button in the window.

To check a wireless connection

1. Make sure that your computer's wireless has been turned on. (For more information, see the documentation that came with your computer.)
2. If you are not using a unique network name (SSID), then it is possible that your wireless computer could be connected to a nearby network that is not yours. The following steps can help you determine if your computer is connected to your network.

Windows

- a. Click **Start**, click **Control Panel**, point to **Network Connections**, and then click **View Network Status and Tasks**.

Or

Click **Start**, select **Settings**, click **Control Panel**, double-click **Network Connections**, click the **View** menu, and then select **Details**

Leave the network dialog box open while you continue to the next step.

- b. Disconnect the power cord from the wireless router. The connection status of your computer should change to **Not Connected**.
- c. Reconnect the power cord to the wireless router. The connection status should change to **Connected**.

Mac OS X

- ▲ Click the **AirPort** icon in the menu bar at the top of the screen. From the menu that appears, you can determine if the AirPort is turned on and which wireless network your computer is connected to.



NOTE: For more detailed information about your AirPort connection, click **System Preferences** in the Dock, and then click **Network**. If the wireless connection is working correctly, a green dot appears next to AirPort in the list of connections. For more information, click the Help button in the window.

If you are unable to get your computer connected to your network, contact the person who set up your network or the router manufacturer as there might be a hardware issue with either your router or computer.

If you are able to access the Internet and are using a computer running Windows, you can also access HP Network Assistant at www.hp.com/sbso/wireless/tools-setup.html?jumpid=reg_R1002_USEN for help in setting up a network. (This Web site is only available in English.)

Make sure that the HP device is connected to your network

If your device is not connected to the same network as your computer, you will not be able to use the HP device over the network. Follow the steps described in this section to find out if your device is actively connected to the correct network.

Make sure the HP device is on the network

1. If the HP device supports Ethernet networking and is connected to an Ethernet network, make sure an Ethernet cable is not plugged into the back of the device. If an Ethernet cable is plugged into the back, then wireless connectivity is disabled.
2. If the HP device is connected to a wireless network, print the device's Wireless Configuration page. For more information, see [Understand the network configuration or wireless status report](#).
 - ▲ After the page has been printed, check the Network Status and URL:

Network Status	<ul style="list-style-type: none">• If the Network Status is Ready, the HP device is actively connected to a network.• If the Network Status is Offline, the HP device is not connected to a network. Run the Wireless Network Test (using the instructions at the beginning of this section) and follow any recommendations.
URL	The URL shown here is the network address assigned to the HP device by your router. You will need this to connect to the embedded Web server.

Check to see if you can access the embedded Web server (EWS)

- ▲ After you establish that the computer and the HP device both have active connections to a network, you can verify if they are on the same network by accessing the device's embedded Web server (EWS). For more information, see [Embedded Web server](#).

To access the EWS

- a. On your computer, open the Web browser you normally use to access the Internet (for example, Internet Explorer or Safari). In the address box, type the URL of the HP device as it was shown on the Network Configuration Page (for example, `http://192.168.1.101`).



NOTE: If you are using a proxy server in your browser, you might need to disable it to access the EWS.

- b. If you can access the EWS, try using the HP device over the network (such as to print) to see if your network setup was successful.
- c. If you cannot access the EWS or are still having problems using the HP device over the network, continue to the next section regarding firewalls.

Check to see if the firewall software is blocking communication

If you cannot access the EWS and are sure both the computer and HP device have active connections to the same network, the firewall security software might be blocking

communication. Temporarily turn off any firewall security software running on your computer and then try to access the EWS again. If you can access the EWS, try using the HP device (for printing).

If you are able to access the EWS and use your HP device with the firewall turned off, you will need to reconfigure your firewall settings to allow the computer and HP device to communicate with each other over the network.

If you are able to access the EWS but are still unable to use the HP device even with the firewall turned off, try enabling the firewall software to recognize the HP device.

Make sure the HP device is online and ready

If you have the HP software installed, you can check the HP device's status from your computer to see if the device is paused or offline, preventing you from using it.

To check the HP device's status, complete the following steps:

Windows

1. Click **Start**, point to **Settings**, and then click **Printers** or **Printers and Faxes**.
- Or -
Click **Start**, click **Control Panel**, and then double-click **Printers**.
2. If the printers on your computer are not being displayed in Details view, click the **View** menu, and then click **Details**.
3. Do one of the following, depending on the printer status:
 - a. If the HP device is **Offline**, right-click the device and click **Use Printer Online**.
 - b. If the HP device is **Paused**, right-click the device and click **Resume Printing**.
4. Try using the HP device over the network.

Mac OS X

1. Click **System Preferences** in the Dock, and then click **Print & Fax**.
2. Select the HP device, and then click **Print Queue**.
3. If **Jobs Stopped** appears in the window that appears, click **Start Jobs**.

If you can use the HP device after performing the steps above but find that the symptoms persist as you continue to use the device, your firewall might be interfering. If you still cannot use the HP device over the network, continue to the next section for additional troubleshooting help.

Your wireless router is using a hidden SSID

If your wireless router or Apple AirPort Base Station is using a hidden SSID, your HP device will not automatically detect the network.

Make sure the wireless version of the HP device is set as the default printer driver (Windows only)

If you install the software again, the installer might create a second version of the printer driver in your **Printers** or **Printers and Faxes** folder. If you have difficulties printing or

connecting to the HP device, make sure the correct version of the printer driver is set as the default.

1. Click **Start**, point to **Settings**, and then click **Printers** or **Printers and Faxes**.
- Or -
Click **Start**, click **Control Panel**, and then double-click **Printers**.
2. Determine if the version of the printer driver in the **Printers** or **Printers and Faxes** folder is connected wirelessly:
 - a. Right-click the printer icon, and then click **Properties**, **Document Defaults**, or **Printing Preferences**.
 - b. On the **Ports** tab, look for a port in the list with a checkmark. The version of the printer driver that is connected wirelessly has **Standard TCP/IP Port** as the Port description, next to the checkmark.
3. Right-click the printer icon for the version of the printer driver that is connected wirelessly and select **Set as Default Printer**.

 **NOTE:** If there is more than one icon in the folder for the HP device, right-click the printer icon for the version of the printer driver that is connected wirelessly and select **Set as Default Printer**.

Make sure the HP Network Devices Support service is running (Windows only)

To restart the HP Network Device Support service

1. Delete any print jobs currently in the print queue.
2. On the desktop, right-click **My Computer** or **Computer**, and then click **Manage**.
3. Double-click **Services and Applications**, and then click **Services**.
4. Scroll down the list of services, right click **HP Network Devices Support**, and then click **Restart**.
5. After the service restarts, try using the HP device over the network again.

If you are able to use the HP device over the network, your network setup was successful.

If you still cannot use the HP device over the network or if you have to periodically perform this step in order to use your device over the network, your firewall might be interfering.

If this still does not work, there might be a problem with your network configuration or router. Contact the person who set up your network or the router manufacturer for help.

Add hardware addresses to a wireless access point (WAP)

MAC filtering is a security feature in which a wireless access point (WAP) is configured with a list of MAC addresses (also called “hardware addresses”) of devices that are allowed to gain access to the network through the WAP. If the WAP does not have the hardware address of a device attempting to access the network, the WAP denies the device access to the network. If the WAP filters MAC addresses, then the device’s MAC address must be added to the WAP’s list of accepted MAC addresses.

- Print the network configuration page. For more information, see [Understand the network configuration or wireless status report](#).
- Open the WAP’s configuration utility, and add the device’s hardware address to the list of accepted MAC addresses.

Troubleshoot installation issues

If the following topics do not help, see [Support and warranty](#) for information about HP support.

- [Hardware installation suggestions](#)
- [Software installation suggestions](#)
- [Solve network problems](#)

Hardware installation suggestions

Check the device

- Make sure that all packing tape and material have been removed from outside and inside the device.
- Make sure that the device is loaded with paper.
- Make sure that no lights are on or blinking except the **Power** light, which should be on. If a light other than the **Power** light is on or blinking, there is an error. For more information, see [Control-panel lights reference](#).
- Make sure that the device can print a printer status page.
- Rear access panel or duplexer is locked into place.

Check the hardware connections

- Make sure that any cords and cables that you are using are in good working order.
- Make sure that the power cord is connected securely to both the device and to a working power outlet.

Check the printhead and ink cartridges

- Make sure that the printhead and all ink cartridges are firmly installed in their correct, colorcoded slot. Press down firmly on each one to ensure proper contact. The device cannot work if they are not all installed.
- Make sure that all latches and covers are closed properly.

Make sure the ink cartridges are properly installed

1. Make sure the product is turned on.
2. Open the ink cartridge access door by lifting from the front right of the product, until the door locks into place.



NOTE: Wait until the print carriage stops moving before proceeding.

3. Make sure the ink cartridges are installed in the correct slots.
Match the shape of the icon and color of the ink cartridge with the slot that has the same shaped icon and color.
4. Run your finger along the top of the ink cartridges to locate any cartridges that are not snapped completely down.
5. Press down on any cartridges that are sticking up.
They should snap down into place.

6. If an ink cartridge was sticking up and you were able to snap it back down into place, close the ink cartridge access door and check if the error has gone away.
 - If the error has gone away, stop troubleshooting here. The error has been resolved.
 - If the error has not gone away, proceed to the next step.
 - If none of the ink cartridges were sticking up, proceed to the next step.
7. Locate the ink cartridge that is indicated in the error , and then press the tab on the ink cartridge to release it from the slot.
8. Press the ink cartridge back down into place.

The tab should make a snapping noise when the ink cartridge is correctly seated. If the ink cartridge did not make a snapping noise, the tab might need to be readjusted.
9. Remove the ink cartridge from the slot.
10. Gently bend the tab away from the ink cartridge.

 **CAUTION:** Be careful not to bend the tab out more than about 1.27 cm (0.5 inches).

11. Reinstall the ink cartridge.

It should now snap down into place.
12. Close the ink cartridge access door, and check if the error has gone away.
13. If you still receive the error, turn the product off, and then on again.

Software installation suggestions

Check the computer system

- Make sure that your computer is running one of the supported operating systems.
- Make sure that the computer meets at least the minimum system requirements.
- In the Windows device manager, make sure that the USB drivers have not been disabled.
- If you are using a computer running Windows, and the computer cannot detect the device, run the uninstallation utility (utilccc\uninstall.bat on the Starter CD) to perform a clean uninstallation of the device driver. Restart your computer, and reinstall the device driver.

Verify installation preliminaries

- Make sure to use the Starter CD that contains the correct installation software for your operating system.
- Before installing software, make sure that all other programs are closed.
- If the computer does not recognize the path to the CD-ROM drive that you type, make sure that you are specifying the correct drive letter.
- If the computer cannot recognize the Starter CD in the CD-ROM drive, inspect the Starter CD for damage. You can download the device driver from the HP Web site (www.hp.com/support).

 **NOTE:** After correcting any problems, run the installation program again.

Solve network problems







General network troubleshooting

- If you are unable to install the device software, verify that:
 - All cable connections to the computer and the device are secure.
 - The network is operational and the network hub is turned on.
 - All applications, including virus protection programs, spyware protection programs, and firewalls, are closed or disabled for computers running Windows.
 - Make sure the device is installed on the same subnet as the computers that will be using the device.
 - If the installation program cannot discover the device, print the network configuration page and enter the IP address manually in the installation program. For more information, see [Understand the network configuration or wireless status report](#).
- If you are using a computer running Windows, make sure that the network ports created in the device driver match the device IP address:
 - Print the device's network configuration page.
 - Click **Start**, point to **Settings**, and then click **Printers** or **Printers and Faxes**.
- Or -
Click **Start**, click **Control Panel**, and then double-click **Printers**.
 - Right-click the device icon, click **Properties**, and then click the **Ports** tab.
 - Select the TCP/IP port for the device, and then click **Configure Port**.
 - Compare the IP address listed in the dialog box and make sure it matches the IP address listed on the network configuration page. If the IP addresses are different, change the IP address in the dialog box to match the address on the network configuration page.
 - Click **OK** twice to save the settings and close the dialog boxes.

Problems connecting to a wired network

- If the **Network** or **Wireless** light on the control panel does not turn on, make sure that all of the "General network troubleshooting" conditions are met.
- Though it is not recommended that you assign the device with a static IP address, you might resolve some installation problems (such as a conflict with a personal firewall) by doing so.

To reset the device's network settings

1. Press and hold  (**Network** button) (on some models, press the  **Wireless** button), press  (**Resume** button) three times, and release  (**Network** button). The Power light blinks for a few seconds. Wait until the Power light is on.
2. Press  (**Network** button) (on some models, press the  **Wireless** button), to print the network configuration page and verify that the network settings have been reset. By default, the network name (SSID) is "hpsetup" and the communication mode is "ad hoc."

Clear jams

Occasionally, media becomes jammed during a job. Try the following remedies before you attempt to clear the jam.

- Make sure that you are printing with media that meets specifications. For more information, see [Select print media](#).
- Make sure to print with media that is not wrinkled, folded, or damaged.
- Make sure that the input trays are loaded correctly and are not too full. For more information, see [Load media](#).
- [Clear a jam in the device](#)
- [Tips for avoiding jams](#)

Clear a jam in the device

To clear a jam

1. Remove all media from the output tray.

△ **CAUTION:** Trying to clear a paper jam from the front of the device can damage the print mechanism. Always access and clear paper jams through the rear access panel or duplexer.

2. Check the rear access panel or duplexer.

- a. Push the button on either side of the rear access panel or duplexer, and then remove the panel or unit.

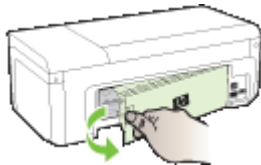

- b. Locate any jammed media inside the device, grasp it with both hands and then pull it towards you.
- c. If the jam is not there, and you are using a duplexer, push the latch on the top of the duplexer and lower its cover. If the jam is inside, carefully remove it. Close the cover.

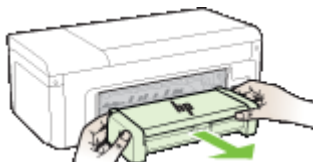

- d. Reinsert the rear access panel or duplexer into the device.

3. Open the top cover. If there is paper remaining inside the device, ensure the carriage has moved to the right of the device, free any paper scraps or wrinkled media, and pull the media towards you through the top of the device.

⚠ **WARNING!** Do not reach into the device when it is on and the carriage is stuck. When you open the top cover, the carriage should return to its position on the right side of the device. If it does not move to the right, turn off the device before you remove any jam.

4. After clearing the jam, close all covers, turn on the device (if you turned it off) and resend the print job.

Tips for avoiding jams

- Make sure that nothing is blocking the paper path.
- Do not overload the trays. For more information, see [Understand specifications for supported media](#).
- Load paper properly and when the device is not printing. For more information, see [Load media](#).
- Do not use media that is curled or crumpled.
- Always use media that conforms with specifications. For more information, see [Select print media](#).
- Make sure the output tray is not overly full.
- Make sure the media guide are adjusted snugly against the media, but do not crinkle or bend the media.

Errors (Windows)

- [Printhead Problem - The printhead appears to be missing or damaged](#)
- [Incompatible Printhead](#)
- [Printhead problem and advanced printhead maintenance](#)
- [Device Disconnected](#)
- [Ink Alert](#)
- [Cartridge Problem](#)
- [Cartridge Problem](#)
- [Paper Mismatch](#)
- [The cartridge cradle cannot move](#)
- [Paper Jam](#)
- [The printer is out of paper.](#)
- [Incompatible Cartridge\(s\)](#)
- [Printer Offline](#)
- [Printer Paused](#)
- [Document failed to print](#)
- [Previously used genuine HP cartridge](#)
- [Ink Service Capacity Warning](#)
- [General printer error](#)

Printhead Problem - The printhead appears to be missing or damaged

Use the following to correct the error:

[Advanced printhead maintenance](#)

Incompatible Printhead

The printhead installed is not intended for use in this printer, or it may be damaged

Use the following to correct the error:

- [Advanced printhead maintenance](#)
- [Supplies](#)

Printhead problem and advanced printhead maintenance

This section covers the following topics:

- [Printhead problem - The following printhead has a problem](#)
- [Advanced printhead maintenance](#)

Printhead problem - The following printhead has a problem

Use the following to correct the error:

- [Advanced printhead maintenance](#)
- [Supplies](#)

Advanced printhead maintenance

⚠ **WARNING!** Only reinstall the printhead as part of the procedure for **Printhead Problem** error messages

To reinstall the printhead

1. Make sure that the product is turned on.
2. Open the ink cartridge door.



3. Remove all of the ink cartridges and place them on a piece of paper with the ink opening pointing up.

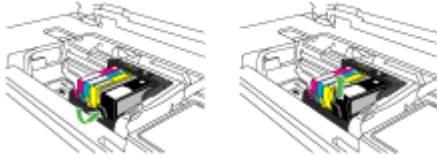

4. Lift the latch handle on the print carriage.

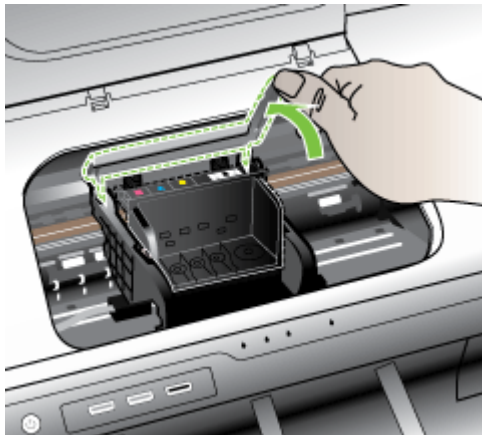

5. Remove the printhead by lifting it straight up.

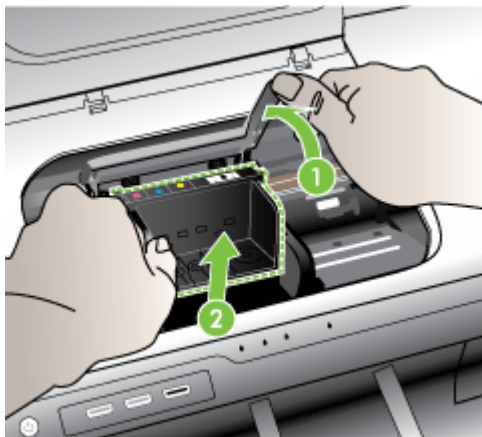

6. Clean the printhead.

There are three areas of the printhead that need to be cleaned: the plastic ramps on both sides of the ink nozzles, the edge between the nozzles and the electrical contacts, and the electrical contacts.

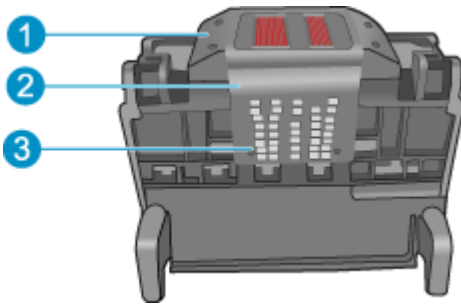

1	Plastic ramps on the sides of the nozzles
2	Edge between nozzles and contacts
3	Electrical contacts

△ **CAUTION:** Touch the nozzle and the electrical contact areas **only** with cleaning materials and not with your finger.

To clean the printhead

- a. Lightly dampen a clean, lint-free cloth and wipe the electrical contact area from the bottom to the top. Do not go past the edge between the nozzles and the electrical contacts. Clean until no new ink shows on the cloth.

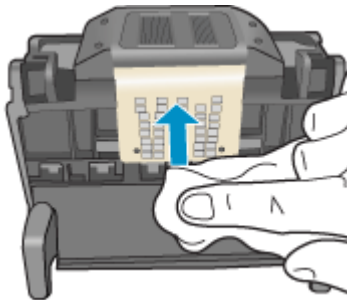

- b. Use a fresh, lightly dampened, lint-free cloth to wipe any accumulated ink and debris from the edge between the nozzles and the contacts.

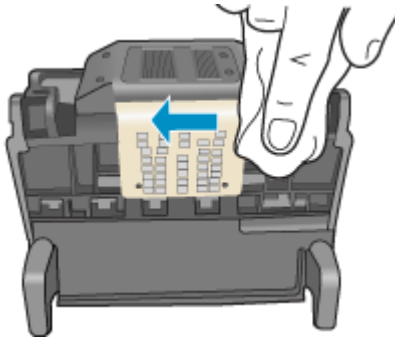

- c. Use a fresh, lightly dampened, lint-free cloth to wipe the plastic ramps on both sides of the nozzles. Wipe away from the nozzles.



- d. Wipe the previously cleaned areas dry with a dry lint-free cloth before proceeding to the next step.

7. Clean the electrical contacts inside the product.

To clean the electrical contacts in the product

- a. Lightly dampen a clean, lint-free cloth with bottled or distilled water.
- b. Clean the electrical contacts in the product by wiping with the cloth from top to bottom. Use as many fresh, clean cloths as necessary. Clean until no ink shows on the cloth.

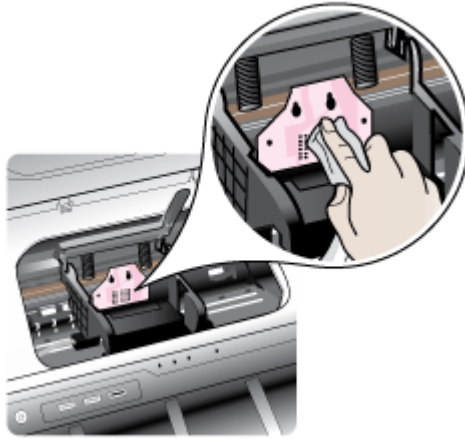

- c. Wipe the area dry with a dry lint-free cloth before proceeding to the next step.
8. Make sure the latch handle is raised, and then reinsert the printhead.

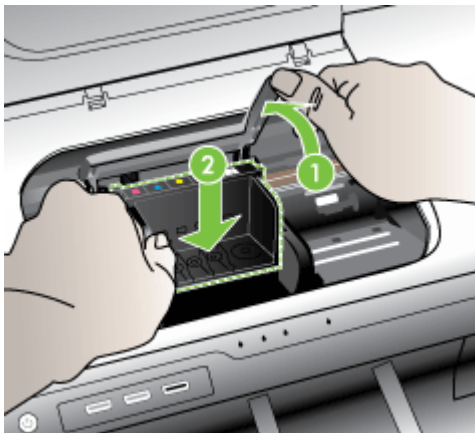

9. Carefully lower the latch handle.

 **NOTE:** Make sure you lower the latch handle before reinserting the ink cartridges. Leaving the latch handle raised can result in incorrectly seated ink cartridges and problems printing. The latch must remain down in order to correctly install the ink cartridges.

10. Using the colored shaped icons for help, slide the ink cartridge into the empty slot until it clicks into place and is seated firmly in the slot.



11. Close the ink cartridge door.

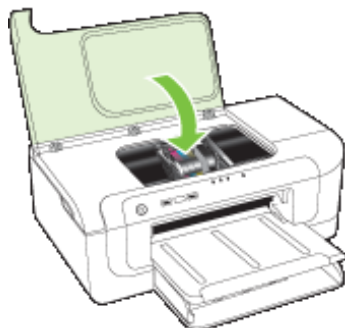

Device Disconnected

Use the following to correct the error:

[Hardware installation suggestions](#)

Ink Alert

Choose your error

- [HP recommends you have a replacement available for when print quality becomes no longer acceptable.](#)
- [The amount of ink in the following cartridge may be low enough to cause poor print quality and cartridge changes may be required soon. HP recommends you have replacement cartridges available to install when print quality is no longer acceptable.](#)
- [Ink system failure](#)

HP recommends you have a replacement available for when print quality becomes no longer acceptable.

Use the following to correct the error:

- [Replace the ink cartridges](#)
- [Supplies](#)

 **NOTE:** Ink level alerts and indicators provide estimates for planning purposes only. When you receive a low-ink alerts, consider having a replacement cartridge available to avoid possible printing delays. You do not need to replace the ink cartridges until print quality becomes unacceptable.

For information on recycling used ink supplies, see [HP inkjet supplies recycling program](#).

The amount of ink in the following cartridge may be low enough to cause poor print quality and cartridge changes may be required soon. HP recommends you have replacement cartridges available to install when print quality is no longer acceptable.

Use the following to correct the error:

- [Replace the ink cartridges](#)
- [Supplies](#)

 **NOTE:** Ink level alerts and indicators provide estimates for planning purposes only. When you receive a low-ink alerts, consider having a replacement cartridge available to avoid possible printing delays. You do not need to replace the ink cartridges until print quality becomes unacceptable.

For information on recycling used ink supplies, see [HP inkjet supplies recycling program](#).

Ink system failure

Use the following to correct the error:

Turn off the product, unplug the power cord, and wait 10 seconds. Then, plug the power cord back in and turn on the product.

If you continue to receive this message, write down the error code provided in the message on the product display, and then contact HP support. Go to www.hp.com/support.

If prompted, choose your country/region, and then click **Contact HP** for information on calling for technical support.

Cause: The printhead or the ink delivery system failed and the product can no longer print.

Cartridge Problem

Choose your error

- [The following cartridge appears to be missing or damaged](#)
- [Cartridge\(s\) in Wrong Slot - The following cartridges are in the wrong slots](#)

The following cartridge appears to be missing or damaged

Use the following to correct the error:

- [Replace the ink cartridges](#)
- [Supplies](#)



NOTE: Ink level alerts and indicators provide estimates for planning purposes only. When you receive a low-ink alerts, consider having a replacement cartridge available to avoid possible printing delays. You do not need to replace the ink cartridges until print quality becomes unacceptable.

For information on recycling used ink supplies, see [HP inkjet supplies recycling program](#).

Cartridge(s) in Wrong Slot - The following cartridges are in the wrong slots

Make sure the ink cartridges are in the proper slot.

Use the following to correct the error:

[Replace the ink cartridges](#)

Cartridge Problem

The following cartridge has a problem

Use the following to correct the error:

- [Replace the ink cartridges](#)
- [Supplies](#)
- [HP inkjet supplies recycling program](#)

Paper Mismatch

Paper detected does not match paper size or type selected

Use the following to correct the error:

- [Load media](#)
- [Print on special and custom-sized media](#)
- [Change print settings](#)

The cartridge cradle cannot move

Please turn device power off. Check device for a paper jam or other obstruction

Use the following to correct the error:

- [Clear a jam in the device](#)
- [Hardware installation suggestions](#)

Paper Jam

There is a paper jam (or misfeed). Clear the jam and press the Resume button on the printer

Use the following to correct the error:

[Clear a jam in the device](#)

The printer is out of paper.

Load more paper and press the Resume button on the front of the printer

Use the following to correct the error:

[Load media](#)

Incompatible Cartridge(s)

Choose your error

- [The following cartridge is not intended for use in this printer](#)
- [The following cartridges are not intended for use in this printer as it is currently configured](#)

The following cartridge is not intended for use in this printer

Use the following to correct the error:

- [Replace the ink cartridges](#)
- [Supplies](#)
- [HP inkjet supplies recycling program](#)

The following cartridges are not intended for use in this printer as it is currently configured

Use the following to correct the error:

- [Replace the ink cartridges](#)
- [Supplies](#)
- [HP inkjet supplies recycling program](#)

Printer Offline

Your printer is currently offline

Use the following to correct the error:

To check if the printer is paused or offline (Windows)

1. Depending upon your operating system, do one of the following:
 - Windows Vista: On the Windows taskbar, click **Start**, click **Control Panel**, and then click **Printers**.
 - Windows XP: On the Windows taskbar, click **Start**, click **Control Panel**, and then click **Printers and Faxes**.
2. Double-click the icon for your product to open the print queue.

3. On the **Printer** menu, make sure there are no check marks next to **Pause Printing** or **Use Printer Offline**.
4. If you made any changes, try to print again.

To check if the printer is paused or offline (Mac OS X)

1. Click **System Preferences**, click **Print & Fax**, and then click select the printer you want to use.
2. Double-click the icon for your product to open the print queue.
3. If **Hold** is selected, click **Resume**.
4. If you made any changes, try to print again.

Printer Paused

Your printer is currently paused

Use the following to correct the error:

[Printer Offline](#)

Document failed to print

The job failed to print due to an error in the printing system.

[Solve printing problems.](#)

Previously used genuine HP cartridge

The following cartridges are previously used:

The genuine HP ink cartridge was previously used in some other product.

Check the print quality of the current print job. If it is not satisfactory, try cleaning the printhead to see if that improves the quality.

Follow the prompts on the display or computer screen to continue.

For more information, see [Clean the printhead](#).



NOTE: HP recommends that you do not leave the ink cartridge outside of the printer for an extended period of time. If a used cartridge is installed, check the print quality. If it is not satisfactory, run the cleaning procedure from the toolbox.

Ink Service Capacity Warning

If you are going to move or transport the product after receiving this message, make sure you keep it upright and do not tip it on its side to avoid ink leakage.

Printing can continue, but ink system behavior might change.

The product has nearly maximized the ink service capacity.

General printer error

If you are going to move or transport the product after receiving this message, make sure you keep it upright and do not tip it on its side to avoid ink leakage. There was a problem with the product.

Write down the error code provided in the message, and then contact HP support. Go to:

www.hp.com/support.

If prompted, choose your country/region, and then click **Contact HP** for information on calling for technical support.



6 Control-panel lights reference

The control-panel lights indicate status and are useful for diagnosing printing problems. This section contains information about the lights, what they indicate, and what action to take if necessary.



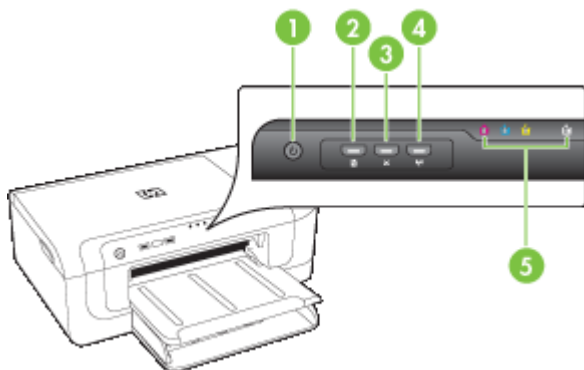





- [Interpreting control-panel lights](#)

Interpreting control-panel lights





1	Power button and light
2	Resume button and light
3	Cancel button
4	Network button  (available with some models) Wireless button  (available with some models)
5	Ink cartridge lights



For more information, visit the HP Web site (www.hp.com/support) for the latest troubleshooting information, or product fixes and updates.

Light description/Light pattern	Explanation and recommended action
<p>All lights are off.</p> 	<p>The device is off.</p> <ul style="list-style-type: none"> Connect the power cable. Press  (Power button).
<p>The Power light is on.</p> 	<p>The device is ready. No action is required.</p>
<p>The Power light blinks.</p> 	<p>The device is turning on or off, or is processing a print job. No action is required.</p> <p>The device is pausing for the ink to dry. Wait for the ink to dry.</p>
<p>The Power light and the Resume light blink.</p> 	<p>Print media is jammed in the device.</p> <p>Remove all media from the output tray. Locate and clear the jam. For more information, see Clear a jam in the device.</p> <p>The device carriage has stalled.</p> <ul style="list-style-type: none"> Open the top cover and remove any obstructions (such as jammed media). Press  (Resume button) to continue printing. If the error persists, turn the device off, and then on again.
<p>The Power light is on and the Resume light blinks.</p> 	<p>The device is out of paper. Load paper and press  (Resume button).</p> <p>The media width setting does not match the media loaded. Change the media setting in the print driver to match the media</p>



(continued)

Light description/Light pattern	Explanation and recommended action
	loaded. For more information, see Print on special and custom-sized media
<p>The Power light and the Resume light are on.</p> 	<p>A cover is not closed completely. Make sure all covers are completely closed.</p>
<p>The Power light is on and the ink cartridge lights blink one after the other, from left to right.</p> 	<p>The printhead is missing or faulty</p> <ul style="list-style-type: none"> • Ensure the indicated printhead is properly installed. • If the error persists, replace the printhead.



(continued)

Light description/Light pattern	Explanation and recommended action
<p data-bbox="240 192 829 239">The Power light blinks and the ink cartridge lights blink one after the other, from left to right.</p> 	<p data-bbox="854 192 1144 215">The printhead is incompatible.</p> <ul data-bbox="854 227 1160 352" style="list-style-type: none"><li data-bbox="854 227 1160 296">• Ensure the indicated printhead is properly installed.<li data-bbox="854 309 1160 352">• If the error persists, replace the printhead.
<p data-bbox="240 814 829 861">The Power light is on and one or more of the ink cartridge lights blink.</p> 	<p data-bbox="854 814 1072 861">One or more of the ink cartridges are missing.</p> <p data-bbox="854 873 1135 920">There is a duplicate cartridge installed in the device.</p> <ul data-bbox="854 932 1160 1104" style="list-style-type: none"><li data-bbox="854 932 1160 1048">• Install the indicated ink cartridge, and then try to print. Remove and re-insert the ink cartridge a few times if necessary.<li data-bbox="854 1055 1160 1104">• If the error persists, replace the indicated ink cartridge. <p data-bbox="854 1116 1156 1163">Ink level is low and might affect print quality.</p> <p data-bbox="854 1175 1131 1269">Replace the indicated ink cartridge. For ordering information, see HP supplies and accessories.</p> <p data-bbox="854 1281 1160 1520">NOTE: Ink level alerts and indicators provide estimates for planning purposes only. When you receive a low-ink alert, consider having a replacement cartridge available to avoid possible printing delays. You do not need to replace the ink cartridges until print quality becomes unacceptable.</p>

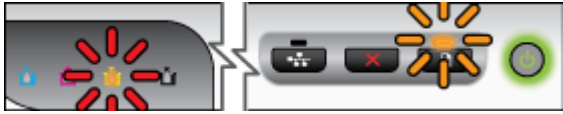

(continued)

Light description/Light pattern	Explanation and recommended action
<p>The Power light and one or more of the ink cartridge lights blink.</p> 	<p>One or more of the ink cartridges are faulty, need attention, incorrect, missing, damaged, or incompatible.</p> <ul style="list-style-type: none"> • Ensure the indicated ink cartridge is properly installed, and then try to print. Remove and re-insert the ink cartridge a few times if necessary. • If the error persists, replace the indicated ink cartridge.
<p>The Power light is on, and one or more of the ink cartridge lights are on.</p> 	<p>One or more of the ink cartridges are low on ink and will need to be replaced soon.</p> <p>Get new ink cartridges and replace the existing cartridges when the print quality becomes unacceptable.</p> <p>NOTE: Ink level alerts and indicators provide estimates for planning purposes only. When you receive a low-ink alert, consider having a replacement cartridge available to avoid possible printing delays.</p>

(continued)

Light description/Light pattern	Explanation and recommended action
<p data-bbox="240 192 826 239">The Power light is on, and the Resume light and one or more ink cartridge lights blink.</p>  <p>The diagram shows two views of a printer's control panel. The left view shows a power button with a lit power icon and a resume button with a lit resume icon. The right view shows a power button with a lit power icon, a resume button with a lit resume icon, and four ink cartridge lights (cyan, magenta, yellow, black) that are all lit. A speech bubble connects the two views, indicating that the power and resume lights are on while the ink cartridge lights are lit.</p>	<p data-bbox="854 192 1087 239">One of the following has occurred.</p> <ul data-bbox="854 253 1160 470" style="list-style-type: none">• One or more of the ink cartridges are almost depleted and may result in poor print quality. Replace the existing ink cartridges to avoid poor print quality. To continue printing using the existing ink cartridges, press  (Resume button). <p data-bbox="892 531 1160 748">NOTE: Ink level alerts and indicators provide estimates for planning purposes only. When you receive a low-ink alert, consider having a replacement cartridge available to avoid possible printing delays.</p> <ul data-bbox="854 762 1154 881" style="list-style-type: none">• One or more of the ink cartridges are depleted. Replace the existing ink cartridges with genuine HP ink cartridges. <p data-bbox="892 895 1160 1182">CAUTION: HP cannot guarantee the quality or reliability of non-HP supplies. Product failure or damage attributable to the use of non-HP ink cartridge will not be covered under warranty. If you believe you have purchased a genuine HP ink cartridge, visit www.hp.com/go/anticounterfeit.</p>

(continued)

Light description/Light pattern	Explanation and recommended action
	<p>To continue printing using the existing ink cartridges, press  (Resume button).</p> <ul style="list-style-type: none"> You have just installed a new printhead and the ink in the ink cartridge is low. There might be insufficient ink to initialize the printhead. Make sure the indicated ink cartridge is properly installed. If this symptom persists, replace the indicated ink cartridge with new ink cartridge or press  (Resume button) to continue using the existing ink cartridge.
<p>All lights are on.</p> 	<p>A non-recoverable error has occurred. Unplug the power cord, and then plug the power cord back in, and try printing.</p>

A HP supplies and accessories

This section provides information on HP supplies and accessories for the device. The information is subject to changes, visit the HP Web site (www.hpshopping.com) for the latest updates. You may also make purchases through the Web site.

- [Order printing supplies online](#)
- [Accessories](#)
- [Supplies](#)

Order printing supplies online

To order supplies online or create a printable shopping list, open the HP Solution Center desktop icon that was installed by your HP printer software and click the **Shopping** icon. Select **Shop Online** or **Print My Shopping List**. HP Solution Center uploads, with your permission, printer information, including model number, serial number, and estimated ink levels. The HP supplies that work in your printer are pre-selected. You can change quantities, add or remove items, and then print the list or purchase online at the HP Store or other online retailers (options differ by country/region). Cartridge information and links to online shopping also appear on ink alert messages.

You can also order online by visiting www.hp.com/buy/supplies. If prompted, choose your country/region, follow the prompts to select your product, and then the supplies you need.

 **NOTE:** Ordering cartridges online is not supported in all countries/regions. However, many countries have information on ordering by telephone, locating a local store and printing a shopping list. In addition, you can select the 'How to Buy' option at the top of the www.hp.com/buy/supplies page to obtain information about purchasing HP products in your country.

Accessories

 **NOTE:** Depending on your country/region, some of these accessories might not be available. For more information, go to www.hp.com/support.

HP USB Network Print Adapter	Q6275A	USB 2.0 printer adapter that allows you to share the device with multiple computers.
HP Wireless Printing Upgrade Kit	Q6236A, Q6259A	Upgrade non-wireless devices to use 802.11g wireless technology
HP Wireless G Print Server	Q6301A, Q6302A	802.11g print server for wireless communication to a computer

Supplies

This section covers the following topics:

- [Ink cartridges](#)
- [HP media](#)

Ink cartridges

Ordering cartridges online is not supported in all countries/regions. However, many countries have information on ordering by telephone, locating a local store and printing a shopping list. In addition, you can select the 'How to Buy' option at the top of the www.hp.com/buy/supplies page to obtain information about purchasing HP products in your country.

You can find the ink cartridge number in the following places:

- On the Information page of the embedded Web server (see [Embedded Web server](#)).
- **Windows:** From the **Toolbox**, if you have bidirectional communication, click the **Estimated Ink Levels** tab, scroll to display the **Cartridge Details** button, and then click **Cartridge Details**.
- **Mac OS X:** From the **HP Printer Utility**, click **Supply Info** from the **Information and Support** panel, and then click **Retail Supplies Information**.
- On the label of the ink cartridge you are replacing.
- **Solution Center:** From the Solution Center you can view supplies information from the **Shopping** tab or the estimated ink level screen.
- On the printer status page (see [Understand the printer status page](#)).

 **NOTE:** Ink level warnings and indicators provide estimates for planning purposes only. When you receive a low-ink warning message, consider having a replacement cartridge available to avoid possible printing delays. You do not need to replace cartridges until prompted to do so.

HP media

To order media such as HP Premium Paper, go to www.hp.com.

	<p>HP recommends plain papers with the ColorLok logo for printing everyday documents. All papers with the ColorLok logo are independently tested to meet high standards of reliability and print quality, and produce documents with crisp, vivid color, bolder blacks & dry faster than ordinary plain papers. Look for papers with the ColorLok logo in a variety of weights and sizes from major paper manufacturers.</p>
---	--

B Support and warranty

The information in [Maintain and troubleshoot](#) suggests solutions to common problems. If your device is not operating correctly and those suggestions did not solve your problem, try using one of the following support services to obtain assistance.

This section contains the following topics:

- [Obtain electronic support](#)
- [Obtain HP telephone support](#)
- [Hewlett-Packard limited warranty statement](#)
- [Ink cartridge warranty information](#)
- [Prepare the device for shipment](#)
- [Pack the device](#)

Obtain electronic support

To find support and warranty information, go to the HP Web site at www.hp.com/support. If prompted, choose your country/region, and then click **Contact HP** for information on calling for technical support.

This Web site also offers technical support, drivers, supplies, ordering information and other options such as:

- Access online support pages.
- Send HP an e-mail message for answers to your questions.
- Connect with an HP technician by using online chat.
- Check for software updates.

You can also obtain support from HP from the following electronic sources:

- **Toolbox (Windows):** The Toolbox provides easy, step-by-step solutions to common printing problems. For more information, see [Toolbox \(Windows\)](#).
- **Embedded Web server:** When the device is connected to a network, you can use the embedded Web server to view status information, change settings, and manage the device at your computer. For more information, see [Embedded Web server](#).

Support options and availability vary by product, country/region, and language.

Obtain HP telephone support

During the warranty period, you may obtain assistance from the HP Customer Care Center.

 **NOTE:** HP does not provide telephone support for Linux printing. All support is provided online at the following web site: <https://launchpad.net/hplip>. Click the **Ask a question** button to begin the support process.

If you are using Windows or Mac OS X, these operating systems are not supported by HPLIP. Please go to the HP web site for additional support and assistance.

This section contains the following topics:

- [Before you call](#)
- [Support process](#)
- [HP support by phone](#)
- [Additional warranty options](#)
- [HP Quick Exchange Service \(Japan\)](#)
- [HP Korea customer support](#)

Before you call

Visit the HP Web site (www.hp.com/support) for the latest troubleshooting information, or product fixes and updates.

Software programs from other companies might be included with the HP device. If you experience problems with any of those programs, you will receive the best technical assistance by calling the experts at that company.

 **NOTE:** This information does not apply to customers in Japan. For information on service options in Japan, see [HP Quick Exchange Service \(Japan\)](#).

To assist our Customer Care Center representatives to serve you better, prepare the following information if you need to call HP.

1. Print the printer status page of the device. For more information, see [Understand the printer status page](#). If the device does not print, get the following information ready:
 - Device model
 - Model number and serial number (check the back of the device)
2. Check the operating system that you are using, such as Windows XP.
3. If the device is connected to the network, check the network operating system.
4. Note how the device is connected to your system, such as through USB or network connection.
5. Obtain the version number of the printer software. (To find the version number of the printer driver, open the printer settings or properties dialog box, and click the **About** tab.)
6. If you have a problem printing from a particular application, note the application and version number.

Support process

If you have a problem, follow these steps

1. Check the documentation that came with the device.
2. Visit the HP online support Web site at www.hp.com/support. HP online support is available to all HP customers. It is the fastest source for up-to-date device information and expert assistance and includes the following features:
 - Fast access to qualified online support specialists
 - Software and driver updates for the HP device

- Valuable troubleshooting information for common problems
 - Proactive device updates, support alerts, and HP newsgrams that are available when you register the HP device
3. Call HP support. Support options and availability vary by device, country/region, and language.

HP support by phone

The phone support numbers and associated costs listed here are those in effect at time of this material publication. For the most current HP list of telephone support numbers and call-cost information, see www.hp.com/support.

This section contains the following topics:

- [Phone support period](#)
- [Telephone support numbers](#)
- [Placing a call](#)
- [After the phone support period](#)

Phone support period

One year of phone support is available in North America, Asia Pacific, and Latin America (including Mexico).

To determine the duration of phone support in Europe, the Middle East, and Africa, go to www.hp.com/support. Standard phone company charges apply.

Telephone support numbers

For the most current list of telephone support numbers, see www.hp.com/support.



www.hp.com/support

Africa (English speaking)	+27 11 2345872
Afrique (francophone)	+33 1 4993 9230
021 672 280	الجزائر
Argentina (Buenos Aires)	54 11 4708 1600 0-800-555-5000
Australia	1300 721 147
Australia (out-of-warranty)	1902 910 910
Österreich	+43 0820 87 4417 0,145 € p/m
17212049	البحرين
België	+32 070 300 005 0,174 €
Belgique	+32 070 300 004 0,174 €
Brasil (Sao Paulo)	55-11-4004-7751
Brasil	0-800-709-7751
Canada	1-(800)-474-6836 (1-800 hp invent)
Central America & The Caribbean	www.hp.com/support
Chile	800-360-999
中国	1068687980
中国	800-810-3888
Colombia (Bogotá)	571 606 9191
Colombia	01-8000-51-4746-8368
Costa Rica	0-800-011-1046
Česka republika	810 222 222
Danmark	+45 70 202 045 0,25 DKK
Ecuador (Andinatel)	1-999-119 ☎ 800-711-2884
Ecuador (Pacifitel)	1-800-225-528 ☎ 800 711 2884
(02) 6910602	مصر
El Salvador	800-6160
España	+34 902 010 059 0,078 €
France	+33 0892 69 60 22 0,337 €
Deutschland	+49 01805 652 180 0,14 € aus dem deutschen Fernnetz - bei Anrufen aus Mobilfunknetzen können andere Preise gelten
Ελλάδα (από το εξωτερικό)	+ 30 210 6073603
Ελλάδα (εντός Ελλάδας)	801 11 75400
Ελλάδα (από Κύπρο)	800 9 2654
Guatemala	1-800-/11-2884
香港特別行政區	(852) 2802 4096
Magyarország	06 40 200 629
India	1-800-425-7737
India	91-80-28526900
Indonesia	+62 (21) 350 3408
+971 4 224 9189	العراق
+971 4 224 9189	الكويت
+971 4 224 9189	لبنان
+971 4 224 9189	قطر
+971 4 224 9189	اليمن
Ireland	+353 1890 923 902 0,05 €
1-700-503-048	ישראל
Italia	+39 848 800 871 0,023 €

Jamaica	1-800-711-2884
日本	0570-000511
日本	03-3335-9800
0800 222 47	الأردن
한국	1588-3003
Luxembourg (Français)	+352 900 40 006 0,161 €
Luxemburg (Deutsch)	+352 900 40 007 0,161 €
Malaysia	1800 88 8588
Mauritius	(230) 262 210 404
México (Ciudad de México)	55-5258-9922
México	01-800-472-68368
Maroc	081 005 010
Nederland	+31 0900 2020 165 0,20 €
New Zealand	0800 441 147
Nigeria	(01) 271 2320
Norge	+47 815 62 070 0,39 NOK
24791773	عمان
Panamá	1-800-711-2884
Paraguay	009 800 51 1 0006
Perú	0-800-10111
Philippines	2 867 3551
Polska	801 800 735
Portugal	+351 800 201 492 0,024 €
Puerto Rico	1-877-232-0589
República Dominicana	1-800-711-2884
Réunion	0820 890 323
Romania	0801 033 390
Россия (Москва)	095 777 3284 0,03 €
Россия (Санкт- Петербург)	812 332 4240 0,08 €
800 897 1415	السعودية
Singapore	+65 6272 5300
Slovensko	0850 111 256
South Africa (RSA)	0860 104 771
Suomi	+358 0 203 66 767 0,015 €
Sverige	+46 077 120 4765 0,23 SEK
Switzerland	+41 0848 672 672 0,08 CHF
臺灣	02-8722-8000
ไทย	+66 (2) 353 9000
071 891 391	تونس
Trinidad & Tobago	1-800-711-2884
Türkiye (İstanbul, Ankara, İzmir & Bursa)	444 0307
Україна	(044) 230-51-06
600 54 47 47	الإمارات العربية المتحدة
United Kingdom	+44 0870 010 4320 0,05 £
United States	1-(800)-474-6836
Uruguay	0004-054-177
Venezuela (Caracas)	58-212-278-8666
Venezuela	0-800-474-68368
Việt Nam	+84 88234530

Placing a call

Call HP support while you are in front of the computer and the HP device. Be prepared to provide the following information:

- Model number (located on the label on the front of the device)
- Serial number (located on the back or bottom of the device)
- Messages that appear when the situation occurs
- Answers to these questions:
 - Has this situation happened before?
 - Can you re-create it?
 - Did you add any new hardware or software to your computer at about the time that this situation began?
 - Did anything else occur prior to this situation (such as a thunderstorm, HP device was moved, etc.)?

After the phone support period

After the phone support period, help is available from HP at an additional cost. Help may also be available at the HP online support Web site: www.hp.com/support. Contact your HP dealer or call the support phone number for your country/region to learn more about support options.

Additional warranty options

Extended service plans are available for the HP device additional costs. Go to www.hp.com/support, select your country/region and language, then explore the services and warranty area for information about the extended service plans.

HP Quick Exchange Service (Japan)

HP クイック・エクステンジサービス

製品に問題がある場合は、以下に記載されている電話番号に連絡してください。故障している、または問題があると判断された場合、保障期間中は無料で製品を交換し、故障した製品を回収します。

電話番号： 0570-000511 (ナビダイヤル)
03-3335-9800 (ナビダイヤルをご利用いただけない場合)

サポート時間： 平日の午前 9:00 から午後 5:00 まで
土日の午前 10:00 から午後 5:00 まで
祝祭日および 1月 1日から 3日は除きます。

サービスの条件：

- サポートの提供は、カスタマケアセンターを通してのみ行われます。
- カスタマケアセンターがプリンタの不具合と判断した場合に、サービスを受けることができます。
ご注意：ユーザの扱いが不適切であったために故障した場合は、保障期間中であっても修理は有料となります。詳細については保証書を参照してください。

その他の制限：

- 運搬の時間はお住まいの地域によって異なります。詳しくは、カスタマケアセンターに連絡してご確認ください。
- 出荷配送は、当社指定の配送業者が行います。
- 配送は交通事情などの諸事情によって、遅れる場合があります。
- このサービスは、将来予告無しに変更することがあります。

For instructions on how to pack your product for exchange, see [Pack the device](#).

HP Korea customer support

HP 한국 고객 지원 문의

- 고객 지원 센터 대표 전화
1588-3003
- 제품가격 및 구입처 정보 문의 전화
080-703-0700
- 전화 상담 가능 시간:
평 일 09:00~18:00
토요일 09:00~13:00
(일요일, 공휴일 제외)

Hewlett-Packard limited warranty statement

HP product	Duration of limited warranty
Software Media	90 days
Printer	1 year
Print or Ink cartridges	Until the HP ink is depleted or the "end of warranty" date printed on the cartridge has been reached, whichever occurs first. This warranty does not cover HP ink products that have been refilled, remanufactured, refurbished, misused, or tampered with.
Printheads (only applies to products with customer replaceable printheads)	1 year
Accessories	1 year unless otherwise stated

A. Extent of limited warranty

- Hewlett-Packard (HP) warrants to the end-user customer that the HP products specified above will be free from defects in materials and workmanship for the duration specified above, which duration begins on the date of purchase by the customer.
- For software products, HP's limited warranty applies only to a failure to execute programming instructions. HP does not warrant that the operation of any product will be interrupted or error free.
- HP's limited warranty covers only those defects that arise as a result of normal use of the product, and does not cover any other problems, including those that arise as a result of:
 - Improper maintenance or modification;
 - Software, media, parts, or supplies not provided or supported by HP;
 - Operation outside the product's specifications;
 - Unauthorized modification or misuse.
- For HP printer products, the use of a non-HP cartridge or a refilled cartridge does not affect either the warranty to the customer or any HP support contract with the customer. However, if printer failure or damage is attributable to the use of a non-HP or refilled cartridge or an expired ink cartridge, HP will charge its standard time and materials charges to service the printer for the particular failure or damage.
- If HP receives, during the applicable warranty period, notice of a defect in any product which is covered by HP's warranty, HP shall either repair or replace the product, at HP's option.
- If HP is unable to repair or replace, as applicable, a defective product which is covered by HP's warranty, HP shall, within a reasonable time after being notified of the defect, refund the purchase price for the product.
- HP shall have no obligation to repair, replace, or refund until the customer returns the defective product to HP.
- Any replacement product may be either new or like-new, provided that it has functionality at least equal to that of the product being replaced.
- HP products may contain remanufactured parts, components, or materials equivalent to new in performance.
- HP's Limited Warranty Statement is valid in any country where the covered HP product is distributed by HP. Contracts for additional warranty services, such as on-site service, may be available from any authorized HP service facility in countries where the product is distributed by HP or by an authorized importer.

B. Limitations of warranty

TO THE EXTENT ALLOWED BY LOCAL LAW, NEITHER HP NOR ITS THIRD PARTY SUPPLIERS MAKES ANY OTHER WARRANTY OR CONDITION OF ANY KIND, WHETHER EXPRESS OR IMPLIED WARRANTIES OR CONDITIONS OF MERCHANTABILITY, SATISFACTORY QUALITY, AND FITNESS FOR A PARTICULAR PURPOSE.

C. Limitations of liability

- To the extent allowed by local law, the remedies provided in this Warranty Statement are the customer's sole and exclusive remedies.
- TO THE EXTENT ALLOWED BY LOCAL LAW, EXCEPT FOR THE OBLIGATIONS SPECIFICALLY SET FORTH IN THIS WARRANTY STATEMENT, IN NO EVENT SHALL HP OR ITS THIRD PARTY SUPPLIERS BE LIABLE FOR DIRECT, INDIRECT, SPECIAL, INCIDENTAL, OR CONSEQUENTIAL DAMAGES, WHETHER BASED ON CONTRACT, TORT, OR ANY OTHER LEGAL THEORY AND WHETHER ADVISED OF THE POSSIBILITY OF SUCH DAMAGES.

D. Local law

- This Warranty Statement gives the customer specific legal rights. The customer may also have other rights which vary from state to state in the United States, from province to province in Canada, and from country to country elsewhere in the world.
- To the extent that this Warranty Statement is inconsistent with local law, this Warranty Statement shall be deemed modified to be consistent with such local law. Under such local law, certain disclaimers and limitations of this Warranty Statement may not apply to the customer. For example, some states in the United States, as well as some governments outside the United States (including provinces in Canada), may:
 - Preclude the disclaimers and limitations in this Warranty Statement from limiting the statutory rights of a consumer (e.g., the United Kingdom);
 - Otherwise restrict the ability of a manufacturer to enforce such disclaimers or limitations; or
 - Grant the customer additional warranty rights, specify the duration of implied warranties which the manufacturer cannot disclaim, or allow limitations on the duration of implied warranties.
- THE TERMS IN THIS WARRANTY STATEMENT, EXCEPT TO THE EXTENT LAWFULLY PERMITTED, DO NOT EXCLUDE, RESTRICT, OR MODIFY, AND ARE IN ADDITION TO, THE MANDATORY STATUTORY RIGHTS APPLICABLE TO THE SALE OF THE HP PRODUCTS TO SUCH CUSTOMERS.

HP Limited Warranty

Dear Customer,

You will find below the name and address of the HP entity responsible for the performance of the HP Limited Warranty in your country.

You may have additional statutory rights against the seller based on your purchase agreement. Those rights are not in any way affected by this HP Limited Warranty.

Ireland: Hewlett-Packard Ireland Limited, 63-74 Sir John Rogerson's Quay, Dublin 2

United Kingdom: Hewlett-Packard Ltd, Cain Road, Bracknell, GB-Berks RG12 1HN

Malta: Hewlett Packard International Trade BV, Branch 48, Sqaq Nru 2, Triq ix-Xatt, Pieta MSD08, Malta

South Africa: Hewlett-Packard South Africa Ltd, 12 Autumn Street, Rivonia, Sandton, 2128, Republic of South Africa

Ink cartridge warranty information

The HP cartridge warranty is applicable when the product is used in its designated HP printing device. This warranty does not cover HP ink products that have been refilled, remanufactured, refurbished, misused, or tampered with.

During the warranty period the product is covered as long as the HP ink is not depleted and the end of warranty date has not been reached. The end of warranty date, in YYYY/MM format, may be found on the product as indicated:

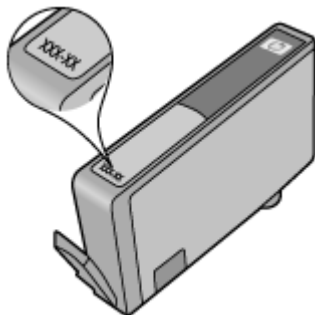

Prepare the device for shipment

If after contacting HP Customer Support or returning to the point of purchase, you are requested to send the device in for service, make sure you remove and keep the following items before returning your device:

- The rear access panel or duplexer.
- The output tray
- The power cord, USB cable, and any other cable connected to the device
- Any paper loaded in the input tray

This section contains the following topics:

- [Remove the rear access panel or duplexer](#)
- [Remove the output tray](#)

Remove the rear access panel or duplexer

Remove the rear access panel or duplexer before shipping the device.

- ▲ Push the button on either side of the rear access panel or the duplexer, and then remove the panel or unit.

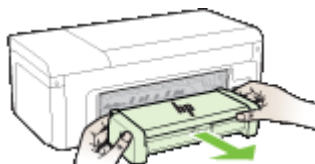

Remove the output tray

Remove the output tray before shipping the device.

- ▲ Lift the output tray, and gently pull it out of the device.

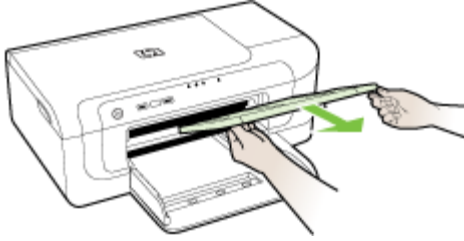

Pack the device

Complete the following steps after you have prepared the device for shipment.

To pack the device

1. If available, pack the device for shipment by using the original packaging materials, or use the packaging materials that came with your replacement device.

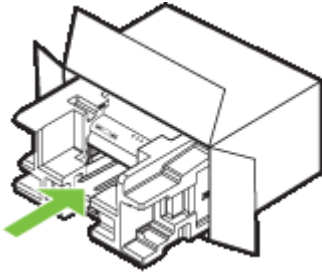

If you do not have the original packaging materials, please use other adequate packaging materials. Shipping damage caused by improper packaging and/or improper transportation is not covered under the warranty.

2. Place the return shipping label on the outside of the box.
3. Include the following items in the box:
 - A complete description of symptoms for service personnel (samples of print quality problems are helpful).
 - A copy of the sales slip or other proof of purchase to establish the warranty coverage period.
 - Your name, address, and a phone number where you can be reached during the day.

C Device specifications

For media and media-handling specifications, see [Understand specifications for supported media](#).

- [Physical specifications](#)
- [Product features and capacities](#)
- [Processor and memory specifications](#)
- [System requirements](#)
- [Network protocol specifications](#)
- [Embedded Web server specifications](#)
- [Print resolution](#)
- [Environmental specifications](#)
- [Electrical specifications](#)
- [Acoustic emission specifications \(print in Draft mode, noise levels per ISO 7779\)](#)

Physical specifications

Size (width x depth x height)

- **Device:** 496 x 299 x 209 mm (19.5 x 11.8 x 8.2 inches)
- **With Duplexer:** Adds 64 mm (2.5 inches) to the rear of the device.

Device weight (does not include printing supplies)

- **Device:** 8.35 kg (18.4 lb)
- **With Duplexer:** Adds 0.95 kg (2.0 lb)

Product features and capacities

Feature	Capacity
Connectivity	<ul style="list-style-type: none">• USB 2.0-compliant high speed• Wireless 802.11b/g• Wired network
Ink cartridges	Four ink cartridges (black, yellow, magenta, cyan)
Supply yields	Visit www.hp.com/pageyield/ for more information on estimated ink cartridge yields.
Device languages	HP PCL 3 HP PCL 3 GUI
Font support	US fonts: CG Times, CG Times Italic, Universe, Universe Italic, Courier, Courier Italic, Letter Gothic, Letter Gothic Italic.
Duty cycle	Up to 7000 pages per month

Processor and memory specifications

Device processor

192 MHz ARM946ES, ETM9 (medium)

Device memory

64 MB built-in RAM, 32 MB built-in Flash ROM

System requirements

 **NOTE:** For the most current information about supported operating systems and system requirements, visit <http://www.hp.com/support/>.

Operating system compatibility

- Windows 2000 Service Pack 4, Windows XP Service Pack 1, Windows XP x64 Service Pack 1, Windows Vista

 **NOTE:** For Windows 2000 SP4, Windows XP x64 Edition SP 1, Windows XP SP 1 Starter Edition, and Windows Vista Starter Edition only printer drivers and the Toolbox are available.

- Mac OS X (v10.4.11, v10.5)
- Linux (For more information, see www.hp.com/go/linuxprinting).

Minimum requirements

- Microsoft® Windows® 2000 Service Pack 4: Intel® Pentium® II or Celeron® processor, 128 MB RAM, 160 MB free hard disk space, Microsoft Internet Explorer 6.0
- Microsoft Windows XP (32-bit) Service Pack 1: Intel Pentium II or Celeron processor, 512 MB RAM, 225 MB free hard disk space, Microsoft Internet Explorer 6.0
- Microsoft Windows x64 Service Pack 1: AMD Athlon™ 64 or AMD Opteron™ processor, Intel Xeon® or Pentium processor with Intel EM64T support, 512MB RAM, 160 MB free hard disk space, Microsoft Internet Explorer 6.0
- Microsoft Windows Vista: 800 MHz 32-bit (x86) or 64-bit (x64) processor, 512 MB RAM, 225 MB free hard disk space, Microsoft Internet Explorer 7.0
- **Mac OS X (v10.4.11, v10.5):** PowerPC G3, G4, G5, or Intel Core processor, 256 MB memory, 500 MB free hard disk space
- **Quick Time 5.0 or later (Mac OS X)**
- Adobe Acrobat Reader 5.0 or later

Recommended requirements

- Microsoft Windows 2000 Service Pack 4: Intel Pentium III or higher processor, 256 MB RAM, 160 MB free hard disk space, Microsoft Internet Explorer 6.0 or later
- Microsoft Windows XP (32-bit) Service Pack 1: Intel Pentium III or higher processor, 512MB RAM, 360 MB free hard disk space, Microsoft Internet Explorer 6.0 or later
- Microsoft Windows XP x64 Service Pack 1: AMD Athlon 64 or AMD Opteron processor, Intel Xeon or Intel Pentium 4 processor with Intel EM64T support, 512MB RAM, 160 MB free hard disk space, Microsoft Internet Explorer 6.0 or later
- Microsoft Windows Vista: 1 GHz 32-bit (x86) or 64-bit (x64) processor, 1 GB RAM, 355 MB free hard disk space, Microsoft Internet Explorer 7.0 or later
- **Mac OS X (v10.4.11, v10.5):** PowerPC G3, G4, G5, or Intel Core processor, 512 MB memory, 500 MB free hard disk space
- **Microsoft Internet Explorer 6.0 or later (Windows 2000, Windows XP); Internet Explorer 7.0 or later (Windows Vista)**

Network protocol specifications

Network operating system compatibility

- Windows 2000, Windows XP (32-bit) (Professional and Home Editions), Windows XP Professional x64
- Mac OS X (10.4.11 and higher, 10.5.x)
- Microsoft Windows 2000 Server Terminal Services with Citrix Metaframe XP with Feature Release 3
- Microsoft Windows 2000 Server Terminal Services with Citrix Presentation Server 4.0
- Microsoft Windows 2000 Server Terminal Services
- Microsoft Windows 2003 Server Terminal Services
- Microsoft Windows 2003 Server Terminal Services with Citrix Presentation Server 4.0
- Microsoft Windows 2003 Server Terminal Services with Citrix Presentation Server 4.5
- Microsoft Windows 2003 Server Terminal Services with Citrix Metaframe XP with Feature Release 3

Compatible network protocols

TCP/IP

Network management

- HP Web Jetadmin plug-ins
- Embedded Web server Features
 - Ability to remotely configure and manage network devices

Embedded Web server specifications

Requirements

- A TCP/IP-based network (IPX/SPX-based networks are not supported)
- A Web browser (either Microsoft Internet Explorer 6.0 or higher, Opera 8.0 or higher, Mozilla Firefox 1.0 or higher, or Safari 1.2, or higher)
- A network connection (you cannot use the embedded Web server connected directly to a computer with a USB cable)
- An Internet connection (required for some features)



NOTE: You can open the embedded Web server without being connected to the Internet. However, some features will not be available.

- It must be on the same side of a firewall as the device.

Print resolution

Black

Up to 1200 dpi with pigmented black ink

Color

HP enhanced photo quality (up to 4800 by 1200 dpi Optimized on HP Premium Plus photo papers with 1200 x 1200 input dpi)

Environmental specifications

Operating environment

Operating temperature: 5° to 40° C (41° to 104° F)

Recommended operating conditions: 15° to 32° C (59° to 90° F)

Recommended relative humidity: 25 to 75% noncondensing

Storage environment

Storage temperature: -40° to 60° C (-40° to 140° F)

Storage relative humidity: Up to 90% noncondensing at a temperature of 60° C (140° F)

Electrical specifications

Power supply

Universal power adapter (external)

Power requirements

Input voltage: 100 to 240 VAC ($\pm 10\%$), 50 to 60 Hz ($\pm 3\text{Hz}$)

Output voltage: 32 Vdc, 1560 mA

Power consumption

29.6 watts

Acoustic emission specifications (print in Draft mode, noise levels per ISO 7779)

Sound pressure (bystander position)

LpAd 54 (dBA)

Sound power

LwAd 6.7 (BA)

D Regulatory information

This section contains the following topics:

- [FCC statement](#)
- [Notice to users in Korea](#)
- [VCCI \(Class B\) compliance statement for users in Japan](#)
- [Notice to users in Japan about the power cord](#)
- [Toxic and hazardous substance table](#)
- [LED indicator statement](#)
- [Regulatory information for wireless products](#)
- [Regulatory model number](#)
- [Declaration of conformity](#)
- [Environmental product stewardship program](#)
- [Third-party license agreements](#)

FCC statement

FCC statement

The United States Federal Communications Commission (in 47 CFR 15.105) has specified that the following notice be brought to the attention of users of this product.

This equipment has been tested and found to comply with the limits for a Class B digital device, pursuant to Part 15 of the FCC Rules. These limits are designed to provide reasonable protection against harmful interference in a residential installation. This equipment generates, uses and can radiate radio frequency energy and, if not installed and used in accordance with the instructions, may cause harmful interference to radio communications. However, there is no guarantee that interference will not occur in a particular installation. If this equipment does cause harmful interference to radio or television reception, which can be determined by turning the equipment off and on, the user is encouraged to try to correct the interference by one or more of the following measures:

- Reorient the receiving antenna.
- Increase the separation between the equipment and the receiver.
- Connect the equipment into an outlet on a circuit different from that to which the receiver is connected.
- Consult the dealer or an experienced radio/TV technician for help.

For further information, contact:

Manager of Corporate Product Regulations
Hewlett-Packard Company
3000 Hanover Street
Palo Alto, Ca 94304
(650) 857-1501

Modifications (part 15.21)

The FCC requires the user to be notified that any changes or modifications made to this device that are not expressly approved by HP may void the user's authority to operate the equipment.

This device complies with Part 15 of the FCC Rules. Operation is subject to the following two conditions: (1) this device may not cause harmful interference, and (2) this device must accept any interference received, including interference that may cause undesired operation.

Notice to users in Korea

사용자 안내문(B급 기기)
 이 기기는 비업무용으로 전자파 적합 등록을 받은 기기로서, 주거지역에서는 물론 모든 지역에서 사용할 수 있습니다.

VCCI (Class B) compliance statement for users in Japan

この装置は、情報処理装置等電波障害自主規制協議会 (VCCI) の基準に基づくクラスB情報技術装置です。この装置は、家庭環境で使用することを目的としていますが、この装置がラジオやテレビジョン受信機に近接して使用されると受信障害を引き起こすことがあります。
 取り扱い説明書に従って正しい取り扱いをして下さい。

Notice to users in Japan about the power cord

製品には、同梱された電源コードをお使い下さい。
 同梱された電源コードは、他の製品では使用出来ません。

Toxic and hazardous substance table

有毒有害物質表						
根据中国《电子信息产品污染控制管理办法》						
零件描述	有毒有害物質和元素					
	鉛	汞	镉	六价铬	多溴联苯	多溴联苯醚
外壳和托盘*	0	0	0	0	0	0
电线*	0	0	0	0	0	0
印刷电路板*	X	0	0	0	0	0
打印系统*	X	0	0	0	0	0
显示器*	X	0	0	0	0	0
喷墨打印机墨盒*	0	0	0	0	0	0
驱动光盘*	X	0	0	0	0	0
扫描仪*	X	X	0	0	0	0
网络配件*	X	0	0	0	0	0
电池板*	X	0	0	0	0	0
自动双面打印系统*	0	0	0	0	0	0
外部电源*	X	0	0	0	0	0

0: 指此部件的所有均一材质中包含的这种有毒有害物質，含量低于SJ/T11363-2006 的限制
 X: 指此部件使用的均一材质中至少有一种包含的这种有毒有害物質，含量高于SJ/T11363-2006 的限制
 注：环保使用期限的参考标识取决于产品正常工作的温度和湿度等条件
 *以上只适用于使用这些部件的产品

LED indicator statement

LED indicator statement

The display LEDs meet the requirements of EN 60825-1.

Regulatory information for wireless products

This section contains the following regulatory information pertaining to wireless products:

- [Exposure to radio frequency radiation](#)
- [Notice to users in Brazil](#)
- [Notice to users in Canada](#)
- [Notice to users in Taiwan](#)
- [European Union regulatory notice](#)

Exposure to radio frequency radiation

Exposure to radio frequency radiation



Caution The radiated output power of this device is far below the FCC radio frequency exposure limits. Nevertheless, the device shall be used in such a manner that the potential for human contact during normal operation is minimized. This product and any attached external antenna, if supported, shall be placed in such a manner to minimize the potential for human contact during normal operation. In order to avoid the possibility of exceeding the FCC radio frequency exposure limits, human proximity to the antenna shall not be less than 20 cm (8 inches) during normal operation.

Notice to users in Brazil

Aviso aos usuários no Brasil

Este equipamento opera em caráter secundário, isto é, não tem direito à proteção contra interferência prejudicial, mesmo de estações do mesmo tipo, e não pode causar interferência a sistemas operando em caráter primário. (Res.ANATEL 282/2001).

Notice to users in Canada

Notice to users in Canada/Note à l'attention des utilisateurs canadiens

For Indoor Use. This digital apparatus does not exceed the Class B limits for radio noise emissions from the digital apparatus set out in the Radio Interference Regulations of the Canadian Department of Communications. The internal wireless radio complies with RSS 210 and RSS GEN of Industry Canada.

Utiliser à l'intérieur. Le présent appareil numérique n'émet pas de bruit radioélectrique dépassant les limites applicables aux appareils numériques de la classe B prescrites dans le Règlement sur le brouillage radioélectrique édicté par le ministère des Communications du Canada. Le composant RF interne est conforme à la norme RSS-210 and RSS GEN d'Industrie Canada.

Notice to users in Taiwan

低功率電波輻射性電機管理辦法

第十二條

經型式認證合格之低功率射頻電機，非經許可，公司、商號或使用者均不得擅自變更頻率、加大功率或變更設計之特性及功能。

第十四條

低功率射頻電機之使用不得影響飛航安全及干擾合法通信；經發現有干擾現象時，應立即停用，並改善至無干擾時方得繼續使用。

前項合法通信，指依電信法規定作業之無線電通信。低功率射頻電機須忍受合法通信或工業、科學及醫藥用電波輻射性電機設備之干擾。

European Union regulatory notice

European Union Regulatory Notice

Products bearing the CE marking comply with the following EU Directives:

- Low Voltage Directive 2006/95/EC
- EMC Directive 2004/108/EC

CE compliance of this product is valid only if powered with the correct CE-marked AC adapter provided by HP.

If this product has telecommunications functionality, it also complies with the essential requirements of the following EU Directive:

- R&TTE Directive 1999/5/EC

Compliance with these directives implies conformity to harmonized European standards (European Norms) that are listed in the EU Declaration of Conformity issued by HP for this product or product family. This compliance is indicated by the following conformity marking placed on the product.



The wireless telecommunications functionality of this product may be used in the following EU and EFTA countries:

Austria, Belgium, Bulgaria, Cyprus, Czech Republic, Denmark, Estonia, Finland, France, Germany, Greece, Hungary, Iceland, Ireland, Italy, Latvia, Liechtenstein, Lithuania, Luxembourg, Malta, Netherlands, Norway, Poland, Portugal, Romania, Slovak Republic, Slovenia, Spain, Sweden, Switzerland and United Kingdom.

Products with 2.4-GHz wireless LAN devices

France

For 2.4 GHz Wireless LAN operation of this product certain restrictions apply: This product may be used indoor for the entire 2400-2483.5 MHz frequency band (channels 1-13). For outdoor use, only 2400-2454 MHz frequency band (channels 1-9) may be used. For the latest requirements, see <http://www.art-telecom.fr>.

Italy

License required for use. Verify with your dealer or directly with the General Direction for Frequency Planning and Management (Direzione Generale Pianificazione e Gestione Frequenze).

Regulatory model number

For regulatory identification purposes, your product is assigned a Regulatory Model Number. The Regulatory Model Number for your product is SNPRC-0802-01 (HP Officejet 6000 Printer) or SNPRC-0802-02 (HP Officejet 6000 Wireless Printer). This regulatory number should not be confused with the marketing name (HP Officejet 6000 Printer Series) or product number.

Declaration of conformity

		DECLARATION OF CONFORMITY according to ISO/IEC 17050-1 and EN 17050-1
Supplier's Name:	Hewlett-Packard Company	DoC#: SNPRC-0802-01-B
Supplier's Address:	60, Alexandra Terrace, # 07-01 The Comtech, Singapore 118502	
declares, that the product		
Product Name:	HP Officejet 6000 Printer Series	
Regulatory Model Number:¹⁾	SNPRC-0802-01	
Product Options:	C9101A / Automatic 2-Sided Printing Device	
conforms to the following Product Specifications and Regulations:		
SAFETY:	IEC 60950-1:2001 / EN60950-1:2001 + A11:2004 EN 60825-1 1994+A1:2002+A2: 2001	
EMC:	CISPR 22:2005/ EN 55022: 2006 Class B ⁽⁴⁾ EN 55024:1998 +A1:2001 + A2:2003 EN 61000-3-2: 2000 + A2: 2005 EN 61000-3-3:1995 +A1: 2001 FCC CFR 47, Part 15 Class B ⁽⁴⁾ / ICES-003, Issue 4 Class B ⁽⁴⁾	
Supplementary Information:		
<ol style="list-style-type: none"> 1. This product is assigned a Regulatory Model Number which stays with the regulatory aspects of the design. The Regulatory Model Number is the main product identifier in the regulatory documentation and test reports, this number should not be confused with the marketing name or the product numbers. 2. This product complies with the requirements of the Low Voltage Directive 2006/95/EC, the EMC Directive 2004/108/EC and carries the CE-marking accordingly. In addition, it complies with the WEEE Directive 2002/96/EC and RoHS Directive 2002/95/EC. 3. This device complies with Part 15 of the FCC Rules. Operation is subject to the following two Conditions: (1) This device may not cause harmful interference, and (2) this device must accept any interference received, including interference that may cause undesired operation. 4. The product was tested in a typical configuration 		
Singapore July 2008		Wong Soo Min, Director Quality Imaging & Printing Manufacturing Operations
Local contact for regulatory topics only:		
EMEA: Hewlett-Packard GmbH, HQ-TRE, Herrenberger Strasse 140, 71034 Boeblingen, Germany www.hp.com/go/certificates USA: Hewlett-Packard, 3000 Hanover St., Palo Alto 94304, U.S.A. 650-857-1501		



DECLARATION OF CONFORMITY

according to ISO/IEC 17050-1 and EN 17050-1

Supplier's Name: Hewlett-Packard Company **DoC#:** SNPRC-0802-02-B

Supplier's Address: 60, Alexandra Terrace, # 07-01 The Comtech, Singapore 118502

declares, that the product

Product Name: HP Officejet 6000 Wireless Printer Series

Regulatory Model Number:¹⁾ SNPRC-0802-02

Product Options: C9101A / Automatic 2-Sided Printing Device

Radio Module Number: RSVLD-0707

conforms to the following Product Specifications and Regulations:

SAFETY: IEC 60950-1:2001 / EN60950-1:2001 + A11:2004
EN 60825-1 1994+A1:2002+A2: 2001

EMC: CISPR 22:2005/ EN 55022: 2006 Class B⁽⁴⁾
EN 55024:1998 +A1:2001 + A2:2003
EN 61000-3-2: 2000 + A2: 2005
EN 61000-3-3:1995 +A1: 2001
FCC CFR 47, Part 15 Class B⁽⁴⁾ / ICES-003, Issue 4 Class B⁽⁴⁾

RADIO: EN 301 489-1 V1.6.1:2005 / EN 301 489-17 V1.2.1:2002
EN 300 328 V1.7.1:2006

Supplementary Information:

1. This product is assigned a Regulatory Model Number which stays with the regulatory aspects of the design. The Regulatory Model Number is the main product identifier in the regulatory documentation and test reports, this number should not be confused with the marketing name or the product numbers.
2. This product complies with the requirements of the Low Voltage Directive 2006/95/EC, the EMC Directive 2004/108/EC and the R&TTE Directive 99/5/EC, and carries the CE-marking accordingly. In addition, it complies with the WEEE Directive 2002/96/EC and RoHS Directive 2002/95/EC.
3. This device complies with Part 15 of the FCC Rules. Operation is subject to the following two Conditions: (1) This device may not cause harmful interference, and (2) this device must accept any interference received, including interference that may cause undesired operation.
4. The product was tested in a typical configuration

**Singapore
July 2008**

**Wong Soo Min, Director Quality
Imaging & Printing Manufacturing Operations**

Local contact for regulatory topics only:

EMEA: Hewlett-Packard GmbH, HQ-TRE, Herrenberger Strasse 140, 71034 Boeblingen, Germany www.hp.com/go/certificates
USA : Hewlett-Packard, 3000 Hanover St., Palo Alto 94304, U.S.A. 650-857-1501

Environmental product stewardship program

Hewlett-Packard is committed to providing quality products in an environmentally sound manner. Design for recycling has been incorporated into this product. The number of materials has been kept to a minimum while ensuring proper functionality and reliability. Dissimilar materials have been designed to separate easily. Fasteners and other connections are easy to locate, access, and remove using common tools. High priority parts have been designed to access quickly for efficient disassembly and repair.

For more information, visit HP's Commitment to the Environment Web site at:

www.hp.com/hpinfo/globalcitizenship/environment/index.html

This section contains the following topics:

- [Paper use](#)
- [Plastics](#)
- [Material safety data sheets](#)
- [Recycling program](#)
- [HP inkjet supplies recycling program](#)
- [Disposal of waste equipment by users in private households in the European Union](#)
- [Power consumption](#)

Paper use

This product is suited for the use of recycled paper according to DIN 19309 and EN 12281:2002.

Plastics

Plastic parts over 25 grams are marked according to international standards that enhance the ability to identify plastics for recycling purposes at the end of product life.

Material safety data sheets

Material safety data sheets (MSDS) can be obtained from the HP Web site at:

www.hp.com/go/msds

Recycling program

HP offers an increasing number of product return and recycling programs in many countries/regions, and partners with some of the largest electronic recycling centers throughout the world. HP conserves resources by reselling some of its most popular products. For more information regarding recycling of HP products, please visit:

www.hp.com/hpinfo/globalcitizenship/environment/recycle/

HP inkjet supplies recycling program

HP is committed to protecting the environment. The HP Inkjet Supplies Recycling Program is available in many countries/regions, and lets you recycle used print cartridges and ink cartridges free of charge. For more information, go to the following Web site:

www.hp.com/hpinfo/globalcitizenship/environment/recycle/

Disposal of waste equipment by users in private households in the European Union



English	<p>Disposal of Waste Equipment by Users in Private Households in the European Union This symbol on the product or on its packaging indicates that this product must not be disposed of with your other household waste. Instead, it is your responsibility to dispose of your waste equipment by handing it over to a designated collection point for the recycling of waste electrical and electronic equipment. The separate collection and recycling of your waste equipment at the time of disposal will help to conserve natural resources and ensure that it is recycled in a manner that protects human health and the environment. For more information about where you can drop off your waste equipment for recycling, please contact your local city office, your household waste disposal service or the shop where you purchased the product.</p>
French	<p>Évacuation des équipements usagés par les utilisateurs dans les foyers privés ou sein de l'Union européenne Ce pictogramme sur le produit ou sur son emballage indique que vous ne pouvez pas vous débarrasser de ce produit de la même façon que des déchets courants. Au contraire, vous êtes responsable de l'évacuation de vos équipements usagés et, à cet effet, vous êtes tenu de les remettre à un point de collecte agréé pour le recyclage des équipements électriques et électroniques usagés. La tri-, l'évacuation et le recyclage séparés de vos équipements usagés permettent de préserver les ressources naturelles et de s'assurer que ces équipements sont recyclés dans le respect de la santé humaine et de l'environnement. Pour plus d'informations sur les lieux de collecte des équipements usagés, veuillez contacter votre mairie, votre service de traitement des déchets ménagers ou le magasin ou vos autres achete le produit.</p>
German	<p>Entsorgung von Elektrogeräten durch Benutzer in privaten Haushalten in der EU Dieses Symbol auf dem Produkt oder dessen Verpackung gibt an, dass das Produkt nicht zusammen mit dem Restmüll entsorgt werden darf. Es obliegt daher Ihrer Verantwortung, das Gerät an einer entsprechenden Stelle für die Entsorgung oder Wiederverwertung von Elektrogeräten oder Art abzugeben (z.B. ein Wertstoffhof). Die separate Sammlung und das Recycling Ihrer abgegebenen Elektrogeräte trägt dazu bei, natürliche Ressourcen zu schonen und zu gewährleisten, dass sie in einer Art und Weise recycelt werden, die den Umwelt- und die Gesundheitsschutz des Menschen und der Umwelt sichert. Weitere Informationen darüber, wo Sie alte Elektrogeräte zum Recycling abgeben können, erhalten Sie bei dem örtlichen Behörden, Wertstoffhöfen oder dort, wo Sie das Gerät erworben haben.</p>
Italian	<p>Smaltimento di apparecchi da parte di privati nell'Unione Europea Questo simbolo che appare sul prodotto o sulla confezione indica che il prodotto non deve essere smaltito assieme agli altri rifiuti domestici. Gli utenti devono provvedere allo smaltimento delle apparecchiature da rottamare partecipando ai luoghi di raccolta individuati per il riciclaggio delle apparecchiature elettriche ed elettroniche. La raccolta e il riciclaggio separati delle apparecchiature da rottamare in fase di smaltimento favoriscono la salvaguardia delle risorse naturali e garantiscono che tali apparecchiature vengano riciclate nel rispetto dell'ambiente e della salute della salute. Per ulteriori informazioni sui punti di raccolta delle apparecchiature da rottamare, contattare il proprio comune di residenza, il servizio di smaltimento dei rifiuti o il negozio presso il quale il prodotto è stato acquistato o venduto.</p>
Spanish	<p>Eliminación de residuos de aparatos eléctricos y electrónicos por parte de usuarios domésticos en la Unión Europea Este símbolo en el producto o en el embalaje indica que no se puede desechar el producto junto con los residuos domésticos. Por el contrario, el debe eliminarse este tipo de residuos, con responsabilidad del usuario entregando en un punto de recogida designado de aparatos eléctricos y electrónicos. El reciclaje y el reciclado por separado de estos residuos, en el momento de la eliminación ayudan a preservar recursos naturales y a garantizar que el residuo se recicla en un sitio con el medio ambiente. Si desea información adicional sobre los lugares donde puede dejar estos residuos por su reciclado, póngase en contacto con las autoridades locales de su ciudad, con el servicio de gestión de residuos domésticos o con la tienda donde adquirió el producto.</p>
Czech	<p>Likvidace výrobků označených symbolem v domácnosti v zemích EU Tento znak na produktu nebo na jeho obalu označuje, že tento produkt nesmí být likvidován společně s ostatními domácími odpady. Odpovědností za to, že výrobky této skupiny budou předloženy likvidaci v určených místech, je uživatel. Oddělená likvidace a recyklace elektrických a elektronických zařízení zabraňuje neoprávněnému sběru a recyklaci nepřírodních zdrojů a zajišťuje, že recyklace proběhne způsobem chránícím lidské zdraví a životní prostředí. Další informace o tom, kam můžete výrobky této skupiny předat k recyklaci, můžete získat od svého místního samosprávy, od specializované provozovny nebo u likvidátora domovního odpadu v obchodu, kde jste produkt získali.</p>
Danish	<p>Bortskaffelse af affaldsudstyr for brugere i private husholdninger i EU Dette symbol på produktet eller på dets emballage indiker, at dette produkt ikke må bortskaffes sammen med andet husholdningsaffald. I stedet er det din ansvar at bortskaffe affaldsudstyr ved at aflever det på den tilsvarende indsamlingssted med henblik på genbrug af elektrisk og elektronisk affaldsudstyr. Den separate indsamling og genbrug af affaldsudstyr på indsamling for bortskaffelse er mid til at bevare naturlige ressourcer og sikre, at genbrug finder sted på en måde, der beskytter menneskers helbred samt miljøet. Hvis du vil vide mere om, hvor du kan aflever dit affaldsudstyr, kan du kontakte kommunen, dit lokale renovationscenter eller den forrenting, hvor du købte produktet.</p>
Dutch	<p>Afvoer van afgedankte apparatuur door gebruikers in particuliere huishoudens in de Europese Unie Dit symbool op het product of de verpakking geeft aan dat dit product niet mag worden afgedankt met het huishoudelijk afval. Het is uw verantwoordelijkheid uw afgedankte apparatuur of te leveren op een afgedankte apparatuur collectie punt voor het recyclen van elektrische apparatuur. Het gescheiden verzamelen en verwerken van uw afgedankte apparatuur draagt bij tot het sparen van natuurlijke bronnen en tot het terugbrengen van nuttelijke opzet wijzen die de volgebruik van hulpbronnen en het milieu beschermen. Meer informatie over het op afgedankte apparatuur kunt u vinden via recycling punt in contact opnemen met het gemeentebureau of in een woonwinkel, de recyclingcentrum of de winkel waar u het product hebt aangekocht.</p>
Slovak	<p>Erasmoprávnenie použitých elektrických zariadení v domácnostiach Európskej únie Tento znak na produkte alebo na jeho obale označuje, že tento produkt nesmie byť likvidovaný spoločne s ostatnými domácimi odpadmi. Odporúčajú sa to, že výrobky tejto skupiny budú predané likvidácii v určených miestach, je používateľ. Oddelená likvidácia a recyklácia elektrických a elektronických zariadení zabraňuje neoprávnenej zberu a recyklácii prírodných zdrojov a zaisťuje, že recyklácia proběhne spôsobom chránícím lidské zdraví a životní prostředí. Další informace o tom, kam můžete výrobky této skupiny předat k recyklaci, můžete získat od svého místního samosprávy, od specializované provozovny nebo u likvidátora domovního odpadu v obchodu, kde jste produkt získali.</p>
Slovenian	<p>Odstranitev odpadnih naprav v zasebnih gospodinjstvih v EU To simbol na izdelku ali na embalaži označuje, da tega izdelka ne smete posebej zavržiti skupaj s ostalimi domačimi odpadki. Namesto tega morate odpadno elektriko in elektronsko opremo posebej dostaviti na določena zbirna mesta za odpadno elektriko in elektronsko opremo. Ločeno zbiranje in recikliranje odpadnih naprav pomagata pri varovanju naravnih virov in zagotavljanju, da odpadna elektrika in elektronska oprema ne bodo posebej zavrženi ali nepravilno reciklirani. Za več informacij o mestih, kjer lahko oddate odpadno opremo za recikliranje, lahko dobite na občini, v lokalnem centru za odpadke ali trgovini, kjer ste izdelek kupili.</p>
Hungarian	<p>Elhárterés az elhasznált villamos és elektronikus készülékek elhelyezésére a háztartásokban az Európai Unióban Ez a szimbólum, amely a termék vagy annak csomagolásán van feltüntetve, azt jelzi, hogy a termék nem kezelhető együtt az egyéb háztartási hulladékkal. Az Ön felelőssége, hogy a készüléket különleges gyűjtőhelyen adja át a megfelelő módon elhelyezésére, amely az elhasznált eszközök újrahasználatát és az elhelyezésük elválasztását szolgálja. Előzetes szétválasztás és különleges elhelyezés segít megőrizni a természetes erőforrásokat, és biztosítja, hogy a hulladék újrahasználatának és reciklálásának az egészséges és környezetbarát módon történjen. További információkért forduljon az önkormányzat felé, a hulladékgyűjtő központ felé, a hulladékgyűjtő központ felé, a hulladékgyűjtő központ felé, a hulladékgyűjtő központ felé, a hulladékgyűjtő központ felé, a hulladékgyűjtő központ felé.</p>
Polish	<p>Wyposażenie użytkownika o oznakowaniu w domostwach w Unii Europejskiej Ten symbol na produkcie albo na jego opakowaniu oznacza, że ten produkt nie należy wyrzucać razem z innymi odpadami domowymi. Użytkownik jest odpowiedzialny za oddzielenie zużytego sprzętu do wyznaczonego punktu gromadzenia zużytych urządzeń elektrycznych i elektronicznych. Gromadzenie osobno i recykling tego typu odpadów przyczynia się do oszczędzenia zasobów naturalnych i zapewnia, że recykling przebiega w sposób, który nie szkodzi środowisku. Więcej informacji na temat sposobu wyłączenia urządzeń przekazanych do recyklingu można uzyskać w odpowiednich władz lokalnych, w przedsiębiorstwie zajmującym się usuwaniem odpadów lub w miejscu zakupu produktu.</p>
Portuguese	<p>Despecho de equipamentos por usuários em residências da União Europeia Este símbolo no produto ou no seu embalagem indica que o produto não pode ser descartado junto com o lixo doméstico. No entanto, é sua responsabilidade levar os equipamentos a serem descartados a um ponto de coleta designado para o recolhimento de equipamentos eletrônicos e eletrônicos. A coleta separada e o recolhimento dos equipamentos no momento do descarte ajudam a preservar os recursos naturais e a garantir que o resíduo seja reciclado em um local com o meio ambiente. Se deseja mais informações sobre onde descartar equipamentos para o reciclagem, entre em contato com o escritório local de sua cidade, o serviço de gestão de resíduos domésticos ou a loja em que adquiriu o produto.</p>
Slovakian	<p>Postup používateľov s použitými elektrickými a elektronickými zariadeniami v domácnostiach používateľov zo zberu Tento symbol na produkte alebo na jeho obale označuje, že tento produkt nesmie byť likvidovaný spoločne s ostatnými domácimi odpadmi. Namesto toho máte povinnosť odviesť tento zariadenia na zberom miesto, kde sa zabezpečuje recyklácia elektrických a elektronických zariadení. Separovaný zber o recyklácia zariadenia určeno na oddaj pohodu chráni prirodzené zdroje a zaisťujú, že recyklácia proběhne spôsobom chránícím lidské zdraví a životní prostředí. Další informace o tom, kam můžete výrobky této skupiny předat k recyklaci, můžete získat od svého místního samosprávy, od specializované provozovny nebo u likvidátora domovního odpadu v obchodu, kde jste produkt získali.</p>
Slovenian	<p>Revonjanje o odpadno opremo v gospodinjstvih znotraj Evropske unije Ta znak na izdelku ali na embalaži označuje, da tega izdelka ne smete posebej zavržiti skupaj s ostalimi domačimi odpadki. Namesto tega morate odpadno elektriko in elektronsko opremo posebej dostaviti na določena zbirna mesta za odpadno elektriko in elektronsko opremo. Ločeno zbiranje in recikliranje odpadnih naprav pomagata pri varovanju naravnih virov in zagotavljanju, da odpadna elektrika in elektronska oprema ne bodo posebej zavrženi ali nepravilno reciklirani. Za več informacij o mestih, kjer lahko oddate odpadno opremo za recikliranje, lahko dobite na občini, v lokalnem centru za odpadke ali trgovini, kjer ste izdelek kupili.</p>
Slovakian	<p>Kassering av förbrukningsmaterial, för hem- och privatbrukare i EU Produkt eller produktens förpackning har detta symbol för att den ska användas separat från övrigt hushållsaffall. Istället får du ansvar för att produkten lämnas till en behörig återvinningssamling för bortskaffning av ditt utrustningsmaterial. Det separerade insamlade och återvinningen av utrustningsmaterial hjälper till att skydda naturliga resurser och säkerställer att återvinningen sker på ett sätt som inte skadar miljön och människors hälsa. För mer information om var du kan lämna in ditt utrustningsmaterial för återvinning, kan du kontakta kommunen, ditt lokala renovationscenter eller butik där varan köptes kan ge mer information om var du kan lämna in ditt utrustningsmaterial för återvinning.</p>
Slovakian	<p>Использование отходов по назначениям в частных домохозяйствах в Европейском союзе Этот символ на продукте или на его упаковке указывает на то, что этот продукт не следует выбрасывать с другими бытовыми отходами. Вместо этого вы должны утилизировать этот продукт отдельно от остальных бытовых отходов. Отдельное накопление и рециклирование отходов помогает сохранить природные ресурсы и гарантирует, что отходы будут переработаны в соответствии с требованиями к защите окружающей среды и здоровья человека. Для получения дополнительной информации о том, куда вы можете сдать этот продукт для переработки, обратитесь к местным властям, в службу управления отходами или в магазин, где вы приобрели этот продукт.</p>
Slovakian	<p>Informações sobre o tratamento de resíduos de equipamentos elétricos e eletrônicos em residências domésticas na União Europeia Este símbolo no produto ou na sua embalagem indica que este produto não deve ser descartado juntamente com os outros resíduos domésticos. Em vez disso, é sua responsabilidade levar este tipo de resíduos, com responsabilidade do usuário entregando em um ponto de coleta designado para o recolhimento de equipamentos elétricos e eletrônicos. O recolhimento e o reciclagem separados desses resíduos, no momento da eliminação, ajudam a preservar recursos naturais e a garantir que o resíduo seja reciclado em um local com o meio ambiente. Se deseja mais informações sobre onde descartar equipamentos para o reciclagem, entre em contato com o escritório local de sua cidade, o serviço de gestão de resíduos domésticos ou a loja em que adquiriu o produto.</p>

Power consumption

Power usage drops significantly while in Sleep mode, which saves natural resources and saves money without affecting the high performance of this product. To determine the ENERGY STAR®

qualification status for this product see the Product Data Sheet or Specifications Sheet. Qualified products are also listed at www.hp.com/go/energystar.

Third-party license agreements

This section contains the following topics:

- [Expat](#)
- [OpenSSL](#)
- [SHA2](#)

Expat

Copyright (c) 1998, 1999, 2000 Thai Open Source Software Center Ltd

Permission is hereby granted, free of charge, to any person obtaining a copy of this software and associated documentation files (the "Software"), to deal in the Software without restriction, including without limitation the rights to use, copy, modify, merge, publish, distribute, sublicense, and/or sell copies of the Software, and to permit persons to whom the Software is furnished to do so, subject to the following conditions:

The above copyright notice and this permission notice shall be included in all copies or substantial portions of the Software.

THE SOFTWARE IS PROVIDED "AS IS", WITHOUT WARRANTY OF ANY KIND, EXPRESS OR IMPLIED, INCLUDING BUT NOT LIMITED TO THE WARRANTIES OF MERCHANTABILITY, FITNESS FOR A PARTICULAR PURPOSE AND NONINFRINGEMENT. IN NO EVENT SHALL THE AUTHORS OR COPYRIGHT HOLDERS BE LIABLE FOR ANY CLAIM, DAMAGES OR OTHER LIABILITY, WHETHER IN AN ACTION OF CONTRACT, TORT OR OTHERWISE, ARISING FROM, OUT OF OR IN CONNECTION WITH THE SOFTWARE OR THE USE OR OTHER DEALINGS IN THE SOFTWARE.

OpenSSL

Copyright (C) 1995-1998 Eric Young (eay@cryptsoft.com) All rights reserved.

This package is an SSL implementation written by Eric Young (eay@cryptsoft.com).

The implementation was written so as to conform with Netscapes SSL.

This library is free for commercial and non-commercial use as long as the following conditions are aheared to. The following conditions apply to all code found in this distribution, be it the RC4, RSA, lhash, DES, etc., code; not just the SSL code. The SSL documentation included with this distribution is covered by the same copyright terms except that the holder is Tim Hudson (tjh@cryptsoft.com). Copyright remains Eric Young's, and as such any Copyright notices in the code are not to be removed.

If this package is used in a product, Eric Young should be given attribution as the author of the parts of the library used.

This can be in the form of a textual message at program startup or in documentation (online or textual) provided with the package.

Redistribution and use in source and binary forms, with or without modification, are permitted provided that the following conditions are met:

1. Redistributions of source code must retain the copyright notice, this list of conditions and the following disclaimer.
2. Redistributions in binary form must reproduce the above copyright notice, this list of conditions and the following disclaimer in the documentation and/or other materials provided with the distribution.
3. All advertising materials mentioning features or use of this software must display the following acknowledgement:
"This product includes cryptographic software written by Eric Young (eay@cryptsoft.com)"
The word 'cryptographic' can be left out if the routines from the library being used are not cryptographic related :-).
If you include any Windows specific code (or a derivative thereof) from the apps directory (application code) you must include an acknowledgement: "This product includes software written by Tim Hudson (tjh@cryptsoft.com)"

THIS SOFTWARE IS PROVIDED BY ERIC YOUNG ``AS IS'' AND ANY EXPRESS OR IMPLIED WARRANTIES, INCLUDING, BUT NOT LIMITED TO, THE IMPLIED WARRANTIES OF MERCHANTABILITY AND FITNESS FOR A PARTICULAR PURPOSE ARE DISCLAIMED. IN NO EVENT SHALL THE AUTHOR OR CONTRIBUTORS BE LIABLE FOR ANY DIRECT, INDIRECT, INCIDENTAL, SPECIAL, EXEMPLARY, OR CONSEQUENTIAL DAMAGES (INCLUDING, BUT NOT LIMITED TO, PROCUREMENT OF SUBSTITUTE GOODS OR SERVICES; LOSS OF USE, DATA, OR PROFITS; OR BUSINESS INTERRUPTION) HOWEVER CAUSED AND ON ANY THEORY OF LIABILITY, WHETHER IN CONTRACT, STRICT LIABILITY, OR TORT (INCLUDING NEGLIGENCE OR OTHERWISE) ARISING IN ANY WAY OUT OF THE USE OF THIS SOFTWARE, EVEN IF ADVISED OF THE POSSIBILITY OF SUCH DAMAGE.

The licence and distribution terms for any publically available version or derivative of this code cannot be changed. i.e. this code cannot simply be copied and put under another distribution licence [including the GNU Public Licence.]

=====

Copyright (c) 1998-2001 The OpenSSL Project. All rights reserved.

Redistribution and use in source and binary forms, with or without modification, are permitted provided that the following conditions are met:

1. Redistributions of source code must retain the above copyright notice, this list of conditions and the following disclaimer
2. Redistributions in binary form must reproduce the above copyright notice, this list of conditions and the following disclaimer in the documentation and/or other materials provided with the distribution.
3. All advertising materials mentioning features or use of this software must display the following acknowledgement:
"This product includes software developed by the OpenSSL Project for use in the OpenSSL Toolkit. (<http://www.openssl.org/>)"
4. The names "OpenSSL Toolkit" and "OpenSSL Project" must not be used to endorse or promote products derived from this software without prior written permission. For written permission, please contact openssl-core@openssl.org.
5. Products derived from this software may not be called "OpenSSL" nor may "OpenSSL" appear in their names without prior written permission of the OpenSSL Project.
6. Redistributions of any form whatsoever must retain the following acknowledgment:
"This product includes software developed by the OpenSSL Project for use in the OpenSSL Toolkit (<http://www.openssl.org/>)"

THIS SOFTWARE IS PROVIDED BY THE OpenSSL PROJECT ``AS IS'' AND ANY EXPRESSED OR IMPLIED WARRANTIES, INCLUDING, BUT NOT LIMITED TO, THE IMPLIED WARRANTIES OF MERCHANTABILITY AND FITNESS FOR A PARTICULAR PURPOSE ARE DISCLAIMED. IN

NO EVENT SHALL THE OpenSSL PROJECT OR ITS CONTRIBUTORS BE LIABLE FOR ANY DIRECT, INDIRECT, INCIDENTAL, SPECIAL, EXEMPLARY, OR CONSEQUENTIAL DAMAGES (INCLUDING, BUT NOT LIMITED TO, PROCUREMENT OF SUBSTITUTE GOODS OR SERVICES; LOSS OF USE, DATA, OR PROFITS; OR BUSINESS INTERRUPTION) HOWEVER CAUSED AND ON ANY THEORY OF LIABILITY, WHETHER IN CONTRACT, STRICT LIABILITY, OR TORT (INCLUDING NEGLIGENCE OR OTHERWISE) ARISING IN ANY WAY OUT OF THE USE OF THIS SOFTWARE, EVEN IF ADVISED OF THE POSSIBILITY OF SUCH DAMAGE.

=====

This product includes cryptographic software written by Eric Young (eay@cryptsoft.com). This product includes software written by Tim Hudson (tjh@cryptsoft.com).

=====

Copyright (c) 1998-2006 The OpenSSL Project. All rights reserved.

Redistribution and use in source and binary forms, with or without modification, are permitted provided that the following conditions are met:

1. Redistributions of source code must retain the above copyright notice, this list of conditions and the following disclaimer.
2. Redistributions in binary form must reproduce the above copyright notice, this list of conditions and the following disclaimer in the documentation and/or other materials provided with the distribution.
3. All advertising materials mentioning features or use of this software must display the following acknowledgment:
"This product includes software developed by the OpenSSL Project for use in the OpenSSL Toolkit. (<http://www.openssl.org/>)"
4. The names "OpenSSL Toolkit" and "OpenSSL Project" must not be used to endorse or promote products derived from this software without prior written permission. For written permission, please contact openssl-core@openssl.org.
5. Products derived from this software may not be called "OpenSSL" nor may "OpenSSL" appear in their names without prior written permission of the OpenSSL Project.
6. Redistributions of any form whatsoever must retain the following acknowledgment:
"This product includes software developed by the OpenSSL Project for use in the OpenSSL Toolkit (<http://www.openssl.org/>)"

THIS SOFTWARE IS PROVIDED BY THE OpenSSL PROJECT ``AS IS'' AND ANY EXPRESSED OR IMPLIED WARRANTIES, INCLUDING, BUT NOT LIMITED TO, THE IMPLIED WARRANTIES OF MERCHANTABILITY AND FITNESS FOR A PARTICULAR PURPOSE ARE DISCLAIMED. IN NO EVENT SHALL THE OpenSSL PROJECT OR ITS CONTRIBUTORS BE LIABLE FOR ANY DIRECT, INDIRECT, INCIDENTAL, SPECIAL, EXEMPLARY, OR CONSEQUENTIAL DAMAGES (INCLUDING, BUT NOT LIMITED TO, PROCUREMENT OF SUBSTITUTE GOODS OR SERVICES; LOSS OF USE, DATA, OR PROFITS; OR BUSINESS INTERRUPTION) HOWEVER CAUSED AND ON ANY THEORY OF LIABILITY, WHETHER IN CONTRACT, STRICT LIABILITY, OR TORT (INCLUDING NEGLIGENCE OR OTHERWISE) ARISING IN ANY WAY OUT OF THE USE OF THIS SOFTWARE, EVEN IF ADVISED OF THE POSSIBILITY OF SUCH DAMAGE.

=====

This product includes cryptographic software written by Eric Young (eay@cryptsoft.com). This product includes software written by Tim Hudson (tjh@cryptsoft.com).

=====

Copyright 2002 Sun Microsystems, Inc. ALL RIGHTS RESERVED. ECC cipher suite support in OpenSSL originally developed by SUN MICROSYSTEMS, INC., and contributed to the OpenSSL project.

SHA2

FIPS 180-2 SHA-224/256/384/512 implementation

Last update: 02/02/2007

Issue date: 04/30/2005

Copyright (C) 2005, 2007 Olivier Gay (olivier.gay@a3.epfl.ch)

All rights reserved.

Redistribution and use in source and binary forms, with or without modification, are permitted provided that the following conditions are met:

1. Redistributions of source code must retain the above copyright notice, this list of conditions and the following disclaimer.
2. Redistributions in binary form must reproduce the above copyright notice, this list of conditions and the following disclaimer in the documentation and/or other materials provided with the distribution.
3. Neither the name of the project nor the names of its contributors may be used to endorse or promote products derived from this software without specific prior written permission.

THIS SOFTWARE IS PROVIDED BY THE PROJECT AND CONTRIBUTORS ``AS IS" AND ANY EXPRESS OR IMPLIED WARRANTIES, INCLUDING, BUT NOT LIMITED TO, THE IMPLIED WARRANTIES OF MERCHANTABILITY AND FITNESS FOR A PARTICULAR PURPOSE ARE DISCLAIMED. IN NO EVENT SHALL THE PROJECT OR CONTRIBUTORS BE LIABLE FOR ANY DIRECT, INDIRECT, INCIDENTAL, SPECIAL, EXEMPLARY, OR CONSEQUENTIAL DAMAGES (INCLUDING, BUT NOT LIMITED TO, PROCUREMENT OF SUBSTITUTE GOODS OR SERVICES; LOSS OF USE, DATA, OR PROFITS; OR BUSINESS INTERRUPTION) HOWEVER CAUSED AND ON ANY THEORY OF LIABILITY, WHETHER IN CONTRACT, STRICT LIABILITY, OR TORT (INCLUDING NEGLIGENCE OR OTHERWISE) ARISING IN ANY WAY OUT OF THE USE OF THIS SOFTWARE, EVEN IF ADVISED OF THE POSSIBILITY OF SUCH DAMAGE.

Index

- A**
- accessibility
 - mobility 10
 - support 10
 - visual 10
 - accessories
 - installation 14
 - ordering 131
 - part numbers 131
 - self-test diagnostic page 40
 - turn on and off in driver 14
 - warranty 139
 - acoustic emissions 145
 - Add Printer installation 45
 - administrator
 - settings 32
 - after the support period 137
 - align printhead 98
- B**
- blank pages, troubleshoot
 - print 67
- C**
- cancel
 - print job 30
 - capacity
 - tray 22
 - cards
 - guidelines 19
 - sizes supported 21
 - tray supporting 22
 - cartridges. *See* ink cartridges
 - clean
 - printhead 97
 - color
 - dull 88
 - colors
 - specifications 144
 - connections
 - changing Ethernet to
 - wireless 51
 - changing USB to wireless (Mac OS X) 51
 - changing USB to wireless (Windows) 50
 - features available 12
 - connectors, locating 12
 - control panel
 - administrator settings 32
 - illustration 124
 - lights, understanding 124
 - locating 11
 - custom-sized media
 - sizes supported 22
 - customer support
 - electronic 133
 - phone support 134
 - warranty 137
 - cut-off pages, troubleshoot 68
- D**
- Declaration of Conformity (DOC) 150
 - device
 - back view 12
 - configuring (Mac OS X) 45
 - configuring (Windows) 42
 - connection, changing 50
 - control panel 11
 - front view 10
 - getting started 8
 - management tools 33
 - network configuration
 - report 41
 - no response 70
 - parts 10
 - printer sharing 12
 - reinstalling software 52
 - resources, additional 8
 - sharing (Mac OS X) 46
 - sharing (Windows) 43
 - turning off 13
 - uninstalling software 52
 - using 16
 - wireless communication 46
 - wireless status report 41
 - diagnostic page 60
 - DOC. *See* Declaration of Conformity
- E**
- documentation, other resources 8
 - dots per inch (dpi)
 - print 144
 - driver
 - accessories settings 14
 - version 134
 - warranty 139
 - duplexer
 - clearing jams 111
 - installation 14
 - locating 12
 - margins, minimum 23
 - media sizes supported 20
 - remove 140
 - turn on and off 14
 - using 26
 - duty cycle 142
- E**
- electrical specifications 145
 - embedded Web server
 - about 34
 - administrator settings 32
 - opening 34
 - pages 35
 - system requirements 144
 - troubleshoot, cannot be opened 100
 - envelopes
 - guidelines 19
 - sizes supported 20
 - tray supporting 22
 - environmental programs
 - European Union equipment disposal 153
 - material safety data 152
 - paper use 152
 - plastics 152
 - recycling program 152
 - environmental specifications 145
 - Ethernet
 - connections 12
 - network port, locating 12

Index

European Union, equipment disposal 153
EWS. *See* embedded Web server

F

fonts supported 142

H

head 96
help 133
see also customer support
HP Company notices 3
HP Printer Utility (Mac OS X)
 administrator settings 33
 opening 37
 panels 38
HP Solution Center 37
humidity specifications 145

I

ink
 low 79
 streaks on the back of paper 92
ink cartridges
 check ink levels 56
 expiration dates 40
 lights 124
 low ink 79
 ordering online 131
 part numbers 40, 132
 recycling 152
 replace 57
 status 32, 40
 supported 142
 tips 55
 warranty 139
 yields 142
ink levels, check 56
installation
 accessories 14
 Add Printer (Windows) 45
 duplexer 14
 hardware installation suggestions 108
 software (Mac OS X) 45
 software (Windows) 42
 software installation suggestions 109

troubleshooting issues 108
Windows network software 44

IP address
 checking for device 101

J

jams
 clearing 111
 paper to avoid 18
 preventing 112

L

language, printer 142
lights on control panel
 illustration 124
 understanding 124
lights reference 124
loading
 tray 1 24

M

Mac OS X
 borderless printing 29
 HP Printer Utility 37
 installing software 45
 printing on special or custom-sized paper 28
 printing settings 26
 sharing device 46
 turn accessories on and off in driver 14
 uninstalling software 54
 wireless communication setup 49
maintain
 printhead 96
maintenance
 align printhead 98
 check ink levels 56
 clean printhead 97
 diagnostic page 60
 print quality report 60
 printhead 96
 replace ink cartridges 57
margins
 duplexer 23
 incorrect 76
 setting, specifications 23
 text or graphic cut off 77
media
 skewed pages 100

specifications 19
supported sizes 20
troubleshoot feeding 99
types and weights supported 22

memory
 specifications 143
missing or incorrect information, troubleshoot 67
model number 40
monitoring tools 32
multi-feeds, troubleshoot 100

N

networks
 connector illustration 12
 Ethernet connections 12
 Mac OS X setup 45
 operating systems supported 144
 protocols supported 144
 sharing (Mac OS X) 46
 sharing (Windows) 43
 solve problems 101, 110
 system requirements 144
 Windows setup 44
 wireless communication setup 46
 wireless settings 47
noise information 145

O

operating environment specifications 145
operating systems supported 143
output tray
 locating 10
 media supported 23
 remove 140

P

packing the device 141
pages per month (duty cycle) 142
paper
 borderless printing 29
 clearing jams 111
 duplexing 26
 feed fails 93
 guidelines, custom-sized 19
 loading tray 1 24

- ordering 132
- printing on custom-sized 27
- selecting 18
- paper jams. *See* jams
- paper-feed problems,
 - troubleshoot 99
- PCL 3 support 142
- phone customer support 134
- phone support 135
- phone support period
 - period for support 135
- photo media
 - sizes supported 21
- photos
 - borderless printing 29
 - paper guidelines 19
- poor printout quality 80
- ports, specifications 142
- power
 - locating input 12
 - specifications 145
 - troubleshoot 66
- print
 - blank printout 79
 - borderless fails 70
 - diagnostic page 60
 - distorted printout 85
 - envelopes print
 - incorrectly 69
 - faded 88
 - margins incorrect 76, 77
 - meaningless characters 73
 - nothing happens 73
 - print quality report 60
 - Printer Status page 40
 - quality, troubleshoot 80, 83, 86, 90
 - reversed page order 76
 - slow 66
 - troubleshoot 66
 - troubleshooting 69
 - vertical streaks 91
- print cartridges. *See* ink cartridges
- print driver
 - accessories settings 14
 - version 134
 - warranty 139
- print quality
 - smear ink 80
- print quality report 60
- print settings
 - print quality 80

- printer driver
 - accessories settings 14
 - settings 25
 - version 134
 - warranty 139
- Printer Status page
 - print 40
- printer status page
 - information on 39
- printhead
 - clean 97
- printhead, align 98
- printheads
 - lights 124
 - ordering online 131
 - part numbers 132
 - warranty 139
- printing
 - borderless (Mac OS X) 29
 - borderless (Windows) 29
 - cancel 30
 - double-sided 26
 - settings 25
 - slow, troubleshoot 96
 - Web pages 30
- problems
 - print 69
- processor specifications 142
- product. *See* device

R

- radio interference. *See* regulatory information
- readme 8
- rear access panel
 - clearing jams 111
 - illustration 12
 - remove 140
- recycling
 - ink cartridges 152
 - program 152
- regulatory information
 - Declaration of Conformity 150
 - environmental stewardship program 152
 - FCC statement 146
 - Japan 147
 - Korea 147
 - LED indicator statement 148
 - power cord, Japan 147

- radio frequency
 - exposure 148
- regulatory model
 - number 150
- toxic and hazardous substance 147
- wireless devices 148
- release notes 8
- replace ink cartridges 57
- reports
 - diagnostic 60
 - print quality 60
 - printhead 96
- resolution
 - print 144

S

- safety information 3
- security
 - wireless communication 51
 - wireless settings 48
- serial number 40
- Services tab, Toolbox (Windows) 36
- settings
 - administrator 32
 - printer driver 25
 - printing, default 26
- setup
 - connection types 12
 - Windows 42
 - Windows networks 44
- shipping the device 140
- skew, troubleshoot
 - print 100
- slow print, troubleshoot 66
- smear ink 80
- software
 - accessories settings 14
 - connection types 12
 - installation (Mac OS X) 45
 - installation (Windows) 42
 - uninstalling (Mac OS X) 54
 - uninstalling (Windows) 52
 - warranty 139
- Solution Center 37
- sound pressure 145
- specifications
 - acoustic emissions 145
 - electrical 145
 - media 19
 - network protocols 144
 - operating environment 145

Index

- physical 142
- processor and memory 142
- storage environment 145
- system requirements 143
- speed
 - troubleshoot print 66
- status
 - self-test diagnostic page 40
 - supplies 32
- storage environment
 - specifications 145
- supplies
 - ordering online 131
 - self-test diagnostic page 40
 - status 32
 - yields 142
- support. *See* customer support
- support process 134
- system requirements 143

T

- telephone customer
 - support 134
- temperature specifications 145
- text
 - cut off 77
 - jagged 94
 - meaningless characters 73
 - not filled in 83
 - smooth fonts 94
 - troubleshoot 68
- Toolbox (Windows)
 - about 35
 - administrator settings 33
 - Estimated Ink Level tab 36
 - opening 36
 - Services tab 36
- transparencies 19
- tray
 - capacity 22
 - media sizes supported 20
 - media types and weights supported 22
- tray 1
 - loading paper 24
 - locating 10
- trays
 - capacities 22
 - clearing jams 111
 - loading paper 24
 - locating 10
 - media sizes supported 20

- paper guides illustration 10
- troubleshoot feeding 99
- troubleshoot
 - blank pages printed 67
 - cut-off pages, incorrect text or graphics placement 68
 - embedded Web server 100
 - media not picked up from tray 99
 - missing or incorrect information 67
 - multiple pages are picked 100
 - paper-feed problems 99
 - power 66
 - print 66
 - print quality 80
 - printer status page 39
 - skewed pages 100
 - slow print 66
 - tips 65
- troubleshooting
 - hardware installation
 - suggestions 108
 - installation issues 108
 - lights 124
 - print 69
 - software installation
 - suggestions 109
 - solve network problems 101, 110
 - wireless problems 102
- two-sided printing 27
- two-sided printing accessory.
See duplexer

U

- uninstalling software
 - Mac OS X 54
 - Windows 52
- USB connection
 - features available 12
 - port, locating 10, 12
 - setup (Mac OS X) 45
 - setup Windows 42
 - specifications 142

V

- voltage specifications 145

W

- warranty 137, 139

Web sites

- accessibility information 10
- Apple 46
- customer support 133
- environmental
 - programs 152
- ordering supplies and accessories 131
- resources, additional 8
- supply yield data sheet 142
- wireless security 48

Windows

- Add Printer installation 45
- borderless printing 29
- duplexing 27
- HP Solution Center 37
- installing software 42
- network setup 44
- printing on special or custom-sized paper 27
- printing settings 25
- set up wireless
 - communication 48
 - sharing device 43
- system requirements 143
- turn accessories on and off in driver 14
- uninstalling software 52
- wireless communication
 - 802.11 network settings 47
 - ad hoc connection 49
 - advanced wireless
 - troubleshooting 103
 - basic wireless
 - troubleshooting 102
 - firewall 49
 - regulatory information 148
 - security 51
 - set up 46
 - set up, installer (Mac OS X) 49
 - set up, installer (Windows) 48
 - turning off 49

© 2009 Hewlett-Packard Development Company, L.P.

www.hp.com/support

