

Multimedia User Guide

© Copyright 2009 Hewlett-Packard
Development Company, L.P.

Microsoft and Windows are U.S. registered
trademarks of Microsoft Corporation.

The information contained herein is subject
to change without notice. The only
warranties for HP products and services are
set forth in the express warranty statements
accompanying such products and services.
Nothing herein should be construed as
constituting an additional warranty. HP shall
not be liable for technical or editorial errors
or omissions contained herein.

First Edition: June 2009

Document Part Number: 533500-001

Product notice

This user guide describes features that are
common to most models. Some features
may not be available on your computer.

Table of contents

1 Multimedia features

Identifying your multimedia components	2
Adjusting the volume	4

2 Multimedia software

Accessing your preinstalled multimedia software	6
Installing multimedia software from a disc	7

3 Audio

Connecting external audio devices	9
Checking your audio functions	10

4 Video

Connecting an external monitor or projector	12
---------------------------------------------------	----

5 Optical drive

Identifying the installed optical drive	13
Using optical discs (CDs and DVDs)	14
Selecting the right disc (CDs and DVDs)	15
CD-R discs	15
CD-RW discs	15
DVD±R discs	15
DVD±RW discs	15
LightScribe DVD+R discs	15
Playing music	16
Watching a movie	17
Configuring AutoPlay	18
Changing DVD region settings	19
Observing the copyright warning	20
Copying a CD or DVD	21
Creating or “burning” a CD or DVD	22
Removing a CD or DVD	23

6 Webcam (select models only)

Webcam tips	25
Adjusting webcam properties	26

7 Troubleshooting

The optical disc tray does not open for removal of a CD or DVD	28
The computer does not detect the optical drive	29
A disc does not play	30
A disc does not play automatically	31
A DVD movie stops, skips, or plays erratically	32
A DVD movie is not visible on an external display	33
The process of burning a disc does not begin, or it stops before completion	34
A device driver must be reinstalled	35
Obtaining the latest HP device drivers	35
Obtaining Microsoft device drivers	35
Using SoftPaq Download Manager	36
Index	37

1 Multimedia features

Your computer includes multimedia features that allow you to listen to music, watch movies, and view pictures. Your computer may include the following multimedia components:

- Optical drive for playing audio and video discs
- Integrated speakers for listening to music
- Integrated microphone for recording your own audio
- Integrated webcam that allows you to capture and share video
- Preinstalled multimedia software that allows you to play and manage your music, movies, and pictures
- Hotkeys that provide fast access to multimedia tasks

 **NOTE:** Your computer may not include all of the components listed.

The following sections explain how to identify and use the multimedia components included with your computer.

Identifying your multimedia components

The following illustration and table describe the multimedia features of the computer.

 **NOTE:** Refer to the illustration that most closely matches your computer.

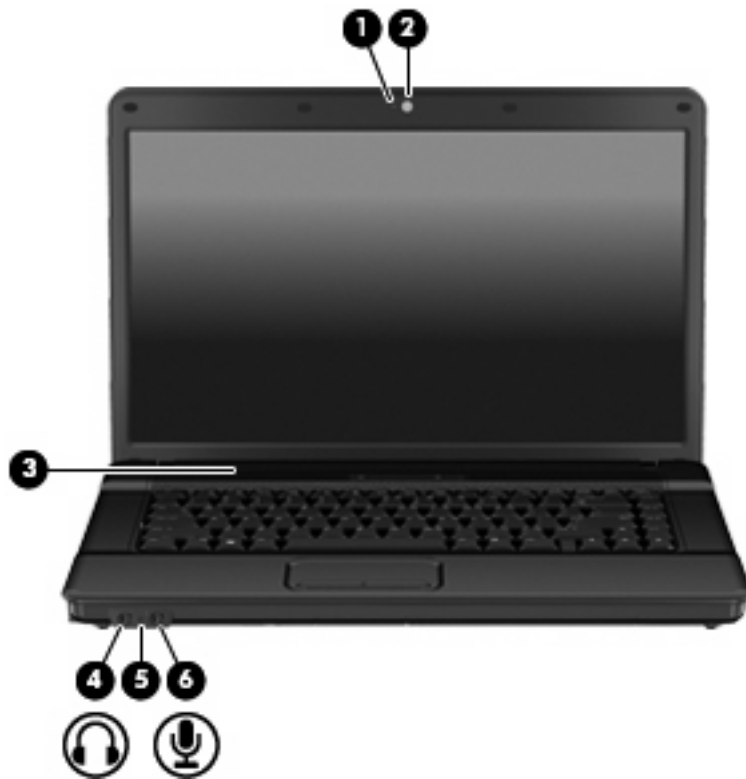

Component	Description
(1) Webcam light (select models only)	On: The webcam is in use.
(2) Webcam (select models only)	Records video and captures still photographs.
(3) Speaker	Produce sound.
(4) Audio-out (headphone) jack	Produces sound when connected to optional powered stereo speakers, headphones, ear buds, a headset, or television audio. NOTE: When a device is connected to the headphone jack, the computer speakers are disabled.
(5) Internal microphone	Records sound.
(6) Audio-in (microphone) jack	Connects an optional computer headset microphone, stereo array microphone, or monaural microphone.



Component	Description
(1) Webcam light (select models only)	On: The webcam is in use.
(2) Webcam (select models only)	Records video and captures still photographs.
(3) Speaker	Produces sound.
(4) Audio-out (headphone) jack	Produces sound when connected to optional powered stereo speakers, headphones, ear buds, a headset, or television audio. NOTE: When a device is connected to the headphone jack, the computer speakers are disabled.
(5) Internal microphone	Records sound.
(6) Audio-in (microphone) jack	Connects an optional computer headset microphone, stereo array microphone, or monaural microphone.

Adjusting the volume

You can adjust the volume using the following controls:

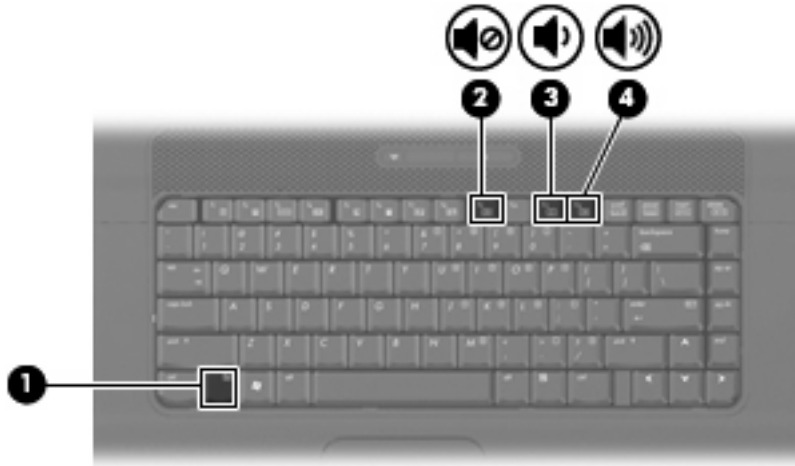

- Computer volume hotkey—A combination of the **fn** key (1) and either the **f9** (2), **f11** (3), or **f12** (4) function key:
 - To mute or restore volume, press **fn+f9**.
 - To decrease volume, press **fn+f11**.
 - To increase volume, press **fn+f12**.
- Windows® volume control:
 - a. Click the **Volume** icon in the notification area, at the far right of the taskbar.
 - b. Increase or decrease the volume by moving the slider up or down. Select the **Mute** check box to mute the volume.

– or –

 - a. Double-click the **Volume** icon in the notification area.
 - b. In the Volume control column, increase or decrease the volume by moving the **Volume** slider up or down. You can also adjust the balance or mute the volume.

If the Volume icon is not displayed in the notification area, follow these steps to add it:

 - a. Select **Start > Control Panel > Sounds, Speech, and Audio Devices > Sounds and Audio Devices > Volume** tab.
 - b. Select the **Place volume icon in the taskbar** check box.
 - c. Click **Apply**.
- Program volume control:

Volume can also be adjusted within some programs.

2 Multimedia software

The computer includes preinstalled multimedia software. Some computer models also include additional multimedia software on an optical disc.

Depending on the hardware and software included with the computer, the following multimedia tasks may be supported:

- Playing digital media, including audio and video CDs, audio and video DVDs, and Internet radio
- Creating or copying data CDs
- Creating, editing, and burning audio CDs
- Creating, editing, and burning a video or movie to a DVD or video CD

△ **CAUTION:** To prevent loss of information or damage to a disc, observe the following guidelines:

Before writing to a disc, connect the computer to a reliable external power source. Do not write to a disc while the computer is running on battery power.

Before writing to a disc, close all open programs except the disc software you are using.

Do not copy directly from a source disc to a destination disc or from a network drive to a destination disc. Instead, copy from a source disc or network drive to your hard drive, and then copy from your hard drive to the destination disc.

Do not use the computer keyboard or move the computer while the computer is writing to a disc. The write process is sensitive to vibration.

 **NOTE:** For information about using software included with the computer, refer to the software manufacturer's instructions that may be provided on disc, in the software Help, or on the software manufacturer's Web site.

Accessing your preinstalled multimedia software

To access your preinstalled multimedia software:

- ▲ Select **Start > All Programs**, and then open the multimedia program you want to use.

 **NOTE:** Some programs may be located in subfolders.

 **NOTE:** For details about using software included with the computer, refer to the software manufacturer's instructions, which may be provided with the software, on disc, or on the manufacturer's Web site.

Installing multimedia software from a disc

1. Insert the disc into the optical drive.
2. When the installation wizard opens, follow the on-screen instructions.
3. Restart the computer if prompted to do so.

 **NOTE:** For details about using software included with the computer, refer to the software manufacturer's instructions, which may be provided with the software, on disc, or on the manufacturer's Web site.

3 Audio

Your computer enables you to use a variety of audio features:

- Play music using your computer speakers and/or connected external speakers
- Record sound using the internal microphone or connect an external microphone
- Download music from the Internet
- Create multimedia presentations using audio and images
- Transmit sound and images with instant messaging programs
- Stream radio programs (select models only) or receive FM radio signals
- Create or “burn” audio CDs (select models only)

Connecting external audio devices

⚠ **WARNING!** To reduce the risk of personal injury, adjust the volume before putting on headphones, earbuds, or a headset. For additional safety information, refer to the *Regulatory, Safety and Environmental Notices*.

To connect external devices such as external speakers, headphones, or a microphone, refer to the information provided with the device. For best results, remember the following tips:

- Be sure that the device cable is securely connected to the correct jack on your computer. (Cable connectors are normally color-coded to match the corresponding jacks on the computer.)
- Be sure to install any drivers required by the external device.

📝 **NOTE:** A driver is a required program that acts like a translator between the device and the programs that use the device.

Checking your audio functions

To check the system sound on your computer, follow these steps:

1. Select **Start > Control Panel**.
2. Select **Sounds, Speech, and Audio Devices > Sounds and Audio Devices**.
3. When the Sounds and Audio Devices Properties window opens, click the **Sounds** tab. Under **Program events**, select any sound event, such as a beep or alarm, and then click the right arrow icon next to the listed sound.

You should hear sound through the speakers or through connected headphones.

To check the record functions of the computer, follow these steps:

1. Select **Start > All Programs > Accessories > Entertainment > Sound Recorder**.
2. Click **Record** and speak into the microphone. Save the file to your desktop.
3. Open Windows Media Player and play back the sound.

 **NOTE:** For best results when recording, speak directly into the microphone and record sound in a setting free of background noise.

- ▲ To confirm or change the audio settings on your computer, right-click the **Sound** icon on the taskbar, or select **Start > Control Panel > Sounds, Speech, and Audio Devices > Sounds and Audio Devices**.

4 Video

Your computer enables you to use a variety of video features:

- Watch movies
- Play games over the Internet and offline
- Edit pictures and video to create presentations
- Connect external video devices

Connecting an external monitor or projector

The external monitor port connects an external display device, such as an external monitor or a projector, to the computer.

- ▲ To connect a display device, connect the device cable to the external monitor port.

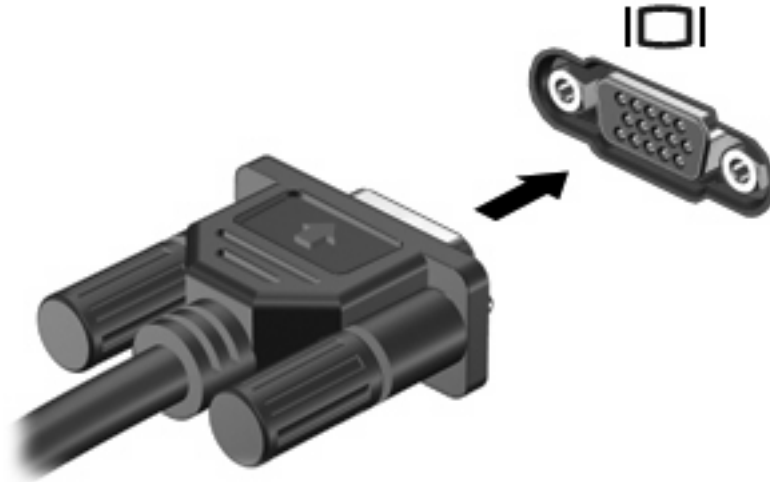

 **NOTE:** If a properly connected external display device does not display an image, press **fn+f4** to transfer the image to the device. Repeatedly pressing **fn+f4** alternates the screen image between the computer display and the device.

5 Optical drive

Depending on the type of optical drive and software installed in your computer, the optical drive plays, copies, and creates CDs or DVDs.

Identifying the installed optical drive

▲ Select **Start > My Computer**.

You will see a list of all the devices installed on your computer, including your optical drive. You may have one of the following types of drives:

- DVD-ROM Drive
- DVD±RW SuperMulti Double-Layer LightScribe Drive

 **NOTE:** Some of the drives listed above may not be supported by your computer.

Using optical discs (CDs and DVDs)

An optical drive, such as a DVD-ROM drive, supports optical discs (CDs and DVDs). These discs store information, such as music, photos, and movies. DVDs have a higher storage capacity than CDs.

Your optical drive can read standard CD and DVD discs.

 **NOTE:** Some of the optical drives listed may not be supported by your computer. The listed drives are not necessarily all of the supported optical drives.

Some optical drives can also write to optical discs as described in the following table.

Optical drive type	Write to CD-RW	Write to DVD±RW/R	Write to DVD±RW DL	Write label to LightScribe CD or DVD±RW/R
DVD-ROM Drive	No	No	No	No
DVD±RW SuperMulti Double-Layer LightScribe Drive*†	Yes	Yes	Yes	Yes

*Double-layer (DL) discs can store more data than single-layer discs. However, double-layer discs burned with this drive may not be compatible with many single-layer DVD drives and players.

†LightScribe discs must be purchased separately. LightScribe creates a grayscale image similar to black-and-white photography.

 **CAUTION:** To prevent possible audio and video degradation, loss of information, or loss of audio or video playback functionality, do not initiate Standby or Hibernation while reading a CD or DVD, or writing to a CD or DVD.

Selecting the right disc (CDs and DVDs)

CDs, used to store digital data, are also used for commercial audio recordings and are convenient for your personal storage needs. DVDs are used primarily for movies, software, and data backup purposes. DVDs are the same form factor as CDs but have a much higher storage capacity.

 **NOTE:** The optical drive on your computer may not support all the types of optical discs discussed in this section.

CD-R discs

Use CD-R (write-once) discs to create permanent archives and to share files with virtually anyone. Typical uses include the following:

- Distributing large presentations
- Sharing scanned and digital photos, video clips, and written data
- Making your own music CDs
- Keeping permanent archives of computer files and scanned home records
- Offloading files from your hard drive to free up disk space

After data is recorded, it cannot be erased or written over.

CD-RW discs

Use a CD-RW disc (a rewritable version of a CD) to store large projects that must be updated frequently. Typical uses include the following:

- Developing and maintaining large documents and project files
- Transporting work files
- Making weekly backups of hard drive files
- Updating photos, video, audio, and data continuously

DVD±R discs

Use blank DVD±R discs to permanently store large amounts of information. After data is recorded, it cannot be erased or written over.

DVD±RW discs

Use DVD±RW discs if you want to be able to erase or write over data that you saved earlier. This type of disc is ideal for testing audio or video recordings before you burn them to a CD or DVD that cannot be changed.

LightScribe DVD+R discs

Use LightScribe DVD+R discs for sharing and storing data, home videos, and photos. These discs are read-compatible with most DVD-ROM drives and DVD video players. With a LightScribe-enabled drive and LightScribe software, you can write data to the disc and then add a designer label to the outside of the disc.

Playing music

1. Turn on the computer.
2. Press the release button **(1)** on the drive bezel to release the disc tray.
3. Pull out the tray **(2)**.
4. Hold the disc by the edges to avoid touching the flat surfaces and position the disc label-side up over the tray spindle.

 **NOTE:** If the tray is not fully accessible, tilt the disc carefully to position it over the spindle.

5. Gently press the disc **(3)** down onto the tray spindle until the disc snaps into place.

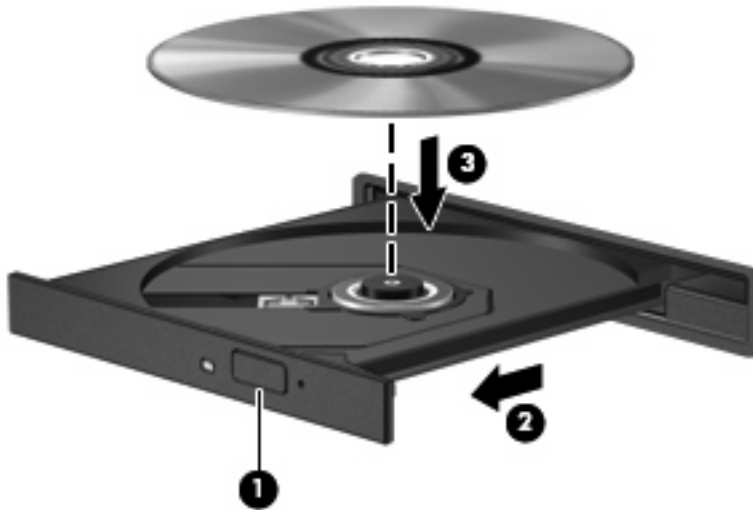

6. Close the disc tray.
7. If you have not yet configured AutoPlay, as described in the section "Configuring AutoPlay," an AutoPlay dialog box opens. It prompts you to select how you want to use the media content. Choose Windows Media Player.

 **NOTE:** After you insert a disc, a short pause is normal.

If Standby or Hibernation is initiated during playback of a disc, you may experience the following behaviors:

- Your playback may be interrupted.
- You may see a warning message asking if you want to continue. If this message is displayed, click **No**.
- You may need to restart the CD or DVD to resume playback.

Watching a movie

Your optical drive allows you to watch movies from a disc.

1. Turn on the computer.
2. Press the release button (1) on the optical drive bezel to release the disc tray.
3. Pull out the tray (2).
4. Hold the disc by the edges and position the disc label-side up over the tray spindle.

 **NOTE:** If the tray is not fully accessible, tilt the disc carefully to position it over the spindle.

5. Gently press the disc (3) down onto the tray spindle until the disc snaps into place.

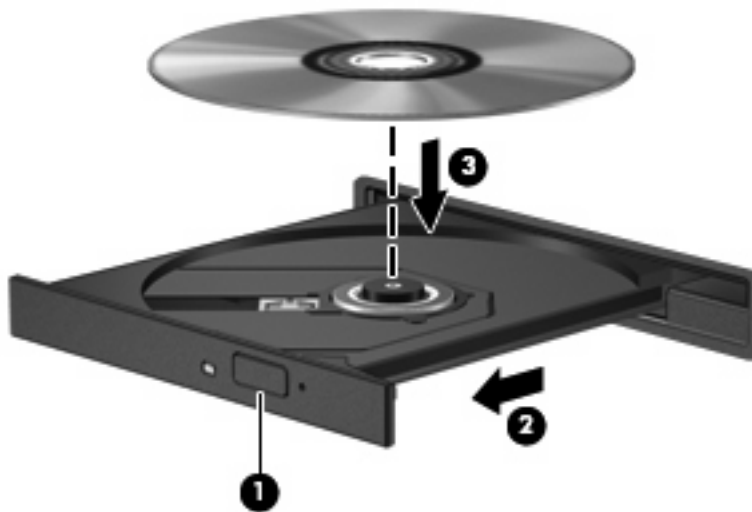

6. Close the disc tray.

 **NOTE:** After you insert a disc, a short pause is normal. If you have not selected a media player, an AutoPlay dialog box opens. It prompts you to select how you want to use the media content.

Configuring AutoPlay

1. Select **Start > My Computer**.
2. Right-click the device (such as CD-ROM drive), and then click **Properties**.
3. Click the **AutoPlay** tab, and then select one of the available actions.

 **NOTE:** Choose WinDVD to play DVDs.

4. Click **OK**.

 **NOTE:** For more information about AutoPlay, refer to Help and Support.

Changing DVD region settings

Most DVDs that contain copyrighted files also contain region codes. The region codes help protect copyrights internationally.

You can play a DVD containing a region code only if the region code on the DVD matches the region setting on your DVD drive.

△ **CAUTION:** The region settings on your DVD drive can be changed only 5 times.

The region setting you select the fifth time becomes the permanent region setting on the DVD drive.

The number of region changes remaining is displayed on the DVD Region tab.

To change settings through the operating system:

1. Select **Start > My Computer**.
2. Right-click in the window and select **Properties > Hardware tab > Device Manager**.
3. Click the "+" sign next to **DVD/CD-ROM drives**, right-click the DVD drive for which you want to change region settings, and then click **Properties**.
4. Make the desired changes on the **DVD Region** tab.
5. Click **OK**.

Observing the copyright warning

It is a criminal offense, under applicable copyright laws, to make unauthorized copies of copyright-protected material, including computer programs, films, broadcasts, and sound recordings. Do not use this computer for such purposes.

△ **CAUTION:** To prevent loss of information or damage to a disc, observe the following guidelines:

Before writing to a disc, connect the computer to a reliable external power source. Do not write to a disc while the computer is running on battery power.

Before writing to a disc, close all open programs except the disc software you are using.

Do not copy directly from a source disc to a destination disc or from a network drive to a destination disc.

Do not use the computer keyboard or move the computer while the computer is writing to a disc. The write process is sensitive to vibration.

📄 **NOTE:** For details about using software included with the computer, refer to the software manufacturer's instructions, which may be provided with the software, on disc, or on the manufacturer's Web site.

Copying a CD or DVD

1. Select **Start > All Programs > Roxio > Creator Business**.
2. In the right pane, click **Copy Disc**.
3. Insert the disc you want to copy into the optical drive.
4. Click **Copy** at the bottom right of the screen.

Creator Business reads the source disc and copies the data to a temporary folder on your hard drive.

5. When prompted, remove the source disc from the optical drive and insert a blank disc into the drive.

After the information is copied, the disc you created is ejected automatically.

Creating or “burning” a CD or DVD

If your computer includes a CD-RW, DVD-RW, or DVD+/-RW optical drive, you can use software such as Windows Media Player or Roxio Creator Business to burn data and audio files, including MP3 and WAV music files. To burn video files to a disc, use Windows Movie Maker.

Observe the following guidelines when burning a CD or DVD:

- Observe the copyright warning. It is a criminal offense, under applicable copyright laws, to make unauthorized copies of copyright-protected material, including computer programs, films, broadcasts, and sound recordings. Do not use this computer for such purposes.
- Before burning a disc, save and close any open files and close all programs.
- A CD-R or DVD-R is usually best for burning audio files because after the information is copied, it cannot be changed.
- Because some home and car stereos will not play CD-RWs, use CD-Rs to burn music CDs.
- A CD-RW or DVD-RW is generally best for burning data files or for testing audio or video recordings before you burn them to a CD or DVD that cannot be changed.
- DVD players used in home systems usually do not support all DVD formats. Refer to the user guide that came with your DVD player for a list of supported formats.
- An MP3 file uses less space than other music file formats, and the process for creating an MP3 disc is the same as the process for creating a data file. MP3 files can be played only on MP3 players or on computers with MP3 software installed.

To burn a CD or DVD, follow these steps:

1. Download or copy the source files into a folder on your hard drive.
2. Insert a blank disc into the optical drive.
3. Select **Start > All Programs** and the name of the software you want to use.
4. Select the kind of disc you want to create—data, audio, or video.
5. Right-click **Start > Explore** and navigate to the folder where the source files are stored.
6. Open the folder, and then drag the files to the drive that contains the blank disc.
7. Initiate the burning process as directed by the program you have selected.

For specific instructions, refer to the software manufacturer's instructions. These instructions may be provided with the software, on disc, or on the manufacturer's Web site.

Removing a CD or DVD

1. Press the release button (1) on the drive bezel to release the disc tray, and then gently pull out the tray (2) until it stops.
2. Remove the disc (3) from the tray by gently pressing down on the spindle while lifting the outer edges of the disc. Hold the disc by the edges and avoid touching the flat surfaces.

 **NOTE:** If the tray is not fully accessible, tilt the disc carefully as you remove it.



3. Close the disc tray and place the disc in a protective case.

6 Webcam (select models only)

 **NOTE:** The section describes features that are common to most models. Some features may not be available on your computer.

Your computer includes an integrated webcam, located at the top of the display. With the preinstalled software, you can use the webcam to take a photo, record a video, or make an audio recording. You can preview the photo, video recording, or audio recording, and save it on your computer hard drive.

To access the webcam and HP Webcam software, select **Start > All Programs > HP Webcam**.

The webcam software enables you to experiment with the following features:

- Video—Record and play back webcam video.
- Audio—Record and play back audio.
- Streaming video—Use with instant message software solutions that support UVC (Universal Video Class) cameras.
- Snapshots—Take still photos.

Webcam tips

For optimum performance, observe the following guidelines while using the webcam:

- Be sure that you have the latest version of an instant message program before starting a video conversation.
- The webcam may not work properly across some network firewalls.

 **NOTE:** If you are having trouble viewing or sending multimedia files to someone on another LAN or outside your network firewall, temporarily disable the firewall, perform the task you want to perform, and then reenable the firewall. To permanently resolve the problem, reconfigure the firewall as necessary, and adjust the policies and settings of other intrusion detection systems. For additional information, contact your network administrator or IT department.

- Whenever possible, place bright light sources behind the webcam and out of the picture area.

 **NOTE:** For details about using the webcam, click the **Help** menu in the webcam software Help, or select **Start > Help and Support**.

Adjusting webcam properties

You can adjust the following webcam properties:

- **Brightness**—Controls the amount of light that is incorporated into the image. A higher brightness setting creates a brighter image; a lower brightness setting creates a darker image.
- **Contrast**—Controls the difference between lighter and darker areas on the image. A higher contrast setting intensifies the image; a lower contrast setting maintains more of the original information's dynamic range but leads to a flatter image.
- **Hue**—Controls the aspect of color that distinguishes it from another color (what makes a color red, green, or blue). Hue is distinct from saturation, which measures the intensity of the hue.
- **Saturation**—Controls the strength of color in the final image. A higher saturation setting creates a bolder image; a lower saturation setting creates a more subtle image.
- **Sharpness**—Controls the definition of edges in an image. A higher sharpness setting creates a more defined image; a lower sharpness setting creates a softer image.
- **Gamma**—Controls the contrast affecting the mid-level grays or midtones of an image. Adjusting the gamma of an image allows you to change the brightness values of the middle range of gray tones without dramatically altering the shadows and highlights. A lower gamma setting makes grays look black, and makes dark colors even darker.
- **Backlight Compensation**—Compensates in cases where a subject with a large amount of background light would otherwise be obscured by blooming or silhouetting.
- **NightMode**—Compensates for low-light conditions.
- **Zoom (select models only)**—Adjusts the zoom percentage for taking photos or recording videos.
- **Horizontal or vertical**—Rotates the image horizontally or vertically.
- **50Hz or 60Hz**—Adjusts the shutter speed to achieve a video recording that does not flicker.

Customizable preset profiles for multiple lighting conditions compensate for the following lighting conditions: incandescent, fluorescent, halogen, sunny, cloudy, night.

7 Troubleshooting

The following sections describe several common issues and resolutions.

The optical disc tray does not open for removal of a CD or DVD

1. Insert the end of a paper clip (1) into the release access in the front bezel of the drive.
2. Press in gently on the paper clip until the disc tray is released, and then pull out the tray (2) until it stops.
3. Remove the disc (3) from the tray by gently pressing down on the spindle while lifting the outer edges of the disc. Hold the disc by the edges and avoid touching the flat surfaces.

 **NOTE:** If the tray is not fully accessible, tilt the disc carefully as you remove it.

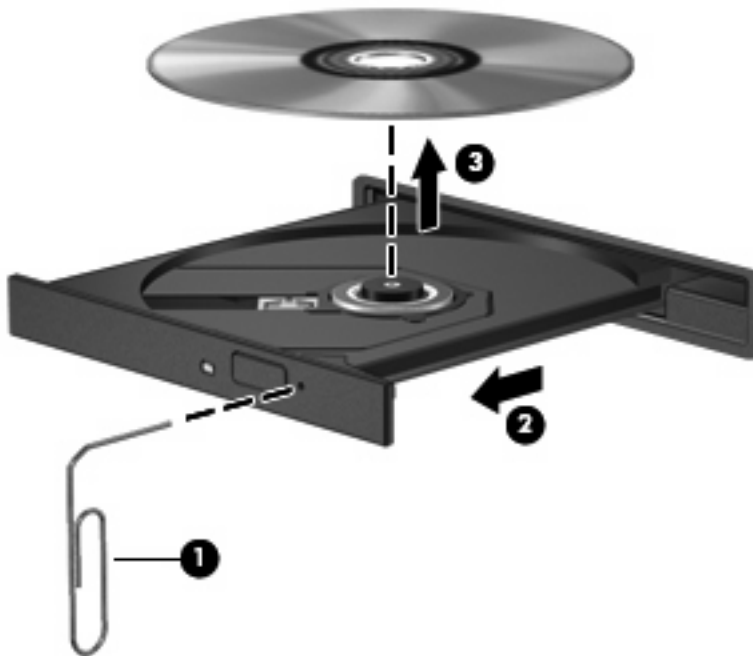

4. Close the disc tray and place the disc in a protective case.

The computer does not detect the optical drive

If the computer does not detect the optical drive, use Device Manager to troubleshoot the device and then update, roll back, or uninstall the device driver.

To check your devices and drivers in Device Manager, follow these steps:

1. Remove any discs from the optical drive.
2. Select **Start > My Computer**.
3. Right-click in the window and select **Properties > Hardware** tab, and then click **Device Manager**.
4. In the Device Manager window, click the plus sign (+) next to **Disc Drives** or **DVD/CD-ROM drives**, unless a minus sign (-) is already showing. Look for the optical drive listing.
5. Right-click the optical device listing to perform the following tasks:
 - Update the driver.
 - Disable the device.
 - Uninstall the device.
 - Scan for hardware changes. Windows scans your system for installed hardware and installs any required drivers.
 - Click **Properties** to see if the device is working properly:
 - Click **Troubleshoot** to fix problems.
 - Click the **Driver** tab to update, roll back, or uninstall drivers for this device.

A disc does not play

- Save your work and close all open programs before playing a CD or DVD.
- Log off the Internet before playing a CD or DVD.
- Be sure that you insert the disc properly.
- Be sure that the disc is clean. If necessary, clean the disc with filtered water and a lint-free cloth. Wipe from the center of the disc to the outer edge.
- Check the disc for scratches. If you find scratches, treat the disc with an optical disc repair kit available at many electronics stores.
- Disable Standby before playing a disc.

Do not initiate Hibernation or Standby while playing a disc. Otherwise, you may see a warning message asking if you want to continue. If this message is displayed, click **No**. After you click No, the computer may behave in either of the following ways:

- Playback may resume.

– or –

- The playback window in the multimedia program may close. To return to playing the disc, click the **Play** button in your multimedia program to restart the disc. In rare cases, you may need to exit the program and then restart it.

- Increase system resources:
 - Turn off external devices such as printers and scanners. This practice frees up valuable system resources and results in better playback performance.

Change desktop color properties. Because the human eye cannot easily tell the difference between colors beyond 16 bits, you should not notice any loss of color while watching a movie if you lower system color properties to 16-bit color, as follows:

1. Right-click on a blank area of the desktop, and then select **Properties > Settings**.
2. Set **Color quality** to **Medium (16 bit)**.

A disc does not play automatically

1. Click **Start > My Computer**.
2. Right-click the device (such as CD-ROM drive), and then click **Properties**.
3. Click the **AutoPlay** tab, and then select one of the available actions.
4. Click **OK**.

A CD or DVD should now start automatically when it is inserted into the optical drive.

 **NOTE:** For more information about AutoPlay, refer to Help and Support.

A DVD movie stops, skips, or plays erratically

- Check to be sure the disc is not scratched or damaged.
- Clean the disc.
- Conserve system resources by trying the following suggestions:
 - Log off the Internet.
 - Change the color properties of the desktop:
 1. Right-click on a blank area of the computer desktop, and select **Properties > Settings**.
 2. Set **Color quality** to **Medium (16 bit)**, if this setting is not already selected.
 - Disconnect external devices, such as a printer, scanner, camera, or handheld device.

A DVD movie is not visible on an external display

1. If both the computer display and an external display are turned on, press **fn+f4** one or more times to switch between the 2 displays.
2. Configure the monitor settings to make the external display primary:
 - a. Right-click on a blank area of the computer desktop, and select **Properties > Settings**.
 - b. Specify a primary display and a secondary display.

 **NOTE:** When using both displays, the DVD image will not appear on any display designated as the secondary display.

To get information about a multimedia question not covered in this guide, select **Start > Help and Support**.

The process of burning a disc does not begin, or it stops before completion

- Be sure that all other programs are closed.
- Turn off Standby and Hibernation.
- Be sure that you are using the right kind of disc for your drive. See your user guides for more information about disc types.
- Be sure that the disc is inserted properly.
- Select a slower write speed and try again.
- If you are copying a disc, save the information on the source disc to your hard drive before trying to burn the contents to a new disc, and then burn from your hard drive.
- Reinstall the disc-burning device driver located in the DVD/CD-ROM drives category in Device Manager.

A device driver must be reinstalled

Obtaining the latest HP device drivers

Follow either of the following procedures to obtain HP device drivers.

To use HP Update:

1. Select **Start > All Programs > HP > HP Update**.
2. On the HP Welcome screen, click **Settings**, and then select a time when the utility should check for software updates on the Web.
3. Click **Next** to immediately check for HP software updates.

To use the HP Web site:

1. Open your Internet browser, and go to <http://www.hp.com/support>, and select your country or region.
2. Click the option for software and driver downloads, and then type your computer model number in the product box.
3. Press **enter**, and then follow the on-screen instructions.

Obtaining Microsoft device drivers

You can obtain the latest Windows device drivers by using Microsoft® Update. This Windows feature can be set to automatically check for and install updates for your hardware drivers, as well as for the Windows operating system and other Microsoft products.

To use Microsoft Update:

1. Open your Internet browser and go to <http://www.microsoft.com>, and click **Security & Updates**.
2. Click **Microsoft Update** to get the latest updates for your computer operating system, programs, and hardware.
3. Follow the on-screen instructions to install Microsoft Update.
4. Click **Change settings** and select a time for Microsoft Update to check for updates to the Windows operating system and other Microsoft products.
5. If prompted to do so, restart your computer.

Using SoftPaq Download Manager

HP SoftPaq Download Manager (SDM) is a tool that provides quick access to SoftPaq information for HP business computers without having to know the SoftPaq number. Using this tool, you can easily search for SoftPaqs and then download and unpack them.

SoftPaq Download Manager works by reading and downloading, from the HP FTP site, a published database file containing computer model and SoftPaq information. SoftPaq Download Manager allows you to specify one or more computer models to determine which SoftPaqs are available for download.

SoftPaq Download Manager checks the HP FTP site for updates to the database and software. If updates are found, they are downloaded and applied automatically.

To download SoftPaqs:

1. Click **Start > All Programs > HP > HP Softpaq Download Manager**.
2. When the SoftPaq Download Manager opens for the first time, a window is displayed asking if you want to show only software for the computer you are using or to show the software for all supported models. Select **Show software for all supported models**. If you have used HP Softpaq Download Manager previously, go to Step 3.
 - a. Select your operating system and language filters in the Configuration Options window. The filters limit the number of options that are listed in the Product Catalog pane. For example, if only Microsoft® Windows® XP Professional is selected in the operating system filter, the only operating system that is displayed in the Product Catalog is Windows XP Professional.
 - b. To add other operating systems, change the filter settings in the Configuration Options window. Refer to the HP Softpaq Download Manager software Help for more information.
3. In the left pane, click the (+) sign to expand the model list, and then select the model(s) of the products you want to update.
4. Click **Find Available SoftPaqs** to download a list of available SoftPaqs for the selected computer.
5. Select from the list of available SoftPaqs, and then click **Download Only** if you have many SoftPaqs to download, because the Softpaq selection and Internet connection speed determine how long the download process will take.

If you have only one or two SoftPaqs to download and a high-speed Internet connection, click **Download & Unpack**.

6. Right-click **Install SoftPaq** in the SoftPaq Download Manager software application to install the SoftPaq on the computer.

Index

A

- audio devices, connecting
 - external 9
- audio features 8
- audio functions, checking 10
- audio-in (microphone) jack 2
- audio-in (microphone) jack, identifying 3
- audio-out (headphone) jack 2
- audio-out (headphone) jack, identifying 3
- AutoPlay 18

C

- CD
 - burning 22
 - copying 21
 - inserting 16
 - protecting 5
 - removing 23
 - writing to 5
- CD drive 13
- checking audio functions 10
- copyright warning 20

D

- device drivers
 - HP 35
 - Microsoft 35
 - uninstalling, reinstalling 35
- drives

- CD 13
- DVD 13
- DVD-ROM Drive 14
- DVD±RW SuperMulti Double-Layer LightScribe Drive 14
- optical 13

DVD

- burning 22
- changing region setting 19

- copying 21
- inserting 16
- protecting 5
- removing 23
- writing to 5

DVD region settings 19

E

- earbuds 2
- external audio devices, connecting 9
- external monitor port 12

H

- headphone (audio-out) jack 2
- headphones 2
- hotkeys
 - volume decrease 4
 - volume increase 4
 - volume mute 4

I

- internal microphone, identifying 2, 3
- issues, resolving 27

J

- jacks
 - audio-in (microphone) 2
 - audio-out (headphone) 2

M

- microphone, internal 2
- monitor, connecting 12
- movie, watching 17
- multimedia components, identifying 2
- multimedia software
 - accessing 6

O

- optical disc
 - inserting 16
 - removing 23
 - writing to 5
- optical drive
 - protecting 5
- optical drive detection 29

P

- ports
 - external monitor 12
 - projector, connecting 12

R

- region codes, DVD 19

S

- SoftPaqs, downloading 36
- speaker 2
- speaker, identifying 3

T

- tips, webcam 25
- troubleshooting
 - AutoPlay 31
 - device drivers 35
 - disc burning 34
 - disc play 30
 - DVD movie play 32
 - external display 33
 - optical disc tray 28
 - optical drive detection 29

U

- using the webcam 24

V

- video, using 11
- volume, adjusting 4

W

webcam

- adjusting properties 26

- identifying 2

- tips 25

- using 24

webcam light, identifying 2, 3

webcam, identifying 3

