

Front (English/Français)

hp HP BD-2000 Blu-ray Disc Player
- Full HD. Full Illumination.

Quick Start Guide

What's inside the box...

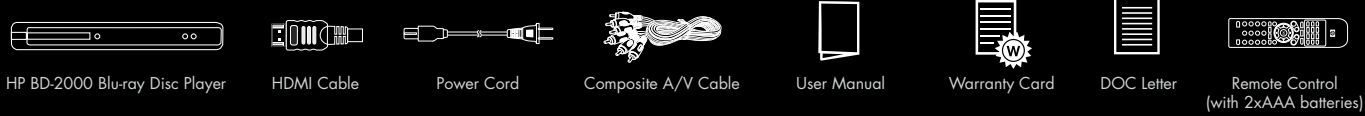

Connect: Select one of the connection options below

Option A:
HDMI (video resolutions up to 1080p)
Required: HDMI Cable (included)
* A single HDMI connection can deliver both audio and video signals to your TV.

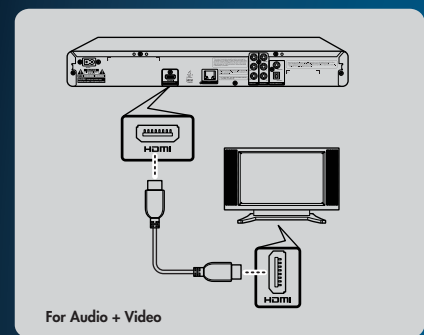

* Please refer to the User Manual for connecting coaxial or optical audio cables.

Option B:
Component (video resolutions up to 1080i)
Required: Component Video Cable (not included)
Composite A/V Cable (included)

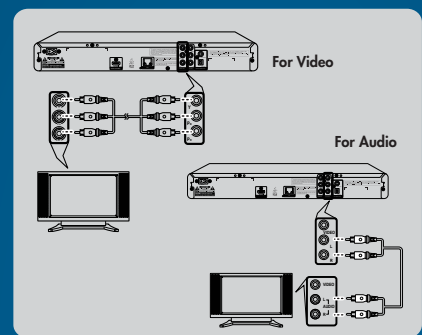

Option C:
Composite (video resolutions up to 480i)
Required: Composite A/V Cable (included)

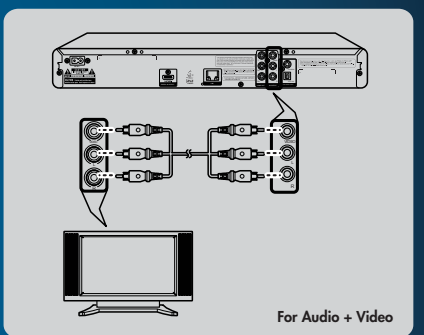

Setup

Step 1:
When the connection between your HP BD-2000 Blu-ray Disc Player and TV is complete, connect the supplied power cord.

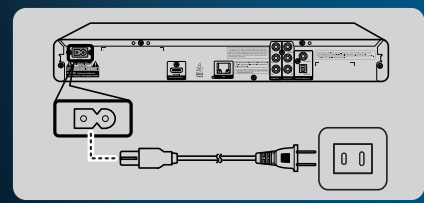

Step 2:
Turn on your TV and select the correct video source based on your earlier connection.

Connect
Option A: HDMI (video resolutions up to 1080p)
Option B: Component (video resolutions up to 1080i)
Option C: Composite (video resolutions up to 480i)

Step 3:
Turn on your HP BD-2000 Blu-ray Disc Player by pushing the power button on the front of the player, or on the remote control*.

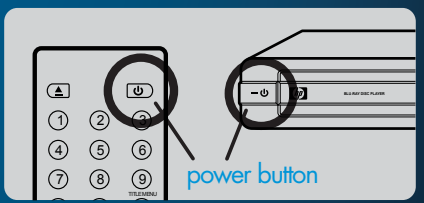

* Please insert the included batteries into the remote control before use.

Enjoy: 1. Open the disc tray by pushing **[Eject]** on the front of the player or pushing **[Eject]** on the remote control.
2. Place the Blu-ray or DVD disc with its label side up into the disc tray then close and start enjoying the movie!

Basic Remote Control Function:



Remote Control Signal

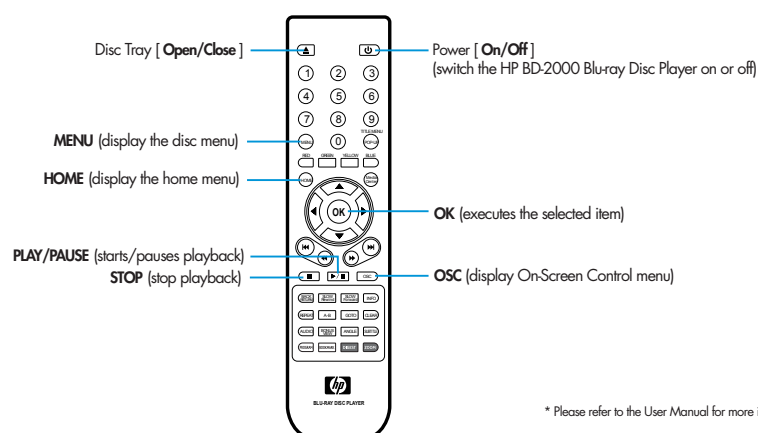

* Please refer to the User Manual for more information on the remote control.
#1N-79252C00055A / 7925200054A

hp Lecteur HP BD-2000 Disque Blu-ray
- Full HD. Illumination Complète.

Guide de mise en route rapide

Contenu de l'emballage...



Se connecter: Sélectionnez l'une des options de connexion ci-dessous

Option A:
HDMI (résolutions vidéo jusqu'à 1080p)
Requis: Câble HDMI (inclus)
* Une simple connexion HDMI peut délivrer à la fois des signaux audio et vidéo à votre téléviseur.

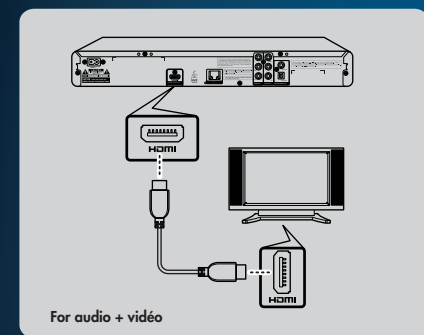

* Veuillez consulter le Manuel de l'utilisateur pour connecter les câbles audio coaxiaux et optiques.

Option B:
Composant (résolutions vidéo jusqu'à 1080i)
Requis: Câble de Composant Vidéo (pas inclus)
Câble Composite A/V (inclus)

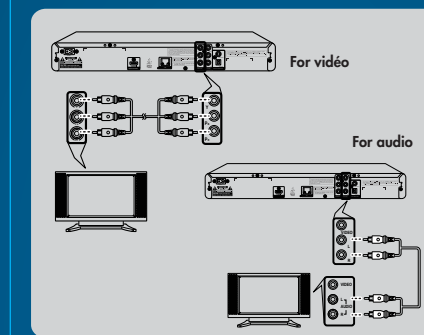

Option C:
Composite (résolutions vidéo jusqu'à 480i)
Requis: Câble Composite A/V (inclus)

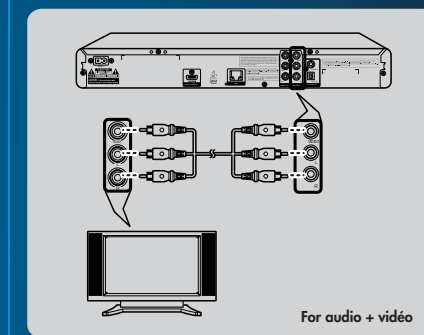

Configuration

Étape 1:
Une fois la connexion entre votre lecteur HP BD-2000 Blu-ray et votre téléviseur établie, connectez le cordon d'alimentation fourni.

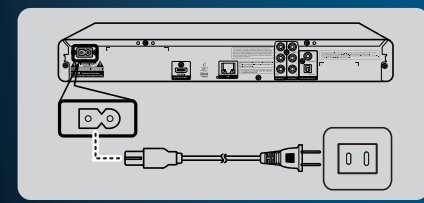

Étape 2:
Allumez votre téléviseur et sélectionnez la source vidéo en fonction de votre connexion antérieure.

Connect
Option A: HDMI (résolutions vidéo jusqu'à 1080p)
Option B: Composant (résolutions vidéo jusqu'à 1080i)
Option C: Composite (résolutions vidéo jusqu'à 480i)

Étape 3:
Allumez votre lecteur HP BD-2000 Blu-ray en appuyant sur le bouton d'alimentation à l'avant du lecteur, ou sur la télécommande*.

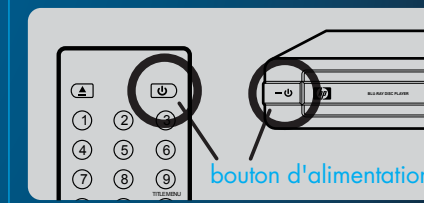

* Veuillez insérer les piles fournies dans la télécommande avant utilisation.

Appréciez: 1. L'ouverture du plateau du lecteur en appuyant sur **[Eject]** à l'avant du lecteur ou sur **[Eject]** de la télécommande.
2. Placez le disque Blu-ray ou DVD sur le plateau du lecteur avec son étiquette face vers le haut puis fermez et appréciez le film!

Fonctions élémentaires de la télécommande :

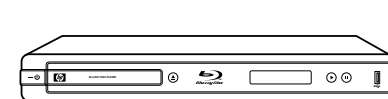

Signal de la télécommande

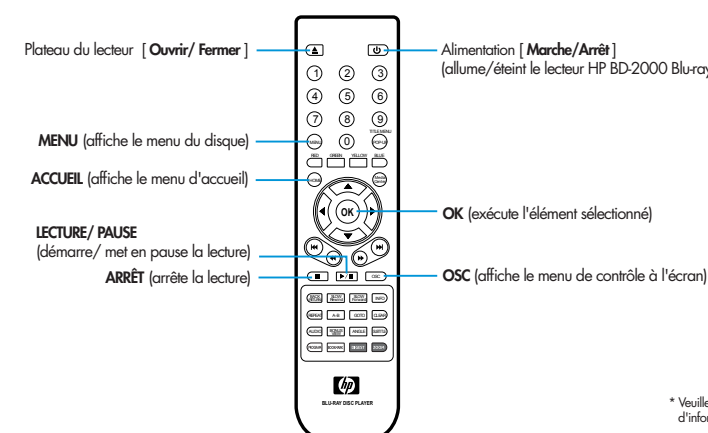

* Veuillez consulter le Manuel de l'utilisateur pour plus d'informations à propos de la télécommande.
#1N-79252C00055A / 7925200054A

Back (Español/Português)

hp Reproductor de discos Blu-ray HP BD-2000
- HD completo. Iluminación completa.

Guía de inicio rápido

Qué contiene la caja...



Conector: Seleccione una de las opciones de conexión siguientes

Opción A:
HDMI (resoluciones de video de hasta 1080p)
Requerido: Cable HDMI (incluido)
* Una única conexión HDMI puede llevar señales de audio y video a su televisor.

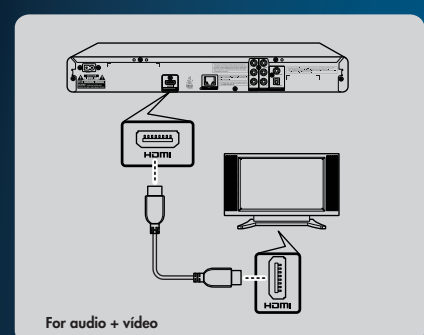

* Consulte el manual del usuario para la conexión de los cables de audio coaxial u óptico.

Opción B:
Componente (resoluciones de video de hasta 1080i)
Requerido: Cable de video componente (no incluido)
Cable A/V compuesto (incluido)

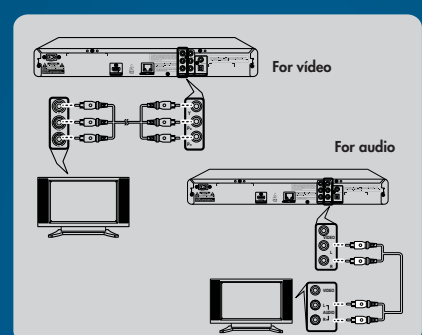

Opción C:
Compuesto (resoluciones de video de hasta 480i)
Requerido: Cable A/V compuesto (incluido)

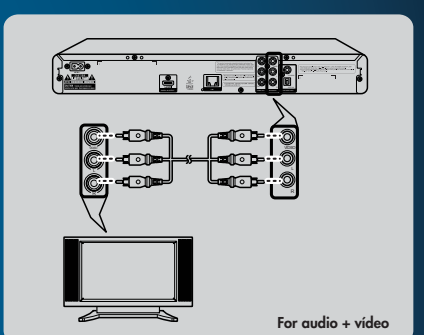

Configuración

Paso 1:
Cuando la conexión entre su Reproductor de Discos Blu-ray HP BD-2000 y el televisor esté completada, conecte el cable de corriente incluido.

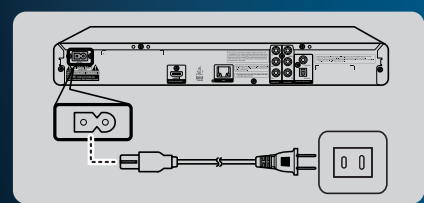

Paso 2:
Encienda su televisor y seleccione la fuente de video correcta basándose en la conexión anterior.

Conector
Opción A: HDMI (resoluciones de video de hasta 1080p)
Opción B: Componente (resoluciones de video de hasta 1080i)
Opción C: Compuesto (resoluciones de video de hasta 480i)

Paso 3:
Encienda su Reproductor de Discos Blu-ray HP BD-2000 presionando el botón de encendido en la parte frontal del reproductor o en el mando a distancia*.

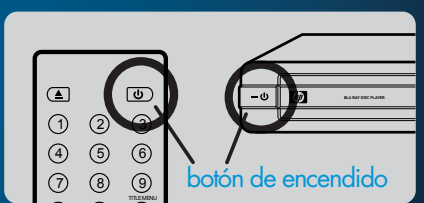

* Inserte las pilas incluidas en el mando antes de utilizarlo.

Disfrute: 1. Abra la bandeja de discos presionando **[Eject]** en la parte frontal del reproductor o presionando **[Eject]** en el mando a distancia.
2. Coloque el disco Blu-ray o DVD con la cara de la etiqueta hacia arriba en la bandeja del disco, ciérrala y comience a disfrutar de la película!

Funciones básicas del mando a distancia:



Señal del mando a distancia

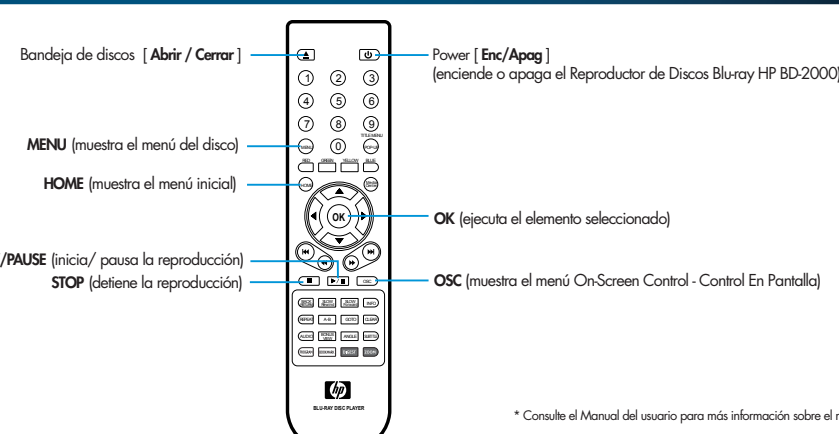

* Consulte el Manual del usuario para más información sobre el mando a distancia.
#1N-79252C00055A / 7925200054A

hp HP BD-2000 Blu-ray Disc Player
- Full HD. Full Illumination.

Guia de Início Rápido

O que há na embalagem...



Conectar: Seleccione uma das opções de conexão abaixo

Opção A:
HDMI (resolução de vídeo até 1080p)
Requisitos: Cabo HDMI (incluído)
* Uma única conexão HDMI pode gerar sinais de áudio e vídeo para sua TV.

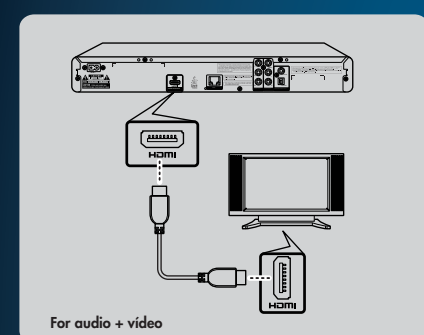

* Por favor, consulte o Manual do Usuário para conexão de cabos de áudio coaxiais ou ópticos.

Opção B:
Componente (resolução de vídeo até 1080i)
Requisitos: Cabo Vídeo Componente (não incluído)
Cabo Composite A/V (incluído)

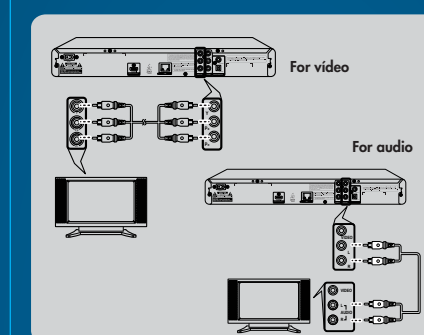

Opção C:
Composite (resolução de vídeo até 480i)
Requisitos: Cabo Composite A/V (incluído)

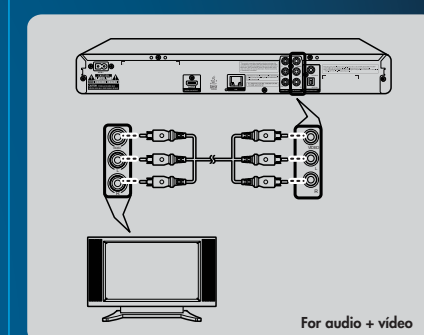

Instalação

Passo 1:
Quando a conexão entre o seu HP BD-2000 Blu-ray Disc Player e a TV estiver concluída, conecte o cabo de alimentação fornecido.

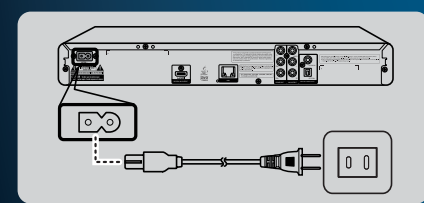

Passo 2:
Ligue sua TV e seleccione a fonte de vídeo correta com base em sua conexão anterior.

Conectar
Opção A: HDMI (resolução de vídeo até 1080p)
Opção B: Componente (resolução de vídeo até 1080i)
Opção C: Composite (resolução de vídeo até 480i)

Passo 3:
Ligue seu HP BD-2000 Blu-ray Disc Player pressionando o botão de energia na parte frontal do player ou no controle remoto*.

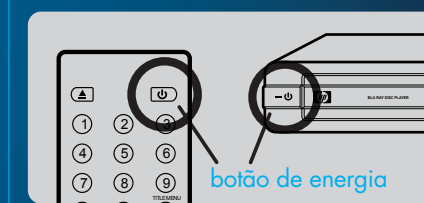

* Por favor, coloque as pilhas fornecidas no controle remoto antes de usar.

Divirta-se: 1. Abra a bandeja do disco pressionando **[Eject]** na parte frontal do player ou pressionando **[Eject]** no controle remoto.
2. Coloque o disco Blu-ray ou DVD com o rótulo voltado para cima na bandeja do disco, em seguida feche e comece a apreciar o filme!

Funções Básicas do Controle Remoto :

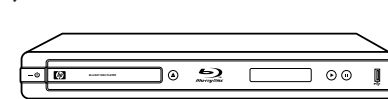

Signal do Controle Remoto

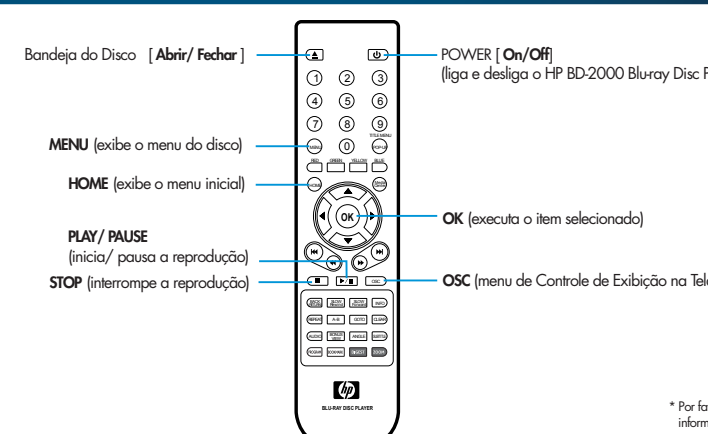

* Por favor, consulte o Manual do Usuário para mais informações sobre o controle remoto.
#1N-79252C00055A / 7925200054A