

# Multimedia User Guide

© Copyright 2009 Hewlett-Packard  
Development Company, L.P.

Windows is a U.S. registered trademark of  
Microsoft Corporation.

The information contained herein is subject  
to change without notice. The only  
warranties for HP products and services are  
set forth in the express warranty statements  
accompanying such products and services.  
Nothing herein should be construed as  
constituting an additional warranty. HP shall  
not be liable for technical or editorial errors  
or omissions contained herein.

Second Edition: August 2009

First Edition: August 2009

Document Part Number: 539995-002

#### **Product notice**

This user guide describes features that are  
common to most models. Some features  
may not be available on your computer.

---

# Table of contents

## 1 Multimedia features

Identifying your multimedia components .....	2
Using the DVD button (select models only) .....	3
Adjusting the volume .....	4
Using the media activity functions .....	6
Using the media activity hotkeys .....	6

## 2 Multimedia software

Using DVD Play software .....	7
Using other preinstalled multimedia software .....	7
Installing multimedia software from a disc .....	7

## 3 Audio

Connecting external audio devices .....	9
Checking your audio functions .....	9

## 4 Video

Connecting an external monitor or projector .....	10
Connecting an HDMI device .....	11
Configuring audio for HDMI .....	12

## 5 Optical drive

Identifying the installed optical drive .....	13
Using optical discs .....	14
Selecting the right disc .....	15
CD-R discs .....	15
CD-RW discs .....	15
DVD±R discs .....	15
DVD±RW discs .....	15
LightScribe DVD+R discs .....	16
Blu-ray Disc .....	16
Playing music .....	17
Watching a movie .....	18
Changing DVD region settings .....	19
Creating or “burning” a CD or DVD .....	20
Removing an optical disc (CD or DVD) .....	21

## 6 Webcam (select models only)

Webcam tips .....	23
Adjusting webcam properties .....	23

## 7 Troubleshooting

The optical disc tray does not open for removal of a CD or DVD .....	24
The computer does not detect the optical drive .....	25
A disc does not play .....	26
A disc does not play automatically .....	26
A DVD movie stops, skips, or plays erratically .....	27
A DVD movie is not visible on an external display .....	27
The process of burning a disc does not begin, or it stops before completion .....	27
A DVD playing in Windows Media Player produces no sound or display .....	28
A device driver must be reinstalled .....	28
Obtaining the latest HP device drivers .....	29
Obtaining the latest Windows device drivers .....	29

<b>Index .....</b>	<b>30</b>
--------------------	-----------

---

# 1 Multimedia features

Your computer includes multimedia features that allow you to listen to music, watch movies, and view pictures. Your computer may include the following multimedia components:

- Optical drive for playing audio and video discs
- Integrated speakers for listening to music
- Integrated microphone for recording your own audio
- Integrated webcam that allows you to capture and share video
- Preinstalled multimedia software that allows you to play and manage your music, movies, and pictures
- Multimedia buttons and hotkeys that provide fast access to multimedia tasks

---

 **NOTE:** Your computer may not include all of the components listed.

---

The following sections explain how to identify and use the multimedia components included with your computer.

## Identifying your multimedia components

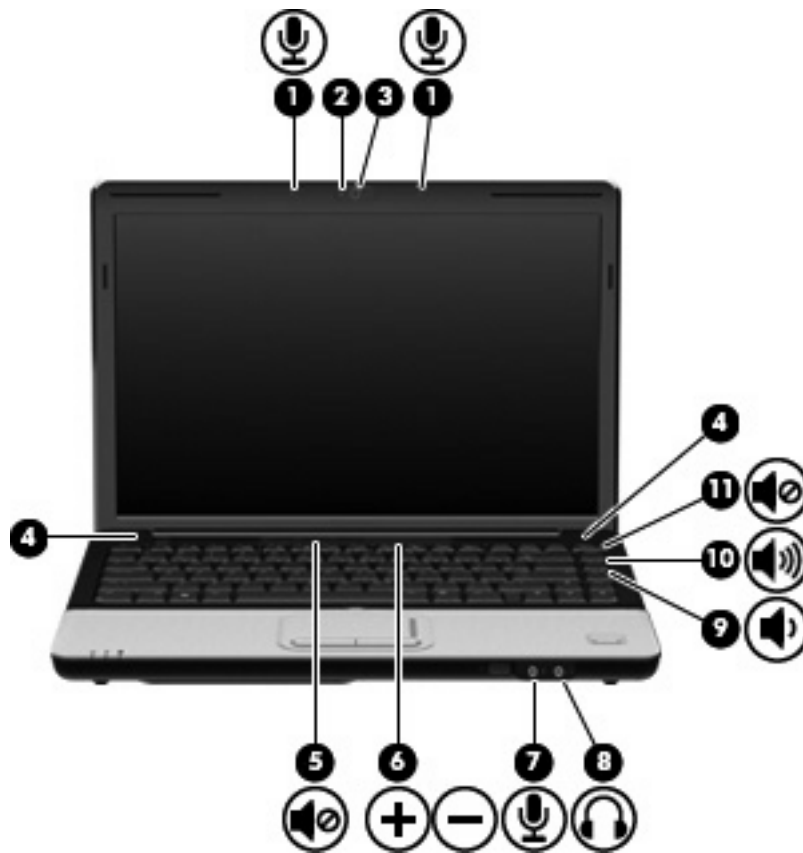

Component	Description
(1) Internal microphone	Records sound.  <b>NOTE:</b> Depending on your computer model, the computer may have 1 or 2 internal microphones.
(2) Webcam light (select models only)	Turns on when video software accesses the webcam.
(3) Webcam (select models only)	Captures video.
(4) Speakers (2)	Produce sound.
(5) Volume mute button (select models only)	Mutes and restores speaker sound.
(6) Volume scroll zone (select models only)	Adjusts speaker volume.
(7) Audio-in (microphone) jack	Connects an optional computer headset microphone, stereo array microphone, or monaural microphone.
(8) Audio-out (headphone) jack	Produces sound when connected to optional powered stereo speakers, headphones, ear buds, a headset, or television audio.  <b>WARNING!</b> To reduce the risk of personal injury, adjust the volume before putting on headphones, earbuds, or a headset. For additional safety information, refer to the <i>Regulatory, Safety and Environmental Notices</i> .  <b>NOTE:</b> When a device is connected to the headphone jack, the computer speakers are disabled.

Component	Description
(9) Volume down hotkey (pg dn)	Decreases speaker sound when pressed in combination with the <a href="#">fn</a> key.
(10) Volume up hotkey (pg up)	Increases speaker sound when pressed in combination with the <a href="#">fn</a> key.
(11) Volume mute hotkey (home)	Mutes and restores speaker sound when pressed in combination with the <a href="#">fn</a> key.

## Using the DVD button (select models only)

The function of the DVD button varies by model and installed software. With this button, you can watch movies and listen to music.



Pressing the DVD button launches the DVD Play program.

 **NOTE:** If the computer has been set up to require a logon password, you may be asked to log on to Windows. DVD Play opens after you log on. Refer to the DVD Play software Help for more information.

## Adjusting the volume

You can adjust the volume using the following controls:

- Computer volume buttons (select models only):
  - To mute or restore volume, press the mute button (1).
  - To decrease volume, slide your finger across the volume scroll zone from right to left, or press the volume down button (2).
  - To increase volume, slide your finger across the volume scroll zone from left to right, press the volume up button (3).

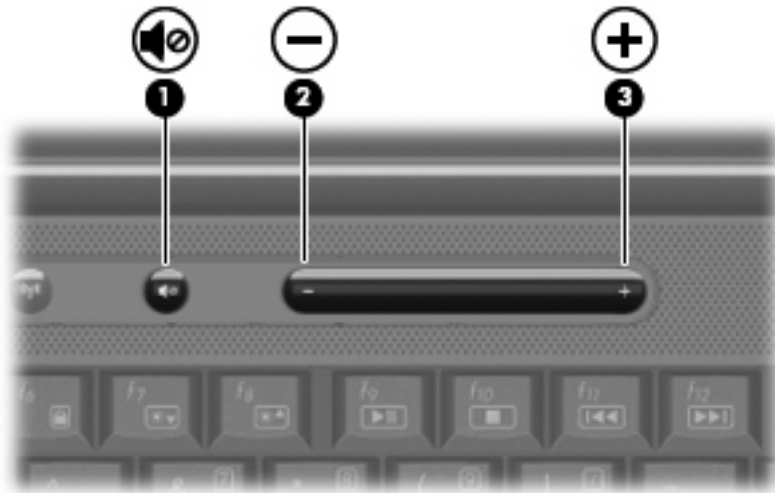

- Computer volume hotkeys—A combination of the **fn** (1) key and either the **home** (2), **pg up** (3), or **pg dn** (4) keys on the right side of the keyboard:

Computer volume hotkeys:

- To mute or restore volume, press **fn+home**.
- To increase volume, press **fn+pg up**.
- To decrease volume, press **fn+pg dn**.





- Windows® volume control:
  - a. Click the **Speakers** icon in the notification area, at the far right of the taskbar.
  - b. Increase or decrease the volume by moving the slider up or down. Click the **Mute Speakers** icon to mute the volume.

– or –

  - a. Right-click the **Speakers** icon in the notification area, and then click **Open Volume Mixer**.
  - b. In the Speakers column, you can increase or decrease the volume by moving the slider up or down. You can also mute the volume by clicking the **Mute Speakers** icon.

If the **Speakers** icon is not displayed in the notification area, follow these steps to add it:

  - a. Right-click the **Show hidden icons** icon (the arrow at the left side of the notification area).
  - b. Click **Customize notification icons**.
  - c. Under **Behaviors**, select **Show icon and notifications** for the Volume icon.
  - d. Click **OK**.
- Program volume control:

Volume can also be adjusted within some programs.

## Using the media activity functions

The media activity hotkeys control the play of an audio CD or a DVD that is inserted into the optical drive.

### Using the media activity hotkeys

A media activity hotkey is a combination of the **fn** key (1) and a function key (2).

- When an audio CD or a DVD is not playing, press **fn+f9** (3) to play the disc.
- When an audio CD or a DVD is playing, use the following hotkeys:
  - To pause or resume playing the disc, press **fn+f9** (3).
  - To stop the disc, press **fn+f10** (4).
  - To play the previous track of an audio CD or the previous chapter of a DVD, press **fn+f11** (5).
  - To play the next track of an audio CD or the next chapter of a DVD, press **fn+f12** (6).



---

## 2 Multimedia software

Your computer includes preinstalled multimedia software that allows you to play music and watch movies. The following sections provide details about DVD Play and other preinstalled multimedia software.

### Using DVD Play software

DVD Play turns your computer into a mobile entertainment center. With DVD Play, you can enjoy music and DVD movies.

To start DVD Play:

▲ Select **Start > All Programs > DVD Play**.

– or –

▲ On select models, press the DVD button on your computer.

For more information on using DVD Play, refer to the software Help.

### Using other preinstalled multimedia software

To locate other preinstalled multimedia software:

▲ Select **Start > All Programs**, and then open the multimedia program you want to use. For example, if you want to use Windows Media Player to play an audio CD, click **Windows Media Player**.

---

 **NOTE:** Some programs may be located in subfolders.

---

### Installing multimedia software from a disc

To install any multimedia software from a CD or DVD, follow these steps:

1. Insert the disc into the optical drive.
2. When the installation wizard opens, follow the on-screen instructions.
3. Restart the computer if you are prompted to do so.

---

 **NOTE:** For details about using software included with the computer, refer to the software manufacturer's instructions, which may be provided on disc, in the software Help, or on the manufacturer's Web site.

---

---

## 3 Audio

Your computer enables you to use a variety of audio features:

- Play music using your computer speakers and/or connected external speakers
- Record sound using the internal microphone or connect an external microphone
- Download music from the Internet
- Create multimedia presentations using audio and images
- Transmit sound and images with instant messaging programs
- Stream radio programs (select models only) or receive FM radio signals
- Create or “burn” audio CDs

# Connecting external audio devices

 **WARNING!** To reduce the risk of personal injury, adjust the volume before putting on headphones, earbuds, or a headset. For additional safety information, refer to the *Regulatory, Safety and Environmental Notices*.

---

To connect external devices such as external speakers, headphone, or a microphone, refer to the information provided with the device. For best results, remember the following tips:

- Be sure that the device cable is securely connected to the correct jack on your computer. (Cable connectors are normally color-coded to match the corresponding jacks on the computer.)
- Be sure to install any drivers required by the external device.

 **NOTE:** A driver is a required program that acts like a translator between the device and the programs that use the device.

---

## Checking your audio functions

To check the system sound on your computer, follow these steps:

1. Select **Start > Control Panel**.
2. Click **Hardware and Sound**.
3. Click **Sound**.
4. When the Sound window opens, click the **Sounds** tab. Under **Program Events**, select any sound event, such as a beep or alarm, and click the **Test** button.

You should hear sound through the speakers or through connected headphones.

To check the record functions of the computer, follow these steps:

1. Select **Start > All Programs > Accessories > Sound Recorder**.
2. Click **Start Recording** and speak into the microphone. Save the file to your desktop.
3. Open Windows Media Player or DVD Play and play back the sound.

 **NOTE:** For best results when recording, speak directly into the microphone and record sound in a setting free of background noise.

---

To confirm or change the audio settings on your computer, select **Start > Control Panel > Hardware and Sound > Sound**.

---

## 4 Video

Your computer enables you to use a variety of video features:

- Watch movies
- Play games over the Internet
- Edit pictures and video to create presentations
- Connect external video devices
- Watch TV, including high-definition TV (select models only)

### Connecting an external monitor or projector

The external monitor port connects an external display device such as an external monitor or a projector to the computer.

- ▲ To connect a display device, connect the device cable to the external monitor port.

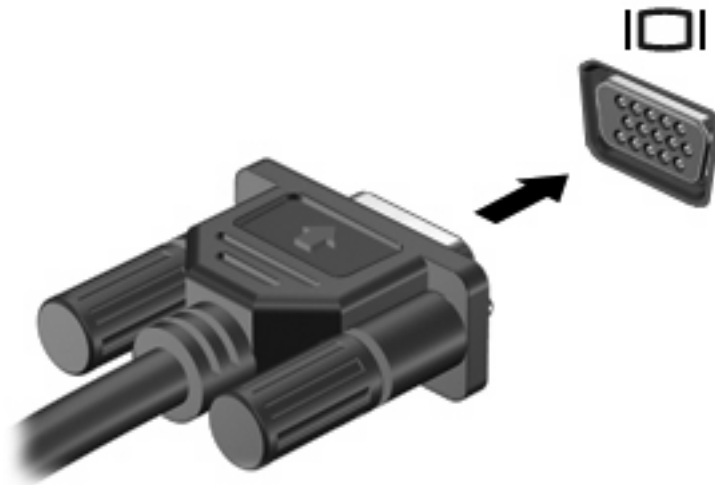

---

 **NOTE:** If a properly connected external display device does not display an image, press **fn+f4** to transfer the image to the device. Repeatedly pressing **fn+f4** alternates the screen image between the computer display and the device.

---

## Connecting an HDMI device

The computer includes an HDMI (High Definition Multimedia Interface) port. The HDMI port connects the computer to an optional video or audio device, such as a high-definition television, or any compatible digital or audio component.

The computer can support one HDMI device connected to the HDMI port, while simultaneously supporting an image on the computer display or any other supported external display.

---

 **NOTE:** To transmit video signals through the HDMI port, you need an HDMI cable (purchased separately), available from most electronic retailers.

---

To connect a video or audio device to the HDMI port:

1. Plug one end of the HDMI cable into the HDMI port on the computer.

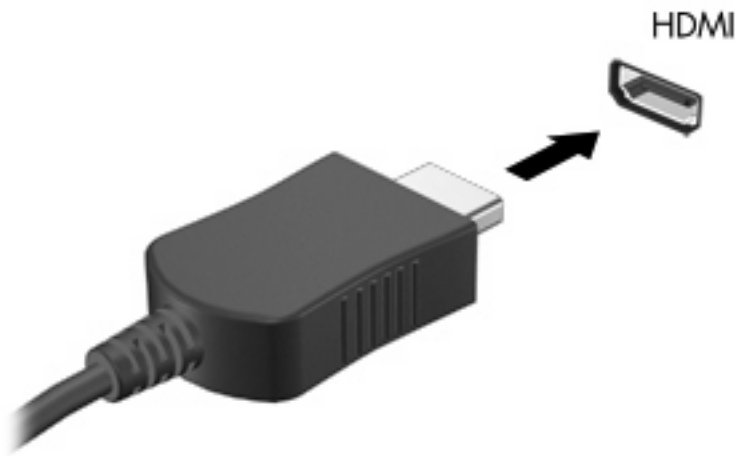

2. Connect the other end of the cable to the video device, according to the device manufacturer's instructions.
3. Press **fn+f4** on the computer to switch the image between the display devices connected to the computer.

## Configuring audio for HDMI

To configure HDMI audio, first connect an audio or video device, such as a high-definition TV, to the HDMI port on your computer. Then configure the default audio playback device as follows:

1. Right-click the **Speakers** icon in the notification area, at the far right of the taskbar, and then click **Playback devices**.
2. On the **Playback** tab, click either **Digital Output** or **Digital Output Device (HDMI)**.
3. Click **Set Default**, and then click **OK**.

To return audio to the computer speakers, follow these steps:

1. Right-click the **Speakers** icon in the notification area, at the far right of the taskbar, and then click **Playback devices**.
2. On the **Playback** tab, click **Speakers**.
3. Click **Set Default**, and then click **OK**.



---

# 5 Optical drive

Your computer includes an optical drive that expands the functionality of the computer. Identify what kind of device is installed in your computer to see its capabilities. The optical drive allows you to read data discs, play music, and watch movies. If your computer includes a Blu-ray Disc ROM Drive, then you can also watch high-definition video from disc.

## Identifying the installed optical drive

▲ Select **Start > Computer**.

You will see a list of all the devices installed on your computer, including your optical drive. You may have one of the following types of drives:

- DVD±RW and CD-RW SuperMulti Double-Layer Combo Drive
- DVD±RW and CD-RW SuperMulti Double-Layer Combo Drive with LightScribe
- Blu-ray ROM DVD±R/RW SuperMulti Double-Layer Drive
- Blu-ray ROM with LightScribe DVD±R/RW SuperMulti Double-Layer Drive

---

 **NOTE:** Some of the drives listed above may not be supported by your computer.

---

## Using optical discs

An optical drive, such as a DVD-ROM drive, supports optical discs (CDs and DVDs). These discs store information, such as music, photos, and movies. DVDs have a higher storage capacity than CDs.

Your optical drive can read standard CD and DVD discs. If your optical drive is a Blu-ray Disc ROM Drive, it can also read Blu-ray discs.

 **NOTE:** Some of the optical drives listed may not be supported by your computer. The listed drives are not necessarily all of the supported optical drives.

Some optical drives can also write to optical discs as described in the following table.

Optical drive type	Write to CD-RW	Write to DVD±RW/R	Write to DVD+RW DL	Write label to LightScribe CD or DVD±RW/R
DVD±RW and CD-RW SuperMulti DL Combo Drive	Yes	Yes	Yes	No
DVD±RW and CD-RW SuperMulti DL Combo Drive with LightScribe	Yes	Yes	Yes	Yes
Blu-ray ROM DVD±R/RW SuperMulti DL Drive	Yes	Yes	Yes	No
Blu-ray ROM with LightScribe DVD±R/RW SuperMulti DL Drive	Yes	Yes	Yes	Yes

 **CAUTION:** To prevent possible audio and video degradation, loss of information, or loss of audio or video playback functionality, do not initiate Sleep or Hibernation while reading or writing to a CD or DVD.

## Selecting the right disc

An optical drive supports optical discs (CDs and DVDs). CDs, used to store digital data, are also used for commercial audio recordings and are convenient for your personal storage needs. DVDs are used primarily for movies, software, and data backup purposes. DVDs are the same form factor as CDs but have 6 to 7 times the storage capacity.

 **NOTE:** The optical drive on your computer may not support all the types of optical discs discussed in this section.

---

### CD-R discs

Use CD-R (write-once) discs to create permanent archives and to share files with virtually anyone. Typical uses include the following:

- Distributing large presentations
- Sharing scanned and digital photos, video clips, and written data
- Making your own music CDs
- Keeping permanent archives of computer files and scanned home records
- Offloading files from your hard drive to free up disk space

After data is recorded, it cannot be erased or written over.

### CD-RW discs

Use a CD-RW disc (a rewritable version of a CD) to store large projects that must be updated frequently. Typical uses include the following:

- Developing and maintaining large documents and project files
- Transporting work files
- Making weekly backups of hard drive files
- Updating photos, video, audio, and data continuously

### DVD±R discs

Use blank DVD±R discs to permanently store large amounts of information. After data is recorded, it cannot be erased or written over.

### DVD±RW discs

Use DVD±RW discs if you want to be able to erase or write over data that you saved earlier. This type of disc is ideal for testing audio or video recordings before you burn them to a CD or DVD that cannot be changed.

## LightScribe DVD+R discs

Use LightScribe DVD+R discs for sharing and storing data, home videos, and photos. These discs are read-compatible with most DVD-ROM drives and DVD video players. With a LightScribe-enabled drive and LightScribe software, you can write data to the disc and then add a designer label to the outside of the disc.

## Blu-ray Disc

Also called BD, Blu-ray Disc is a high-density optical disc format for the storage of digital information, including high-definition video. A single-layer Blu-ray Disc can store 25 GB, over five times the size of a single-layer DVD at 4.7 GB. A dual-layer Blu-ray Disc can store 50 GB, almost 6 times the size of a dual-layer DVD at 8.5 GB.

Typical uses include the following:

- Storage of large amounts of data
- High-definition video playback and storage

## Playing music

1. Turn on the computer.
2. Press the release button (1) on the optical drive bezel to release the disc tray.
3. Pull out the tray (2).
4. Hold the disc by the edges and position the disc label-side up over the tray spindle.

---

 **NOTE:** If the tray is not fully accessible, tilt the disc carefully to position it over the spindle.

---

5. Gently press the disc (3) down onto the tray spindle until the disc snaps into place.

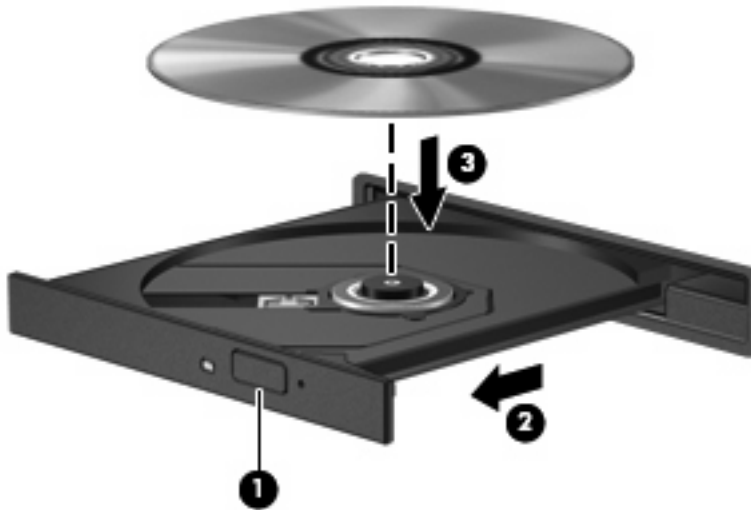

6. Close the disc tray.
7. If you have not yet configured AutoPlay, the AutoPlay dialog box opens and asks how you want to use the media content. Choose DVD Play or Windows Media Player, both preinstalled on your computer.

---

 **NOTE:** After you insert a disc, a short pause is normal.

---

If Sleep or Hibernation is initiated during playback of a disc, you may experience the following behaviors:

- Your playback may be interrupted.
- You may see a warning message asking if you want to continue. If this message is displayed, click **No**.
- You may need to restart the CD or DVD to resume playback.

## Watching a movie

Your optical drive allows you to watch movies from a disc. You can also watch high-definition movies from a disc if your computer includes an optional Blu-ray Disc ROM Drive.

1. Turn on the computer.
2. Press the release button **(1)** on the optical drive bezel to release the disc tray.
3. Pull out the tray **(2)**.
4. Hold the disc by the edges and position the disc label-side up over the tray spindle.

 **NOTE:** If the tray is not fully accessible, tilt the disc carefully to position it over the spindle.

5. Gently press the disc **(3)** down onto the tray spindle until the disc snaps into place.

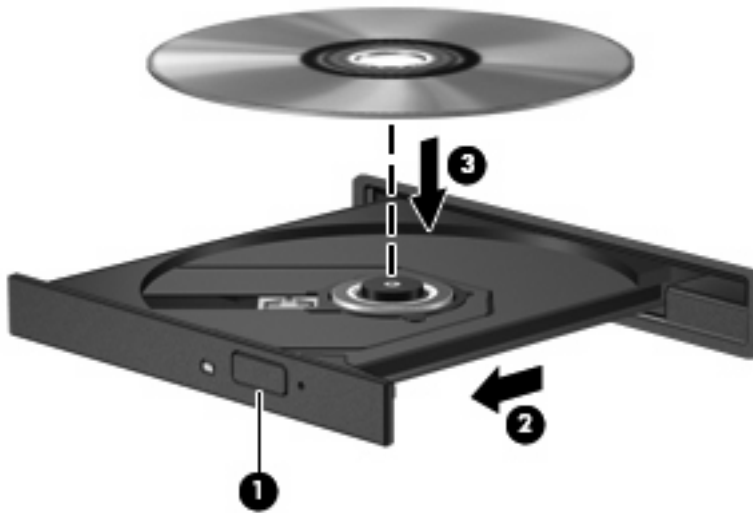

6. Close the disc tray.
7. To launch the DVD playback feature:
  - ▲ Select **Start > All Programs > DVD Play**.
  - or –
  - ▲ On select models, press the DVD button on your computer.
8. Then click the DVD icon and follow the instructions on the screen.

 **NOTE:** To watch a high-definition movie, you must use DVD Play. To watch standard format movies, you can use DVD Play or other multimedia software.

# Changing DVD region settings

Most DVDs that contain copyrighted files also contain region codes. The region codes help protect copyrights internationally.

You can play a DVD containing a region code only if the region code on the DVD matches the region setting on your DVD drive.

---

△ **CAUTION:** The region settings on your DVD drive can be changed only 5 times.

The region setting you select the fifth time becomes the permanent region setting on the DVD drive.

The number of region changes remaining is displayed on the DVD Region tab.

---

To change settings through the operating system:

1. Select **Start > Control Panel > System and Security**. Then in the **System** area, click **Device Manager**.

 **NOTE:** Windows includes the User Account Control feature to improve the security of your computer. You may be prompted for your permission or password for tasks such as installing applications, running utilities, or changing Windows settings. Refer to Windows Help for more information.

---

2. Click the arrow next to **DVD/CD-ROM drives** to expand the list to show all of the installed drives.
3. Right-click the DVD drive for which you want to change region settings, and then click **Properties**.
4. Make the desired changes on the **DVD Region** tab.
5. Click **OK**.

## Creating or “burning” a CD or DVD

If your computer includes a CD-RW, DVD-RW, or DVD±RW optical drive, you can use software such as Windows Media Player or CyberLink Power2Go to burn data and audio files, including MP3 and WAV music files. To burn video files to a CD or DVD, use MyDVD.

Observe the following guidelines when burning a CD or DVD:

- Before burning a disc, save and close any open files and close all programs.
- A CD-R or DVD-R is usually best for burning audio files because after the information is copied, it cannot be changed.

---

 **NOTE:** You cannot create an audio DVD with CyberLink Power2Go.

---

- Because some home and car stereos will not play CD-RWs, use CD-Rs to burn music CDs.
- A CD-RW or DVD-RW is generally best for burning data files or for testing audio or video recordings before you burn them to a CD or DVD that cannot be changed.
- DVD players used in home systems usually do not support all DVD formats. Refer to the user guide that came with your DVD player for a list of supported formats.
- An MP3 file uses less space than other music file formats, and the process for creating an MP3 disc is the same as the process for creating a data file. MP3 files can be played only on MP3 players or on computers with MP3 software installed.

To burn a CD or DVD, follow these steps:

1. Download or copy the source files into a folder on your hard drive.
2. Insert a blank CD or DVD into the optical drive.
3. Select **Start > All Programs** and the name of the program you want to use.

---

 **NOTE:** Some programs may be located in subfolders.

---

4. Select the kind of CD or DVD you want to create—data, audio, or video.
5. Right-click **Start**, click **Open Windows Explorer**, and navigate to the folder where the source files are stored.
6. Open the folder, and then drag the files to the drive that contains the blank optical disc.
7. Initiate the burning process as directed by the program you have selected.

For specific instructions, refer to the software manufacturer's instructions, which may be provided with the software, on disc, or on the manufacturer's Web site.

---

△ **CAUTION:** Observe the copyright warning. It is a criminal offense, under applicable copyright laws, to make unauthorized copies of copyright-protected material, including computer programs, films, broadcasts, and sound recordings. Do not use this computer for such purposes.

---



## Removing an optical disc (CD or DVD)

1. Press the release button (1) on the drive bezel to release the media tray, and then gently pull out the tray (2) until it stops.
2. Remove the disc (3) from the tray by gently pressing down on the spindle while lifting the outer edges of the disc. Hold the disc by the edges and avoid touching the flat surfaces.

 **NOTE:** If the tray is not fully accessible, tilt the disc carefully as you remove it.

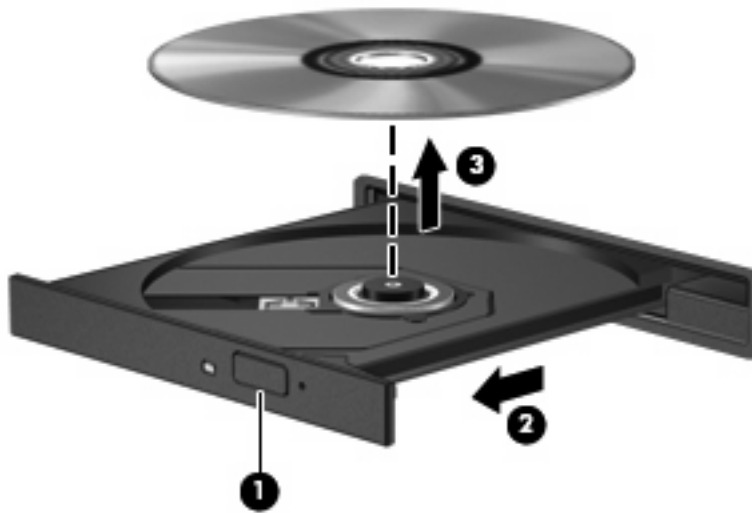

3. Close the media tray and place the disc in a protective case.

---

## 6 Webcam (select models only)

Your computer includes an integrated webcam, located at the top of the display. The webcam is an input device that allows you to capture and share video. Preinstalled CyberLink YouCam software provides new features that expand the webcam experience.

To access the webcam and CyberLink YouCam software, select **Start > All Programs > CyberLink YouCam > YouCam**.

---

 **NOTE:** The first time you access the YouCam software, you may experience a brief delay as the software loads.

---

Using YouCam as your default webcam software enables you to experiment with the following features:

- Video—Record and play back webcam video. You can also e-mail or upload video to YouTube, using the icon on the software interface.
- Streaming video—When you open your instant message program, YouCam displays a floating toolbar that lets you add graphic effects.
- Special effects—Add frames, filters, and emoticons to your snapshots and video.
- Snapshots—Take single frame or “burst” webcam shots in rapid succession.
- Connect—E-mail photos and video using the icon on the software interface.

---

 **NOTE:** For details about using webcam software, refer to the software manufacturer's instructions, which may be provided with the software, on disc, or on the manufacturer's Web site.

---

## Webcam tips

For optimum performance, observe the following guidelines while using the webcam:

- Be sure that you have the latest version of an instant message program before starting a video conversation.
- The webcam may not work properly across some network firewalls.

 **NOTE:** If you are having trouble viewing or sending multimedia files to someone on another LAN or outside your network firewall, temporarily disable the firewall, perform the task you want to perform, and then reenable the firewall. To permanently resolve the problem, reconfigure the firewall as necessary, and adjust the policies and settings of other intrusion detection systems. For additional information, contact your network administrator or IT department.

- Whenever possible, place bright light sources behind the camera and out of the picture area.

## Adjusting webcam properties

You can adjust webcam properties using the Properties dialog box, which is accessible from various programs that use the integrated camera, usually from a configuration, settings, or properties menu:

- **Brightness**—Controls the amount of light that is incorporated into the image. A higher brightness setting creates a brighter image; a lower brightness setting creates a darker image.
- **Contrast**—Controls the difference between lighter and darker areas on the image. A higher contrast setting intensifies the image; a lower contrast setting maintains more of the original information's dynamic range but leads to a flatter image.
- **Hue**—Controls the aspect of color that distinguishes it from another color (what makes a color red, green, or blue). Hue is distinct from saturation, which measures the intensity of the hue.
- **Saturation**—Controls the strength of color in the final image. A higher saturation setting creates a bolder image; a lower saturation setting creates a more subtle image.
- **Sharpness**—Controls the definition of edges in an image. A higher sharpness setting creates a more defined image; a lower sharpness setting creates a softer image.
- **Gamma**—Controls the contrast affecting the mid-level grays or midtones of an image. Adjusting the gamma of an image allows you to change the brightness values of the middle range of gray tones without dramatically altering the shadows and highlights. A lower gamma setting makes grays look black, and makes dark colors even darker.
- **Backlight Comp**—Compensates in cases where a subject with a large amount of background light would otherwise be obscured by blooming or silhouetting.

For information about using the webcam, select **Start > Help and Support**.

## 7 Troubleshooting

The following sections describe several common issues and resolutions.

### The optical disc tray does not open for removal of a CD or DVD

1. Insert the end of a paper clip (1) into the release access in the front bezel of the drive.
2. Press in gently on the paper clip until the disc tray is released, and then pull out the tray (2) until it stops.
3. Remove the disc (3) from the tray by gently pressing down on the spindle while lifting the outer edges of the disc. Hold the disc by the edges and avoid touching the flat surfaces.

 **NOTE:** If the tray is not fully accessible, tilt the disc carefully as you remove it.

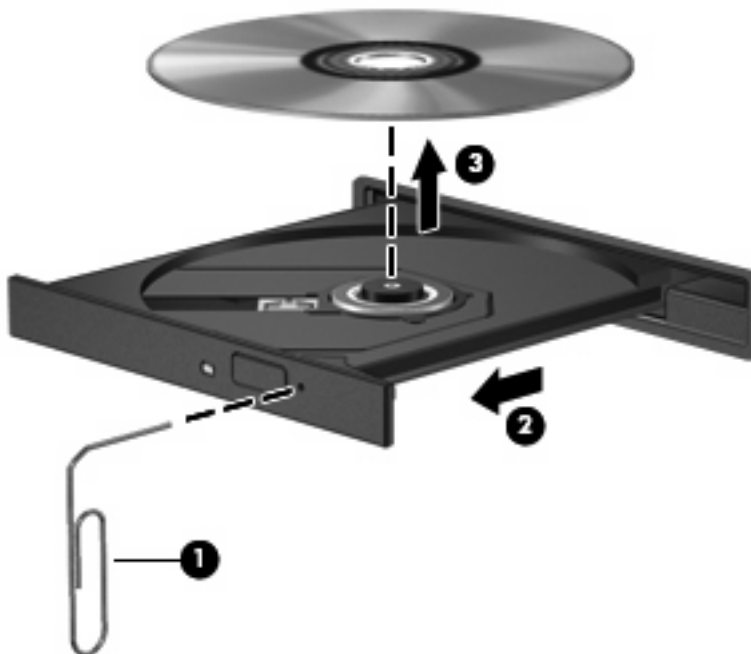

4. Close the disc tray and place the disc in a protective case.

## The computer does not detect the optical drive

If Windows does not detect an installed device, the device driver software may be missing or corrupted. If you suspect that the optical drive is not being detected, verify that the optical drive is listed in the Device Manager utility.

1. Remove any discs from the optical drive.
2. Click **Start > Control Panel > System and Security**. Then in the **System** area, click **Device Manager**.
3. In the Device Manager window, click the arrow next to DVD/CD-ROM drives to expand the list to show all of the installed drives.
4. Right-click the optical device listing to perform the following tasks:
  - Update driver software
  - Disable
  - Uninstall
  - Scan for hardware changes. Windows scans your system for installed hardware and installs any required drivers.
  - Click **Properties** to see if the device is working properly:
    - The Properties window provides details about the device to help you troubleshoot issues.
    - Click the **Driver** tab to update, disable, or uninstall drivers for this device.

## A disc does not play

- Save your work and close all open programs before playing a CD or a DVD.
- Log off the Internet before playing a CD or a DVD.
- Be sure that you insert the disc properly.
- Be sure that the disc is clean. If necessary, clean the disc with filtered water and a lint-free cloth. Wipe from the center of the disc to the outer edge.
- Check the disc for scratches. If you find scratches, treat the disc with an optical disc repair kit available at many electronics stores.
- Disable Sleep mode before playing the disc.

Do not initiate Hibernation or Sleep while playing a disc. Otherwise, you may see a warning message asking if you want to continue. If this message is displayed, click **No**. After you click No, the computer may behave in either of the following ways:

- Playback may resume.

– or –

- The playback window in the multimedia program may close. To return to playing the disc, click the **Play** button in your multimedia program to restart the disc. In rare cases, you may need to exit the program and then restart it.
- Increase system resources:
  - Turn off external devices such as printers and scanners. Disconnecting these devices frees up valuable system resources and results in better playback performance.
  - Change desktop color properties. Because the human eye cannot easily tell the difference between colors beyond 16 bits, you should not notice any loss of color while watching a movie if you lower system color properties to 16-bit color, as follows:
    1. Right-click on a blank area of the computer desktop, and select **Screen resolution**.
    2. Select **Advanced Settings > Monitor** tab.
    3. Select **High Color (16 bit)**, if this setting is not already selected.
    4. Click **OK**.

## A disc does not play automatically

1. Click **Start > Default Programs > Change AutoPlay Settings**.
2. Select the check box for **Use AutoPlay for all media and devices**.
3. Click **Save**.

A CD or DVD should now start automatically when it is inserted into the optical drive.

## A DVD movie stops, skips, or plays erratically

- Clean the disc.
- Conserve system resources by trying the following suggestions:
  - Log off the Internet.
  - Change the color properties of the desktop:
    1. Right-click on a blank area of the computer desktop, and select **Screen resolution**.
    2. Select **Advanced Settings > Monitor** tab.
    3. Select **High Color (16 bit)**, if this setting is not already selected.
    4. Click **OK**.
  - Disconnect external devices, such as a printer, scanner, camera, or handheld device.

## A DVD movie is not visible on an external display

1. If both the computer display and an external display are turned on, press **fn+f4** one or more times to switch between the 2 displays.
2. Configure the monitor settings to make the external display primary:
  - a. Right-click on a blank area of the computer desktop, and select **Screen resolution**.
  - b. Specify a primary display and a secondary display.

---

 **NOTE:** When using both displays, the DVD image will not appear on any display designated as the secondary display.

---

To get information about a multimedia question not covered in this guide, go to **Start > Help and Support**.

## The process of burning a disc does not begin, or it stops before completion

- Be sure that all other programs are closed.
- Turn off Sleep mode and Hibernation.
- Be sure that you are using the right kind of disc for your drive. See your user guides for more information about disc types.
- Be sure that the disc is inserted properly.
- Select a slower write speed and try again.
- If you are copying a disc, save the information on the source disc to your hard drive before trying to burn the contents to a new disc, and then burn from your hard drive.
- Reinstall the disc-burning device driver located in the DVD/CD-ROM drives category in Device Manager.

## A DVD playing in Windows Media Player produces no sound or display

Use DVD Play to play a DVD. DVD Play is installed on the computer, and is also available from the HP Web site at <http://www.hp.com>.

## A device driver must be reinstalled

1. Remove any discs from the optical drive.
2. Select **Start > Control Panel > System and Security**. Then in the **System** area, click **Device Manager**.
3. In the Device Manager window, click the arrow next to the type of driver you want to uninstall and then reinstall (for example, DVD/CD-ROMs, Modems, and so on).
4. Right-click the device listing and click **Uninstall**. When prompted, confirm that you want to delete the device, but do not restart the computer. Repeat for any other drivers you want to delete.
5. In the Device Manager window, click **Action**, and then click **Scan for hardware changes**. Windows scans your system for installed hardware and installs default drivers for any devices requiring drivers.

---

 **NOTE:** If you are prompted to restart the computer, save all open files, and then continue with the restart.

---

6. Reopen Device Manager, if necessary, and then verify that the drivers are once again listed.
7. Try running your program again.

If uninstalling and reinstalling the device drivers does not correct the problem, you may need to update your drivers using the procedures in the following sections.



## Obtaining the latest HP device drivers

1. Open your Internet browser, go to <http://www.hp.com/support>, and then click the **Software & Driver Downloads** link.
2. On the **Software & Driver downloads** page, select the task, type your computer model number as instructed, and then press **enter**.

– or –

If you want a specific SoftPaq, enter the SoftPaq number in the **Search** box, press **enter**, and follow the instructions provided. Proceed to step 6.

3. Click your specific product from the models listed.
4. Click the Windows 7 operating system.
5. When the list of drivers is displayed, click an updated driver to open a window containing additional information.
6. Click **Install now** to install the updated driver without downloading the file.

– or –

Click **Download only** to save the file to your computer. When prompted, click **Save** and then select a storage location on your hard drive.

After the file is downloaded, navigate to the folder where the file was stored, and double-click the file to install.

7. If prompted to do so, restart your computer after the installation is complete, and then verify the operation of the device.

## Obtaining the latest Windows device drivers

You can obtain the latest Windows device drivers by using Windows Update. This feature can be set to automatically check for and install updates for the Windows operating system and other Microsoft products.

To use Windows Update:

1. Click **Start > All Programs > Windows Update**.

 **NOTE:** If you have not previously set up Windows Update, you will be prompted to enter settings before you can check for updates.

---

2. Click **Check for updates**.
3. Follow the on-screen instructions.

---

# Index

- A**
  - audio devices, connecting
    - external 9
  - audio features 8
  - audio functions, checking 9
  - audio-in (microphone) jack 2
  - audio-out (headphone) jacks 2
- B**
  - Blu-ray disc 16
  - buttons
    - DVD 3
    - volume mute 4
- C**
  - CD
    - inserting 17
    - removing 21
  - CD drive 14
  - checking audio functions 9
- D**
  - device drivers
    - HP drivers 29
    - Windows drivers 29
  - drives, optical drive 14
  - DVD
    - changing region setting 19
    - inserting 17
    - removing 21
  - DVD button 3
  - DVD drive 14
  - DVD Play
    - starting 3, 7
    - using 7, 18
  - DVD Play software 7
  - DVD region settings 19
- E**
  - earbuds 2
- external audio devices,
  - connecting 9
- external monitor port 10
- H**
  - HDMI, connecting a device 11
  - headphone (audio-out) jacks 2
  - headphones 2
  - hotkeys
    - volume down 3
    - volume mute 3
    - volume up 3
- I**
  - internal microphone, identifying 2
  - issues, resolving 24
- J**
  - jacks
    - audio-in (microphone) 2
    - audio-out (headphone) 2
- M**
  - media activity hotkeys 6
  - microphone, internal 2
  - monitor, connecting 10
  - movie, watching 18
  - multimedia components,
    - identifying 2
  - multimedia software 7
  - multimedia software, installing 7
  - mute button 4
- O**
  - optical disc
    - Blu-ray 16
    - inserting 17
    - removing 21
  - optical discs, using 14
  - optical drive 14
  - optical drive, using 13
- P**
  - ports, external monitor 10
  - projector, connecting 10
- R**
  - region codes, DVD 19
- S**
  - speakers 2
- T**
  - tips, webcam 23
  - troubleshooting
    - disc burning 27
    - disc play 26
    - DVD movie play 27
    - external display 27
    - HP device drivers 29
    - optical disc tray 24
    - optical drive detection 25
    - Windows device drivers 29
- V**
  - video, using 10
  - volume down button 4
  - volume down hotkey 3
  - volume mute button 4
  - volume mute hotkey 3
  - volume up hotkey 3
  - volume, adjusting 4
- W**
  - webcam 2
  - webcam light 2
  - webcam properties, adjusting 23
  - webcam tips 23
  - webcam, using 22

