

HP Mini User Guide

© Copyright 2009 Hewlett-Packard
Development Company, L.P.

Bluetooth is a trademark owned by its proprietor and used by Hewlett-Packard Company under license. Microsoft and Windows are U.S. registered trademarks of Microsoft Corporation. SD Logo is a trademark of its proprietor.

The information contained herein is subject to change without notice. The only warranties for HP products and services are set forth in the express warranty statements accompanying such products and services. Nothing herein should be construed as constituting an additional warranty. HP shall not be liable for technical or editorial errors or omissions contained herein.

First Edition: July 2009

Document Part Number: 538073-001

Product notice

This user guide describes features that are common to most models. Some features may not be available on your computer.

Safety warning notice

-
- ⚠ **WARNING!** To reduce the possibility of heat-related injuries or of overheating the computer, do not place the computer directly on your lap or obstruct the computer air vents. Use the computer only on a hard, flat surface. Do not allow another hard surface, such as an adjoining optional printer, or a soft surface, such as pillows or rugs or clothing, to block airflow. Also, do not allow the AC adapter to contact the skin or a soft surface, such as pillows or rugs or clothing, during operation. The computer and the AC adapter comply with the user-accessible surface temperature limits defined by the International Standard for Safety of Information Technology Equipment (IEC 60950).
-

Table of contents

1 Features

Identifying the hardware	1
Top components	1
TouchPad	1
Lights	3
Buttons	4
Keys	5
Front components	5
Right-side components	6
Left-side components	7
Display components	8
Bottom components	8
Wireless antennas	9
Additional hardware components	10
Identifying the labels	10

2 Power management

Setting power options	12
Using power-saving states	12
Initiating and exiting Standby	12
Initiating and exiting Hibernation	13
Using the Power Meter	13
Using power schemes	14
Viewing the current scheme	14
Selecting a different power scheme	14
Customizing power schemes	15
Setting password protection upon exiting Standby	15
Using external AC power	15
Connecting the AC adapter	16
Using battery power	16
Displaying the remaining battery charge	17
Inserting or removing the battery	17
Charging a battery	18
Maximizing battery discharge time	19

Managing low battery levels	19
Identifying low battery levels	19
Resolving a low battery level	20
Resolving a low battery level when external power is available	20
Resolving a low battery level when a charged battery is available	20
Resolving a low battery level when no power source is available	20
Resolving a low battery level when the computer cannot exit Hibernation	20
Calibrating a battery	20
Step 1: Fully charge the battery	20
Step 2: Disable Hibernation and Standby	21
Step 3: Discharge the battery	21
Step 4: Fully recharge the battery	22
Step 5: Reenable Hibernation and Standby	22
Conserving battery power	22
Storing a battery	22
Disposing of a used battery	23
Replacing the battery	23
Testing an AC adapter	24
Shutting down the computer	24

3 Wireless

Using wireless devices (select models only)	25
Identifying wireless and network icons	25
Using the wireless controls	26
Using the wireless switch	26
Using operating system controls	26
Using a WLAN	27
Setting up a WLAN	27
Protecting your WLAN	27
Connecting to a WLAN	29
Roaming to another network	29
Using HP Mobile Broadband (select models only)	30
Inserting a SIM	30
Removing a SIM	31
Using Bluetooth wireless devices (select models only)	33
Bluetooth and Internet Connection Sharing (ICS)	33

4 Multimedia

Multimedia features	34
Identifying your multimedia components	34
Adjusting the volume	35

Multimedia software	36
Using preinstalled multimedia software	37
Installing multimedia software from a disc	37
Audio	38
Connecting external audio devices	38
Checking your audio functions	38
Video	40
Connecting an external monitor or projector	40
Optical drive (select models only)	41
Identifying the external optical drive	41
Using optical discs	41
Selecting the right disc	41
CD-R discs	42
CD-RW discs	42
DVD±R discs	42
DVD±RW discs	42
Playing music	42
Watching a movie	43
Changing DVD region settings	44
Creating or “burning” a CD or DVD	44
Removing an optical disc (CD or DVD)	45
Webcam	47
Adjusting webcam properties	47

5 Security

Protecting the computer	48
Using passwords	49
Setting passwords in Windows	49
Setting passwords in Computer Setup	49
Setup password	50
Managing a setup password	51
Entering a setup password	52
Power-on password	52
Managing a power-on password	53
Entering a power-on password	54
Requiring a power-on password at restart	55
Using Computer Setup DriveLock	55
Setting a DriveLock password	56
Entering a DriveLock password	57
Changing a DriveLock password	58
Removing DriveLock protection	59
Using Computer Setup security features	60
Securing system devices	60

Using Computer Setup stringent security	60
Setting stringent security	61
Removing stringent security	62
Viewing Computer Setup System Information	62
Using antivirus software	63
Using firewall software	64
Installing critical updates	65
Installing a security cable	66

6 External devices

Using a USB device	67
Connecting a USB device	67
Stopping and removing a USB device	67
Using USB legacy support	68
Using external drives	69
Using optional external devices	69
Using an optional external MultiBay II	69
Using an optional external optical drive (select models only)	70
Inserting an optical disc (CD or DVD)	70
Removing an optical disc (CD or DVD)	71
When the disc tray opens	71
When the disc tray does not open	72

7 External media cards

Using SD Card Reader cards	74
Inserting a digital card	74
Stopping and removing a digital card	75

8 Pointing devices and keyboard

Using pointing devices	76
Setting pointing device preferences	76
Using the TouchPad	76
Connecting an external mouse	76
Using the keyboard function keys	76
Switching the screen image (f2)	78
Decreasing screen brightness (f3)	78
Increasing screen brightness (f4)	78
Initiating Standby (f5)	78
Initiating QuickLock (f6)	78
Muting speaker sound (f8)	79
Decreasing speaker sound (f10)	79
Increasing speaker sound (f11)	79
Using keypads	79

Using the embedded numeric keypad	79
Enabling and disabling the embedded numeric keypad	80
Switching key functions on the embedded numeric keypad	80
Using an optional external numeric keypad	80
Cleaning the TouchPad and keyboard	81

9 Drives

Identifying installed drives	82
Handling drives	82
Improving hard drive performance	84
Using Disk Defragmenter	84
Using Disk Cleanup	84
Using HP 3D DriveGuard (select models only)	85
Identifying HP 3D DriveGuard status	85
Using HP 3D DriveGuard software	85
Replacing a hard drive	87

10 Memory modules

11 Computer Setup

Starting Computer Setup	94
Using Computer Setup	94
Navigating and selecting in Computer Setup	94
Restoring factory settings in Computer Setup	95
Computer Setup menus	95
File menu	95
Security menu	96
Diagnostics menu	96
System Configuration menu	97

12 Backing up and recovering

Backing up	100
Recovering	101

Index	102
--------------------	------------

1 Features

Identifying the hardware

Components included with the computer may vary by region and model. The illustrations in this chapter identify the standard features on most computer models.

To see a list of hardware installed in the computer, follow these steps:

1. Select **Start > My Computer**.
2. In the left pane of the System Tasks window, select **View system information**.
3. Select **Hardware** tab > **Device Manager**.

You can also add hardware or modify device configurations using Device Manager.

Top components

TouchPad

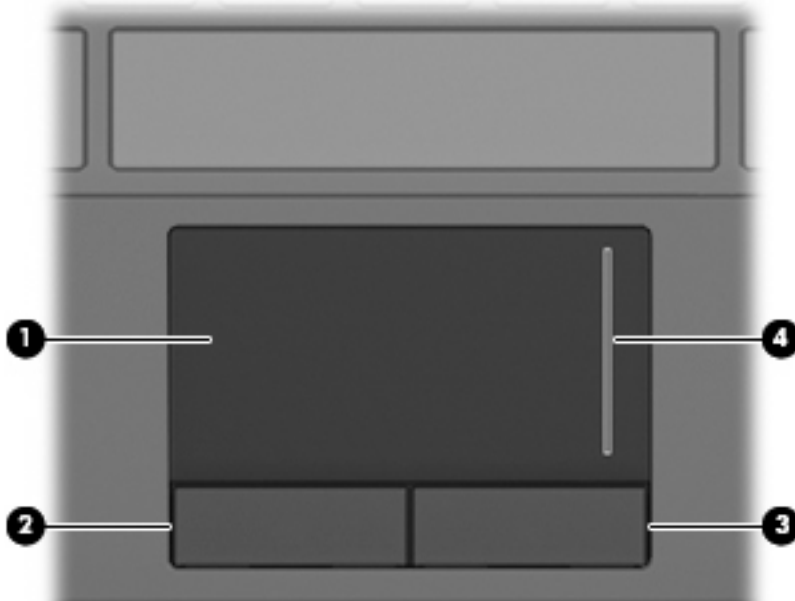

Component	Description
(1) TouchPad*	Moves the pointer and selects or activates items on the screen.

Component	Description
(2) Left TouchPad button*	Functions like the left button on an external mouse.
(3) Right TouchPad button*	Functions like the right button on an external mouse.
(4) TouchPad scroll zone	Scrolls up or down.

*This table describes factory settings. To view or change pointing device preferences, select **Start > Control Panel > Printers and Other Hardware > Mouse**.

Lights

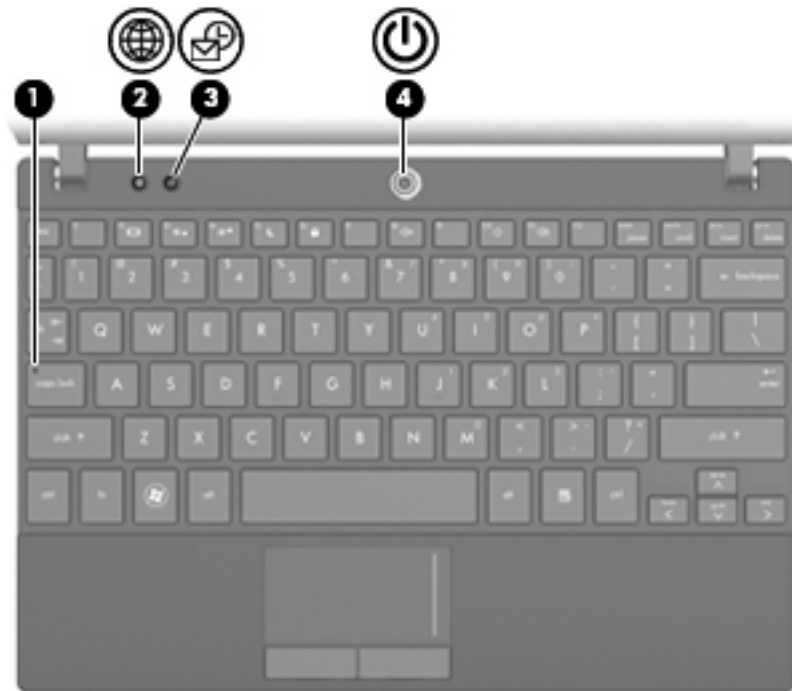

Component	Description
(1) Caps lock light	On: Caps lock is on.
(2) Quick Launch Web light	On: The default Internet browser is being launched.
(3) Quick Launch Mail light	On: The default mail application is being launched.
(4) Power light	<ul style="list-style-type: none">On: The computer is on.Blinking: The computer is in the Standby state.Off: The computer is off or in Hibernation.

Buttons

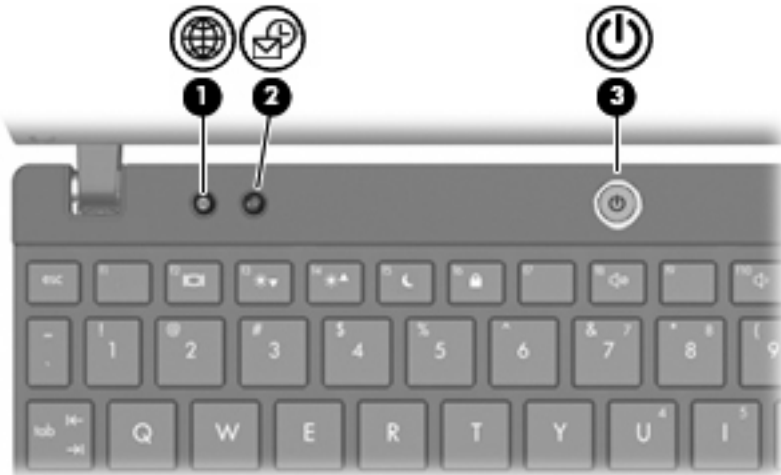

Component	Description
(1) Quick Launch Web button	Opens the default Internet browser when the computer is on.
(2) Quick Launch Mail button	Opens the default mail application when the computer is on.
(3) Power button	<ul style="list-style-type: none">• When the computer is off, press the button to turn on the computer.• When the computer is on, press the button to shut down the computer.• When the computer is in the Standby state, press the button briefly to exit Standby.• When the computer is in Hibernation, press the button briefly to exit Hibernation. <p>If the computer has stopped responding and Windows shutdown procedures are ineffective, press and hold the power button for at least 5 seconds to turn off the computer.</p> <p>To learn more about your power settings, select Start > Control Panel > Performance and Maintenance > Power Options.</p>

Keys

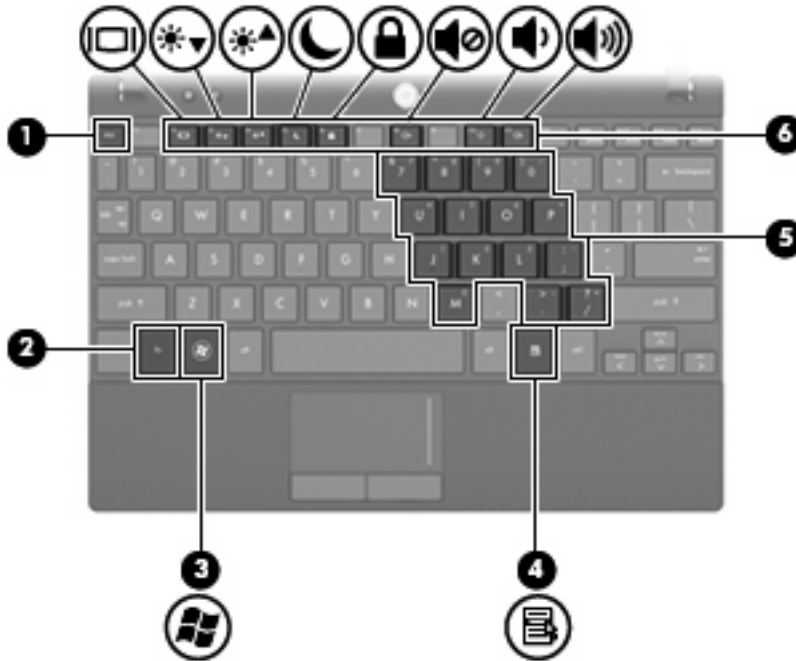

Component	Description
(1) <code>esc</code> key	Displays system information when pressed in combination with the <code>fn</code> key.
(2) <code>fn</code> key	Displays system information when pressed in combination with the <code>esc</code> key.
(3) Windows logo key	Displays the Windows Start menu.
(4) Windows applications key	Displays a shortcut menu for items beneath the pointer.
(5) Embedded numeric keypad keys	Can be used like the keys on an external numeric keypad.
(6) Function keys	Execute the action represented by the icon on the key.

Front components



Component	Description
(1) Drive light	Blinking: The hard drive is being accessed.

Component	Description
(2) Wireless light	<ul style="list-style-type: none"> Blue: An integrated wireless device, such as a wireless local area network (WLAN) device and/or a Bluetooth® device, is on. Amber: All wireless devices are off. <p>NOTE: The wireless light turns amber when the computer turns on and all wireless devices are off.</p>
(3) Wireless switch	<p>Turns the wireless feature on or off, but does not create a wireless connection.</p> <p>NOTE: To establish a wireless connection, a wireless network must already be set up.</p>
(4) Speakers (2)	Produce sound.

Right-side components

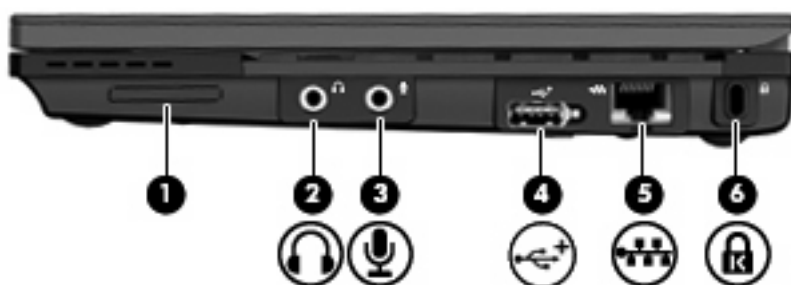

Component	Description
(1) SD Card Reader	<p>Supports the following optional digital card formats:</p> <ul style="list-style-type: none"> MultiMediaCard (MMC) Secure Digital (SD) Memory Card
(2) Audio-out (headphone) jack	<p>Produces sound when connected to optional powered stereo speakers, headphones, ear buds, a headset, or television audio.</p> <p>NOTE: When a device is connected to the headphone jack, the computer speakers are disabled.</p>
(3) Audio-in (microphone) jack	Connects an optional computer headset microphone, stereo array microphone, or monaural microphone.
(4) Powered USB port	Provides power to a USB device, such as an optional external optical drive, if used with a powered USB cable.
(5) RJ-45 (network) jack	Connects a network cable.
(6) Security cable slot	<p>Attaches an optional security cable to the computer.</p> <p>NOTE: The security cable is designed to act as a deterrent, but it may not prevent the computer from being mishandled or stolen.</p>

Left-side components

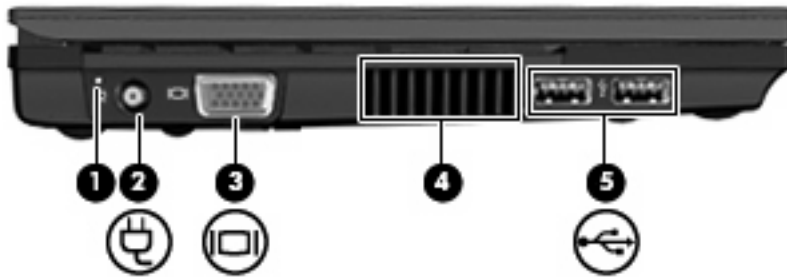

Component	Description
(1) Battery light	<ul style="list-style-type: none">• Amber: A battery is charging.• Blue: A battery is close to full charge capacity.• Blinking amber: A battery that is the only available power source has reached a low battery level. When the battery reaches a critical battery level, the battery light begins blinking rapidly.• Off: If the computer is plugged into an external power source, the light turns off when all batteries in the computer are fully charged. If the computer is not plugged into an external power source, the light stays off until the battery reaches a low battery level.
(2) Power connector	Connects an AC adapter.
(3) External monitor port	Connects an external VGA monitor or projector.
(4) Vent	Enables airflow to cool internal components. NOTE: The computer fan starts up automatically to cool internal components and prevent overheating. It is normal for the internal fan to cycle on and off during routine operation.
(5) USB ports (2)	Connect optional USB devices.

Display components



Component	Description
(1) Webcam light	On: The webcam is in use.
(2) Webcam	Records audio and video and captures still photographs.
(3) Internal microphones (2)	Record sound. NOTE: If there is a microphone icon next to each microphone opening, your computer has internal microphones.
(4) Speakers (2)	Produce sound.

Bottom components

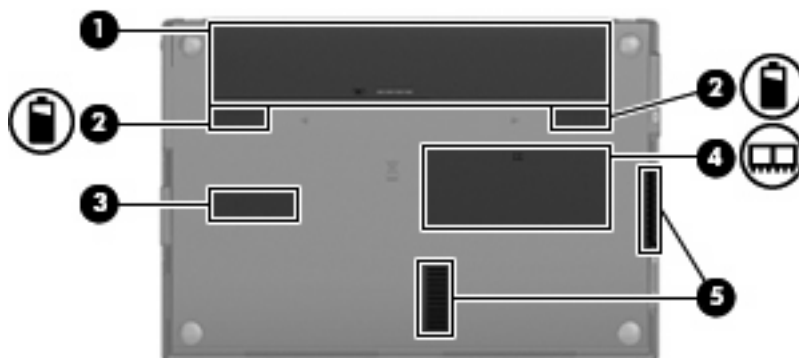

Component	Description
(1) Battery bay	Holds the battery.
(2) Battery release latches (2)	Release the battery from the battery bay.
(3) Service tag	Provides the product brand and series name, serial number (s/n), and product number (p/n) of your computer. Have this information available when you contact technical support.
(4) Memory module compartment	Contains the memory module slot.
(5) Vents (2)	Enable airflow to cool internal components.

NOTE: The computer fan starts up automatically to cool internal components and prevent overheating. It is normal for the internal fan to cycle on and off during routine operation.

Wireless antennas

On select computer models, at least 2 antennas send and receive signals from one or more wireless devices. These antennas are not visible from the outside of the computer.



NOTE: For optimal transmission, keep the areas immediately around the WLAN and WWAN antennas free from obstructions.

To see wireless regulatory notices, refer to the section of the *Regulatory, Safety and Environmental Notices* that applies to your country or region. These notices are located in Help and Support.

Additional hardware components



Component	Description
(1) Power cord*	Connects an AC adapter to an AC outlet.
(2) AC adapter	Converts AC power to DC power.
(3) Battery*	Powers the computer when the computer is not plugged into external power.

*Batteries and power cords vary in appearance by region and country.

Identifying the labels

The labels affixed to the computer provide information you may need when you troubleshoot system problems or travel internationally with the computer.

- Service tag—Provides important information including:



- Product Name **(1)**. This is the product name affixed to the front of your computer.
- Serial Number (s/n) **(2)**. This is an alphanumeric identifier that is unique to each product.
- Part Number/Product Number (p/n) **(3)**. This number provides specific information about the product's hardware components. The part number helps a service technician to determine what components and parts are needed.
- Model Description **(4)**. This is the alphanumeric identifier you need to locate documents, drivers, and support for your computer.
- Warranty period **(5)**. This number describes the duration (in years) of the warranty period for this computer.

Have this information available when you contact technical support. The service tag label is affixed to the bottom of the computer.

- Microsoft® Certificate of Authenticity—Contains the Windows Product Key. You may need the Product Key to update or troubleshoot the operating system. This certificate is affixed to the bottom of the computer.
- Regulatory label—Provides regulatory information about the computer. The regulatory label is affixed to the bottom of the computer.
- Wireless certification label(s) (select models only)—Provide information about optional wireless devices and the approval markings of some of the countries or regions in which the devices have been approved for use. An optional device may be a wireless local area network (WLAN) device or an optional Bluetooth® device. If your computer model includes one or more wireless devices, one or more certification labels are included with your computer. You may need this information when traveling internationally. Wireless certification labels are affixed inside the battery bay.

2 Power management

Setting power options

Using power-saving states

The computer has two power-saving states enabled at the factory: Standby and Hibernation.

When Standby is initiated, the power lights blink and the screen clears. Your work is saved to memory. Exiting Standby is faster than exiting Hibernation. If the computer is in Standby for an extended period or if the battery reaches a critical battery level while in Standby, the computer initiates Hibernation.

When Hibernation is initiated, your work is saved to a hibernation file on the hard drive and the computer turns off.

△ **CAUTION:** To prevent possible audio and video degradation, loss of audio or video playback functionality, or loss of information, do not initiate Standby or Hibernation while reading from or writing to a disc or an external media card.

📄 **NOTE:** You cannot initiate any type of networking connection or perform any computer functions while the computer is in Standby or in Hibernation.

NOTE: When HP 3D DriveGuard has parked a drive, the computer will not initiate Standby or Hibernation, and the display will be turned off.

Initiating and exiting Standby

The system is set at the factory to initiate Standby after 10 minutes of inactivity when running on battery power and 25 minutes of inactivity when running on external power.

Power settings and timeouts can be changed using Power Options in Windows® Control Panel.

With the computer on, you can initiate Standby in any of the following ways:

- Press **f5**.
- Click **Start > Turn Off Computer > Stand By**.

If Stand by is not displayed, follow these steps:

- a. Click the down arrow.
- b. Select **Stand by** from the list.
- c. Click **OK**.

To exit Standby:

- ▲ Briefly press the power button.

When the computer exits Standby, the power lights turn on and your work returns to the screen where you stopped working.

 **NOTE:** If you have set a password to be required when the computer exits Standby, you must enter your Windows password before your work will return to the screen.

Initiating and exiting Hibernation

The system is set at the factory to initiate Hibernation after 30 minutes of inactivity when running on battery power or when the battery reaches a critical battery level.

 **NOTE:** The system will not initiate Hibernation when running on external power.

Power settings and timeouts can be changed using Power Options in Windows Control Panel.

To initiate Hibernation:

1. Select **Start > Turn Off Computer**.
2. Hold down the **shift** key and select **Hibernate**.

If Hibernate is not displayed, follow these steps:

- a. Click the down arrow.
- b. Select **Hibernate** from the list.
- c. Click **OK**.

To exit Hibernation:

- ▲ Briefly press the power button.

The power lights turn on and your work returns to the screen where you stopped working.

 **NOTE:** If you have set a password to be required when the computer exits Hibernation, you must enter your Windows password before your work will return to the screen.

Using the Power Meter

The Power Meter is located in the notification area, at the far right of the taskbar. The Power Meter allows you to quickly access power settings and view the remaining battery charge.

- To access Power Options, right-click the **Power Meter** icon and select **Adjust Power Properties**.
- To display the percentage of remaining battery charge, double-click the **Power Meter** icon.

Different battery meter icons indicate whether the computer is running on battery or external power.

To remove the Power Meter icon from the notification area, follow these steps:

1. Right-click the **Power Meter** icon in the notification area, and then click **Adjust Power Properties**.
2. Click the **Advanced** tab.

3. Clear the **Always show icon on the taskbar** check box.
4. Click **Apply**, and then click **OK**.

To show the Power Meter icon in the notification area, follow these steps:

1. Select **Start > Control Panel > Performance and Maintenance > Power Options**.
2. Click the **Advanced** tab.
3. Select the **Always show icon on the taskbar** check box.
4. Click **Apply**, and then click **OK**.

 **NOTE:** If you cannot see an icon you have placed in the notification area, click the **Show Hidden Icons** icon (< or <<) in the notification area.

Using power schemes

A power scheme is a collection of system settings that manages how the computer uses power. Power schemes can help you conserve power and maximize computer performance.

The following power schemes are available:

- Portable/Laptop (recommended)
- Home/Office Desk
- Presentation
- Always On
- Minimal Power Management
- Max Battery

You can change the settings of these power plans through Power Options.

Viewing the current scheme

- ▲ Click the **Power Meter** icon in the notification area, at the far right of the taskbar.

– or –

Select **Start > Control Panel > Performance and Maintenance > Power Options**.

Selecting a different power scheme

- ▲ Click the **Power Meter** icon in the notification area, at the far right of the taskbar, and then select a power scheme from the list.

– or –

- a. Select **Start > Control Panel > Performance and Maintenance > Power Options**.
- b. Select a power scheme from the **Power schemes** list.
- c. Click **OK**.

Customizing power schemes

1. Select **Start > Control Panel > Performance and Maintenance > Power Options**.
2. Select a power scheme from the **Power schemes** list.
3. Modify the **Plugged in** and **Running on batteries settings** as needed.
4. Click **OK**.

Setting password protection upon exiting Standby

To set the computer to prompt for a password when the computer exits Standby, follow these steps:

1. Right-click the **Power Meter** icon in the notification area, and then click **Adjust Power Properties**.
2. Click the **Advanced** tab.
3. Select the **Prompt for password when computer resumes from standby** check box.
4. Click **Apply**.

Using external AC power

External AC power is supplied through one of the following devices:

-
- ⚠ **WARNING!** To reduce potential safety issues, use only the AC adapter provided with the computer, a replacement AC adapter provided by HP, or a compatible AC adapter purchased from HP.
- Approved AC adapter
 - Optional docking device or optional expansion product

Connect the computer to external AC power under any of the following conditions:

-
- ⚠ **WARNING!** Do not charge the computer battery while you are onboard aircraft.
- When you are charging or calibrating a battery
 - When you are installing or modifying system software
 - When you are writing information to a CD or DVD

When you connect the computer to external AC power, the following events occur:

- The battery begins to charge.
- If the computer is turned on, the battery meter icon in the notification area changes appearance.

When you disconnect external AC power, the following events occur:

- The computer switches to battery power.
- The display brightness is automatically decreased to save battery life. To increase display brightness, press the **f4** key or reconnect the AC adapter.

Connecting the AC adapter

⚠ WARNING! To reduce the risk of electric shock or damage to the equipment:

Plug the power cord into an AC outlet that is easily accessible at all times.

Disconnect power from the computer by unplugging the power cord from the AC outlet (not by unplugging the power cord from the computer).

If provided with a 3-pin attachment plug on the power cord, plug the cord into a grounded (earthed) 3-pin outlet. Do not disable the power cord grounding pin, for example, by attaching a 2-pin adapter. The grounding pin is an important safety feature.

To connect the computer to external AC power, follow these steps:

1. Plug the AC adapter into the power connector **(1)** on the computer.
2. Plug the power cord into the AC adapter **(2)**.
3. Plug the other end of the power cord into an AC outlet **(3)**.



Using battery power

When a charged battery is in the computer and the computer is not plugged into external power, the computer runs on battery power. When the computer is plugged into external AC power, the computer runs on AC power.

If the computer contains a charged battery and is running on external AC power supplied through the AC adapter, the computer switches to battery power if the AC adapter is disconnected from the computer.

📖 NOTE: The display brightness is decreased to save battery life when you disconnect AC power. To increase display brightness, use the **f4** key or reconnect the AC adapter.

You can keep a battery in the computer or in storage, depending on how you work. Keeping the battery in the computer whenever the computer is plugged into AC power charges the battery and also protects your work in case of a power outage. However, a battery in the computer slowly discharges when the computer is off and unplugged from external power.

⚠ WARNING! To reduce potential safety issues, use only the battery provided with the computer, a replacement battery provided by HP, or a compatible battery purchased from HP.

Computer battery life varies, depending on power management settings, programs running on the computer, display brightness, external devices connected to the computer, and other factors.

Displaying the remaining battery charge

▲ Double-click the **Power Meter** icon in the notification area, at the far right of the taskbar.

– or –

Select **Start > Control Panel > Performance and Maintenance > Power Options > Power Meter** tab.

Most charge indicators report battery status as both a percentage and as the number of minutes of charge remaining:

- The percentage indicates the approximate amount of charge remaining in the battery.
- The time indicates the approximate running time remaining on the battery *if the battery continues to provide power at the current level*. For example, the time remaining will decrease when a DVD is playing and will increase when a DVD stops playing.

When a battery is charging, a lightning bolt icon may be superimposed over the battery icon on the Power Meter screen.

Inserting or removing the battery

△ **CAUTION:** Removing a battery that is the sole power source can cause loss of information. To prevent loss of information, initiate Hibernation or shut down the computer through Windows before removing the battery.

To insert the battery:

1. Turn the computer upside down on a flat surface, with the battery bay toward you.
2. Insert the battery into the battery bay (1) and push in until it is seated.

The battery release latches (2) automatically lock the battery into place.

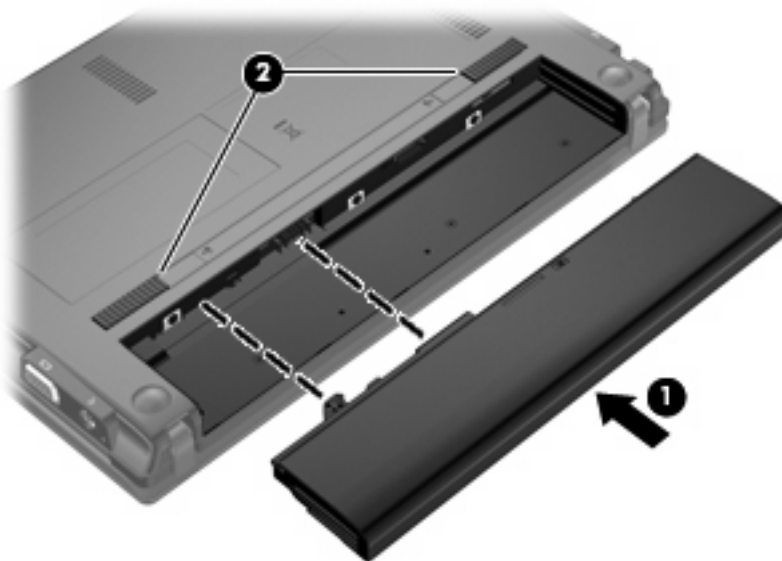

To remove the battery:

1. Turn the computer upside down on a flat surface, with the battery bay toward you.
2. Slide the battery release latches (1) to release the battery.
3. Remove the battery (2) from the computer.

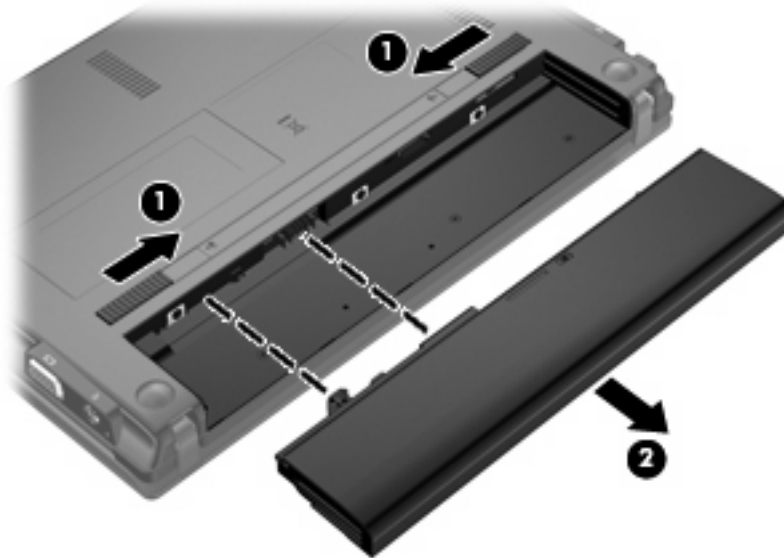

Charging a battery

⚠ WARNING! Do not charge the computer battery while you are onboard aircraft.

The battery charges whenever the computer is plugged into external power through an AC adapter, an optional power adapter, an optional expansion product, or an optional docking device.

The battery charges whether the computer is off or in use, but it charges faster when the computer is off.

Charging may take longer if a battery is new, has been unused for 2 weeks or more, or is much warmer or cooler than room temperature.

To prolong battery life and optimize the accuracy of battery charge displays, follow these recommendations:

- If you are charging a new battery, charge it fully before turning on the computer.
- Charge the battery until the battery light turns off.

📝 NOTE: If the computer is on while the battery is charging, the battery meter in the notification area may show 100 percent charge before the battery is fully charged.

- Allow the battery to discharge below 5 percent of a full charge through normal use before charging it.
- If the battery has been unused for one month or more, calibrate the battery instead of simply charging it.

The battery light displays charge status:

- On: The battery is charging.
- Blinking: The battery has reached a low battery level or critical battery level and is not charging.
- Off: The battery is fully charged, in use, or not installed.

Maximizing battery discharge time

Battery discharge time varies, depending on the features you use while on battery power. Maximum discharge time gradually shortens as the battery storage capacity naturally degrades.

Tips for maximizing battery discharge time:

- Lower the brightness on the display.
- Remove the battery from the computer when it is not being used or charged.
- Store the battery in a cool, dry location.

Managing low battery levels

The information in this section describes the alerts and system responses set at the factory. Some low-battery alerts and system responses can be changed using Power Options in Windows Control Panel. Preferences set using Power Options do not affect lights.

Identifying low battery levels

When a battery that is the sole power source for the computer reaches a low battery level, the battery light blinks.

If a low battery level is not resolved, the computer enters a critical battery level, and the battery light blinks rapidly.

The computer takes the following actions for a critical battery level:

- If Hibernation is enabled and the computer is on or in Standby, the computer initiates Hibernation.
- If Hibernation is disabled and the computer is on or in Standby, the computer remains briefly in Standby, and then shuts down and loses any unsaved information.

Resolving a low battery level

△ **CAUTION:** To reduce the risk of losing information when the computer reaches a critical battery level and has initiated Hibernation, do not restore power until the power lights turn off.

Resolving a low battery level when external power is available

- ▲ Connect one of the following devices:
 - AC adapter
 - Optional expansion product or docking device
 - Optional power adapter

Resolving a low battery level when a charged battery is available

1. Turn off the computer or initiate Hibernation.
2. Remove the discharged battery, and then insert a charged battery.
3. Turn on the computer.

Resolving a low battery level when no power source is available

- ▲ Initiate Hibernation.
 - or –
 - Save your work and shut down the computer.

Resolving a low battery level when the computer cannot exit Hibernation

When the computer lacks sufficient power to exit Hibernation, follow these steps:

1. Insert a charged battery or plug the computer into external power.
2. Exit Hibernation by briefly pressing the power button.

Calibrating a battery

Calibrate a battery under the following conditions:

- When battery charge displays seem inaccurate
- When you observe a significant change in battery run time

Even if a battery is heavily used, it should not need to be calibrated more than once a month. It is also not necessary to calibrate a new battery.

Step 1: Fully charge the battery

⚠ **WARNING!** Do not charge the computer battery while you are onboard aircraft.

📝 **NOTE:** The battery charges whether the computer is off or in use, but it charges faster when the computer is off.

To fully charge the battery:

1. Insert the battery into the computer.
2. Connect the computer to an AC adapter, optional power adapter, optional expansion product, or optional docking device, and then plug the adapter or device into external power.

The battery light on the computer turns on.

3. Leave the computer plugged into external power until the battery is fully charged.

The battery light on the computer turns off.

Step 2: Disable Hibernation and Standby

1. Right-click the **Power Meter** icon in the notification area, at the far right of the taskbar, and then click **Adjust Power Properties**.

– or –

Select **Start > Control Panel > Performance and Maintenance > Power Options**.

2. Record the 4 settings listed in the **Running on batteries** and **Plugged in** columns so that you can reset them after the calibration.
3. Set the 4 options to **Never**.
4. Click **OK**.

Step 3: Discharge the battery

The computer must remain on while the battery is being discharged. The battery can discharge whether or not you are using the computer, but the battery will discharge faster while you are using it.

- If you plan to leave the computer unattended during the discharge, save your information before beginning the discharge procedure.
- If you use the computer occasionally during the discharge procedure and have set energy-saving timeouts, expect the following performance from the system during the discharge process:
 - The monitor will not turn off automatically.
 - Hard drive speed will not decrease automatically when the computer is idle.
 - System-initiated Hibernation will not occur.

To discharge a battery:

1. Unplug the computer from its external power source, but do *not* turn off the computer.
2. Run the computer on battery power until the battery is discharged. The battery light begins to blink when the battery has discharged to a low battery level. When the battery is discharged, the battery light turns off and the computer shuts down.

Step 4: Fully recharge the battery

To recharge the battery:

1. Plug the computer into external power and maintain external power until the battery is fully recharged. When the battery is recharged, the battery light on the computer turns off.

You can use the computer while the battery is recharging, but the battery will charge faster if the computer is off.

2. If the computer is off, turn it on when the battery is fully charged and the battery light has turned off.

Step 5: Reenable Hibernation and Standby

△ **CAUTION:** Failure to reenable Hibernation after calibration may result in a full battery discharge and information loss if the computer reaches a critical battery level.

1. Select **Start > Control Panel > Performance and Maintenance > Power Options**.
2. Reenter the settings that you recorded for the items in the **Plugged in** column and the **Running on batteries** column.
3. Click **OK**.

Conserving battery power

- Select low power-use settings through Power Options in Windows Control Panel.
- Turn off wireless and local area network (LAN) connections and exit modem applications when you are not using them.
- Disconnect external devices that are not plugged into an external power source, when you are not using them.
- Stop, disable, or remove any external media cards that you are not using.
- Use the **f3** and **f4** keys to adjust screen brightness as needed.
- If you leave your work, initiate Standby or Hibernation, or shut down the computer.

Storing a battery

△ **CAUTION:** To prevent damage to a battery, do not expose it to high temperatures for extended periods of time.

If a computer will be unused and unplugged from external power for more than 2 weeks, remove the battery and store it separately.

To prolong the charge of a stored battery, place it in a cool, dry place.

 **NOTE:** A stored battery should be checked every 6 months. If the capacity is less than 50 percent, recharge the battery before returning it to storage.

Calibrate a battery before using it if it has been stored for one month or more.

Disposing of a used battery

 **WARNING!** To reduce the risk of fire or burns, do not disassemble, crush, or puncture; do not short external contacts; do not dispose of in fire or water.

Refer to the *Regulatory, Safety and Environmental Notices* for battery disposal information.

Replacing the battery

Computer battery life varies, depending on the power management settings, programs running on the computer, display brightness, external devices connected to the computer, and other factors.

 **NOTE:** To ensure that you always have battery power when you need it, HP recommends purchasing a new battery when the storage capacity indicator turns green-yellow.

Testing an AC adapter

Test the AC adapter if the computer exhibits any of the following symptoms:

- The computer will not turn on when connected to the AC adapter.
- The display does not turn on when the computer is connected to the AC adapter.
- The power light is off when the computer is connected to the AC adapter.

To test the AC adapter:

1. Remove the battery from the computer.
2. Connect the AC adapter.
3. Turn on the computer.
 - If the power light turns **on**, the AC adapter is functioning properly.
 - If the power light remains **off**, the AC adapter is not functioning and should be replaced.

Contact technical support for information on obtaining a replacement AC power adapter by selecting **Start > Help and Support**.

Shutting down the computer

△ **CAUTION:** Unsaved information will be lost when the computer is shut down.

The Shut Down command closes all open programs, including the operating system, and then turns off the display and computer.

Shut down the computer under any of the following conditions:

- When you need to replace the battery or access components inside the computer
- When you are connecting an external hardware device that does not connect to a USB port
- When the computer will be unused and disconnected from external power for an extended period

To shut down the computer, follow these steps:

📝 **NOTE:** If the computer is in Standby or in Hibernation, you must first exit Standby or Hibernation before shutdown is possible.

1. Save your work and close all open programs.
2. Select **Start > Turn Off Computer > Turn Off**.

If the computer is unresponsive and you are unable to use the preceding shutdown procedures, try the following emergency procedures in the sequence provided:

- Press **ctrl+alt+delete**. Then, select **Shut Down > Turn Off**.
- Press and hold the power button for at least 5 seconds.
- Disconnect the computer from external power and remove the battery.

3 Wireless

Using wireless devices (select models only)

Wireless technology transfers data across radio waves instead of wires. Your computer may be equipped with one or more of the following wireless devices:

- **Wireless local area network (WLAN) device**—Connects the computer to wireless local area networks (commonly referred to as Wi-Fi networks, wireless LANs, or WLANs) in corporate offices, your home, and public places such as airports, restaurants, coffee shops, hotels, and universities. In a WLAN, each mobile wireless device communicates with a wireless router or a wireless access point.
- **Bluetooth® device**—Creates a personal area network (PAN) to connect to other Bluetooth-enabled devices such as computers, phones, printers, headsets, speakers, and cameras. In a PAN, each device communicates directly with other devices, and devices must be relatively close together—typically within 10 meters (approximately 33 feet) of each other.

Computers with WLAN devices support one or more of the following IEEE industry standards:

- 802.11b, the first popular standard, supports data rates of up to 11 Mbps and operates at a frequency of 2.4 GHz.
- 802.11g supports data rates of up to 54 Mbps and operates at a frequency of 2.4 GHz. An 802.11g WLAN device is backward compatible with 802.11b devices, so they can operate on the same network.
- 802.11a supports data rates of up to 54 Mbps and operates at a frequency of 5 GHz.

 **NOTE:** 802.11a is not compatible with 802.11b and 802.11g.





- Wi-Fi CERTIFIED 802.11n draft 2.0 supports data rates of up to 300 Mbps and may operate at 2.4 GHz or 5 GHz, making it backward compatible with 802.11a, b, and g.

 **NOTE:** The specifications for the 802.11n WLAN are draft specifications and are not final. If the final specifications differ from the draft specifications, it may affect the ability of the computer to communicate with other 802.11n WLAN devices.

For more information on wireless technology, refer to the information and Web site links provided in Help and Support.

Identifying wireless and network icons

Icon	Name	Description
------	------	-------------

	Wireless (connected)	Identifies the location of the wireless lights and the wireless switch on the computer.
	Wireless (disconnected)	Indicates that all of the wireless devices are off.
	Network status (connected)	Indicates that one or more of your network drivers are installed and one or more network devices are connected to the network.
	Network status (disconnected)	Indicates that one or more of your network drivers are installed but no network devices are connected to the network.

Using the wireless controls

You can control the wireless devices in your computer using these features:

- Wireless switch
- Operating system controls

Using the wireless switch

The computer has a wireless switch, one or more wireless devices, and one or two wireless lights, depending on the model. All of the wireless devices on your computer are enabled at the factory, so the wireless light is on (blue) when you turn on the computer.

The wireless light indicates the overall power state of your wireless devices, not the status of individual devices. If the wireless light is blue, at least one wireless device is on. If the wireless light is amber, all wireless devices are off.

Because the wireless devices are enabled at the factory, you can use the wireless switch to turn on or turn off the wireless devices simultaneously. Individual wireless devices can be controlled through Computer Setup.

 **NOTE:** If the wireless devices are disabled by Computer Setup, the wireless switch will not work until you reenables your devices.

Using operating system controls

Some operating systems also offer a way to manage integrated wireless devices and the wireless connection. For more information, refer to the operating system documentation.

Using a WLAN

With a WLAN device, you can access a wireless local area network (WLAN), which is composed of other computers and accessories that are linked by a wireless router or a wireless access point.

 **NOTE:** The terms *wireless router* and *wireless access point* are often used interchangeably.

- A large-scale WLAN, such as a corporate or public WLAN, typically uses wireless access points that can accommodate a large number of computers and accessories and can separate critical network functions.
- A home or small office WLAN typically uses a wireless router, which allows several wireless and wired computers to share an Internet connection, a printer, and files without requiring additional pieces of hardware or software.

To use the WLAN device in your computer, you must connect to a WLAN infrastructure (provided through a service provider or a public or corporate network).

Setting up a WLAN

To set up a WLAN and connect to the Internet, you need the following equipment:

- A broadband modem (either DSL or cable) **(1)** and high-speed Internet service purchased from an Internet service provider (ISP)
- A wireless router (purchased separately) **(2)**
- The wireless computer **(3)**

The illustration below shows an example of a wireless network installation that is connected to the Internet.



As your network grows, additional wireless and wired computers can be connected to the network to access the Internet.

For help in setting up your WLAN, refer to the information provided by your router manufacturer or your ISP.

Protecting your WLAN

Because the WLAN standard was designed with only limited security capabilities—basically to foil casual eavesdropping rather than more powerful forms of attack—it is essential to understand that WLANs are vulnerable to well-known and well-documented security weaknesses.

WLANs in public areas, or “hotspots,” like coffee shops and airports may not provide any security. New technologies are being developed by wireless manufacturers and hotspot service providers that make the public environment more secure and anonymous. If you are concerned about the security of your computer in a hotspot, limit your network activities to noncritical e-mail and basic Internet surfing.

When you set up a WLAN or access an existing WLAN, always enable security features to protect your network from unauthorized access. The common security levels are Wi-Fi Protected Access (WPA) and Wired Equivalent Privacy (WEP). Because wireless radio signals travel outside the network, other WLAN devices can pick up unprotected signals and either connect to your network (uninvited) or capture information being sent across it. However, you can take precautions to protect your WLAN:

- **Use a wireless transmitter with built-in security**

Many wireless base stations, gateways, and routers provide built-in security features such as wireless security protocols and firewalls. With the correct wireless transmitter, you can protect your network from the most common wireless security risks.

- **Work behind a firewall**

A firewall is a barrier that checks both data and requests for data that are sent to your network and then discards any suspicious items. Firewalls are available in many varieties, both software and hardware. Some networks use a combination of both types.

- **Use wireless encryption**

A variety of sophisticated encryption protocols is available for your WLAN. Find the solution that works best for your network security:

- **Wired Equivalent Privacy (WEP)** is a wireless security protocol that uses a WEP key to encode or encrypt all network data before it is transmitted. Usually, you can allow the network to assign the WEP key. Alternatively, you can set up your own key, generate a different key, or choose other advanced options. Without the correct key, others will not be able to use the WLAN.
- **WPA (Wi-Fi Protected Access)**, like WEP, uses security settings to encrypt and decrypt data that is transmitted over the network. However, instead of using one static security key for encryptions as WEP does, WPA uses *temporal key integrity protocol* (TKIP) to dynamically generate a new key for every packet. It also generates different sets of keys for each computer on the network.

- **Close your network**

If possible, prevent your network name (SSID) from being broadcast by the wireless transmitter. Most networks initially broadcast the name, telling any computer nearby that your network is available. By closing the network, other computers are less likely to know that your network exists.

 **NOTE:** If your network is closed and the SSID is not broadcast, you will need to know or remember the SSID to connect new devices to the network. Write down the SSID and store it in a secure place before closing the network.

Connecting to a WLAN

To connect to the WLAN, follow these steps:

1. Be sure that the WLAN device is on. If it is on, the wireless light is on. If the wireless light is amber, slide the wireless switch.
2. Select **Start > Connect To**.
3. Select your WLAN from the list, and then type the network security key, if required.
 - If the network is unsecured, meaning that anyone can access the network, a warning is displayed. Click **Connect Anyway** to accept the warning and complete the connection.
 - If the network is a security-enabled WLAN, you are prompted to enter a network security key, which is a security code. Type the code, and then click **Connect** to complete the connection.

 **NOTE:** If no WLANs are listed, you are out of range of a wireless router or access point.

NOTE: If you do not see the network you want to connect to, click **Show all connections**. A list of options will appear that includes creating a new network connection, as well as troubleshooting connection issues.

After the connection is made, place the mouse pointer over the network status icon in the notification area, at the far right of the taskbar, to verify the name and status of the connection.

 **NOTE:** The functional range (how far your wireless signals travel) depends on WLAN implementation, router manufacturer, and interference from other electronic devices or structural barriers such as walls and floors.

More information about using a WLAN is available through the following resources:

- Information from your ISP and the manufacturer's instructions included with your wireless router and other WLAN equipment
- Information and Web site links provided in Help and Support

For a list of public WLANs near you, contact your ISP or search the Web. Web sites that list public WLANs include Cisco Internet Mobile Office Wireless Locations, Hotspotlist, and Geektools. Check with each public WLAN location for cost and connection requirements.

For additional information on connecting your computer to a corporate WLAN, contact your network administrator or IT department.

Roaming to another network

When you move your computer within range of another WLAN, Windows attempts to connect to that network. If the attempt is successful, your computer is automatically connected to the new network. If Windows does not recognize the new network, follow the same procedure you used initially to connect to your WLAN.

Using HP Mobile Broadband (select models only)

HP Mobile Broadband enables your computer to use wireless wide area networks (WWANs) to access the Internet from more places and over larger areas than it can by using WLANs. Using HP Mobile Broadband requires a network service provider (called a *mobile network operator*), which in most cases is a mobile phone network operator. Coverage for HP Mobile Broadband is similar to mobile phone voice coverage.

When used with mobile network operator service, HP Mobile Broadband gives you the freedom to stay connected to the Internet, send e-mail, or connect to your corporate network whether you are on the road or outside the range of Wi-Fi hotspots.

HP supports the following technologies:

- HSPA (High Speed Packet Access), which provides access to networks based on the Global System for Mobile Communications (GSM) telecommunications standard.
- EV-DO (Evolution Data Optimized), which provides access to networks based on the code division multiple access (CDMA) telecommunications standard.

You may need the HP Mobile Broadband Module serial number to activate mobile broadband service. The serial number is printed on a label inside the battery bay of your computer.

Some mobile network operators require the use of a subscriber identity module (SIM). A SIM contains basic information about you, such as a PIN (personal identification number), as well as network information. Some computers include a SIM that is preinstalled in the battery bay. If the SIM is not preinstalled, it may be provided in the HP Mobile Broadband information provided with your computer or the mobile network operator may provide it separately from the computer.

For information on inserting and removing the SIM, refer to the “Inserting a SIM” and “Removing a SIM” sections in this chapter.

For information on HP Mobile Broadband and how to activate service with a preferred mobile network operator, refer to the HP Mobile Broadband information included with your computer. For additional information, see the HP Web site at <http://www.hp.com/go/mobilebroadband> (US only).

Inserting a SIM

△ **CAUTION:** To prevent damage to the connectors, use minimal force when inserting a SIM.

To insert a SIM:

1. Shut down the computer. If you are not sure whether the computer is off or in Hibernation, turn the computer on by pressing the power button. Then shut down the computer through the operating system.
2. Close the display.
3. Disconnect all external devices connected to the computer.
4. Unplug the power cord from the AC outlet.
5. Turn the computer upside down on a flat surface, with the battery bay toward you.
6. Remove the battery.

7. Insert the SIM into the SIM slot, and gently push the SIM into the slot until it is firmly seated.

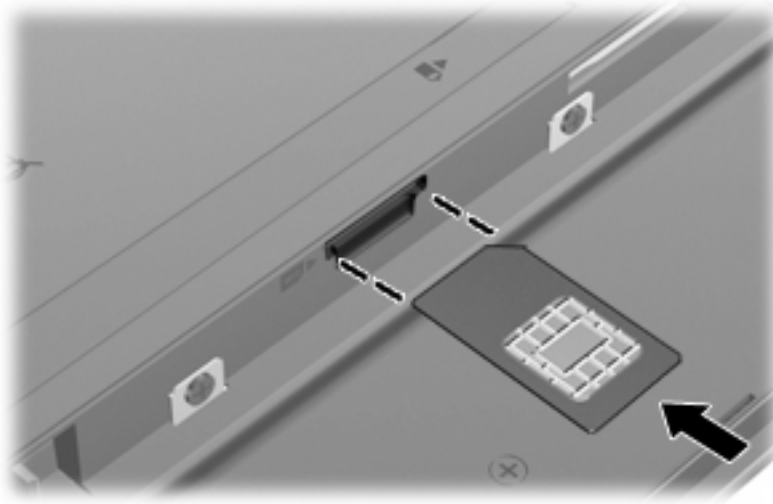

8. Replace the battery.

 **NOTE:** HP Mobile Broadband will be disabled if the battery is not replaced.

9. Reconnect external power.
10. Reconnect external devices.
11. Turn on the computer.

Removing a SIM

To remove a SIM:

1. Shut down the computer. If you are not sure whether the computer is off or in Hibernation, turn the computer on by pressing the power button. Then shut down the computer through the operating system.
2. Close the display.
3. Disconnect all external devices connected to the computer.
4. Unplug the power cord from the AC outlet.
5. Turn the computer upside down on a flat surface, with the battery bay toward you.
6. Remove the battery.

7. Press in on the SIM (1), and then remove it from the slot (2).

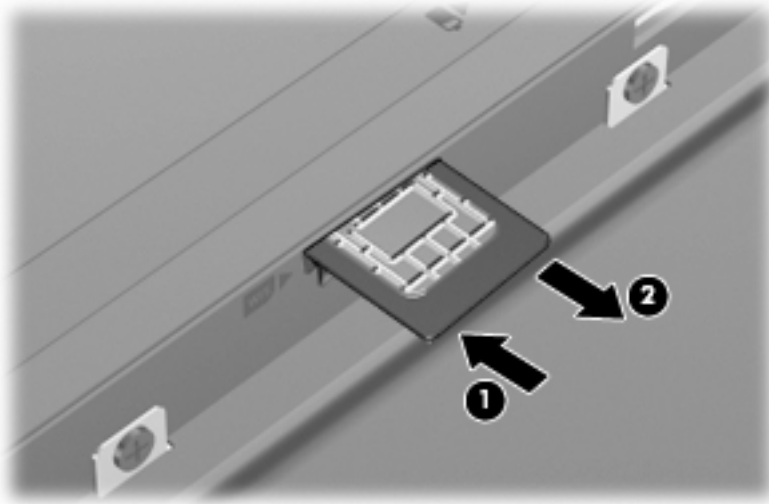

8. Replace the battery.
9. Reconnect external power.
10. Reconnect external devices.
11. Turn on the computer.

Using Bluetooth wireless devices (select models only)

A Bluetooth device provides short-range wireless communications that replace the physical cable connections that traditionally link electronic devices such as the following:

- Computers (desktop, notebook, PDA)
- Phones (cellular, cordless, smart phone)
- Imaging devices (printer, camera)
- Audio devices (headset, speakers)

Bluetooth devices provide peer-to-peer capability that allows you to set up a personal area network (PAN) of Bluetooth devices. For information on configuring and using Bluetooth devices, refer to the Bluetooth software Help.

Bluetooth and Internet Connection Sharing (ICS)

HP does **not** recommend setting up one computer with Bluetooth as a host and using it as a gateway through which other computers may connect to the Internet. When two or more computers are connected using Bluetooth, and Internet Connection Sharing (ICS) is enabled on one of the computers, the other computers may not be able to connect to the Internet using the Bluetooth network.

The strength of Bluetooth is in synchronizing information transfers between your computer and wireless devices including cellular phones, printers, cameras, and PDAs. The inability to consistently connect two or more computers to share the Internet through Bluetooth is a limitation of Bluetooth and the Windows operating system.

4 Multimedia

Multimedia features

Your computer includes multimedia features that allow you to listen to music, watch movies, and view pictures. Your computer may include the following multimedia components:

- Integrated speakers for listening to music
- Integrated microphones for recording your own audio
- Integrated webcam that allows you to capture and share video
- Preinstalled multimedia software that allows you to play and manage your music, movies, and pictures
- Function keys that provide fast access to volume control

 **NOTE:** Your computer may not include all of the components listed.

The following sections explain how to identify and use the multimedia components included with your computer.

Identifying your multimedia components

The following illustration and table describe the multimedia features of the computer.



Component	Description
(1) Webcam light	On: The webcam is in use.
(2) Webcam	Records audio and video and captures still photographs.
(3) Internal microphones (2)	Record sound.
(4) Audio-in (microphone) jack	Connects an optional computer headset microphone, stereo array microphone, or monaural microphone.
(5) Audio-out (headphone) jack	Produces sound when connected to optional powered stereo speakers, headphones, ear buds, or a headset.
	<p>WARNING! To reduce the risk of personal injury, adjust the volume before putting on headphones, earbuds, or a headset. For additional safety information, refer to the <i>Regulatory, Safety and Environmental Notices</i>.</p> <p>NOTE: When a device is connected to the headphone jack, the computer speakers are disabled.</p>
(6) Speakers (2)	Produce sound.

Adjusting the volume

You can adjust the volume using the following controls:

- Computer volume function keys—Either the **f8 (2)**, **f10 (3)**, or **f11 (4)** function key:
 - To mute or restore volume, press **f8**.
 - To decrease volume, press **f10**.

- To increase volume, press **f11**.

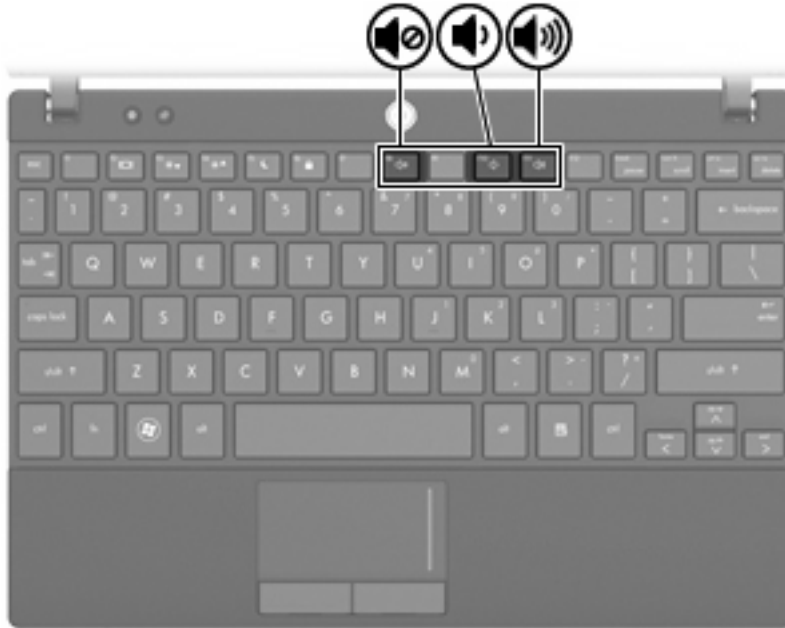

- Windows® volume control:
 - a. Click the **Volume** icon in the notification area, at the far right of the taskbar.
 - b. Increase or decrease the volume by moving the slider up or down. Select the **Mute** check box to mute the volume.

– or –

- a. Double-click the **Volume** icon in the notification area.
- b. In the Master Volume column, you can increase or decrease the volume by moving the **Volume** slider up or down. You can also adjust the balance or mute the volume.

If the Volume icon is not displayed in the notification area, follow these steps to add it:

- a. Select **Start > Control Panel > Sounds, Speech, and Audio Devices > Sounds and Audio Devices > Volume** tab.
 - b. Select the **Place volume icon in the taskbar** check box.
 - c. Click **Apply**.
- Program volume control:

Volume can also be adjusted within some programs.

Multimedia software

Your computer includes preinstalled multimedia software that allows you to play music and view pictures. The following sections provide details about preinstalled multimedia software and installing multimedia software from a disc.

Using preinstalled multimedia software

To locate preinstalled multimedia software:

- ▲ Select **Start > All Programs**, and then open the multimedia program you want to use.

 **NOTE:** Some programs may be located in subfolders.

Installing multimedia software from a disc

 **NOTE:** To install multimedia software from a disc, you must have an external optical drive connected to the computer. The computer provides one powered USB port on the left side of the computer. This port provides power to the external optical drive when used with a powered USB cable. An external optical drive connected to the other USB port on the computer must be connected to AC power.

To install any multimedia software from a CD or DVD, follow these steps:

1. Insert the disc into a connected external optical drive.
2. When the installation wizard opens, follow the on-screen instructions.
3. Restart the computer if prompted to do so.

 **NOTE:** For details about using software included with the computer, refer to the software manufacturer's instructions, which may be provided with the software, on disc, or on the manufacturer's Web site.

Audio

Your computer enables you to use a variety of audio features:

- Play music using your computer speakers and/or connected external speakers
- Record sound using the internal microphones or connect an external microphone
- Download music from the Internet
- Create multimedia presentations using audio and images
- Transmit sound and images with instant messaging programs
- Stream radio programs (select models only) or receive FM radio signals
- Create or “burn” audio CDs using an external optical drive

Connecting external audio devices

 **WARNING!** To reduce the risk of personal injury, adjust the volume before putting on headphones, earbuds, or a headset. For additional safety information, refer to the *Regulatory, Safety and Environmental Notices*.

To connect external devices such as external speakers, headphone, or a microphone, refer to the information provided with the device. For best results, remember the following tips:

- Be sure that the device cable is securely connected to the correct jack on your computer. (Cable connectors are normally color-coded to match the corresponding jacks on the computer.)
- Be sure to install any drivers required by the external device.

 **NOTE:** A driver is a required program that acts like a translator between the device and the programs that use the device.

Checking your audio functions

To check the system sound on your computer, follow these steps:

1. Select **Start > Control Panel**.
2. Click **Sounds, Speech, and Audio Devices > Sounds and Audio Devices**.
3. When the Sounds and Audio Devices Properties window opens, click the **Sounds** tab. Under **Program events**, select any sound event, such as a beep or alarm, and click the **Play** button.

You should hear sound through the speakers or through connected headphones.

To check the record functions of the computer, follow these steps:

1. Select **Start > All Programs > Accessories > Entertainment > Sound Recorder**.
2. Click **Record** and speak into the microphone. Save the file to the desktop.
3. Open Windows Media Player and play back the sound.

 **NOTE:** For best results when recording, speak directly into the microphone and record sound in a setting free of background noise.

- ▲ To confirm or change the audio settings on your computer, right-click the **Sound** icon on the taskbar, or select **Start > Control Panel > Sounds, Speech, and Audio Devices > Sounds and Audio Devices**.

Video

Your computer enables you to use a variety of video features:

- Play games over the Internet
- Edit pictures and video to create presentations
- Connect external video devices

Connecting an external monitor or projector

The external monitor port connects an external display device such as an external monitor or a projector to the computer.

- ▲ To connect a display device, connect the device cable to the external monitor port.

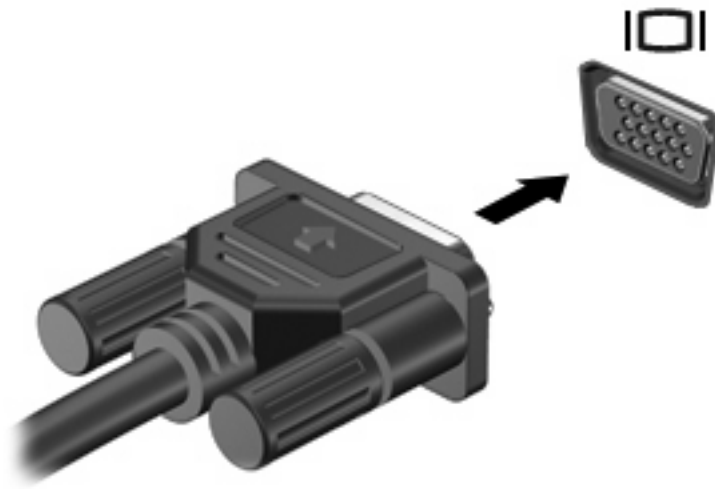

 **NOTE:** If a properly connected external display device does not display an image, press **f2** to transfer the image to the device. Repeatedly pressing **f2** alternates the screen image between the computer display and the device.

Optical drive (select models only)

Your computer may come with an external optical drive that expands the functionality of the computer. The external optical drive allows you to read data discs, play music, and watch movies.

Identifying the external optical drive

▲ Select **Start > My Computer**.

You will see a list of all the devices installed on your computer, including the connected external optical drive. You may have one of the following types of drives:

- DVD-ROM Drive
- DVD/CD-RW Combo Drive
- DVD±RW/R and CD-RW Combo Drive with Double-Layer (DL) support

 **NOTE:** Some of the drives listed above may not be supported by your computer.

Using optical discs

An optical drive, such as a DVD-ROM drive, supports optical discs (CDs and DVDs). These discs store information, such as music, photos, and movies. DVDs have a higher storage capacity than CDs.

The external optical drive can read standard CD and DVD discs.

 **NOTE:** Some of the optical drives listed may not be supported by your computer. The listed drives are not necessarily all of the supported optical drives.

Some optical drives can also write to optical discs as described in the following table.

Optical drive type	Read from CD and DVD-ROM media	Write to CD-R/RW media	Write to DVD (includes DVD+R DL, DVD±RW/R, and DVD-ROM media)	Write label to LightScribe CD or DVD
DVD-ROM Drive	Yes	No	No	No
DVD/CD-RW Combo Drive	Yes	Yes	No	No
DVD±RW/CD-RW Combo Drive	Yes	Yes	Yes	No

△ **CAUTION:** To prevent possible audio and video degradation, loss of information, or loss of audio or video playback functionality, do not initiate Standby or Hibernation while reading or writing to a CD or DVD.

Selecting the right disc

An optical drive supports optical discs (CDs and DVDs). CDs, used to store digital data, are also used for commercial audio recordings and are convenient for your personal storage needs. DVDs are used primarily for movies, software, and data backup purposes. DVDs are the same form factor as CDs but have 6 to 7 times the storage capacity.

 **NOTE:** The external optical drive connected to your computer may not support all the types of optical discs discussed in this section.

CD-R discs

Use CD-R (write-once) discs to create permanent archives and to share files with virtually anyone. Typical uses include the following:

- Distributing large presentations
- Sharing scanned and digital photos, video clips, and written data
- Making your own music CDs
- Keeping permanent archives of computer files and scanned home records
- Offloading files from your hard drive to free up disk space

After data is recorded, it cannot be erased or written over.

CD-RW discs

Use a CD-RW disc (a rewritable version of a CD) to store large projects that must be updated frequently. Typical uses include the following:

- Developing and maintaining large documents and project files
- Transporting work files
- Making weekly backups of hard drive files
- Updating photos, video, audio, and data continuously

DVD±R discs

Use blank DVD±R discs to permanently store large amounts of information. After data is recorded, it cannot be erased or written over.

DVD±RW discs

Use DVD±RW discs if you want to be able to erase or write over data that you saved earlier. This type of disc is ideal for testing audio or video recordings before you burn them to a CD or DVD that cannot be changed.

Playing music

 **NOTE:** Be sure that the external optical drive is connected to your computer before beginning these steps.

1. Turn on the computer.
2. Press the release button **(1)** on the external optical drive bezel to release the disc tray.
3. Pull out the tray **(2)**.
4. Hold the disc by the edges and position the disc label-side up over the tray spindle.

 **NOTE:** If the tray is not fully accessible, tilt the disc carefully to position it over the spindle.

5. Gently press the disc **(3)** down onto the tray spindle until the disc snaps into place.

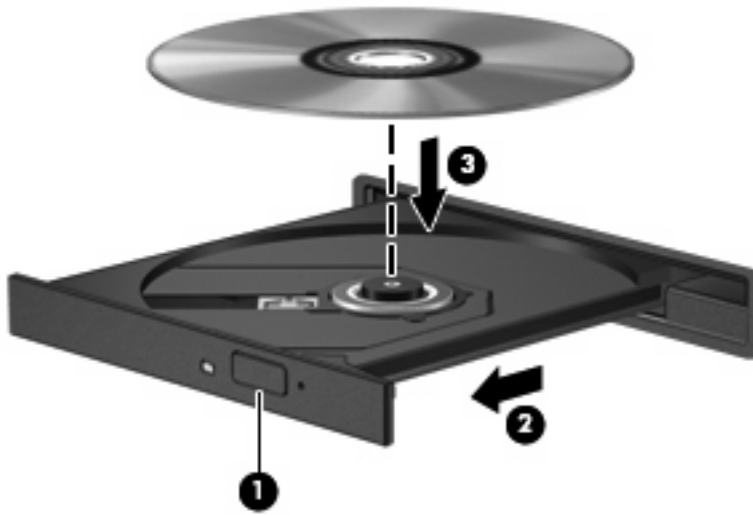

6. Close the disc tray.
7. If you have not yet configured AutoPlay, the AutoPlay dialog box opens and asks how you want to use the media content. Choose Windows Media Player, which is preinstalled on your computer.

 **NOTE:** After you insert a disc, a short pause is normal.

If Standby or Hibernation is accidentally initiated during playback of a disc:

- Your playback may be interrupted.
- You may see a warning message asking if you want to continue. If this message is displayed, click **No**.
- You may need to restart the CD or DVD to resume playback.

Watching a movie

An external optical drive allows you to watch movies from a disc.

 **NOTE:** Be sure that the external optical drive is connected to your computer before beginning these steps.

1. Turn on the computer.
2. Press the release button **(1)** on the external optical drive bezel to release the disc tray.
3. Pull out the tray **(2)**.
4. Hold the disc by the edges and position the disc label-side up over the tray spindle.

 **NOTE:** If the tray is not fully accessible, tilt the disc carefully to position it over the spindle.

5. Gently press the disc (3) down onto the tray spindle until the disc snaps into place.

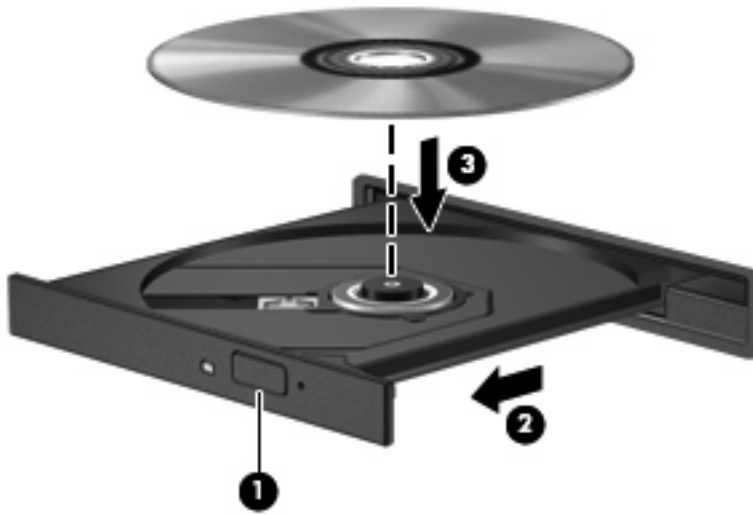

6. Close the disc tray.

 **NOTE:** After you insert a disc, a short pause is normal. If you have not selected a media player, an AutoPlay dialog box opens. It prompts you to select how you want to use the media content.

Changing DVD region settings

Most DVDs that contain copyrighted files also contain region codes. The region codes help protect copyrights internationally.

You can play a DVD containing a region code only if the region code on the DVD matches the region setting on your DVD drive.

 **CAUTION:** The region settings on your DVD drive can be changed only 5 times.

The region setting you select the fifth time becomes the permanent region setting on the DVD drive.

The number of region changes remaining is displayed on the DVD Region tab.

To change settings through the operating system:

1. Select **Start > My Computer**.
2. Right-click in the window and select **Properties > Hardware tab > Device Manager**.
3. Click the "+" sign next to **DVD/CD-ROM drives**, right-click the DVD drive for which you want to change region settings, and then click **Properties**.
4. Make the desired changes on the **DVD Region** tab.
5. Click **OK**.

Creating or “burning” a CD or DVD

If your external optical drive is a CD-RW, DVD-RW, or DVD±RW optical drive, you can use software such as Windows Media Player to burn data and audio files, including MP3 and WAV music files. To burn video files to a CD or DVD, use MyDVD.

Observe the following guidelines when burning a CD or DVD:

- Before burning a disc, save and close any open files and close all programs.
- A CD-R or DVD-R is usually best for burning audio files because after the information is copied, it cannot be changed.
- Because some home and car stereos will not play CD-RWs, use CD-Rs to burn music CDs.
- A CD-RW or DVD-RW is generally best for burning data files or for testing audio or video recordings before you burn them to a CD or DVD that cannot be changed.
- DVD players used in home systems usually do not support all DVD formats. Refer to the user guide that came with your DVD player for a list of supported formats.
- An MP3 file uses less space than other music file formats, and the process for creating an MP3 disc is the same as the process for creating a data file. MP3 files can be played only on MP3 players or on computers with MP3 software installed.

To burn a CD or DVD, follow these steps:

1. Download or copy the source files into a folder on your hard drive.
2. Insert a blank CD or DVD into the external optical drive.
3. Select **Start > All Programs** and the name of the software you want to use.
4. Select the kind of CD or DVD you want to create—data, audio, or video.
5. Right-click **Start**, click **Explore**, and navigate to the folder where the source files are stored.
6. Open the folder, and then drag the files to the drive that contains the blank optical disc.
7. Initiate the burning process as directed by the program you have selected.

For specific instructions, refer to the software manufacturer's instructions, which may be provided with the software, on disc, or on the manufacturer's Web site.

△ **CAUTION:** Observe the copyright warning. It is a criminal offense, under applicable copyright laws, to make unauthorized copies of copyright-protected material, including computer programs, films, broadcasts, and sound recordings. Do not use this computer for such purposes.

Removing an optical disc (CD or DVD)

1. Press the release button **(1)** on the drive bezel to release the disc tray, and then gently pull out the tray **(2)** until it stops.

2. Remove the disc **(3)** from the tray by gently pressing down on the spindle while lifting the outer edges of the disc. Hold the disc by the edges and avoid touching the flat surfaces.

 **NOTE:** If the tray is not fully accessible, tilt the disc carefully as you remove it.

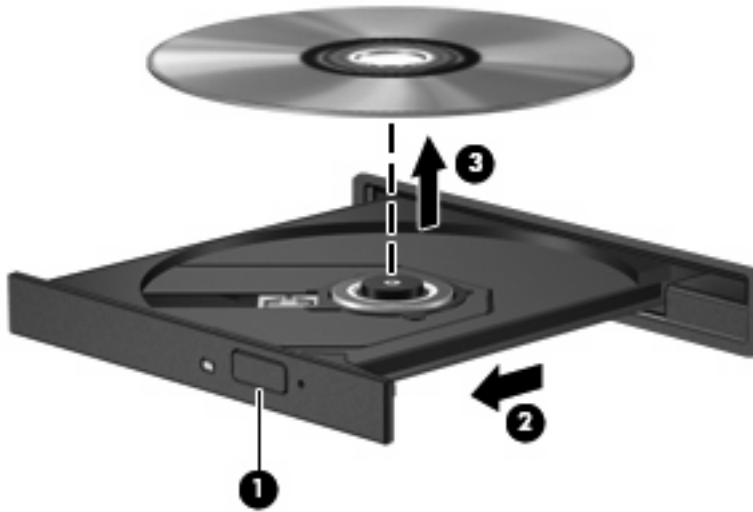

3. Close the disc tray and place the disc in a protective case.

Webcam

Your computer model includes an integrated webcam, located at the top of the display. The webcam can be used with a variety of software for the following functions:

- Capturing video
- Streaming video with instant message software
- Taking still photos

 **NOTE:** Be sure that you have installed software that is designed for use with the integrated webcam.

NOTE: For information about using software designed for use with the integrated webcam, refer to the online Help for that software.

For optimum performance, observe the following guidelines while using the integrated webcam:

- Be sure that you have the latest version of an instant message program before attempting a video conversation.
- The webcam may not work properly across some network firewalls.

 **NOTE:** If you are having trouble viewing or sending multimedia files to someone on another LAN or outside your network firewall, temporarily disable the firewall, perform the task you want to perform, and then reenable the firewall. To permanently resolve the problem, reconfigure the firewall as necessary, and adjust the policies and settings of other intrusion detection systems. For additional information, contact your network administrator or IT department.

- Whenever possible, place bright light sources behind the webcam and out of the picture area.

Adjusting webcam properties

You can adjust webcam properties using the Properties dialog box, which is accessible from various programs that use the integrated webcam, usually from a configuration, settings, or properties menu:

- **Brightness**—Controls the amount of light that is incorporated into the image. A higher brightness setting creates a brighter image; a lower brightness setting creates a darker image.
- **Contrast**—Controls the difference between lighter and darker areas on the image. A higher contrast setting intensifies the image; a lower contrast setting maintains more of the original information's dynamic range but leads to a flatter image.
- **Hue**—Controls the aspect of color that distinguishes it from another color (what makes a color red, green, or blue). Hue is distinct from saturation, which measures the intensity of the hue.
- **Saturation**—Controls the strength of color in the final image. A higher saturation setting creates a bolder image; a lower saturation setting creates a more subtle image.
- **Sharpness**—Controls the definition of edges in an image. A higher sharpness setting creates a more defined image; a lower sharpness setting creates a softer image.
- **Gamma**—Controls the contrast affecting the mid-level grays or midtones of an image. Adjusting the gamma of an image allows you to change the brightness values of the middle range of gray tones without dramatically altering the shadows and highlights. A lower gamma setting makes grays look black, and makes dark colors even darker.

For information about using the webcam, select **Start > Help and Support**.

5 Security

Protecting the computer

 **NOTE:** Security solutions are designed to act as deterrents. These deterrents may not prevent a product from being mishandled or stolen.

NOTE: In some countries or regions, the computer supports CompuTrace, which is an online-security-based tracking and recovery service. If the computer is stolen, CompuTrace can track the computer if the unauthorized user accesses the Internet. You must purchase the software and subscribe to the service in order to use CompuTrace. For information about ordering the CompuTrace software, see the HP Web site at <http://www.hpshopping.com>.

Security features provided with your computer can protect the computer, personal information, and data from a variety of risks. The way you use your computer will determine which security features you need to use.

The Windows operating system offers certain security features. Additional security features are listed in the following table. Most of these additional security features can be configured in the Computer Setup utility.

To protect against	Use this security feature
Unauthorized use of the computer	Power-on authentication using passwords or smart cards
Unauthorized access to Computer Setup (f10)	Setup password in Computer Setup*
Unauthorized access to the contents of a hard drive	DriveLock password in Computer Setup*
Unauthorized reset of Computer Setup (f10) passwords	Stringent security feature in Computer Setup*
Unauthorized startup from an optical drive, diskette drive, or internal network adapter	Boot options feature in Computer Setup*
Unauthorized access to data	<ul style="list-style-type: none">• Firewall software• Windows updates
Unauthorized access to Computer Setup settings and other system identification information	Setup password in Computer Setup*
Unauthorized removal of the computer	Security cable slot (used with an optional security cable)

*Computer Setup is a non-Windows utility accessed by pressing f10 when the computer is turned on or restarted. When using Computer Setup, you must use the keys on your computer to navigate and make selections.

Using passwords

A password is a group of characters that you choose to secure your computer information. Several types of passwords can be set, depending on how you want to control access to your information. Passwords can be set in Windows or in the non-Windows Computer Setup utility preinstalled on the computer.

△ **CAUTION:** To prevent being locked out of the computer, record each password you set. Because most passwords are not displayed as they are set, changed, or deleted, it is essential to record each password immediately and store it in a secure place.

You can use the same password for a Computer Setup feature and for a Windows security feature. You can also use the same password for more than one Computer Setup feature.

Use the following guidelines when setting a password in Computer Setup:

- A password can be any combination of up to 8 letters and numbers and is case sensitive.
- A password set in Computer Setup must be entered at a Computer Setup prompt. A password set in Windows must be entered at a Windows prompt.

Use the following tips for creating and saving passwords:

- When creating passwords, follow requirements set by the program.
- Write down your passwords and store them in a secure place away from the computer.
- Do not store passwords in a file on the computer.
- Do not use your name or other personal information that could be easily discovered by an outsider.

The following sections list Windows and Computer Setup passwords and describe their functions. For additional information about Windows passwords, such as screen-saver passwords, select **Start > Help and Support**.

Setting passwords in Windows

Windows passwords	Function
Administrator password*	Protects access to a Windows administrator-level account.
User password*	Protects access to a Windows user account.

*For information about setting a Windows administrator password or a Windows user password, select **Start > Help and Support**.

Setting passwords in Computer Setup

Computer Setup passwords	Function
Setup password	Protects access to Computer Setup.
Power-on password	Protects access to the computer contents when the computer turns on, restarts, or exits Hibernation.

Computer Setup passwords	Function
DriveLock master password	Protects access to the internal hard drive that is protected by DriveLock. It is also used to remove DriveLock protection. This password is set under DriveLock Passwords during the enable process.
DriveLock user password	Protects access to the internal hard drive that is protected by DriveLock, and is set under DriveLock Passwords during the enable process.

Setup password

The Computer Setup setup password protects the configuration settings and system identification information in Computer Setup. After this password is set, it must be entered to access Computer Setup and to make changes using Computer Setup.

Note the following characteristics of the setup password:

- It is not interchangeable with a Windows administrator password, although both passwords can be identical.
- It is not displayed as it is set, entered, changed, or deleted.
- It must be set and entered with the same keys. For example, a setup password set with keyboard number keys will not be recognized if you enter it thereafter with embedded numeric keypad number keys.
- It can include any combination of up to 32 letters and numbers and is not case sensitive.

Managing a setup password

A setup password is set, changed, and deleted in Computer Setup.

To manage, set, change, or delete this password, follow these steps:

1. Open Computer Setup by turning on or restarting the computer, and then pressing **f10** while the “F10 = ROM Based Setup” message is displayed in the lower-left corner of the screen.
2. Use the arrow keys to select **Security > Setup password**, and then press **enter**.
 - To set a setup password, type your password in the **New password** and **Verify new password** fields, and then press **f10**.
 - To change a setup password, type your current password in the **Old password** field, type a new password in the **New password** and **Verify new password** fields, and then press **f10**.
 - To delete a setup password, type your current password in the **Old password** field, and then press **f10**.
3. To save your preferences, use the arrow keys to select **File > Save changes and exit**. Then follow the instructions on the screen.

Your preferences go into effect when the computer restarts.

Entering a setup password

At the **Setup password** prompt, type your setup password (using the same kind of keys you used to set the password), and then press **enter**. After 3 unsuccessful attempts to enter the setup password, you must restart the computer and try again.

Power-on password

The Computer Setup power-on password prevents unauthorized use of the computer. After this password is set, it must be entered each time the computer is turned on.

Note the following characteristics of a power-on password:

- It is not displayed as it is set, entered, changed, or deleted.
- It must be set and entered with the same keys. For example, a power-on password set with keyboard number keys will not be recognized if you enter it thereafter with embedded numeric keypad number keys.
- It can include any combination of up to 32 letters and numbers and is not case sensitive.

Managing a power-on password

A power-on password is set, changed, and deleted in Computer Setup.

To manage, set, change, or delete this password, follow these steps:

1. Open Computer Setup by turning on or restarting the computer, and then pressing **f10** while the “F10 = ROM Based Setup” message is displayed in the lower-left corner of the screen.
2. Use the arrow keys to select **Security > Power-On password**, and then press **enter**.
 - To set a power-on password, type the password in the **New password** and **Verify new password** fields, and then press **f10**.
 - To change a power-on password, type the current password in the **Old password** field, type the new password in the **New password** and **Verify new password** fields, and then press **f10**.
 - To delete a power-on password, type the current password in the **Old password** field, and then press **f10**.
3. To save your preferences, use the arrow keys to select **File > Save changes and exit**. Then follow the instructions on the screen.

Your preferences go into effect when the computer restarts.

Entering a power-on password

At the **Power-on Password** prompt, type your password (using the same kind of keys you used to set the password), and then press [enter](#). After 3 unsuccessful attempts to enter the password, you must turn off the computer, turn it back on, and then try again.

Requiring a power-on password at restart

In addition to requiring that a power-on password be entered each time the computer is turned on, you can also require that a power-on password be entered each time the computer is restarted.

To enable and disable this feature in Computer Setup, follow these steps:

1. Open Computer Setup by turning on or restarting the computer, and then pressing **f10** while the “F10 = ROM Based Setup” message is displayed in the lower-left corner of the screen.
2. Use the arrow keys to select **Security > Password options**, and then press **enter**.
3. Use the arrow keys to select **Enable** or **Disable** in the **Require password on restart** field, and then press **f10**.
4. To save your preferences, use the arrow keys to select **File > Save changes and exit**. Then follow the instructions on the screen.

Using Computer Setup DriveLock

- △ **CAUTION:** To prevent the DriveLock-protected hard drive from becoming permanently unusable, record the DriveLock user password and the DriveLock master password in a safe place away from your computer. If you forget both DriveLock passwords, the hard drive will be permanently locked and can no longer be used.

DriveLock protection prevents unauthorized access to the contents of a hard drive. DriveLock can be applied only to the internal hard drive(s) of the computer. After DriveLock protection is applied to a drive, a password must be entered to access the drive. The drive must be inserted into the computer, not into an optional docking device or external MultiBay, in order for it to be accessed by the DriveLock passwords.

To apply DriveLock protection to an internal hard drive, a user password and a master password must be set in Computer Setup. Note the following considerations about using DriveLock protection:

- After DriveLock protection is applied to a hard drive, the hard drive can be accessed only by entering either the user password or the master password.
- The owner of the user password should be the day-to-day user of the protected hard drive. The owner of the master password may be either a system administrator or the day-to-day user.
- The user password and the master password can be identical.
- You can delete a user password or master password only by removing DriveLock protection from the drive. DriveLock protection can be removed from the drive only with the master password.

- 📝 **NOTE:** When your power-on password and DriveLock user password are identical, you will be prompted to enter only a power-on password instead of both a power-on password and a DriveLock user password.

Setting a DriveLock password

To access the DriveLock settings in Computer Setup, follow these steps:

1. Open Computer Setup by turning on or restarting the computer, and then pressing **f10** while the “F10 = ROM Based Setup” message is displayed in the lower-left corner of the screen.
2. Use the arrow keys to select **Security > DriveLock passwords**, and then press **enter**.
3. Select the location of the hard drive you want to protect, and then press **f10**.
4. Use the arrow keys to select **Enable** in the **Protection** field, and then press **f10**.
5. Read the warning. To continue, press **f10**.
6. Type your user password in the **New password** and **Verify new password** fields, and then press **f10**.
7. Type your master password in the **New password** and **Verify new password** fields, and then press **f10**.
8. To confirm DriveLock protection on the drive you have selected, type `DriveLock` in the confirmation field, and then press **f10**.
9. To exit DriveLock settings, use the arrow keys to select **Esc**.
10. To save your preferences, use the arrow keys to select **File > Save changes and exit**. Then follow the instructions on the screen.

Your preferences go into effect when the computer restarts.

Entering a DriveLock password

Be sure that the hard drive is inserted into the computer (not into an optional docking device or external MultiBay).

At the **DriveLock Password** prompt, type your user or master password (using the same kind of keys you used to set the password), and then press [enter](#).

After 2 incorrect attempts to enter the password, you must shut down the computer and try again.

Changing a DriveLock password

To access the DriveLock settings in Computer Setup, follow these steps:

1. Open Computer Setup by turning on or restarting the computer, and then pressing **f10** while the “F10 = ROM Based Setup” message is displayed in the lower-left corner of the screen.
2. Use the arrow keys to select **Security > DriveLock passwords**, and then press **enter**.
3. Use the arrow keys to select the location of the internal hard drive, and then press **f10**.
4. Use the arrow keys to select the field for the password you want to change. Type your current password in the **Old password** field, and then type the new password in the **New password** field and in the **Verify new password** field. Then press **f10**.
5. To save your preferences, use the arrow keys to select **File > Save changes and exit**. Then follow the instructions on the screen.

Your preferences go into effect when the computer restarts.

Removing DriveLock protection

To access the DriveLock settings in Computer Setup, follow these steps:

1. Open Computer Setup by turning on or restarting the computer, and then pressing **f10** while the “F10 = ROM Based Setup” message is displayed in the lower-left corner of the screen.
2. Use the arrow keys to select **Security > DriveLock passwords**, and then press **enter**.
3. Use the arrow keys to select the location of the internal hard drive, and then press **f10**.
4. Use the arrow keys to select **Disable** in the **Protection** field, and then press **f10**.
5. Type your master password in the **Old password** field. Then press **f10**.
6. To save your preferences, use the arrow keys to select **File > Save changes and exit**. Then follow the instructions on the screen.

Your preferences go into effect when the computer restarts.

Using Computer Setup security features

Securing system devices

From the Boot options menu or the Port options menu in Computer Setup, you can disable or enable system devices.

To disable or reenable system devices in Computer Setup, follow these steps:

1. Open Computer Setup by turning on or restarting the computer, and then pressing **f10** while the “F10 = ROM Based Setup” message is displayed in the lower-left corner of the screen.
2. Use the arrow keys to select **System Configuration > Boot options** or **System Configuration > Port options**. Then press **enter** and use the arrow keys to select the options you want.
3. To confirm your preferences, press **f10**.
4. To save your preferences, use the arrow keys to select **File > Save changes and exit**. Then follow the instructions on the screen.

Your preferences go into effect when the computer restarts.

Using Computer Setup stringent security

-
- △ **CAUTION:** To prevent the computer from becoming permanently unusable, record your configured setup password, power-on password, or smart card PIN in a safe place away from your computer. Without these passwords or PIN, the computer cannot be unlocked.
-

The stringent security feature enhances power-on security by forcing user authentication with your configured setup password, power-on password, or smart card PIN before granting access to the system.

Setting stringent security

To enable stringent security in Computer Setup, follow these steps:

1. Open Computer Setup by turning on or restarting the computer, and then pressing **f10** while the “F10 = ROM Based Setup” message is displayed in the lower-left corner of the screen.
2. Use the arrow keys to select **Security > Password options**, and then press **enter**.
3. Use the arrow keys to select **Enable** in the **Stringent security** field.
4. Read the warning. To continue, press **f10**.
5. To enable the feature each time the computer is turned on, press **f10**.
6. To save your preferences, use the arrow keys to select **File > Save changes and exit**. Then follow the instructions on the screen.

Your preferences go into effect when the computer restarts.

Removing stringent security

To remove stringent security in Computer Setup, follow these steps:

1. Open Computer Setup by turning on or restarting the computer, and then pressing **f10** while the “F10 = ROM Based Setup” message is displayed in the lower-left corner of the screen.
2. Use the arrow keys to select **Security > Password options** and then press **enter**.
3. Use the arrow keys to select **Disable** in the **Stringent security** field, and then press **f10**.
4. To save your preferences, use the arrow keys to select **File > Save changes and exit**. Then follow the instructions on the screen.

Your preferences go into effect when the computer restarts.

Viewing Computer Setup System Information

The System Information feature in Computer Setup provides 2 types of system information:

- Identification information about the computer model.
- Specification information for the processor, cache and memory size, and system ROM.

To view this general system information, follow these steps:

1. Open Computer Setup by turning on or restarting the computer, and then pressing **f10** while the “F10 = ROM Based Setup” message is displayed in the lower-left corner of the screen.
2. Use the arrow keys to select **File > System Information**, and then press **enter**.



NOTE: To prevent unauthorized access to this information, you must create a setup password in Computer Setup.

Using antivirus software

When you use the computer to access e-mail, a network, or the Internet, you expose the computer to computer viruses. Computer viruses can disable the operating system, applications, or utilities, or cause them to function abnormally.

Antivirus software can detect most viruses, destroy them, and in most cases, repair any damage they have caused. To provide ongoing protection against newly discovered viruses, antivirus software must be updated.

For more information about computer viruses, type `viruses` in the Search box in Help and Support.

Using firewall software

When you use the computer to access e-mail, a network, or the Internet, unauthorized persons may be able to gain access to information about you, the computer, and your personal files. Use the firewall software preinstalled on the computer to protect your privacy.

Firewall features include information on logging and reporting, and automatic alarms to monitor all incoming and outgoing traffic. Refer to the firewall documentation or contact your firewall manufacturer for more information.

 **NOTE:** Under some circumstances a firewall can block access to Internet games, interfere with printer or file sharing on a network, or block authorized e-mail attachments. To temporarily solve the problem, disable the firewall, perform the task that you want to perform, and then reenable the firewall. To permanently resolve the problem, reconfigure the firewall.

Installing critical updates

△ **CAUTION:** To protect the computer from security breaches and computer viruses, install the online critical updates from Microsoft as soon as you receive an alert.

Updates to the operating system and other software may have become available *after* the computer was shipped. To be sure that all available updates are installed on the computer, observe these guidelines:

- Run Windows Update monthly to install the latest software from Microsoft.
- Obtain updates, as they are released, from the Microsoft Web site and through the updates link in Help and Support.

Installing a security cable

 **NOTE:** The security cable is designed to act as a deterrent, but it may not prevent the computer from being mishandled or stolen.

1. Loop the security cable around a secured object.
2. Insert the key (1) into the cable lock (2).
3. Insert the cable lock into the security cable slot on the computer (3), and then lock the cable lock with the key.

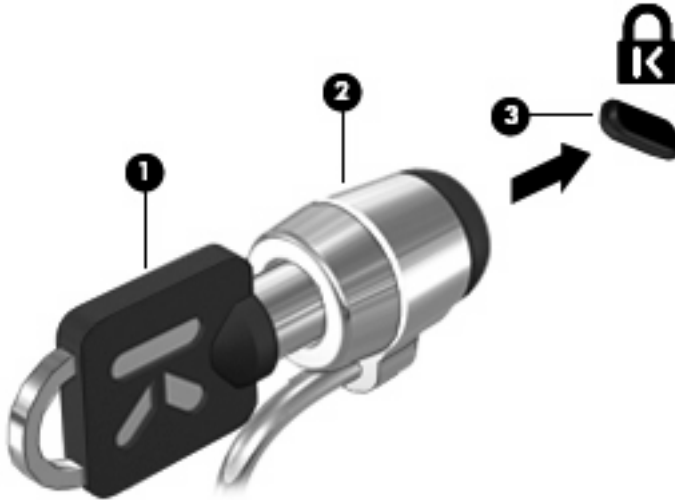

 **NOTE:** Your computer may look different from the illustration. The location of the security cable slot varies by model.

6 External devices

Using a USB device

Universal Serial Bus (USB) is a hardware interface that can be used to connect an optional external device, such as a USB keyboard, mouse, drive, printer, scanner, or hub.

Some USB devices may require additional support software, which is usually included with the device. For more information about device-specific software, refer to the manufacturer's instructions.

Your computer model has 2 USB ports, which support USB 1.0, USB 1.1, and USB 2.0 devices. A USB hub provides additional USB ports that can be used with the computer.

Connecting a USB device

△ **CAUTION:** To prevent damage to a USB connector, use minimal force to connect a USB device.

▲ To connect a USB device to the computer, connect the USB cable for the device to the USB port.



You will hear a sound when the device has been detected.

📄 **NOTE:** The first time you connect a USB device, a message is displayed in the notification area to let you know the device is recognized by the computer.

Stopping and removing a USB device

△ **CAUTION:** To prevent loss of information or an unresponsive system, stop a USB device before removing it.

CAUTION: To prevent damage to a USB connector, do not pull on the cable to remove the USB device.

To stop and remove a USB device:

1. Double-click the **Safely Remove Hardware** icon in the notification area, at the far right of the taskbar.

 **NOTE:** To display the Safely Remove Hardware icon, click the **Show Hidden Icons** icon (< or <<) in the notification area.

2. Click the name of the device in the list.

 **NOTE:** If the USB device is not listed, you do not have to stop the device before you remove it.

3. Click **Stop**, and then click **OK**.
4. Remove the device.

Using USB legacy support

USB legacy support (enabled by default) permits the following actions:

- Using a USB keyboard, mouse, or hub connected to a USB port on the computer during startup or in an MS-DOS-based program or utility
- Starting or restarting from an optional external MultiBay or an optional USB bootable device

USB legacy support is enabled at the factory. To disable or enable USB legacy support:

1. Open Computer Setup by turning on or restarting the computer, and then pressing **f10** while the “F10 = ROM Based Setup” message is displayed in the lower-left corner of the screen.
2. Use the arrow keys to select **System Configuration > Device configurations**, and then press **enter**.
3. Use the arrow keys to enable or disable USB legacy support, and then press **f10**.
4. To save your preferences and exit Computer Setup, use the arrow keys to select **File > Save changes and exit**. Then follow the instructions on the screen.

Your preferences go into effect when the computer restarts.

Using external drives

Removable external drives expand your options for storing and accessing information. A USB drive can be added by connecting the drive to a USB port on the computer.

 **NOTE:** HP external USB optical drives should be connected to the powered USB port on the left side of the computer.

USB drives include the following types:

- 1.44-megabyte diskette drive
- Hard drive module (a hard drive with an adapter attached)
- DVD-ROM Drive
- DVD/CD-RW Combo Drive
- DVD+RW and CD-RW Combo Drive
- DVD±RW/CD-RW Combo Drive
- MultiBay device

Using optional external devices

 **NOTE:** For more information about required software and drivers, or to learn which computer port to use, refer to the manufacturer's instructions.

To connect an external device to the computer:

 **CAUTION:** To reduce the risk of damage to the equipment when connecting a powered device, be sure that the device is turned off and the AC power cord is unplugged.

1. Connect the device to the computer.
2. If you are connecting a powered device, plug the device power cord into a grounded AC outlet.
3. Turn on the device.

To disconnect an unpowered external device, turn off the device, and then disconnect it from the computer. To disconnect a powered external device, turn off the device, disconnect it from the computer, and then unplug the AC power cord.

Using an optional external MultiBay II

An MultiBay II connects to a USB port on the computer and enables you to use MultiBay II devices. The computer provides one powered USB port on the left side of the computer. This port provides power to the external MultiBay when used with a powered USB cable. An external MultiBay connected to the other USB port on the computer must be connected to AC power.

For more information about the external MultiBay, refer to the user guide that is included with the device.

Using an optional external optical drive (select models only)

An external optical drive connects to a USB port on the computer and enables you to use optical discs (CDs and DVDs). The computer provides one powered USB port on the left side of the computer. This port provides power to the external optical drive when used with a powered USB cable. An external optical drive connected to the other USB port on the computer must be connected to AC power.

An external optical drive, such as a DVD-ROM drive, supports optical discs (CDs and DVDs). These discs store or transport information and play music and movies. DVDs have a higher storage capacity than CDs.

All optical drives can read from optical discs and some drives can also write to optical discs as described in the following table.

Optical drive type	Read from CD and DVD-ROM media	Write to CD-R/RW media	Write to DVD (includes DVD+R DL, DVD±RW/R, and DVD-RAM media)	Write label to LightScribe CD or DVD
DVD-ROM Drive	Yes	No	No	No
DVD/CD-RW Combo Drive	Yes	Yes	No	No
DVD±RW/CD-RW Combo Drive	Yes	Yes	Yes	No

NOTE: Some of the optical drives listed may not be supported by your computer. The listed drives are not necessarily all of the supported optical drives.

△ **CAUTION:** To prevent possible audio and video degradation, or loss of audio or video playback functionality, do not initiate Standby or Hibernation while reading from or writing to a CD or DVD.

To prevent loss of information, do not initiate Standby or Hibernation when writing to a CD or DVD.

If Standby or Hibernation is initiated during playback of a disc, you may experience the following behaviors:

- Your playback may be interrupted.
- You may see a warning message asking if you want to continue. If this message is displayed, click **No**.
- You may need to restart the CD or DVD to resume audio and video playback.

Inserting an optical disc (CD or DVD)

1. Turn on the computer.
2. Press the release button **(1)** on the drive bezel to release the disc tray.
3. Pull out the tray **(2)**.
4. Hold the disc by the edges to avoid touching the flat surfaces and position the disc label-side up over the tray spindle.

 **NOTE:** If the tray is not fully accessible, tilt the disc carefully to position it over the spindle.

5. Gently press the disc **(3)** down onto the tray spindle until the disc snaps into place.

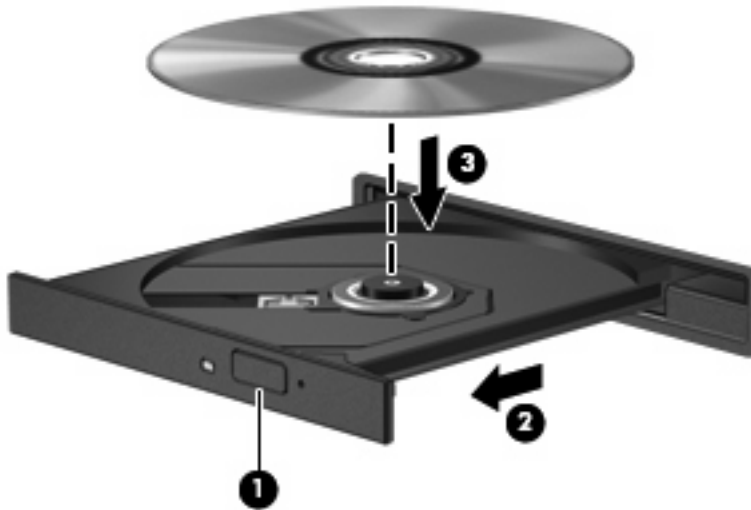

6. Close the disc tray.

Removing an optical disc (CD or DVD)

There are 2 ways to remove a disc, depending on whether the disc tray opens normally or not.

When the disc tray opens

1. Press the release button **(1)** on the drive bezel to release the disc tray, and then gently pull out the tray **(2)** until it stops.

2. Remove the disc **(3)** from the tray by gently pressing down on the spindle while lifting the outer edges of the disc. Hold the disc by the edges and avoid touching the flat surfaces.

 **NOTE:** If the tray is not fully accessible, tilt the disc carefully as you remove it.

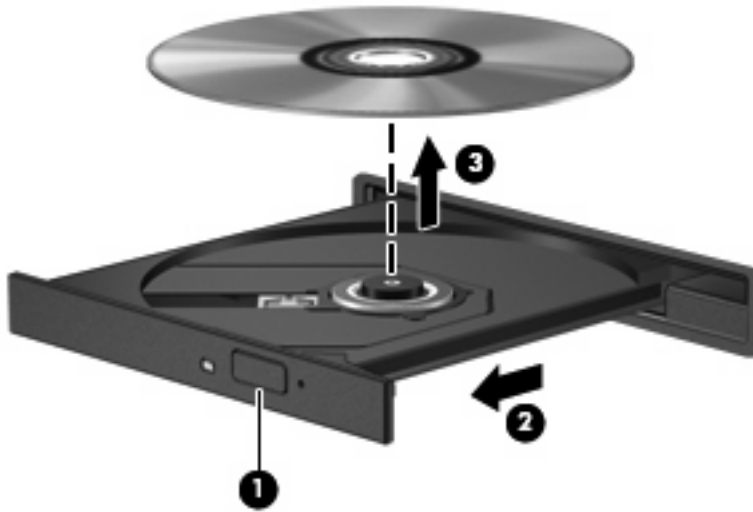

3. Close the disc tray and place the disc in a protective case.

When the disc tray does not open

1. Insert the end of a paper clip **(1)** into the release access in the front bezel of the drive.
2. Press in gently on the paper clip until the tray is released, and then pull out the tray **(2)** until it stops.

3. Remove the disc (3) from the tray by gently pressing down on the spindle while lifting the outer edges of the disc. Hold the disc by the edges and avoid touching the flat surfaces.

 **NOTE:** If the tray is not fully accessible, tilt the disc carefully as you remove it.

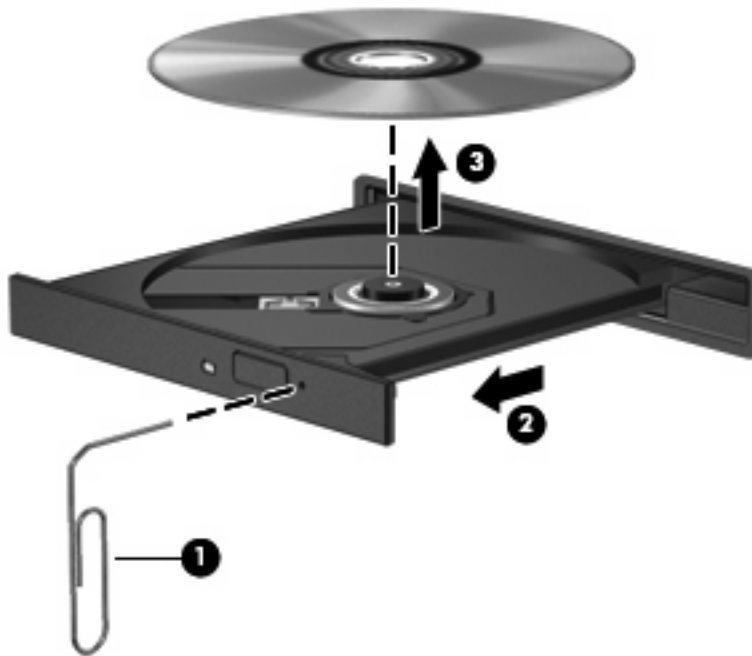

4. Close the disc tray and place the disc in a protective case.

7 External media cards

Using SD Card Reader cards

Optional digital cards provide secure data storage and convenient data sharing. These cards are often used with digital media–equipped cameras and PDAs as well as with other computers.

The SD Card Reader supports the following formats:

- MultiMediaCard (MMC)
- Secure Digital (SD) Memory Card

Inserting a digital card

△ **CAUTION:** To avoid damaging the digital card or the computer, do not insert any type of adapter into the SD Card Reader.

CAUTION: To prevent damage to the digital card connectors, use minimal force to insert a digital card.

1. Hold the digital card label-side up, with the connectors facing the computer.
2. Insert the card into the SD Card Reader, and then push in on the card until it is firmly seated.

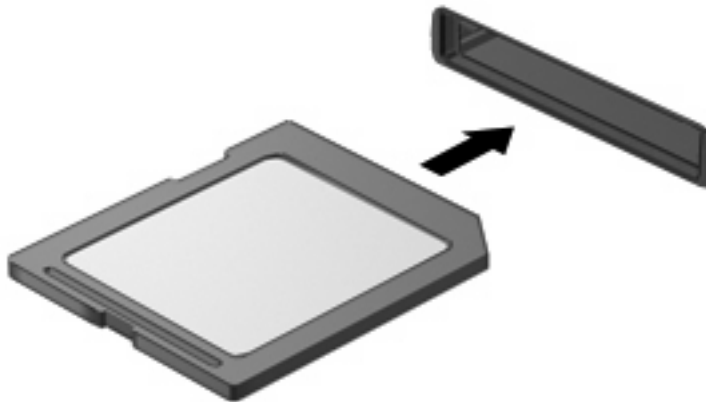

You will hear a sound when the device has been detected, and a menu of available options may be displayed.

Stopping and removing a digital card

△ **CAUTION:** To prevent loss of data or an unresponsive system, stop a digital card before removing it.

1. Save your information and close all programs associated with the digital card.

 **NOTE:** To stop a data transfer, click **Cancel** in the operating system Copying window.

2. Stop the digital card:

- a. Double-click the **Safely Remove Hardware** icon in the notification area, at the far right of the taskbar.

 **NOTE:** To display the Safely Remove Hardware icon, click the **Show Hidden Icons** icon (< or <<) in the notification area.

- b. Click the name of the digital card in the list.
 - c. Click **Stop**, and then click **OK**.
3. Press in on the digital card **(1)**, and then remove the card from the slot **(2)**.

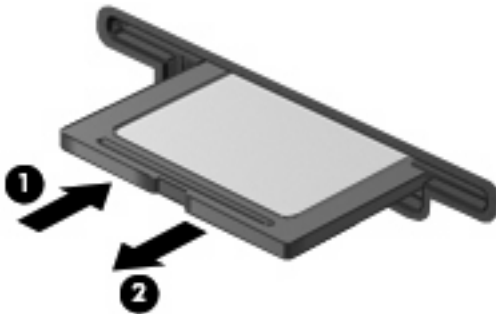

8 Pointing devices and keyboard

Using pointing devices

Setting pointing device preferences

Use Mouse Properties in Windows® to customize settings for pointing devices, such as button configuration, click speed, and pointer options.

To access Mouse Properties, select **Start > Control Panel > Printers and Other Hardware > Mouse**.

Using the TouchPad

To move the pointer, slide your finger across the TouchPad surface in the direction you want the pointer to go. Use the TouchPad buttons like the corresponding buttons on an external mouse. To scroll up and down using the TouchPad vertical scroll zone, slide your finger up or down over the lines.

 **NOTE:** If you are using the TouchPad to move the pointer, you must lift your finger off the TouchPad before moving it to the scroll zone. Simply sliding your finger from the TouchPad to the scroll zone will not activate the scrolling function.

Connecting an external mouse

You can connect an external USB mouse to the computer using one of the USB ports on the computer. A USB mouse can also be connected to the system using the ports on an optional docking device or expansion product.

Using the keyboard function keys

The icons on the function keys **f2** through **f6** and **f8**, **f10**, and **f11** keys represent the action performed when a function key is pressed. The following table and sections describe the function keys.

 **NOTE:** Your computer may look slightly different from the illustration in this section.

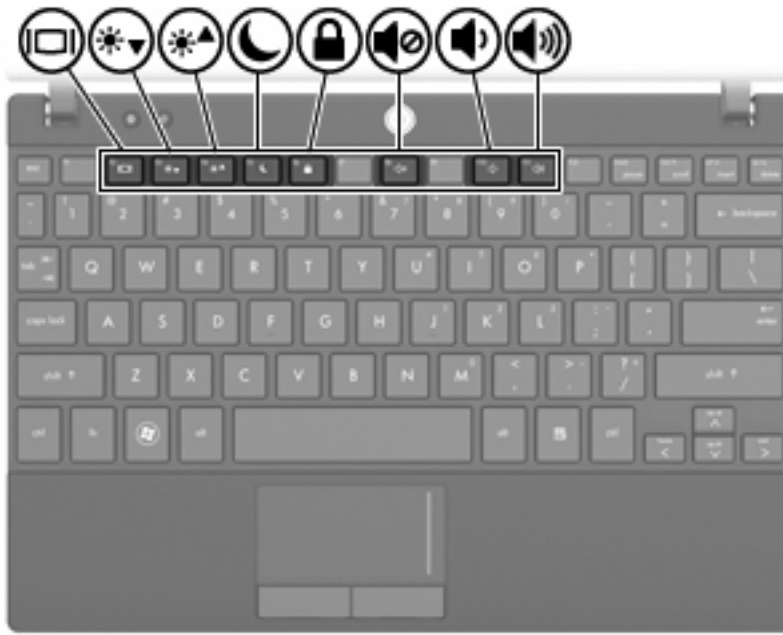

Function	Key
Alternate between computer display and external display.	f2
Decrease screen brightness.	f3
Increase screen brightness.	f4
Initiate Standby.	f5
Initiate QuickLock.	f6
Mute or restore computer sound.	f8
Decrease computer sound.	f10
Increase computer sound.	f11

Switching the screen image (f2)

Press **f2** to switch the screen image among display devices connected to the system. For example, if a monitor is connected to the computer, pressing **f2** alternates the screen image from computer display to monitor display to simultaneous display on both the computer and the monitor.

Most external monitors receive video information from the computer using the external VGA video standard. Pressing **f2** can also alternate images among other devices receiving video information from the computer.

The following video transmission types, with examples of devices that use them, are supported by the **f2** key:

- LCD (computer display)
- External VGA (most external monitors)

Decreasing screen brightness (f3)

Press **f3** to decrease screen brightness. Hold down the key to decrease the brightness level incrementally.

Increasing screen brightness (f4)

Press **f4** to increase screen brightness. Hold down the key to increase the brightness level incrementally.

Initiating Standby (f5)

Press **f5** to initiate Standby.

When Standby is initiated, your information is stored in system memory, the screen is cleared, and power is conserved. While the computer is in the Sleep state, the power lights blink.

CAUTION: To reduce the risk of information loss, save your work before initiating Standby.

The computer must be on before you can initiate Standby.

To exit Standby, briefly press the power button or press any key on the keyboard.

The function of the **f5** key can be changed. For example, you can set the **f5** key to initiate Hibernation instead of Standby.

Initiating QuickLock (f6)

Press **f6** to initiate the QuickLock security feature.

QuickLock protects your information by displaying the operating system Log On window. While the Log On window is displayed, the computer cannot be accessed until a password is entered.

 **NOTE:** Before you can use QuickLock, you must set a password.

To use QuickLock, press **f6** to display the Log On window and lock the computer. Then follow the instructions on the screen to enter your password and access the computer.

Muting speaker sound (f8)

Press **f8** to mute speaker sound. Press the key again to restore speaker sound.

Decreasing speaker sound (f10)

Press **f10** to decrease speaker sound. Hold down the key to decrease speaker sound incrementally.

Increasing speaker sound (f11)

Press **f11** to increase speaker sound. Hold down the key to increase speaker sound incrementally.

Using keypads

The computer has an embedded numeric keypad and also supports an optional external numeric keypad or an optional external keyboard that includes a numeric keypad.

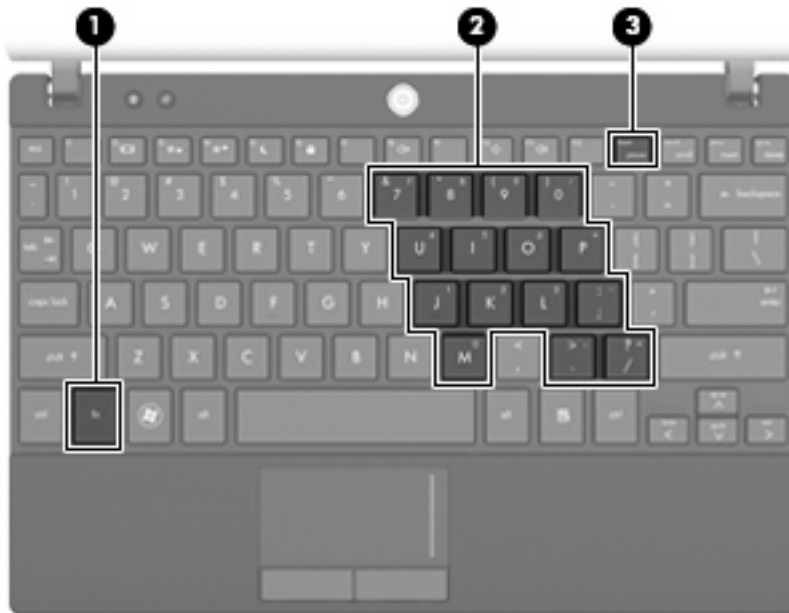

Component	Description
(1) fn key	Alternates the functions of the keys on the embedded numeric keypad when pressed in combination with a keypad key or the shift key.
(2) Embedded numeric keypad	Can be used like the keys on an external numeric keypad.
(3) num lk key	Enables the embedded numeric keypad.

Using the embedded numeric keypad

The 15 keys of the embedded numeric keypad can be used like the keys on an external keypad. When the embedded numeric keypad is turned on, each key on the keypad performs the function indicated by the icon in the upper-right corner of the key.

Enabling and disabling the embedded numeric keypad

Press **fn+num lk** to enable the embedded numeric keypad. Press **fn+num lk** again to return the keys to their standard keyboard functions.

 **NOTE:** The embedded numeric keypad will not function while an external keyboard or numeric keypad is connected to the computer, an optional docking device, or an optional expansion product.

Switching key functions on the embedded numeric keypad

You can temporarily alternate the functions of keys on the embedded numeric keypad between their standard keyboard functions and their keypad functions by using the **fn** key or the **fn+shift** key combination.

- To change the function of a keypad key to keypad functions while the keypad is off, press and hold the **fn** key while pressing the keypad key.
- To use the keypad keys temporarily as standard keys while the keypad is on:
 - Press and hold the **fn** key to type in lowercase.
 - Press and hold **fn+shift** to type in uppercase.

Using an optional external numeric keypad

Keys on most external numeric keypads function differently according to whether num lock is on or off. (Num lock is turned off at the factory.) For example:

- When num lock is on, most keypad keys type numbers.
- When num lock is off, most keypad keys function like the arrow, page up, or page down keys.

When num lock on an external keypad is turned on, the num lock light on the computer is turned on. When num lock on an external keypad is turned off, the num lock light on the computer is turned off.

To turn num lock on or off on an external keypad as you work:

- ▲ Press the **num lk** key on the external keypad, not on the computer.

Cleaning the TouchPad and keyboard

Dirt and grease on the TouchPad can cause the pointer to jump around on the screen. To avoid this, clean the TouchPad with a damp cloth, and wash your hands frequently when using the computer.

⚠ **WARNING!** To reduce the risk of electric shock or damage to internal components, do not use a vacuum cleaner attachment to clean the keyboard. A vacuum cleaner can deposit household debris on the keyboard surface.

Clean the keyboard regularly to prevent keys from sticking and to remove dust, lint, and particles that can become trapped beneath the keys. A can of compressed air with a straw extension can be used to blow air around and under the keys to loosen and remove debris.



9 Drives

Identifying installed drives

To view the drives installed on the computer, select **Start > My Computer**.

On models with a secondary hard drive (drive D), the optical drive becomes drive E. The next drive added to the system, such as a new USB drive, will be assigned the next available drive letter.

Handling drives

Drives are fragile computer components that must be handled with care. Refer to the following cautions before handling drives. Additional cautions are included with the procedures to which they apply.

△ **CAUTION:** To reduce the risk of damage to the computer, damage to a drive, or loss of information, observe these precautions:

Before you move a computer that is connected to an external hard drive, initiate Standby and allow the screen to clear, or properly disconnect the external hard drive.

Before handling a drive, discharge static electricity by touching the unpainted metal surface of the drive.

Do not touch the connector pins on a removable drive or on the computer.

Handle a drive carefully; do not drop a drive or place items on it.

Before removing or inserting a drive, shut down the computer. If you are unsure whether the computer is off, in Standby, or in Hibernation, turn the computer on and then shut it down through the operating system.

Do not use excessive force when inserting a drive into a drive bay.

Do not type on the keyboard or move the computer while an optional optical drive is writing to a disc. The write process is sensitive to vibration.

When the battery is the only source of power, be sure that the battery is sufficiently charged before writing to media.

Avoid exposing a drive to temperature or humidity extremes.

Avoid exposing a drive to liquids. Do not spray the drive with cleaning products.

Remove media from a drive before removing the drive from the drive bay, or traveling with, shipping, or storing a drive.

If a drive must be mailed, place the drive in a bubble-pack mailer or other suitable protective packaging and label the package "FRAGILE."

Avoid exposing a drive to magnetic fields. Security devices with magnetic fields include airport walk-through devices and security wands. The airport security devices that check carry-on luggage, such as conveyor belts, use X-rays instead of magnetism and will not damage a drive.

Improving hard drive performance

Using Disk Defragmenter

As you use the computer, files on the hard drive become fragmented. Disk Defragmenter consolidates the fragmented files and folders on the hard drive so that the system can run more efficiently.

To run Disk Defragmenter:

1. Select **Start > All Programs > Accessories > System Tools > Disk Defragmenter**.
2. Under **Volume**, click the listing for the hard drive, usually listed as (C:), and then click **Defragment**.

For additional information, access the Disk Defragmenter online Help.

Using Disk Cleanup

Disk Cleanup searches the hard drive for unnecessary files that you can safely delete to free up disk space and help the computer to run more efficiently.

To run Disk Cleanup:

1. Select **Start > All Programs > Accessories > System Tools > Disk Cleanup**.
2. Follow the on-screen instructions.

Using HP 3D DriveGuard (select models only)

HP 3D DriveGuard protects the hard drive by parking the drive and halting I/O requests under either of the following conditions:

- You drop the computer.
- You move the computer with the display closed while the computer is running on battery power.

A short time after the end of one of these events, HP 3D DriveGuard returns the hard drive to normal operation.

 **NOTE:** Hard drives that are in an optional docking device or are connected to a USB port are not protected by HP 3D DriveGuard.

For more information, refer to the HP 3D DriveGuard online Help.

Identifying HP 3D DriveGuard status

The drive light on the computer changes to an amber color to show that the drive is parked. To determine whether drives are currently protected or whether a drive is parked, use the icon in the notification area, at the far right of the taskbar:

- If the software is enabled, a green check mark is superimposed over the hard drive icon.
- If the software is disabled, a red X is superimposed over the hard drive icon.
- If the drives are parked, a yellow moon is superimposed over the hard drive icon.

If HP 3D DriveGuard has parked the drive, the computer will behave in the following ways:

- The computer will not shut down.
- The computer will not initiate Standby or Hibernation, except as described in the following Note.

 **NOTE:** If the computer is running on battery power and reaches a critical battery level, HP 3D DriveGuard allows the computer to initiate Hibernation.

- The computer will not activate battery alarms set on the Alarms tab in Power Options Properties.

Before you move the computer, HP recommends that you either shut it down or initiate Standby or Hibernation.

Using HP 3D DriveGuard software

The HP 3D DriveGuard software enables you to perform the following tasks:

- Enable and disable HP 3D DriveGuard.

 **NOTE:** Depending on your user privileges, you may not be able to enable or disable HP 3D DriveGuard.

- Determine whether a drive in the system is supported.
- Hide or show the icon in the notification area.

To open the software and change settings, follow these steps:

1. Double-click the icon in the notification area, at the far right of the taskbar.

– or –

Right-click the icon in the notification area, and then select **Settings**.

2. Click the appropriate button to change settings.
3. Click **OK**.

Replacing a hard drive

△ **CAUTION:** To prevent information loss or an unresponsive system:

Shut down the computer before removing the hard drive from the hard drive bay. Do not remove the hard drive while the computer is on, in Standby, or in Hibernation.

If you are not sure whether the computer is off or in Hibernation, turn the computer on by briefly pressing the power button. Then shut down the computer through the operating system.

To remove a hard drive:

1. Save your work.
2. Shut down the computer and close the display.
3. Disconnect all external hardware devices connected to the computer.
4. Unplug the power cord from the AC outlet.
5. Turn the computer upside down on a flat surface, with the battery bay toward you.
6. Remove the battery from the computer.
7. Remove the 3 screws from the back edge of the computer.



8. Turn the computer display-side up, with the front toward you, and open the display.

9. Lift the top edge of the keyboard up and remove the keyboard from the computer to expose the hard drive.

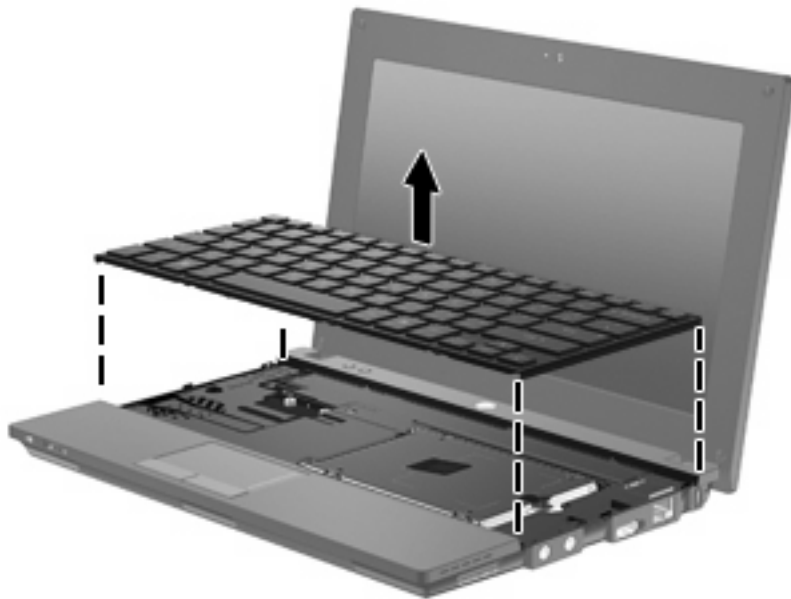

10. Remove the two hard drive screws (1).
11. Loosen the captive hard drive screw (2).
12. Pull the hard drive tab (3) to the right to disconnect the hard drive, and then lift the hard drive out of the hard drive bay (4).

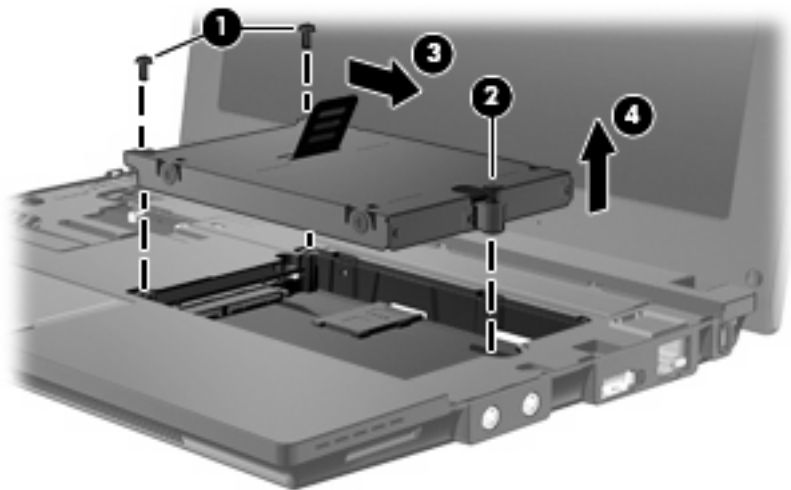

To install a hard drive:

1. Insert the hard drive into the hard drive bay (1).
2. Pull the hard drive tab (2) to the left to connect the hard drive.
3. Tighten the captive hard drive screw (3).

4. Replace the hard drive screws (4).

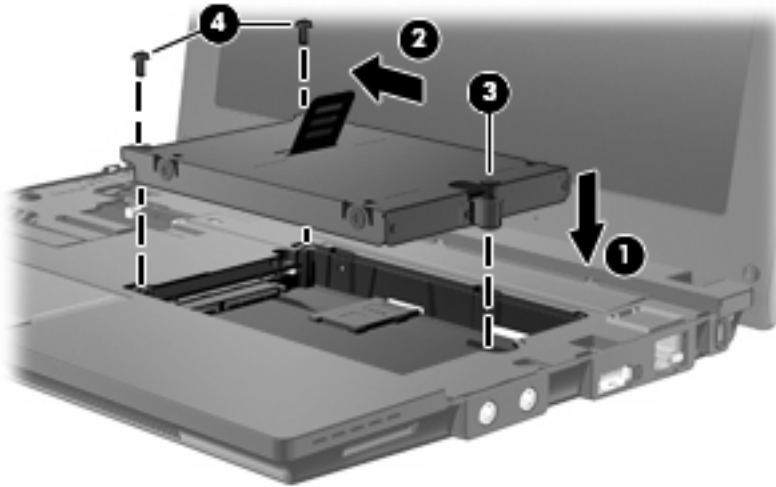

5. Insert the front edge (1) of the keyboard into the keyboard tray, and then press the keyboard into place (2).



6. Close the computer display and turn the computer upside down on a flat surface.

7. Replace the 3 screws on the back edge of the computer.



8. Replace the battery.

10 Memory modules

The computer has one memory module compartment, which is located under the keyboard. The memory capacity of the computer can be upgraded by replacing the existing memory module in the memory module slot.

- △ **WARNING!** To reduce the risk of electric shock and damage to the equipment, unplug the power cord and remove all batteries before installing a memory module.
- △ **CAUTION:** Electrostatic discharge (ESD) can damage electronic components. Before beginning any procedure, be sure that you are discharged of static electricity by touching a grounded metal object.

To add or replace a memory module:

1. Save your work.
2. Shut down the computer and close the display.

If you are not sure whether the computer is off or in Hibernation, turn the computer on by briefly pressing the power button. Then shut down the computer through the operating system.

3. Disconnect all external devices connected to the computer.
4. Unplug the power cord from the AC outlet.
5. Turn the computer upside down on a flat surface.
6. Slide the battery latch **(1)** to release the battery from the computer.
7. Remove the battery from the computer.
8. Slide the battery latch again, and the memory module compartment cover pops open.

9. Remove the memory module compartment cover (2).

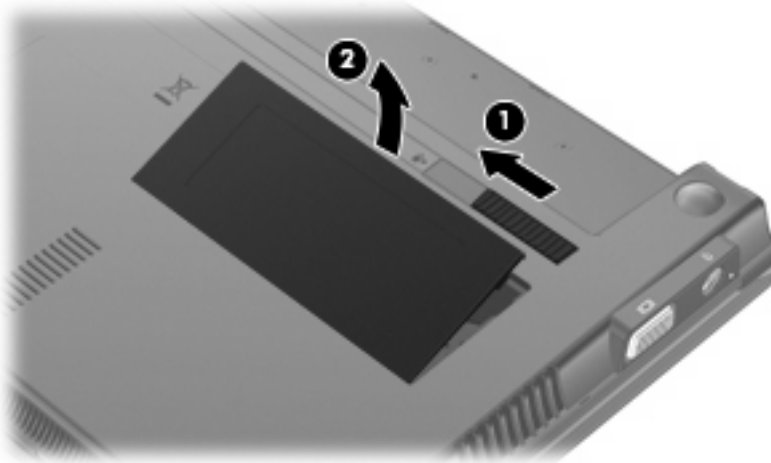

10. Remove the existing memory module:

- a. Pull away the retention clips (1) on each side of the memory module.

The memory module tilts up.

△ **CAUTION:** To prevent damage to the memory module, hold the memory module by the edges only. Do not touch the components on the memory module.

- b. Grasp the edge of the memory module (2), and gently pull the module out of the memory module slot.

To protect a memory module after removal, place it in an electrostatic-safe container.

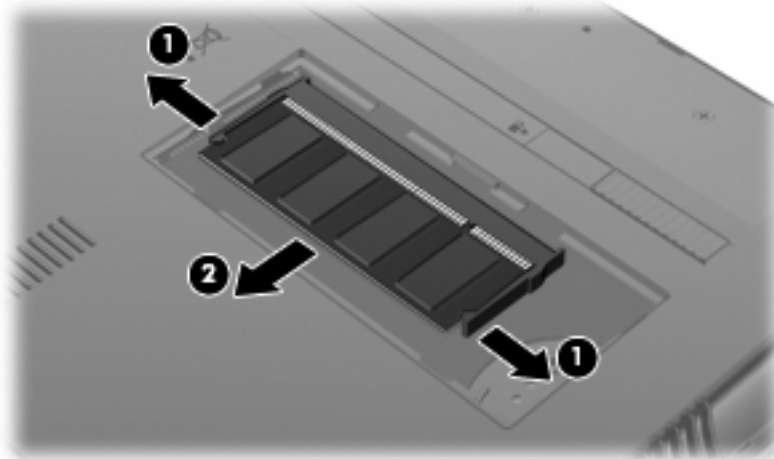

11. Insert a new memory module:

△ **CAUTION:** To prevent damage to the memory module, hold the memory module by the edges only. Do not touch the components on the memory module.

- a. Align the notched edge (1) of the memory module with the tab in the memory module slot.
- b. With the memory module at a 45-degree angle from the surface of the memory module compartment, press the module (2) into the memory module slot until it is seated.

△ **CAUTION:** To prevent damage to the memory module, do not bend the memory module.

- c. Gently press the memory module (3) down, applying pressure to the left and right edges of the memory module, until the retention clips snap into place.

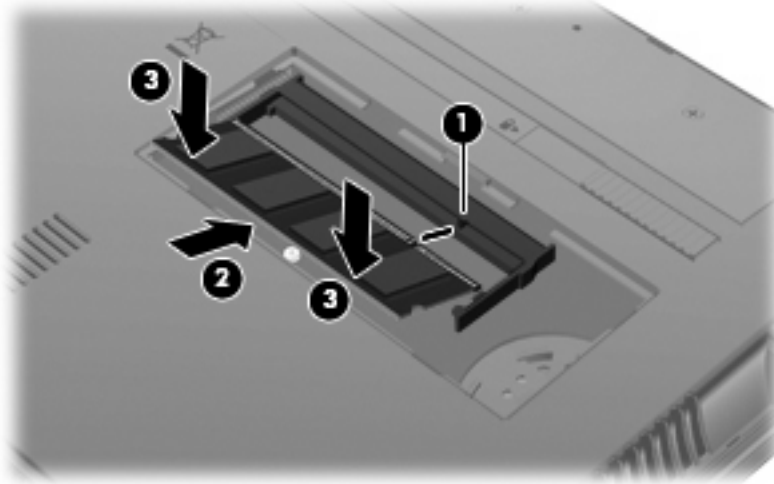

12. Insert the tabs of the memory module compartment cover (1) into the notches of the compartment.
13. Press the cover down until it snaps into place (2).

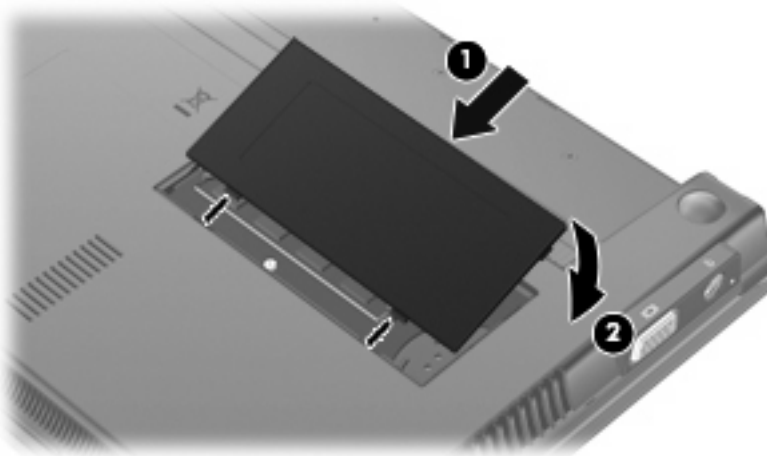

14. Replace the battery.
15. Turn the computer right-side up, and then reconnect external power and external devices.
16. Turn on the computer.

11 Computer Setup

Starting Computer Setup

Computer Setup is a preinstalled, ROM-based utility that can be used even when the operating system is not working or will not load.

 **NOTE:** Some of the Computer Setup menu items listed in this guide may not be supported by your computer.

NOTE: Pointing devices are not supported in Computer Setup. You must use the keyboard to navigate and make selections.

NOTE: An external keyboard connected by USB can be used with Computer Setup only if USB legacy support is enabled.

To start Computer Setup, follow these steps:

1. Turn on or restart the computer.
2. Before your operating system opens and while the “F10=ROM Based Setup” message is displayed in the lower-left corner of the screen, press **f10**.

Using Computer Setup

Navigating and selecting in Computer Setup

The information and settings in Computer Setup are accessed from the File, Security, Diagnostics, and System Configuration menus.

1. Open Computer Setup by turning on or restarting the computer, and then pressing **f10** while the “F10 = ROM Based Setup” message is displayed in the lower-left corner of the screen.

Because Computer Setup is not operating system based, it does not support the TouchPad. Navigation and selection are by keystroke:

- To choose a menu or a menu item, use the arrow keys.
- To select an item, press **enter**.
- To close open dialog boxes and return to the main Computer Setup screen, press **esc**.

- To view navigation information, press **f1**.
 - To change the language, press **f2**.
2. Select the **File, Security, Diagnostics, or System Configuration** menu.
 3. To exit Computer Setup, choose one of the following methods:
 - To exit Computer Setup without saving your preferences, use the arrow keys to select **File > Ignore changes and exit**. Then follow the instructions on the screen.
 - To save your preferences and exit Computer Setup, use the arrow keys to select **File > Save changes and exit**. Then follow the instructions on the screen.

Your preferences go into effect when the computer restarts.

Restoring factory settings in Computer Setup

To return all settings in Computer Setup to the values that were set at the factory, follow these steps:

1. Open Computer Setup by turning on or restarting the computer, and then pressing **f10** while the "F10 = ROM Based Setup" message is displayed in the lower-left corner of the screen.
2. Use the arrow keys to select **File > Restore defaults**, and then press **enter**.
3. When the confirmation dialog box opens, press **f10**.
4. To save your preferences and exit Computer Setup, use the arrow keys to select **File > Save changes and exit**. Then follow the instructions on the screen.

Your preferences go into effect when the computer restarts.

 **NOTE:** Your password settings and security settings are not changed when you restore the factory settings.

Computer Setup menus

The menu tables in this section provide an overview of the Computer Setup options.

 **NOTE:** Some of the Computer Setup menu items listed in this chapter may not be supported by your computer.

File menu

Select	To do this
System information	<ul style="list-style-type: none"> • View identification information for the computer. • View specification information for the processor, cache and memory size, and system ROM.
Restore defaults	Replace the configuration settings in Computer Setup with the original factory settings. (Password settings and security settings are not changed when you restore the factory settings.)

Select	To do this
Ignore changes and exit	Cancel any changes entered during the current session. Then exit and restart the computer.
Save changes and exit	Save any changes entered during the current session. Then exit and restart the computer. Your changes go into effect when the computer restarts.

Security menu

 **NOTE:** Some of the menu items listed in this section may not be supported by your computer.

Select	To do this
Setup password	Enter, change, or delete a setup password.
Power-on password	Enter, change, or delete a power-on password.
Password options	<ul style="list-style-type: none"> • Enable/disable stringent security. • Enable/disable the password requirement on computer restart.
DriveLock passwords	<ul style="list-style-type: none"> • Enable, change, or disable DriveLock on any computer hard drive. • Enter, change, or disable DriveLock on an optional MultiBay hard drive. <p>NOTE: DriveLock settings are accessible only when you enter Computer Setup by turning on (not restarting) the computer.</p>
System IDs	Enter a user-defined computer asset tracking number and ownership tag.
Disk Sanitizer	<p>Run Disk Sanitizer to destroy all existing data on the primary hard drive. The following options are available:</p> <ul style="list-style-type: none"> • Fast: Runs the Disk Sanitizer erase cycle once. • Optimum: Runs the Disk Sanitizer erase cycle 3 times. • Custom: Allows you to select the desired number of Disk Sanitizer erase cycles from a list. <p>CAUTION: If you run Disk Sanitizer, the data on the primary hard drive is destroyed permanently.</p>

Diagnostics menu

Select	To do this
HDD Self-Test Options	Run a comprehensive self-test on any hard drive in the system or on any optional MultiBay hard drive.
Memory Check	Run a comprehensive check on system memory.

System Configuration menu

 **NOTE:** Some of the listed System Configuration options may not be supported by your computer.

Select	To do this
Language	Change the Computer Setup language.
Boot options	<ul style="list-style-type: none">• Set an f9, f10, and f12 delay when starting up.• Enable/disable CD-ROM boot.• Enable/disable floppy boot.• Enable/disable internal network adapter boot.• Enable/disable MultiBoot, which sets a boot order that can include most boot devices in the system.• Set the Express Boot Popup delay in seconds.• Set the boot order.<ul style="list-style-type: none">◦ 1st boot device: USB CD-ROM◦ 2nd boot device: USB floppy◦ 3rd boot device: USB SuperDisk◦ 4th boot device: Notebook hard drive◦ 5th boot device: USB hard disk◦ 6th boot device: Network controller
Device configurations	<ul style="list-style-type: none">• Swap the functions of the fn key and left ctrl key.• Enable/disable USB legacy support. When enabled, USB legacy support allows the following:<ul style="list-style-type: none">◦ Use of a USB keyboard in Computer Setup even when a your operating system is not running.◦ Startup from bootable USB devices, including a hard drive, diskette drive, or optical drive connected by a USB port to the computer.• Enable/disable BIOS DMA data transfers.• Enable/disable fan always on while connected to an AC outlet.• Enable/disable data execution prevention.• Enable/disable LAN power saving mode.• Enable/disable SATA Native Mode.• Enable/disable Dual Core CPU.• Enable/disable HDD translation mode.
Built-in device options	<ul style="list-style-type: none">• Enable/disable embedded WLAN Device Radio.• Enable/disable embedded Bluetooth Device Radio.• Enable/disable Network Interface Controller (NIC)

Select	To do this
	<ul style="list-style-type: none">• Enable/disable LAN/WLAN Switching.• Enable/disable Wake on LAN.• Enable/disable the integrated camera (webcam)
Port options	<ul style="list-style-type: none">• Enable/disable USB port.• Enable/disable ExpressCard slot.

12 Backing up and recovering

To protect your information, use the Windows® Backup utility to back up files and folders or create recovery points. In case of system failure, you can use the backup files to restore your computer.

 **NOTE:** Windows Backup utility is available only on the notebooks with the Windows XP Professional operating system. If your notebook has Windows XP Home, you can back up your personal files to a USB external hard drive (purchased separately).

Windows XP Professional provides the following advanced backup and recovery options:

- Backing up individual files and folders
- Backing up all files and folders
- Scheduling automatic backups (select models only)
- Scheduling automatic backups
- Creating recovery points
- Recovering information

 **NOTE:** For instructions on these procedures, go to Help and Support.

Backing up

Recovery after a system failure is as complete as your most current backup. You should create your initial backup immediately after software setup. As you add new software and data files, you should continue to back up your system on a regular basis to maintain a reasonably current backup.

In Windows XP Professional, use the Windows Backup utility to create a backup. Click **Start > All Programs > Accessories > System Tools > Backup**. Follow the on-screen instructions to back up your files.

In Windows XP Home, copy data files to a USB external hard drive (purchased separately).

Recovering

In case of system failure or instability, use the *Operating System* disc and the *Driver Recovery* discs that are included with the computer to recover your operating system and programs.

△ **CAUTION:** The recovery process reformats and completely erases the hard drive. All files you have created and any software installed on the computer are permanently removed. The recovery process reinstalls the original operating system as well as software and drivers. Software, drivers, and updates not installed by HP must be manually reinstalled. Personal files must be restored from a backup.

1. If possible, back up all personal files.
2. Shut down the computer.
3. Insert the *Operating System* disc into an optional external optical drive.
4. Turn on the computer.
5. Follow the on-screen instructions to install the operating system.
6. After the operating system is installed, remove the *Operating System* disc and insert the *Driver Recovery* disc.
7. Follow the on-screen instructions to install the drivers and programs.

 **NOTE:** For additional information, go to Help and Support.

Index

- A**
 - AC adapter
 - connecting 16
 - identifying 10
 - administrator password 49
 - airport security devices 83
 - antennas 9
 - applications key, Windows 5
 - audio devices, connecting
 - external 38
 - audio functions, checking 38
 - audio-in (microphone) jack 6, 35
 - audio-out (headphone) jack 6, 35
- B**
 - backing up 99, 100
 - battery
 - calibrating 20
 - charging 18, 20
 - conserving power 22
 - disposing 23
 - inserting 17
 - low battery levels 19
 - recharging 22
 - removing 17
 - replacing 23
 - storing 22
 - battery bay 9, 11
 - battery charge, maximizing 19
 - battery light 18, 19
 - battery power 16
 - battery release latches 17
 - battery release latches, identifying 9
 - battery temperature 22
 - battery, identifying 10
 - bays, battery 11
 - Bluetooth device 25
 - Bluetooth label 11
 - boot options 97
 - boot order 97
 - button, volume mute 35
 - buttons
 - power 4
 - Quick Launch Mail 4
 - Quick Launch Web 4
 - TouchPad 2
- C**
 - cables
 - USB 67
 - calibrating battery 20
 - caps lock light, identifying 3
 - CD
 - inserting 42, 70
 - removing 45, 71
 - CD drive 41, 69
 - Certificate of Authenticity label 11
 - charging batteries 18, 20
 - checking audio functions 38
 - components
 - additional hardware 10
 - bottom 8
 - display 8
 - front 5
 - left-side 7
 - right-side 6
 - top 1
 - Computer Setup
 - device security 60
 - Diagnostic menu 96
 - DriveLock password 55
 - File menu 95
 - navigating and selecting 94
 - power-on password 52
 - restoring factory settings 95
 - Security menu 96
 - setup password 50
 - stringent security 60
 - System Configuration menu 97
 - connecting to a WLAN 29
 - Connection Manager icon 25
 - connection, external power 16
 - connector, power 7
 - conservation, power 22
 - cord, power 10
 - corporate WLAN connection 29
 - critical battery level 19
- D**
 - device security 60
 - Diagnostic menu 96
 - digital card
 - inserting 74
 - removing 75
 - stopping 75
 - Disk Cleanup software 84
 - Disk Defragmenter software 84
 - disk performance 84
 - diskette drive 69
 - display
 - image, switching 78
 - screen brightness keys 78
 - display components 8
 - drive light 5, 85
 - drive media 12
 - DriveLock password
 - changing 58
 - description 55
 - entering 57
 - removing 59
 - setting 56
 - drives
 - diskette 69
 - external 69
 - hard 69, 88

- MultiBay 69
 - optical 69
- drives, boot order 97
- drives, optical drive 41
- DVD
 - changing region setting 44
 - inserting 42, 70
 - removing 45, 71
- DVD drive 41, 69
- DVD region settings 44

E

- earbuds 35
- embedded numeric keypad keys,
 - identifying 5
- encryption 28
- esc key, identifying 5
- external audio devices,
 - connecting 38
- external drive 69
- external monitor port 40
- external monitor port,
 - identifying 7

F

- File menu 95
- firewall 28
- fn key, identifying 5
- function keys
 - decreasing screen brightness 78
 - increasing screen brightness 78
 - increasing speaker volume 79
 - initiating QuickLock 78
 - initiating Sleep 78
 - muting speaker sound 79
 - switching screen image 78
- function keys, identifying 5

H

- hard disk drive
 - external 69
 - HP 3D DriveGuard 85
 - installing 88
- hard drive
 - external 69
 - HP 3D DriveGuard 85
 - installing 88
- hardware, identifying 1
- headphone (audio-out) jacks 35

- headphones 35
- Hibernation
 - exiting 13
 - initiated during critical battery level 19
 - initiating 13
- HP 3D DriveGuard 85
- HP Mobile Broadband Module 30
- HP Mobile Broadband,
 - disabled 30
- hubs 67

I

- icons
 - Connection Manager 25
 - network status 25
 - wireless 25
- internal microphone,
 - identifying 35
- internal microphones,
 - identifying 8
- Internet connection setup 27

J

- jacks
 - audio-in (microphone) 6, 35
 - audio-out (headphone) 6, 35
 - RJ-45 (network) 6

K

- keyboard function keys,
 - identifying 76
- keypad, embedded
 - enabling and disabling 80
 - identifying 79
 - switching key functions 80
 - using 79
- keypad, external
 - num lock 80
 - using 80
- keys
 - decreasing speaker sound 79
 - esc 5
 - fn 5
 - function 5
 - keypad 5
 - Windows applications 5
 - Windows logo 5

L

- labels
 - Bluetooth 11
 - Microsoft Certificate of Authenticity 11
 - regulatory 11
 - service tag 9, 10
 - wireless certification 11
 - WLAN 11
- latches, battery release 9
- legacy support, USB 94, 97
- light, drive 85
- lights
 - caps lock 3
 - drive 5
 - power 3, 7
 - Quick Launch Mail 3
 - Quick Launch Web 3
 - webcam 8, 35
 - wireless 6
- low battery level 19

M

- maintenance
 - Disk Cleanup 84
 - Disk Defragmenter 84
- memory module
 - inserting 92
 - removing 92
- memory module compartment,
 - identifying 9
- microphones, internal 8, 35
- Microsoft Certificate of Authenticity label 11
- monitor port, external 7
- monitor, connecting 40
- mouse, external
 - connecting 76
 - setting preferences 76
- movie, watching 43
- MultiBay 69
- multimedia components,
 - identifying 34
- multimedia software 37
- MultiMediaCard 74
- mute button 35

N

- network status icon 25
- num lock, external keypad 80

- O**
 - operating system
 - Microsoft Certificate of Authenticity label 11
 - Product Key 11
 - optical disc
 - inserting 42, 70
 - removing 45, 71
 - optical discs, using 41
 - optical drive 41, 69
- P**
 - passwords
 - administrator 49
 - DriveLock 55
 - power-on 52
 - setup 50
 - user 49
 - pointing devices
 - setting preferences 76
 - ports
 - external monitor 7, 40
 - USB 6, 7, 67
 - power
 - connecting 16
 - conserving 22
 - power button, identifying 4
 - power connector, identifying 7
 - power cord, identifying 10
 - power light 7
 - power light, identifying 3
 - Product Key 11
 - product name and number,
 - computer 9, 10
 - projector, connecting 40
 - public WLAN connection 29
- Q**
 - Quick Launch Mail light,
 - identifying 3
 - Quick Launch Mail, identifying 4
 - Quick Launch Web button,
 - identifying 4
 - Quick Launch Web light,
 - identifying 3
 - QuickLock key 78
- R**
 - readable media 12
 - recovering 99, 101
 - region codes, DVD 44
 - regulatory information
 - regulatory label 11
 - wireless certification labels 11
 - release latches, battery 9
 - RJ-45 (network) jack,
 - identifying 6
- S**
 - screen brightness keys 78
 - screen image, switching 78
 - scrolling regions, TouchPad 2
 - SD Card 74
 - SD Card Reader 6, 74
 - security cable slot, identifying 6
 - Security menu 96
 - security, wireless 27
 - serial number, computer 9, 10
 - service tag 9, 10
 - setup of WLAN 27
 - setup utility
 - Diagnostic menu 96
 - File menu 95
 - restoring factory settings 95
 - Security menu 96
 - System Configuration menu 97
 - setup, computer 1
 - shut down 24
 - SIM
 - inserting 30
 - removing 31
 - Sleep key 78
 - slots
 - security cable 6
 - software
 - Disk Cleanup 84
 - Disk Defragmenter 84
 - speakers 35
 - speakers, identifying 6, 8
 - Standby
 - exiting 12
 - initiating 12
 - storing battery 22
 - stringent security 60, 96
 - switches
 - wireless 6
 - System Configuration menu 97
 - system fan 97
 - system information 95
 - system information key 5
- T**
 - temperature 22
 - TouchPad
 - buttons 2
 - identifying 1
 - scrolling regions 2
 - using 76
 - traveling with the computer 11, 22
 - turning off the computer 24
- U**
 - unresponsive system 24
 - USB cable, connecting 67
 - USB devices
 - connecting 67
 - description 67
 - removing 67
 - stopping 67
 - USB hubs 67
 - USB legacy support 68, 94, 97
 - USB port, powered 69, 70
 - USB ports, identifying 6, 7, 67
 - user password 49
- V**
 - vents, identifying 7, 9
 - video transmission types 78
 - video, recording 8
 - volume keys 35
 - volume mute button 35
 - volume, adjusting 35
- W**
 - webcam 8, 35
 - webcam light, identifying 8, 35
 - webcam properties, adjusting 47
 - Windows applications key,
 - identifying 5
 - Windows logo key, identifying 5
 - wireless antennas 9
 - wireless certification label 11
 - wireless controls
 - button 26
 - operating system 26
 - wireless icon 25
 - wireless light 6, 26
 - wireless network (WLAN)
 - connecting 29
 - corporate WLAN connection 29

- equipment needed 27
- functional range 29
- public WLAN connection 29
- security 27
- wireless switch 6, 26
- WLAN device 11, 25, 27
- WLAN label 11
- writable media 12
- WWAN device 30

